

February 7, 2017

TMA4A PCB – EU334002 seen from front

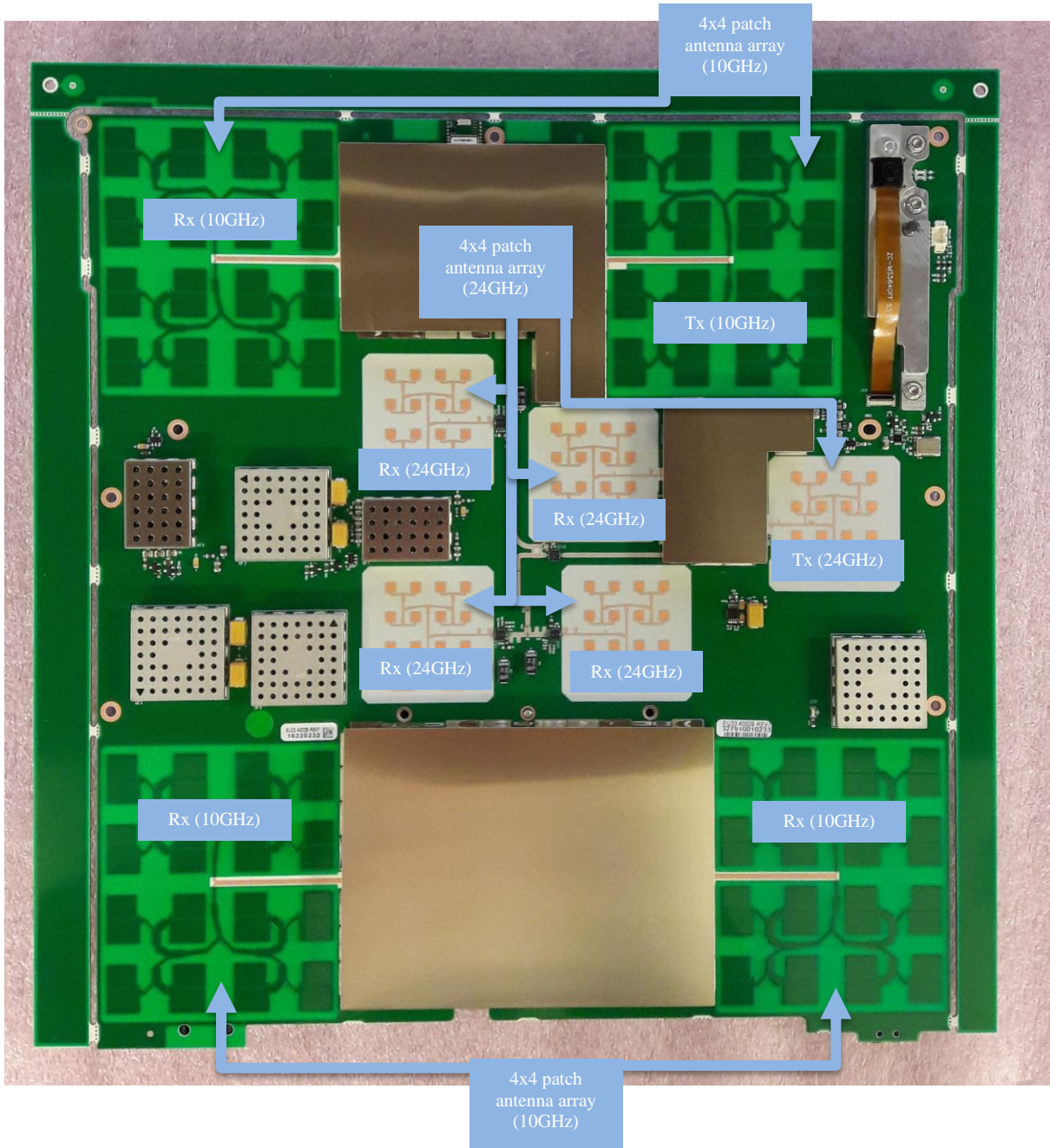

TMA4A PCB – EU334002 seen from back

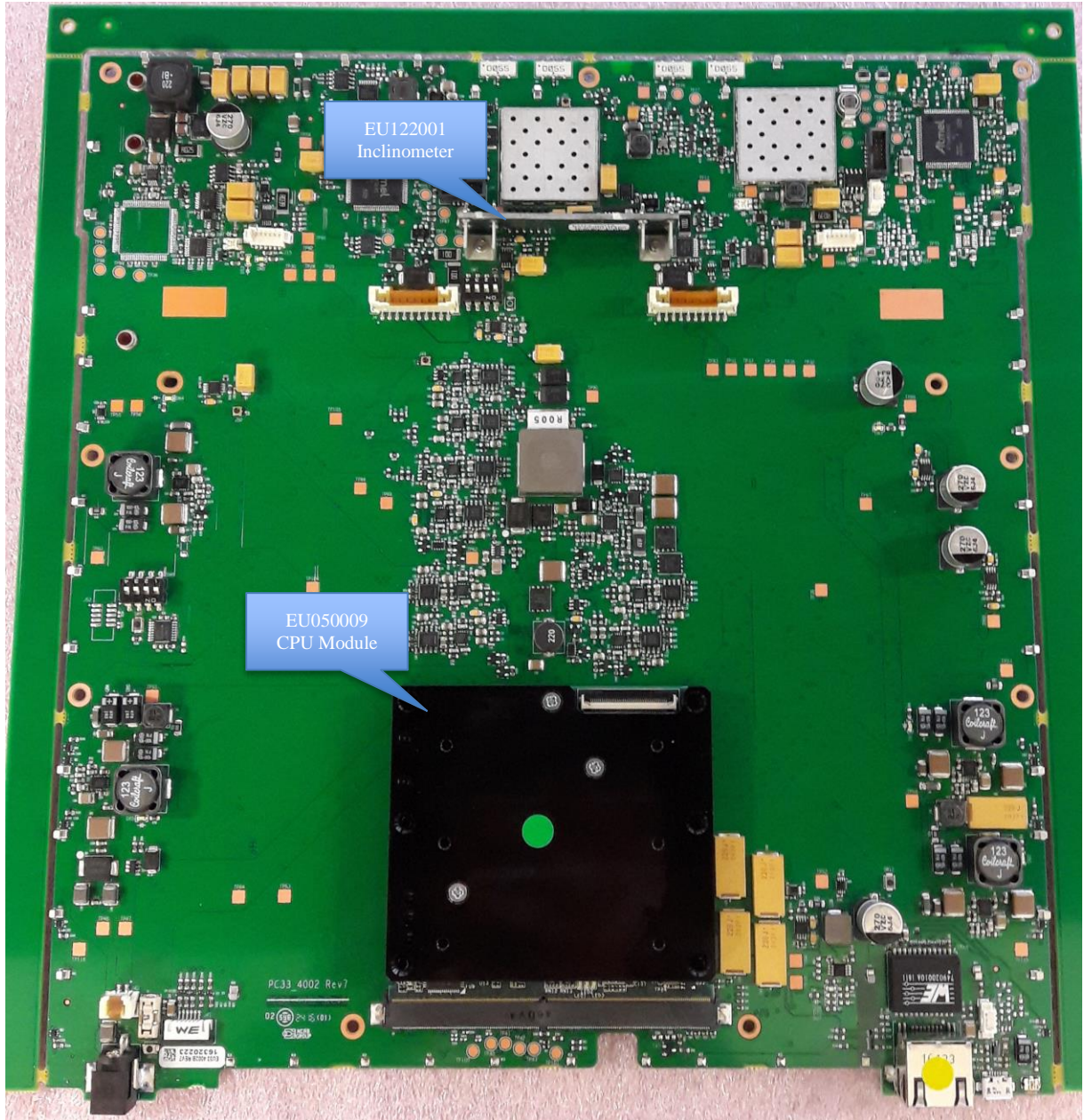

TMA4A PCB – EU334002 seen from back (Wi-Fi exposed)

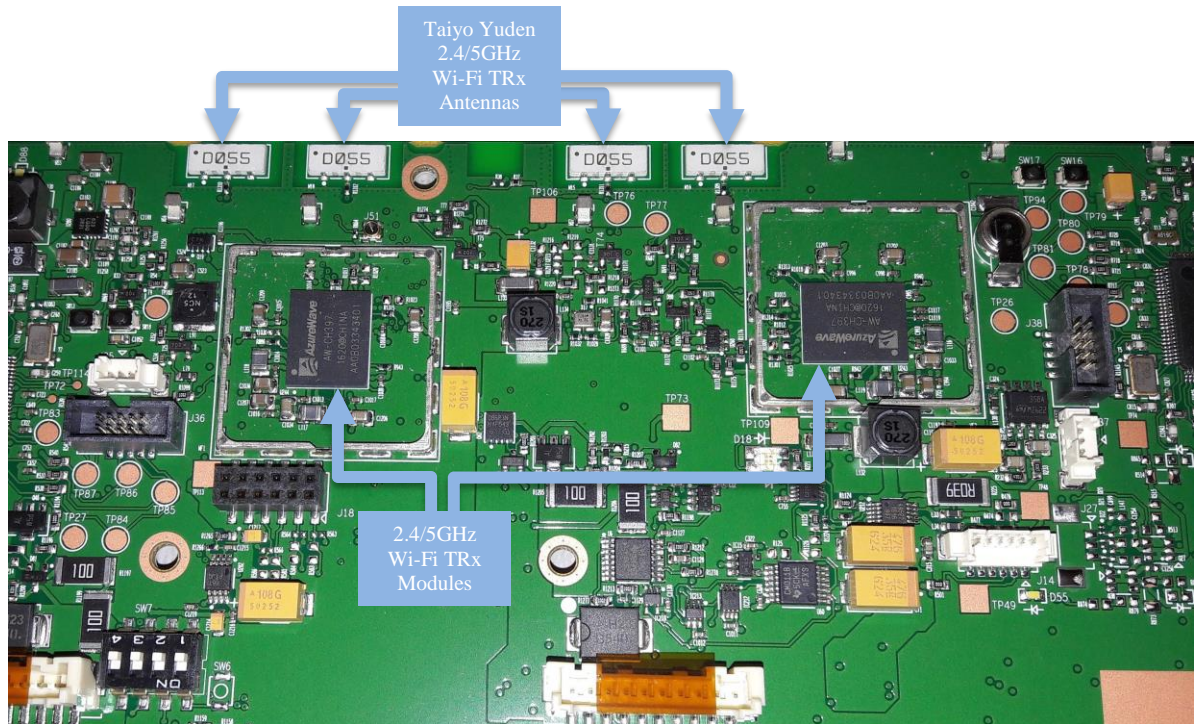

TMA4A PCB – EU334002 inside mechanical housing, seen from front

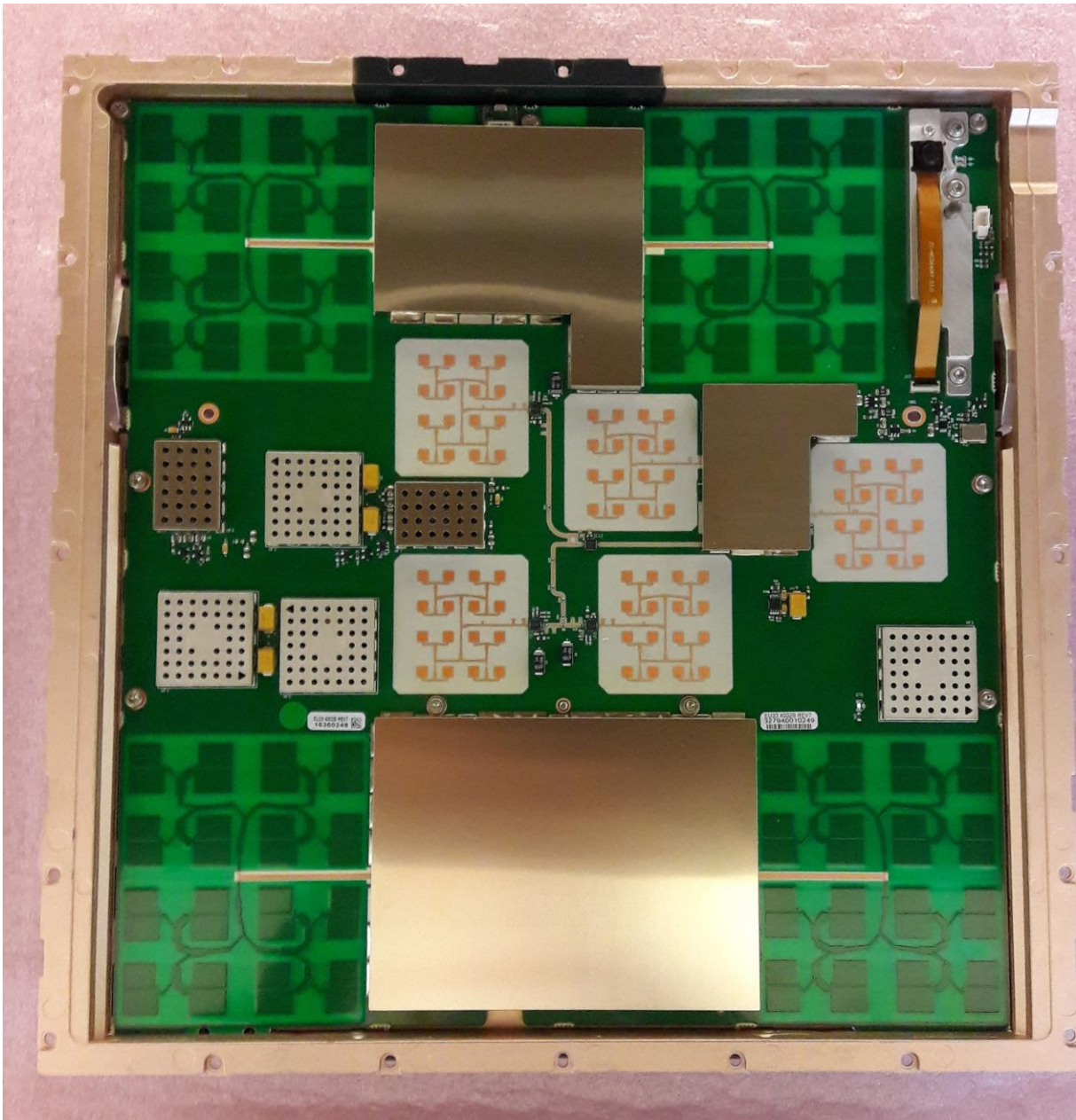

TMA4A mechanical housing with PCB – EU334002, seen from back

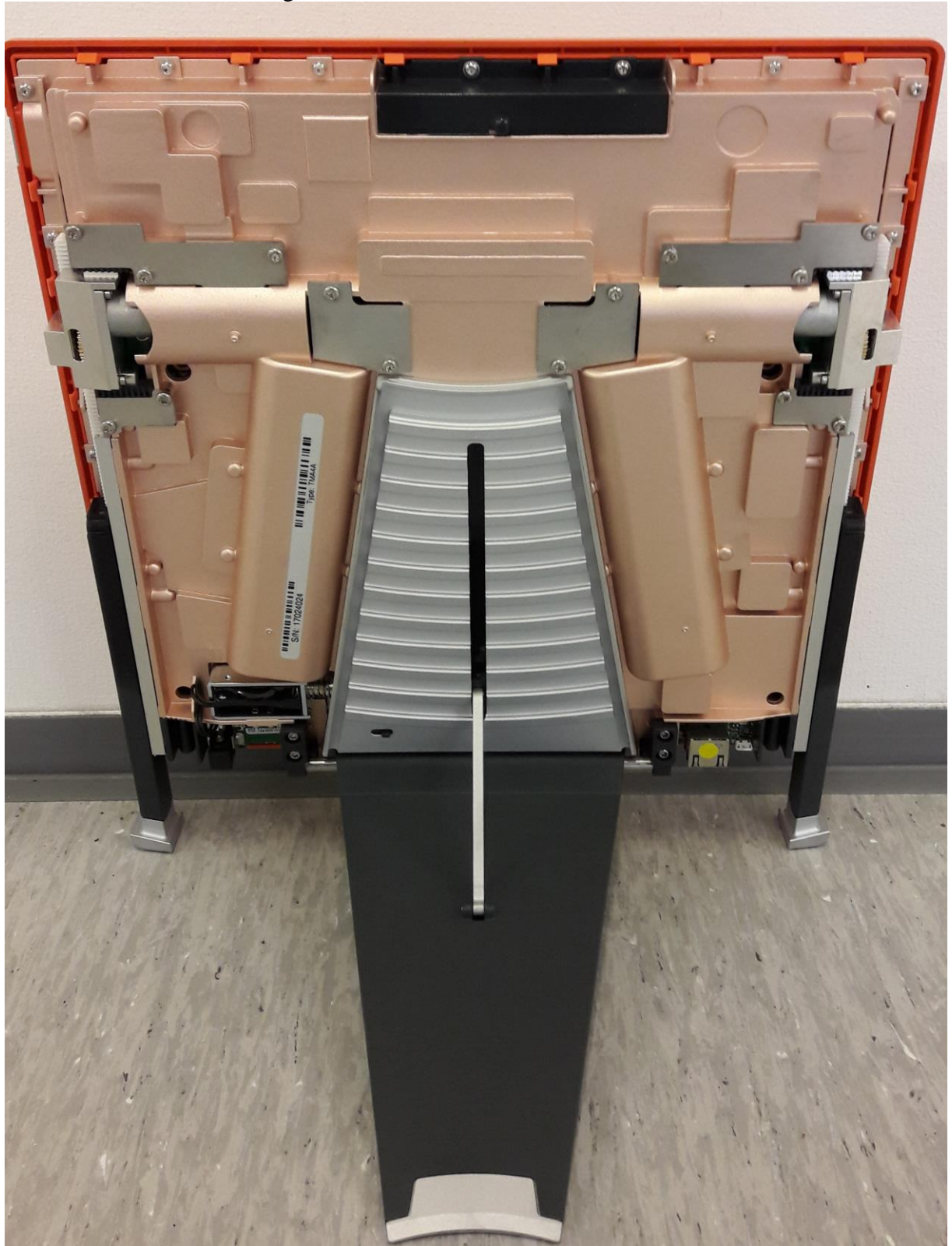

TMA4A CPU module – EU050009, seen from front



TMA4A CPU module – EU050009, seen from back

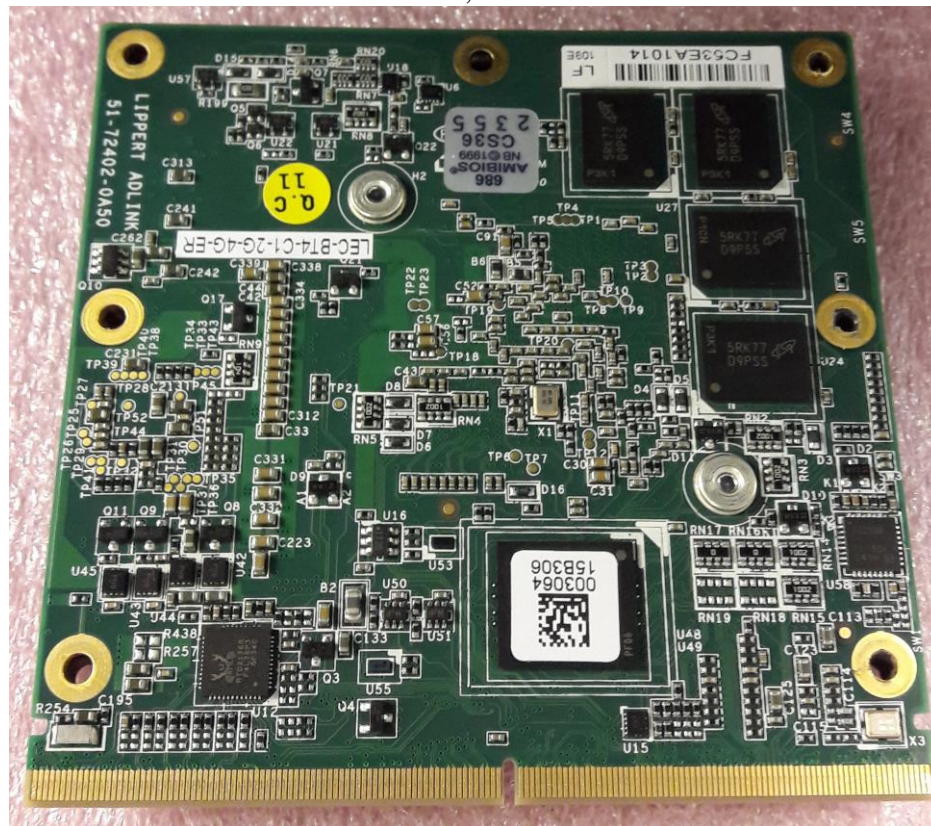

TMA4A Inclinometer module – EU122001, seen from front

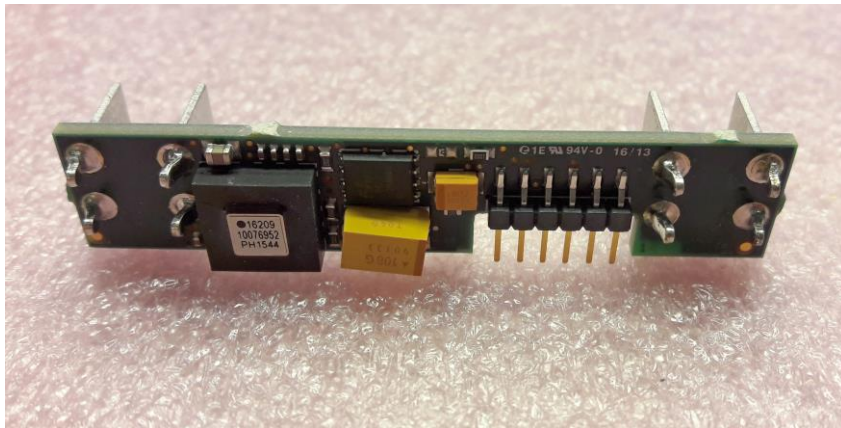
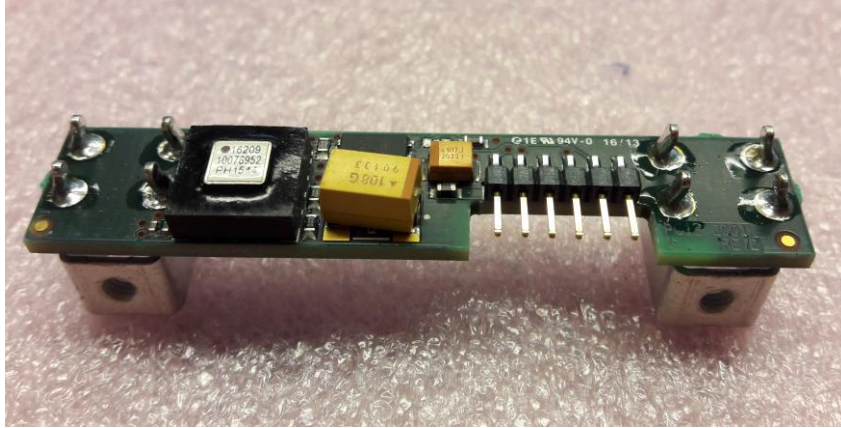

TMA4A Inclinometer module – EU122001, seen from back

