



**CONFORMANCE TEST REPORT
FOR
FCC 47 CFR, Part 15 Subpart C**



Report No.: ET93S-10-122-01

Client:	IQ Group Sdn. Bhd.(Representative Office)
Product:	Short Range Remote Controller Transmitter
Model:	WD-6108
FCC ID:	SFV-04WD6108
Manufacturer/supplier:	IQ Group Sdn. Bhd.
Date test item received:	2004/10/15
Date test campaign completed:	2004/10/28
Date of issue:	2004/10/29

The test result only corresponds to the tested sample. It is not permitted to copy this report, in part or in full, without the permission of the test laboratory.

Total number of pages of this test report: 25 pages

Total number of pages of photos: External photos 1 pages
Internal photos 3 pages
Setup photos 2 pages

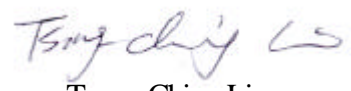
Test Engineer	Checked By	Approved By
 Mark	 Joe Hsieh	 Tsung-Ching Lin

ELECTRONICS TESTING CENTER, TAIWAN
 NO.8, LANE 29, WEN-MING RD.,
 LO-SHAN TSUN, KUI-SHAN HSIANG,
 TAOYUAN HSIEN 333
 TAIWAN, R.O.C.

TEL: (03) 3276170~4
 INT: +886-3-3276170~4
 FAX: (03) 3276188
 INT: +886-3-3276188



TEST REPORT CERTIFICATION

Client : IQ Group Sdn. Bhd. (Representative Office)
Address : 5F., No. 16, Lane 130, Ming-Chun Rd., Hsin Tien, Taipei Hsien, Taiwan
Manufacturer : IQ Group Sdn. Bhd.
Address : Plot 149, Jalan Sultan Azlan Shah, Taman Perindustrian Bayan lepas, Fasa 1(FTZ), Bay Lepas, 11900 Pulau Penang, Malaysia.
EUT : Short Range Remote Controller Transmitter
Trade name : ----
Model No. : WD-6108
Power Source : 3VDC
Regulations applied : FCC 47 CFR, Part 15 Subpart C (2003)

The testing described in this report has been carried out to the best of our knowledge and ability, and our responsibility is limited to the exercise of reasonable care. This certification is not intended to believe the sellers from their legal and/or contractual obligations.

The compliance test is only certified for the test equipment and the results of the testing report relate only to the item tested. The compliance test of this report was conducted in accordance with the appropriate standards. It is not intention to assure the quality and performance of the product. This report shall not be reproduced except in full, without the approval of ETC. This report must not be used by the client to claim product endorsement by NVLAP or any agency of the U.S. Government.

Laboratory Introduction: Electronics Testing Center, Taiwan is recognized, filed and mutual recognition arrangement as following:

- ① ISO9001: TÜV Product Service
- ② ISO/IEC 17025: BSMI, CNLA, DGT, NVLAP, CCIBLAC, UL, Compliance
- ③ Filing: FCC, Industry Canada, VCCI
- ④ MRA: Australia, Hong Kong, New Zealand, Singapore, USA, Japan, Korea, China, APLAC through CNLA



NVLAP Lab Code 200133-0

Table of Contents

Page

1. GENERAL INFORMATION	4
1.1 PRODUCT DESCRIPTION.....	4
1.2 CHARACTERISTICS OF DEVICE:.....	4
1.3 TEST METHODOLOGY	4
1.4 TEST FACILITY.....	4
2. DEFINITION AND LIMITS	5
2.1 DEFINITION.....	5
2.2 RESTRICTED BANDS OF OPERATION	5
2.3 LIMITATION	6
2.4 LABELING REQUIREMENT	7
2.5 USER INFORMATION	7
3. RADIATED EMISSION MEASUREMENT	8
3.1 APPLICABLE STANDARD	8
3.2 MEASUREMENT PROCEDURE	8
3.3 TEST DATA.....	10
3.4 FIELD STRENGTH CALCULATION	15
3.5 RADIATED TEST EQUIPMENT.....	15
3.6 MEASURING INSTRUMENT SETUP	19
4. BANDWIDTH OF EMISSION	20
4.1 APPLICABLE STANDARD PLOT GRAPHIC OF BANDWIDTH.....	20
4.2 TEST EQUIPMENT	20
4.3 TEST RESULT	20
5. CONDUCTED EMISSION MEASUREMENT	23
6. LIMIT OF TRANSMISSION TIME	24
6.1 APPLICABLE STANDARD	24
6.2 ACTIVE TIME	24

1. GENERAL INFORMATION

1.1 Product Description

- a) Type of EUT : Short Range Remote Controller Transmitter
- b) Model No. : WD-6108
- c) Serial No. : ----
- d) FCC ID : SFV-04WD6108
- e) Working Frequency : 433.84 MHz
- f) Power Supply : 3VDC

1.2 Characteristics of Device:

When the bell push button is pressed, the confidence light will illuminate to reassure the caller that the bell push is working and the ID code will be transmitted in 1.2 seconds. The light will flash 5 times when the battery needs replacing.

1.3 Test Methodology

Both Conducted and radiated testing were performed according to the procedures in chapter 13 of ANSI C63.4.

The Short Range Remote Controller Transmitter under test was operated continuously in its normal operating mode for the purpose of the measurements. In order to secure the continuous operation of the device under test, the circuit rewired by the manufacturer to affect its intended operation.

The receiving antenna was varied from 1 to 4 meters and the wooden turntable was rotated through 360 degrees to obtain the highest reading on the field strength meter or on the display of the spectrum analyzer. And also, each emission was to be maximized by changing the orientation of the Remote Controller Transmitter under test.

1.4 Test Facility

The semi-anechoic chamber and conducted measurement facility used to collect the radiated and conducted data are located inside the Building at No.8, Lane 29, Wen-ming Road, Lo-shan Tsun, Kweishan Hsiang, Taoyuan, Taiwan, R.O.C.

This site has been accreditation as a FCC filing site.

2. DEFINITION AND LIMITS

2.1 Definition

Intentional radiator:

A device that intentionally generates and emits radio frequency energy by radiation or induction.

2.2 Restricted Bands of Operation

Only spurious emissions are permitted in any of the frequency bands listed below:

MHz	MHz	MHz	GHz
0.090 - 0.110	16.42-16.423	399.9-410	4.5-5.25
0.495 - 0.505 **	16.69475 - 16.69525	608-614	5.35-5.46
2.1735 - 2.1905	16.80425 - 16.80475	960-1240	7.25-7.75
4.125-4.128	25.5-25.67	1300-1427	8.025-8.5
4.17725-4.17775	37.5-38.25	1435-1626.5	9.0-9.2
4.20725-4.20775	73-74.6	1645.5-1646.5	9.3-9.5
6.215-6.218	74.8-75.2	1660-1710	10.6-12.7
6.26775-6.26825	108-121.94	1718.8-1722.2	13.25-13.4
6.31175-6.31225	123-138	2200-2300	14.47-14.5
8.291-8.294	149.9-150.05	2310-2390	15.35-16.2
8.362-8.366	156.52475 - 156.52525	2483.5-2500	17.7-21.4
8.37625-8.38675	156.7-156.9	2655-2900	22.01-23.12
8.41425-8.41475	162.0125-167.17	3260-3267	23.6-24.0
12.29-12.293	167.72-173.2	3332-3339	31.2-31.8
12.51975-12.52025	240-285	3345.8-3358	36.43-36.5
12.57675-12.57725	322-335.4	3600-4400	Above 38.6
13.36-13.41			

Remark “**” : Until February 1, 1999, this restricted band shall be 0.490-0.510 MHz

2.3 Limitation

(1) Conducted Emission Limits :

For an intentional radiator which is designed to be connected to the public utility (AC) power line, the conducted limit is the following:

Frequency MHz	Quasi Peak dB μ V	Average dB μ V
0.15 - 0.5	66-56	56-46
0.5 - 5.0	56	46
5.0 - 30.0	60	50

(2) Radiated Emission Limits :

According to 15.231 ,Periodic operation in the band 40.66-40.70 MHz and above 70 MHz, the field strength of emissions from intentional radiators operated under this section shall not exceed the following:

Frequency Band (MHz)	Field strength of Fundamental (uV/m)	Field strength of Spurious (uV/m)
40.66-40.70	2250	225
70-130	1250	125
130-174	*1,250 to 3,750	*125 to 375
174-260	3750	375
260-470	*3,750 to 12,500	*375 to 1250
Above 470	12500	1250

* Linear interpolations.

Field strength limits are at the distance of 3 meters, emissions radiated outside of the specified bands, shall be according to the general radiated limits in 15.209,as following table:

Other Frequencies (MHz)	Field Strength of Fundamental	
	μ V/meter	dB μ V/meter
30 - 88	100	40.0
88 - 216	150	43.5
216 - 960	200	46.0
Above 960	500	54.0

As shown in 15.35(b), for frequencies above 1000MHz, the field strength limits are based on average detector, however, the peak field strength of any emission shall not exceed the maximum permitted average limits, specified above by more than 20 dB under any condition of modulation.

(3) Limit of transmission time

- a) A manually operated Remote Controller Transmitter shall employ a switch that will automatically deactivate the Remote Controller Transmitter within not more than 5 seconds of being released.
- b) A Remote Controller Transmitter activated automatically shall cease transmission within 5 seconds after activation.

2.4 Labeling Requirement

The device shall bear the following statement in a conspicuous location on the device :

This device complies with part 15 of the FCC Rules. Operation is subject to the following two conditions: (1) This device may not cause harmful interference, and (2) this device must accept any interference received, including interference that may cause undesired operation.

2.5 User Information

The users manual or instruction manual for an intentional or unintentional radiator shall caution the user that changes or modifications not expressly approved by the party responsible for compliance could void the user's authority to operate the equipment.

3. RADIATED EMISSION MEASUREMENT

3.1 Applicable Standard

For periodic operation intentional radiator, the radiated emission shall comply with § 15.231(b).

3.2 Measurement Procedure

A. Preliminary Measurement For Portable Devices.

For portable devices, the following procedure was performed to determine the maximum emission axis of EUT:

1. With the receiving antenna is H polarization, rotate the EUT in turns with three orthogonal axes to determine the axis of maximum emission.
2. With the receiving antenna is V polarization, rotate the EUT in turns with three orthogonal axes to determine the axis of maximum emission.
3. Compare the results derived from above two steps. So, the axis of maximum emission from EUT was determined and the configuration was used to perform the final measurement.

B. Final Measurement

1. Setup the configuration per figure 1 and 2 for frequencies measured below and above 1 GHz respectively. Turn on EUT and make sure that it is in continuous operating function.
2. For emission frequencies measured below 1 GHz, a pre-scan is performed in a semi-anechoic chamber to determine the accurate frequencies of higher emissions and then each selected frequency is precisely measured. As the same purpose, for emission measured above 1 GHz, a pre-scan also be performed with a 1 meter measuring distance before final test.
3. For emission measured below and above 1 GHz, set the spectrum analyzer on a 120 kHz and 1 MHz resolution bandwidth respectively for each frequency measured in step 2.
4. The search antenna is to be raised and lowered over a range from 1 to 4 meters in horizontally polarized orientation. Position the highness when the highest value is indicated on spectrum analyzer, then change the orientation of EUT on test table over a range from 0° to 360° with a speed as slow as possible, and keep the azimuth that highest emission is indicated on the spectrum analyzer. Vary the antenna position again and record the highest value as a final reading. A RF test receiver is also used to confirm emissions measured.

Figure 1 : Frequencies measured below 1 GHz configuration

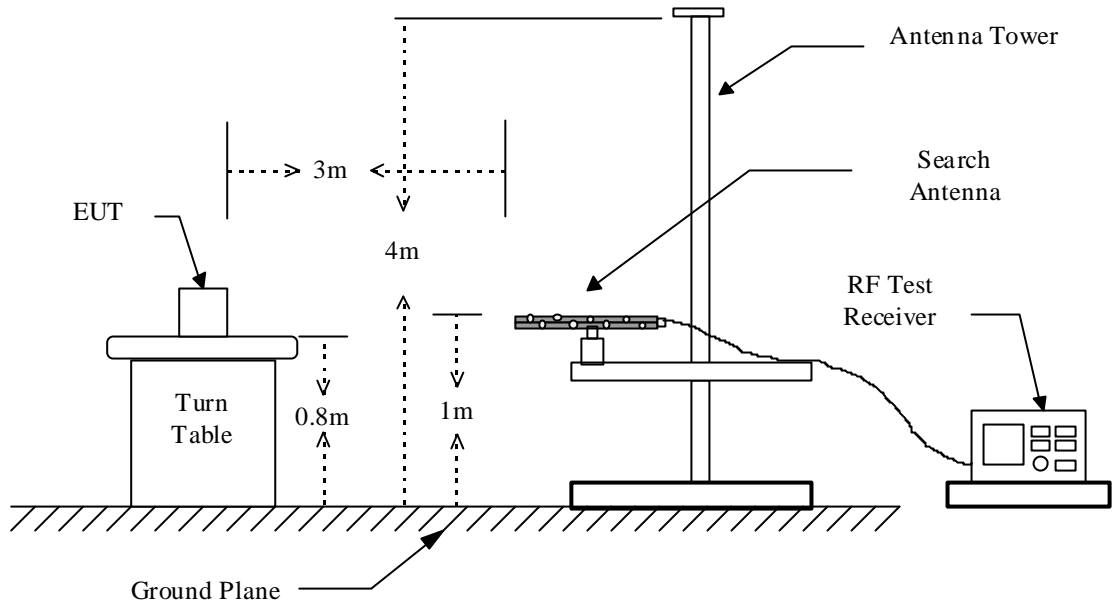
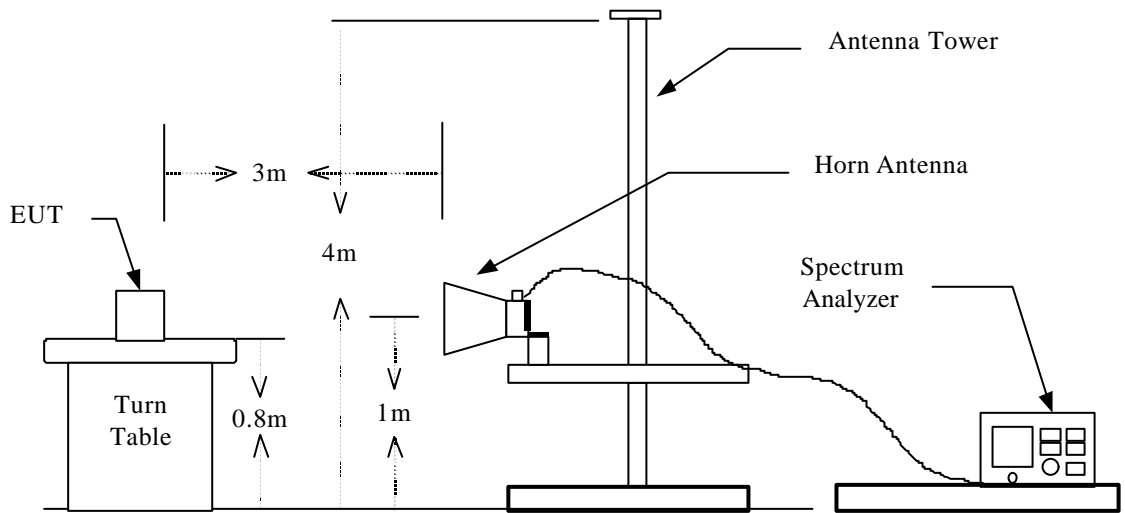

Figure 2 : Frequencies measured above 1 GHz configuration



3.3 Test DataOperated mode : TransmittingTest Date : Oct. 28, 2004 Temperature : 24 Humidity : 70 %

Frequency (MHz)	Ant Pol H / V	Reading (dBuV)		Correct Factor (dB)	Duty Factor (dB)	Result @3m (dBuV/m)			Limit @3m (dBuV/m)			Table Degree (Deg.)	Ant. High (m)
		Peak	QP			Peak	QP	AVG	Peak	QP	AVG		
Fundamental													
433.870	H	65.2	50.3	20.1	-14.9	85.3	----	70.4	100.8	----	80.8	32	1.0
433.870	V	50.6	35.7	20.1	-14.9	70.7	----	55.8	100.8	----	80.8	167	1.0
Harmonic													
----	----	----	----	----	----	----	----	----	----	----	----	----	----
Other Spurious													
----	----	----	----	----	----	----	----	----	----	----	----	----	----

Note:

1. *Peak Result = Peak Reading + Correct Factor*
2. *AVG Result = Peak Result + Duty Factor*
3. *If the result of peak value is under the limit of average, the average value doesn't need to be measured.*
4. *"*" means the frequency is in the Restricted Bands.*
5. *Please refer to page 11 to page 14 for chart*

Horizontal



ETC TEST LABORATORY

Data#: 5737 File#: C:\Program Files\e3\MARK1.emi

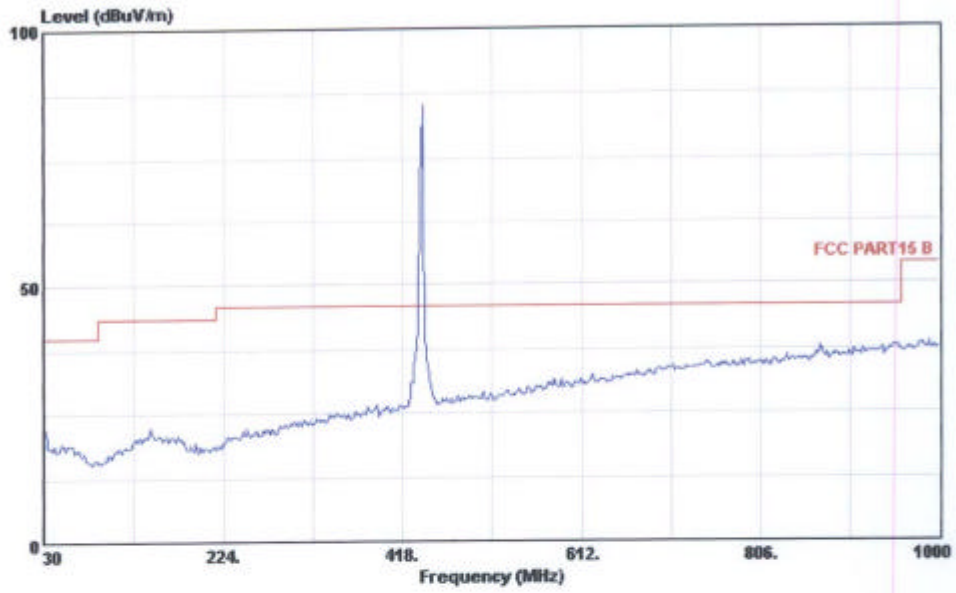

Site : M00 SITE
Condition : FCC PART15 B 3m HORIZONTAL
EUT :
MODEL : WD-6108
memo : TX

Vertical



ETC TEST LABORTARY

Data#: 5736 File#: C:\Program Files\3\MARK1.emi

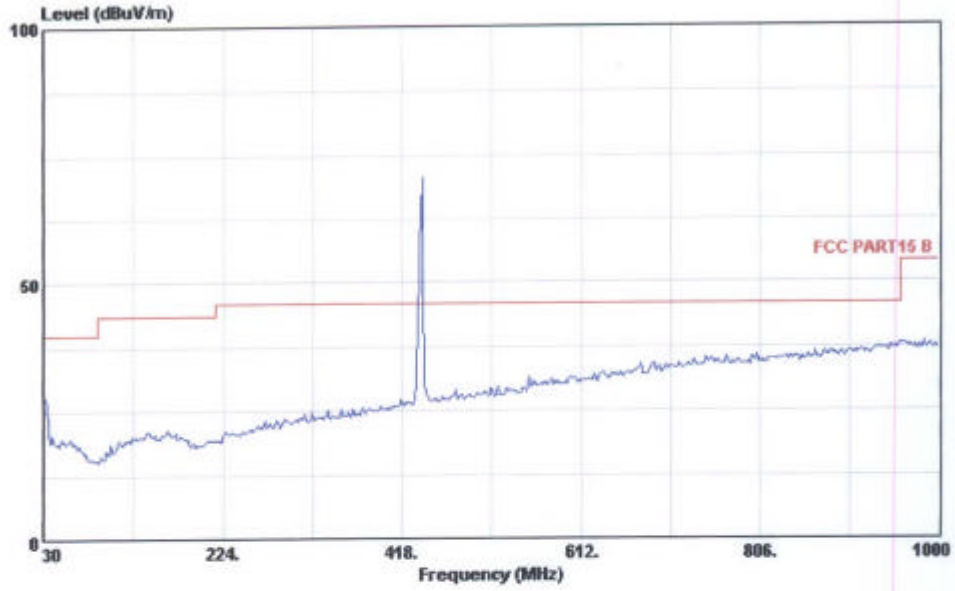

Site : MOO SITE
Condition : FCC PART15 B 3m VERTICAL
EUT :
MODEL : WD-6108
memo : TX

Horizontal

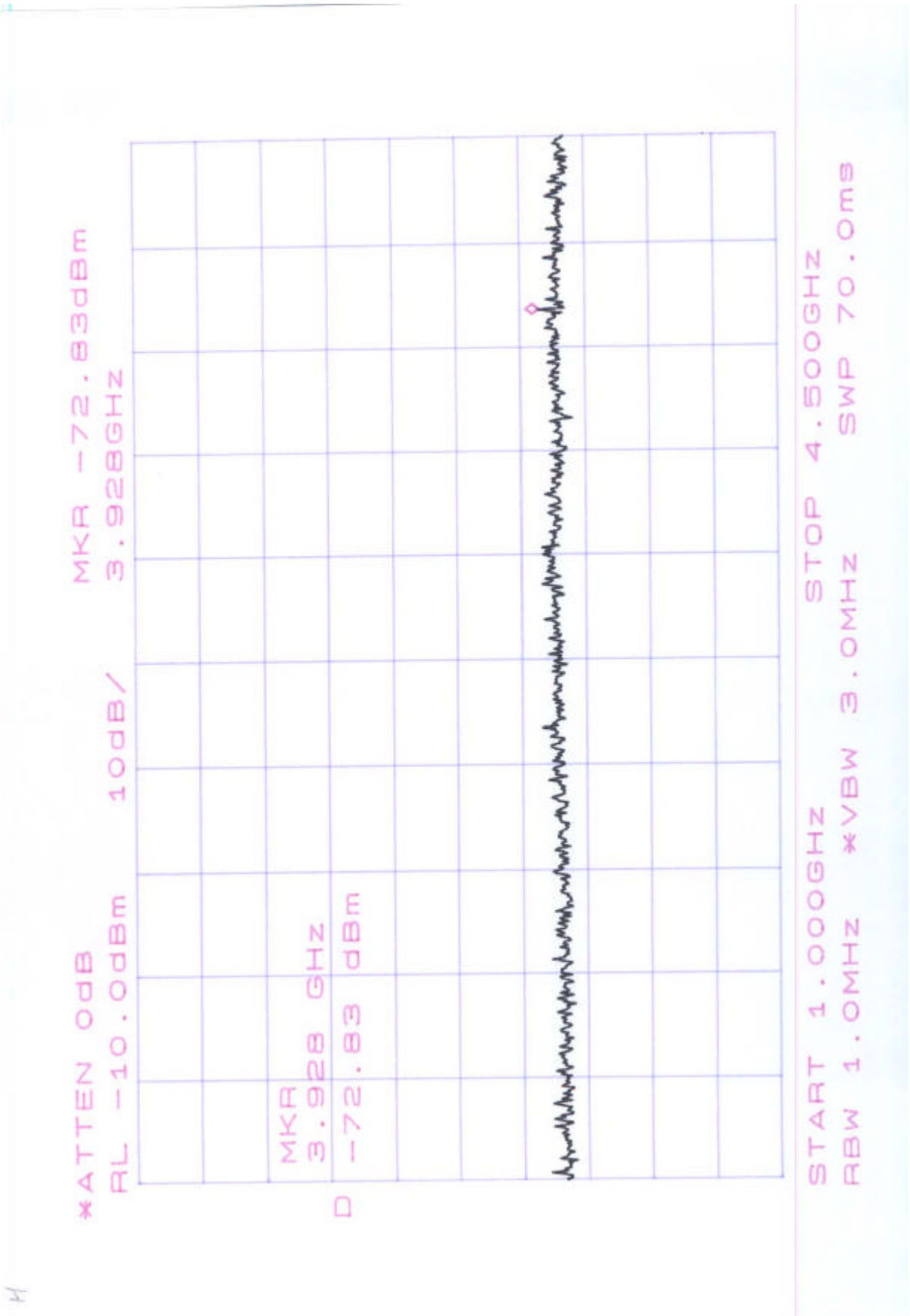

Vertical

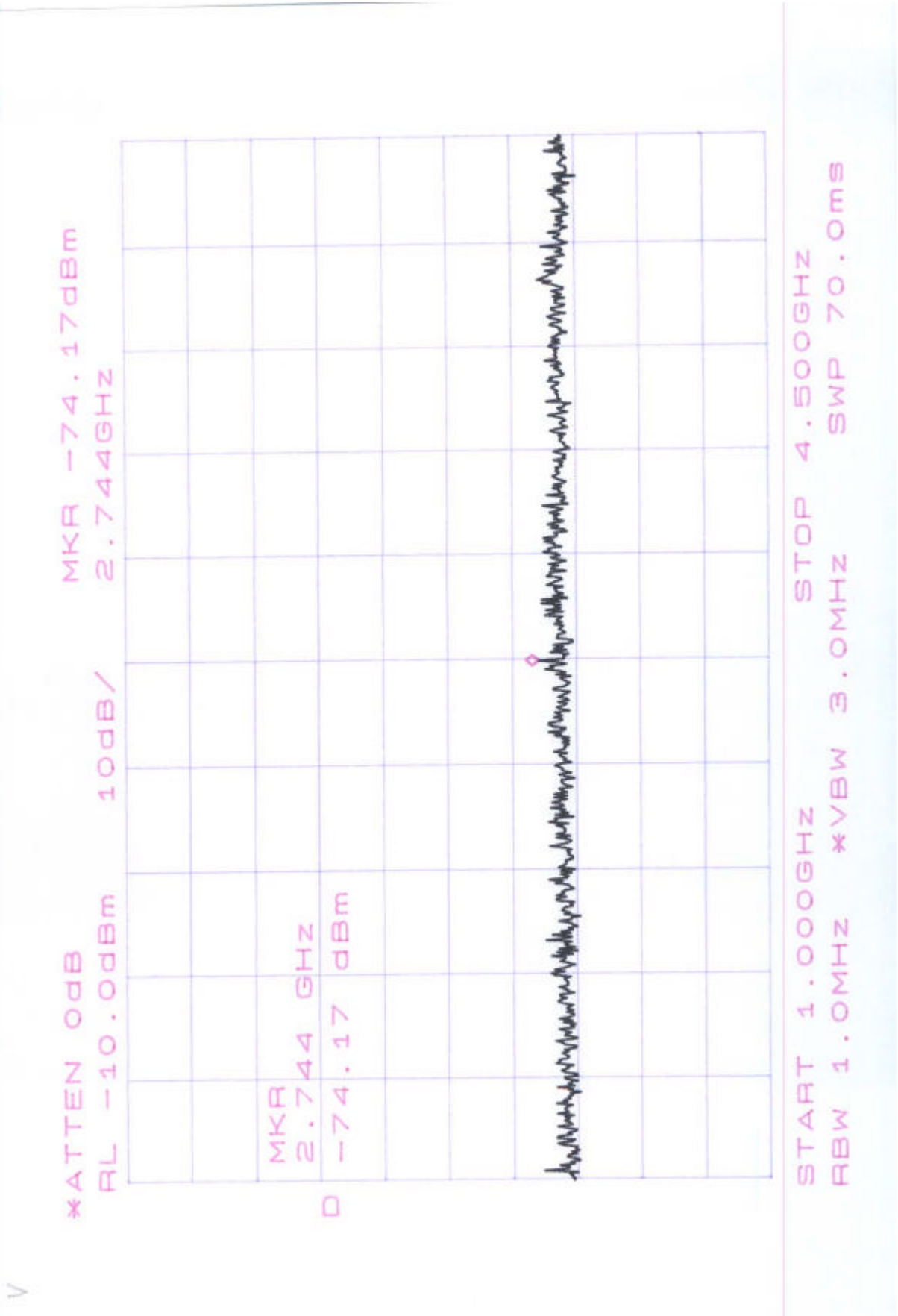

3.4 Field Strength Calculation

(a) Field Strength:

The field strength is calculated by adding the Antenna Factor and Cable Factor, and subtracting the Amplifier Gain (if any) from the measured reading. The basic equation with a sample calculation is as follows:

$$\mathbf{RESULT = READING + CORR. FACTOR}$$

where CORR. FACTOR = Antenna FACTOR + Cable FACTOR

Assume a receiver reading of 62.4 dB μ V is obtained. The Antenna Factor of 14.1 and a Cable Factor of 3.4 is added. The total of field strength is 79.9 dB μ V/m.

$$\mathbf{RESULT = 62.4 + 14.1 + 3.4 = 79.9 \text{ dB } \mu \text{ V/m}}$$

$$\mathbf{Level \text{ in } \mu \text{ V/m} = \text{Common Antilogarithm}[(79.9 \text{ dB } \mu \text{ V/m})/20] = 9885.5 \mu \text{ V/m}}$$

(b) Duty Factor:

$$20\log\frac{0.7467(ms)\times 24}{100(ms)} = -14.9 \text{ dB}$$

The plotted graph of Duty Factor please see page 16 ~ 18.

3.5 Radiated Test Equipment

The following instrument are used for radiated emissions measurement :

Equipment	Manufacturer	Model No.	Serial No.	Calibrated until
EMI Test Receiver	HP	8546A	13054404-001	Sep. 06, 2005
BiconiLog Antenna	Schwarzbeck	VULB 9160	13057310-001	Oct. 28,2005
Horn Antenna	EMCO	3115	9107-3729	Jun. 04, 2005

Note: The standards used to perform this calibration are traceable to NML/ROC, NIST/USA and NPL.

Plotted graph 1 of Duty Factor



Plotted graph 2 of Duty Factor

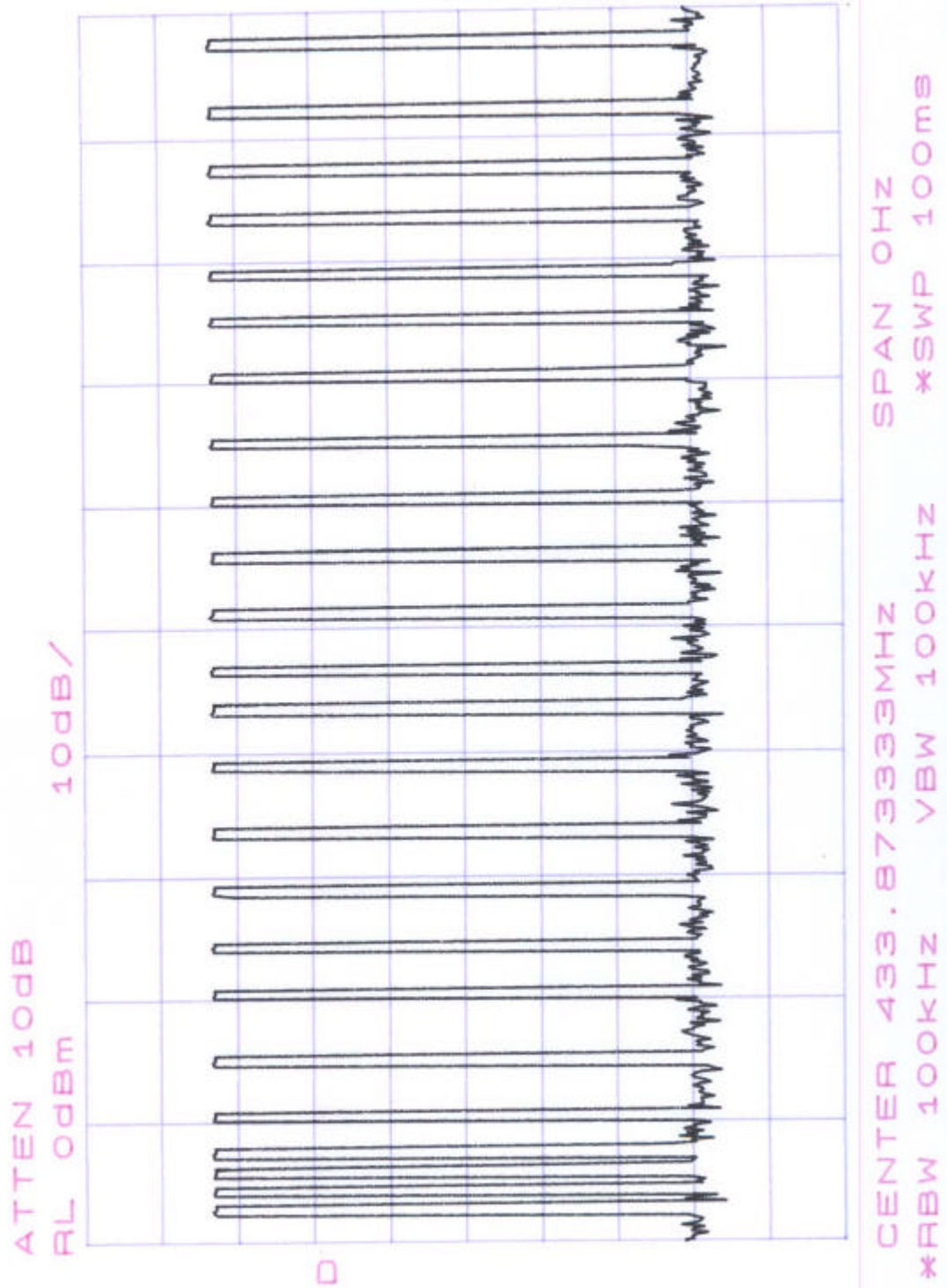

Plotted graph 3 of Duty Factor

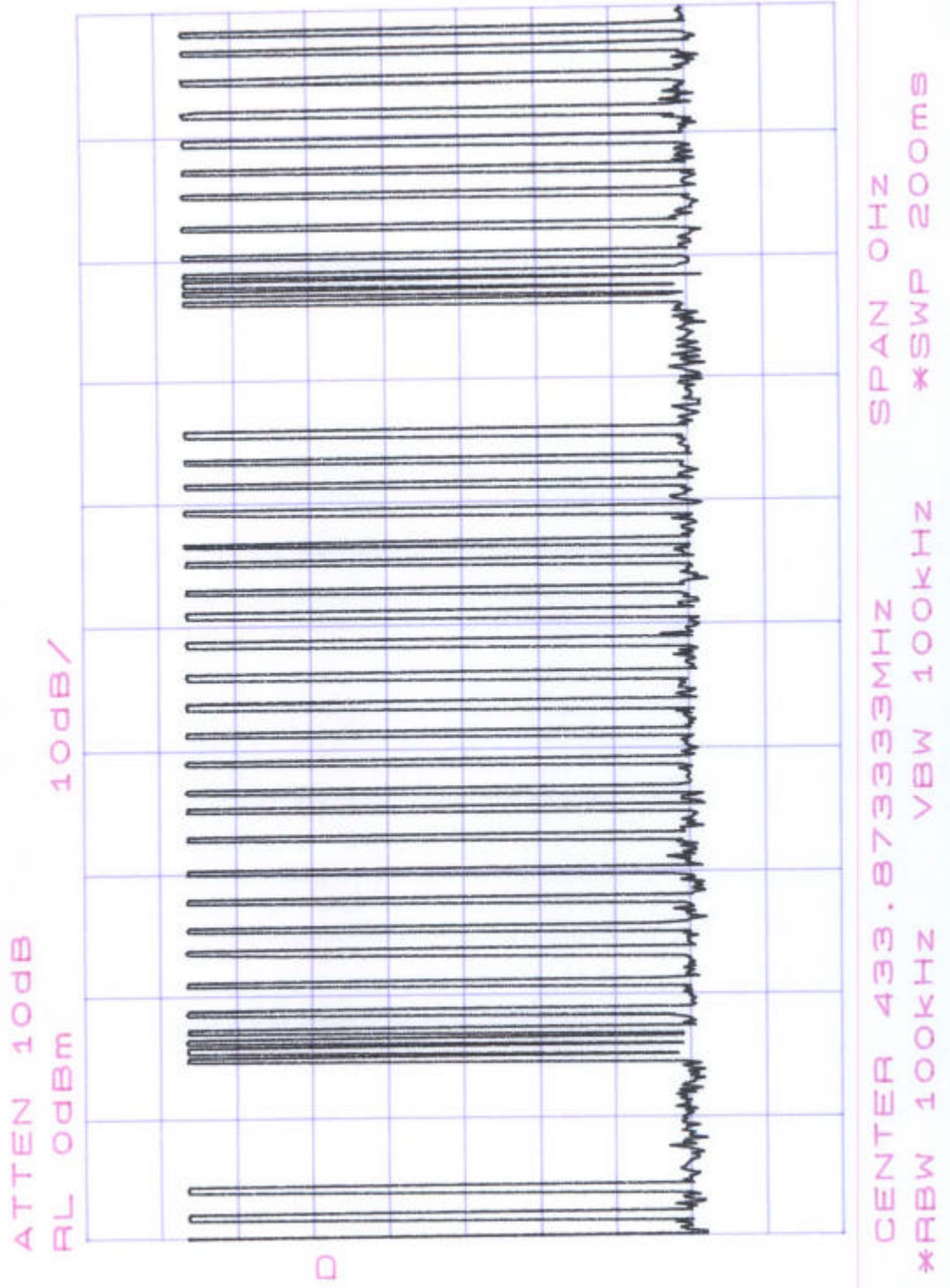

3.6 Measuring Instrument Setup

Measuring instrument setup in measured frequency band when specified detector function is used :

Frequency Band (MHz)	Instrument	Function	Resolution bandwidth	Video Bandwidth
30 to 1000	EMI Test Receiver	Peak	120 kHz	300 kHz
1000 to 5000	EMI Test Receiver	Peak	1 MHz	1 MHz

4. BANDWIDTH OF EMISSION

4.1 Applicable Standard Plot Graphic of Bandwidth

Per FCC rule § 15.231(c), the permitted emission bandwidth is no wider than 0.25% of the center frequency for devices operating above 70 MHz and below 900 MHz.

4.2 Test Equipment

Equipment	Manufacturer	Model No.	Next Cal. Date
Test Receiver	Agilent	8564EC	Sep. 16,2005
Plotter	Hewlett-Packard	7470A	N/A

4.3 Test Result

Test Date : Oct. 28, 2004 Temperature : 24 Humidity : 70 %

Center Frequency	433.870 MHz
FCC Limit	$433.870\text{MHz} \times 0.25\% = 1084.680 \text{ kHz}$
Bandwidth of Emission	$213 \text{ kHz} + 183 \text{ kHz} = 396 \text{ kHz}$
Chart	Page 21, 22
Result	PASS

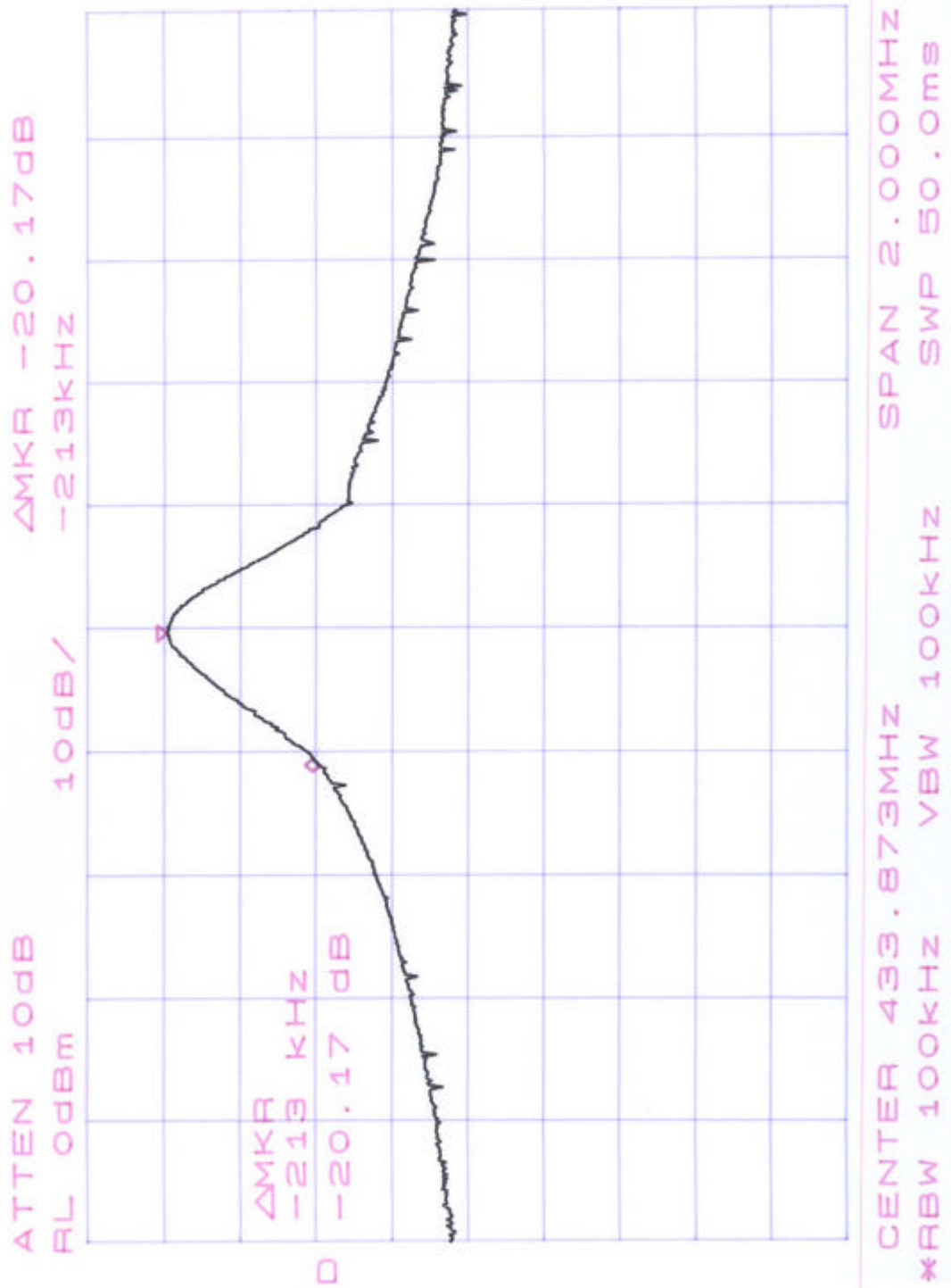

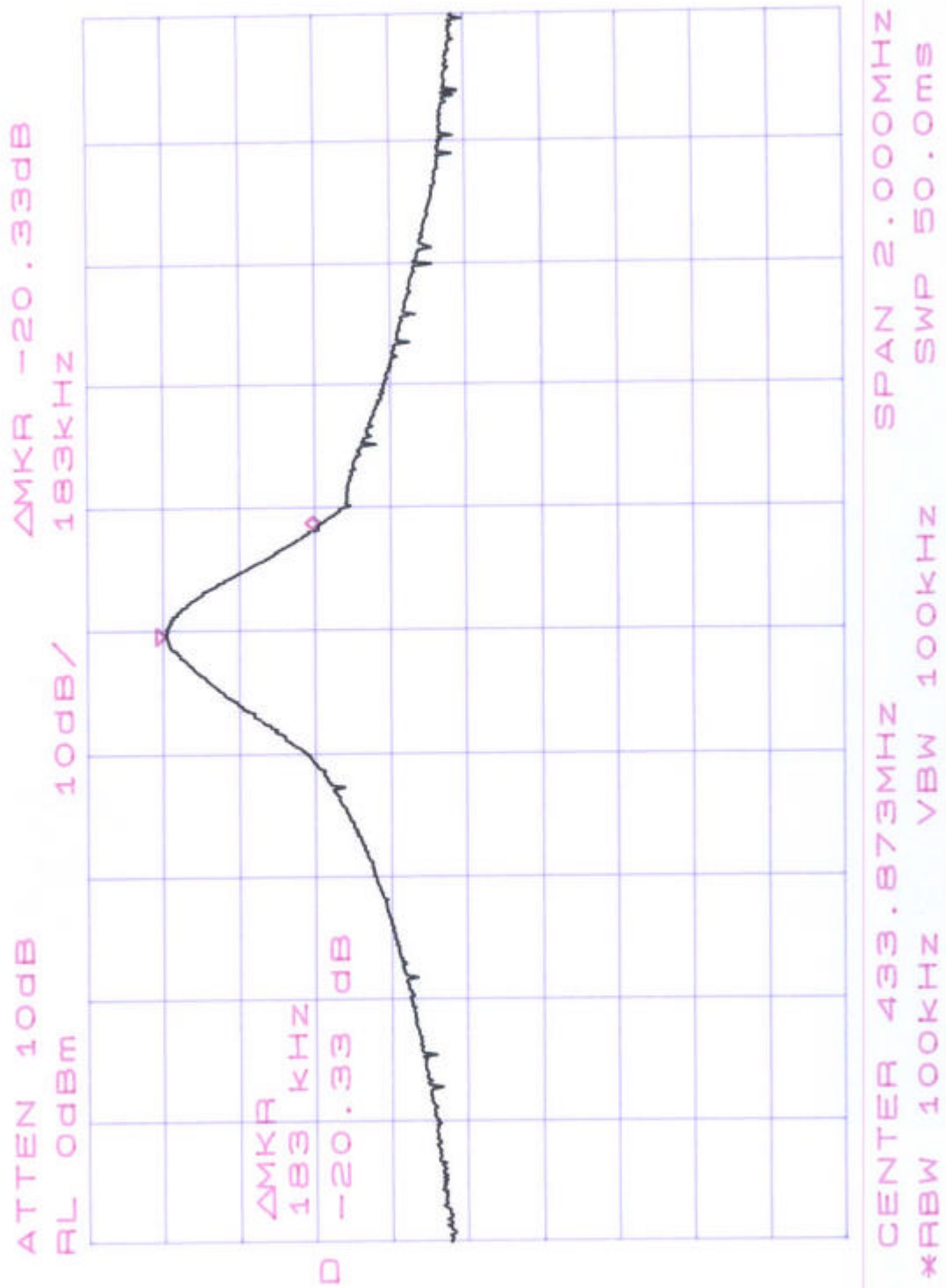

5. CONDUCTED EMISSION MEASUREMENT

This EUT is excused from investigation of conducted emission, for it is powered by battery only. According to § 15.207 (d), measurements to demonstrate compliance with the conducted limits are not required for devices which only employ battery power for operation and which do not operate from the AC power lines or contain provisions for operation while connected to the AC power lines.

6. LIMIT OF TRANSMISSION TIME

6.1 Applicable Standard

According to 15.231(a)(1), a manually operated transmitter shall employ a switch that will automatically deactivate the transmitter within not more than 5 seconds of being released.

6.2 Active Time

This transmitter is operated by manual and active time is 1.2 second after being released.

Note : Please refer to page 25 for chart

