

# RF MEASUREMENT REPORT

---

**FCC ID:** SFK-WF810E  
**Applicant:** CIG Shanghai Co., Ltd.  
**Product:** Tri-band Wi-Fi 6E Wireless AP  
**Model No.:** WF-810E  
**Brand Name:** CIG  
**FCC Classification:** 15E 6GHz Low Power Indoor Access Point (6ID)  
**FCC Rule Part(s):** Part 15 Subpart E (Section 15.407)  
**Result:** Complies  
**Received Date:** 2022-10-27  
**Test Date:** 2023-01-11 ~ 2023-04-07

**Reviewed By:**

\_\_\_\_\_  
Kevin Guo

**Approved By:**

\_\_\_\_\_  
Robin Wu



The test results relate only to the samples tested.

This equipment has been shown to be capable of compliance with the applicable technical standards as indicated in the measurement report and was tested in accordance with the measurement procedures specified in KDB789033. Test results reported herein relate only to the item(s) tested.

The test report shall not be reproduced except in full without the written approval of MRT Technology (Suzhou) Co., Ltd.

---

### Revision History

Report No.	Version	Description	Issue Date	Note
2210RSU047-U6	V01	Initial Report	2023-04-17	Valid

---

## CONTENTS

Description	Page
<b>1. General Information .....</b>	<b>6</b>
1.1. Applicant .....	6
1.2. Manufacturer .....	6
1.3. Testing Facility .....	6
1.4. Product Information .....	7
1.5. Radio Specification under Test .....	7
1.6. Working Frequencies .....	8
1.7. Antenna Details .....	9
<b>2. Test Configuration .....</b>	<b>11</b>
2.1. Test Mode .....	11
2.2. Test System Connection Diagram .....	11
2.3. Test Software .....	12
2.4. Applied Standards .....	12
1.8. Test Environment Condition .....	12
<b>3. Antenna Requirements .....</b>	<b>13</b>
<b>4. Measuring Instrument .....</b>	<b>14</b>
<b>5. Decision Rules and Measurement Uncertainty .....</b>	<b>15</b>
5.1. Decision Rules .....	15
5.2. Measurement Uncertainty .....	15
<b>6. Test Result .....</b>	<b>16</b>
6.1. Summary .....	16
6.2. 26dB Bandwidth Measurement .....	17
6.2.1. Test Limit .....	17
6.2.2. Test Procedure .....	17
6.2.3. Test Setting .....	17
6.2.4. Test Setup .....	18
6.2.5. Test Result .....	18
6.3. Output Power Measurement .....	19
6.3.1. Test Limit .....	19
6.3.2. Test Procedure .....	19
6.3.3. Test Setting .....	19
6.3.4. Test Setup .....	20
6.3.5. Test Result .....	20
6.4. Power Spectral Density Measurement .....	21
6.4.1. Test Limit .....	21

---

6.4.2.	Test Procedure .....	21
6.4.3.	Test Setting .....	21
6.4.4.	Test Setup.....	22
6.4.5.	Test Result .....	22
6.5.	In-Band Emission Measurement .....	23
6.5.1.	Test Limit .....	23
6.5.2.	Test Procedure .....	23
6.5.3.	Test Setting .....	23
6.5.4.	Test Setup.....	24
6.5.5.	Test Result .....	24
6.6.	Frequency Stability Measurement.....	25
6.6.1.	Test Limit .....	25
6.6.2.	Test Procedure .....	25
6.6.3.	Test Setup.....	25
6.6.4.	Test Result.....	26
6.7.	Contention Based Protocol Measurement .....	27
6.7.1.	Test Limit .....	27
6.7.2.	Test Procedure .....	27
6.7.3.	Test Setting.....	27
6.7.4.	Test Setup.....	28
6.7.5.	Test Result.....	28
6.8.	Radiated Spurious Emission Measurement .....	29
6.8.1.	Test Limit .....	29
6.8.2.	Test Procedure .....	29
6.8.3.	Test Setting.....	30
6.8.4.	Test Setup.....	32
6.8.5.	Test Result.....	33
6.9.	Radiated Restricted Band Edge Measurement.....	34
6.9.1.	Test Limit .....	34
6.9.2.	Test Procedure .....	35
6.9.3.	Test Setting.....	36
6.9.4.	Test Setup.....	37
6.9.5.	Test Result.....	37
6.10.	AC Conducted Emissions Measurement.....	38
6.10.1.	Test Limit .....	38
6.10.2.	Test Setup.....	38
6.10.3.	Test Result.....	38
<b>Appendix A – Test Result.....</b>		<b>39</b>

---

A.1	Duty Cycle Test Result .....	39
A.2	26dB Bandwidth Test Result .....	41
A.3	Output Power Test Result .....	52
A.4	Power Spectral Density Test Result .....	54
A.5	In-Band Emission Measurement .....	65
A.6	Frequency Stability Test Result .....	87
A.7	Contention Based Protocol Test Result .....	88
A.8	Radiated Spurious Emission Test Result .....	100
A.9	Radiated Restricted Band Edge Test Result .....	158
A.10	AC Conducted Emissions Test Result .....	198
<b>Appendix B – Test Setup Photograph .....</b>		<b>200</b>
<b>Appendix C – EUT Photograph .....</b>		<b>201</b>



#### 1.4. Product Information

Product Name	Tri-band Wi-Fi 6E Wireless AP
Model No.	WF-810E
Serial No.	1HG223803250
Wi-Fi Specification	802.11a/b/g/n/ac/ax
Bluetooth Specification	V5.0 (Single mode, LE only)
Antenna Information	Refer to Section 1.7
Accessories	
Adapter #1	Model No.: ADT-38FKJ-PCU00F Input: 100-240V, 50/60Hz, Max. 1.0A Output: 5.0V=3.0A or 12.0V=3.0A
Adapter #2	Model No.: ADS036G-W 120300 Input: 100-240V, 50/60Hz, Max. 1.0A Output: 5.0V=3.0A, 9.0V=3.0A, 12.0V=3.0A
Note: 1. The information of EUT was provided by the manufacturer, and the accuracy of the information shall be the responsibility of the manufacturer. 2. Adapter #1 was selected in this report.	

#### 1.5. Radio Specification under Test

Frequency Range	For 802.11a/ax-HE20: 5955 ~ 7095MHz For 802.11ax-HE40: 5965 ~ 7085MHz For 802.11ax-HE80: 5985 ~ 7025MHz For 802.11ax-HE160: 6025 ~ 6985MHz
Type of Modulation	802.11a: OFDM, 802.11ax: OFDMA
Data Rate	802.11a: up to 54Mbps 802.11ax: up to 2402Mbps

## 1.6. Working Frequencies

### 802.11a/ax-HE20

Channel	Frequency	Channel	Frequency	Channel	Frequency
01	5955 MHz	05	5975 MHz	09	5995 MHz
13	6015 MHz	17	6035 MHz	21	6055 MHz
25	6075 MHz	29	6095 MHz	33	6115 MHz
37	6135 MHz	41	6155 MHz	45	6175 MHz
49	6195 MHz	53	6215 MHz	57	6235 MHz
61	6255 MHz	65	6275 MHz	69	6295 MHz
73	6315 MHz	77	6335 MHz	81	6355 MHz
85	6375 MHz	89	6395 MHz	93	6415 MHz
97	6435 MHz	101	6455 MHz	105	6475 MHz
109	5495 MHz	113	6515 MHz	117	6535 MHz
121	6555 MHz	125	6575 MHz	129	6595 MHz
133	6615 MHz	137	6635 MHz	141	6655 MHz
145	6675 MHz	149	6695 MHz	153	6715 MHz
157	6735 MHz	161	6755 MHz	165	6775 MHz
169	6795 MHz	173	6815 MHz	177	6835 MHz
181	6855 MHz	185	6875 MHz	189	6895 MHz
193	6915 MHz	197	6935 MHz	201	6955 MHz
205	6975 MHz	209	6995 MHz	213	7015 MHz
217	7035 MHz	221	7055 MHz	225	7075 MHz
229	7095 MHz	--	--	--	--

### 802.11ax-HE40

Channel	Frequency	Channel	Frequency	Channel	Frequency
03	5965 MHz	11	6005 MHz	19	6045 MHz
27	6085 MHz	35	6125 MHz	43	6165 MHz
51	6205 MHz	59	6245 MHz	67	6285 MHz
75	6325 MHz	83	6365 MHz	91	6405 MHz
99	6445 MHz	107	6485 MHz	115	6525 MHz
123	6565 MHz	131	6605 MHz	139	6645 MHz
147	6685 MHz	155	6725 MHz	163	6765 MHz
171	6805 MHz	179	6845 MHz	187	6885 MHz
195	6925 MHz	203	6965 MHz	211	7005 MHz
219	7045 MHz	227	7085 MHz	--	--



## 802.11ax-HE80

Channel	Frequency	Channel	Frequency	Channel	Frequency
07	5985 MHz	23	6065 MHz	39	6145 MHz
55	6225 MHz	71	6305 MHz	87	6385 MHz
103	6465 MHz	119	6545 MHz	135	6625 MHz
151	6705 MHz	167	6785 MHz	183	6865 MHz
199	6945 MHz	215	7025 MHz	--	--

## 802.11ax-HE160

Channel	Frequency	Channel	Frequency	Channel	Frequency
15	6025 MHz	47	6185 MHz	79	6345 MHz
111	6505 MHz	143	6665 MHz	175	6825 MHz
207	6985 MHz	--	--	--	--

## 1.7. Antenna Details

Antenna Type	Frequency (MHz)	TX Path	Antenna Gain (dBi)				Directional Gain (dBi)	
			Ant 0	Ant 1	Ant 2	Ant 3	Correlated	Uncorrelated
Wi-Fi Antenna								
PIFA	2412 ~ 2462	2	3.80	4.10	--	--	4.46	1.56
	5180 ~ 5320	4	4.60	6.20	4.30	4.02	7.58	1.85
	5500 ~ 5720	4	4.30	5.50	4.80	4.35	8.01	2.29
	5745 ~ 5825	4	3.70	5.20	4.10	4.70	8.01	2.23
	5925 ~ 7125	2	4.70	4.20	--	--	6.60	3.59

## Remark:

- The antenna gain and directional gain refer to manufacturer's antenna specification.
- The device supports CDD Mode and STBC mode, details refer to the table as below.
- CDD signals are correlated, the directional gain as follows,  
 For power measurements: Array Gain = 0 dB for  $N_{ANT} \leq 4$ , the directional gain = max antenna gain + array gain  
 For power spectral density (PSD) measurements: the max directional gain (each angle) =  $10 \log[(10^{G1/20} + 10^{G2/20} + \dots + 10^{GN/20})^2 / N_{ANT}]$
- STBC signals are uncorrelated, the directional gain as follows,  
 the max directional gain (each angle) =  $10 \log[(10^{G1/10} + 10^{G2/10} + \dots + 10^{GN/10}) / N_{ANT}]$

Test Mode	T <sub>x</sub> Paths	CDD Mode	STBC Mode
Wi-Fi 2.4G			
802.11b/g	2	√	X
802.11n/ax	2	X	√
Wi-Fi 5G			
802.11a	4	√	X
802.11n/ac/ax	4	X	√
Wi-Fi 6G			
802.11a	2	√	X
802.11ax	2	X	√
Remark: "√" means "Support", "X" means "Not support".			

## 2. Test Configuration

### 2.1. Test Mode

Mode 1: Transmit by 802.11a (6Mbps) _ Nss=1 (CDD Mode)
Mode 2: Transmit by 802.11ax-HE20 (MCS0) _ Nss=2 (STBC Mode)
Mode 3: Transmit by 802.11ax-HE40 (MCS0) _ Nss=2 (STBC Mode)
Mode 4: Transmit by 802.11ax-HE80 (MCS0) _ Nss=2 (STBC Mode)
Mode 5: Transmit by 802.11 ax-HE160 (MCS0) _ Nss=2 (STBC Mode)
Note:
1. For Radiated emission, the modulation and the data rate picked for testing are determined by the Max. RF conducted power.
2. For CDD mode, this device supports 2 Nss and power level is the same of spatial multiplexing. The worst case is Nss=1.
3. EUT supports one configuration only in 802.11ax full RU mode.
4. All modes of operation and data rates were investigated, so all RF test requirements shall be executed at the worse data rate which power is the greatest.

### 2.2. Test System Connection Diagram

The device was tested per the guidance ANSI C63.10: 2013 was used to reference the appropriate EUT setup for radiated emissions testing and AC line conducted testing.

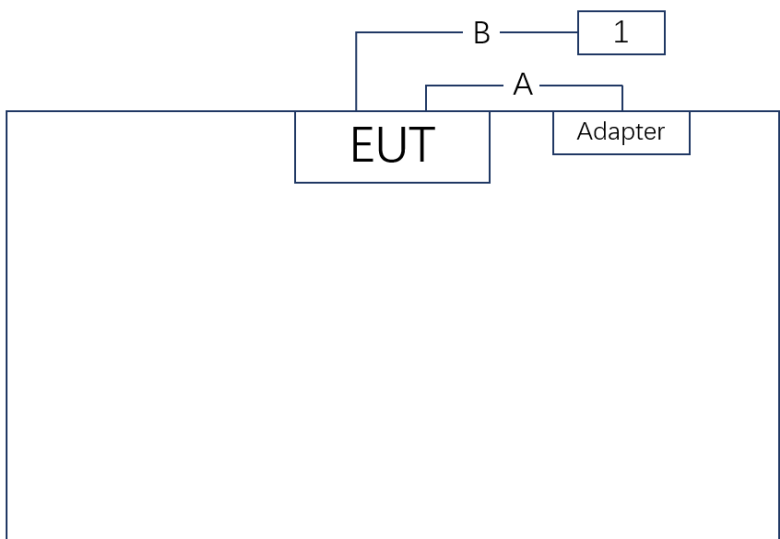
Connection Diagram			
 <pre>                     graph LR                         EUT[EUT] --- A[A] --- Adapter[Adapter]                         Adapter --- B[B] --- 1[1]                     </pre>			
No.	Cable Type	Cable Spec.	Length
A	Power Cable	Non-Shielding	1.2m
B	Ethernet Cable	Non-Shielding	>5m

No.	Product	Manufacturer	Model No.
1	Notebook	Lenovo	E495

### 2.3. Test Software

The test utility software used during testing was “QRCT”, and the version was 3.0.268.0.

Note: Final power setting please refer to operational description

### 2.4. Applied Standards

According to the specifications of the manufacturer, the EUT must comply with the requirements of the following standards:

- ANSI C63.10-2013
- FCC KDB 789033 D02v02r01
- FCC KDB 987594 D02v01
- FCC KDB 987594 D04v01
- FCC KDB 662911 D01v02r01
- FCC KDB 414788 D01v01r01
- FCC KDB 412172 D01v01r01

### 1.8. Test Environment Condition

Ambient Temperature	15 ~ 35°C
Relative Humidity	20 ~ 75%RH

### 3. Antenna Requirements

Excerpt from §15.407(a)(9) of the FCC Rules/Regulations:

Access points operating under the provisions of paragraphs (a)(5) and (a)(6) of this section must employ a permanently attached integrated antenna.

- The antenna of the device is built in and locked inside the enclosure.

Conclusion:

The device complies with the requirement of §15.407(a)(9).

#### 4. Measuring Instrument

Instrument	Manufacturer	Model No.	Asset No.	Cali. Interval	Cali. Due Date	Test Site
EMI Test Receiver	R&S	ESR3	MRTSUE06185	1 year	2023-12-28	SIP-AC1
Anechoic Chamber	RIKEN	SIP-AC1	MRTSUE06554	1 year	2023-12-22	SIP-AC1
Thermohygrometer	testo	608-H1	MRTSUE06616	1 year	2023-11-01	SIP-AC1
Thermohygrometer	testo	608-H1	MRTSUE06620	1 year	2023-11-27	SIP-AC1
TRILOG Antenna	Schwarzbeck	VULB 9168	MRTSUE06645	1 year	2023-07-30	SIP-AC1
Loop Antenna	Schwarzbeck	FMZB 1519 B	MRTSUE06937	1 year	2024-02-26	SIP-AC1
Signal Analyzer	Keysight	N9010B	MRTSUE06559	1 year	2023-06-01	SIP-AC2
Horn Antenna	Schwarzbeck	BBHA 9170	MRTSUE06598	1 year	2023-11-05	SIP-AC2
Preamplifier	EMCI	EMC051845SE	MRTSUE06601	1 year	2023-11-22	SIP-AC2
Preamplifier	EMCI	EMC184045SE	MRTSUE06602	1 year	2023-10-10	SIP-AC2
Thermohygrometer	testo	608-H1	MRTSUE06623	1 year	2023-11-27	SIP-AC2
Thermohygrometer	testo	608-H1	MRTSUE06624	1 year	2023-11-27	SIP-AC2
Horn Antenna	Schwarzbeck	BBHA 9120D	MRTSUE06648	1 year	2023-10-22	SIP-AC2
Anechoic Chamber	RIKEN	SIP-AC2	MRTSUE06781	1 year	2023-12-22	SIP-AC2
Signal Analyzer	Keysight	N9010B	MRTSUE06603	1 year	2023-10-25	SIP-AC3
Horn Antenna	R&S	HF907	MRTSUE06611	1 year	2023-07-30	SIP-AC3
Thermohygrometer	testo	608-H1	MRTSUE06619	1 year	2023-11-01	SIP-AC3
Thermohygrometer	testo	608-H1	MRTSUE06622	1 year	2023-11-27	SIP-AC3
Preamplifier	EMCI	EMC012645SE	MRTSUE06642	1 year	2024-01-12	SIP-AC3
TRILOG Antenna	Schwarzbeck	VULB 9168	MRTSUE06646	1 year	2023-08-16	SIP-AC3
Anechoic Chamber	RIKEN	SIP-AC3	MRTSUE06782	1 year	2023-12-22	SIP-AC3
Temperature Chamber	BAOYT	BYG-408CS	MRTSUE06847	1 year	2024-02-12	SIP-TR1
Signal Analyzer	Keysight	N9010B	MRTSUE07036	1 year	2024-02-29	SIP-TR1
Thermohygrometer	testo	608-H1	MRTSUE11022	1 year	2023-11-01	SIP-TR1
Frequency extender for EXG or MXG	Keysight	N5182BX07	MRTSUE06984	1 year	2024-02-29	WZ-SR5
Signal Generator	Keysight	N5182B	MRTSUE06451	1 year	2023-07-08	WZ-SR5
Signal Analyzer	Keysight	N9010B	MRTSUE06457	1 year	2023-06-04	WZ-SR5
Thermohygrometer	testo	608-H1	MRTSUE06402	1 year	2023-06-06	WZ-SR5
Shielding Room	HUAMING	WZ-SR5	MRTSUE06442	N/A	N/A	WZ-SR5

Software	Version	Function
EMI Software	V3.0.0	EMI Test Software
Controller_MF 7802BS	1.02	RE Antenna & Turntable
Agilent Power Panel	V R03.09.00	Power

## 5. Decision Rules and Measurement Uncertainty

### 5.1. Decision Rules

The Decision Rule is based on Simple Acceptance in accordance with ISO Guide 98-4: 2012 Clause 8.2. (Measurement uncertainty is not taken into account when stating conformity with a specified requirement.)

### 5.2. Measurement Uncertainty

Where relevant, the following test uncertainty levels have been estimated for tests performed on the EUT as specified in CISPR 16-4-2. This uncertainty represents an expanded uncertainty expressed at approximately the 95% confidence level using a coverage factor of  $k = 2$ .

<b>AC Conducted Emission Measurement</b>
Measurement Uncertainty for a Level of Confidence of 95% ( $U=2Uc(y)$ ): 9kHz~150kHz: 3.58dB 150kHz~30MHz: 3.20dB
<b>Radiated Disturbance</b>
Measurement Uncertainty for a Level of Confidence of 95% ( $U=2Uc(y)$ ): Coaxial: 9kHz~30MHz: 2.59dB Coplanar: 9kHz~30MHz: 2.60dB Horizontal: 30MHz~200MHz: 3.85dB 200MHz~1GHz: 4.36dB 1GHz~40GHz: 4.98dB Vertical: 30MHz~200MHz: 4.06dB 200MHz~1GHz: 5.28dB 1GHz~40GHz: 4.91dB
<b>Spurious Emissions, Conducted</b>
Measuring Uncertainty for a Level of Confidence of 95% ( $U=2Uc(y)$ ): 2.3dB
<b>Output Power</b>
Measuring Uncertainty for a Level of Confidence of 95% ( $U=2Uc(y)$ ): 1.5dB
<b>Power Spectrum Density</b>
Measuring Uncertainty for a Level of Confidence of 95% ( $U=2Uc(y)$ ): 2.3dB
<b>Occupied Bandwidth</b>
Measuring Uncertainty for a Level of Confidence of 95% ( $U=2Uc(y)$ ): 3.2%

## 6. Test Result

### 6.1. Summary

FCC Section(s)	Test Description	Test Condition	Verdict
15.407(a)	26dB Bandwidth	Conducted	Pass
15.407(a)(5)	Maximum Equivalent Isotropically Radiated Power (e.i.r.p)		Pass
15.407(a)(5)	Peak Power Spectral Density (e.i.r.p)		Pass
15.407(b)(7)	In-Band Emission		Pass
15.407(g)	Frequency Stability		Pass
15.407(d)(6)	Contention-Based Protocol		Pass
15.407(b)(6)	Unwanted Emissions		Pass
15.407(b)(8), (9), (10)	General Field Strength (Restricted Bands and Radiated Emission)	Radiated	Pass
15.207	AC Conducted Emissions 150kHz - 30MHz	Line Conducted	Pass

#### Notes:

- The analyzer plots shown in this section were all taken with a correction table loaded into the analyzer. The correction table was used to account for the losses of the cables and attenuators used as part of the system to connect the EUT to the analyzer at all frequencies of interest.
- For radiated emission test, every axis (X, Y, Z) was also verified. The test results shown in the following sections represent the worst-case emissions.



## 6.2. 26dB Bandwidth Measurement

### 6.2.1. Test Limit

N/A

### 6.2.2. Test Procedure

KDB 789033 D02v02r01- Section II)C)1) (26dB Bandwidth)

KDB 789033 D02v02r01- Section II)D) (99% Bandwidth)

### 6.2.3. Test Setting

#### 26dB Bandwidth

1. The analyzers' automatic bandwidth measurement capability was used to perform the 26dB bandwidth
2. RBW = approximately 1% of the emission bandwidth.
3. VBW > RBW
4. Detector = Peak.
5. Trace mode = max hold.
6. Measure the maximum width of the emission that is 26 dB down from the maximum of the emission.  
Compare this with the RBW setting of the analyzer. Readjust RBW and repeat measurement as needed until the RBW/EBW ratio is approximately 1%.

#### 99% Bandwidth

1. Set center frequency to the nominal EUT channel center frequency.
2. RBW = 1% to 5% of the OBW
3. VBW  $\geq 3 \times$  RBW
4. Span = 1.5 times to 5 times the OBW
5. Detector = peak
6. Trace mode = max hold
7. Allow the trace to stabilize
8. Use the 99% power bandwidth function of the instrument.

#### 6.2.4. Test Setup

Spectrum Analyzer

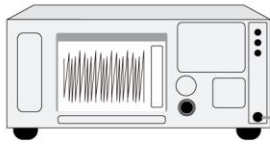

DC Block  
&  
Attenuator



#### 6.2.5. Test Result

Refer to Appendix A.2.

### 6.3. Output Power Measurement

#### 6.3.1. Test Limit

For an indoor access point operating in the 5.925-7.125 GHz band, the maximum e.i.r.p. over the frequency band of operation must not exceed 30 dBm.

For a subordinate device operating under the control of an indoor access point in the 5.925-7.125 GHz band, the maximum e.i.r.p. over the frequency band of operation must not exceed 30 dBm.

#### 6.3.2. Test Procedure

KDB 789033D02v02r01- Section II)A)1

KDB 789033D02v02r01- Section II)E)2)b) Method SA-2

#### 6.3.3. Test Setting

1. Analyzer was set to the center frequency of the UNII channel under investigation
2. Span was set to encompass the entire 26dB EBW of the signal.
3. RBW = 1MHz
4. VBW = 3MHz
5. Number of sweep points  $\geq 2 \times (\text{span} / \text{RBW})$
6. Detector = power averaging (Average)
7. Sweep time = auto
8. Trigger = free run
9. Trace average at least 100 traces in power averaging (rms) mode; however, the number of traces to be averaged shall be increased above 100 as needed to ensure that the average accurately represents the true average over the on and off periods of the transmitter.
10. Use the channel power function on the instrument to measure the power of the spectrum and record its value.
11. Add  $10 \cdot \log(1/x)$ , where x is the duty cycle, to the measured power in order to compute the average power during the actual transmission times (because the measurement represents an average over both the on and off times of the transmission). For example, add  $10 \cdot \log(1/0.25) = 6$  dB if the duty cycle is 25 percent.

### 6.3.4. Test Setup

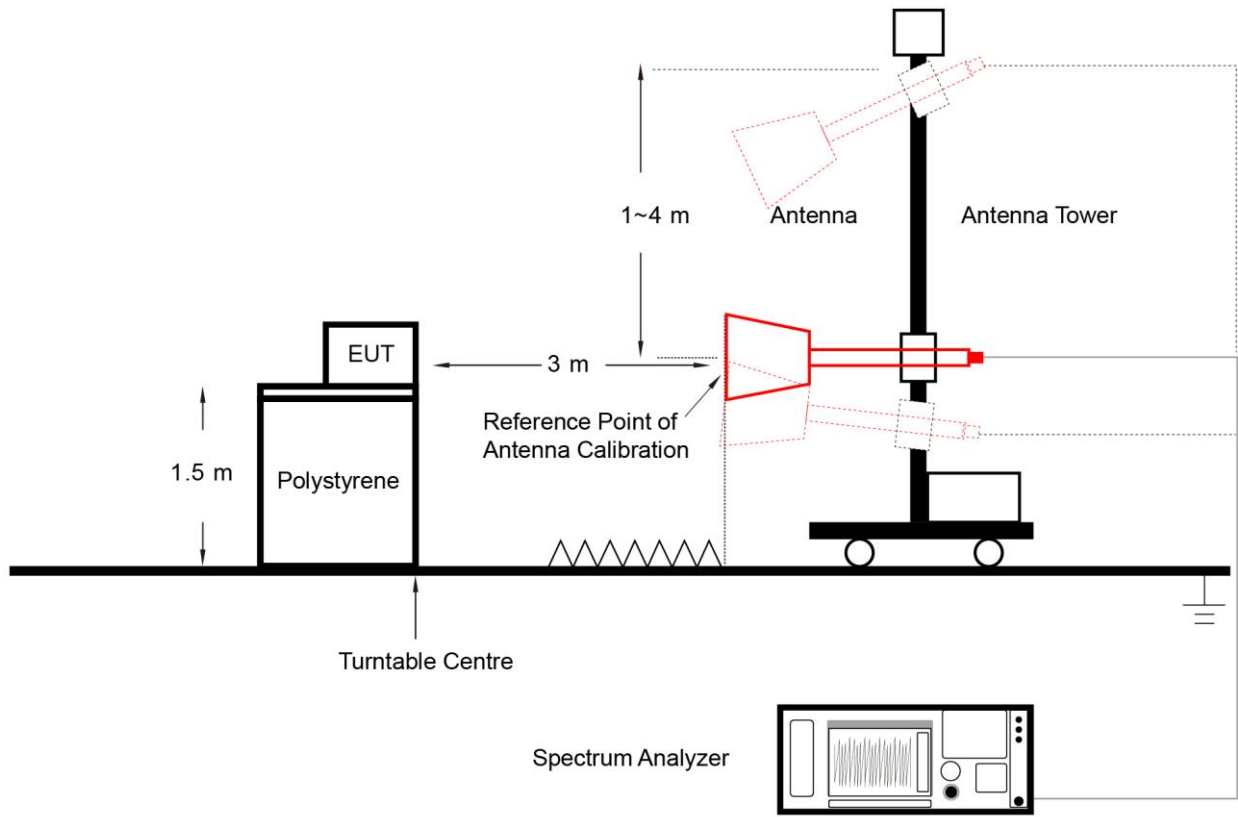

### 6.3.5. Test Result

Refer to Appendix A.3.

## **6.4. Power Spectral Density Measurement**

### **6.4.1. Test Limit**

For an indoor access point operating in the 5.925-7.125 GHz band, the maximum power spectral density must not exceed 5 dBm e.i.r.p. in any 1-megahertz band.

For a subordinate device operating under the control of an indoor access point in the 5.925-7.125 GHz band, the maximum power spectral density must not exceed 5 dBm e.i.r.p in any 1-megahertz band.

### **6.4.2. Test Procedure**

KDB 789033D02v02r01- Section II)A)1

KDB 789033 D02v02r01-Section II)F

### **6.4.3. Test Setting**

12. Analyzer was set to the center frequency of the UNII channel under investigation
13. Span was set to encompass the entire 26dB EBW of the signal.
14. RBW = 1MHz
15. VBW = 3MHz
16. Number of sweep points  $\geq 2 \times (\text{span} / \text{RBW})$
17. Detector = power averaging (Average)
18. Sweep time = auto
19. Trigger = free run
20. Trace average at least 100 traces in power averaging (rms) mode; however, the number of traces to be averaged shall be increased above 100 as needed to ensure that the average accurately represents the true average over the on and off periods of the transmitter.
21. Use the peak search function on the instrument to find the peak of the spectrum and record its value.
22. Add  $10 \cdot \log(1/x)$ , where x is the duty cycle, to the measured power in order to compute the average power during the actual transmission times (because the measurement represents an average over both the on and off times of the transmission). For example, add  $10 \cdot \log(1/0.25) = 6$  dB if the duty cycle is 25 percent.

#### 6.4.4. Test Setup

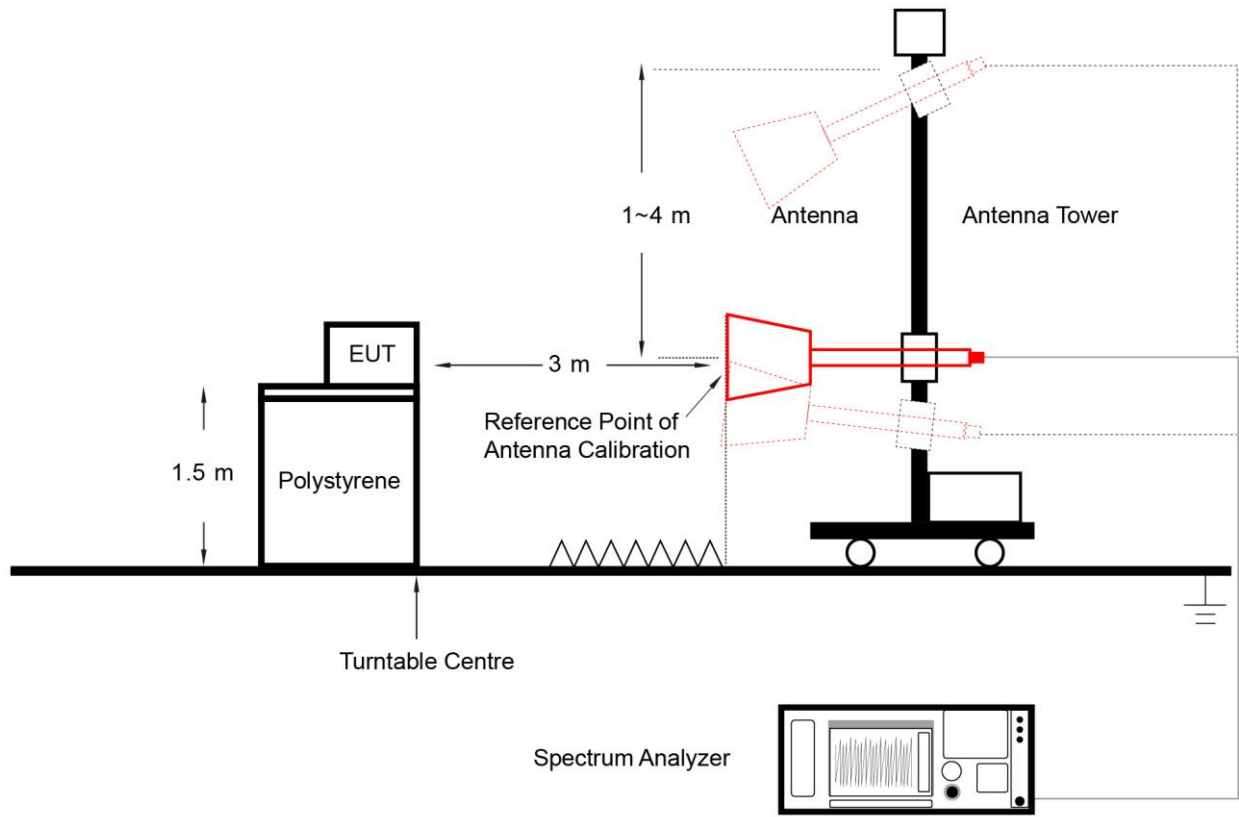

#### 6.4.5. Test Result

Refer to Appendix A.4.

## 6.5. In-Band Emission Measurement

### 6.5.1. Test Limit

Suppressed by 20 dB at 1 MHz outside of the channel edge. (The channel edge is defined as the 26-dB point on either side of the carrier center frequency.)

Suppressed by 28 dB at one channel bandwidth from the channel center.

Suppressed by 40 dB at one- and one-half times the channel bandwidth from the channel center.

### 6.5.2. Test Procedure

KDB 789033D02v02r01- Section II)A)1

KDB 987594 D02v01r01- Section J

### 6.5.3. Test Setting

#### Emissions Mask Reference Level Measurement

1. Set the span to encompass the entire 26 dB EBW of the signal.
2. Set RBW = same RBW used for 26 dB EBW measurement.
3. Set VBW  $\geq 3 \times$  RBW.
4. Number of points in sweep  $\geq [2 \times \text{span} / \text{RBW}]$ .
5. Sweep time = auto.
6. Detector = RMS.
7. Trace average at least 100 traces in power averaging (rms) mode.
8. Use the peak search function on the instrument to find the peak of the spectrum.

#### In-Band Emission

1. Using the measuring equipment limit line function, develop the emissions mask based on rule.
2. Adjust the span to encompass the entire mask as necessary.
3. Clear trace.
4. Trace average at least 100 traces in power averaging (rms) mode.
5. Adjust the reference level as necessary so that the crest of the channel touches the top of the emission mask.

#### 6.5.4. Test Setup

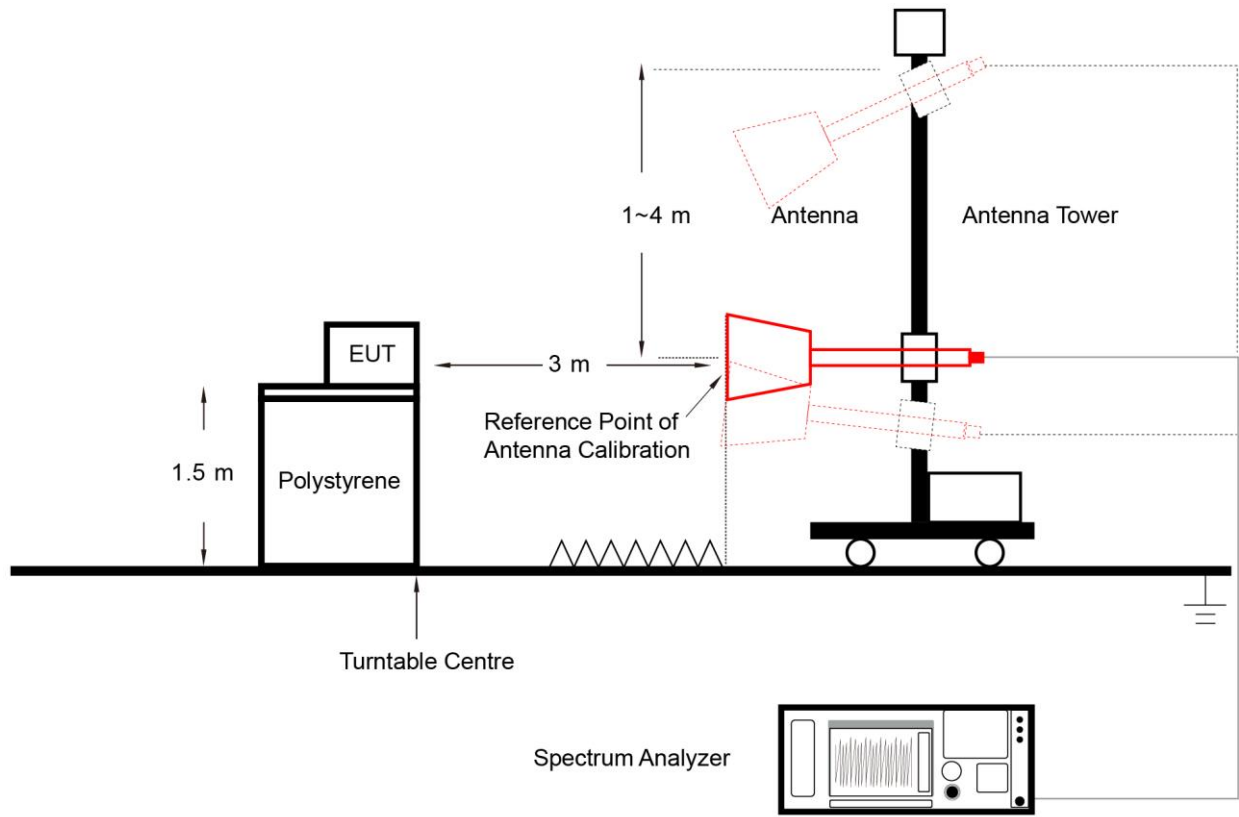

#### 6.5.5. Test Result

Refer to Appendix A.5.



## 6.6. Frequency Stability Measurement

### 6.6.1. Test Limit

Manufactures of U-NII devices are responsible for ensuring frequency stability such that an emission is maintained within the band of operation under all conditions of normal operation as specified in the user's manual.

### 6.6.2. Test Procedure

#### Frequency Stability Under Temperature Variations:

The equipment under test was connected to an external AC or DC power supply and input rated voltage. RF output was connected to a frequency counter or spectrum analyzer via feed through attenuators. The EUT was placed inside the temperature chamber. Set the spectrum analyzer RBW low enough to obtain the desired frequency resolution and measure EUT 20°C operating frequency as reference frequency. Turn EUT off and set the chamber temperature to highest. After the temperature stabilized for approximately 30 minutes recorded the frequency. Repeat step measure with 10°C decreased per stage until the lowest temperature reached.

#### Frequency Stability Under Voltage Variations:

Set chamber temperature to 20°C. Use a variable AC power supply / DC power source to power the EUT and set the voltage to rated voltage. Set the spectrum analyzer RBW low enough to obtain the desired frequency resolution and recorded the frequency.

Reduce the input voltage to specify extreme voltage variation ( $\pm 15\%$ ) and endpoint, record the maximum frequency change.

### 6.6.3. Test Setup

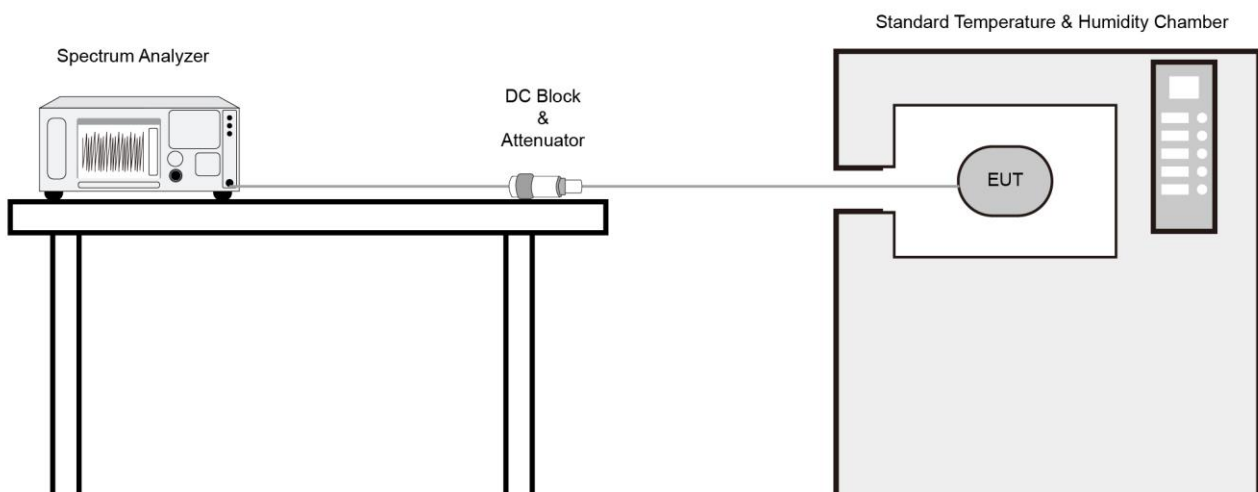

#### **6.6.4. Test Result**

Refer to Appendix A.6.

## **6.7. Contention Based Protocol Measurement**

### **6.7.1. Test Limit**

Unlicensed indoor low power device must detect co-channel radio frequency power that is at least -62dBm (The threshold is referenced to a 0dBi antenna gain.) or low.

Indoor low power device must detect an AWGN signal with 90% (or better) level of certainty.

### **6.7.2. Test Procedure**

KDB 987594 D02v01- Section I

### **6.7.3. Test Setting**

1. Configure the EUT to transmit with a constant duty cycle.
2. Set the operating parameters of the EUT including power level, operating frequency, modulation and bandwidth.
3. Set the signal analyzer center frequency to the nominal EUT channel center frequency. The span range of the signal analyzer shall be between two times and five times the OBW of the EUT.  
Connect the output port of the EUT to the signal analyzer 2. Ensure that the attenuator 2 provides enough attenuation to not overload the signal analyzer 2 receiver.
4. Monitoring the signal analyzer 2, verify the EUT is operating and transmitting with the parameters set at step two.
5. Using an AWGN signal source, generate a 10 MHz-wide AWGN signal. Use Table 1 of KDB 987594 to determine the center frequency of the 10 MHz AWGN signal relative to the EUT's channel bandwidth and center frequency.
6. Set the AWGN signal power to an extremely low level. Connect the AWGN signal source, via a 3-dB splitter, to the signal analyzer 1 and the EUT as shown in below figure.
7. Transmit the AWGN signal (RF ON) and verify its characteristics on the signal analyzer 1.
8. Monitor the signal analyzer 2 to verify if the AWGN signal has been detected and the EUT has ceased transmission. If the EUT continues to transmit, then incrementally increase the AWGN signal power level until the EUT stops transmitting.
9. Determine and record the AWGN signal power level (at the EUT's antenna port) at which the EUT ceased transmission. Repeat the procedure at least 10 times to verify the EUT can detect an AWGN signal with 90% (or better) level of certainty.
10. Refer to Table 1 to determine number of times the detection threshold testing needs to be

repeated. If testing is required more than once, then go back to step 5, choose a different center frequency for the AWGN signal and repeat the process.

#### 6.7.4. Test Setup

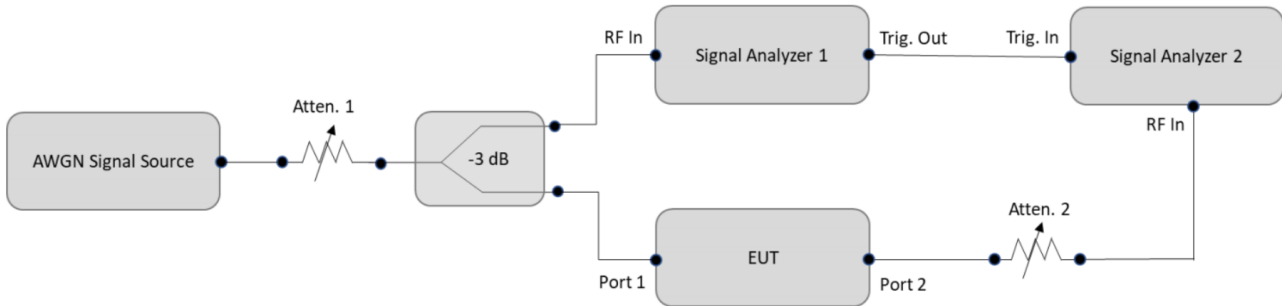

#### 6.7.5. Test Result

Refer to Appendix A.7.

## 6.8. Radiated Spurious Emission Measurement

### 6.8.1. Test Limit

For 15.407(b)(5) requirement

For transmitters operating within the 5.925-7.125 GHz band: Any emissions outside of the 5.925-7.125 GHz band must not exceed an e.i.r.p. of  $-27$  dBm/MHz.

Refer to 987594 D02 U-NII 6GHz EMC Measurement v01 clause G

Use guidance in KDB 789033 for measurements below 1000 MHz and above 1000 MHz. Unwanted emissions outside of restricted bands are measured with a RMS detector. In addition, 15.35(b) applies where the peak emissions must be limited to no more than 20 dB above the average limit.

All out of band emissions appearing in a restricted band as specified in Section 15.205 of the Title 47CFR must not exceed the limits shown in Table per Section 15.209.

FCC Part 15 Subpart C Paragraph 15.209		
Frequency [MHz]	Field Strength [ $\mu$ V/m]	Measured Distance [Meters]
0.009 - 0.490	2400/F (kHz)	300
0.490 - 1.705	24000/F (kHz)	30
1.705 - 30	30	30
30 - 88	100	3
88 - 216	150	3
216 - 960	200	3
Above 960	500	3

### 6.8.2. Test Procedure

KDB 789033 D02v02r01-Section II)G)

### 6.8.3. Test Setting

**Table 1 - RBW as a function of frequency**

Frequency	RBW
9 ~ 150 kHz	200 ~ 300 Hz
0.15 ~ 30 MHz	9 ~ 10 kHz
30 ~ 1000 MHz	100 ~ 120 kHz
> 1000MHz	1MHz

#### **Quasi-Peak Measurements below 1GHz**

1. Analyzer center frequency was set to the frequency of the radiated spurious emission of interest
2. Span was set greater than 1MHz
3. RBW = as specified in Table 1
4. Detector = CISPR quasi-peak
5. Sweep time = auto couple
6. Trace was allowed to stabilize

#### **Peak Measurements above 1GHz**

1. Analyzer center frequency was set to the frequency of the radiated spurious emission of interest
2. RBW = 1MHz
3. VBW = 3MHz
4. Detector = peak
5. Sweep time = auto couple
6. Trace mode = max hold
7. Trace was allowed to stabilize

**Average Measurements above 1GHz (Method VB)**

1. Analyzer center frequency was set to the frequency of the radiated spurious emission of interest
2. RBW = 1MHz
3. VBW; If the EUT is configured to transmit with duty cycle  $\geq 98\%$ , set VBW = 10 Hz.  
If the EUT duty cycle is  $< 98\%$ , set VBW  $\geq 1/T$ . T is the minimum transmission duration.
4. Detector = Peak
5. Sweep time = auto
6. Trace mode = max hold
7. Trace was allowed to stabilize

### 6.8.4. Test Setup

Below 30MHz Test Setup:

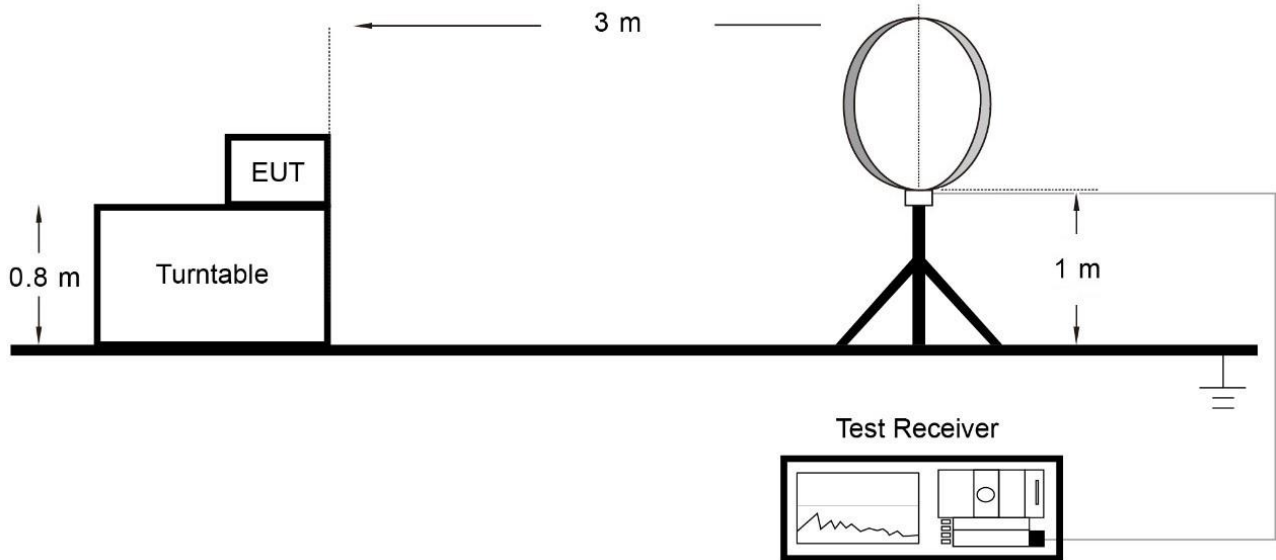

Below 1GHz Test Setup:

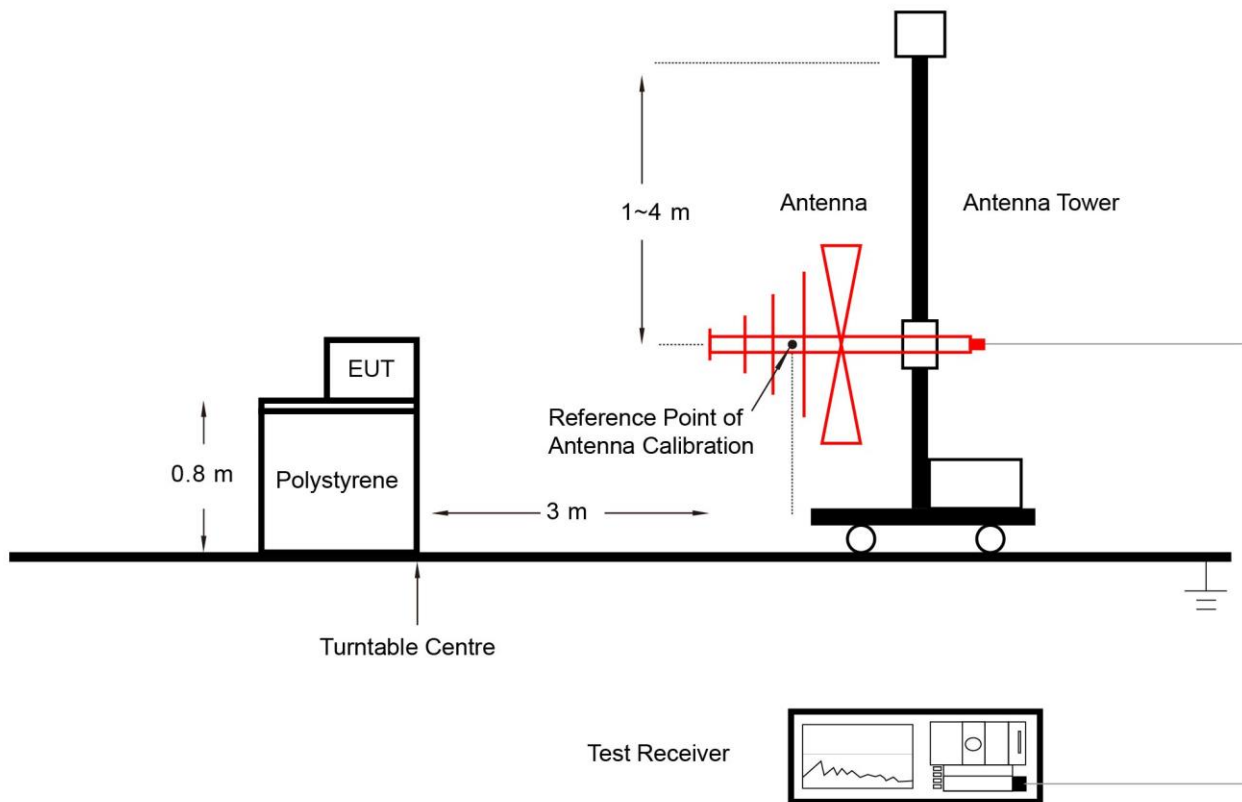



Above 1GHz Test Setup:

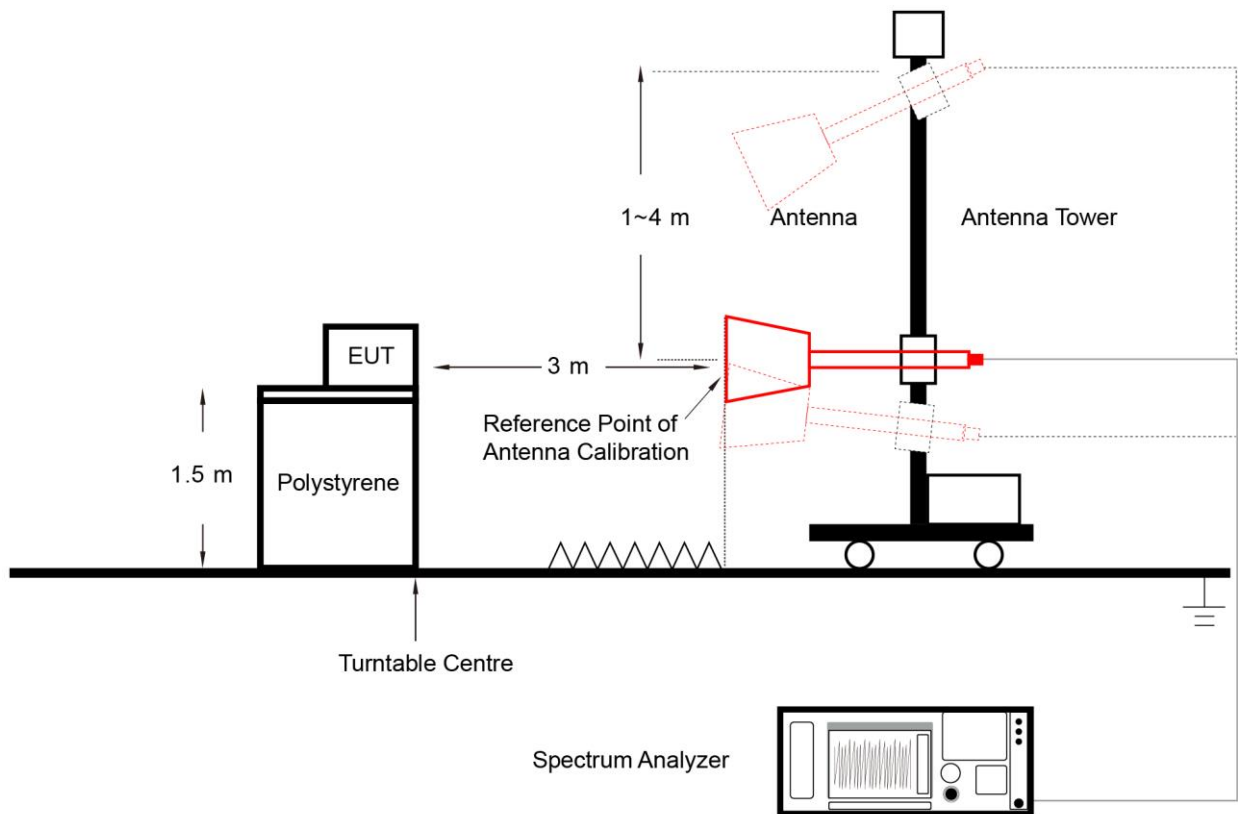

### 6.8.5. Test Result

Refer to Appendix A.8.

## 6.9. Radiated Restricted Band Edge Measurement

### 6.9.1. Test Limit

#### **For 15.205 requirement:**

Radiated emissions which fall in the restricted bands, as defined in Section 15.205(a) of FCC part 15, must also comply with the radiated emission limits specified in Section 15.209(a).

Frequency (MHz)	Frequency (MHz)	Frequency (MHz)	Frequency (GHz)
0.090 - 0.110	16.42 - 16.423	399.9 - 410	4.5 - 5.15
<sup>1</sup> 0.495 - 0.505	16.69475 - 16.69525	608 - 614	5.35 - 5.46
2.1735 - 2.1905	16.80425 - 16.80475	960 - 1240	7.25 - 7.75
4.125 - 4.128	25.5 - 25.67	1300 - 1427	8.025 - 8.5
4.17725 - 4.17775	37.5 - 38.25	1435 - 1626.5	9.0 - 9.2
4.20725 - 4.20775	73 - 74.6	1645.5 - 1646.5	9.3 - 9.5
6.215 - 6.218	74.8 - 75.2	1660 - 1710	10.6 - 12.7
6.26775 - 6.26825	108 - 121.94	1718.8 - 1722.2	13.25 - 13.4
6.31175 - 6.31225	123 - 138	2200 - 2300	14.47 - 14.5
8.291 - 8.294	149.9 - 150.05	2310 - 2390	15.35 - 16.2
8.362 - 8.366	156.52475 - 156.52525	2483.5 - 2500	17.7 - 21.4
8.37625 - 8.38675	156.7 - 156.9	2690 - 2900	22.01 - 23.12
8.41425 - 8.41475	162.0125 - 167.17	3260 - 3267	23.6 - 24.0
12.29 - 12.293	167.72 - 173.2	3332 - 3339	31.2 - 31.8
12.51975 - 12.52025	240 - 285	3345.8 - 3358	36.43 - 36.5
12.57675 - 12.57725	322 - 335.4	3600 - 4400	( <sup>2</sup> )
13.36 - 13.41	--	--	--

**For 15.407(b)(5) requirement:**

For transmitters operating within the 5.925-7.125 GHz band: Any emissions outside of the 5.925-7.125 GHz band must not exceed an e.i.r.p. of  $-27$  dBm/MHz.

Refer to 987594 D02 U-NII 6GHz EMC Measurement v01 clause G - Unwanted Emission Measurement

Use guidance in KDB 789033 for measurements below 1000 MHz and above 1000 MHz. Unwanted emissions outside of restricted bands are measured with a RMS detector. In addition, 15.35(b) applies where the peak emissions must be limited to no more than 20 dB above the average limit.

All out of band emissions appearing in a restricted band as specified in Section 15.205 of the Title 47CFR must not exceed the limits shown in Table per Section 15.209.

FCC Part 15 Subpart C Paragraph 15.209		
Frequency [MHz]	Field Strength [uV/m]	Measured Distance [Meters]
0.009 - 0.490	2400/F (kHz)	300
0.490 - 1.705	24000/F (kHz)	30
1.705 - 30	30	30
30 - 88	100	3
88 - 216	150	3
216 - 960	200	3
Above 960	500	3

**6.9.2. Test Procedure**

KDB 789033 D02v02r01-Section II)G)

### 6.9.3. Test Setting

#### **Peak Measurements above 1GHz**

1. Analyzer center frequency was set to the frequency of the radiated spurious emission of interest
2. RBW = 1MHz
3. VBW = 3MHz
4. Detector = Peak
5. Sweep time = Auto couple
6. Trace mode = Max hold
7. Trace was allowed to stabilize

#### **Average Measurements above 1GHz (Method VB)**

1. Analyzer center frequency was set to the frequency of the radiated spurious emission of interest
2. RBW = 1MHz
3. VBW; if the EUT is configured to transmit with duty cycle  $\geq 98\%$ , set VBW = 10Hz
4. If the EUT duty cycle is  $< 98\%$ , set VBW  $\geq 1/T$ . T is the minimum transmission duration
5. Detector = Peak
6. Sweep time = Auto
7. Trace mode = Max hold
8. Trace was allowed to stabilize

### 6.9.4. Test Setup

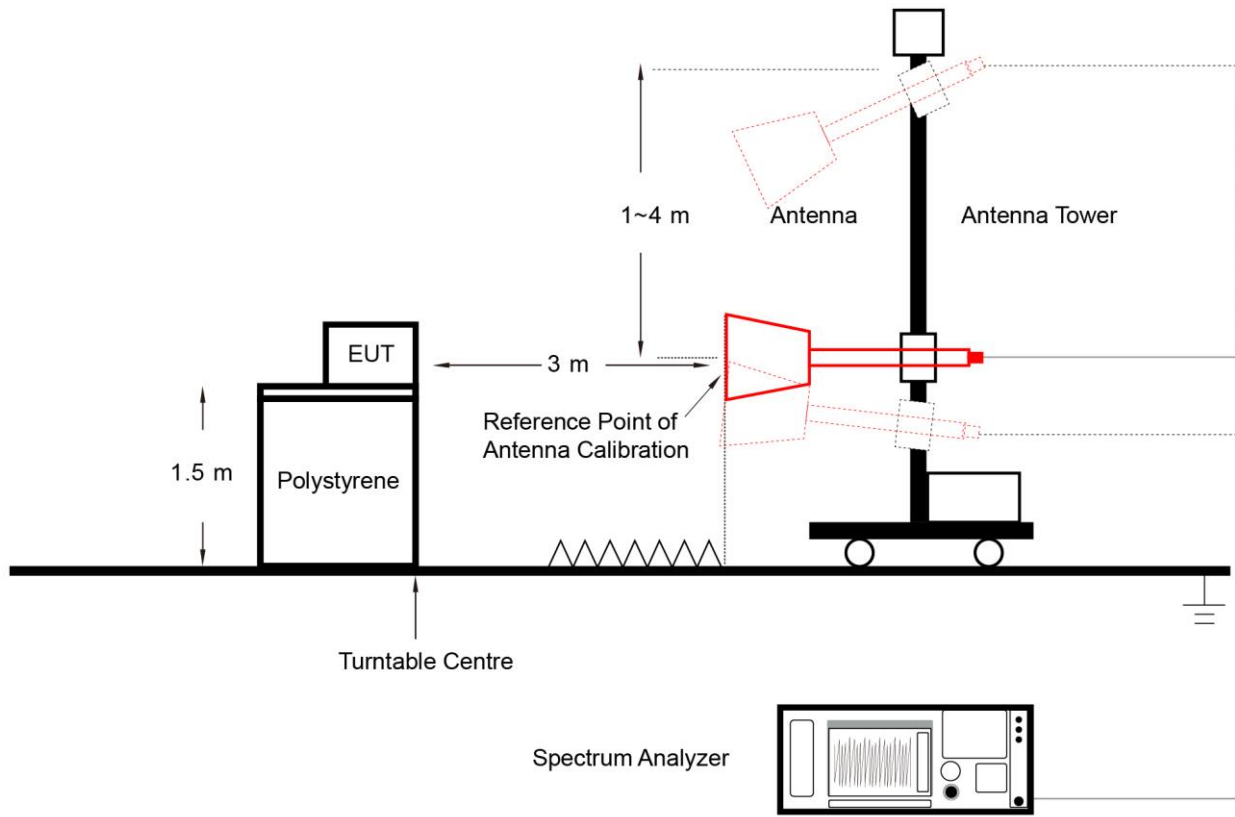

### 6.9.5. Test Result

Refer to Appendix A.9.

## 6.10. AC Conducted Emissions Measurement

### 6.10.1. Test Limit

FCC Part 15.207 Limits		
Frequency (MHz)	QP (dBuV)	AV (dBuV)
0.15 - 0.50	66 - 56	56 - 46
0.50 - 5.0	56	46
5.0 - 30	60	50

Note 1: The lower limit shall apply at the transition frequencies.

Note 2: The limit decreases linearly with the logarithm of the frequency in the range 0.15MHz to 0.5MHz.

### 6.10.2. Test Setup

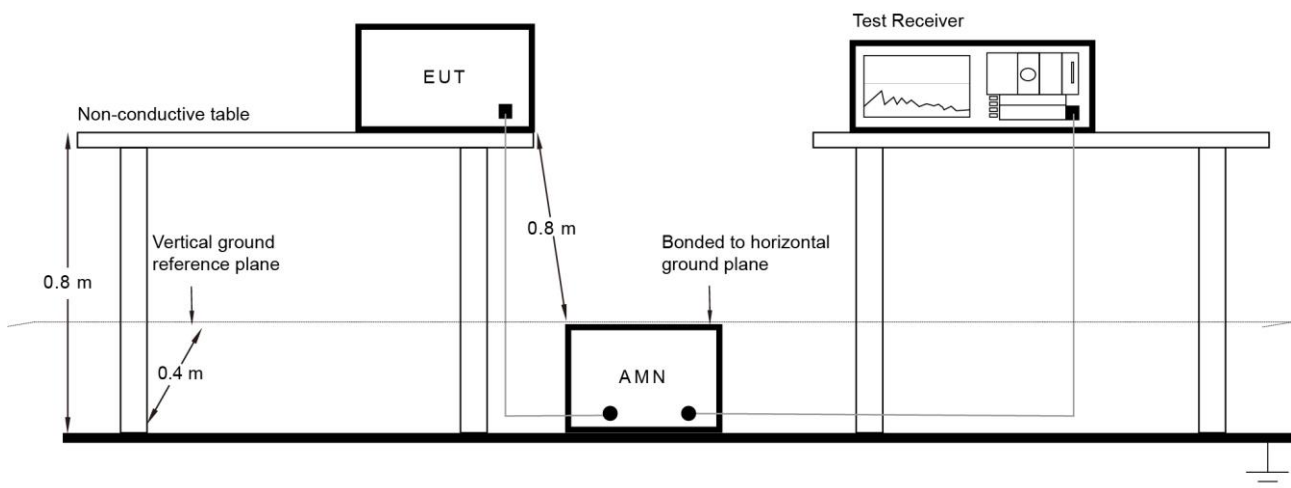

### 6.10.3. Test Result

Refer to Appendix A.10.

## Appendix A – Test Result

### A.1 Duty Cycle Test Result

Test Site	SIP-TR1	Test Engineer	Nandy Zhang
Test Date	2023-01-11		

Test Mode	Duty Cycle
802.11a	96.24%
802.11ax-HE20	99.27%
802.11ax-HE40	99.27%
802.11ax-HE80	99.27%
802.11ax-HE160	99.09%

#### Duty Cycle (T = Transmission Duration)

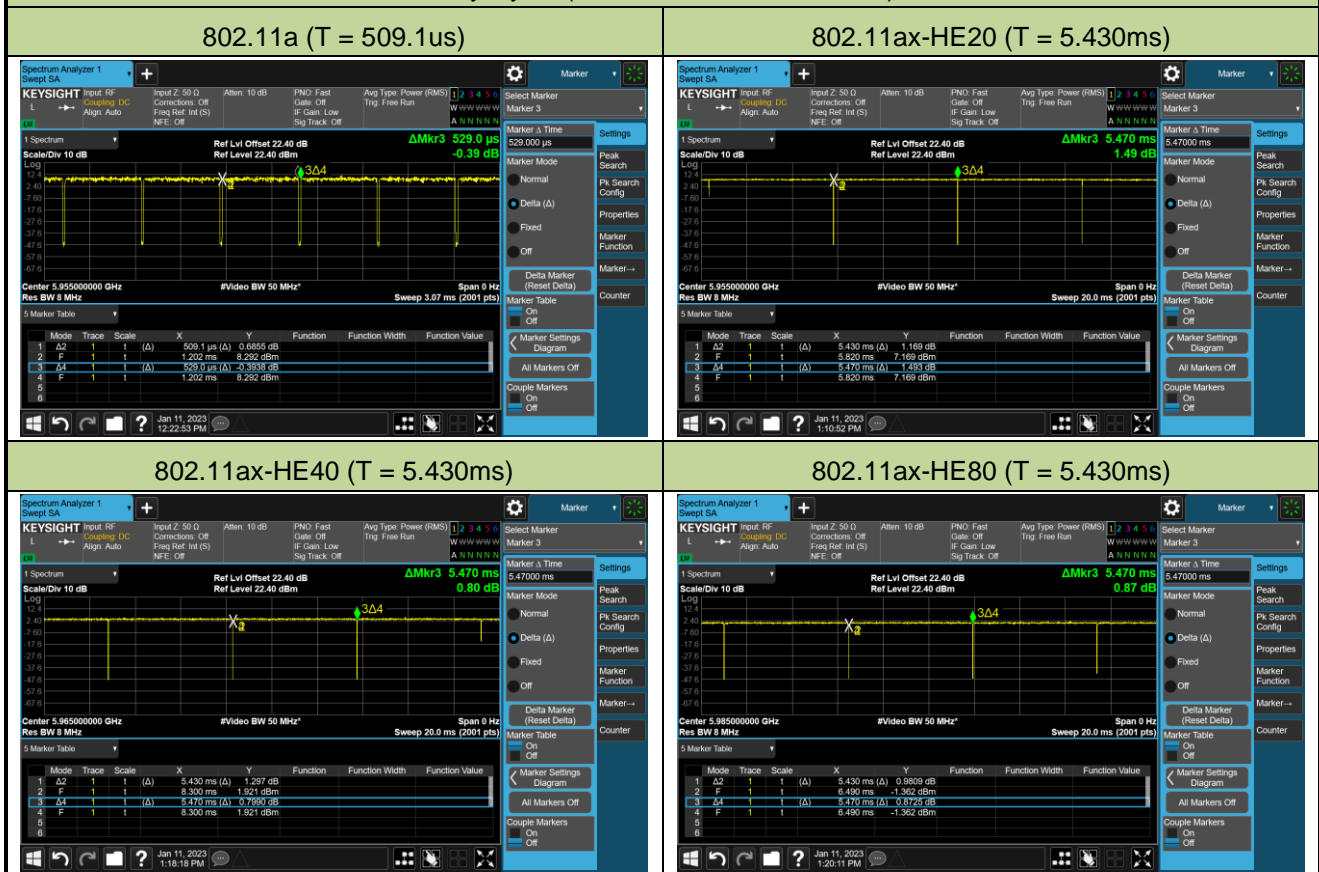

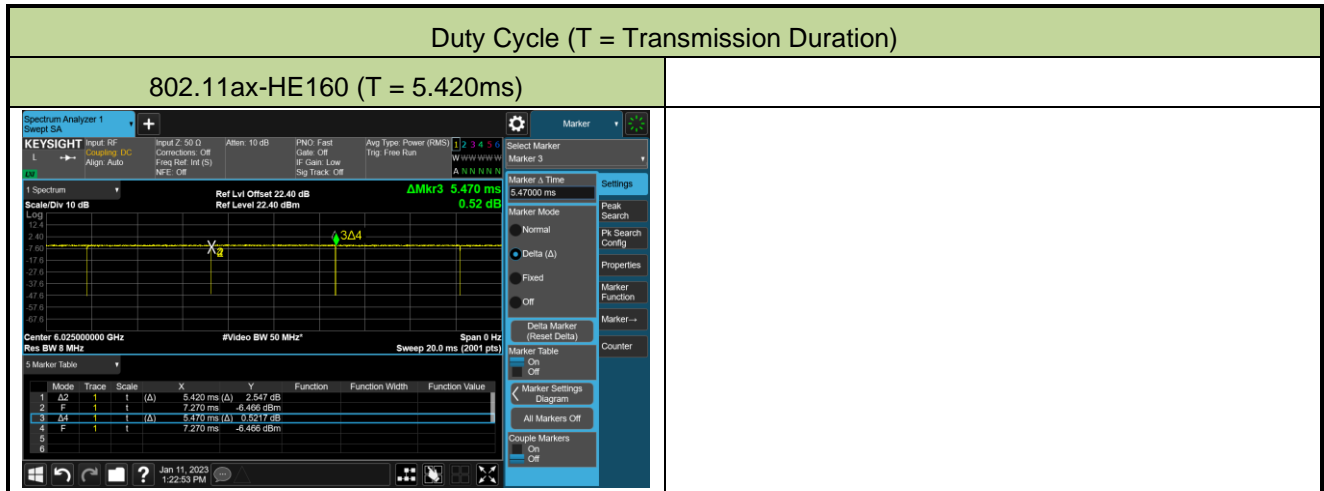



**A.2 26dB Bandwidth Test Result**

Test Site	SIP-TR1	Test Engineer	Nandy Zhang
Test Date	2023-03-20~2023-03-30		

Test Mode	Data Rate/ MCS	Channel No.	Frequency (MHz)	26dB Bandwidth (MHz)	99% Bandwidth (MHz)
802.11a	24Mbps	1	5955	18.35	16.331
802.11a	24Mbps	49	6195	18.26	16.345
802.11a	24Mbps	93	6415	18.35	16.328
802.11a	24Mbps	97	6435	18.40	16.331
802.11a	24Mbps	105	6475	18.35	16.340
802.11a	24Mbps	113	6515	18.41	16.330
802.11a	24Mbps	117	6535	18.43	16.342
802.11a	24Mbps	153	6715	18.27	16.321
802.11a	24Mbps	181	6855	18.33	16.308
802.11a	24Mbps	185	6875	18.17	16.334
802.11a	24Mbps	189	6895	18.35	16.314
802.11a	24Mbps	213	7015	18.28	16.337
802.11a	24Mbps	229	7095	18.32	16.321
802.11ax-HE20	MCS2	1	5955	20.67	18.831
802.11ax-HE20	MCS2	49	6195	20.59	18.831
802.11ax-HE20	MCS2	93	6415	20.66	18.847
802.11ax-HE20	MCS2	97	6435	20.68	18.837
802.11ax-HE20	MCS2	105	6475	20.54	18.840
802.11ax-HE20	MCS2	113	6515	20.70	18.870
802.11ax-HE20	MCS2	117	6535	20.49	18.855
802.11ax-HE20	MCS2	153	6715	20.73	18.819
802.11ax-HE20	MCS2	181	6855	20.48	18.857
802.11ax-HE20	MCS2	185	6875	20.51	18.874
802.11ax-HE20	MCS2	189	6895	20.57	18.843
802.11ax-HE20	MCS2	213	7015	20.64	18.856
802.11ax-HE20	MCS2	229	7095	20.48	18.830

Test Mode	Data Rate/ MCS	Channel No.	Frequency (MHz)	26dB Bandwidth (MHz)	99% Bandwidth (MHz)
802.11ax-HE40	MCS6	3	5965	43.45	37.999
802.11ax-HE40	MCS6	51	6205	43.67	38.018
802.11ax-HE40	MCS6	91	6405	43.59	37.959
802.11ax-HE40	MCS6	99	6445	43.12	37.971
802.11ax-HE40	MCS6	107	6485	43.39	37.960
802.11ax-HE40	MCS6	115	6525	43.13	37.997
802.11ax-HE40	MCS6	123	6565	43.27	38.040
802.11ax-HE40	MCS6	147	6685	43.84	38.032
802.11ax-HE40	MCS6	179	6845	43.21	38.007
802.11ax-HE40	MCS6	187	6885	43.62	38.042
802.11ax-HE40	MCS6	195	6925	44.37	38.000
802.11ax-HE40	MCS6	211	7005	43.48	37.963
802.11ax-HE40	MCS6	227	7085	43.75	38.003
802.11ax-HE80	MCS6	7	5985	136.8	78.359
802.11ax-HE80	MCS6	55	6225	147.9	79.029
802.11ax-HE80	MCS6	87	6385	156.1	79.648
802.11ax-HE80	MCS6	103	6465	144.0	78.763
802.11ax-HE80	MCS6	119	6545	147.6	78.208
802.11ax-HE80	MCS6	135	6625	134.8	78.245
802.11ax-HE80	MCS6	151	6705	87.72	77.791
802.11ax-HE80	MCS6	183	6865	87.86	77.772
802.11ax-HE80	MCS6	199	6945	97.76	77.840
802.11ax-HE80	MCS6	215	7025	109.8	77.967
802.11ax-HE160	MCS0	15	6025	162.6	154.41
802.11ax-HE160	MCS0	47	6185	162.3	154.53
802.11ax-HE160	MCS0	79	6345	161.9	154.70
802.11ax-HE160	MCS0	111	6505	163.2	154.80
802.11ax-HE160	MCS0	143	6665	163.9	154.40
802.11ax-HE160	MCS0	175	6825	162.6	154.51
802.11ax-HE160	MCS0	207	6985	164.2	154.76

## 802.11a 26dB Bandwidth

### Channel 1 (5955MHz)      Channel 49 (6195MHz)

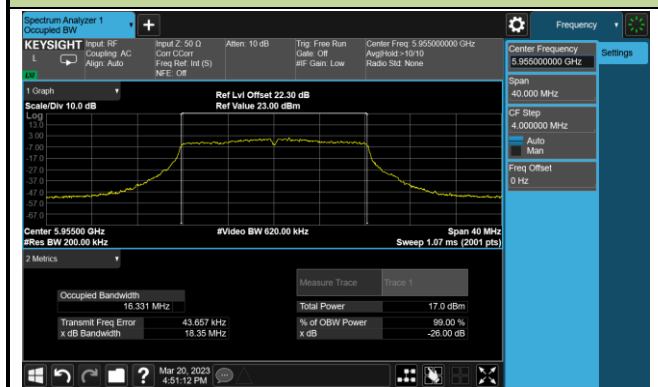

### Channel 93 (6415MHz)

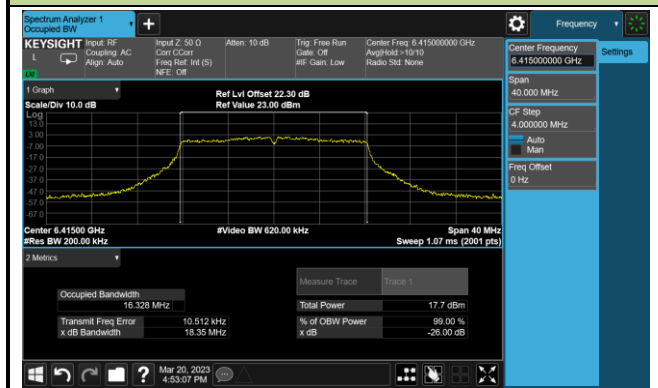

### Channel 97 (6435MHz)

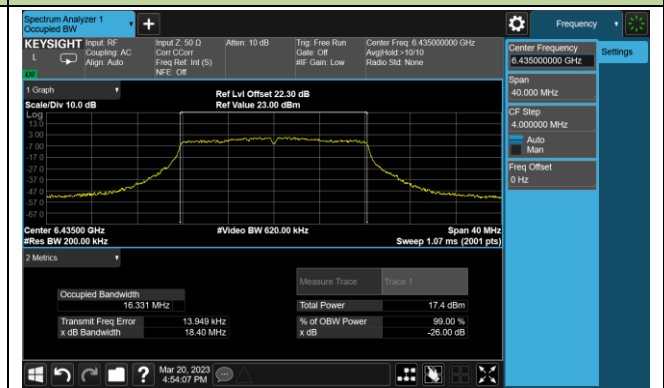

### Channel 105 (6475MHz)

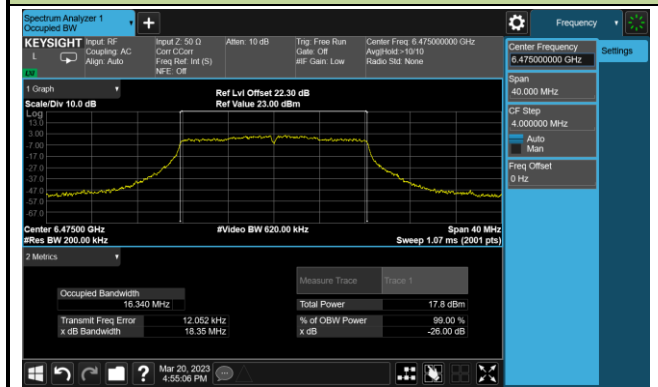

### Channel 113 (6515MHz)

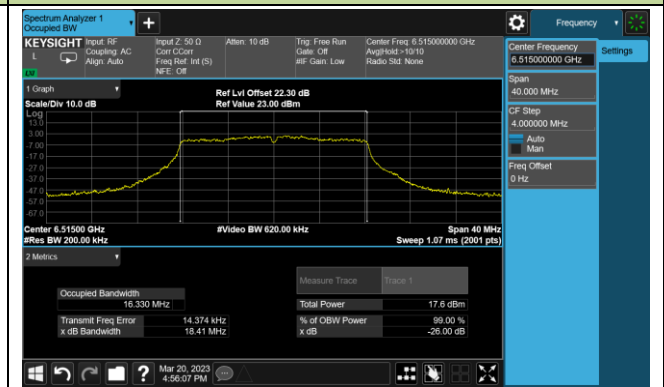

### Channel 117 (6535MHz)

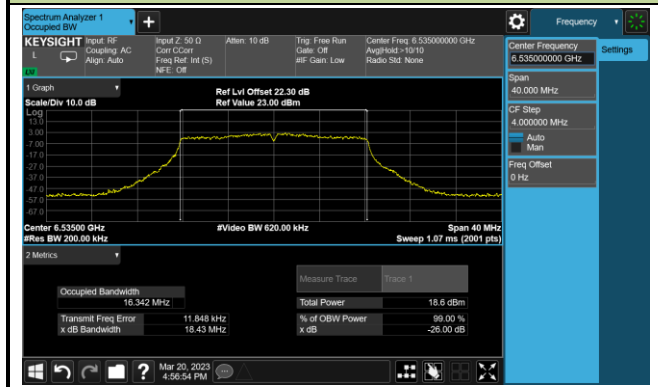

### Channel 153 (6715MHz)



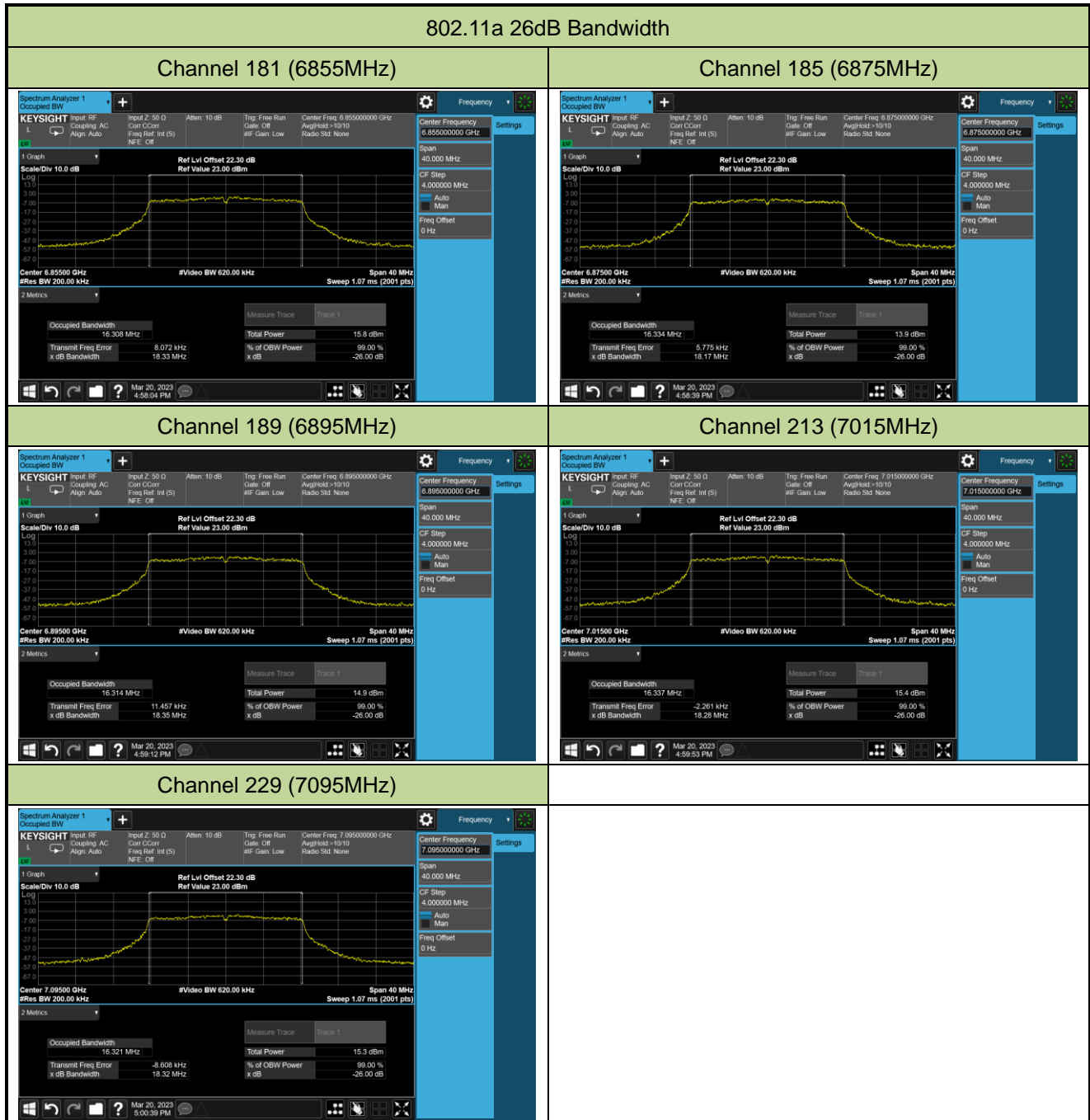

## 802.11ax-HE20 26dB Bandwidth

## Channel 1 (5955MHz)

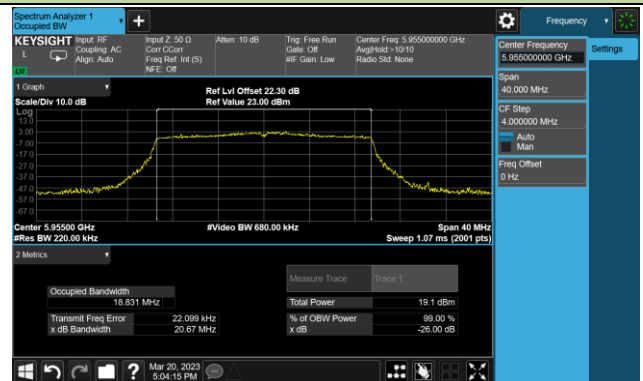

## Channel 49 (6195MHz)

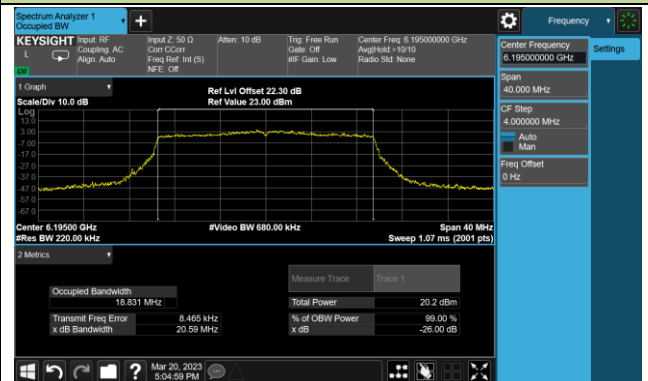

## Channel 93 (6415MHz)

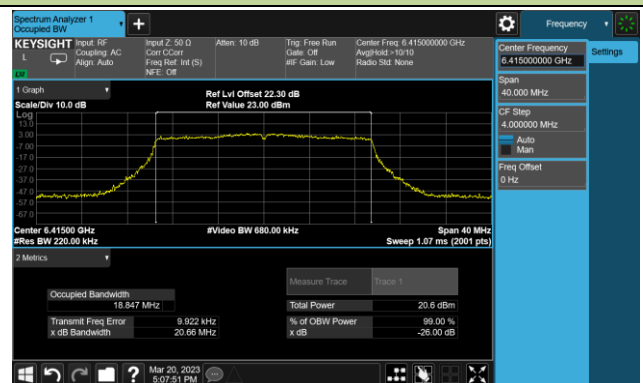

## Channel 97 (6435MHz)



## Channel 105 (6475MHz)

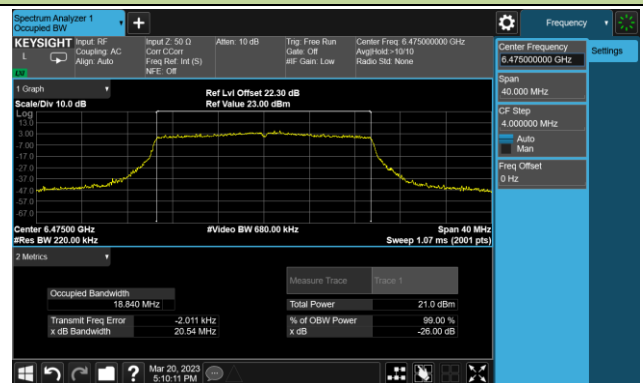

## Channel 113 (6515MHz)

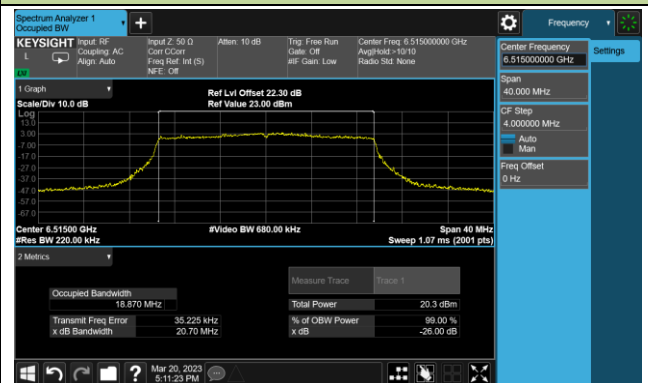

## Channel 117 (6535MHz)

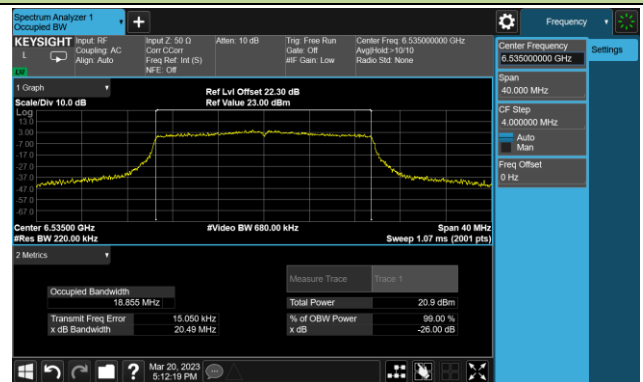

## Channel 153 (6715MHz)

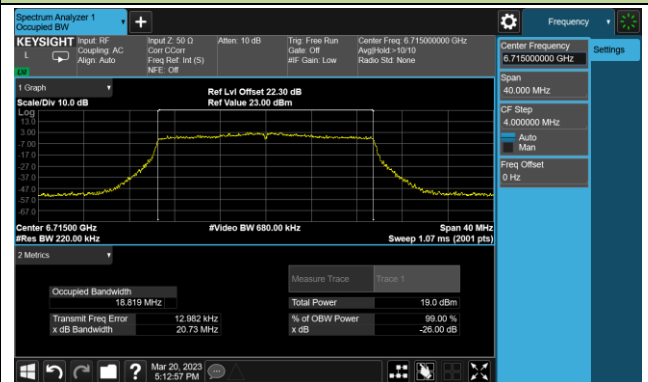

802.11ax-HE20 26dB Bandwidth

Channel 181 (6855MHz)

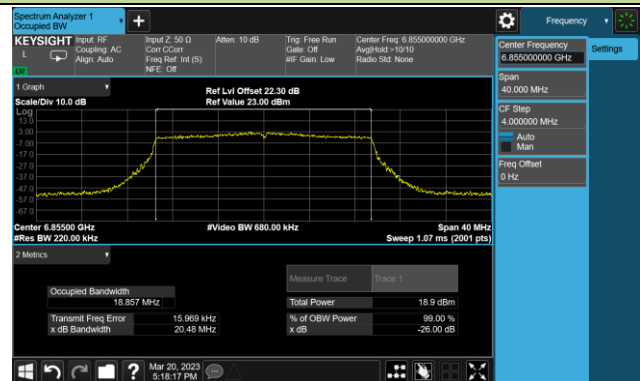

Channel 185 (6875MHz)



Channel 189 (6895MHz)

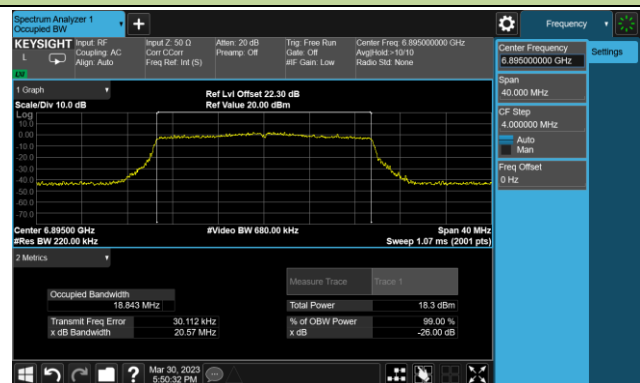

Channel 213 (7015MHz)



Channel 229 (7095MHz)



## 802.11ax-HE40 26dB Bandwidth

## Channel 3 (5965MHz)

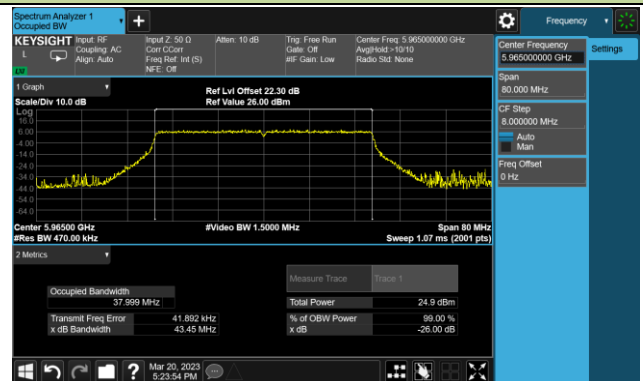

## Channel 51 (6205MHz)

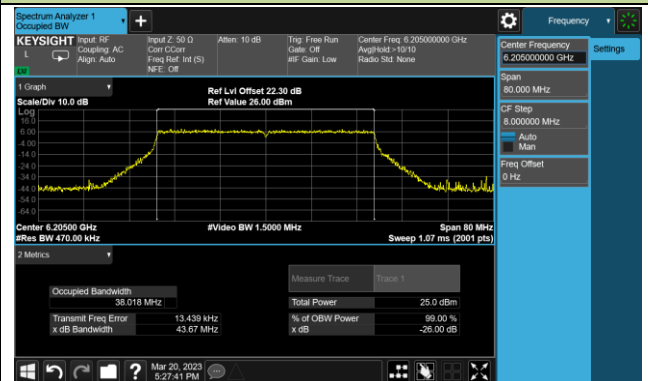

## Channel 91 (6405MHz)

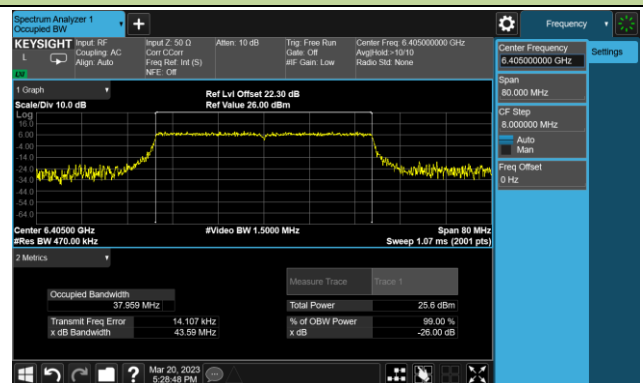

## Channel 99 (6445MHz)

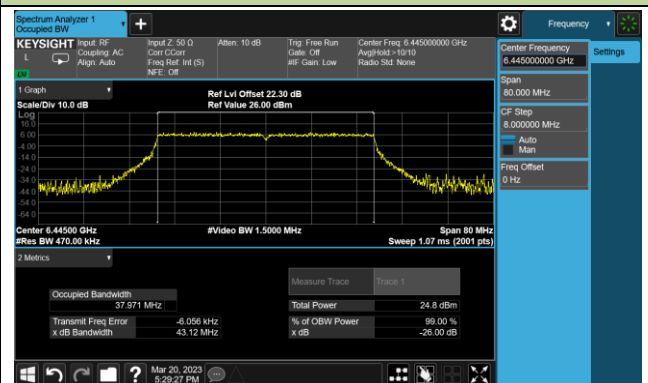

## Channel 107 (6485MHz)

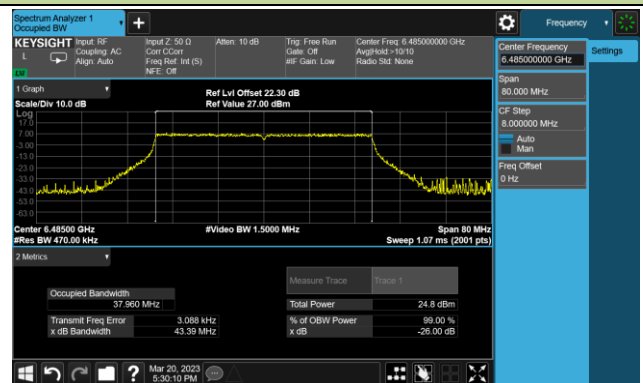

## Channel 115 (6525MHz)

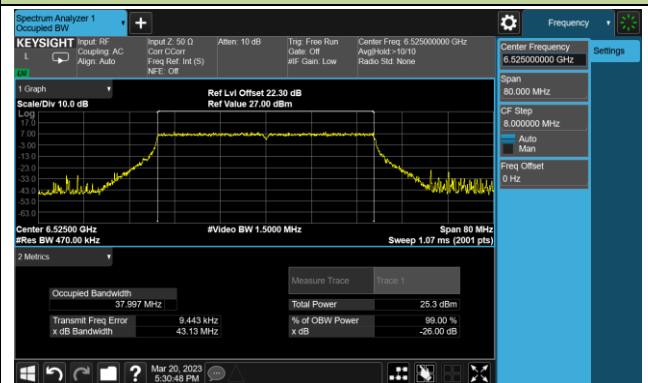

## Channel 123 (6565MHz)

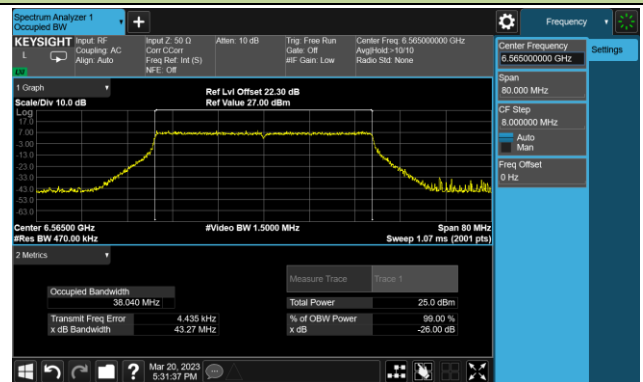

## Channel 147 (6685MHz)

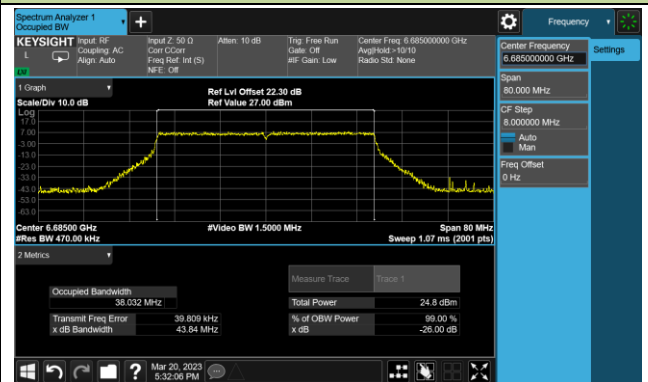

802.11ax-HE40 26dB Bandwidth

Channel 179 (6845MHz)

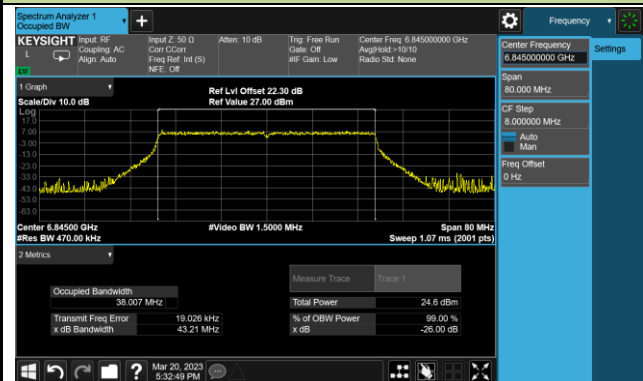

Channel 187 (6885MHz)

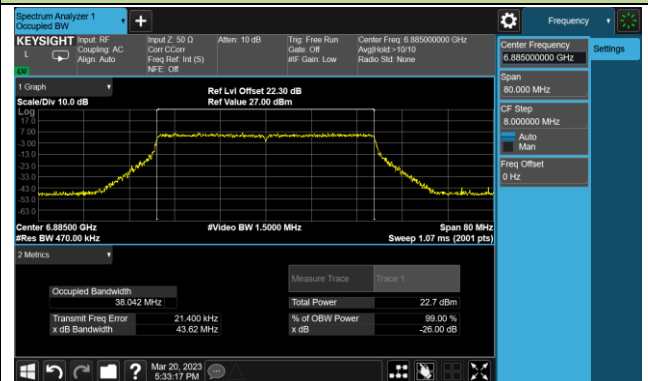

Channel 195 (6925MHz)

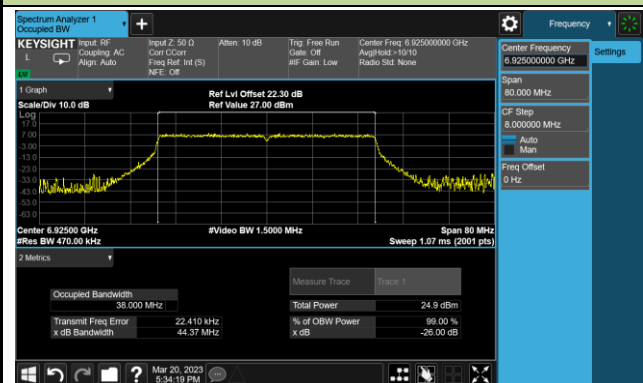

Channel 211 (7005MHz)

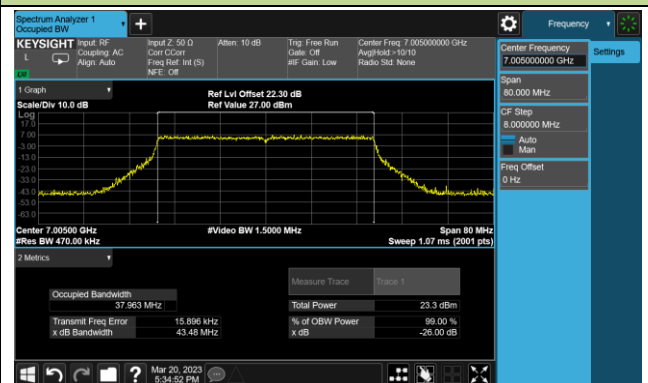

Channel 227 (7085MHz)

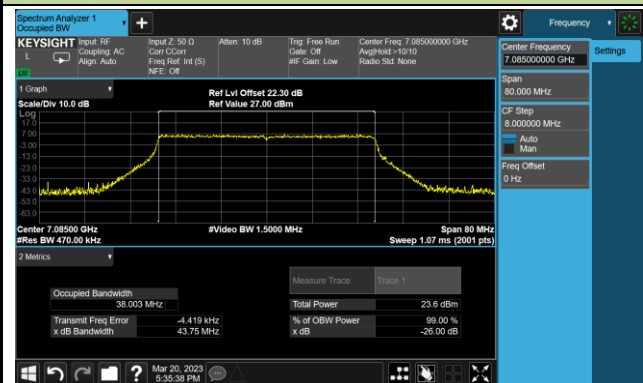



## 802.11ax-HE80 26dB Bandwidth

Channel 7 (5985MHz)

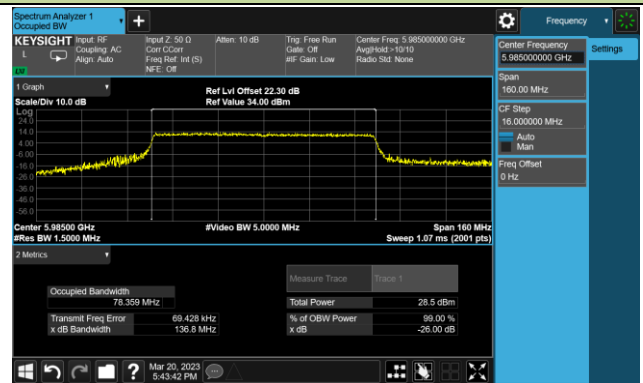

Channel 55 (6225MHz)

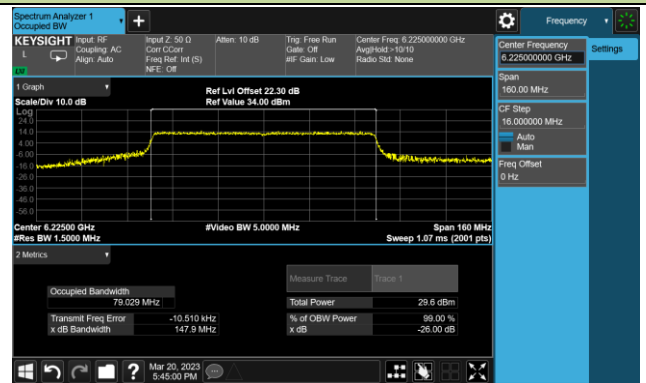

Channel 87 (6385MHz)

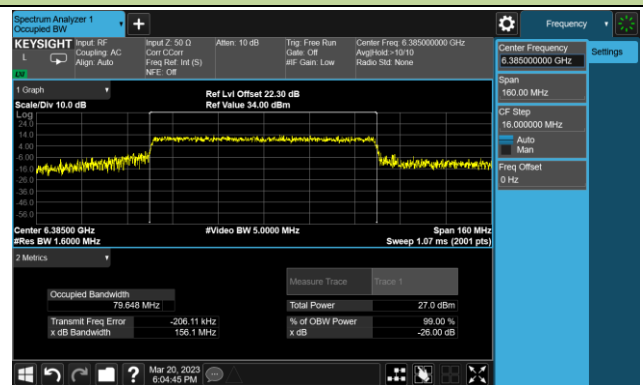

Channel 103 (6465MHz)

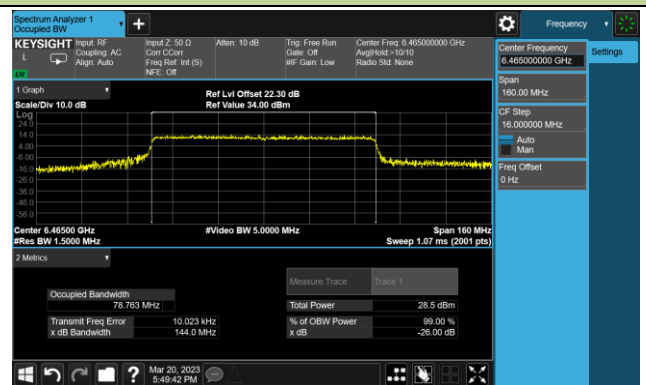

Channel 119 (6545MHz)

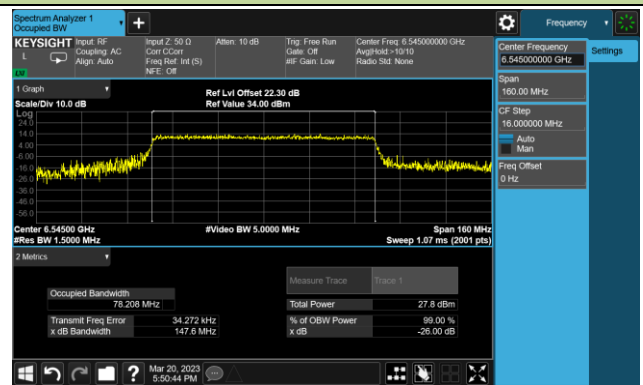

Channel 135 (6625MHz)

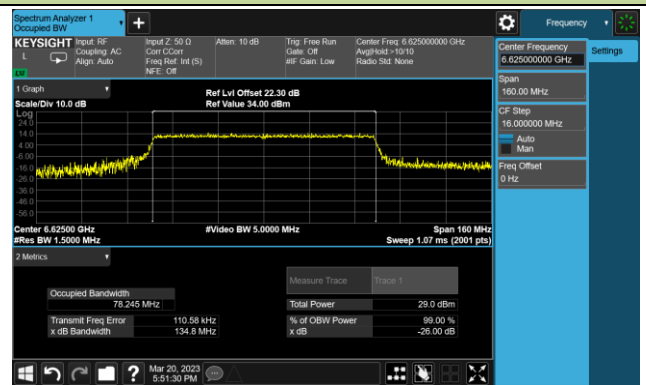

Channel 151 (6705MHz)

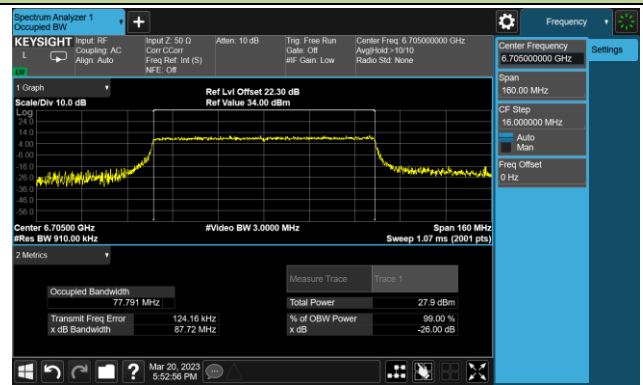

Channel 183 (6865MHz)

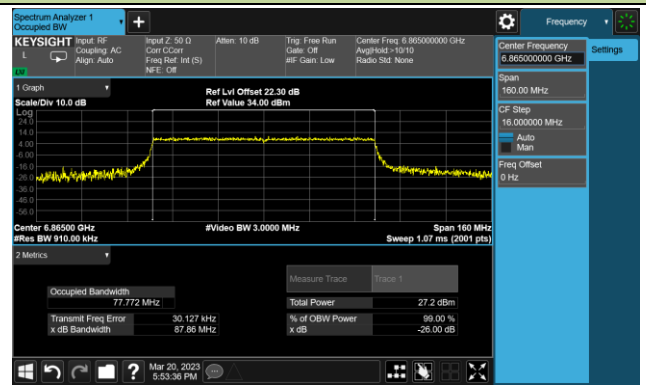

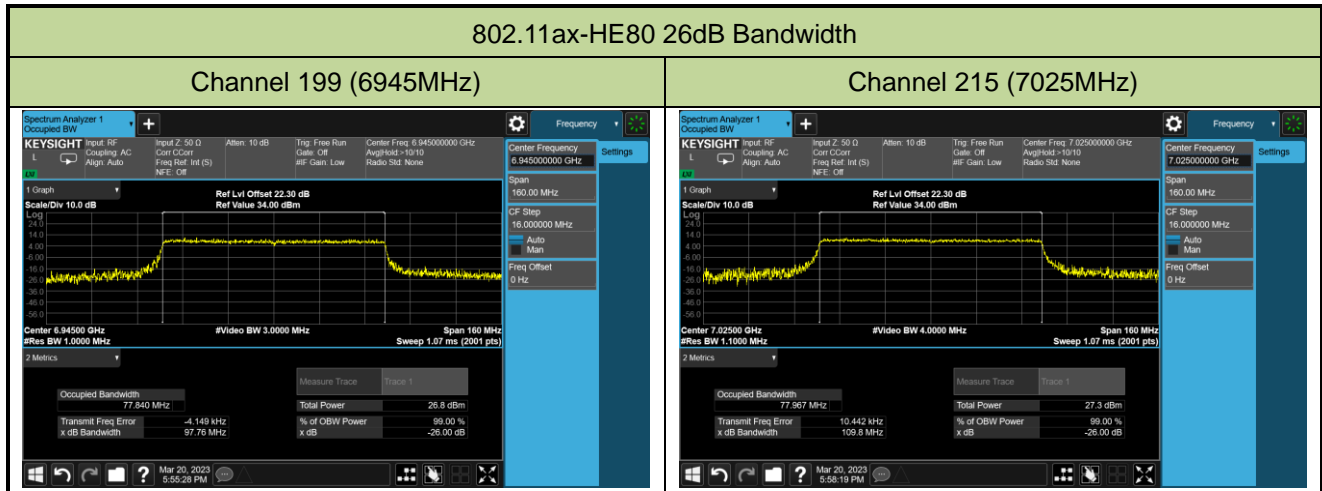

802.11ax-HE160 26dB Bandwidth

Channel 15 (6025MHz)

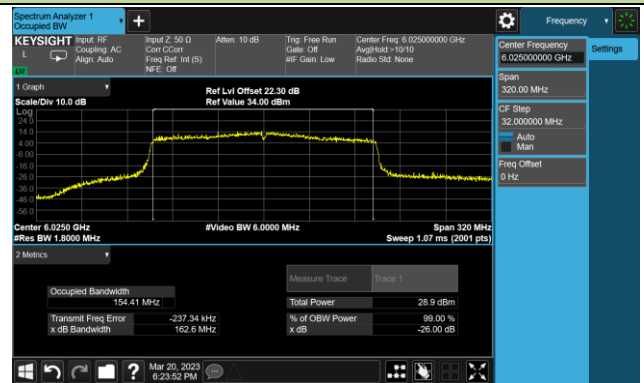

Channel 47 (6185MHz)

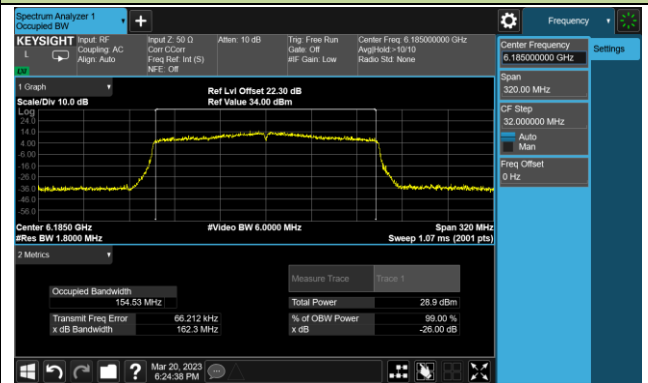

Channel 79 (6345MHz)

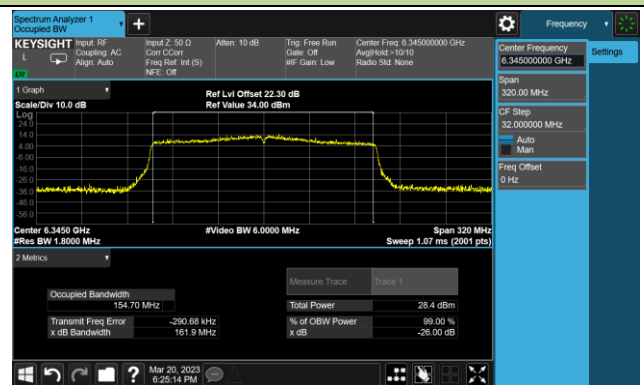

Channel 111 (6505MHz)

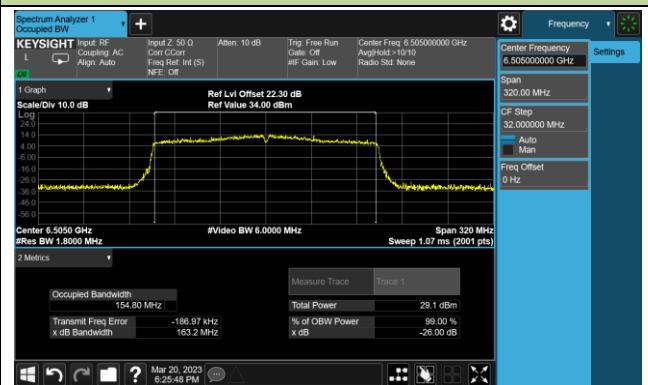

Channel 143 (6665MHz)

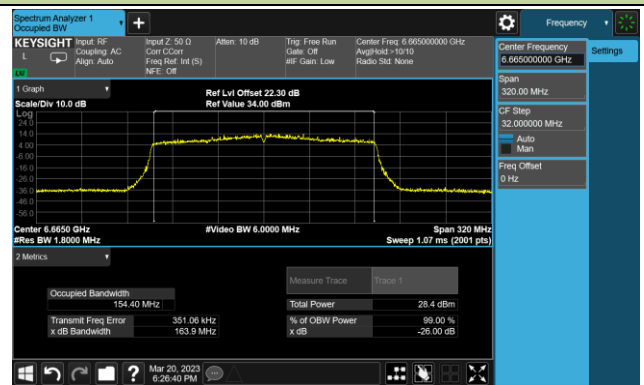

Channel 175 (6825MHz)

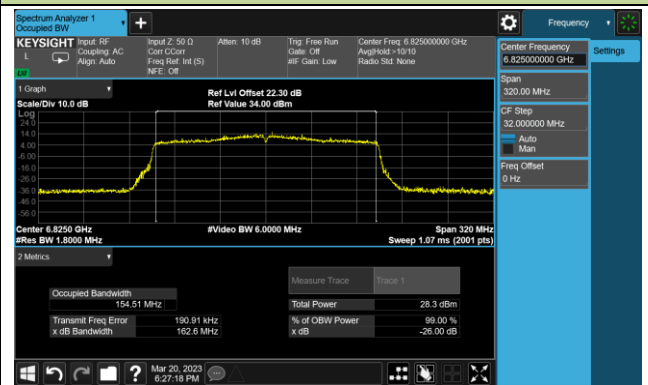

Channel 207 (6985MHz)



### A.3 Output Power Test Result

Test Site	SIP-AC2	Test Engineer	Arvin Ding
Test Date	2023-03-17		

Test Mode	Data Rate/ MCS	Channel No.	Freq. (MHz)	EIRP (dBuV/m)	EIRP (dBm)	Total EIRP (dBm)	EIRP Limit (dBm)
802.11a	24Mbps	1	5955	106.8	11.60	11.77	≤ 30.00
802.11a	24Mbps	49	6195	107.2	12.00	12.17	≤ 30.00
802.11a	24Mbps	93	6415	107.2	12.00	12.17	≤ 30.00
802.11a	24Mbps	97	6435	106.9	11.70	11.87	≤ 30.00
802.11a	24Mbps	105	6475	107.6	12.40	12.57	≤ 30.00
802.11a	24Mbps	113	6515	107.3	12.10	12.27	≤ 30.00
802.11a	24Mbps	117	6535	107.7	12.50	12.67	≤ 30.00
802.11a	24Mbps	153	6715	107.5	12.30	12.47	≤ 30.00
802.11a	24Mbps	181	6855	107.8	12.60	12.77	≤ 30.00
802.11a	24Mbps	185	6875	107.3	12.10	12.27	≤ 30.00
802.11a	24Mbps	189	6895	107.1	11.90	12.07	≤ 30.00
802.11a	24Mbps	213	7015	107.6	12.40	12.57	≤ 30.00
802.11a	24Mbps	229	7095	107.5	12.30	12.47	≤ 30.00
802.11ax-HE20	MCS2	1	5955	110.3	15.10	15.13	≤ 30.00
802.11ax-HE20	MCS2	49	6195	110.5	15.30	15.33	≤ 30.00
802.11ax-HE20	MCS2	93	6415	110.5	15.30	15.33	≤ 30.00
802.11ax-HE20	MCS2	97	6435	110.5	15.30	15.33	≤ 30.00
802.11ax-HE20	MCS2	105	6475	110.3	15.10	15.13	≤ 30.00
802.11ax-HE20	MCS2	113	6515	110.6	15.40	15.43	≤ 30.00
802.11ax-HE20	MCS2	117	6535	110.5	15.30	15.33	≤ 30.00
802.11ax-HE20	MCS2	153	6715	110.2	15.00	15.03	≤ 30.00
802.11ax-HE20	MCS2	181	6855	110.7	15.50	15.53	≤ 30.00
802.11ax-HE20	MCS2	185	6875	110.6	15.40	15.43	≤ 30.00
802.11ax-HE20	MCS2	189	6895	110.5	15.30	15.33	≤ 30.00
802.11ax-HE20	MCS2	213	7015	110.8	15.60	15.63	≤ 30.00
802.11ax-HE20	MCS2	229	7095	110.0	14.80	14.83	≤ 30.00

Test Mode	Data Rate/ MCS	Channel No.	Freq. (MHz)	EIRP (dBuV/m)	EIRP (dBm)	Total EIRP (dBm)	EIRP Limit (dBm)
802.11ax-HE40	MCS6	3	5965	114.9	19.70	19.73	≤ 30.00
802.11ax-HE40	MCS6	51	6205	114.9	19.70	19.73	≤ 30.00
802.11ax-HE40	MCS6	91	6405	114.8	19.60	19.63	≤ 30.00
802.11ax-HE40	MCS6	99	6445	114.6	19.40	19.43	≤ 30.00
802.11ax-HE40	MCS6	107	6485	114.3	19.10	19.13	≤ 30.00
802.11ax-HE40	MCS6	115	6525	114.9	19.70	19.73	≤ 30.00
802.11ax-HE40	MCS6	123	6565	114.9	19.70	19.73	≤ 30.00
802.11ax-HE40	MCS6	147	6685	115.0	19.80	19.83	≤ 30.00
802.11ax-HE40	MCS6	179	6845	115.0	19.80	19.83	≤ 30.00
802.11ax-HE40	MCS6	187	6885	114.9	19.70	19.73	≤ 30.00
802.11ax-HE40	MCS6	195	6925	115.1	19.90	19.93	≤ 30.00
802.11ax-HE40	MCS6	211	7005	114.4	19.20	19.23	≤ 30.00
802.11ax-HE40	MCS6	227	7085	114.5	19.30	19.33	≤ 30.00
802.11ax-HE80	MCS6	7	5985	117.7	22.50	22.53	≤ 30.00
802.11ax-HE80	MCS6	55	6225	118.2	23.00	23.03	≤ 30.00
802.11ax-HE80	MCS6	87	6385	117.9	22.70	22.73	≤ 30.00
802.11ax-HE80	MCS6	103	6465	118.0	22.80	22.83	≤ 30.00
802.11ax-HE80	MCS6	119	6545	117.6	22.40	22.43	≤ 30.00
802.11ax-HE80	MCS6	135	6625	118.1	22.90	22.93	≤ 30.00
802.11ax-HE80	MCS6	151	6705	117.9	22.70	22.73	≤ 30.00
802.11ax-HE80	MCS6	183	6865	118.2	23.00	23.03	≤ 30.00
802.11ax-HE80	MCS6	199	6945	117.6	22.40	22.43	≤ 30.00
802.11ax-HE80	MCS6	215	7025	117.5	22.30	22.33	≤ 30.00
802.11ax-HE160	MCS0	15	6025	118.6	23.40	23.44	≤ 30.00
802.11ax-HE160	MCS0	47	6185	118.6	23.40	23.44	≤ 30.00
802.11ax-HE160	MCS0	79	6345	118.0	22.80	22.84	≤ 30.00
802.11ax-HE160	MCS0	111	6505	118.4	23.20	23.24	≤ 30.00
802.11ax-HE160	MCS0	143	6665	118.0	22.80	22.84	≤ 30.00
802.11ax-HE160	MCS0	175	6825	118.5	23.30	23.34	≤ 30.00
802.11ax-HE160	MCS0	207	6985	117.9	22.70	22.74	≤ 30.00

Note 1: EIRP (dBm) = EIRP (dBuV/m) – 95.2.

Note 2: Total EIRP (dBm) = EIRP (dBm) + 10\*log(1/duty cycle).

#### A.4 Power Spectral Density Test Result

Test Site	SIP-AC2	Test Engineer	Arvin Ding
Test Date	2023-03-17		

Test Mode	Data Rate/ MCS	Channel No.	Freq. (MHz)	EIRP PSD (dBuV/m)	EIRP PSD (dBm/MHz)	Duty Cycle (%)	Final EIRP PSD (dBm/MHz)	EIRP PSD Limit (dBm/MHz)
802.11a	24Mbps	1	5955	99.73	4.53	96.24	4.69	≤ 5.00
802.11a	24Mbps	49	6195	99.48	4.28	96.24	4.45	≤ 5.00
802.11a	24Mbps	93	6415	99.64	4.44	96.24	4.61	≤ 5.00
802.11a	24Mbps	97	6435	99.55	4.35	96.24	4.51	≤ 5.00
802.11a	24Mbps	105	6475	99.52	4.32	96.24	4.48	≤ 5.00
802.11a	24Mbps	113	6515	99.60	4.40	96.24	4.57	≤ 5.00
802.11a	24Mbps	117	6535	99.69	4.49	96.24	4.65	≤ 5.00
802.11a	24Mbps	153	6715	99.87	4.67	96.24	4.83	≤ 5.00
802.11a	24Mbps	181	6855	99.74	4.54	96.24	4.71	≤ 5.00
802.11a	24Mbps	185	6875	99.68	4.48	96.24	4.65	≤ 5.00
802.11a	24Mbps	189	6895	99.70	4.50	96.24	4.66	≤ 5.00
802.11a	24Mbps	213	7015	99.68	4.48	96.24	4.65	≤ 5.00
802.11a	24Mbps	229	7095	99.88	4.68	96.24	4.84	≤ 5.00
802.11ax-HE20	MCS2	1	5955	99.78	4.58	99.27	4.61	≤ 5.00
802.11ax-HE20	MCS2	49	6195	99.82	4.62	99.27	4.65	≤ 5.00
802.11ax-HE20	MCS2	93	6415	99.77	4.57	99.27	4.60	≤ 5.00
802.11ax-HE20	MCS2	97	6435	99.81	4.61	99.27	4.64	≤ 5.00
802.11ax-HE20	MCS2	105	6475	99.82	4.62	99.27	4.66	≤ 5.00
802.11ax-HE20	MCS2	113	6515	100.07	4.87	99.27	4.90	≤ 5.00
802.11ax-HE20	MCS2	117	6535	99.61	4.41	99.27	4.44	≤ 5.00
802.11ax-HE20	MCS2	153	6715	99.84	4.64	99.27	4.67	≤ 5.00
802.11ax-HE20	MCS2	181	6855	100.01	4.81	99.27	4.84	≤ 5.00
802.11ax-HE20	MCS2	185	6875	99.94	4.74	99.27	4.77	≤ 5.00
802.11ax-HE20	MCS2	189	6895	99.74	4.54	99.27	4.57	≤ 5.00
802.11ax-HE20	MCS2	213	7015	100.07	4.87	99.27	4.90	≤ 5.00
802.11ax-HE20	MCS2	229	7095	99.72	4.52	99.27	4.55	≤ 5.00

Test Mode	Data Rate/ MCS	Channel No.	Freq. (MHz)	EIRP PSD (dBuV/m)	EIRP PSD (dBm/MHz)	Duty Cycle (%)	Final EIRP PSD (dBm/MHz)	EIRP PSD Limit (dBm/MHz)
802.11ax-HE40	MCS6	3	5965	99.87	4.67	99.27	4.70	≤ 5.00
802.11ax-HE40	MCS6	51	6205	99.75	4.55	99.27	4.58	≤ 5.00
802.11ax-HE40	MCS6	91	6405	99.74	4.54	99.27	4.57	≤ 5.00
802.11ax-HE40	MCS6	99	6445	100.04	4.84	99.27	4.88	≤ 5.00
802.11ax-HE40	MCS6	107	6485	99.58	4.38	99.27	4.41	≤ 5.00
802.11ax-HE40	MCS6	115	6525	99.86	4.66	99.27	4.69	≤ 5.00
802.11ax-HE40	MCS6	123	6565	99.99	4.79	99.27	4.82	≤ 5.00
802.11ax-HE40	MCS6	147	6685	100.07	4.87	99.27	4.90	≤ 5.00
802.11ax-HE40	MCS6	179	6845	100.01	4.80	99.27	4.84	≤ 5.00
802.11ax-HE40	MCS6	187	6885	99.63	4.43	99.27	4.46	≤ 5.00
802.11ax-HE40	MCS6	195	6925	100.03	4.83	99.27	4.86	≤ 5.00
802.11ax-HE40	MCS6	211	7005	99.63	4.43	99.27	4.46	≤ 5.00
802.11ax-HE40	MCS6	227	7085	99.63	4.43	99.27	4.46	≤ 5.00
802.11ax-HE80	MCS6	7	5985	99.66	4.46	99.27	4.49	≤ 5.00
802.11ax-HE80	MCS6	55	6225	100.06	4.86	99.27	4.89	≤ 5.00
802.11ax-HE80	MCS6	87	6385	99.74	4.54	99.27	4.57	≤ 5.00
802.11ax-HE80	MCS6	103	6465	99.94	4.74	99.27	4.77	≤ 5.00
802.11ax-HE80	MCS6	119	6545	99.79	4.59	99.27	4.63	≤ 5.00
802.11ax-HE80	MCS6	135	6625	99.92	4.72	99.27	4.75	≤ 5.00
802.11ax-HE80	MCS6	151	6705	99.84	4.64	99.27	4.68	≤ 5.00
802.11ax-HE80	MCS6	183	6865	99.96	4.76	99.27	4.79	≤ 5.00
802.11ax-HE80	MCS6	199	6945	99.85	4.65	99.27	4.68	≤ 5.00
802.11ax-HE80	MCS6	215	7025	99.60	4.40	99.27	4.44	≤ 5.00
802.11ax-HE160	MCS0	15	6025	99.91	4.71	99.09	4.75	≤ 5.00
802.11ax-HE160	MCS0	47	6185	99.95	4.75	99.09	4.79	≤ 5.00
802.11ax-HE160	MCS0	79	6345	99.65	4.45	99.09	4.49	≤ 5.00
802.11ax-HE160	MCS0	111	6505	99.91	4.71	99.09	4.75	≤ 5.00
802.11ax-HE160	MCS0	143	6665	99.67	4.47	99.09	4.51	≤ 5.00
802.11ax-HE160	MCS0	175	6825	100.00	4.80	99.09	4.83	≤ 5.00
802.11ax-HE160	MCS0	207	6985	99.74	4.54	99.09	4.58	≤ 5.00

Note 1: EIRP PSD (dBm/MHz) = EIRP PSD (dBuV/m/MHz) - 95.2.

Note 2: Final EIRP PSD (dBm/MHz) = EIRP PSD (dBm/MHz) + 10\*log(1/duty cycle).

## 802.11a Power Spectral Density

Channel 1 (5955MHz)

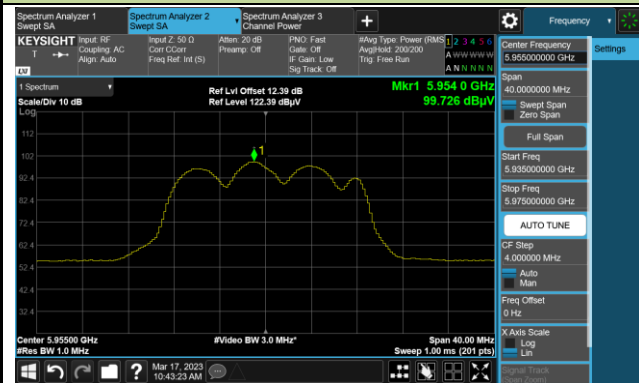

Channel 49 (6195MHz)

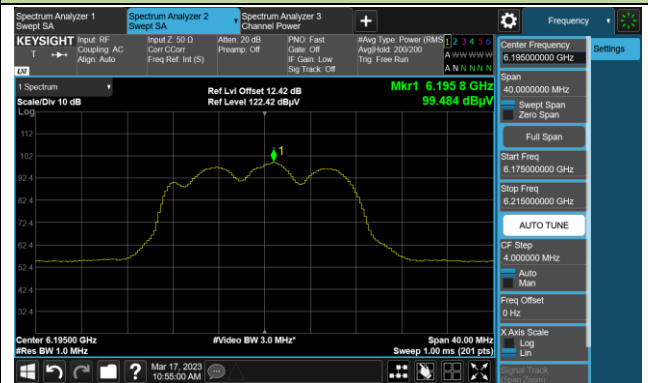

Channel 93 (6415MHz)

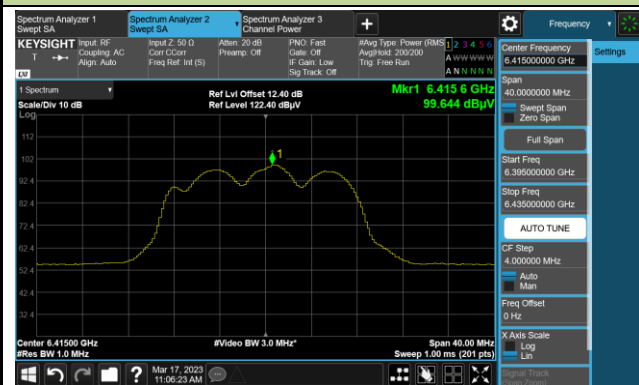

Channel 97 (6435MHz)

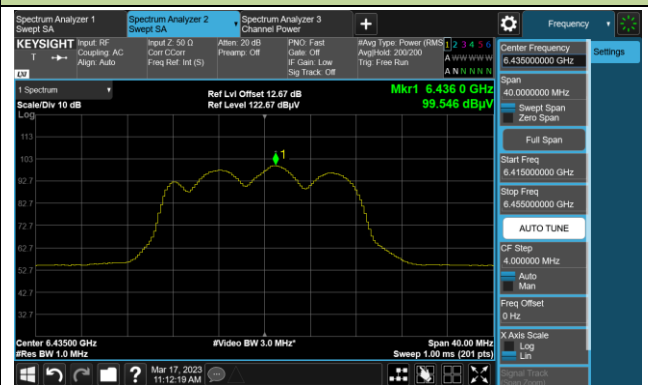

Channel 105 (6475MHz)

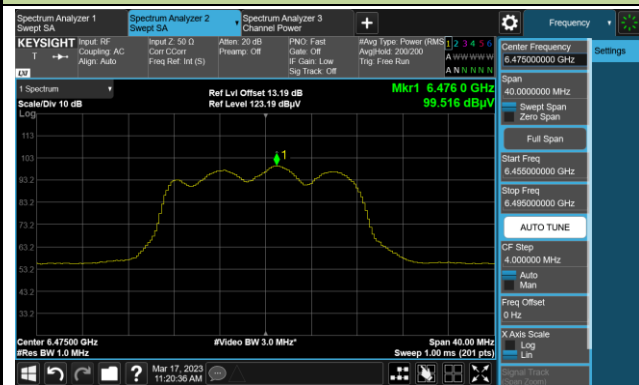

Channel 113 (6515MHz)

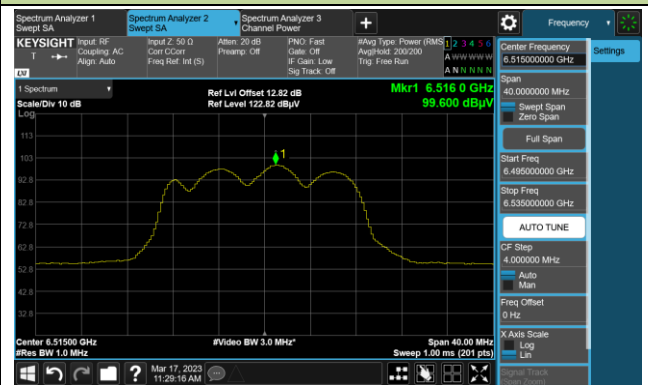

Channel 117 (6535MHz)

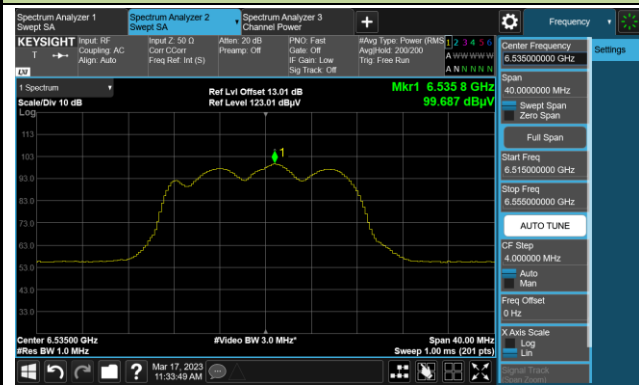

Channel 153 (6715MHz)

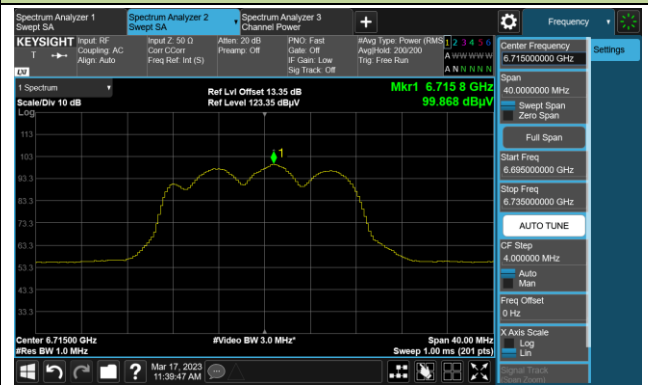



## 802.11a Power Spectral Density

## Channel 181 (6855MHz)

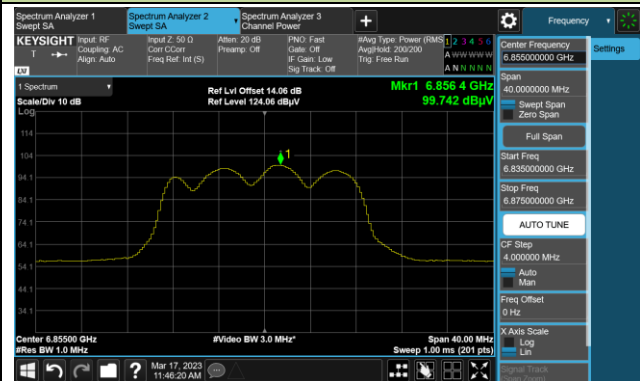

## Channel 185 (6875MHz)

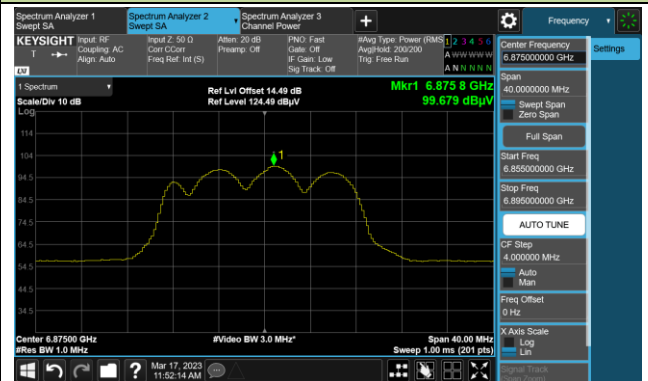

## Channel 189 (6895MHz)

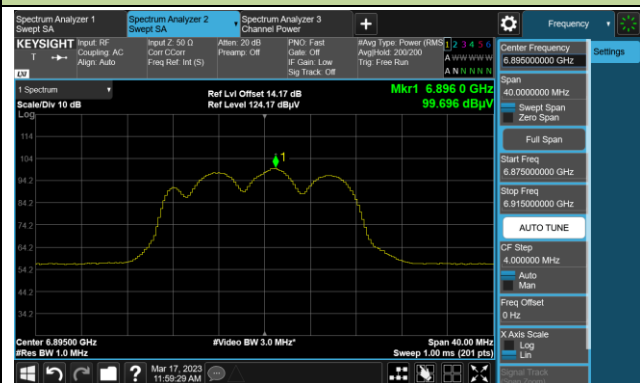

## Channel 213 (7015MHz)

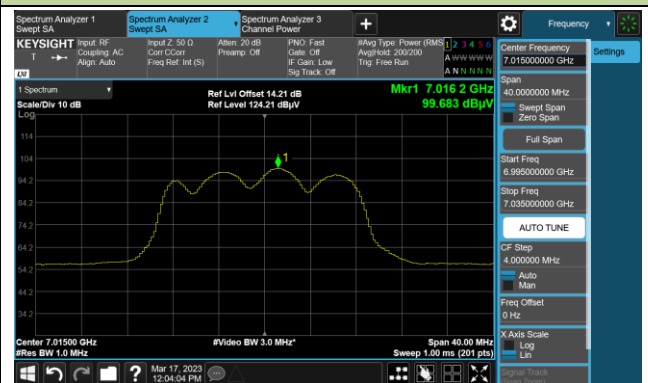

## Channel 229 (7095MHz)

