

# MEASUREMENT REPORT

## FCC PART 15.247 Bluetooth-LE

---

**FCC ID:** SFK-WF402AP

**Application:** CIG Shanghai Co., Ltd.

**Application Type:** Certification

**Product:** AirFinder Access Point

**Model No.:** WF402-AP

**Brand Name:** CIG

**FCC Classification:** Digital Transmission System (DTS)

**FCC Rule Part(s):** Part 15 Subpart C (Section 15.247)

**IC Rule(s):** RSS-247 Issue 2, RSS-GEN Issue 5

**Test Procedure(s):** ANSI C63.10-2013, KDB 558074 D01v05r02

**Test Date:** August 04 ~ 27, 2019

Reviewed By:   
( Sunny Sun )

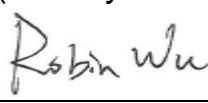
Approved By:   
( Robin Wu )



The test results relate only to the samples tested.

This equipment has been shown to be capable of compliance with the applicable technical standards as indicated in the measurement report and was tested in accordance with the measurement procedures specified in ANSI C63.10-2013. Test results reported herein relate only to the item(s) tested.

The test report shall not be reproduced except in full without the written approval of MRT Technology (Suzhou) Co., Ltd.

---

## Revision History

Report No.	Version	Description	Issue Date	Note
1907RSU055-U1	Rev. 01	Initial Report	09-09-2019	Valid

---

## CONTENTS

Description	Page
<b>1. INTRODUCTION .....</b>	<b>6</b>
1.1. Scope .....	6
1.2. MRT Test Location .....	6
<b>2. PRODUCT INFORMATION .....</b>	<b>7</b>
2.1. Feature of Equipment under Test .....	7
2.2. Product Specification Subjective to this Report.....	7
2.3. Working Frequencies for this report .....	7
2.4. Device Capabilities .....	8
2.5. EMI Suppression Device(s)/Modifications.....	8
2.6. Configuration of Tested System.....	9
2.7. Labeling Requirements.....	9
2.8. Test Software .....	9
<b>3. DESCRIPTION OF TEST .....</b>	<b>10</b>
3.1. Evaluation Procedure .....	10
3.2. AC Line Conducted Emissions .....	10
3.3. Radiated Emissions .....	11
<b>4. ANTENNA REQUIREMENTS.....</b>	<b>12</b>
<b>5. TEST EQUIPMENT CALIBRATION DATE.....</b>	<b>13</b>
<b>6. MEASUREMENT UNCERTAINTY.....</b>	<b>15</b>
<b>7. TEST RESULT .....</b>	<b>16</b>
7.1. Summary .....	16
7.2. 6dB Bandwidth Measurement.....	17
7.2.1. Test Limit .....	17
7.2.2. Test Procedure used.....	17
7.2.3. Test Setting.....	17
7.2.4. Test Setup.....	17
7.2.5. Test Result.....	18
7.3. Output Power Measurement.....	19
7.3.1. Test Limit .....	19
7.3.2. Test Procedure Used .....	19
7.3.3. Test Setting.....	19
7.3.4. Test Setup.....	19
7.3.5. Test Result.....	20

7.4.	Power Spectral Density Measurement .....	21
7.4.1.	Test Limit .....	21
7.4.2.	Test Procedure Used .....	21
7.4.3.	Test Setting.....	21
7.4.4.	Test Setup.....	21
7.4.5.	Test Result.....	22
7.5.	Conducted Band Edge and Out-of-Band Emissions.....	23
7.5.1.	Test Limit .....	23
7.5.2.	Test Procedure Used .....	23
7.5.3.	Test Setting.....	23
7.5.4.	Test Setup.....	24
7.5.5.	Test Result.....	25
7.6.	Radiated Spurious Emission Measurement .....	27
7.6.1.	Test Limit .....	27
7.6.2.	Test Procedure Used .....	27
7.6.3.	Test Setting.....	27
7.6.4.	Test Setup.....	29
7.6.5.	Test Result.....	30
7.7.	Radiated Restricted Band Edge Measurement .....	35
7.7.1.	Test Limit .....	35
7.7.2.	Test Procedure Used .....	36
7.7.3.	Test Setting.....	36
7.7.4.	Test Setup.....	37
7.7.5.	Test Result.....	38
7.8.	AC Conducted Emissions Measurement.....	46
7.8.1.	Test Limit .....	46
7.8.2.	Test Setup.....	46
7.8.3.	Test Result.....	46
<b>8.</b>	<b>CONCLUSION.....</b>	<b>47</b>
	<b>Appendix A – Test Setup Photograph.....</b>	<b>48</b>
	<b>Appendix B – EUT Photograph .....</b>	<b>49</b>

## §2.1033 General Information

<b>Applicant:</b>	CIG Shanghai Co., Ltd.
<b>Applicant Address:</b>	5/F, Building 37, No. 8 Dongbeiwang West Road, Haidian District Beijing 100194, P.R. China
<b>Manufacturer:</b>	CIG Shanghai Co., Ltd., Shanghai Branch.
<b>Manufacturer Address:</b>	F/2, 3 Building 1, No. 505 Jiangyue Road, Minhang District, Shanghai, P.R.China
<b>Test Site:</b>	MRT Technology (Suzhou) Co., Ltd
<b>Test Site Address:</b>	D8 Building, Youxin Industrial Park, No.2 Tian'edang Rd., Wuzhong Economic Development Zone, Suzhou, China

### Test Facility / Accreditations

Measurements were performed at MRT Laboratory located in Tian'edang Rd., Suzhou, China.

- MRT facility is a FCC registered (MRT Reg. No. 893164) test facility with the site description report on file and has met all the requirements specified in ANSI C63.4-2014.
- MRT facility is an IC registered (MRT Reg. No. 11384A-1) test laboratory with the site description on file at Industry Canada.
- MRT facility is a VCCI registered (R-20025, G-20034, C-20020, T-20020) test laboratory with the site description on file at VCCI Council.
- MRT Lab is accredited to ISO 17025 by the American Association for Laboratory Accreditation (A2LA) under the American Association for Laboratory Accreditation Program (A2LA Cert. No. 3628.01) in EMC, Telecommunications, Radio and SAR testing.



## 1. INTRODUCTION

### 1.1. Scope

Measurement and determination of electromagnetic emissions (EMC) of radio frequency devices including intentional and/or unintentional radiators for compliance with the technical rules and regulations of the Federal Communications Commission and the Industry Canada Certification and Engineering Bureau.

### 1.2. MRT Test Location

The map below shows the location of the MRT LABORATORY, its proximity to the Taihu Lake. These measurement tests were conducted at the MRT Technology (Suzhou) Co., Ltd. Facility located at D8 Building, No.2 Tian'edang Rd., Wuzhong Economic Development Zone, Suzhou, China. The measurement facility compliant with the test site requirements specified in ANSI C63.4-2014.



## 2. PRODUCT INFORMATION

### 2.1. Feature of Equipment under Test

Product Name:	AirFinder Access Point
Model No.:	WF402-AP
Brand Name:	CIG
Bluetooth Specification:	v4.0 (Bluetooth-LE only)
Lora Specification:	902 ~ 928 MHz

### 2.2. Product Specification Subjective to this Report

Bluetooth Frequency	2402~2480MHz
Bluetooth Version	v4.0 (Bluetooth-LE only)
Data Rate	1Mbps
Antenna Type	PCB Antenna
Antenna Gain:	2dBi

Note: For other features of this EUT, test report will be issued separately.

### 2.3. Working Frequencies for this report

Channel	Frequency	Channel	Frequency	Channel	Frequency
00	2402 MHz	01	2404 MHz	02	2406 MHz
03	2408 MHz	04	2410 MHz	05	2412 MHz
06	2414 MHz	07	2416 MHz	08	2418 MHz
09	2420 MHz	10	2422 MHz	11	2424 MHz
12	2426 MHz	13	2428 MHz	14	2430 MHz
15	2432 MHz	16	2434 MHz	17	2436 MHz
18	2438 MHz	19	2440 MHz	20	2442 MHz
21	2444 MHz	22	2446 MHz	23	2448 MHz
24	2450 MHz	25	2452 MHz	26	2454 MHz
27	2456 MHz	28	2458 MHz	29	2460 MHz
30	2462 MHz	31	2464 MHz	32	2466 MHz
33	2468 MHz	34	2470 MHz	35	2472 MHz
36	2474 MHz	37	2476 MHz	38	2478 MHz
39	2480 MHz	--	--	--	--

### 2.4. Device Capabilities

This device contains the following capabilities:

Bluetooth (v4.0)

**Note:** The maximum achievable duty cycles was determined based on measurements performed on a spectrum analyzer in zero-span mode with RBW = 8MHz, VBW = 50MHz. The RBW and VBW were both greater than 50/T, where T is the minimum transmission duration, and the number of sweep points across T was greater than 100. The duty cycles are as follows:

Test Mode	Duty Cycle
BLE	53.58%

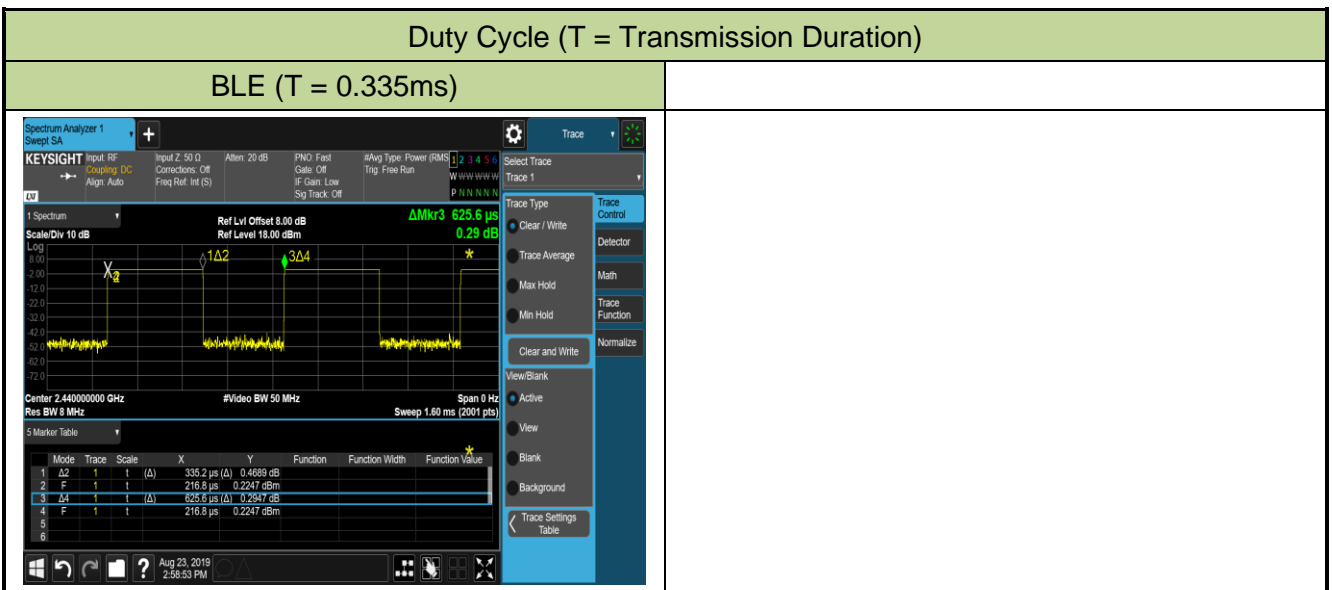

### 2.5. EMI Suppression Device(s)/Modifications

No EMI suppression device(s) were added and/or no modifications were made during testing.



## 2.6. Configuration of Tested System

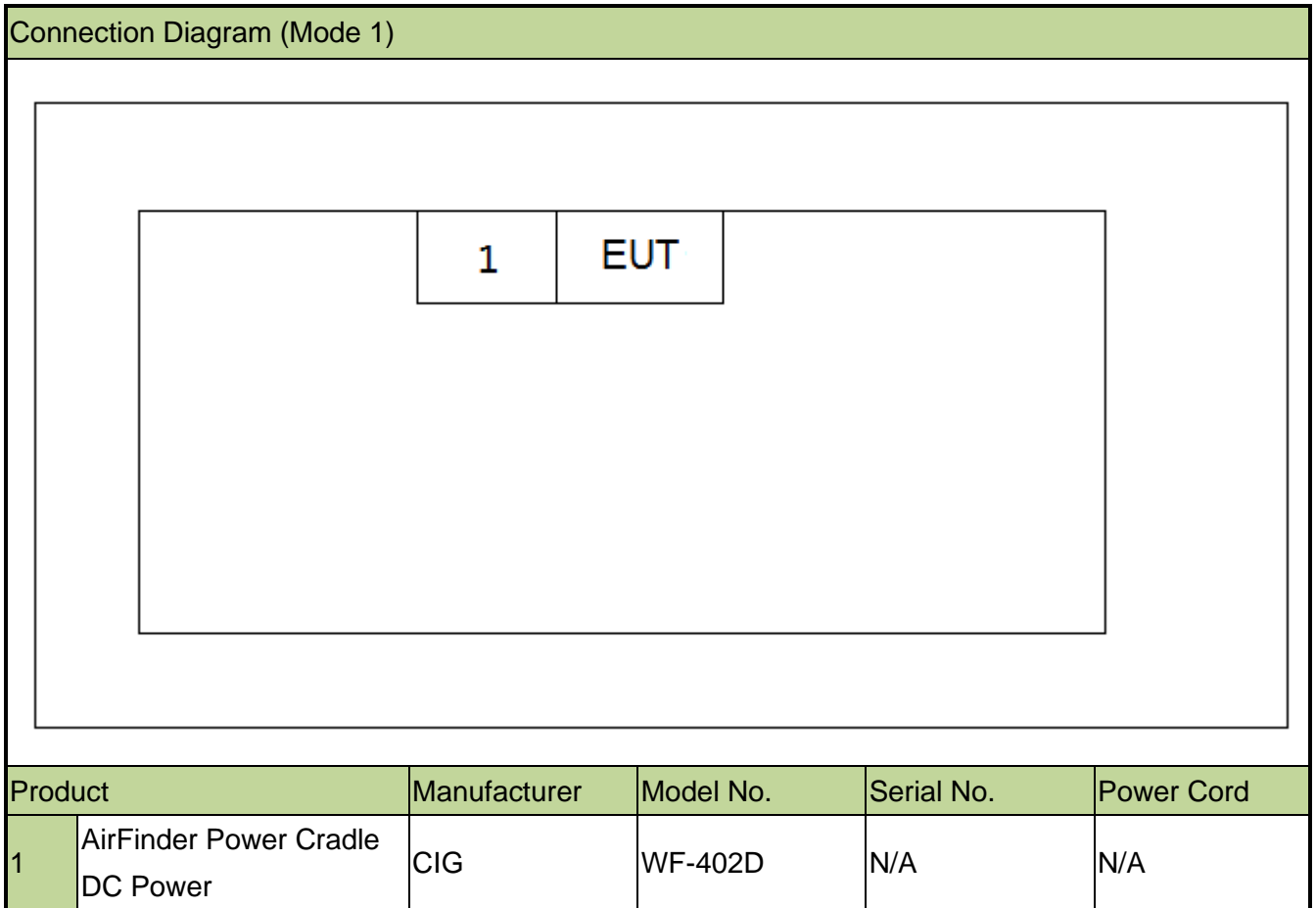

## 2.7. Labeling Requirements

Per 2.1074 & 15.19; Docket 95-19

The label shall be permanently affixed at a conspicuous location on the device; instruction manual or pamphlet supplied to the user and be readily visible to the purchaser at the time of purchase.

However, when the device is so small wherein placement of the label with specified statement is not practical, only the FCC ID must be displayed on the device per Section 15.19(a)(5). Please see attachment for FCC ID label and label location.

## 2.8. Test Software

The test utility software used during testing was “nRFgo Studio”.

### 3. DESCRIPTION OF TEST

#### 3.1. Evaluation Procedure

The measurement procedures described in the American National Standard for Testing Unlicensed Wireless Devices (ANSI C63.10-2013), and the guidance provided in KDB 558074 D01v05r02 were used in the measurement.

**Deviation from measurement procedure.....None**

#### 3.2. AC Line Conducted Emissions

The line-conducted facility is located inside an 8'x4'x4' shielded enclosure. A 1m x 2m wooden table 80cm high is placed 40cm away from the vertical wall and 80cm away from the sidewall of the shielded room. Two 10kHz-30MHz, 50Ω/50uH Line-Impedance Stabilization Networks (LISNs) are bonded to the shielded room floor. Power to the LISNs is filtered by external high-current high-insertion loss power line filters. These filters attenuate ambient signal noise from entering the measurement lines. These filters are also bonded to the shielded enclosure.

The EUT is powered from one LISN and the support equipment is powered from the second LISN. All interconnecting cables more than 1 meter were shortened to a 1 meter length by non-inductive bundling (serpentine fashion) and draped over the back edge of the test table. All cables were at least 40cm above the horizontal reference ground-plane. Power cables for support equipment were routed down to the second LISN while ensuring that that cables were not draped over the second LISN.

Sufficient time for the EUT, support equipment, and test equipment was allowed in order for them to warm up to their normal operating condition. The RF output of the LISN was connected to the receiver and exploratory measurements were made to determine the frequencies producing the maximum emission from the EUT. The receiver was scanned from 150kHz to 30MHz. The detector function was set to peak mode for exploratory measurements while the bandwidth of the analyzer was set to 9kHz. The EUT, support equipment, and interconnecting cables were arranged and manipulated to maximize each emission. Each emission was also maximized by varying: power lines, the mode of operation or data exchange speed, or support equipment whichever determined the worst-case emission. Once the worst case emissions have been identified, the one EUT cable configuration/arrangement and mode of operation that produced these emissions were used for final measurements on the same test site. The analyzer is set to CISPR quasi-peak and average detectors with a 9kHz resolution bandwidth for final measurements.

An extension cord was used to connect to a single LISN which powered by EUT. The extension cord was calibrated with LISN, the impedance and insertion loss are compliance with the requirements as stated in ANSI C63.10-2013.

### 3.3. Radiated Emissions

The radiated test facilities consisted of an indoor 3 meter semi-anechoic chamber used for final measurements and exploratory measurements, when necessary. The measurement area is contained within the semi-anechoic chamber which is shielded from any ambient interference. For measurements above 1GHz absorbers are arranged on the floor between the turn table and the Antenna mast in such a way so as to maximize the reduction of reflections. For measurements below 1GHz, the absorbers are removed. A MF Model 210SS turntable is used for radiated measurement. It is a continuously rotatable, remote controlled, metallic turntable and 2 meters (6.56 ft.) in diameter. The turn table is flush with the raised floor of the chamber in order to maintain its function as a ground plane. An 80cm high PVC support structure is placed on top of the turntable. For all measurements, the spectrum was scanned through all EUT azimuths and from 1 to 4 meter receive Antenna height using a broadband Antenna from 30MHz up to the upper frequency shown in 15.33(b)(1) depending on the highest frequency generated or used in the device or on which the device operates or tunes. For frequencies above 1GHz, linearly polarized double ridge horn Antennas were used. For frequencies below 30MHz, a calibrated loop Antenna was used. When exploratory measurements were necessary, they were performed at 1 meter test distance inside the semi-anechoic chamber using broadband Antennas, broadband amplifiers, and spectrum analyzers to determine the frequencies and modes producing the maximum emissions. Sufficient time for the EUT, support equipment, and test equipment was allowed in order for them to warm up to their normal operating condition. The test set-up for frequencies below 1GHz was placed on top of the 0.8 meter high, 1 x 1.5 meter table; and test set-up for frequencies 1-40GHz was placed on top of the 1.5 meter high, 1 x 1.5 meter table. The EUT, support equipment, and interconnecting cables were arranged and manipulated to maximize each emission. Appropriate precaution was taken to ensure that all emissions from the EUT were maximized and investigated. The system configuration, clock speed, mode of operation or video resolution, if applicable, turntable azimuth, and receive Antenna height was noted for each frequency found.

Final measurements were made in the semi-anechoic chamber using calibrated, linearly polarized broadband and horn Antennas. The test setup was configured to the setup that produced the worst case emissions. The spectrum analyzer was set to investigate all frequencies required for testing to compare the highest radiated disturbances with respect to the specified limits. The turntable containing the EUT was rotated through 360 degrees and the height of the receive Antenna was varied 1 to 4 meters and stopped at the azimuth and height producing the maximum emission. Each emission was maximized by changing the orientation of the EUT through three orthogonal planes and changing the polarity of the receive Antenna, whichever produced the worst-case emissions. According to 3dB Beam-Width of horn Antenna, the horn Antenna should be always directed to the EUT when rising height.

## 4. ANTENNA REQUIREMENTS

### **Excerpt from §15.203 of the FCC Rules/Regulations:**

“An intentional radiator antenna shall be designed to ensure that no antenna other than that furnished by the responsible party can be used with the device. The use of a permanently attached antenna or of an antenna that uses a unique coupling to the intentional radiator shall be considered sufficient to comply with the provisions of this section.”

- The antenna is permanently attached.
- There are no provisions for connection to an external antenna.

### **Conclusion:**

The unit complies with the requirement of §15.203.

## 5. TEST EQUIPMENT CALIBRATION DATE

### Conducted Emissions - SR2

Instrument	Manufacturer	Type No.	Asset No.	Cali. Interval	Cali. Due Date
EMI Test Receiver	R&S	ESR3	MRTSUE06185	1 year	2020/04/15
Two-Line V-Network	R&S	ENV 216	MRTSUE06002	1 year	2020/06/13
Two-Line V-Network	R&S	ENV 216	MRTSUE06003	1 year	2020/06/13
Thermohygrometer	Testo	608-H1	MRTSUE06404	1 year	2020/08/08
Shielding Room	MIX-BEP	Chamber-SR2	MRTSUE06215	N/A	N/A

### Radiated Emissions - AC1

Instrument	Manufacturer	Type No.	Asset No.	Cali. Interval	Cali. Due Date
EMI Test Receiver	R&S	ESR7	MRTSUE06001	1 year	2020/08/01
PXA Signal Analyzer	Keysight	9030B	MRTSUE06395	1 year	2019/09/25
Loop Antenna	Schwarzbeck	FMZB 1519	MRTSUE06025	1 year	2019/11/09
Bilog Period Antenna	Schwarzbeck	VULB 9168	MRTSUE06172	1 year	2020/03/31
Broad Band Horn Antenna	Schwarzbeck	BBHA 9120D	MRTSUE06023	1 year	2019/10/19
Broad Band Horn Antenna	Schwarzbeck	BBHA 9170	MRTSUE06024	1 year	2019/12/17
Microwave System Amplifier	Agilent	83017A	MRTSUE06076	1 year	2019/11/16
Preamplifier	Schwarzbeck	BBV 9721	MRTSUE06121	1 year	2020/06/11
Thermohygrometer	Testo	608-H1	MRTSUE06403	1 year	2020/08/08
Anechoic Chamber	TDK	Chamber-AC1	MRTSUE06212	1 year	2020/04/30

### Radiated Emission - AC2

Instrument	Manufacturer	Type No.	Asset No.	Cali. Interval	Cali. Due Date
Spectrum Analyzer	Keysight	N9038A	MRTSUE06125	1 year	2020/08/01
Loop Antenna	Schwarzbeck	FMZB 1519	MRTSUE06025	1 year	2019/11/09
Bilog Period Antenna	Schwarzbeck	VULB 9162	MRTSUE06022	1 year	2019/10/19
Horn Antenna	Schwarzbeck	BBHA9120D	MRTSUE06171	1 year	2019/11/09
Broad Band Horn Antenna	Schwarzbeck	BBHA 9170	MRTSUE06024	1 year	2019/12/17
Broadband Coaxial Preamplifier	Schwarzbeck	BBV 9718	MRTSUE06176	1 year	2019/11/16
Preamplifier	Schwarzbeck	BBV 9721	MRTSUE06121	1 year	2020/06/11
Temperature/Humidity Meter	Minggao	ETH529	MRTSUE06170	1 year	2019/12/13
Anechoic Chamber	RIKEN	Chamber-AC2	MRTSUE06213	1 year	2020/04/30

## Conducted Test Equipment - TR3

Instrument	Manufacturer	Type No.	Asset No.	Cali. Interval	Cali. Due Date
EXA Signal Analyzer	Agilent	N9020A	MRTSUE06106	1 year	2020/04/15
EXA Signal Analyzer	Keysight	N9010B	MRTSUE06452	1 year	2020/07/11
Signal Analyzer	R&S	FSV40	MRTSUE06218	1 year	2020/04/15
Power Meter	Agilent	U2021XA	MRTSUE06030	1 year	2019/11/16
USB wideband power sensor	Keysight	U2021XA	MRTSUE06446	1 year	2020/06/30
USB wideband power sensor	Keysight	U2021XA	MRTSUE06447	1 year	2020/06/30
Bluetooth Test Set	Anritsu	MT8852B-042	MRTSUE06389	1 year	2020/06/13
Audio Analyzer	Agilent	U8903B	MRTSUE06143	1 year	2020/06/13
Modulation Analyzer	HP	8901A	MRTSUE06098	1 year	2019/10/18
Wideband Radio Communication Tester	R&S	CMW 500	MRTSUE06243	1 year	2019/11/16
DC Power Supply	GWINSTEK	DPS-3303C	MRTSUE06064	N/A	N/A
Temperature & Humidity Chamber	BAOYT	BYH-150CL	MRTSUE06051	1 year	2019/11/16
Thermohygrometer	testo	608-H1	MRTSUE06401	1 year	2020/08/08

Software	Version	Function
EMI Software	V3	EMI Test Software

## 6. MEASUREMENT UNCERTAINTY

Where relevant, the following test uncertainty levels have been estimated for tests performed on the EUT as specified in CISPR 16-4-2. This uncertainty represents an expanded uncertainty expressed at approximately the 95% confidence level using a coverage factor of  $k = 2$ .

<b>AC Conducted Emission Measurement - SR2</b>
Measuring Uncertainty for a Level of Confidence of 95% ( $U=2Uc(y)$ ): 150kHz~30MHz: 3.46dB
<b>Radiated Emission Measurement - AC1</b>
Measuring Uncertainty for a Level of Confidence of 95% ( $U=2Uc(y)$ ): 9kHz ~ 1GHz: 4.18dB 1GHz ~ 25GHz: 4.76dB

## 7. TEST RESULT

### 7.1. Summary

FCC Section(s)	Test Description	Test Limit	Test Condition	Test Result	Reference
15.247(a)(2)	6dB Bandwidth	$\geq 500\text{kHz}$	Conducted	Pass	Section 7.2
15.247(b)(3)	Output Power	$\leq 30\text{dBm}$		Pass	Section 7.3
15.247(e)	Power Spectral Density	$\leq 8\text{dBm}/3\text{kHz}$		Pass	Section 7.4
15.247(d)	Band Edge / Out-of-Band Emissions	$\leq 20\text{dBc}$ (Peak)		Pass	Section 7.5
15.205 15.209	General Field Strength Limits (Restricted Bands and Radiated Emission Limits)	Emissions in restricted bands must meet the radiated limits detailed in 15.209	Radiated	Pass	Section 7.6 & 7.7
15.207	AC Conducted Emissions 150kHz - 30MHz	< FCC 15.207 limits	Line Conducted	N/A	Section 7.8

#### Notes:

- 1) The analyzer plots shown in this section were all taken with a correction table loaded into the analyzer. The correction table was used to account for the losses of the cables and attenuators used as part of the system to connect the EUT to the analyzer at all frequencies of interest.
- 2) All modes of operation and data rates were investigated. For radiated emission test, every axis (X, Y, Z) was also verified. The test results shown in the following sections represent the worst case emissions.



## 7.2. 6dB Bandwidth Measurement

### 7.2.1. Test Limit

The minimum 6dB bandwidth shall be at least 500 kHz.

### 7.2.2. Test Procedure used

ANSI C63.10-2013 - Section 11.8.2 Option 2

### 7.2.3. Test Setting

1. The Spectrum's automatic bandwidth measurement capability was used to perform the 6dB bandwidth measurement. The "X" dB bandwidth parameter was set to  $X = 6$ . The bandwidth measurement was not influenced by any intermediate power nulls in the fundamental emission.
2. Set RBW = 100 kHz
3. VBW  $\geq 3 \times$  RBW
4. Detector = Peak
5. Trace mode = max hold
6. Sweep = auto couple
7. Allow the trace was allowed to stabilize

### 7.2.4. Test Setup

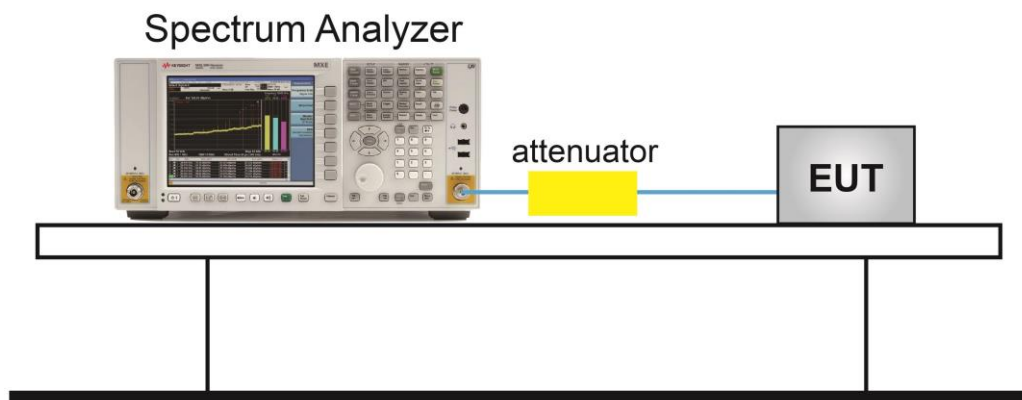

**7.2.5. Test Result**

Product	AirFinder Access Point	Temperature	25°C
Test Engineer	Chase Zhu	Relative Humidity	52%
Test Site	TR3	Test Date	2019/08/23

Test Mode	Data Rate (Mbps)	Channel No.	Frequency (MHz)	6dB Bandwidth (MHz)	Limit (MHz)	Result
BLE	1	00	2402	0.69	≥ 0.5	Pass
BLE	1	19	2440	0.70	≥ 0.5	Pass
BLE	1	39	2480	0.69	≥ 0.5	Pass

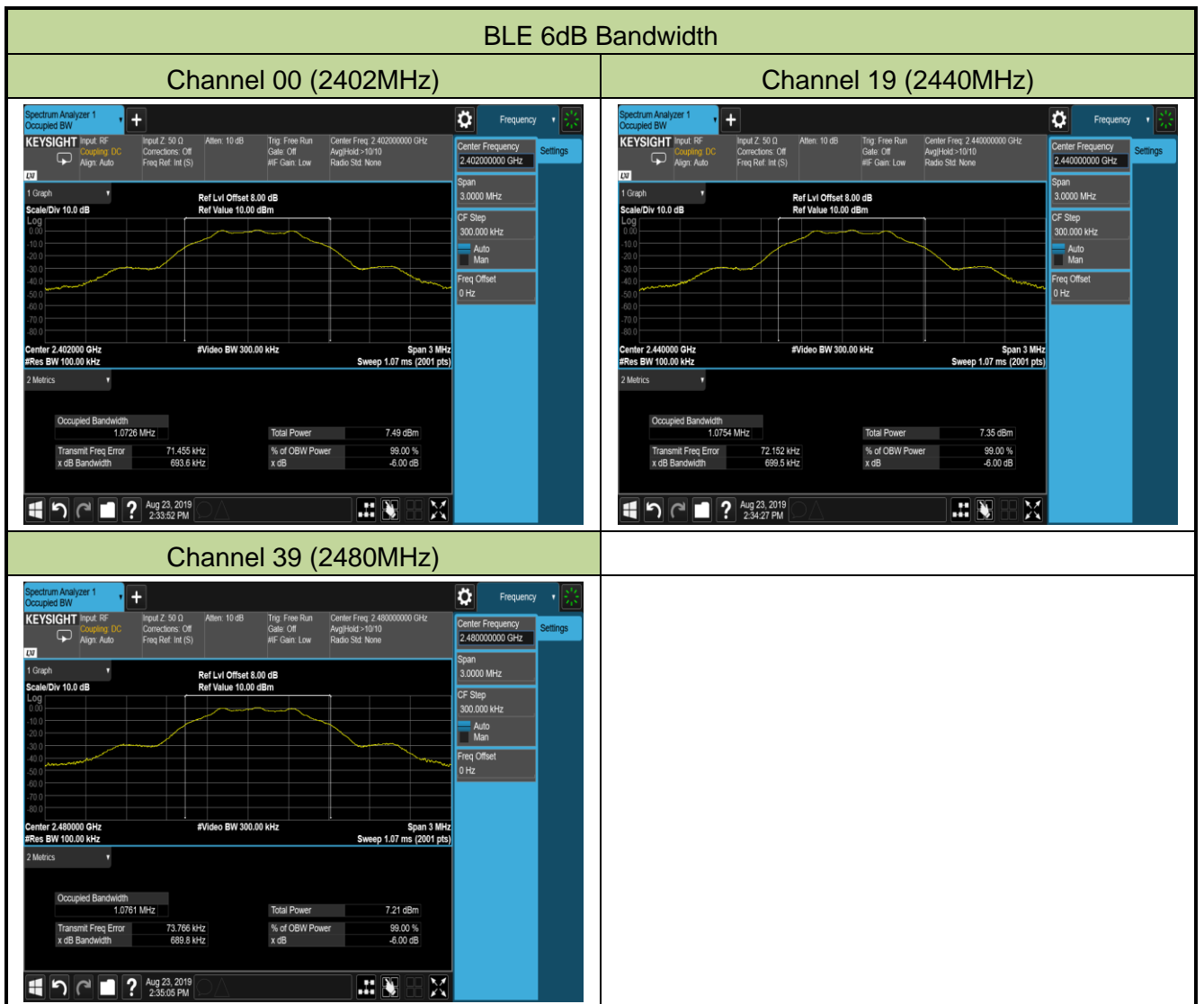

### 7.3. Output Power Measurement

#### 7.3.1. Test Limit

The maximum out power shall be less 1 Watt (30dBm).

The conducted output power limit specified in paragraph FCC Part 15.247(b) of this section is based on the use of antennas with directional gains that do not exceed 6 dBi. If transmitting antennas of directional gain greater than 6 dBi are used, the conducted output power from the intentional radiator shall be reduced below the stated values in paragraphs FCC Part 15.247(b)(3) of this section, as appropriate, by the amount in dB that the directional gain of the antenna exceeds 6 dBi.

#### 7.3.2. Test Procedure Used

ANSI C63.10-2013 - Section 11.9.1.3 & 11.9.2.3.

#### 7.3.3. Test Setting

##### **Method PKPM1 (Peak Power Measurement of Signals with DTS BW $\leq$ 50MHz)**

Peak power measurements were performed only when the EUT was transmitting at its maximum power control level using a broadband power meter with a pulse sensor. The pulse sensor employs a VBW = 50MHz so this method was only used for signals whose DTS bandwidth was less than or equal to 50MHz.

#### 7.3.4. Test Setup

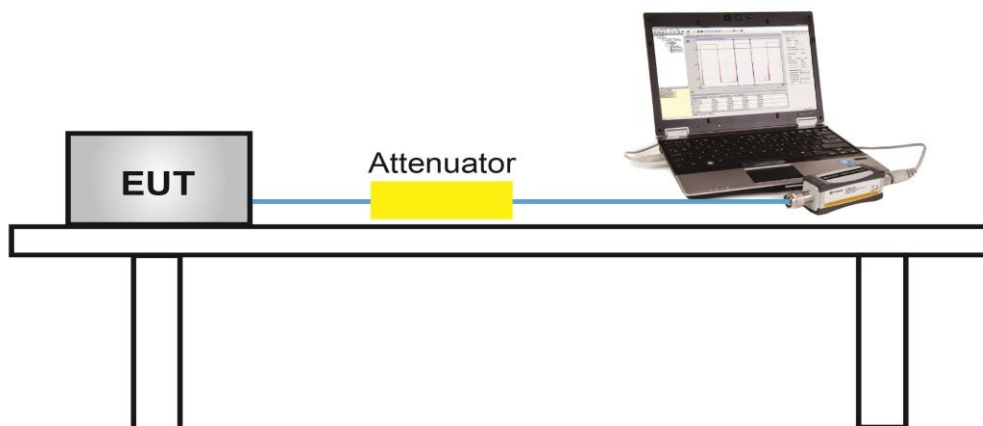

**7.3.5. Test Result**

Product	AirFinder Access Point	Temperature	25°C
Test Engineer	Chase Zhu	Relative Humidity	52%
Test Site	TR3	Test Date	2019/08/20

**Test Result of Peak Output Power**

Test Mode	Data Rate (Mbps)	Channel No.	Frequency (MHz)	Peak Power (dBm)	Limit (dBm)	Result
BLE	1	00	2402	0.93	≤ 30.00	Pass
BLE	1	19	2440	0.84	≤ 30.00	Pass
BLE	1	39	2480	0.72	≤ 30.00	Pass

**Test Result of Average Output Power (Reporting Only)**

Test Mode	Data Rate (Mbps)	Channel No.	Frequency (MHz)	Average Power (dBm)	Limit (dBm)	Result
BLE	1	00	2402	0.81	≤ 30.00	Pass
BLE	1	19	2440	0.69	≤ 30.00	Pass
BLE	1	39	2480	0.57	≤ 30.00	Pass

## 7.4. Power Spectral Density Measurement

### 7.4.1. Test Limit

The maximum permissible power spectral density is 8dBm in any 3 kHz band.

### 7.4.2. Test Procedure Used

ANSI C63.10 Section 11.10.2

### 7.4.3. Test Setting

1. Analyzer was set to the center frequency of the DTS channel under investigation
2. Span = 1.5 times the DTS channel bandwidth
3. RBW = 3kHz
4. VBW = 10kHz
5. Detector = peak
6. Sweep time = auto couple
7. Trace mode = max hold
8. Trace was allowed to stabilize

### 7.4.4. Test Setup

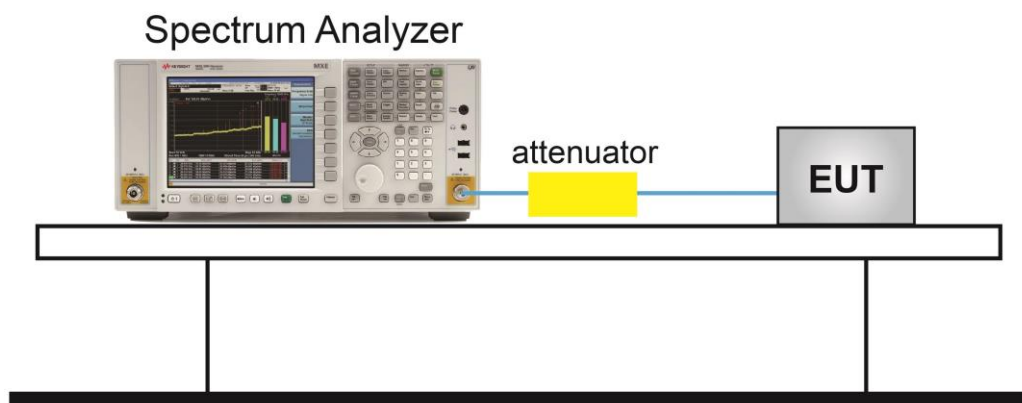

**7.4.5. Test Result**

Product	AirFinder Access Point	Temperature	25°C
Test Engineer	Chase Zhu	Relative Humidity	52%
Test Site	TR3	Test Date	2019/08/23

Test Mode	Data Rate (Mbps)	Channel No.	Frequency (MHz)	PSD Result (dBm / 3kHz)	Limit (dBm / 3kHz)	Result
BLE	1	00	2402	-14.50	≤ 8.00	Pass
BLE	1	19	2440	-14.75	≤ 8.00	Pass
BLE	1	39	2480	-14.94	≤ 8.00	Pass

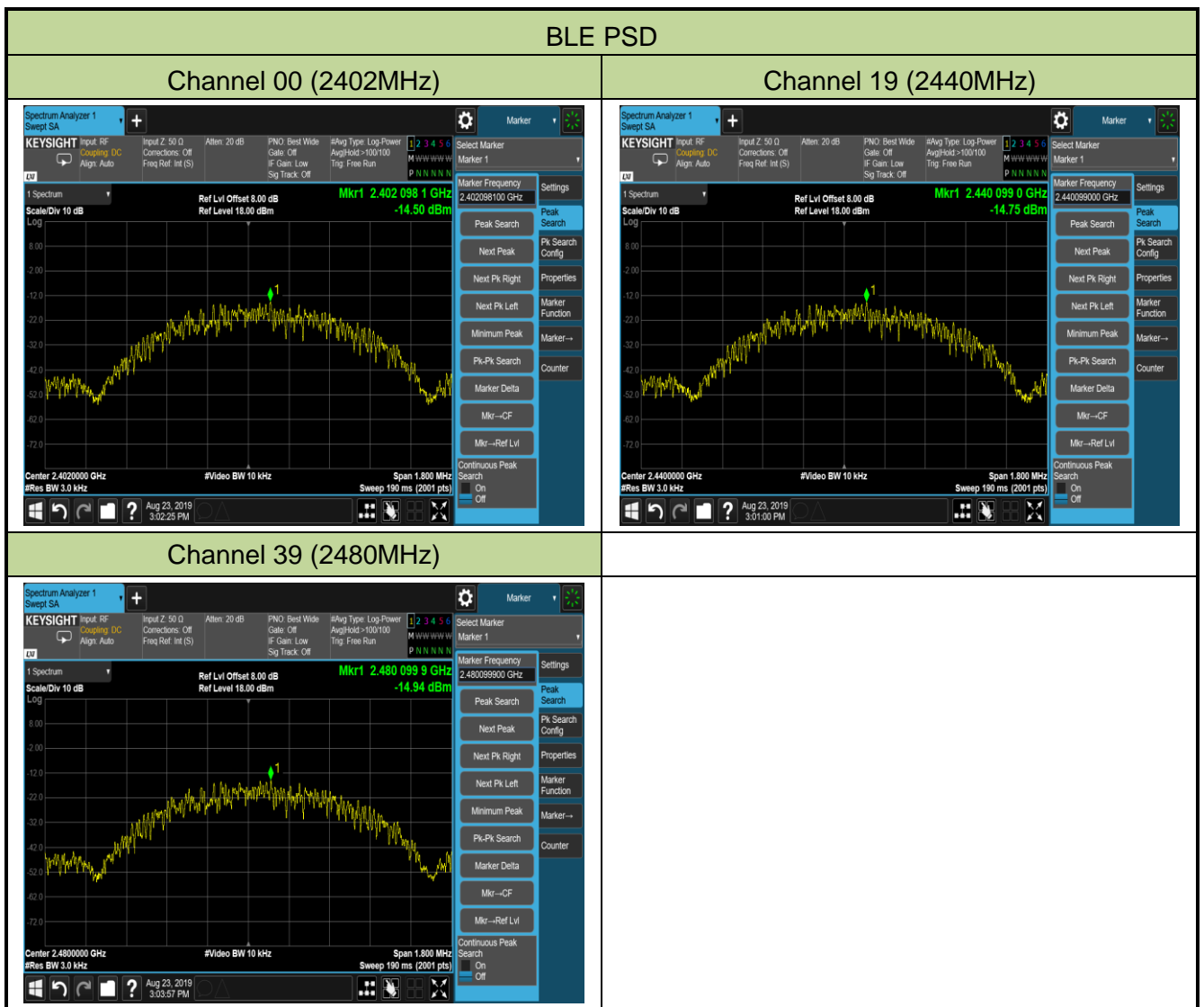

## **7.5. Conducted Band Edge and Out-of-Band Emissions**

### **7.5.1. Test Limit**

The limit for out-of-band spurious emissions at the band edge is 20dB below the fundamental emission level, as determined from the in-band power measurement of the DTS channel performed in a 100kHz bandwidth per the PSD procedure.

### **7.5.2. Test Procedure Used**

ANSI C63.10 Section 11.11

### **7.5.3. Test Setting**

#### **Reference level measurement**

1. Set instrument center frequency to DTS channel center frequency
2. Set the span to  $\geq 1.5$  times the DTS bandwidth
3. Set the RBW = 100 kHz
4. Set the VBW  $\geq 3 \times$  RBW
5. Detector = peak
6. Sweep time = auto couple
7. Trace mode = max hold
8. Allow trace to fully stabilize

#### **Emission level measurement**

1. Set the center frequency and span to encompass frequency range to be measured
2. RBW = 100kHz
3. VBW = 300kHz
4. Detector = Peak
5. Number of sweep points  $\geq 2 \times$  Span/RBW
6. Trace mode = max hold
7. Sweep time = auto couple
8. The trace was allowed to stabilize

### Test Notes

1. RBW was set to 1.3MHz rather than 100kHz in order to increase the measurement speed.
2. The display line shown in the following plots denotes the limit at 20dB below the fundamental emission level measured in a 100kHz bandwidth. However, since the traces in the following plots are measured with a 1.3MHz RBW, the display line may not necessarily appear to be 20dB below the level of the fundamental in a 1.3MHz bandwidth.
3. For plots showing conducted spurious emissions near the limit, the frequencies were investigated with a reduced RBW to ensure that no emissions were present.

### 7.5.4. Test Setup

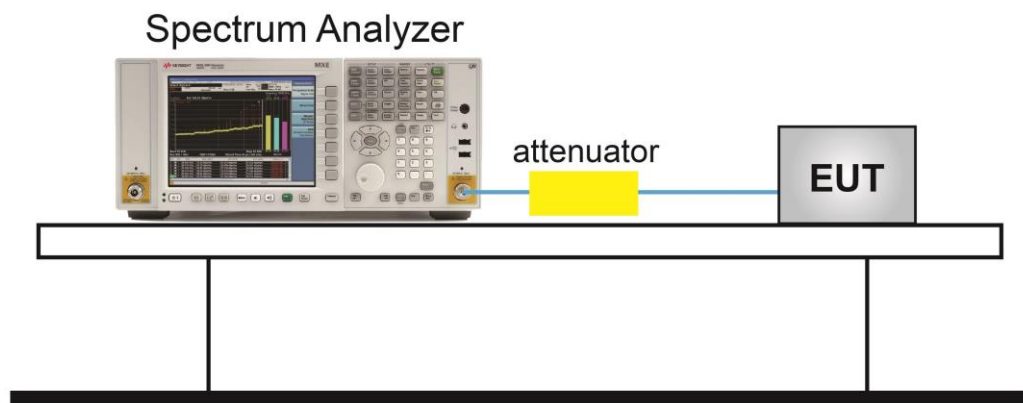



### 7.5.5. Test Result

Product	AirFinder Access Point	Temperature	25°C
Test Engineer	Chase Zhu	Relative Humidity	52%
Test Site	TR3	Test Date	2019/08/23

Test Mode	Data Rate (Mbps)	Channel No.	Frequency (MHz)	Limit	Result
BLE	1	00	2402	20dBc	Pass
BLE	1	19	2440	20dBc	Pass
BLE	1	39	2480	20dBc	Pass

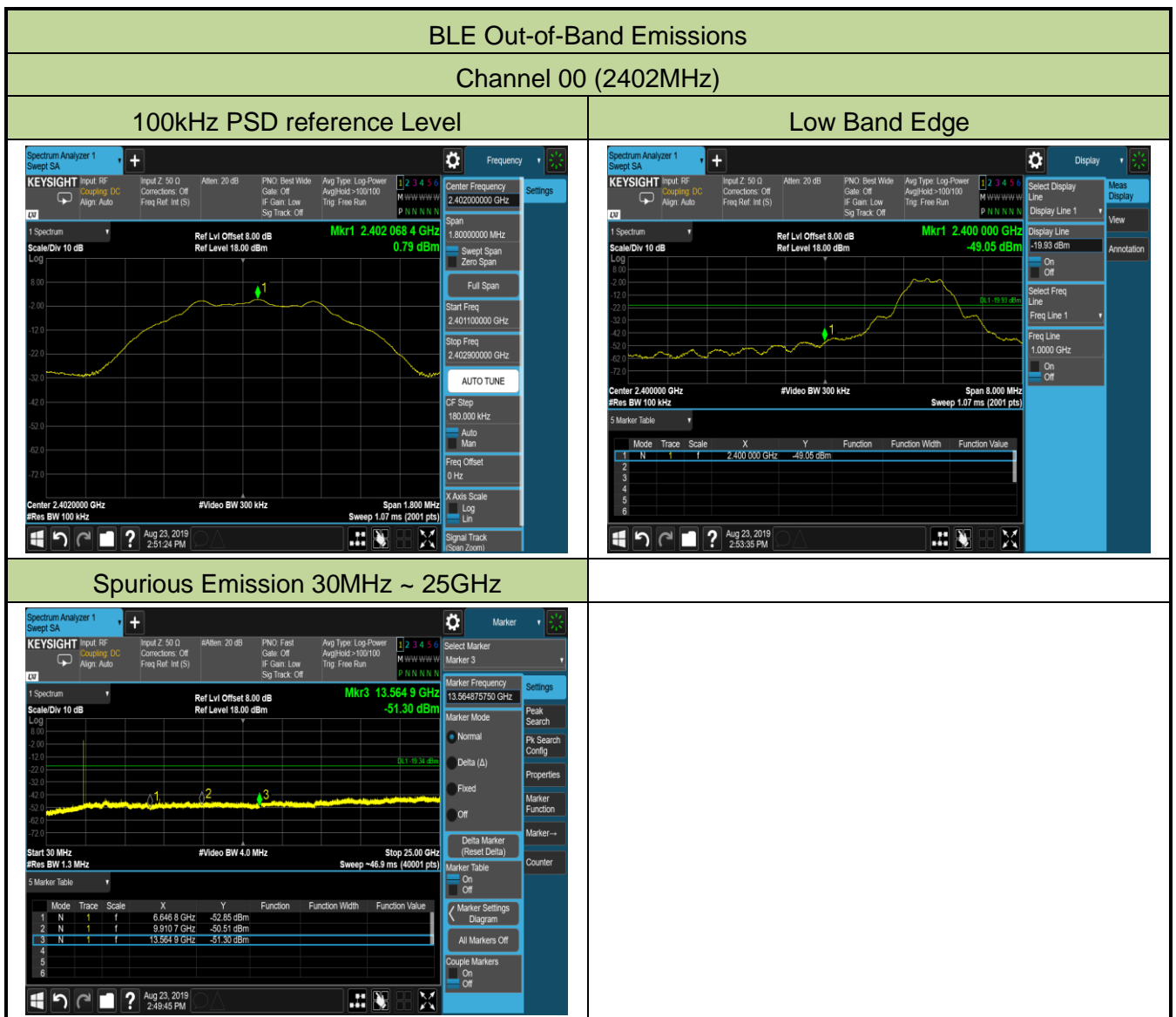

Channel 19 (2440MHz)

100kHz PSD reference Level



Spurious Emission 30MHz ~ 25GHz

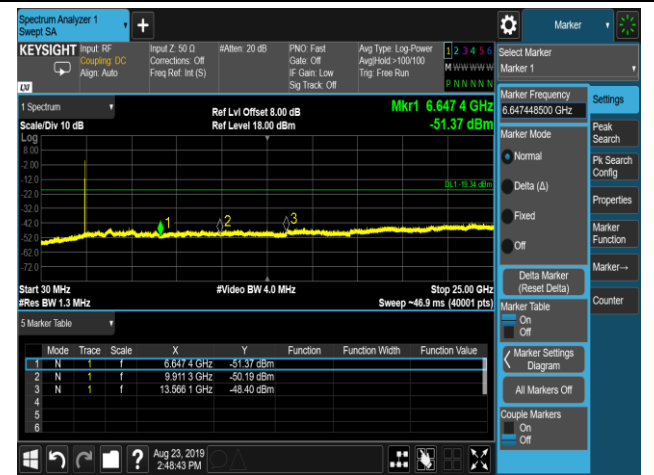

Channel 39 (2480MHz)

100kHz PSD reference Level

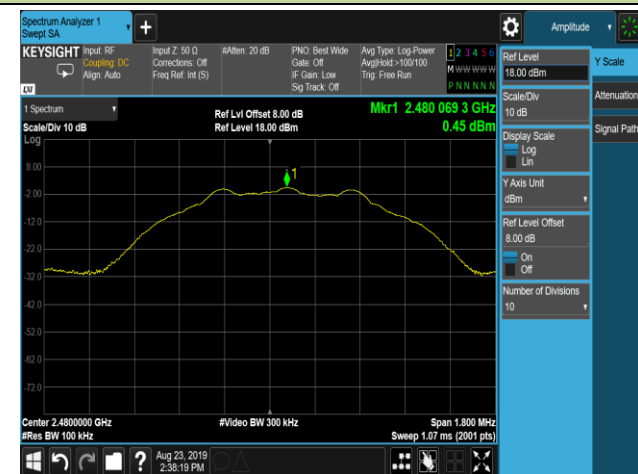

High Band Edge

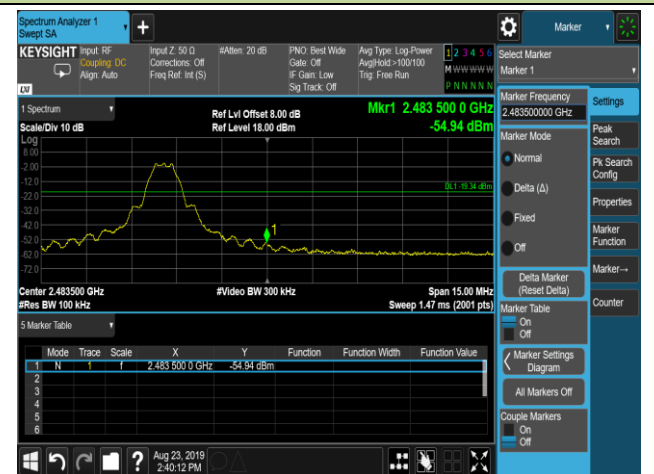

Spurious Emission 30MHz ~ 25GHz

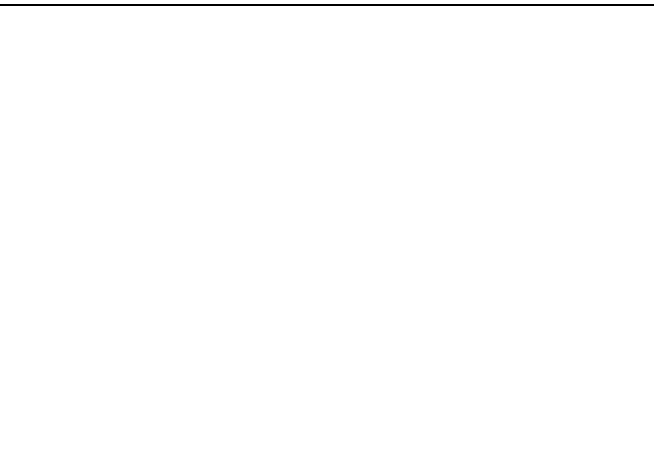
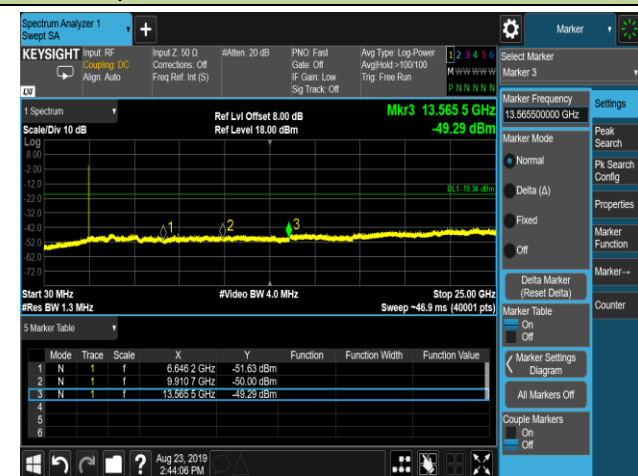

## 7.6. Radiated Spurious Emission Measurement

### 7.6.1. Test Limit

All out of band emissions appearing in a restricted band as specified in Section 15.205 of the Title 47 CFR must not exceed the limits shown in Table per Section 15.209.

FCC Part 15 Subpart C Paragraph 15.209		
Frequency (MHz)	Field Strength (uV/m)	Measured Distance (Meters)
0.009 - 0.490	2400/F (kHz)	300
0.490 - 1.705	24000/F (kHz)	30
1.705 - 30	30	30
30 - 88	100	3
88 - 216	150	3
216 - 960	200	3
Above 960	500	3

### 7.6.2. Test Procedure Used

ANSI C63.10 Section 6.3 (General Requirements)

ANSI C63.10 Section 6.4 (Standard test method below 30MHz)

ANSI C63.10 Section 6.5 (Standard test method above 30MHz to 1GHz)

ANSI C63.10 Section 6.6 (Standard test method above 1GHz)

### 7.6.3. Test Setting

#### Peak Field Strength Measurements

1. Analyzer center frequency was set to the frequency of the radiated spurious emission of interest
2. RBW = as specified in Table 1
3. VBW = 3MHz
4. Detector = peak
5. Sweep time = auto couple
6. Trace mode = max hold
7. Trace was allowed to stabilize

**Table 1 - RBW as a function of frequency**

Frequency	RBW
9 ~ 150 kHz	200 ~ 300 Hz
0.15 ~ 30 MHz	9 ~ 10 kHz
30 ~ 1000 MHz	100 ~ 120 kHz
> 1000 MHz	1 MHz

**Average Field Strength Measurements**

1. Analyzer center frequency was set to the frequency of the radiated spurious emission of interest
2. RBW = 1MHz
3. VBW  $\geq 1/T$
4. De As an alternative, the instrument may be set to linear detector mode. Ensure that video filtering is applied in linear voltage domain (rather than in a log or dB domain). Some instruments require linear display mode in order to accomplish this. Others have a setting for Average-VBW Type, which can be set to "Voltage" regardless of the display mode
5. Detector = Peak
6. Sweep time = auto
7. Trace mode = max hold
8. Allow max hold to run for at least 50 times (1/duty cycle) traces

### 7.6.4. Test Setup

#### Below 1GHz Test Setup:

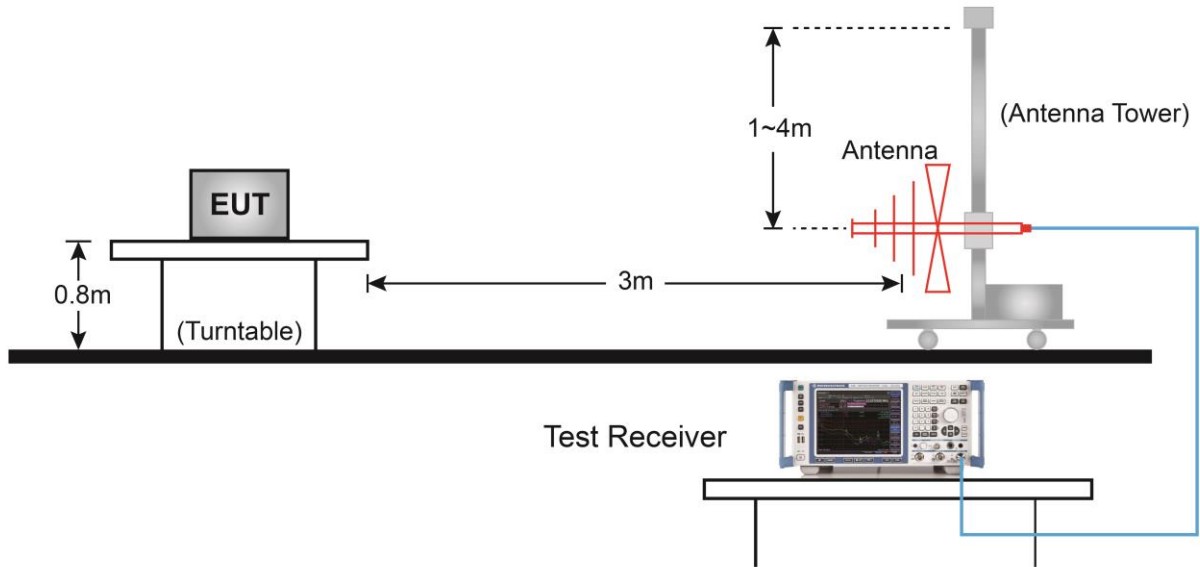

#### Above 1GHz Test Setup:

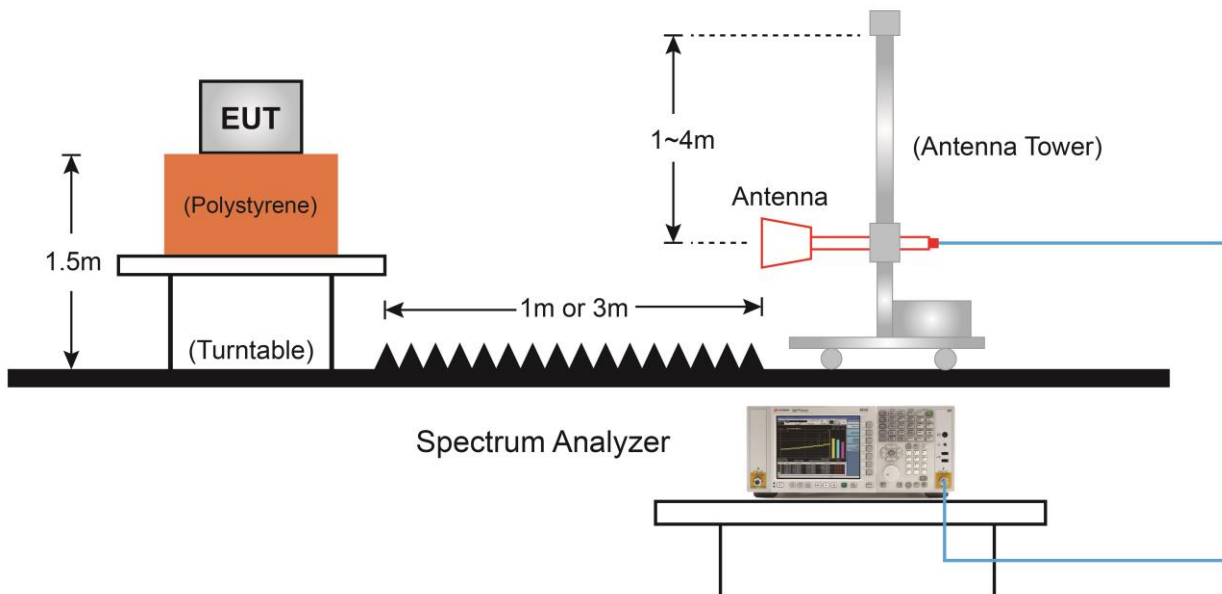

**7.6.5. Test Result**

Product	AirFinder Access Point	Temperature	26°C
Test Engineer	Dandy Li	Relative Humidity	56%
Test Site	AC1	Test Date	2019/08/06
Model No.	WF-402AP	Test Channel	00
Remark:	1. Average measurement was not performed if peak level lower than average limit. 2. Other frequency was 20dB below limit line within 1-18GHz, there is not show in the report.		

Mark	Frequency (MHz)	Reading Level (dBμV)	Factor (dB)	Measure Level (dBμV/m)	Limit (dBμV/m)	Margin (dB)	Detector	Polarization
	4068.5	38.0	2.7	40.7	74.0	-33.3	Peak	Horizontal
	5012.0	36.9	6.1	43.0	74.0	-31.0	Peak	Horizontal
*	7205.0	38.3	11.6	49.9	74.0	-24.1	Peak	Horizontal
*	8556.5	36.4	12.8	49.2	74.0	-24.8	Peak	Horizontal
	4791.0	38.2	5.4	43.6	74.0	-30.4	Peak	Vertical
	7358.0	36.9	11.7	48.6	74.0	-25.4	Peak	Vertical
*	7987.0	36.3	12.6	48.9	74.0	-25.1	Peak	Vertical
*	10214.0	35.1	16.5	51.6	74.0	-22.4	Peak	Vertical

Note 1: "\*" is not in restricted band, its limit is 20dBc of the fundamental emission level (93.4dBμV/m) or 15.209 which is higher.

Note 2: Measure Level (dBμV/m) = Reading Level (dBμV) + Factor (dB)

Factor (dB) = Cable Loss (dB) + Antenna Factor (dB/m) - Pre\_Amplifier Gain (dB)

Product	AirFinder Access Point	Temperature	26°C
Test Engineer	Dandy Li	Relative Humidity	56%
Test Site	AC1	Test Date	2019/08/06
Model No.	WF-402AP	Test Channel	19
Remark:	<ol style="list-style-type: none"> <li>1. Average measurement was not performed if peak level lower than average limit.</li> <li>2. Other frequency was 20dB below limit line within 1-18GHz, there is not show in the report.</li> </ol>		

Mark	Frequency (MHz)	Reading Level (dBμV)	Factor (dB)	Measure Level (dBμV/m)	Limit (dBμV/m)	Margin (dB)	Detector	Polarization
	4995.0	36.4	6.1	42.5	74.0	-31.5	Peak	Horizontal
	7315.5	37.5	11.7	49.2	74.0	-24.8	Peak	Horizontal
*	8590.5	36.2	12.9	49.1	74.0	-24.9	Peak	Horizontal
*	9865.5	34.9	16.1	51.0	74.0	-23.0	Peak	Horizontal
	4765.5	37.8	5.4	43.2	74.0	-30.8	Peak	Vertical
	7324.0	37.2	11.7	48.9	74.0	-25.1	Peak	Vertical
*	8599.0	36.4	12.9	49.3	74.0	-24.7	Peak	Vertical
*	10256.5	35.6	16.5	52.1	74.0	-21.9	Peak	Vertical

Note 1: "\*" is not in restricted band, its limit is 20dBc of the fundamental emission level (93.4dBμV/m) or 15.209 which is higher.

Note 2: Measure Level (dBμV/m) = Reading Level (dBμV) + Factor (dB)

Factor (dB) = Cable Loss (dB) + Antenna Factor (dB/m) - Pre\_Amplifier Gain (dB)

Product	AirFinder Access Point	Temperature	26°C
Test Engineer	Dandy Li	Relative Humidity	56%
Test Site	AC1	Test Date	2019/08/06
Model No.	WF-402AP	Test Channel	39
Remark:	1. Average measurement was not performed if peak level lower than average limit. 2. Other frequency was 20dB below limit line within 1-18GHz, there is not show in the report.		

Mark	Frequency (MHz)	Reading Level (dBμV)	Factor (dB)	Measure Level (dBμV/m)	Limit (dBμV/m)	Margin (dB)	Detector	Polarization
	4808.0	37.9	5.6	43.5	74.0	-30.5	Peak	Horizontal
	7443.0	36.5	11.9	48.4	74.0	-25.6	Peak	Horizontal
*	8633.0	36.0	13.1	49.1	74.0	-24.9	Peak	Horizontal
*	9942.0	35.2	16.1	51.3	74.0	-22.7	Peak	Horizontal
	4017.5	38.9	2.5	41.4	74.0	-32.6	Peak	Vertical
	5012.0	37.4	6.1	43.5	74.0	-30.5	Peak	Vertical
*	7953.0	35.5	12.5	48.0	74.0	-26.0	Peak	Vertical
*	9738.0	35.4	15.7	51.1	74.0	-22.9	Peak	Vertical

Note 1: "\*" is not in restricted band, its limit is 20dBc of the fundamental emission level (93.8dBμV/m) or 15.209 which is higher.

Note 2: Measure Level (dBμV/m) = Reading Level (dBμV) + Factor (dB)

Factor (dB) = Cable Loss (dB) + Antenna Factor (dB/m) - Pre\_Amplifier Gain (dB)



**The worst case of Radiated Emission below 1GHz:**

Site: AC1	Time: 2019/08/16 - 10:50
Limit: FCC_Part15.209_RE(3m)	Engineer: Dandy Li
Probe: VULB 9168_20-2000MHz	Polarity: Horizontal
EUT: AirFinder Access Point	Power: DC 5V
<b>Worse Case Mode:</b> Transmit by BLE at channel 2402MHz	

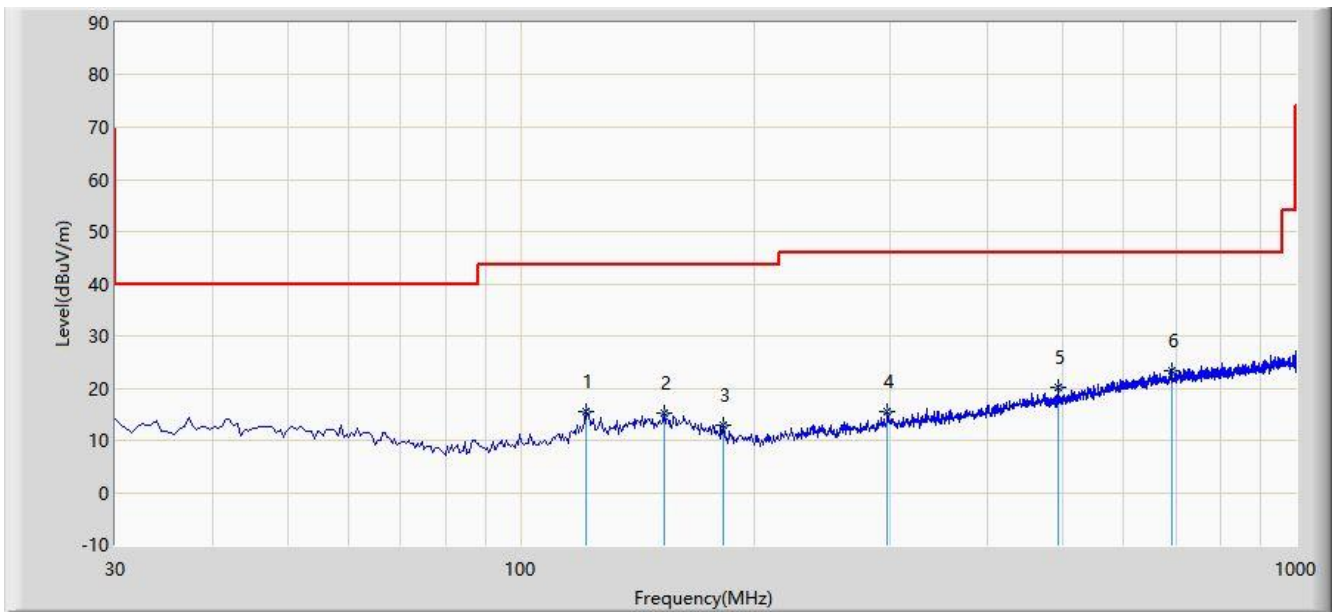

No	Flag	Mark	Frequency (MHz)	Measure Level (dBuV/m)	Reading Level (dBuV)	Margin (dB)	Limit (dBuV/m)	Factor (dB)	Type
1			121.620	15.451	2.010	-28.049	43.500	13.440	QP
2			153.220	15.147	-0.254	-28.353	43.500	15.401	QP
3			182.320	12.970	0.214	-30.530	43.500	12.756	QP
4			297.610	15.482	1.025	-30.518	46.000	14.457	QP
5			493.400	20.281	1.650	-25.719	46.000	18.631	QP
6		*	692.600	23.458	1.125	-22.542	46.000	22.332	QP

Note 1: Measure Level (dBuV/m) = Reading Level (dBuV) + Factor (dB)

Factor (dB) = Cable Loss (dB) + Antenna Factor (dB/m)

Note 2: The test trace is same as the ambient noise and the amplitude of the emissions are attenuated more than 20dB below the permissible (the test frequency range: 9kHz ~ 30MHz, 18GHz ~ 25GHz), therefore no data appear in the report.

Site: AC1	Time: 2019/08/16 - 10:54
Limit: FCC_Part15.209_RSE(3m)	Engineer: Dandy Li
Probe: VULB 9168_20-2000MHz	Polarity: Vertical
EUT: AirFinder Access Point	Power: DC 5V
<b>Worse Case Mode:</b> Transmit by BLE at channel 2402MHz	

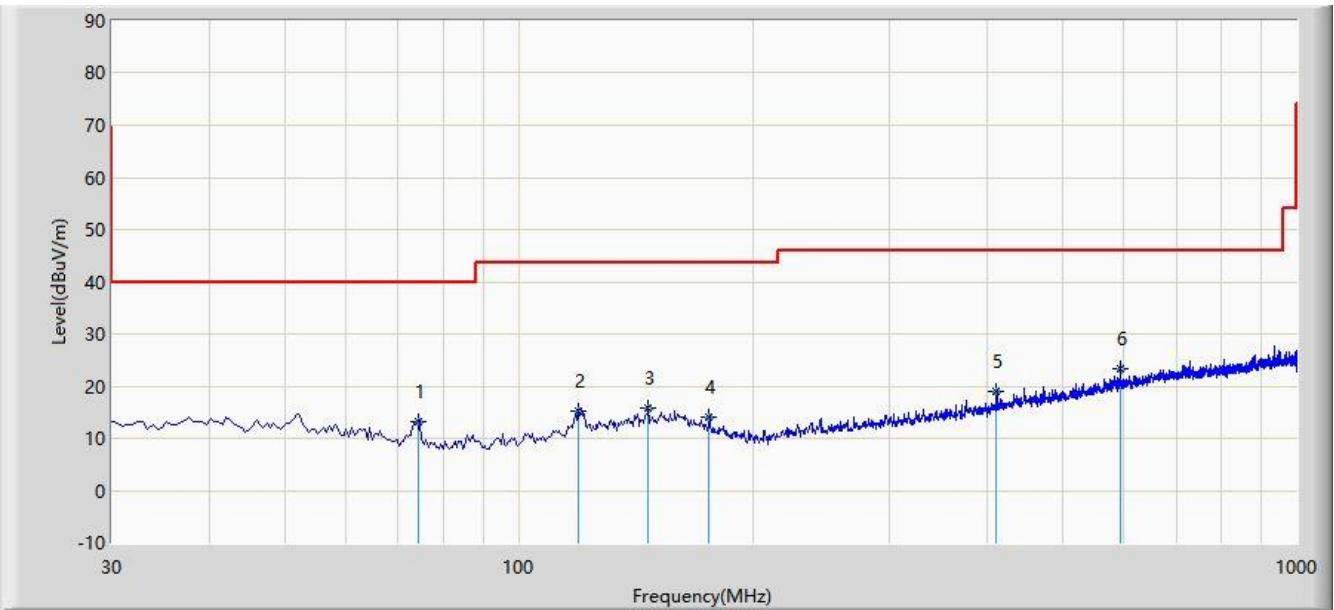

No	Flag	Mark	Frequency (MHz)	Measure Level (dBuV/m)	Reading Level (dBuV)	Margin (dB)	Limit (dBuV/m)	Factor (dB)	Type
1			74.310	13.174	2.140	-26.826	40.000	11.034	QP
2			119.340	15.284	2.030	-28.216	43.500	13.254	QP
3			146.640	15.903	0.743	-27.597	43.500	15.160	QP
4			175.300	14.118	0.399	-29.382	43.500	13.719	QP
5			411.210	18.994	1.950	-27.006	46.000	17.044	QP
6		*	594.456	23.450	2.650	-22.550	46.000	20.800	QP

Note 1: Measure Level (dB $\mu$ V/m) = Reading Level (dB $\mu$ V) + Factor (dB)

Factor (dB) = Cable Loss (dB) + Antenna Factor (dB/m)

Note 2: The test trace is same as the ambient noise and the amplitude of the emissions are attenuated more than 20dB below the permissible (the test frequency range: 9kHz ~ 30MHz, 18GHz ~ 25GHz), therefore no data appear in the report.

## 7.7. Radiated Restricted Band Edge Measurement

### 7.7.1. Test Limit

#### **For 15.205 requirement:**

Radiated emissions which fall in the restricted bands, as defined in Section 15.205(a) of FCC part 15, must also comply with the radiated emission limits specified in Section 15.209(a).

Frequency (MHz)	Frequency (MHz)	Frequency (MHz)	Frequency (GHz)
0.090 - 0.110	16.42 - 16.423	399.9 - 410	4.5 - 5.15
<sup>1</sup> 0.495 - 0.505	16.69475 - 16.69525	608 - 614	5.35 - 5.46
2.1735 - 2.1905	16.80425 - 16.80475	960 - 1240	7.25 - 7.75
4.125 - 4.128	25.5 - 25.67	1300 - 1427	8.25 - 8.5
4.17725 - 4.17775	37.5 - 38.25	1435 - 1626.5	9.0 - 9.2
4.20725 - 4.20775	73 - 74.6	1645.5 - 1646.5	9.3 - 9.5
6.215 - 6.218	74.8 - 75.2	1660 - 1710	10.6 - 12.7
6.26775 - 6.26825	108 - 121.94	1718.8 - 1722.2	13.25 - 13.4
6.31175 - 6.31225	123 - 138	2200 - 2300	14.47 - 14.5
8.291 - 8.294	149.9 - 150.05	2310 - 2390	15.35 - 16.2
8.362 - 8.366	156.52475 - 156.525	2483.5 - 2500	17.7 - 21.4
8.37625 - 8.38675	156.7 - 156.9	2690 - 2900	22.01 - 23.12
8.41425 - 8.41475	162.0125 - 167.17	3260 - 3267	23.6 - 24.0
12.29 - 12.293	167.72 - 173.2	3332 - 3339	31.2 - 31.8
12.51975 - 12.52025	240 - 285	3345.8 - 3358	36.43 - 36.5
12.57675 - 12.57725	322 - 335.4	3600 - 4400	( <sup>2</sup> )
13.36 - 13.41	--	--	--

All out of band emissions appearing in a restricted band as specified in Section 15.205 of the Title 47CFR must not exceed the limits shown in Table per Section 15.209.

FCC Part 15 Subpart C Paragraph 15.209		
Frequency (MHz)	Field Strength (uV/m)	Measured Distance (Meters)
0.009 - 0.490	2400/F (kHz)	300
0.490 - 1.705	24000/F (kHz)	30
1.705 - 30	30	30
30 - 88	100	3
88 - 216	150	3
216 - 960	200	3
Above 960	500	3

### 7.7.2. Test Procedure Used

ANSI C63.10 Section 6.3 (General Requirements)

ANSI C63.10 Section 6.6 (Standard test method above 1GHz)

### 7.7.3. Test Setting

#### Peak Field Strength Measurements

1. Analyzer center frequency was set to the frequency of the radiated spurious emission of interest
2. RBW = 1MHz
3. VBW = 3MHz
4. Detector = peak
5. Sweep time = auto couple
6. Trace mode = max hold
7. Trace was allowed to stabilize

### Average Field Strength Measurements

1. Analyzer center frequency was set to the frequency of the radiated spurious emission of interest
2. RBW = 1MHz
3. VBW  $\geq 1/T$
4. De As an alternative, the instrument may be set to linear detector mode. Ensure that video filtering is applied in linear voltage domain (rather than in a log or dB domain). Some instruments require linear display mode in order to accomplish this. Others have a setting for Average-VBW Type, which can be set to "Voltage" regardless of the display mode
5. Detector = Peak
6. Sweep time = auto
7. Trace mode = max hold
8. Allow max hold to run for at least 50 times (1/duty cycle) traces

#### 7.7.4. Test Setup

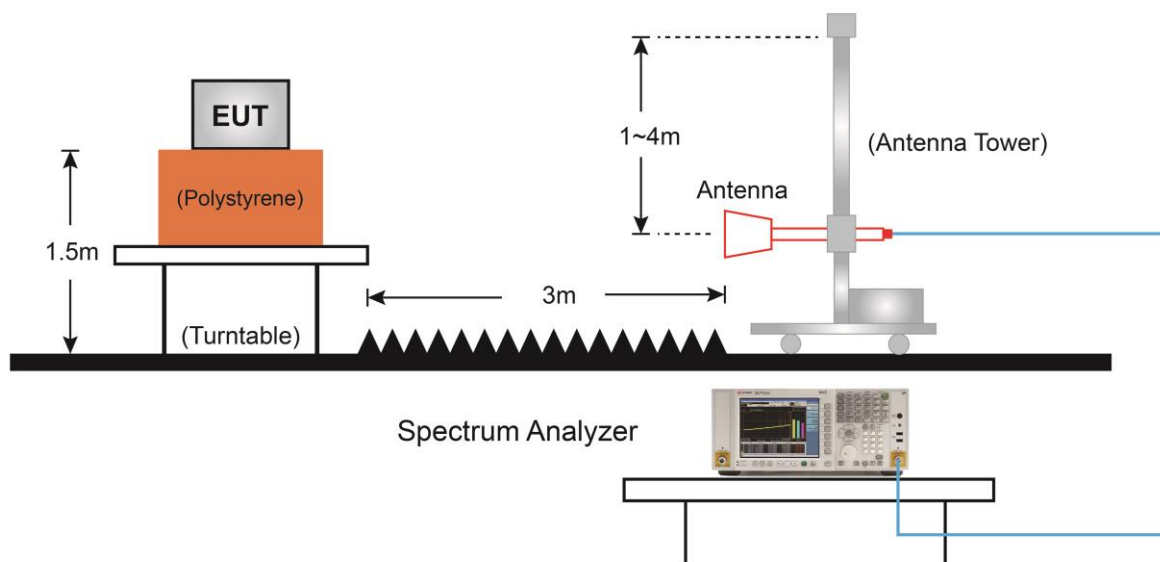

### 7.7.5. Test Result

Site: AC1	Time: 2019/08/06 - 19:03
Limit: FCC_Part15.209_RE(3m)	Engineer: Dandy Li
Probe: BBHA9120D_1-18GHz	Polarity: Horizontal
EUT: AirFinder Access Point	Power: DC 5V
Note: Transmit by BLE at channel 2402MHz	

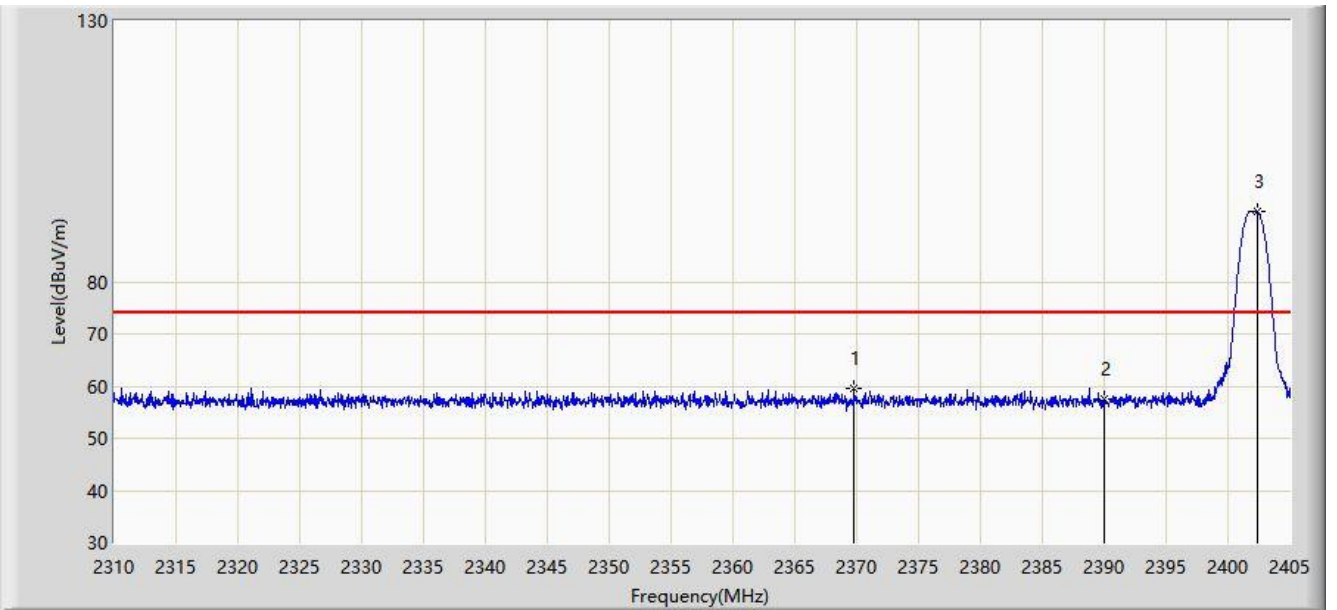

No	Flag	Mark	Frequency (MHz)	Measure Level (dBuV/m)	Reading Level (dBuV)	Margin (dB)	Limit (dBuV/m)	Factor (dB)	Type
1			2369.802	59.664	27.211	-14.336	74.000	32.452	PK
2			2390.000	57.409	24.996	-16.591	74.000	32.413	PK
3		*	2402.340	93.448	61.052	N/A	N/A	32.396	PK

Note: Measure Level (dB $\mu$ V/m) = Reading Level (dB $\mu$ V) + Factor (dB)

Factor (dB) = Cable Loss (dB) + Antenna Factor (dB/m)

Site: AC1	Time: 2019/08/06 - 19:10
Limit: FCC_Part15.209_RE(3m)	Engineer: Dandy Li
Probe: BBHA9120D_1-18GHz	Polarity: Horizontal
EUT: AirFinder Access Point	Power: DC 5V
Note: Transmit by BLE at channel 2402MHz	

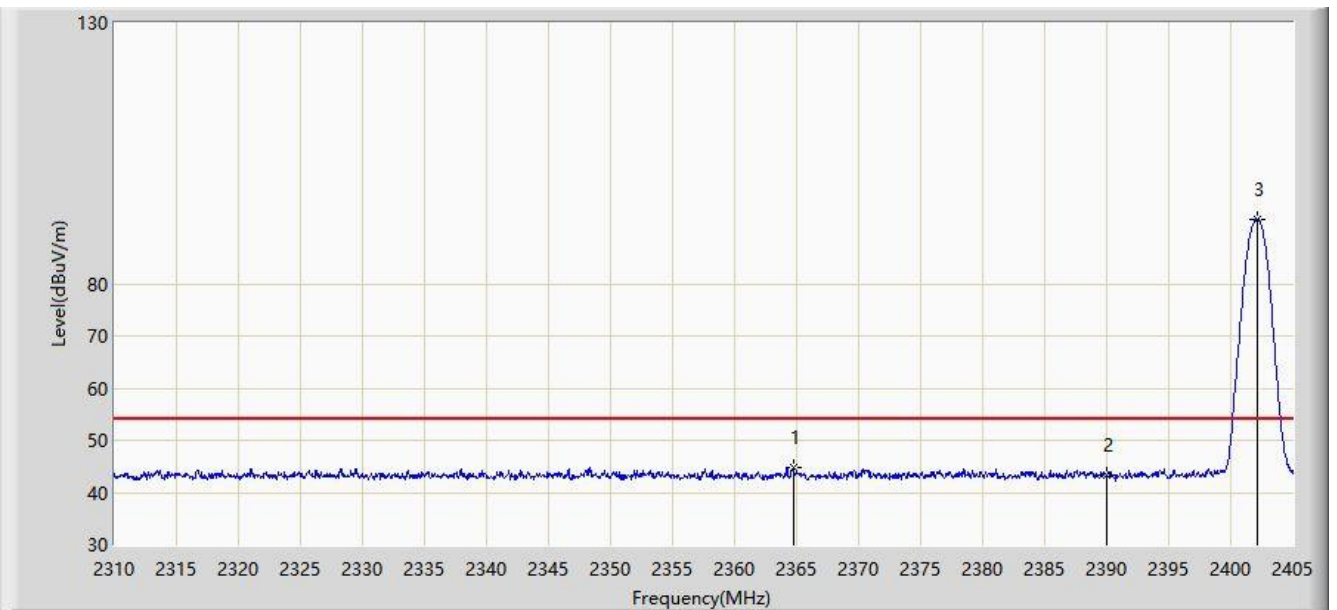

No	Flag	Mark	Frequency (MHz)	Measure Level (dBuV/m)	Reading Level (dBuV)	Margin (dB)	Limit (dBuV/m)	Factor (dB)	Type
1			2364.768	44.893	12.429	-9.107	54.000	32.464	AV
2			2390.000	43.369	10.956	-10.631	54.000	32.413	AV
3		*	2402.102	92.446	60.050	N/A	N/A	32.395	AV

Note: Measure Level (dB $\mu$ V/m) = Reading Level (dB $\mu$ V) + Factor (dB)

Factor (dB) = Cable Loss (dB) + Antenna Factor (dB/m)

Site: AC1	Time: 2019/08/06 - 19:11
Limit: FCC_Part15.209_RE(3m)	Engineer: Dandy Li
Probe: BBHA9120D_1-18GHz	Polarity: Vertical
EUT: AirFinder Access Point	Power: DC 5V
Note: Transmit by BLE at channel 2402MHz	

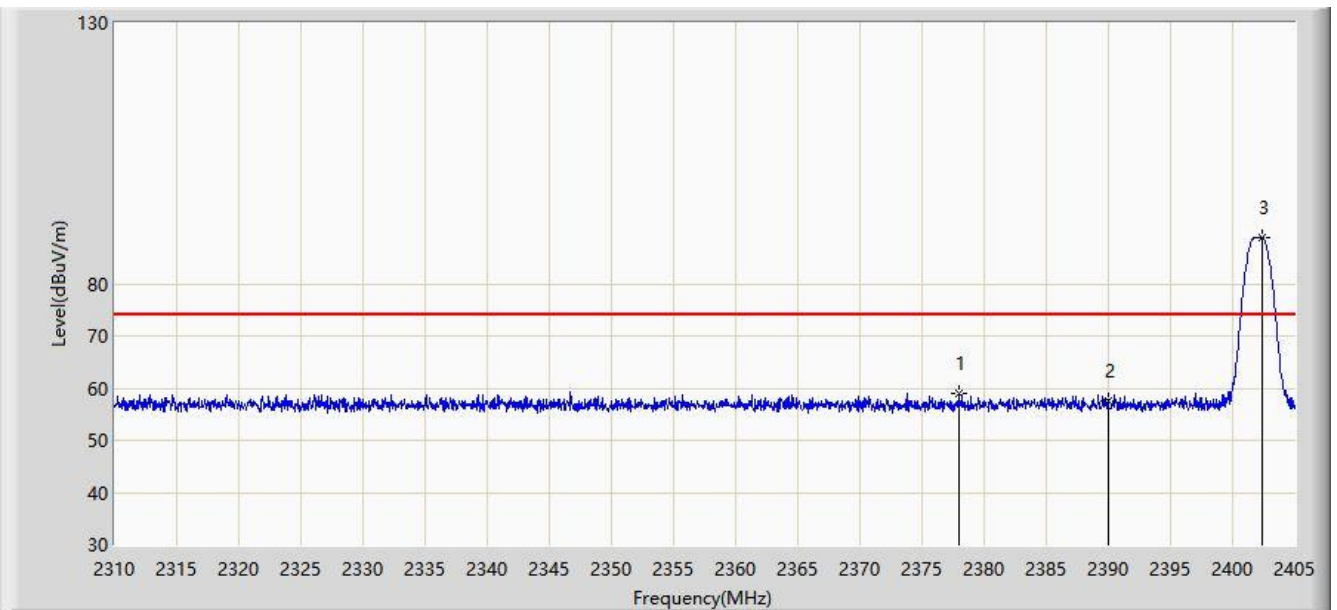

No	Flag	Mark	Frequency (MHz)	Measure Level (dBuV/m)	Reading Level (dBuV)	Margin (dB)	Limit (dBuV/m)	Factor (dB)	Type
1			2377.925	58.902	26.467	-15.098	74.000	32.435	PK
2			2390.000	57.484	25.071	-16.516	74.000	32.413	PK
3		*	2402.387	88.957	56.561	N/A	N/A	32.396	PK

Note: Measure Level (dB $\mu$ V/m) = Reading Level (dB $\mu$ V) + Factor (dB)

Factor (dB) = Cable Loss (dB) + Antenna Factor (dB/m)



Site: AC1	Time: 2019/08/06 - 19:13
Limit: FCC_Part15.209_RE(3m)	Engineer: Dandy Li
Probe: BBHA9120D_1-18GHz	Polarity: Vertical
EUT: AirFinder Access Point	Power: DC 5V
Note: Transmit by BLE at channel 2402MHz	

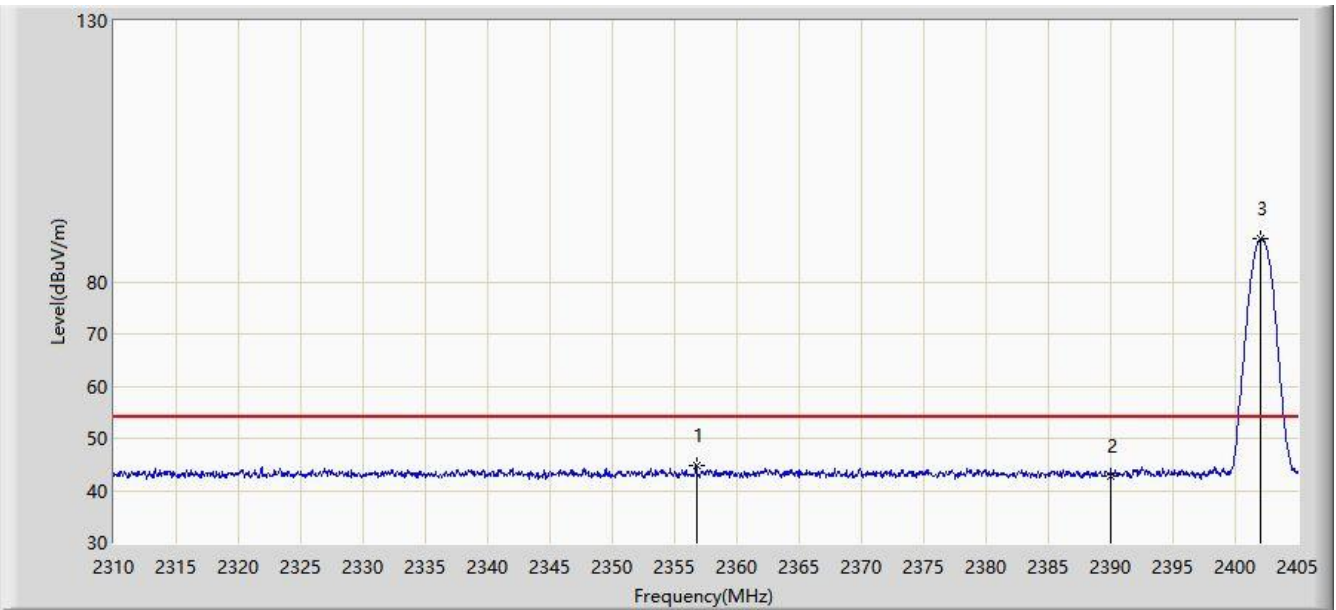

No	Flag	Mark	Frequency (MHz)	Measure Level (dBuV/m)	Reading Level (dBuV)	Margin (dB)	Limit (dBuV/m)	Factor (dB)	Type
1			2356.740	44.922	12.438	-9.078	54.000	32.485	AV
2			2390.000	42.858	10.445	-11.142	54.000	32.413	AV
3		*	2402.055	88.281	55.885	N/A	N/A	32.395	AV

Note: Measure Level (dBμV/m) = Reading Level (dBμV) + Factor (dB)

Factor (dB) = Cable Loss (dB) + Antenna Factor (dB/m)

Site: AC1	Time: 2019/08/06 - 19:13
Limit: FCC_Part15.209_RE(3m)	Engineer: Dandy Li
Probe: BBHA9120D_1-18GHz	Polarity: Horizontal
EUT: AirFinder Access Point	Power: DC 5V
Note: Transmit by BLE at channel 2480MHz	

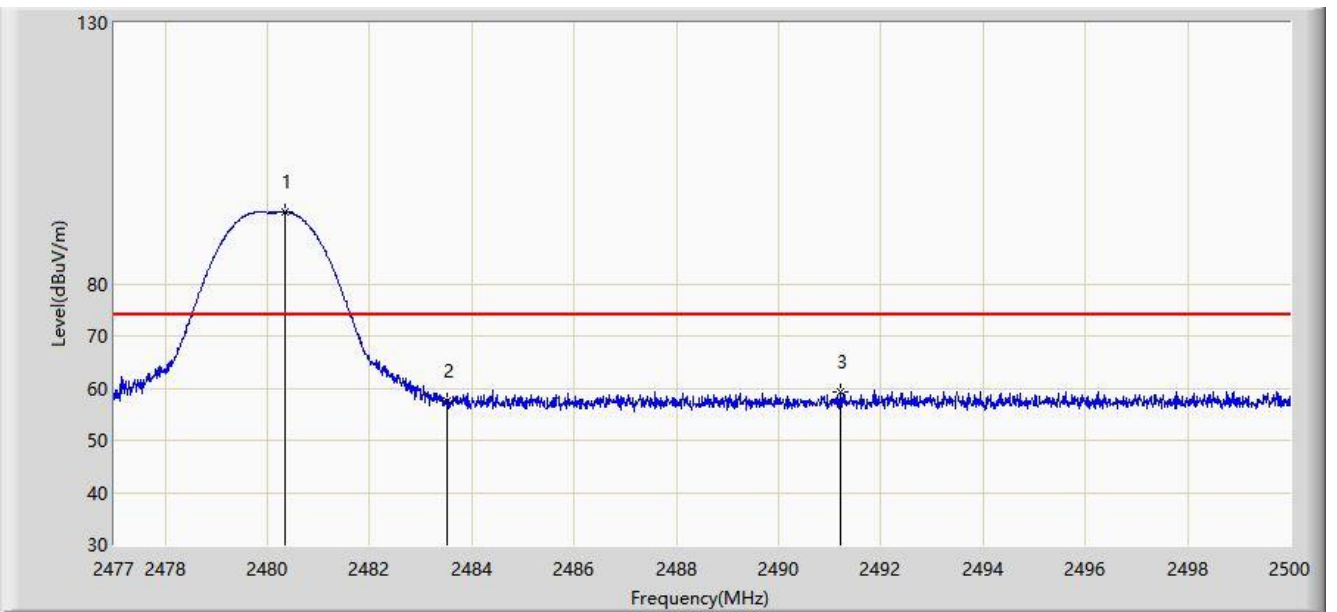

No	Flag	Mark	Frequency (MHz)	Measure Level (dBuV/m)	Reading Level (dBuV)	Margin (dB)	Limit (dBuV/m)	Factor (dB)	Type
1		*	2480.347	93.767	61.358	N/A	N/A	32.409	PK
2			2483.500	57.531	25.116	-16.469	74.000	32.416	PK
3			2491.214	59.396	26.965	-14.604	74.000	32.431	PK

Note: Measure Level (dB $\mu$ V/m) = Reading Level (dB $\mu$ V) + Factor (dB)

Factor (dB) = Cable Loss (dB) + Antenna Factor (dB/m)

Site: AC1	Time: 2019/08/06 - 19:16
Limit: FCC_Part15.209_RE(3m)	Engineer: Dandy Li
Probe: BBHA9120D_1-18GHz	Polarity: Horizontal
EUT: AirFinder Access Point	Power: DC 5V
Note: Transmit by BLE at channel 2480MHz	

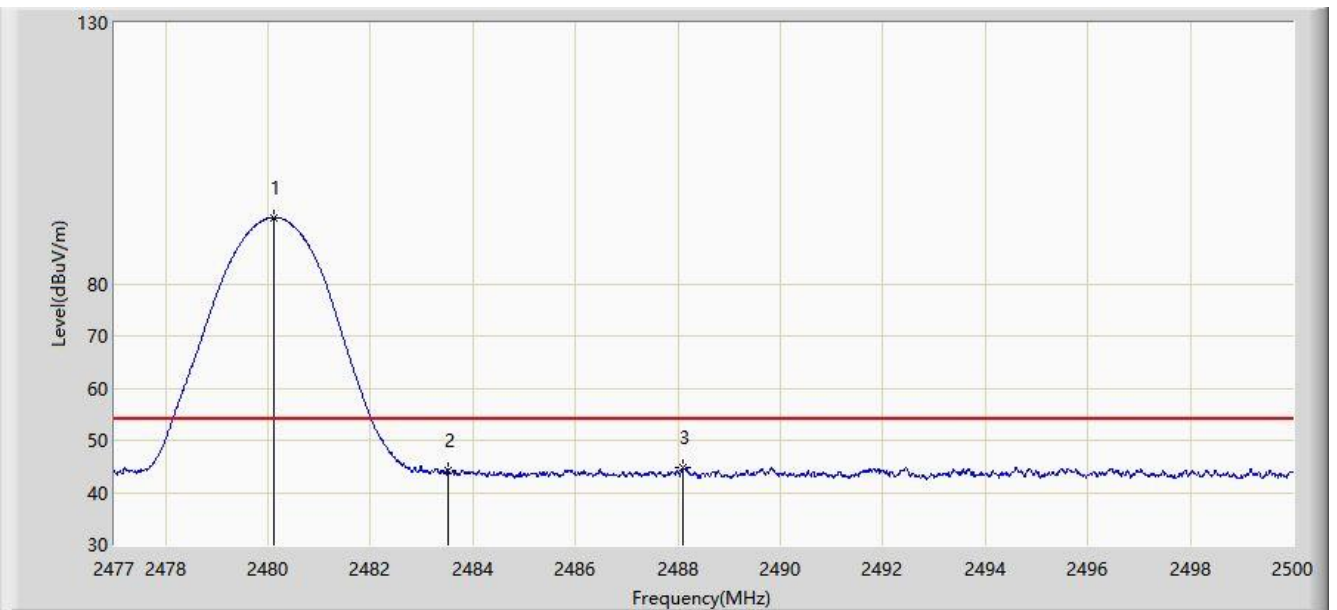

No	Flag	Mark	Frequency (MHz)	Measure Level (dBuV/m)	Reading Level (dBuV)	Margin (dB)	Limit (dBuV/m)	Factor (dB)	Type
1		*	2480.117	92.718	60.309	N/A	N/A	32.408	AV
2			2483.500	44.205	11.790	-9.795	54.000	32.416	AV
3			2488.109	44.836	12.411	-9.164	54.000	32.425	AV

Note: Measure Level (dB $\mu$ V/m) = Reading Level (dB $\mu$ V) + Factor (dB)

Factor (dB) = Cable Loss (dB) + Antenna Factor (dB/m)

Site: AC1	Time: 2019/08/06 - 19:16
Limit: FCC_Part15.209_RE(3m)	Engineer: Dandy Li
Probe: BBHA9120D_1-18GHz	Polarity: Vertical
EUT: AirFinder Access Point	Power: DC 5V
Note: Transmit by BLE at channel 2480MHz	

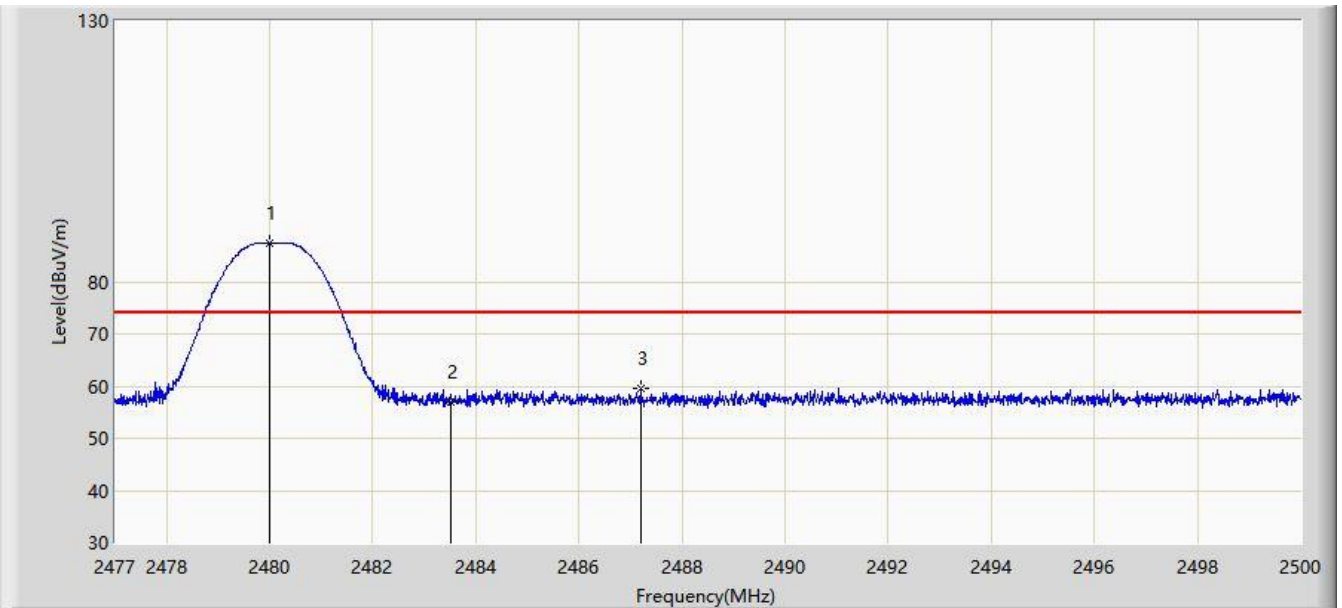

No	Flag	Mark	Frequency (MHz)	Measure Level (dBuV/m)	Reading Level (dBuV)	Margin (dB)	Limit (dBuV/m)	Factor (dB)	Type
1		*	2479.990	87.502	55.094	N/A	N/A	32.408	PK
2			2483.500	56.838	24.423	-17.162	74.000	32.416	PK
3			2487.200	59.689	27.266	-14.311	74.000	32.422	PK

Note: Measure Level (dB $\mu$ V/m) = Reading Level (dB $\mu$ V) + Factor (dB)

Factor (dB) = Cable Loss (dB) + Antenna Factor (dB/m)

Site: AC1	Time: 2019/08/06 - 19:18
Limit: FCC_Part15.209_RE(3m)	Engineer: Dandy Li
Probe: BBHA9120D_1-18GHz	Polarity: Vertical
EUT: AirFinder Access Point	Power: DC 5V
Note: Transmit by BLE at channel 2480MHz	

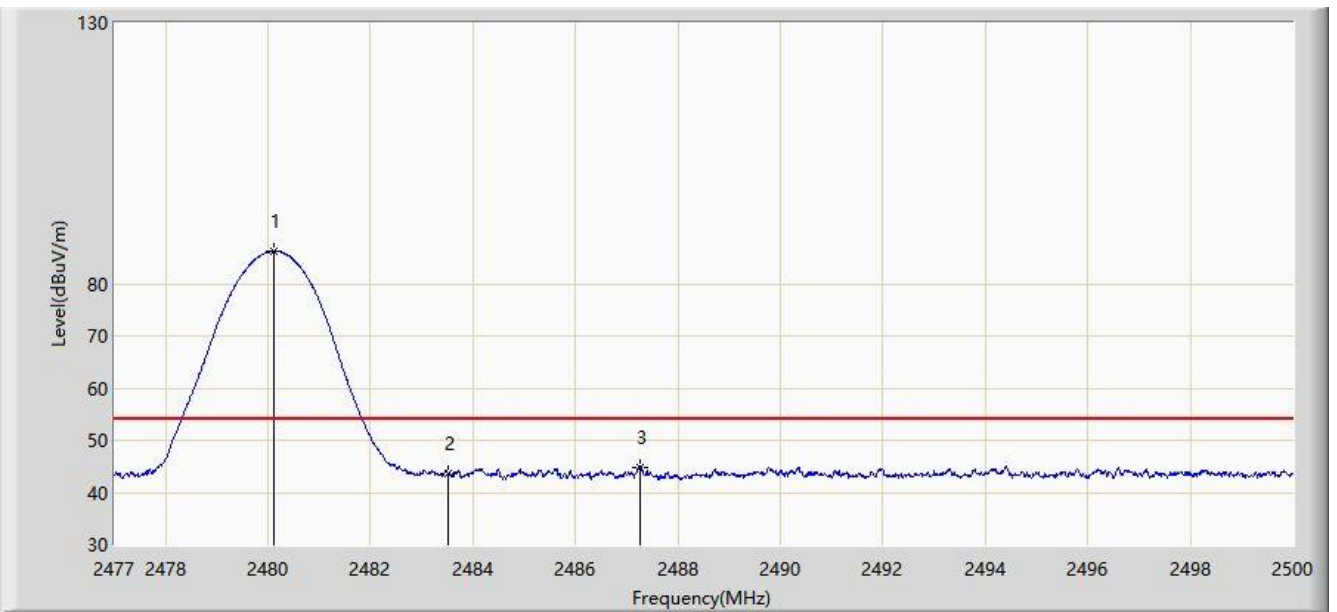

No	Flag	Mark	Frequency (MHz)	Measure Level (dBuV/m)	Reading Level (dBuV)	Margin (dB)	Limit (dBuV/m)	Factor (dB)	Type
1		*	2480.105	86.239	53.830	N/A	N/A	32.408	AV
2			2483.500	43.768	11.353	-10.232	54.000	32.416	AV
3			2487.258	44.755	12.332	-9.245	54.000	32.422	AV

Note: Measure Level (dB $\mu$ V/m) = Reading Level (dB $\mu$ V) + Factor (dB)

Factor (dB) = Cable Loss (dB) + Antenna Factor (dB/m)

## 7.8. AC Conducted Emissions Measurement

### 7.8.1. Test Limit

FCC Part 15.107		
Frequency (MHz)	QP (dB $\mu$ V)	AV (dB $\mu$ V)
0.15 ~ 0.50	66 ~ 56	56 ~ 46
0.50 ~ 5.0	56	46
5.0 ~ 30	60	50

Note 1: The lower limit shall apply at the transition frequencies.

Note 2: The limit decreases linearly with the logarithm of the frequency in the range 0.15MHz to 0.5MHz.

### 7.8.2. Test Setup

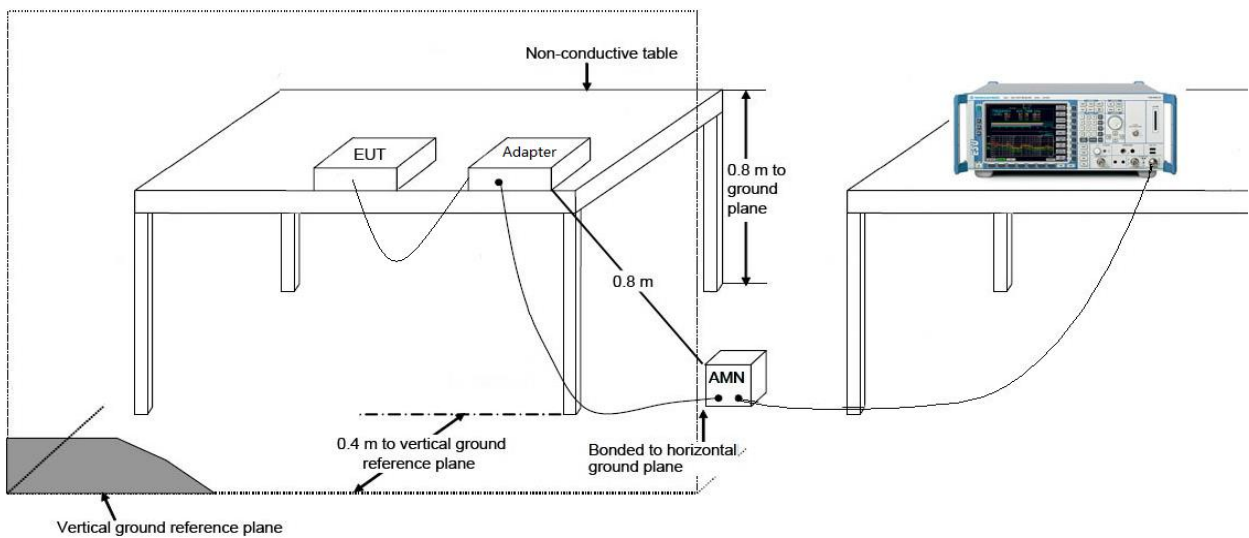

### 7.8.3. Test Result

The EUT is powered by DC Source, so this requirement doesn't apply.

## 8. CONCLUSION

The data collected relate only the item(s) tested and show that the unit is compliance with Part 15C of the FCC rules.

\_\_\_\_\_ The End \_\_\_\_\_

## **Appendix A – Test Setup Photograph**

Refer to “1907RSU055-UT” file.



## **Appendix B – EUT Photograph**

Refer to “1907RSU055-UE” file.