

---

# FCC Test Report

---

Report No.: AGC21D120802-2F2

**FCC ID** : SF4-RK300  
**PRODUCT DESIGNATION** : Bluetooth headset  
**BRAND NAME** : N/A  
**MODEL NAME** : RK300  
**CLIENT** : ATI Electronics (Shenzhen) Co.Ltd  
**DATE OF ISSUE** : Sep.10, 2012  
**STANDARD(S)** : FCC Part 15 Rules  
**REPORT VERSION** : V1.0

**Attestation of Global Compliance (Shenzhen) Co., Ltd.**

CAUTION: This report shall not be reproduced except in full without the written permission of the test laboratory and shall not be quoted out of context.

## VERIFICATION OF COMPLIANCE

Applicant	ATI Electronics (Shenzhen) Co.Ltd
	2/F, A Tower, Tangyanshan Industrial Park Tangkeng Village, Shiyan Town, Shenzhen, China
Manufacturer	ATI Electronics (Shenzhen) Co.Ltd
	2/F, A Tower, Tangyanshan Industrial Park Tangkeng Village, Shiyan Town, Shenzhen, China
Product Designation	Bluetooth headset
Brand Name	N/A
Model Name	RK300
FCC ID	<b>SF4-RK300</b>
Report Number	AGC21D120802-2F2
Date of Test	Aug.31, 2012 to Sep.08, 2012

### WE HEREBY CERTIFY THAT:

The above equipment was tested by Attestation of Global Compliance (Shenzhen) Co., Ltd. The test data, data evaluation, test procedures, and equipment configurations shown in this report were made in accordance with the procedures given in ANSI C63.4 (2003) and the energy emitted by the sample EUT tested as described in this report is in compliance with radiated emission limits of FCC Rules Part 15.247.

  
Tested By: \_\_\_\_\_  
Bart Xie                      Sep.10, 2012

  
Reviewed By: \_\_\_\_\_  
Forrest Lei                      Sep.10, 2012

  
Approved By: \_\_\_\_\_  
Solger Zhang                      Sep.10, 2012

## TABLE OF CONTENTS

1. GENERAL INFORMATION.....	4
1.1 PRODUCT DESCRIPTION.....	4
1.2 TABLE OF CARRIER FREQUENCIES.....	4
1.3 RECEIVER INPUT BANDWIDTH.....	5
1.4 EXAMPLE OF A HOPPING SEQUENCY IN DATA MODE.....	6
1.5 EQUALLY AVERAGE USE OF FREQUENCIES AND BEHAVIOUR.....	6
1.6 RELATED SUBMITTAL(S) / GRANT (S).....	6
1.7 TEST METHODOLOGY.....	6
1.8 MEASUREMENT UNCERTAINTY.....	6
1.9 TEST FACILITY.....	7
1.10 SPECIAL ACCESSORIES.....	7
1.11 EQUIPMENT MODIFICATIONS.....	7
2. SYSTEM TEST CONFIGURATION.....	8
2.1 CONFIGURATION OF TESTED SYSTEM.....	8
2.2 EQUIPMENT USED IN EUT SYSTEM.....	8
3. SUMMARY OF TEST RESULTS.....	9
4. DESCRIPTION OF TEST MODES.....	9
5. PEAK OUTPUT POWER.....	10
5.1 MEASUREMENT PROCEDURE.....	10
5.2 TEST SET-UP (BLOCK DIAGRAM OF CONFIGURATION).....	10
5.3 MEASUREMENT EQUIPMENT USED.....	11
5.4 LIMITS AND MEASUREMENT RESULT.....	11
6. 20 DB BANDWIDTH.....	12
6.1 MEASUREMENT PROCEDURE.....	12
6.2 TEST SET-UP (BLOCK DIAGRAM OF CONFIGURATION).....	12
6.3 MEASUREMENT EQUIPMENT USED.....	12
6.4 LIMITS AND MEASUREMENT RESULTS.....	12
7. CONDUCTED SPURIOUS EMISSION.....	15
7.1 MEASUREMENT PROCEDURE.....	15
7.2 TEST SET-UP (BLOCK DIAGRAM OF CONFIGURATION).....	15
7.3 MEASUREMENT EQUIPMENT USED.....	15
7.4 LIMITS AND MEASUREMENT RESULT.....	15
8. RADIATED EMISSION.....	17
8.1 MEASUREMENT PROCEDURE.....	17
8.2 TEST SETUP.....	18
8.3 TEST EQUIPMENT LIST.....	19
8.4 TEST RESULT.....	20
9. BAND EDGES EMISSION.....	24
9.1 MEASUREMENT PROCEDURE.....	24
9.2 TEST SET-UP.....	24
9.3 TEST RESULT.....	24
10. NUMBER OF HOPPING FREQUENCY.....	28
10.1 MEASUREMENT PROCEDURE.....	28

10.2 TEST SETUP (BLOCK DIAGRAM OF CONFIGURATION).....	28
10.3 MEASUREMENT EQUIPMENT USED.....	28
10.4 LIMITS AND MEASUREMENT RESULT .....	28
11. TIME OF OCCUPANCY (DWELL TIME).....	29
11.1 MEASUREMENT PROCEDURE .....	29
11.2 TEST SETUP (BLOCK DIAGRAM OF CONFIGURATION).....	29
11.3 MEASUREMENT EQUIPMENT USED.....	29
11.4 LIMITS AND MEASUREMENT RESULT.....	29
12. FREQUENCY SEPARATION.....	32
12.1 MEASUREMENT PROCEDURE.....	32
12.2 TEST SETUP (BLOCK DIAGRAM OF CONFIGURATION).....	32
12.3 MEASUREMENT EQUIPMENT USED.....	32
12.4 LIMITS AND MEASUREMENT RESULT .....	32
13. CONDUCTED EMISSION.....	33
13.1 LIMITS OF LINE CONDUCTED EMISSION TEST .....	33
13.2 BLOCK DIAGRAM OF LINE CONDUCTED EMISSION TEST .....	33
13.3 PROCEDURE OF LINE CONDUCTED EMISSION TEST .....	34
13.4 TEST RESULT OF LINE CONDUCTED EMISSION TEST .....	35
APPENDIX I.....	37
PHOTOGRAPHS OF THE EUT .....	37
APPENDIX II.....	43
PHOTOGRAPHS OF THE TEST SETUP .....	43

## 1. GENERAL INFORMATION

### 1.1 PRODUCT DESCRIPTION

The EUT is a **Bluetooth headset** with microphone designed as a “Communication Device”. It is designed by way of utilizing the FHSS technology to achieve the system operation.

A major technical description of EUT is described as following:

Operation Frequency	2.402 GHz to 2.480GHz
Max. Output Power	3.87dBm for GFSK modulation
Bluetooth Version	V3.0
Modulation	GFSK, $\pi/4$ -DQPSK, 8DPSK
Number of channels	79
Antenna Designation	Integrated Antenna
Antenna Gain	0.8dBi
Hardware Version	B04 V3.0
Software Version	RK300 V1.0
Power Supply	DC3.7V by Built-in Li-ion Battery

### 1.2 TABLE OF CARRIER FREQUENCIES

Frequency Band	Channel Number	Frequency
2400~2483.5MHZ	0	2402MHZ
	1	2403MHZ
	:	:
	38	2440 MHZ
	39	2441 MHZ
	40	2442 MHZ
	:	:
	77	2479 MHZ
	78	2480 MHZ

### 1.3 RECEIVER INPUT BANDWIDTH

The input bandwidth of the receiver is 1.3 MHz. In every connection one Bluetooth device is the master and the other one is slave. The master determines the hopping sequence. The slave follows this sequence. Both devices shift between RX and TX time slot according to the clock of the master. Additionally the type of connection (e.g. single or multisport (packet)) is set up at the beginning of the connection. The master adapts its hopping frequency and its TX/RX timing according to the packet type of the connection. Also the slave of the connection will use these settings.

Repeating of a packet has no influence on the hopping sequence. The hopping sequence generated by the master of the connection will be followed in any case. That means, a repeated packet will not be sent on the same frequency, it is sent on the next frequency of the hopping sequence.

#### 1.4 EXAMPLE OF A HOPPING SEQUENCY IN DATA MODE

Example of a 79 hopping sequence in data mode:  
40,21,44,23,42,53,46,55,48,33,52,35,50,65,54,67  
56,37,60,39,58,69,62,71,64,25,68,27,66,57,70,59  
72,29,76,31,74,61,78,63,01,41,05,43,03,73,07,75  
09,45,13,47,11,77,15,00,64,49,66,53,68,02,70,06  
01,51,03,55,05,04

#### 1.5 EQUALLY AVERAGE USE OF FREQUENCIES AND BEHAVIOUR

The generation of the hopping sequence in connection mode depends essentially on two input values:

1 LAP/UAP of the master of the connection

2 Internal master clock

The LAP(lower address part) are the 24 LSB's of the 48 BD\_ADDRESS. The BD\_ADDRESS is an unambiguous number of every Bluetooth unit. The UAP(upper address part) are the 24MSB's of the 48BD\_ADDRESS

The internal clock of a Bluetooth unit is derived from a free running clock which is never adjusted and is never turned off. For synchronization with other units only offset are used. It has no relation to the time of the day. Its resolution is at least half the RX/TX slot length of 312.5us. The clock has a cycle of about One day(23h30). In most case it is implemented as 28 bit counter. For the deriving of the hopping sequence the entire.

LAP(24 bits),4LSB's(4bits)(Input 1) and the 27MSB's of the clock(Input 2) are used. With this input values different mathematical procedures(permutations, additions, XOR-operations)are performed to generate te Sequence. This will be done at the beginning of every new transmission.

Regarding short transmissions the Bluetooth system has the following behavior:

The first connection between the two devices is established, a hopping sequence was generated. For Transmitting the wanted data the complete hopping sequence was not used. The connection ended.

The second connection will be established. A new hopping sequence is generated. Due to the fact the Bluetooth clock has a different value, because the period between the two transmission is longer(and it Cannot be shorter)than the minimum resolution of the clock(312.5us).The hopping sequence will always Differ from the first one.

#### 1.6 RELATED SUBMITTAL(S) / GRANT (S)

This submittal(s) (test report) is intended for **FCC ID: SF4-RK300**, filing to comply with Section 15.247 of the FCC Part 15, Subpart C Rules.

#### 1.7 TEST METHODOLOGY

Both conducted and radiated testing were performed according to the procedures in ANSI C63.4 (2003). Radiated testing was performed at an antenna to EUT distance 3 meters.

#### 1.8 MEASUREMENT UNCERTAINTY

The uncertainty is calculated using the methods suggested in the "Guide to the Expression of Uncertainty in Measurement" (GUM) published by ISO.

- Uncertainty of Conducted Emission,  $U_c = \pm 2.75\text{dB}$
- Uncertainty of Radiated Emission,  $U_c = \pm 3.2\text{dB}$

## **1.9 TEST FACILITY**

All measurement facilities used to collect the measurement data are located at  
Attestation of Global Compliance (Shenzhen) Co., Ltd.

2/F., Building 2, No.1-No.4, Chaxi Sanwei Technical Industrial Park, Gushu, Xixiang, Bao'an District, Shenzhen,  
Guangdong, China

The test site is constructed and calibrated to meet the FCC requirements in documents ANSI C63.4: 2003.  
FCC register No.: 259865

## **1.10 SPECIAL ACCESSORIES**

Refer to section 2.2.

## **1.11 EQUIPMENT MODIFICATIONS**

Not available for this EUT intended for grant.



## 2. SYSTEM TEST CONFIGURATION

### 2.1 CONFIGURATION OF TESTED SYSTEM

**Configure 1** (Normal Hopping mode)

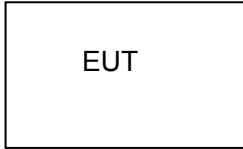

**Configure 2** (Control continuous TX through PC)

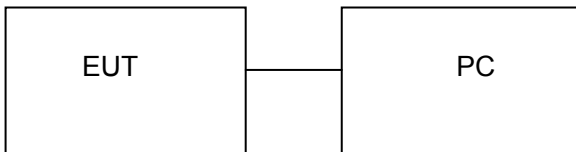

*Note: All the accessories have been used during the test.*

### 2.2 EQUIPMENT USED IN EUT SYSTEM

Item	Equipment	Mfr/Brand	Model/Type No.	Remark
1	Bluetooth headset	N/A	RK300	EUT
2	PC	DELL	INSPIRON	A.E

### 3. SUMMARY OF TEST RESULTS

FCC RULES	DESCRIPTION OF TEST	RESULT
§15.247	Peak Output Power	Compliant
§15.247	20 dB Bandwidth	Compliant
§15.247	Conducted Spurious Emission	Compliant
§15.207	Conduction Emission	Compliant
§15.209	Radiated Emission	Compliant
§15.247	Band Edges	Compliant
§15.247	Number of Hopping Frequency	Compliant
§15.247	Time of Occupancy	Compliant
§15.247	Frequency Separation	Compliant

**\*\*\*Note:** The EUT can work normally when charging. The USB port only used for charging and can't be used to transfer data with PC.

### 4. DESCRIPTION OF TEST MODES

The EUT has been operated in three modulations: GFSK,  $\pi/4$ -DQPSK, 8-DPSK independently. The following operating modes were applied for the related test items. All 3axis have been tested.

No.	TEST MODES
1	Low Channel(TX)
2	Middle Channel(TX)
3	High Channel(TX)
4	Normal Hopping

**\*\*\*Note:** All the test modes were tested, and the battery is fulfilled, only the result of the worst case was recorded in the report.

## 5. PEAK OUTPUT POWER

### 5.1 MEASUREMENT PROCEDURE

1. The EUT was placed on a turn table which is 0.8m above ground plane.
2. Connect EUT RF output port to the Spectrum Analyzer.
3. Set the EUT Work on the top, the middle and the bottom operation frequency individually.

### 5.2 TEST SET-UP (BLOCK DIAGRAM OF CONFIGURATION)

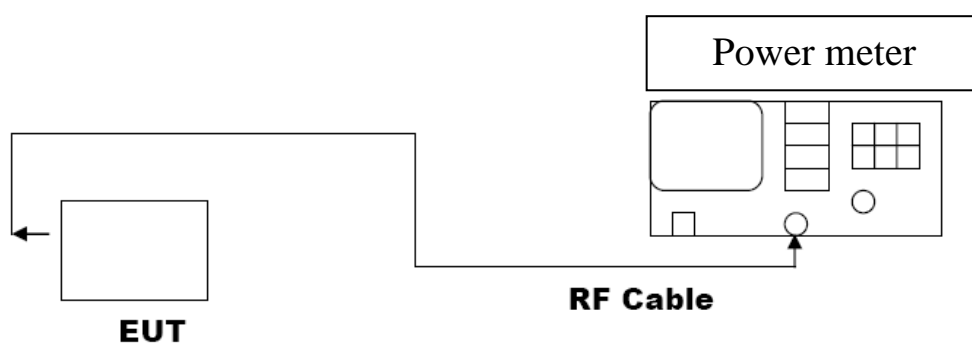

### 5.3 MEASUREMENT EQUIPMENT USED

Description	Manufacturer	Model	SERIAL NUMBER	Cal. Date	Cal. Due
Power meter	R&S	NRP-Z23	N/A	07/18/2012	07/17/2013

### 5.4 LIMITS AND MEASUREMENT RESULT

PEAK OUTPUT POWER MEASUREMENT RESULT FOR GFSK MODULATION			
Frequency (GHz)	Result (dBm)	Applicable Limits (dBm)	Pass or Fail
2.402	3.87	30	Pass
2.441	3.69	30	Pass
2.480	3.66	30	Pass

PEAK OUTPUT POWER MEASUREMENT RESULT FOR $\pi/4$ -DQPSK, 8DPSK MODULATION				
Frequency (GHz)	Test Result 2 Mbps (dBm)	Test Result 3 Mbps (dBm)	Applicable Limits (dBm)	Pass or Fail
2.402	3.23	3.19	30	Pass
2.441	3.25	3.05	30	Pass
2.480	3.18	3.03	30	Pass

## 6. 20 dB BANDWIDTH

### 6.1 MEASUREMENT PROCEDURE

1. The EUT was placed on a turn table which is 0.8m above ground plane.
2. Connect EUT RF output port to the Spectrum Analyzer through an RF attenuator
3. Set the EUT Work on the top, the middle and the bottom operation frequency individually.
4. Set Span = approximately 2 to 3 times the 20 dB bandwidth, centered on a hopping channel  
RBW  $\geq$  1% of the 20 dB bandwidth, VBW  $\geq$  RBW; Sweep = auto; Detector function = peak
5. Set SPA Trace 1 Max hold, then View.

### 6.2 TEST SET-UP (BLOCK DIAGRAM OF CONFIGURATION)

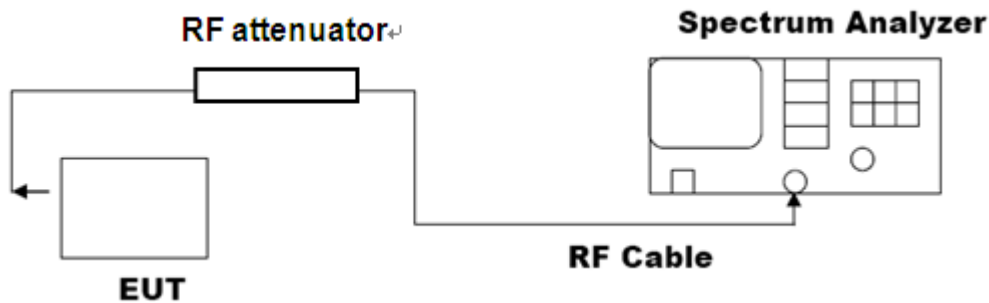

### 6.3 MEASUREMENT EQUIPMENT USED

Description	Manufacturer	Model	SERIAL NUMBER	Cal. Date	Cal. Due
Spectrum Analyzer	Agilent	E4440A	N/A	07/18/2012	07/17/2013
RF attenuator	N/A	RFA20db	N/A	N/A	N/A

### 6.4 LIMITS AND MEASUREMENT RESULTS

THE MEASUREMENT RESULT WITH THE WORST CASE OF 3MBPS FOR 8-DPSK MODULATION			
Applicable Limits	Measurement Result		
	Test Data (MHz)		Criteria
--	Low Channel	1.264	PASS
	Middle Channel	1.264	PASS
	High Channel	1.209	PASS

TEST PLOT OF BANDWIDTH FOR LOW CHANNEL

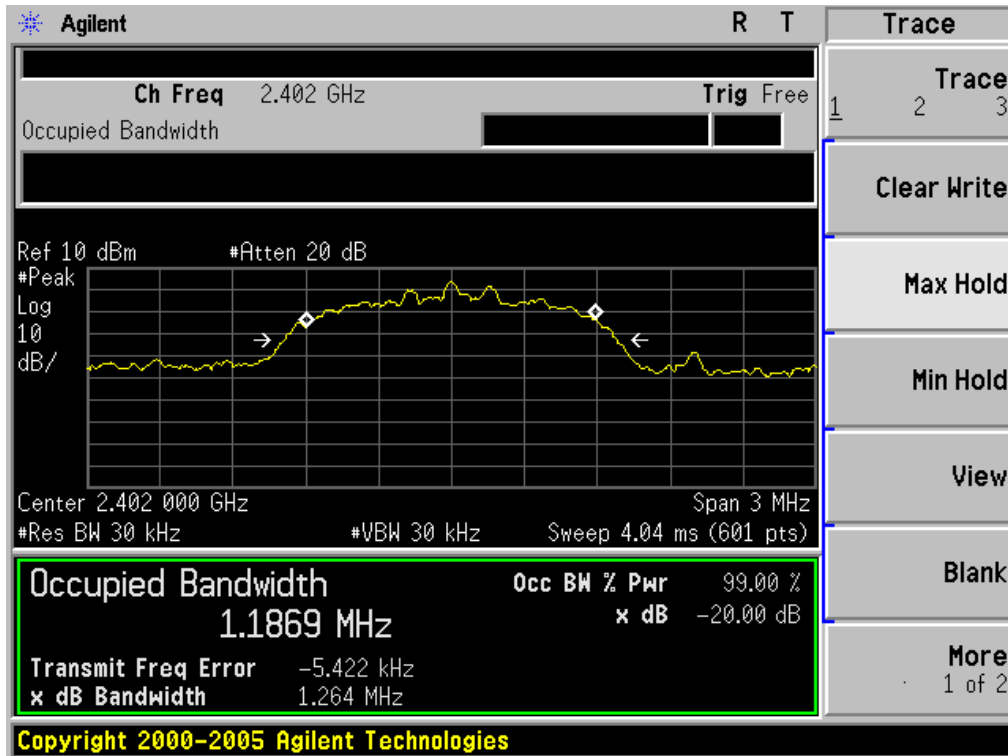

TEST PLOT OF BANDWIDTH FOR MIDDLE CHANNEL

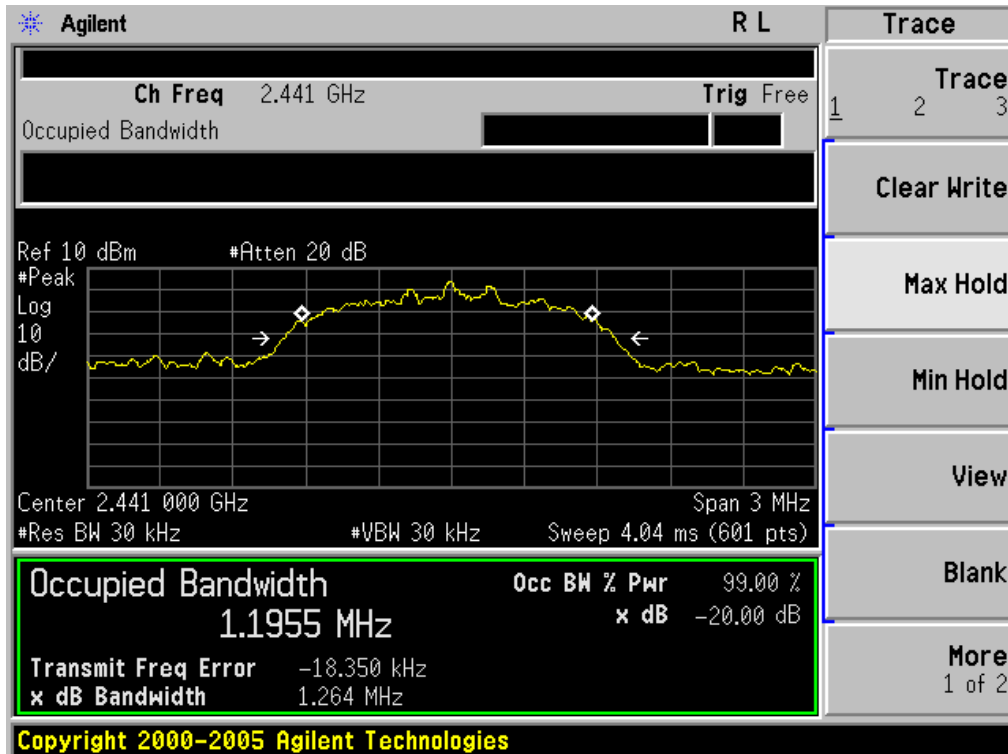

TEST PLOT OF BANDWIDTH FOR HIGH CHANNEL

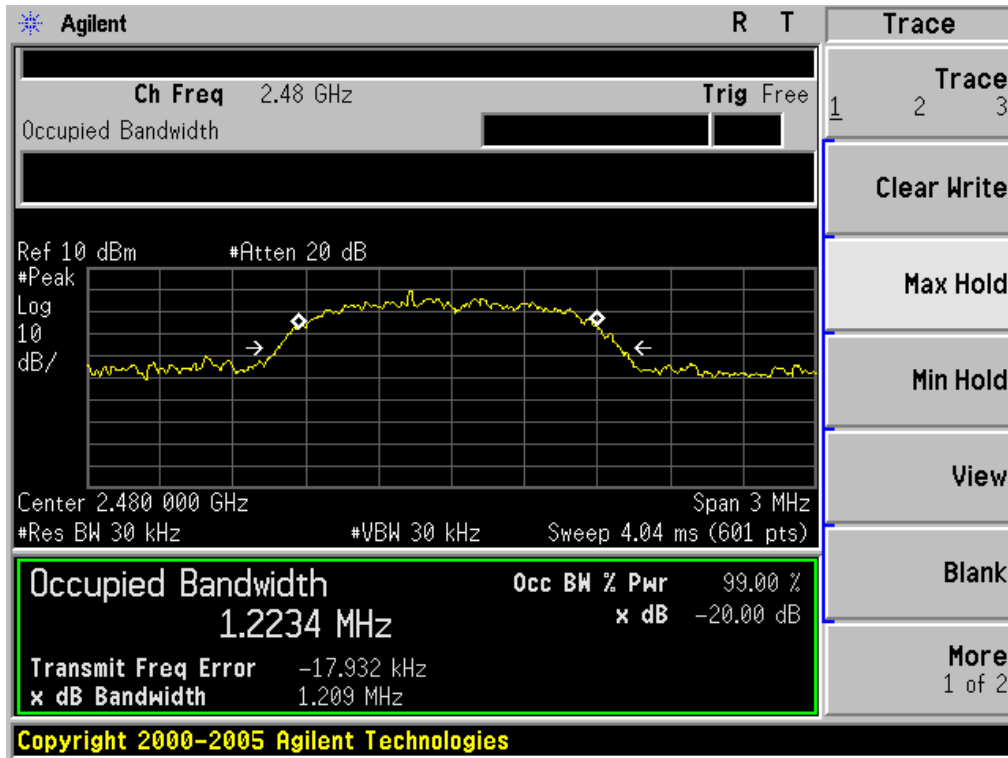

## 7. CONDUCTED SPURIOUS EMISSION

### 7.1 MEASUREMENT PROCEDURE

1. The EUT was placed on a turn table which is 0.8m above ground plane.
2. Connect EUT RF output port to the Spectrum Analyzer through an RF attenuator
3. Set the EUT Work on the top, the middle and the bottom operation frequency individually.
4. Set the Span = wide enough to capture the peak level of the in-band emission and all spurious emissions from the lowest frequency generated in the EUT up through the 10th harmonic.  
RBW = 100 kHz; VBW  $\geq$  RBW; Sweep = auto; Detector function = peak.
5. Set SPA Trace 1 Max hold, then View.

### 7.2 TEST SET-UP (BLOCK DIAGRAM OF CONFIGURATION)

The same as described in section 6.2

### 7.3 MEASUREMENT EQUIPMENT USED

The same as described in section 6.3

### 7.4 LIMITS AND MEASUREMENT RESULT

LIMITS AND MEASUREMENT RESULT		
Applicable Limits	Measurement Result	
	Test Data	Criteria
In any 100 KHz Bandwidth Outside the frequency band in which the spread spectrum intentional radiator is operating, the radio frequency power that is produce by the intentional radiator shall be at least 20 dB below that in 100KHz bandwidth within the band that contains the highest level of the desired power.	At least -20dBc than the limit Specified on the BOTTOM Channel	PASS
In addition, radiation emissions which fall in the restricted bands, as defined in §15.205(a), must also comply with the radiated emission limits specified in§15.209(a))	At least -20dBc than the limit Specified on the TOP Channel	PASS



TEST PLOT OF OUT OF BAND EMISSIONS WITH THE WORST CASE  
OF 1 MBPS FOR GFSK MODULATION IN LOW CHANNEL

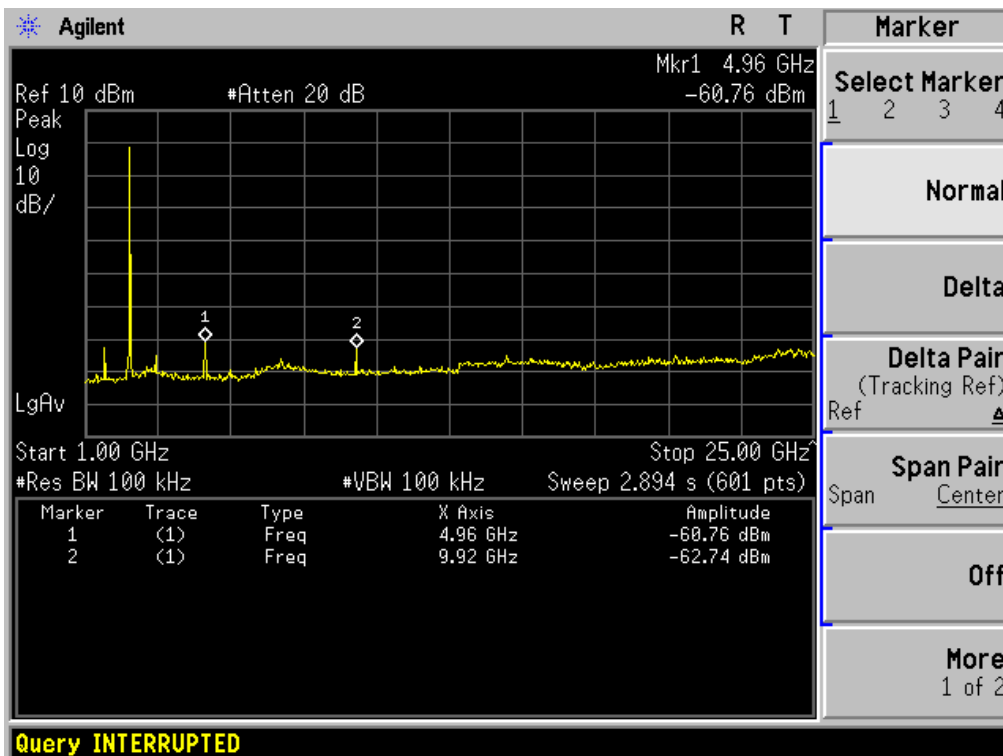
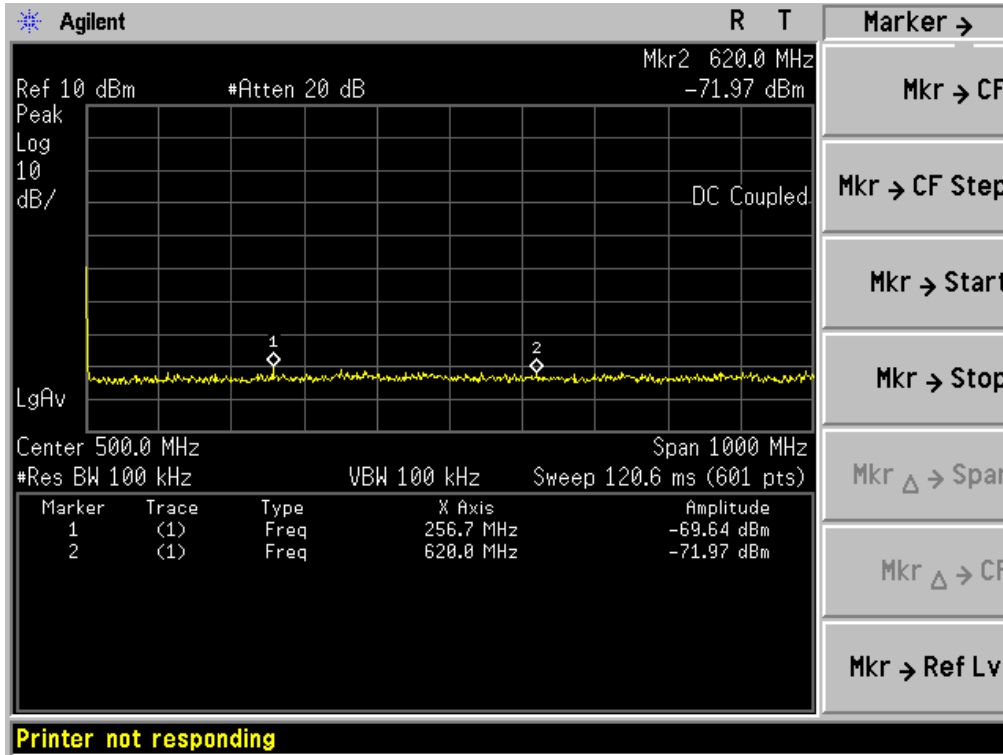

## **8. RADIATED EMISSION**

### **8.1 MEASUREMENT PROCEDURE**

1. Configure the EUT according to ANSI C63.4. The EUT was placed on the top of the turntable 0.8 meter above ground. The phase center of the receiving antenna mounted on the top of a height-variable antenna tower was placed 3 meters far away from the turntable.
2. Power on the EUT and all the supporting units. The turntable was rotated by 360 degrees to determine the position of the highest radiation.
3. The height of the broadband receiving antenna was varied between one meter and four meters above ground to find the maximum emissions field strength of both horizontal and vertical polarization.
4. For each suspected emissions, the antenna tower was scan (from 1 M to 4 M) and then the turntable was rotated (from 0 degree to 360 degrees) to find the maximum reading.
5. Set the test-receiver system to Peak or CISPR quasi-peak Detect Function with specified bandwidth under Maximum Hold Mode.
6. For emissions above 1GHz, use 1MHz VBW and RBW for peak reading. Then 1MHz RBW and 10Hz VBW for average reading in spectrum analyzer.
7. When the radiated emissions limits are expressed in terms of the average value of the emissions, and pulsed operation is employed, the measurement field strength shall be determined by averaging over one complete pulse train, including blanking intervals, as long as the pulse train does not exceed 0.1 seconds. As an alternative (provided the transmitter operates for longer than 0.1 seconds) or in cases where the pulse train exceeds 0.1 seconds, the measured field strength shall be determined from the average absolute voltage during a 0.1 second interval during which the field strength is at its maximum value.
8. If the emissions level of the EUT in peak mode was 3 dB lower than the average limit specified, then testing will be stopped and peak values of EUT will be reported, otherwise, the emissions which do not have 3 dB margin will be repeated one by one using the quasi-peak method for below 1GHz.
9. For testing above 1GHz, the emissions level of the EUT in peak mode was lower than average limit (that means the emissions level in peak mode also complies with the limit in average mode), then testing will be stopped and peak values of EUT will be reported, otherwise, the emissions will be measured in average mode again and reported.
10. In case the emission is lower than 30MHz, loop antenna has to be used for measurement and the recorded data should be QP measured by receiver. High – Low scan is not required in this case.

The following table is the setting of spectrum analyzer and receiver.'

Spectrum Parameter	Setting
Start Frequency	1GHz
Stop Frequency	26.5GHz
RB/VB(Emission in restricted band)	1MHz/1MHz for Peak, 1MHz/10Hz for Average
RB/VB(Emission in non-restricted band)	1MHz/1MHz for Peak

Receiver Parameter	Setting
Start ~Stop Frequency	9KHz~150KHz/RB 200Hz for QP
Start ~Stop Frequency	150KHz~30MHz/RB 9KHz for QP
Start ~Stop Frequency	30MHz~1000MHz/RB 120KHz for QP

## 8.2 TEST SETUP

### RADIATED EMISSION TEST SETUP BELOW 30MHz

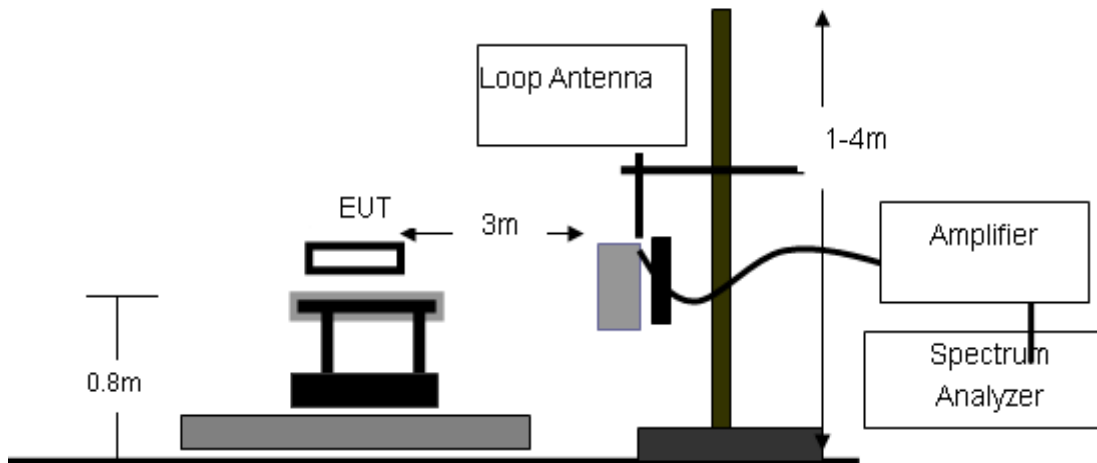

RADIATED EMISSION TEST SETUP 30MHz-1000MHz

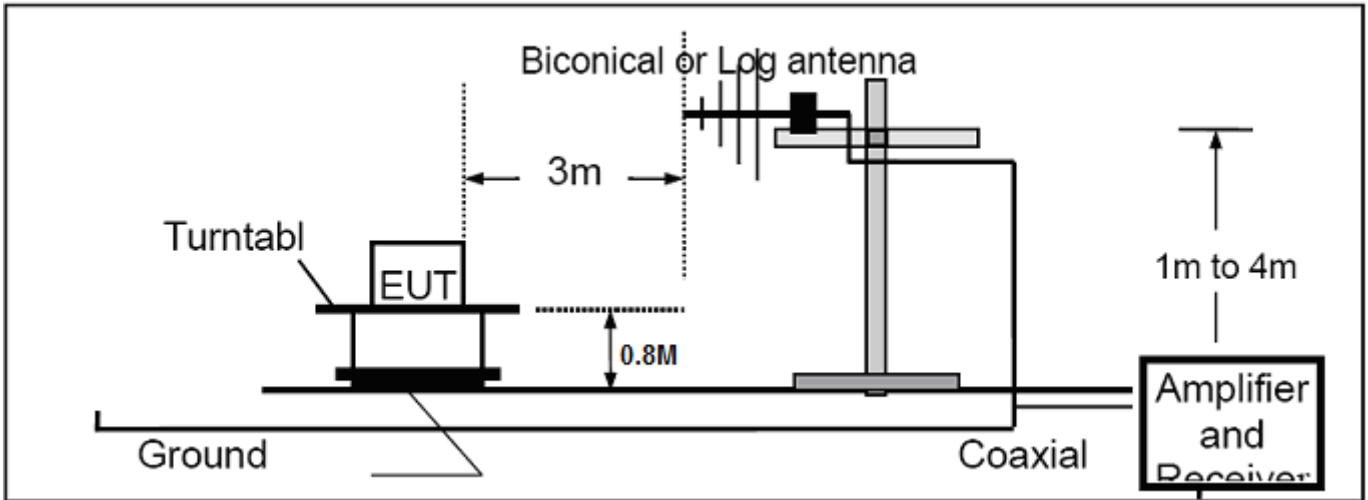

RADIATED EMISSION TEST SETUP ABOVE 1000MHz

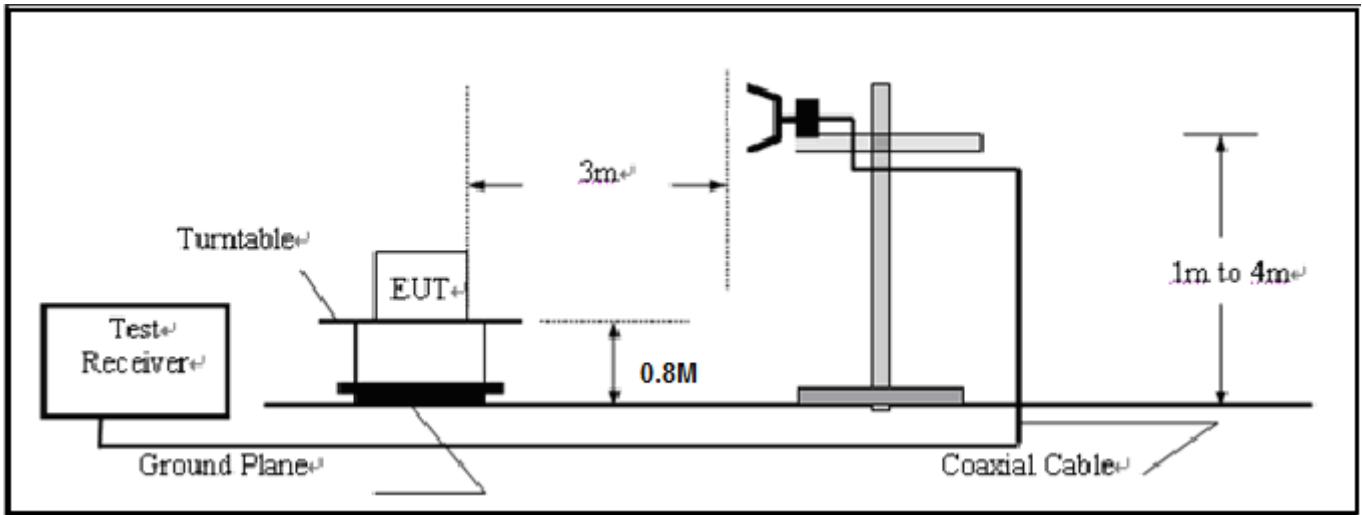

### 8.3 TEST EQUIPMENT LIST

Description	Manufacturer	Model	SERIAL NUMBER	Cal. Date	Cal. Due
Spectrum Analyzer	Agilent	E4440A	N/A	07/18/2012	07/17/2013
Amplifier	EM	EM30180	0607030	07/18/2012	07/17/2013
Horn Antenna	EM	EM-AH-10180	N/A	07/18/2012	07/17/2013
EMI Test Receiver	Rohde & Schwarz	ESCI	N/A	07/18/2012	07/17/2013
Amplifier	EM	EM30180	N/A	07/18/2012	07/17/2013
Biological Antenna	A.H. Systems Inc.	SAS-521-4	N/A	07/18/2012	07/17/2013
Loop Antenna	Daze	ZN30900N	SEL0097	07/18/2012	07/17/2013
Isolation Transformer	LETEAC	LTBK	--	07/18/2012	07/17/2013

### 8.4 TEST RESULT

The worst case is Normal Hopping Mode.

#### RADIATED EMISSION BELOW 30MHZ

No emission found between lowest internal used/generated frequencies to 30MHz.

#### RADIATED EMISSION BELOW 1GHZ

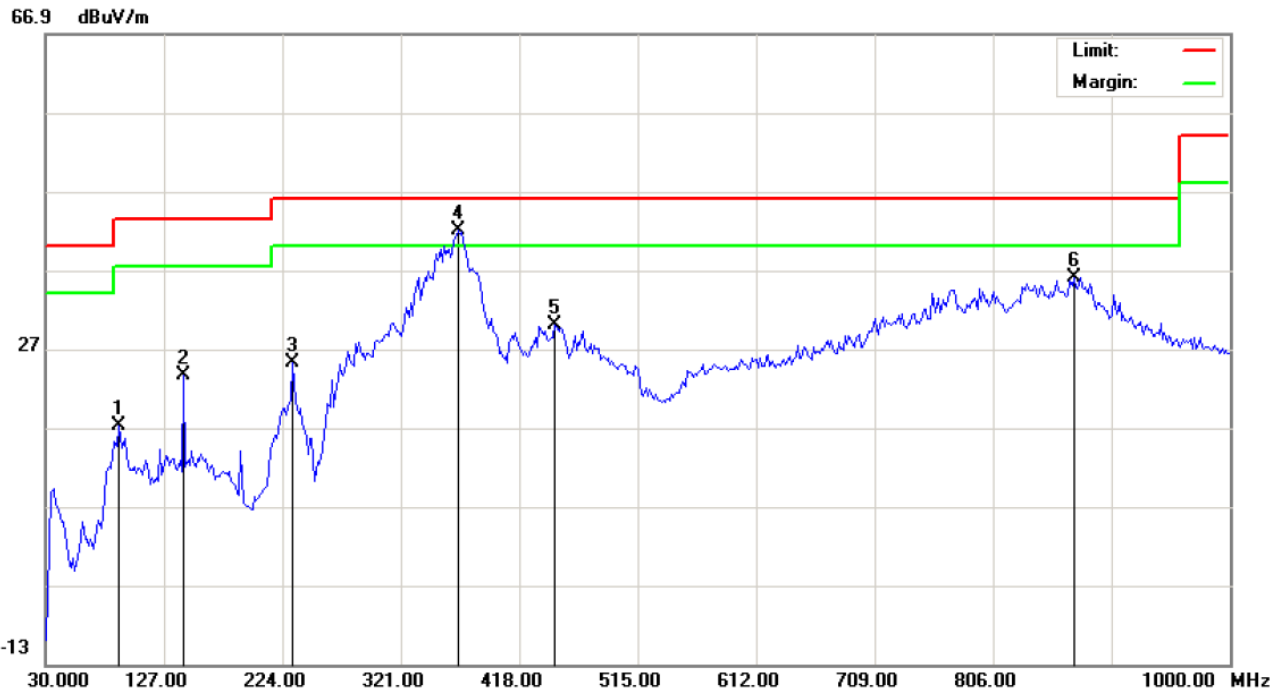

Site: site #1	Polarization: <i>Horizontal</i>	Temperature: 26
Limit: FCC Class B 3M Radiation	Power: AC 120V/60Hz	Humidity: 60 %
EUT: Bluetooth headset	Distance: 3m	
M/N: RK300		
Mode: Nomal Hopping		
Note:		

No.	Mk	Freq.	Reading	Factor	Measurement	Limit	Over	Detector	Antenna Height	Table Degree	Comment
		MHz	dBuV	dB/m	dBuV/m	dBuV/m	dB		cm	degree	
1		89.8167	0.05	17.11	17.16	43.50	-26.34	peak			
2		143.1667	10.82	12.76	23.58	43.50	-19.92	peak			
3		232.0833	12.79	12.44	25.23	46.00	-20.77	peak			
4	*	367.8833	22.88	19.16	42.04	46.00	-3.96	peak			
5		447.1000	8.42	21.49	29.91	46.00	-16.09	peak			
6		872.2833	6.88	29.19	36.07	46.00	-9.93	peak			

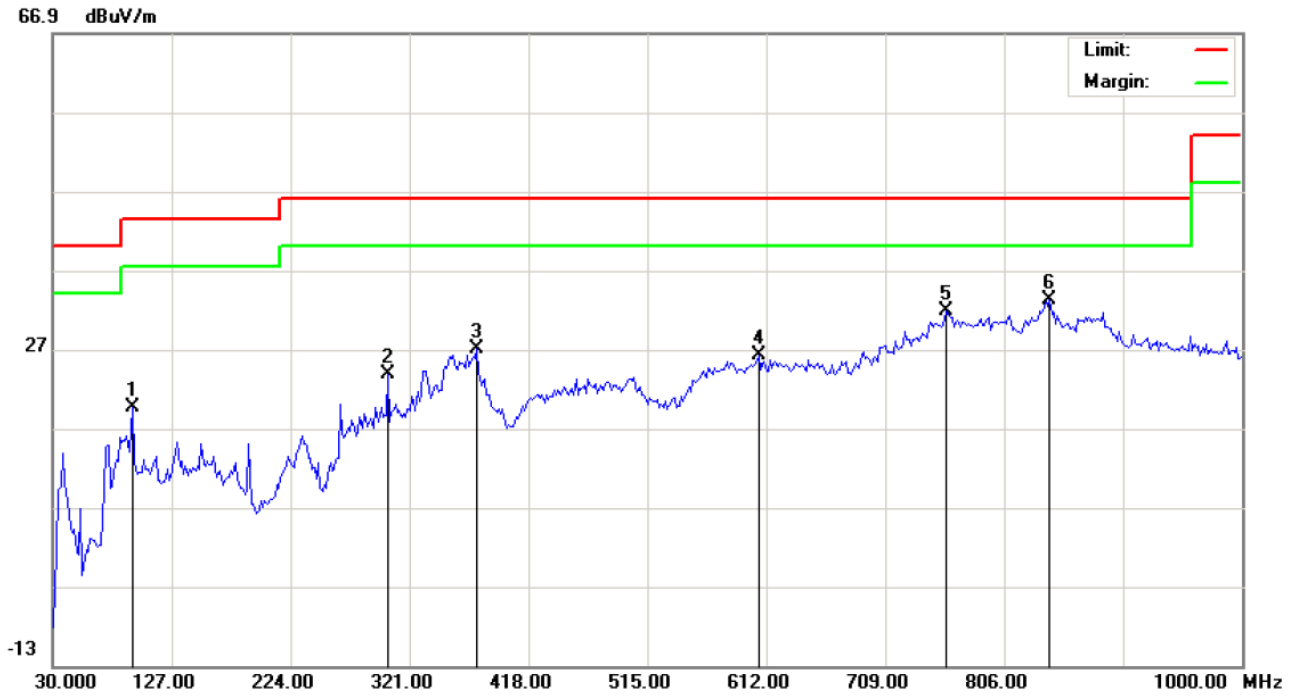

Site: site #1  
Limit: FCC Class B 3M Radiation  
EUT: Bluetooth headset  
M/N: RK300  
Mode: Normal Hopping  
Note:

Polarization: **Vertical**  
Power: AC 120V/60Hz  
Distance: 3m

Temperature: 26  
Humidity: 60 %

No.	Mk	Freq.	Reading	Factor	Measurement	Limit	Over	Detector	Antenna Height	Table Degree	Comment
		MHz	dBuV	dB/m	dBuV/m	dBuV/m	dB		cm	degree	
1		94.6667	4.60	15.06	19.66	43.50	-23.84	peak			
2		303.2167	6.51	17.21	23.72	46.00	-22.28	peak			
3		375.9667	7.71	19.21	26.92	46.00	-19.08	peak			
4		605.5333	1.22	24.96	26.18	46.00	-19.82	peak			
5		759.1167	4.37	27.46	31.83	46.00	-14.17	peak			
6	*	843.1833	2.26	30.99	33.25	46.00	-12.75	peak			

**RADIATED EMISSION ABOVE 1GHZ (1-10<sup>th</sup> Harmonics)**

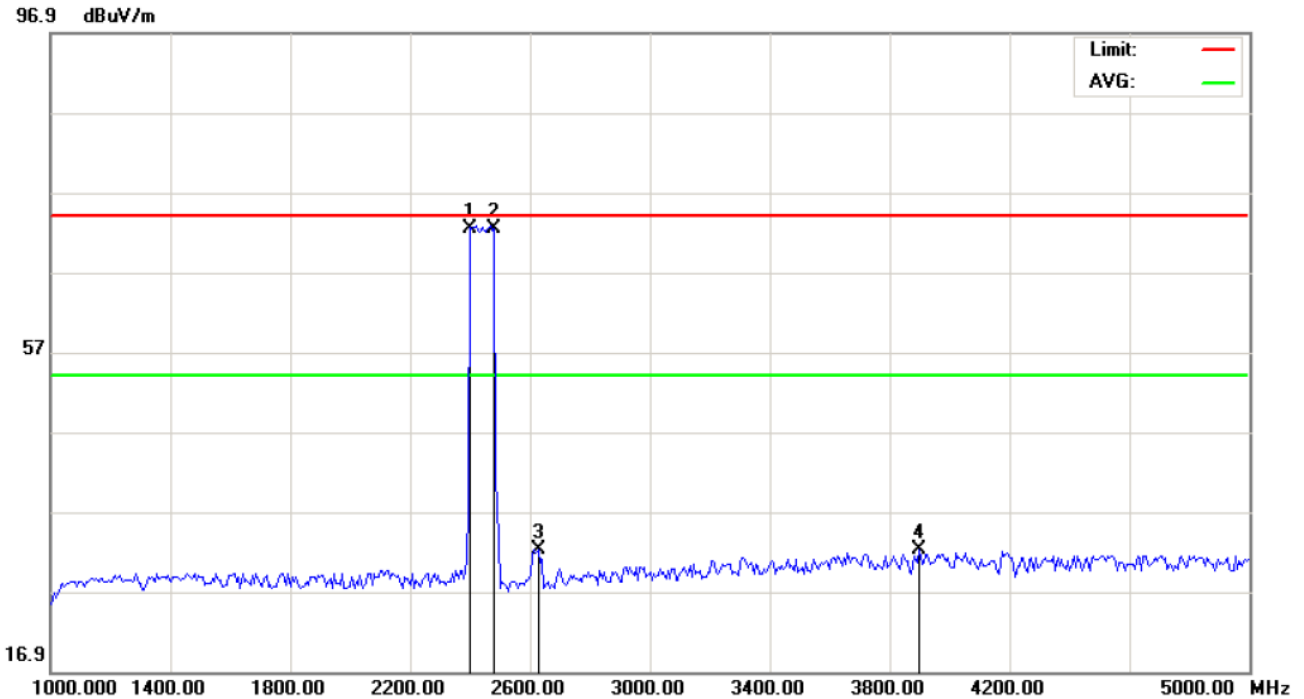

Site: site #1  
Limit: FCC Class B 3M Radiation above 1GHZ(PK)  
EUT: Bluetooth headset  
M/N: RK300  
Mode: Normal Hopping  
Note:

Polarization: *Horizontal*  
Power:  
Distance: 3m

Temperature: 26  
Humidity: 60 %

No.	Mk	Freq.	Reading	Factor	Measurement	Limit	Over	Detector	Antenna Height	Table Degree	Comment
		MHz	dBuV	dB/m	dBuV/m	dBuV/m	dB		cm	degree	
1	*	2402.000	80.71	-8.39	72.32	74.00	-1.68	peak			
2		2480.000	80.39	-8.08	72.31	74.00	-1.69	peak			
3		2626.667	40.32	-8.19	32.13	74.00	-41.87	peak			
4		3900.000	39.45	-7.22	32.23	74.00	-41.77	peak			

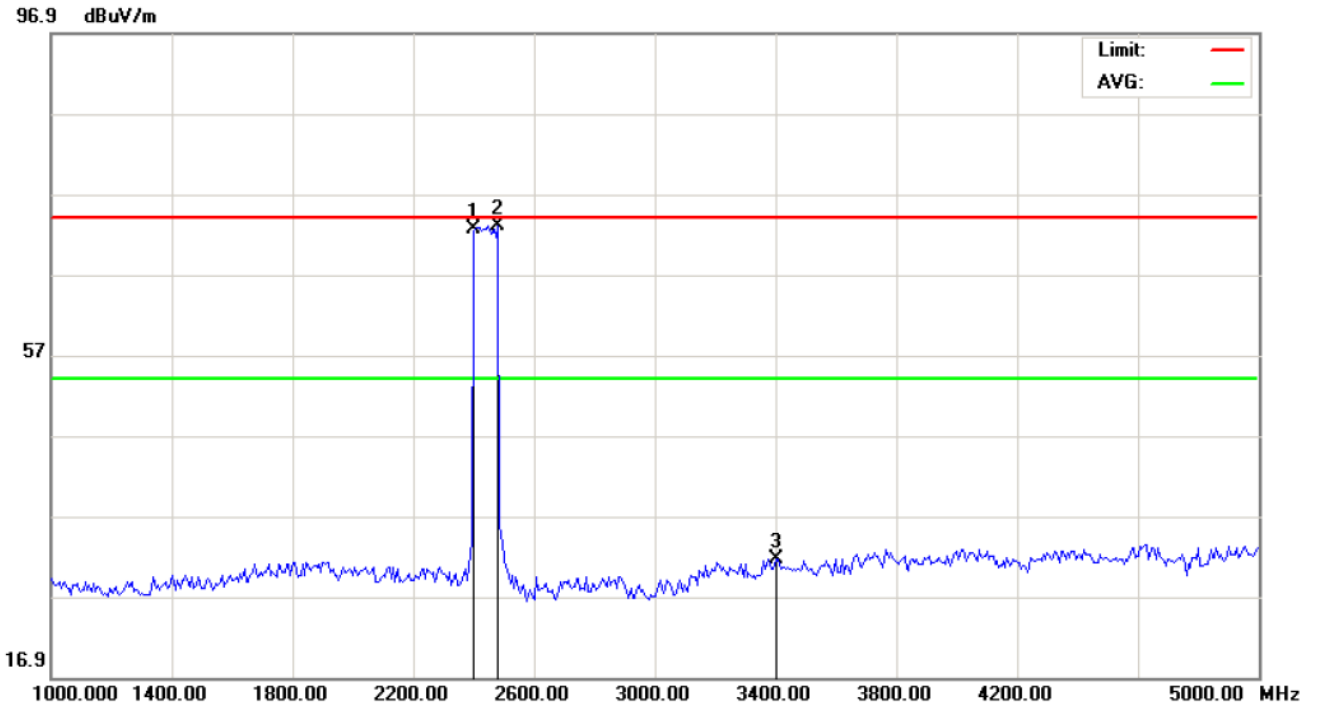

Site: site #1  
 Limit: FCC Class B 3M Radiation above 1GHZ(PK)  
 EUT: Bluetooth headset  
 M/N: RK300  
 Mode: Normal Hopping  
 Note:

Polarization: *Vertical*  
 Power:  
 Distance: 3m

Temperature: 26  
 Humidity: 60 %

No.	Mk	Freq.	Reading	Factor	Measurement	Limit	Over	Detector	Antenna Height	Table Degree	Comment
		MHz	dBuV	dB/m	dBuV/m	dBuV/m	dB		cm	degree	
1		2402.000	81.06	-8.39	72.67	74.00	-1.33	peak			
2	*	2480.000	81.15	-8.08	73.07	74.00	-0.93	peak			
3		3400.000	39.47	-7.83	31.64	74.00	-42.36	peak			

**Note:** 5~25GHz at least have 20dB margin. No recording in the test report.  
 Factor=Antenna Factor+ Cable loss-Amplifier gain, Over=Measurement-Limit.











## 10. NUMBER OF HOPPING FREQUENCY

### 10.1 MEASUREMENT PROCEDURE

1. Place the EUT on the table and set it in transmitting mode.
2. Remove the antenna from the EUT and then connect a low RF cable from the antenna port to the spectrum analyzer.
3. Set the spectrum analyzer Start = 2.4GHz Stop = 2.4835GHz
4. Set the Spectrum Analyzer as RBW>=1%span, VBW>=RBW.

### 10.2 TEST SETUP (BLOCK DIAGRAM OF CONFIGURATION)

Same as described in section 6.2  
Conducted Method.

### 10.3 MEASUREMENT EQUIPMENT USED

The same as described in section 6.3

### 10.4 LIMITS AND MEASUREMENT RESULT

TOTAL NO. OF HOPPING CHANNEL	LIMIT (NO. OF CH)	MEASUREMENT (NO. OF CH)	RESULT
	>=15	79	PASS

TEST PLOT FOR NO. OF TOTAL CHANNELS

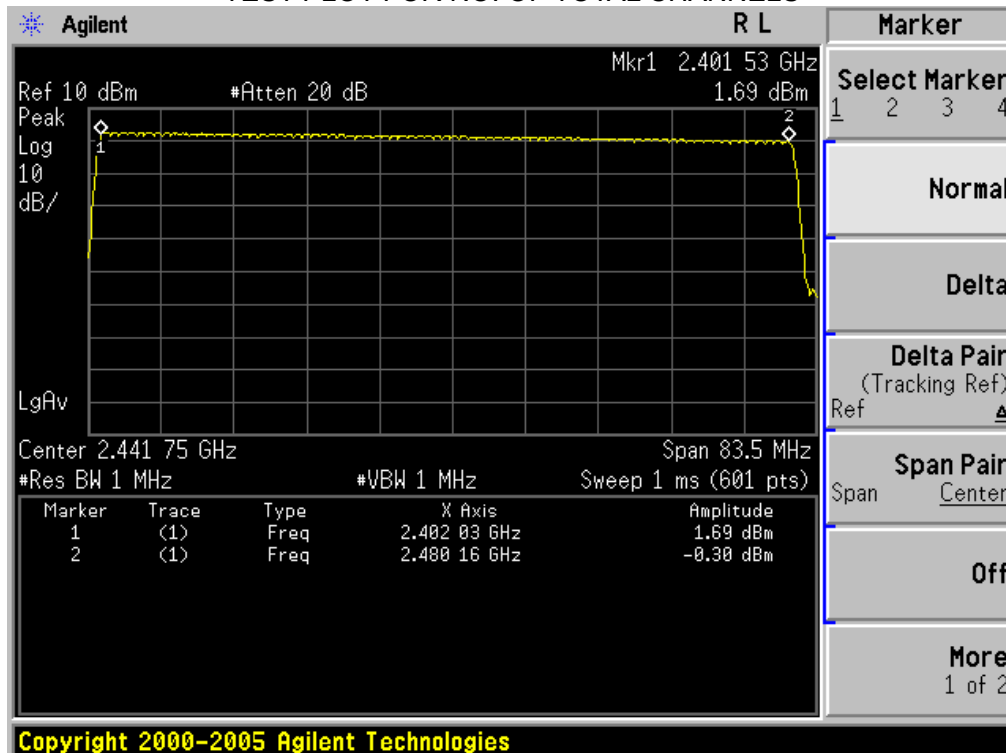

## 11. TIME OF OCCUPANCY (DWELL TIME)

### 11.1 MEASUREMENT PROCEDURE

1. Place the EUT on the table and set it in transmitting mode.
2. Remove the antenna from the EUT and then connect a low RF cable from the antenna port to the spectrum analyzer.
3. Set Span = zero span, centered on a hopping channel.
4. Set the spectrum analyzer as RBW=1MHz, VBW>=RBW, Span = 0 Hz.

### 11.2 TEST SETUP (BLOCK DIAGRAM OF CONFIGURATION)

Same as described in section 6.2  
Conducted Method

### 11.3 MEASUREMENT EQUIPMENT USED

The same as described in section 6.3

### 11.4 LIMITS AND MEASUREMENT RESULT

**Bluetooth 3Mbps Test Result**

Channel	Time of Pulse for DH5 (ms)	Period Time (s)	Sweep Time (ms)	Limit (ms)
Low	2.9	31.6	309.33	400
Middle	2.9	31.6	309.33	400
High	2.923	31.6	311.79	400

Low Channel Time

$$2.9 * (1600/6) / 79 * 31.6 = 309.33 \text{ms}$$

Middle Channel Time

$$2.9 * (1600/6) / 79 * 31.6 = 309.33 \text{ms}$$

High Channel Time

$$2.923 * (1600/6) / 79 * 31.6 = 311.79 \text{ms}$$

TEST PLOT OF LOW CHANNEL

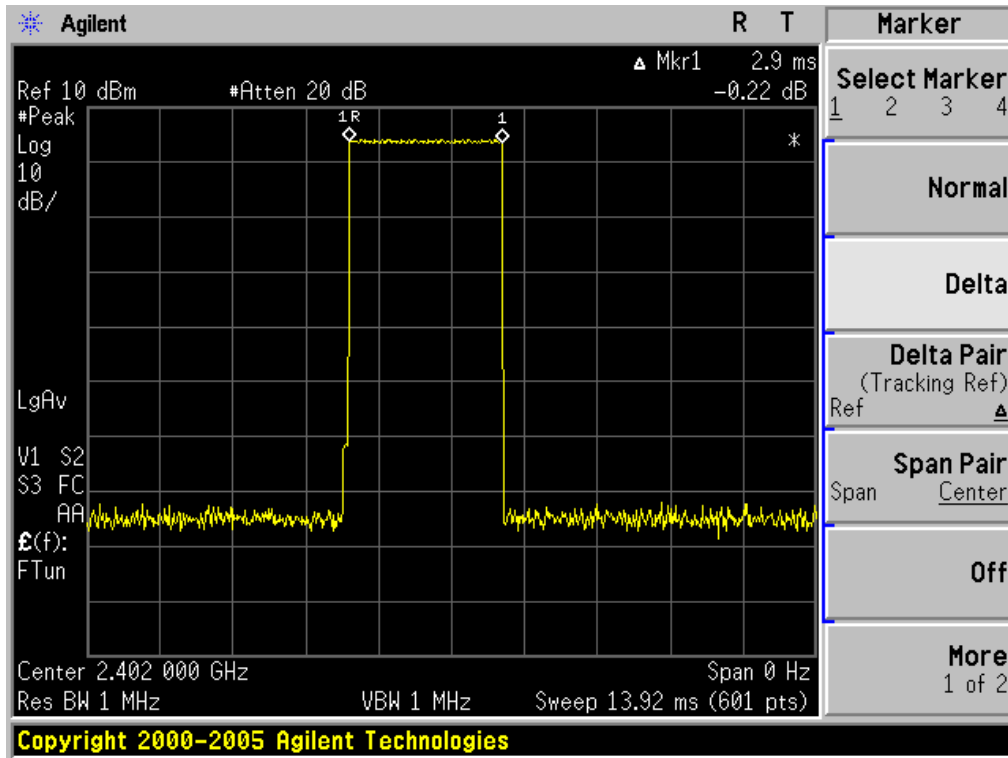

TEST PLOT OF MIDDLE CHANNEL

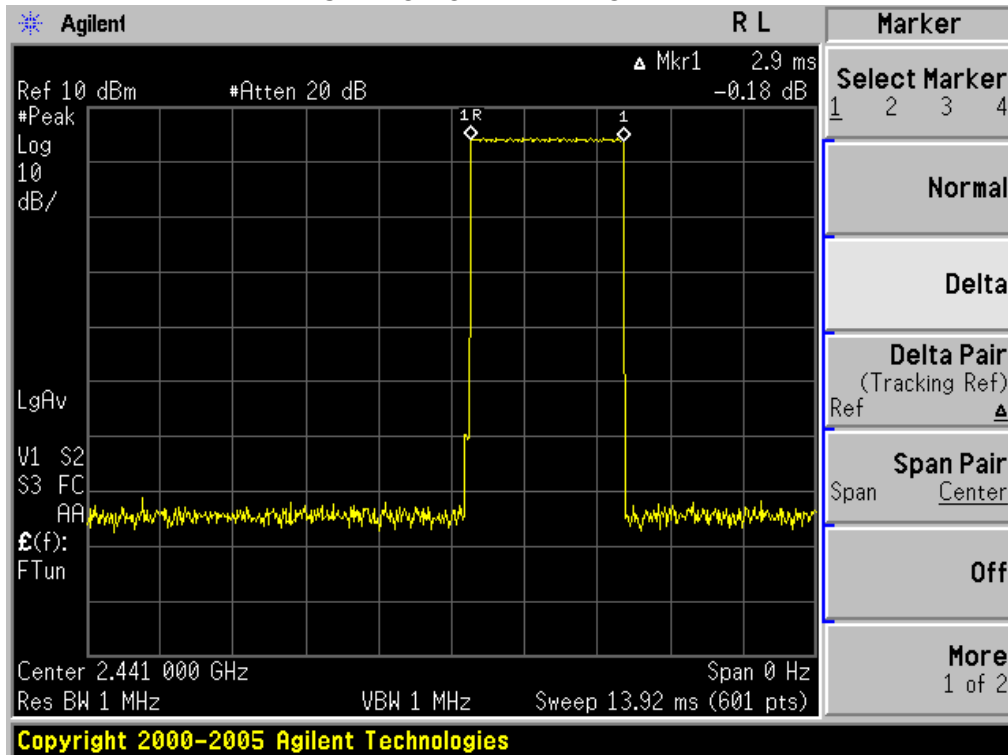

TEST PLOT OF HIGH CHANNEL

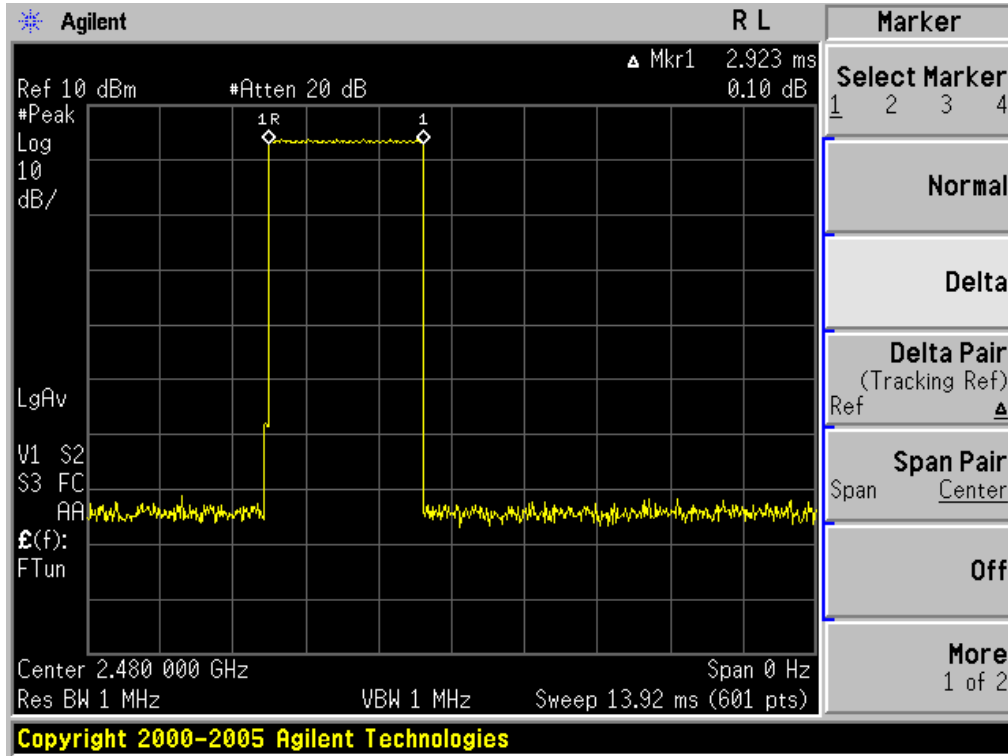



## 12. FREQUENCY SEPARATION

### 12.1 MEASUREMENT PROCEDURE

1. Place the EUT on the table and set it in transmitting mode
2. Remove the antenna from the EUT and then connect a low RF cable from the antenna port to the spectrum analyzer
3. Set Span = wide enough to capture the peaks of two adjacent channels Resolution (or IF) Bandwidth (RBW)  $\geq$  1% of the span Video (or Average) Bandwidth (VBW)  $\geq$  RBW; Sweep = auto; Detector function = peak; Trace = max hold

### 12.2 TEST SETUP (BLOCK DIAGRAM OF CONFIGURATION)

Same as described in section 6.2

### 12.3 MEASUREMENT EQUIPMENT USED

The same as described in section 6.3

### 12.4 LIMITS AND MEASUREMENT RESULT

BLUETOOTH 1MBPS TEST RESULT

CHANNEL	CHANNEL SEPARATION	LIMIT	RESULT
	KHz	KHz	
CH00-CH01	1000	$\geq$ 25 KHz or 2/3 20 dB BW	Pass

TEST PLOT FOR FREQUENCY SEPARATION (1Mbps)

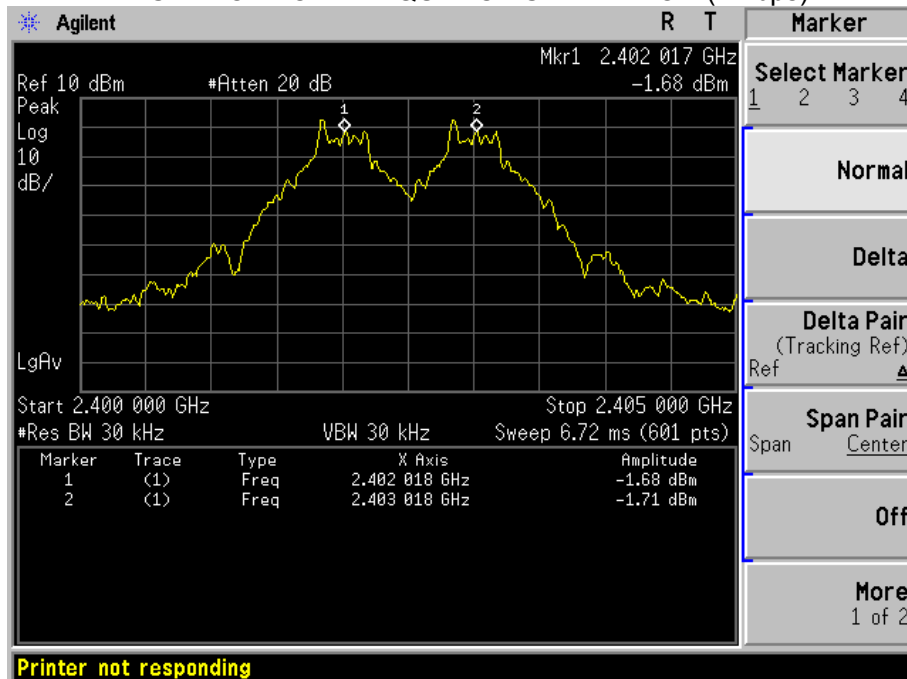

### 13. CONDUCTED EMISSION

#### 13.1 LIMITS OF LINE CONDUCTED EMISSION TEST

Frequency	Maximum RF Line Voltage	
	Q.P.( dBuV)	Average( dBuV)
150kHz~500kHz	66-56	56-46
500kHz~5MHz	56	46
5MHz~30MHz	60	50

**\*\*Note:** 1. The lower limit shall apply at the transition frequency.  
2. The limit decreases linearly with the logarithm of the frequency in the range 0.15 MHz to 0.50 MHz

#### 13.2 BLOCK DIAGRAM OF LINE CONDUCTED EMISSION TEST

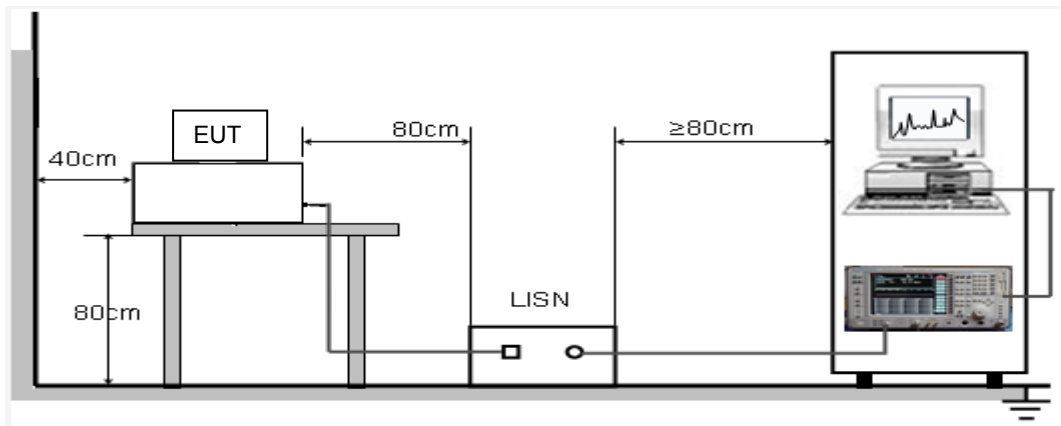

### 13.3 PROCEDURE OF LINE CONDUCTED EMISSION TEST

- 1) The equipment was set up as per the test configuration to simulate typical actual usage per the user's manual. When the EUT is a tabletop system, a wooden table with a height of 0.8 meters is used and is placed on the ground plane as per ANSI C63.4 (see Test Facility for the dimensions of the ground plane used). When the EUT is a floor-standing equipment, it is placed on the ground plane which has a 3-12 mm non-conductive covering to insulate the EUT from the ground plane.
- 2) Support equipment, if needed, was placed as per ANSI C63.4.
- 3) All I/O cables were positioned to simulate typical actual usage as per ANSI C63.4.
- 4) The EUT received DC 5V charging voltage by PC which received 120V/60Hz power through a LISN.
- 5) The EUT test program was started. Emissions were measured on each current carrying line of the EUT using a spectrum Analyzer / Receiver connected to the LISN powering the EUT. The LISN has two monitoring points: Line 1 (Hot Side) and Line 2 (Neutral Side). Two scans were taken: one with Line 1 connected to Analyzer / Receiver and Line 2 connected to a 50 ohm load; the second scan had Line 1 connected to a 50 ohm load and Line 2 connected to the Analyzer / Receiver.
- 6) Analyzer / Receiver scanned from 150 kHz to 30MHz for emissions in each of the test modes.
- 7) During the above scans, the emissions were maximized by cable manipulation.
- 8) A scan was taken on both power lines, Line 1 and Line 2, recording at least the six highest emissions.
- 9) Emission frequency and amplitude were recorded into a computer in which correction factors were used to calculate the emission level and compare reading to the applicable limit. If EUT emission level was less -2dB to the A.V. limit in Peak mode, then the emission signal was re-checked using Q.P and Average detector.

The test data of the worst case condition(s) was reported on the Summary Data page.

### 13.4 TEST RESULT OF LINE CONDUCTED EMISSION TEST

#### LINE CONDUCTED EMISSION – L

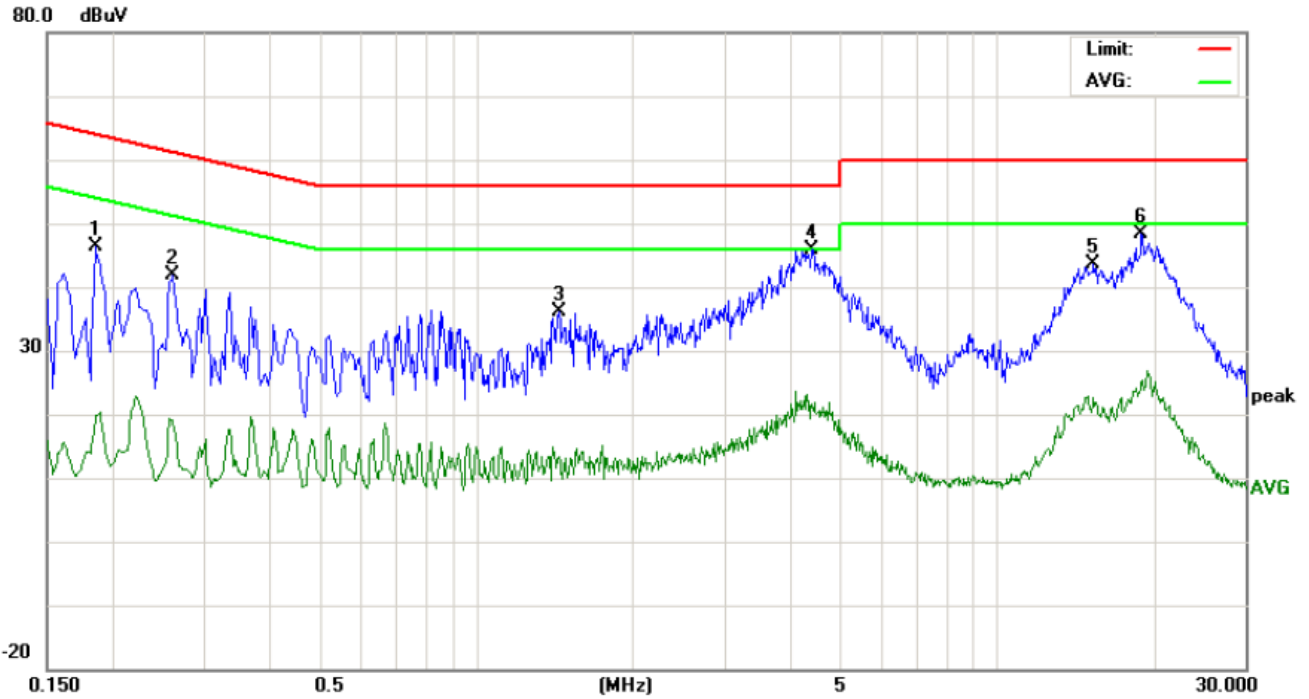

Site: Conduction Phase: **L1** Temperature: 26  
 Limit: FCC Class B Conduction(QP) Power: AC 120V/60Hz Humidity: 60 %  
 EUT: Bluetooth headset  
 M/N: RK300  
 Mode: Normal Hopping  
 Note:

No.	Freq. (MHz)	Reading_Level (dBuV)			Correct Factor (dB)	Measurement (dBuV)			Limit (dBuV)		Margin (dB)		P/F	Comment
		Peak	QP	AVG		Peak	QP	AVG	QP	AVG	QP	AVG		
1	0.1860	36.15		9.52	10.20	46.35		19.72	64.21	54.21	-17.86	-34.49	P	
2	0.2620	31.49		8.62	10.27	41.76		18.89	61.36	51.36	-19.60	-32.47	P	
3	1.4420	25.66		2.93	10.38	36.04		13.31	56.00	46.00	-19.96	-32.69	P	
4	4.4220	35.64		11.27	10.24	45.88		21.51	56.00	46.00	-10.12	-24.49	P	
5	15.3660	33.56		12.63	10.12	43.68		22.75	60.00	50.00	-16.32	-27.25	P	
6	18.9700	38.21		15.12	10.12	48.33		25.24	60.00	50.00	-11.67	-24.76	P	

LINE CONDUCTED EMISSION – N

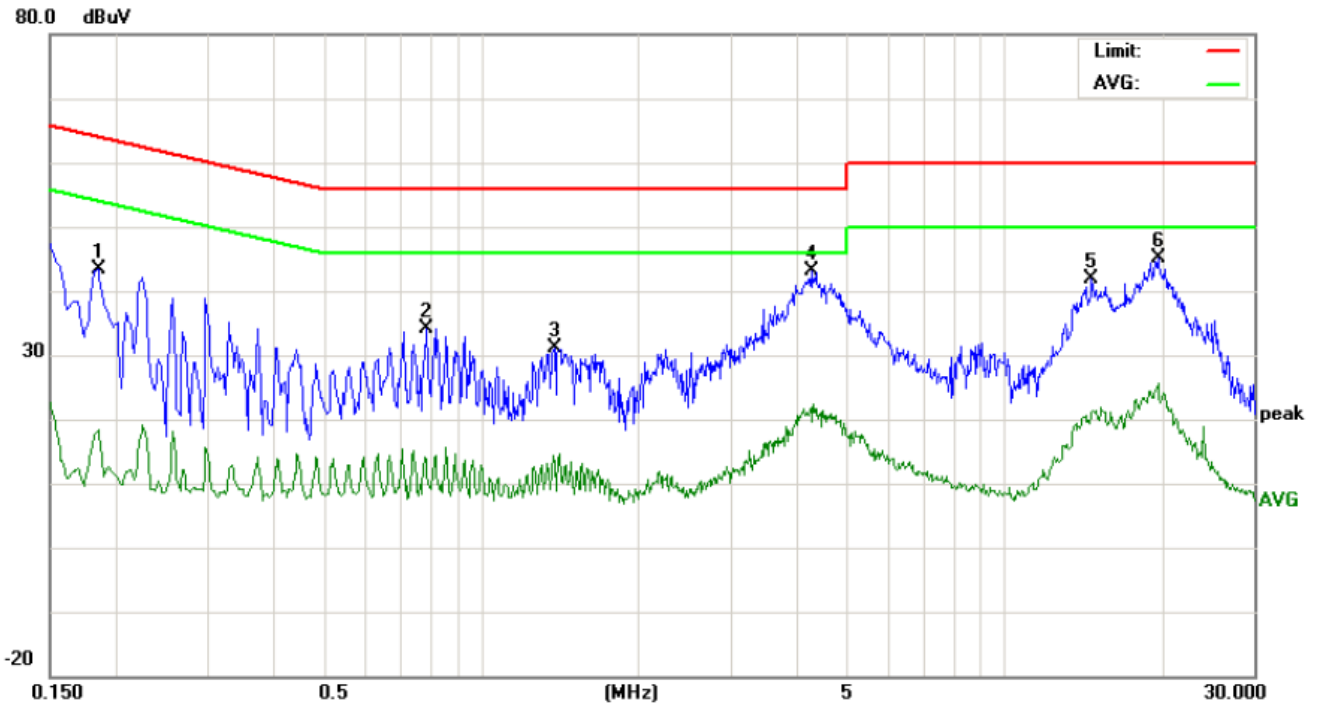

Site: Conduction Phase: **N** Temperature: 26  
 Limit: FCC Class B Conduction(QP) Power: AC 120V/60Hz Humidity: 60 %  
 EUT: Bluetooth headset  
 M/N: RK300  
 Mode: Normal Hopping  
 Note:

No.	Freq. (MHz)	Reading_Level (dBuV)			Correct Factor (dB)	Measurement (dBuV)			Limit (dBuV)		Margin (dB)		P/F	Comment
		Peak	QP	AVG		Peak	QP	AVG	QP	AVG	QP	AVG		
1	0.1860	33.10		8.22	10.20	43.30		18.42	64.21	54.21	-20.91	-35.79	P	
2	0.7900	23.95		1.00	10.29	34.24		11.29	56.00	46.00	-21.76	-34.71	P	
3	1.3820	20.65		2.77	10.38	31.03		13.15	56.00	46.00	-24.97	-32.85	P	
4	4.2740	32.84		11.57	10.31	43.15		21.88	56.00	46.00	-12.85	-24.12	P	
5	14.7180	31.85		10.91	10.12	41.97		21.03	60.00	50.00	-18.03	-28.97	P	
6	19.6380	35.02		15.60	10.11	45.13		25.71	60.00	50.00	-14.87	-24.29	P	

**APPENDIX I**  
**PHOTOGRAPHS OF THE EUT**  
**TOP VIEW OF EUT**



**BOTTOM VIEW OF EUT**



LEFT VIEW OF EUT



RIGHT VIEW OF EUT



FRONT VIEW OF EUT



BACK VIEW OF EUT





OPEN VIEW OF EUT



FRONT VIEW OF PCB-1

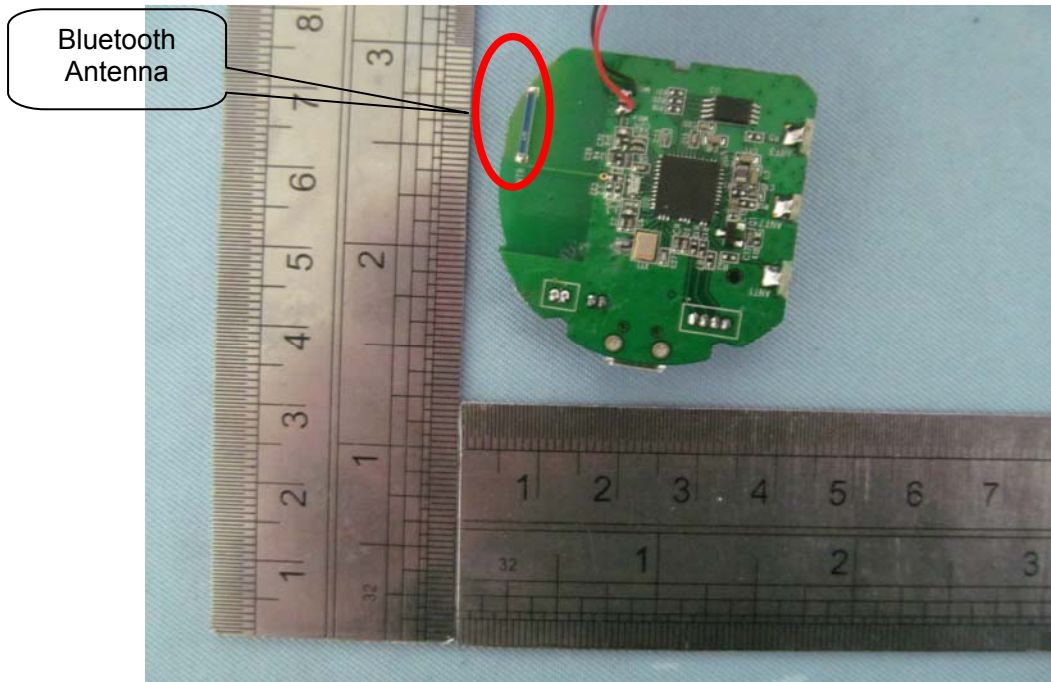

BACK VIEW OF PCB-1

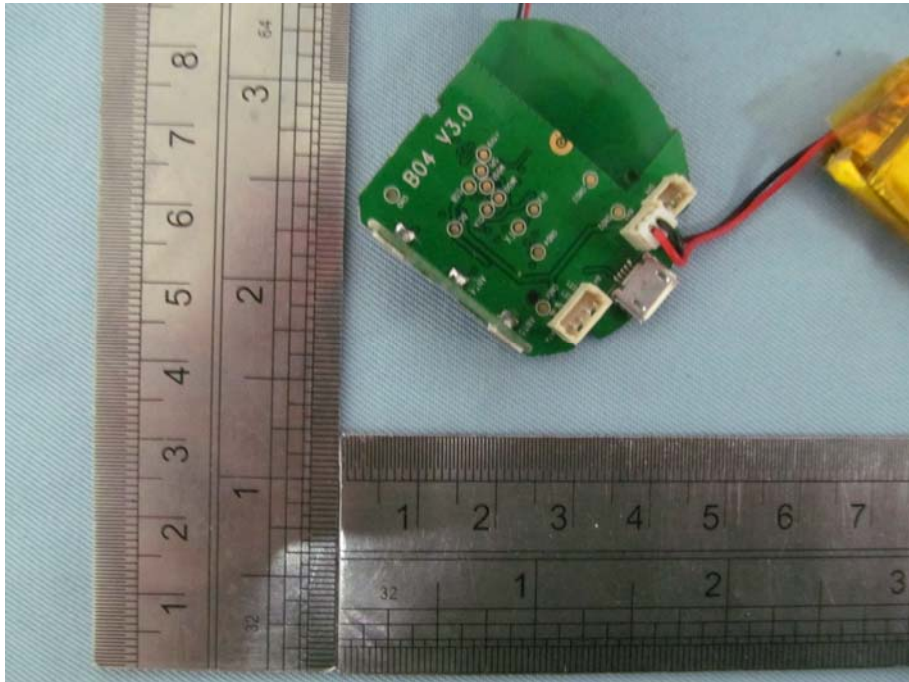

FRONT VIEW OF PCB-2

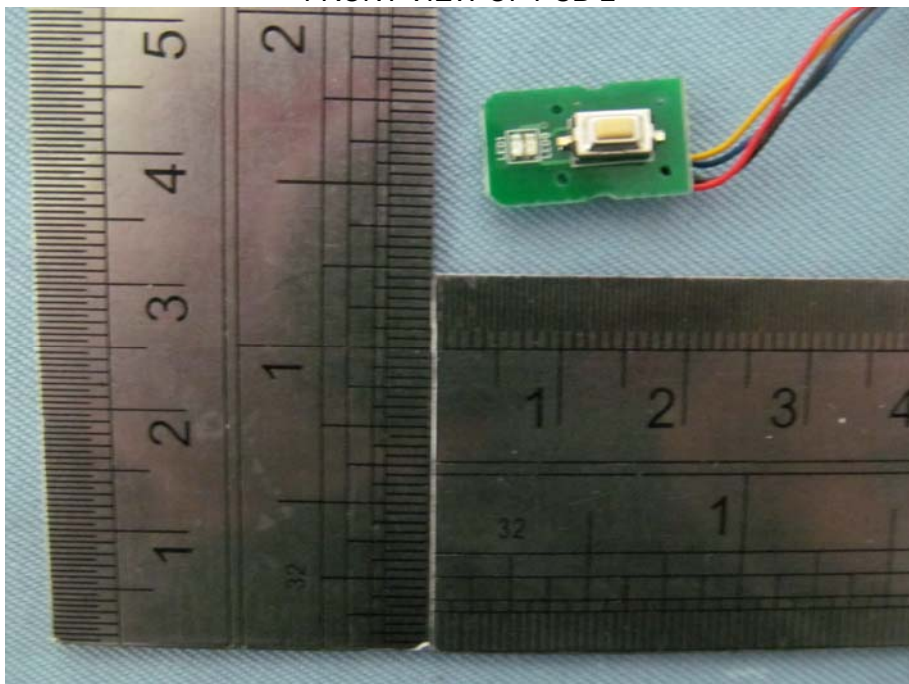

BACK VIEW OF PCB-2

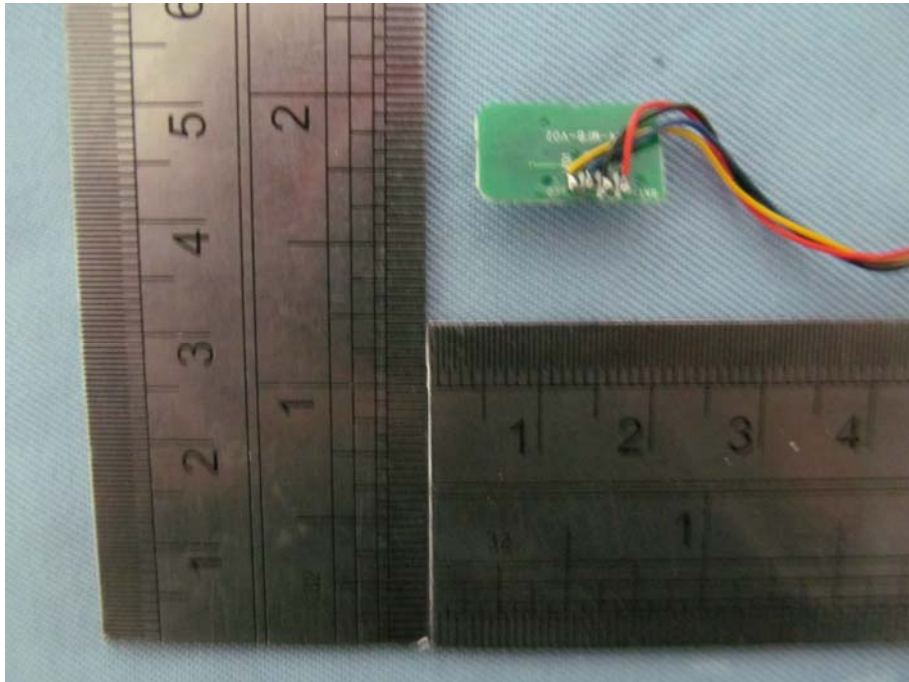

**APPENDIX II  
PHOTOGRAPHS OF THE TEST SETUP  
CONDUCTED EMISSION**



**RADIATED EMISSION**



**----END OF REPORT----**