

TEST REPORT

FCC ID: SF4-BAT103

Product: Bluetooth Audio Transmitter

Model No.: BAT103

Additional Model: BAT103+, BAT103X (“X” can be A to Z, denoting the different appearance and color), AD4, LYXBWR7, Strobe, ZX1596

Trade Mark: BlueXtel, LYXPRO, Proxelle, PEARL

Report No.: TCT160711E001

Issued Date: July 22, 2016

Issued for:

ATI Electronics (ShenZhen) Co. Ltd

**1/F, B Tower, Shengdelan Industrial Park, Kukeng Village, Guanlan Town,
Shenzhen, China.**

Issued By:

Shenzhen Tongce Testing Lab.

1F, Leinuo Watch Building, Fuyong Town, Baoan Dist, Shenzhen, China

TEL: +86-755-27673339

FAX: +86-755-27673332

Note: This report shall not be reproduced except in full, without the written approval of Shenzhen Tongce Testing Lab.

This document may be altered or revised by Shenzhen Tongce Testing Lab. personnel only, and shall be noted in the revision section of the document. The test results in the report only apply to the tested sample.

TABLE OF CONTENTS

1. Test Certification..... 3

2. Test Result Summary 4

3. EUT Description 5

4. General Information 6

 4.1. Test environment and mode..... 6

 4.2. Description of Support Units..... 6

5. Facilities and Accreditations 7

 5.1. Facilities 7

 5.2. Location 7

 5.3. Measurement Uncertainty..... 7

6. Test Results and Measurement Data 8

 6.1. Antenna requirement 8

 6.2. Conducted Emission..... 9

 6.3. Conducted Output Power 13

 6.4. 20dB Occupancy Bandwidth 18

 6.5. Carrier Frequencies Separation 23

 6.6. Hopping Channel Number 28

 6.7. Dwell Time..... 31

 6.8. Pseudorandom Frequency Hopping Sequence..... 34

 6.9. Conducted Band Edge Measurement 35

 6.10. Conducted Spurious Emission Measurement..... 39

 6.11. Radiated Spurious Emission Measurement 43

Appendix A: Photographs of Test Setup

Appendix B: Photographs of EUT

1. Test Certification

Product:	Bluetooth Audio Transmitter
Model No.:	BAT103
Additional Model:	BAT103+, BAT103X ("X" can be A to Z, denoting the different appearance and color), AD4, LYXBWR7, Strobe, ZX1596
Applicant:	ATI Electronics (ShenZhen) Co. Ltd
Address:	1/F, B Tower, Shengdelan Industrial Park, Kukeng Village, Guanlan Town, Shenzhen, China.
Manufacturer:	ATI Electronics (ShenZhen) Co. Ltd
Address:	1/F, B Tower, Shengdelan Industrial Park, Kukeng Village, Guanlan Town, Shenzhen, China.
Date of Test:	July 11 – July 21, 2016
Applicable Standards:	FCC CFR Title 47 Part 15 Subpart C Section 15.247

The above equipment has been tested by Shenzhen Tongce Testing Lab. and found compliance with the requirements set forth in the technical standards mentioned above. The results of testing in this report apply only to the product/system, which was tested. Other similar equipment will not necessarily produce the same results due to production tolerance and measurement uncertainties.

Tested By:



Beryl Zhao

Date:

July 21, 2016

Reviewed By:



Joe Zhou

Date:

July 22, 2016

Approved By:



Tomsin

Date:

July 22, 2016

2. Test Result Summary

Requirement	CFR 47 Section	Result
Antenna Requirement	§15.203/§15.247 (c)	PASS
AC Power Line Conducted Emission	§15.207	PASS
Conducted Peak Output Power	§15.247 (b)(1)	PASS
20dB Occupied Bandwidth	§15.247 (a)(1)	PASS
Carrier Frequencies Separation	§15.247 (a)(1)	PASS
Hopping Channel Number	§15.247 (a)(1)	PASS
Dwell Time	§15.247 (a)(1)	PASS
Radiated Emission	§15.205/§15.209	PASS
Band Edge	§15.247(d)	PASS

Note:

1. PASS: Test item meets the requirement.
2. Fail: Test item does not meet the requirement.
3. N/A: Test case does not apply to the test object.
4. The test result judgment is decided by the limit of test standard.

3. EUT Description

Product Name:	Bluetooth Audio Transmitter
Model :	BAT103
Additional Model:	BAT103+, BAT103X ("X" can be A to Z, denoting the different appearance and color), AD4, LYXBWR7, Strobe, ZX1596
Trade Mark:	BlueXtel, LYXPRO, Proxelle, PEARL
Operation Frequency:	2402MHz~2480MHz
Transfer Rate:	1/2/3 Mbits/s
Number of Channel:	79
Modulation Type:	GFSK, $\pi/4$ -DQPSK, 8DPSK
Modulation Technology:	FHSS
Antenna Type:	Internal Antenna
Antenna Gain:	0dBi
Power Supply:	Rechargeable Li-ion Battery DC3.7V
Remark:	All models above are identical in interior structure, electrical circuits and components, and just model names are different for the marketing requirement.

Operation Frequency each of channel for GFSK, $\pi/4$ -DQPSK, 8DPSK

Channel	Frequency	Channel	Frequency	Channel	Frequency	Channel	Frequency
0	2402MHz	20	2422MHz	40	2442MHz	60	2462MHz
1	2403MHz	21	2423MHz	41	2443MHz	61	2463MHz
...
10	2412MHz	30	2432MHz	50	2452MHz	70	2472MHz
11	2413MHz	31	2433MHz	51	2453MHz	71	2473MHz
...
18	2420MHz	38	2440MHz	58	2460MHz	78	2480MHz
19	2421MHz	39	2441MHz	59	2461MHz	-	-

Remark: Channel 0, 39 & 78 have been tested for GFSK, $\pi/4$ -DQPSK, 8DPSK modulation mode.

4. Genera Information

4.1. Test environment and mode

Operating Environment:	
Temperature:	25.0 °C
Humidity:	56 % RH
Atmospheric Pressure:	1010 mbar
Test Mode:	
Engineering mode:	Keep the EUT in continuous transmitting by select channel and modulations
<p>The sample was placed (0.8m below 1GHz, 1.5m above 1GHz) above the ground plane of 3m chamber. Measurements in both horizontal and vertical polarities were performed. During the test, each emission was maximized by: having the EUT continuously working, investigated all operating modes, rotated about all 3 axis (X, Y & Z) and considered typical configuration to obtain worst position, manipulating interconnecting cables, rotating the turntable, varying antenna height from 1m to 4m in both horizontal and vertical polarizations. The emissions worst-case are shown in Test Results of the following pages.</p>	

4.2. Description of Support Units

The EUT has been tested as an independent unit together with other necessary accessories or support units. The following support units or accessories were used to form a representative test configuration during the tests.

Equipment	Model No.	Serial No.	FCC ID	Trade Name
Noteboob	G485	/	/	Lenove

Note:

1. All the equipment/cables were placed in the worst-case configuration to maximize the emission during the test.
2. Grounding was established in accordance with the manufacturer's requirements and conditions for the intended use.
3. For conducted measurements (Output Power, 20dB Occupied Bandwidth, Carrier Frequencies Separation, Hopping Channel Number, Dwell Time, Spurious Emissions), the antenna of EUT is connected to the test equipment via temporary antenna connector, the antenna connector is soldered on the antenna port of EUT, and the temporary antenna connector is listed in the Test Instruments.

5. Facilities and Accreditations

5.1. Facilities

The test facility is recognized, certified, or accredited by the following organizations:

- FCC - Registration No.: 572331

Shenzhen Tongce Testing Lab

The 3m Semi-anechoic chamber has been registered and fully described in a report with the (FCC) Federal Communications Commission. The acceptance letter from the FCC is maintained in our files.

- IC - Registration No.: 10668A-1

The 3m Semi-anechoic chamber of Shenzhen TCT Testing Technology Co., Ltd. has been registered by Certification and Engineering Bureau of Industry Canada for radio equipment testing

- CNAS - Registration No.: CNAS L6165

Shenzhen TCT Testing Technology Co., Ltd. is accredited to ISO/IEC 17025:2005 General Requirements for the Competence of Testing and Calibration laboratories for the competence of testing. The Registration No. is CNAS L6165.

5.2. Location

Shenzhen Tongce Testing Lab

Address: 1F, Leinuo Watch Building, Fuyong Town, Baoan Dist, Shenzhen, China

Tel: 86-755-36638142

5.3. Measurement Uncertainty

The reported uncertainty of measurement $y \pm U$, where expanded uncertainty U is based on a standard uncertainty multiplied by a coverage factor of $k=2$, providing a level of confidence of approximately 95 %.

No.	Item	MU
1	Conducted Emission	$\pm 2.56\text{dB}$
2	RF power, conducted	$\pm 0.12\text{dB}$
3	Spurious emissions, conducted	$\pm 0.11\text{dB}$
4	All emissions, radiated(<1G)	$\pm 3.92\text{dB}$
5	All emissions, radiated(>1G)	$\pm 4.28\text{dB}$
6	Temperature	$\pm 0.1^\circ\text{C}$
7	Humidity	$\pm 1.0\%$

6. Test Results and Measurement Data

6.1. Antenna requirement

Standard requirement:

FCC Part15 C Section 15.203 /247(c)

15.203 requirement:

An intentional radiator shall be designed to ensure that no antenna other than that furnished by the responsible party shall be used with the device. The use of a permanently attached antenna or of an antenna that uses a unique coupling to the intentional radiator, the manufacturer may design the unit so that a broken antenna can be replaced by the user, but the use of a standard antenna jack or electrical connector is prohibited.

15.247(c) (1)(i) requirement:

(i) Systems operating in the 2400-2483.5 MHz band that is used exclusively for fixed. Point-to-point operations may employ transmitting antennas with directional gain greater than 6dBi provided the maximum conducted output power of the intentional radiator is reduced by 1 dB for every 3 dB that the directional gain of the antenna exceeds 6dBi.

E.U.T Antenna:

The Bluetooth antenna is an internal antenna which permanently attached, and the best case gain of the antenna is 0dBi.

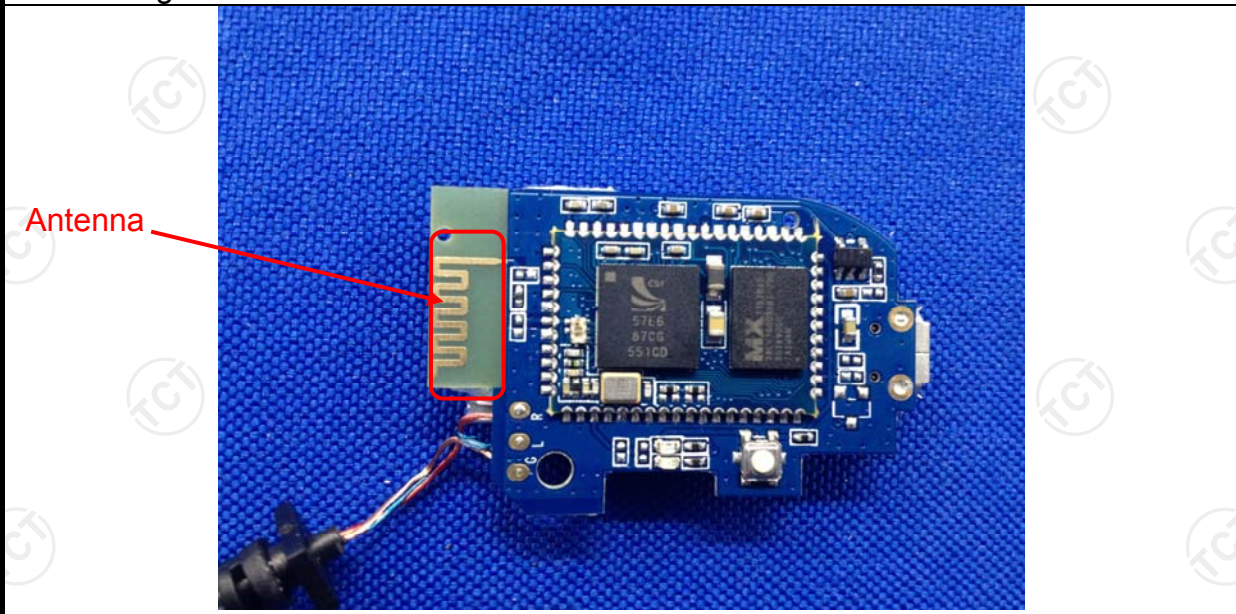

6.2. Conducted Emission

6.2.1. Test Specification

Test Requirement:	FCC Part15 C Section 15.207														
Test Method:	ANSI C63.4:2014														
Frequency Range:	150 kHz to 30 MHz														
Receiver setup:	RBW=9 kHz, VBW=30 kHz, Sweep time=auto														
Limits:	<table border="1"> <thead> <tr> <th rowspan="2">Frequency range (MHz)</th> <th colspan="2">Limit (dBuV)</th> </tr> <tr> <th>Quasi-peak</th> <th>Average</th> </tr> </thead> <tbody> <tr> <td>0.15-0.5</td> <td>66 to 56*</td> <td>56 to 46*</td> </tr> <tr> <td>0.5-5</td> <td>56</td> <td>46</td> </tr> <tr> <td>5-30</td> <td>60</td> <td>50</td> </tr> </tbody> </table>	Frequency range (MHz)	Limit (dBuV)		Quasi-peak	Average	0.15-0.5	66 to 56*	56 to 46*	0.5-5	56	46	5-30	60	50
Frequency range (MHz)	Limit (dBuV)														
	Quasi-peak	Average													
0.15-0.5	66 to 56*	56 to 46*													
0.5-5	56	46													
5-30	60	50													
Test Setup:	<p><i>Remark</i> E.U.T: Equipment Under Test LISN: Line Impedance Stabilization Network Test table height=0.8m</p>														
Test Mode:	Refer to item 4.1														
Test Procedure:	<ol style="list-style-type: none"> 1. The E.U.T and simulators are connected to the main power through a line impedance stabilization network (L.I.S.N.). This provides a 50ohm/50uH coupling impedance for the measuring equipment. 2. The peripheral devices are also connected to the main power through a LISN that provides a 50ohm/50uH coupling impedance with 50ohm termination. (Please refer to the block diagram of the test setup and photographs). 3. Both sides of A.C. line are checked for maximum conducted interference. In order to find the maximum emission, the relative positions of equipment and all of the interface cables must be changed according to ANSI C63.4: 2014 on conducted measurement. 														
Test Result:	PASS														

6.2.2. Test Instruments

Conducted Emission Shielding Room Test Site (843)				
Equipment	Manufacturer	Model	Serial Number	Calibration Due
EMI Test Receiver	R&S	ESCS30	100139	Sep. 11, 2016
LISN	Schwarzbeck	NSLK 8126	8126453	Sep. 16, 2016
Coax cable	TCT	CE-05	N/A	Sep. 11, 2016
EMI Test Software	Shurple Technology	EZ-EMC	N/A	N/A

Note: The calibration interval of the above test instruments is 12 months and the calibrations are traceable to international system unit (SI).

6.2.3. Test data

Please refer to following diagram for individual

Conducted Emission on Line Terminal of the power line (150 kHz to 30MHz)

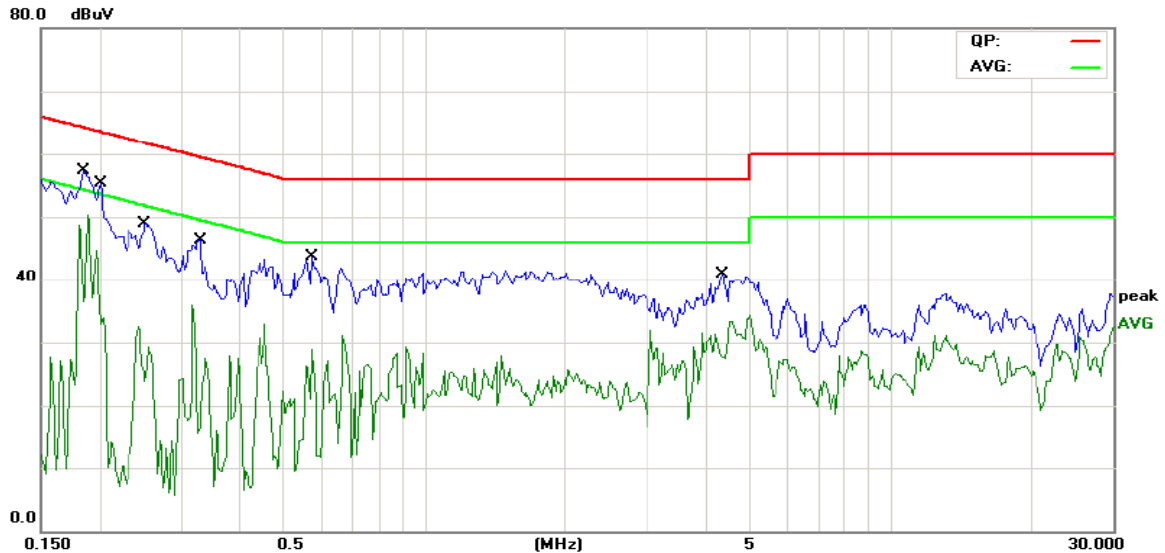

Site Chamber #2 Phase: **L1** Temperature: 23 (C)
Limit: FCC Part 15B Class B Conduction(QP) Power: AC 120V/60Hz Humidity: 54 %

No.	Mk.	Freq.	Reading Level	Correct Factor	Measurement	Limit	Over	Detector	Comment
		MHz	dBuV	dB	dBuV	dBuV	dB		
1	*	0.1852	40.97	11.48	52.45	64.24	-11.79	QP	
2		0.1852	27.27	11.48	38.75	54.24	-15.49	AVG	
3		0.2008	37.96	11.46	49.42	63.57	-14.15	QP	
4		0.2008	21.60	11.46	33.06	53.57	-20.51	AVG	
5		0.2516	33.41	11.43	44.84	61.70	-16.86	QP	
6		0.2516	19.83	11.43	31.26	51.70	-20.44	AVG	
7		0.3297	30.95	11.39	42.34	59.46	-17.12	QP	
8		0.3297	16.95	11.39	28.34	49.46	-21.12	AVG	
9		0.5719	28.45	11.26	39.71	56.00	-16.29	QP	
10		0.5719	12.19	11.26	23.45	46.00	-22.55	AVG	
11		4.3477	24.03	10.85	34.88	56.00	-21.12	QP	
12		4.3477	12.28	10.85	23.13	46.00	-22.87	AVG	

Note:

- Freq. = Emission frequency in MHz
- Reading level (dBuV) = Receiver reading
- Corr. Factor (dB) = Antenna factor + Cable loss
- Measurement (dBuV) = Reading level (dBuV) + Corr. Factor (dB)
- Limit (dBuV) = Limit stated in standard
- Margin (dB) = Measurement (dBuV) – Limits (dBuV)
- Q.P. =Quasi-Peak
- AVG =average
- * is meaning the worst frequency has been tested in the frequency range 150 kHz to 30MHz.

Conducted Emission on Neutral Terminal of the power line (150 kHz to 30MHz)

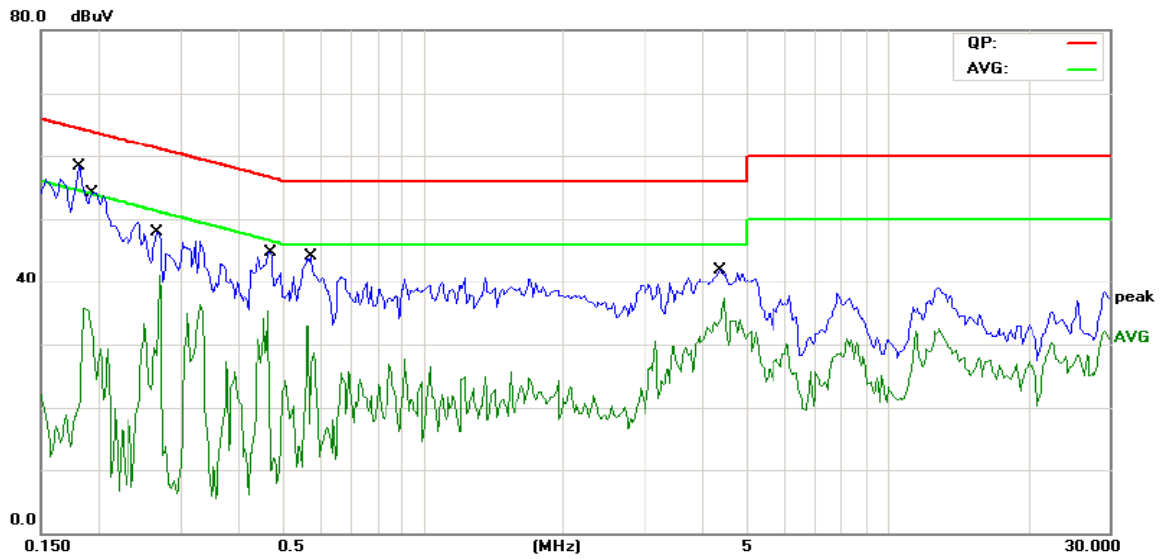

Site Chamber #2 Phase: **N** Temperature: 23 (C)
 Limit: FCC Part 15B Class B Conduction(QP) Power: AC 120V/60Hz Humidity: 54 %

No.	Mk.	Freq. MHz	Reading Level dBuV	Correct Factor dB	Measure- ment dBuV	Limit dBuV	Over dB	Detector	Comment
1	*	0.1812	42.28	11.48	53.76	64.43	-10.67	QP	
2		0.1812	23.91	11.48	35.39	54.43	-19.04	AVG	
3		0.1930	40.69	11.46	52.15	63.90	-11.75	QP	
4		0.1930	26.76	11.46	38.22	53.90	-15.68	AVG	
5		0.2711	32.98	11.42	44.40	61.08	-16.68	QP	
6		0.2711	12.05	11.42	23.47	51.08	-27.61	AVG	
7		0.4703	30.31	11.31	41.62	56.51	-14.89	QP	
8		0.4703	14.03	11.31	25.34	46.51	-21.17	AVG	
9		0.5719	27.96	11.26	39.22	56.00	-16.78	QP	
10		0.5719	12.67	11.26	23.93	46.00	-22.07	AVG	
11		4.3516	26.17	10.85	37.02	56.00	-18.98	QP	
12		4.3516	14.89	10.85	25.74	46.00	-20.26	AVG	

Note1:

Freq. = Emission frequency in MHz

Reading level (dBuV) = Receiver reading

Corr. Factor (dB) = Antenna factor + Cable loss

Measurement (dBuV) = Reading level (dBuV) + Corr. Factor (dB)

Limit (dBuV) = Limit stated in standard

Margin (dB) = Measurement (dBuV) – Limits (dBuV)

Q.P. =Quasi-Peak

AVG =average

* is meaning the worst frequency has been tested in the frequency range 150 kHz to 30MHz.

Note2:

Measurements were conducted in all three channels (high, middle, low) and three modulation (GFSK, Pi/4 DQPSK, 8DPSK), and the worst case Mode (Lowest channel and GFSK) was submitted only.

6.3. Conducted Output Power

6.3.1. Test Specification

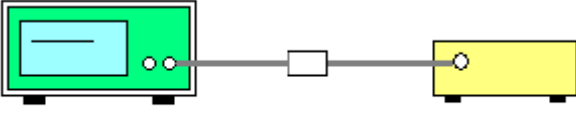
Test Requirement:	FCC Part15 C Section 15.247 (b)(3)
Test Method:	ANSI C63.10:2013 and DA00-705
Limit:	Section 15.247 (b) The maximum peak conducted output power of the intentional radiator shall not exceed the following: (1) For frequency hopping systems operating in the 2400-2483.5 MHz band employing at least 75 non-overlapping hopping channels, and all frequency hopping systems in the 5725-5850 MHz band: 1 watt. For all other frequency hopping systems in the 2400-2483.5 MHz band 0.125 watts.
Test Setup:	 <p style="text-align: center;">Spectrum Analyzer EUT</p>
Test Mode:	Transmitting mode with modulation
Test Procedure:	Use the following spectrum analyzer settings: Span = approximately 5 times the 20 dB bandwidth, centered on a hopping channel RBW > the 20 dB bandwidth of the emission being measured VBW ≥ RBW Sweep = auto Detector function = peak Trace = max hold Allow the trace to stabilize. Use the marker-to-peak function to set the marker to the peak of the emission.
Test Result:	PASS

6.3.2. Test Instruments

Equipment	Manufacturer	Model	Serial Number	Calibration Due
Spectrum Analyzer	R&S	FSU	200054	Sep. 11, 2016
RF Cable	TCT	RE-06	N/A	Sep. 12, 2016
Antenna Connector	TCT	RFC-01	N/A	Sep. 12, 2016

Note: The calibration interval of the above test instruments is 12 months and the calibrations are traceable to international system unit (SI).

6.3.3. Test Data

GFSK mode			
Test channel	Peak Output Power (dBm)	Limit (dBm)	Result
Lowest	3.06	21.00	PASS
Middle	2.16	21.00	PASS
Highest	1.57	21.00	PASS

Pi/4DQPSK mode			
Test channel	Peak Output Power (dBm)	Limit (dBm)	Result
Lowest	2.29	21.00	PASS
Middle	0.87	21.00	PASS
Highest	-0.55	21.00	PASS

8DPSK mode			
Test channel	Peak Output Power (dBm)	Limit (dBm)	Result
Lowest	2.57	21.00	PASS
Middle	1.22	21.00	PASS
Highest	-0.12	21.00	PASS

Test plots as follows:

Lowest channel

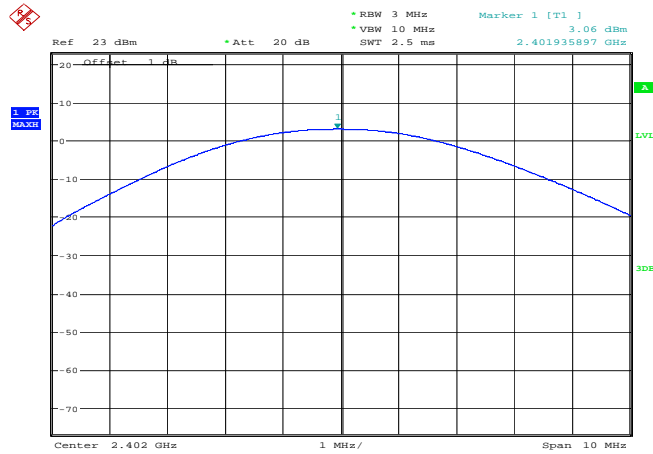

Date: 14.JUL.2016 14:48:01

Middle channel

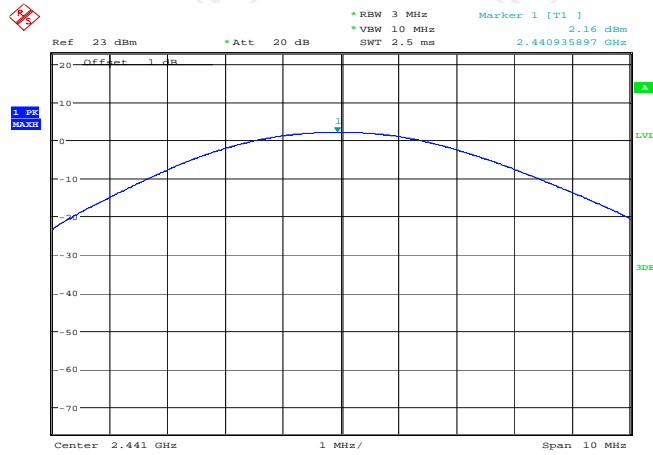

Date: 14.JUL.2016 15:07:02

Highest channel

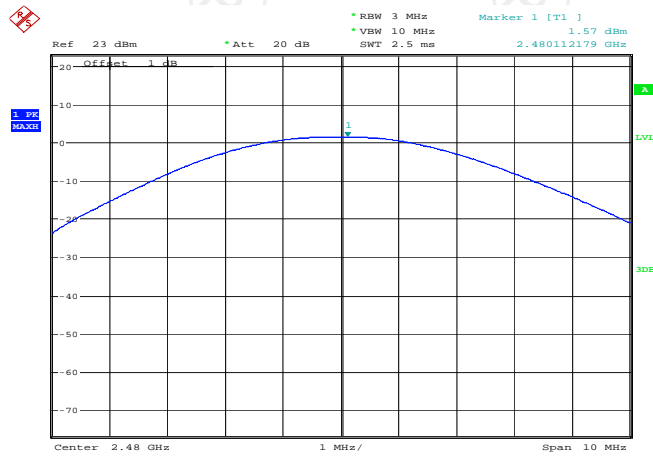

Date: 15.JUL.2016 14:37:41

Pi/4DQPSK Modulation

Lowest channel

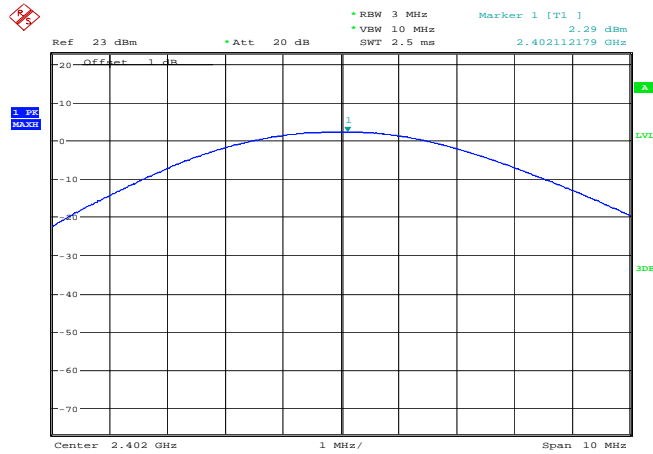

Date: 14.JUL.2016 15:11:42

Middle channel

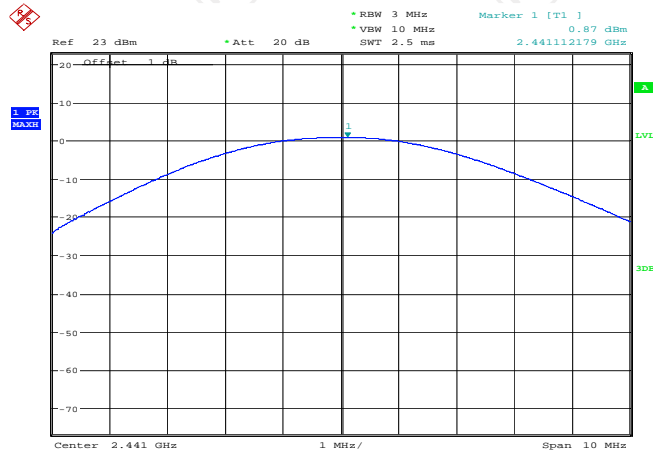

Date: 14.JUL.2016 15:13:03

Highest channel

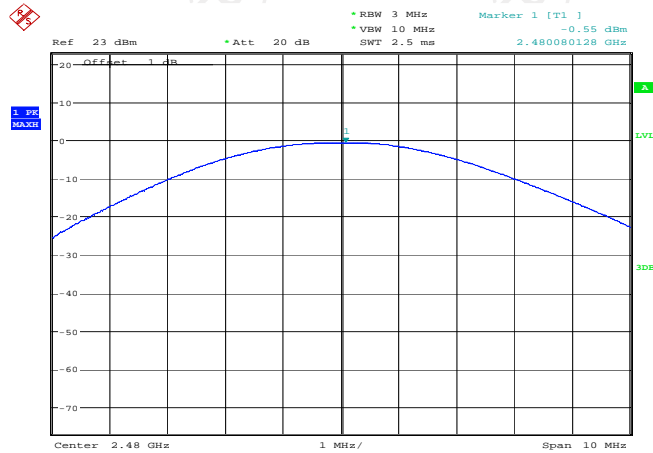

Date: 14.JUL.2016 15:13:49

Lowest channel

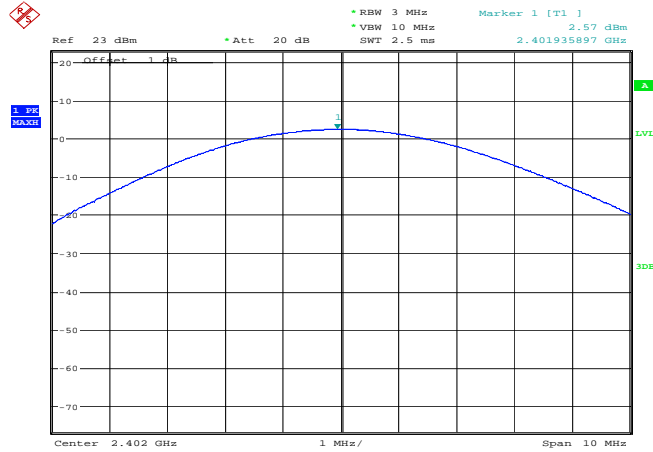

Date: 14.JUL.2016 15:15:20

Middle channel

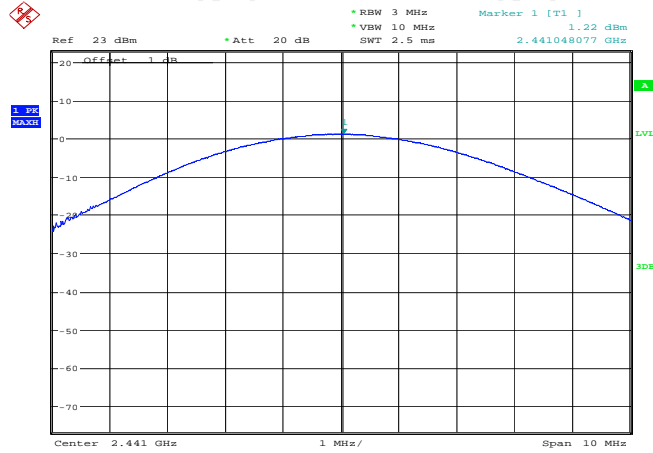

Date: 14.JUL.2016 15:18:05

Highest channel

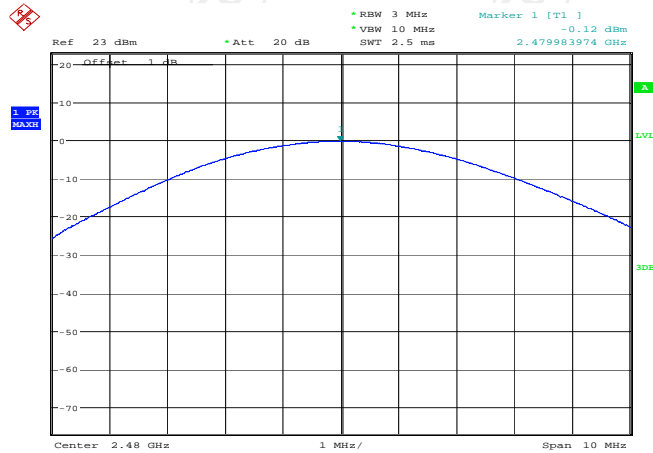

Date: 14.JUL.2016 15:18:52

6.4. 20dB Occupy Bandwidth

6.4.1. Test Specification

Test Requirement:	FCC Part15 C Section 15.247 (a)(1)
Test Method:	ANSI C63.10:2013 and DA00-705
Limit:	N/A
Test Setup:	 <p style="text-align: center;">Spectrum Analyzer EUT</p>
Test Mode:	Transmitting mode with modulation
Test Procedure:	<ol style="list-style-type: none"> 1. The testing follows FCC Public Notice DA 00-705 Measurement Guidelines. 2. The RF output of EUT was connected to the spectrum analyzer by RF cable and attenuator. The path loss was compensated to the results for each measurement. 3. Set to the maximum power setting and enable the EUT transmit continuously. 4. Use the following spectrum analyzer settings for 20dB Bandwidth measurement. Span = approximately 2 to 3 times the 20 dB bandwidth, centered on a hopping channel; RBW\geq1% of the 20 dB bandwidth; VBW\geqRBW; Sweep = auto; Detector function = peak; Trace = max hold. 5. Measure and record the results in the test report.
Test Result:	PASS

6.4.2. Test Instruments

RF Test Room				
Equipment	Manufacturer	Model	Serial Number	Calibration Due
Spectrum Analyzer	R&S	FSU	200054	Sep. 11, 2016
RF cable	TCT	RE-06	N/A	Sep. 12, 2016
Antenna Connector	TCT	RFC-01	N/A	Sep. 12, 2016

Note: The calibration interval of the above test instruments is 12 months and the calibrations are traceable to international system unit (SI).

6.4.3. Test data

Test channel	20dB Occupy Bandwidth (kHz)			
	GFSK	$\pi/4$ -DQPSK	8DPSK	Conclusion
Lowest	817.31	942.31	1227.56	PASS
Middle	846.15	1205.13	1233.97	PASS
Highest	842.95	1211.54	1211.54	PASS

Test plots as follows:

Lowest channel

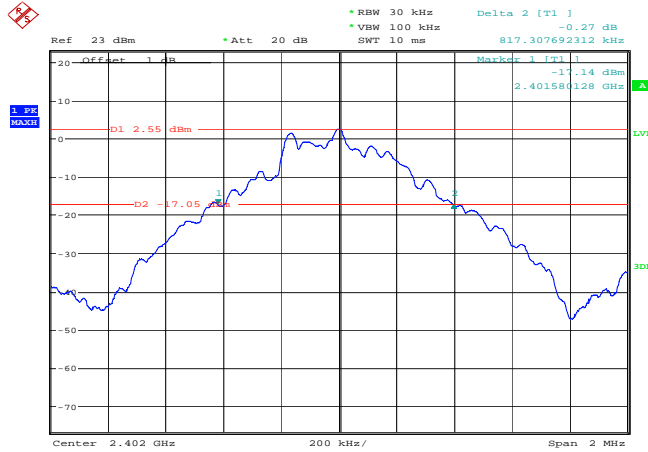

Date: 14.JUL.2016 12:39:13

Middle channel

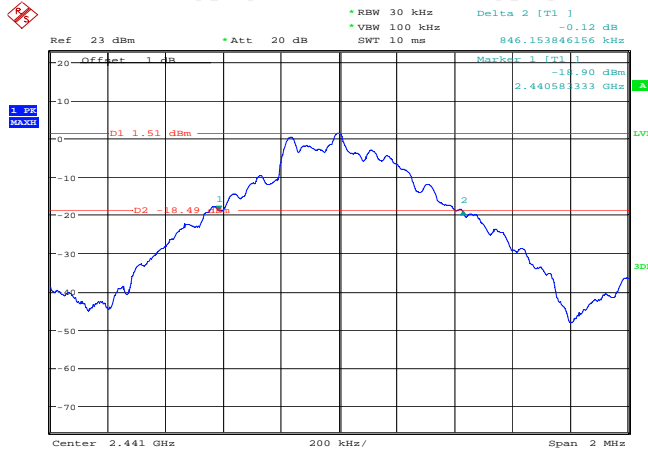

Date: 14.JUL.2016 12:44:43

Highest channel

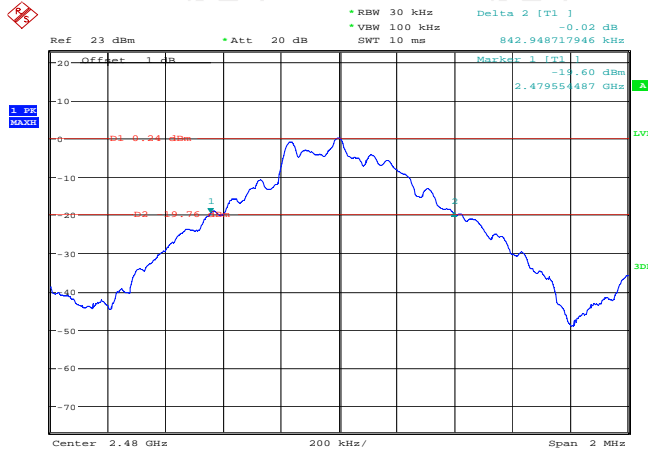

Date: 14.JUL.2016 12:48:03

Lowest channel

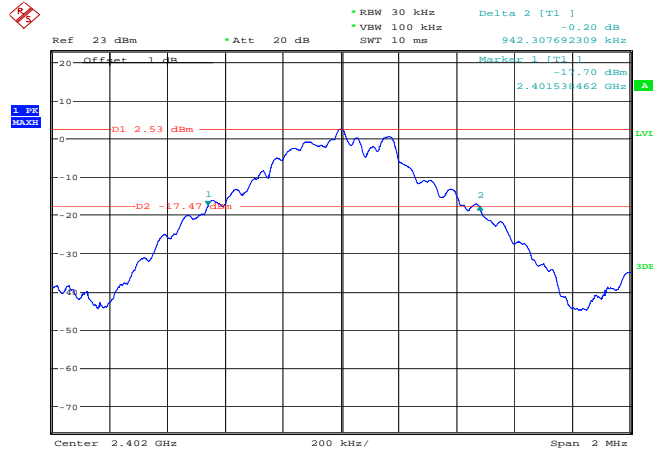

Date: 14.JUL.2016 14:19:40

Middle channel

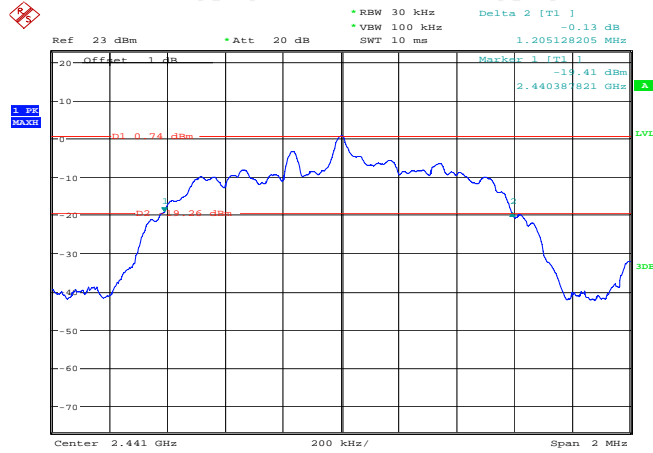

Date: 14.JUL.2016 14:29:24

Highest channel

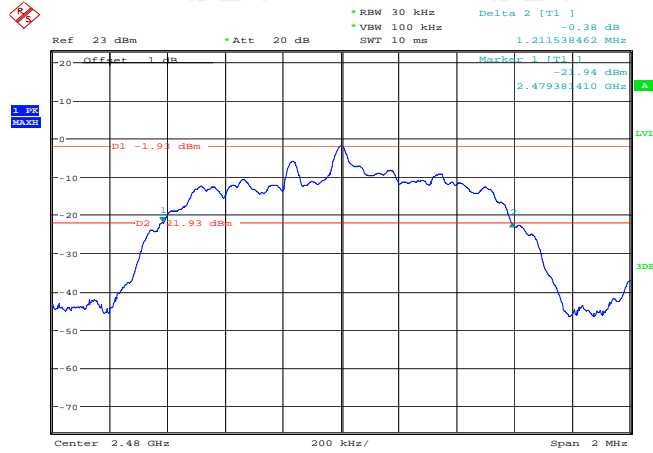

Date: 14.JUL.2016 14:31:34

Lowest channel

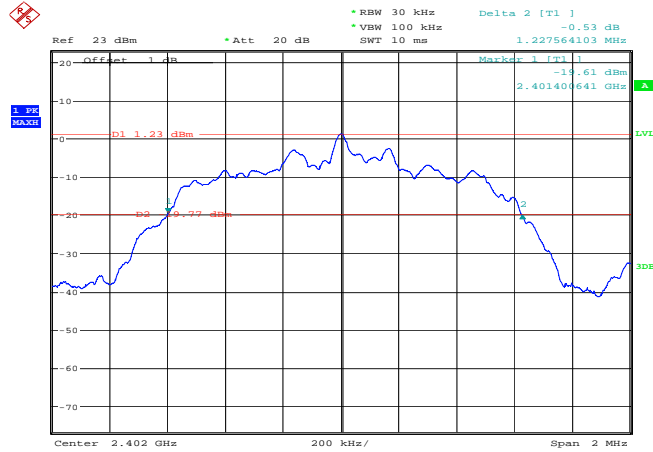

Date: 14.JUL.2016 14:35:43

Middle channel

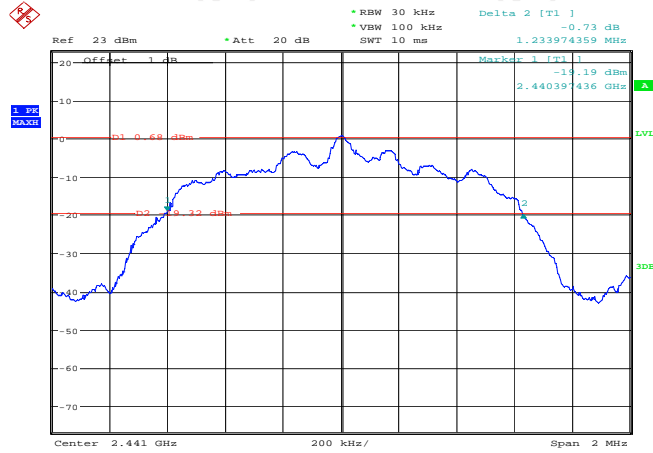

Date: 14.JUL.2016 14:39:19

Highest channel

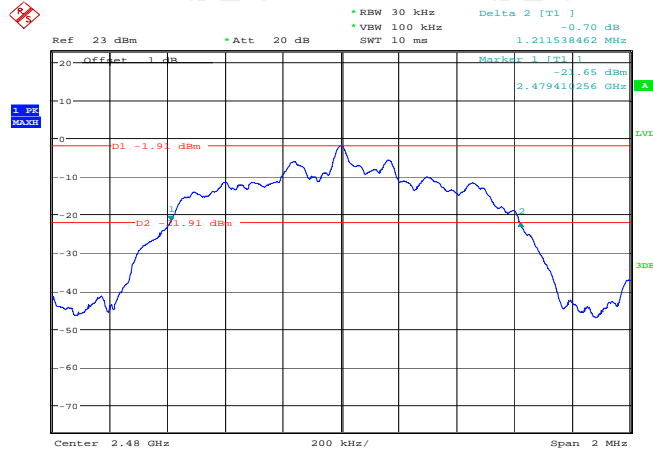

Date: 14.JUL.2016 14:42:27

6.5. Carrier Frequencies Separation

6.5.1. Test Specification

Test Requirement:	FCC Part15 C Section 15.247 (a)(1)
Test Method:	ANSI C63.10:2013 and DA00-705
Limit:	Frequency hopping systems operating in the 2400-2483.5 MHz band may have hopping channel carrier frequencies that are separated by 25 kHz or two-thirds of the 20 dB bandwidth of the hopping channel, whichever is greater.
Test Setup:	 <p style="text-align: center;">Spectrum Analyzer EUT</p>
Test Mode:	Hopping mode
Test Procedure:	<ol style="list-style-type: none"> 1. The testing follows FCC Public Notice DA 00-705 Measurement Guidelines. 2. The RF output of EUT was connected to the spectrum analyzer by RF cable and attenuator. The path loss was compensated to the results for each measurement. 3. Set to the maximum power setting and enable the EUT transmit continuously. 4. Enable the EUT hopping function. 5. Use the following spectrum analyzer settings: Span = wide enough to capture the peaks of two adjacent channels; RBW\geq1% of the span; VBW\geqRBW; Sweep = auto; Detector function = peak; Trace = max hold. 6. Measure and record the results in the test report.
Test Result:	PASS

6.5.2. Test Instruments

RF Test Room				
Equipment	Manufacturer	Model	Serial Number	Calibration Due
Spectrum Analyzer	R&S	FSU	200054	Sep. 11, 2016
RF cable	TCT	RE-06	N/A	Sep. 12, 2016
Antenna Connector	TCT	RFC-01	N/A	Sep. 12, 2016

Note: The calibration interval of the above test instruments is 12 months and the calibrations are traceable to international system unit (SI).

6.5.3. Test data

GFSK mode			
Test channel	Carrier Frequencies Separation (kHz)	Limit (kHz)	Result
Lowest	1006.41	564.10	PASS
Middle	1006.41	564.10	PASS
Highest	1003.21	564.10	PASS

Pi/4 DQPSK mode			
Test channel	Carrier Frequencies Separation (kHz)	Limit (kHz)	Result
Lowest	1000	807.69	PASS
Middle	1000	807.69	PASS
Highest	1000	807.69	PASS

8DPSK mode			
Test channel	Carrier Frequencies Separation (kHz)	Limit (kHz)	Result
Lowest	1000	822.65	PASS
Middle	996.79	822.65	PASS
Highest	1000	822.65	PASS

Note: According to section 6.4

Mode	20dB bandwidth (kHz) (worse case)	Limit (kHz) (Carrier Frequencies Separation)
GFSK	846.15	564.10
$\pi/4$ -DQPSK	1211.54	807.69
8DPSK	1233.97	822.65

Test plots as follows:

Lowest channel

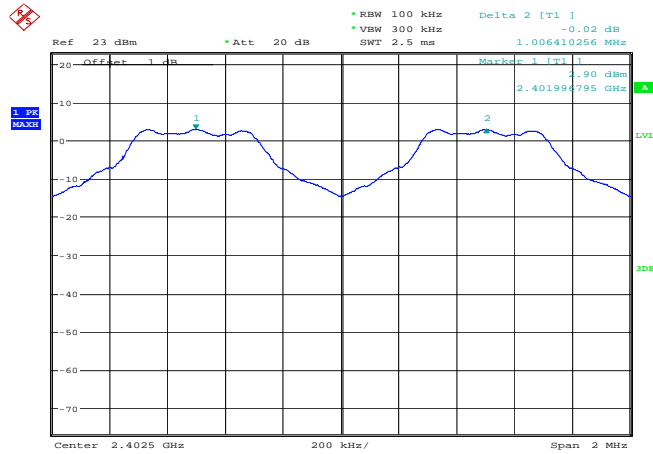

Date: 14.JUL.2016 15:22:41

Middle channel

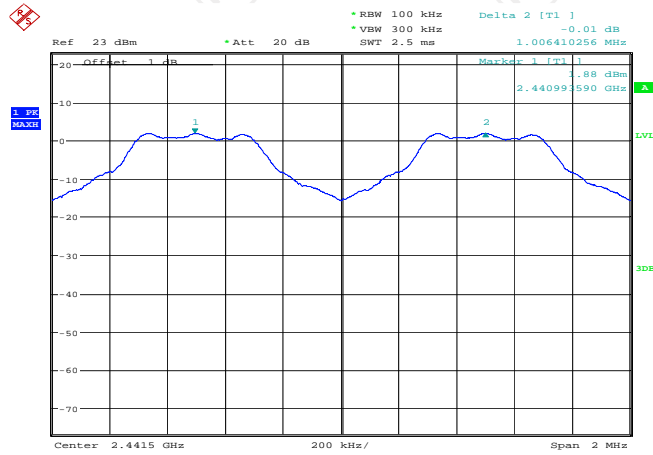

Date: 14.JUL.2016 15:29:32

Highest channel

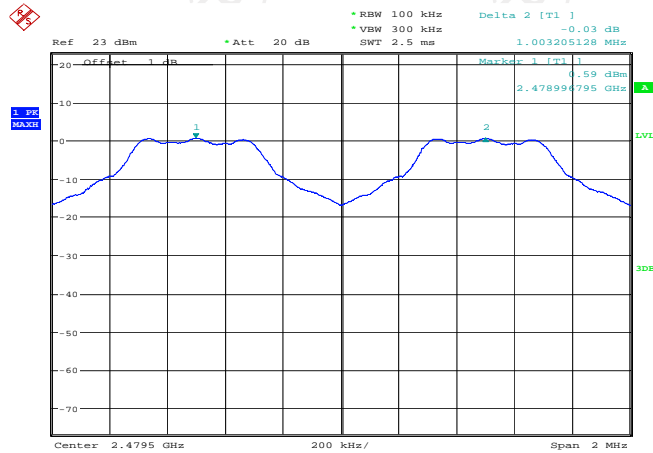

Date: 14.JUL.2016 15:32:00

Lowest channel

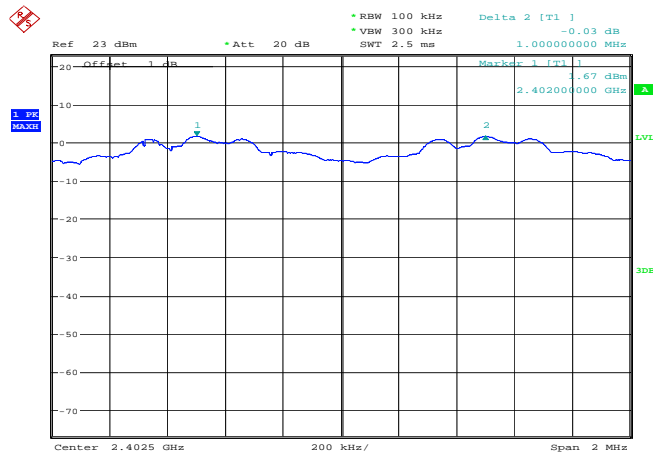

Date: 14.JUL.2016 15:34:14

Middle channel

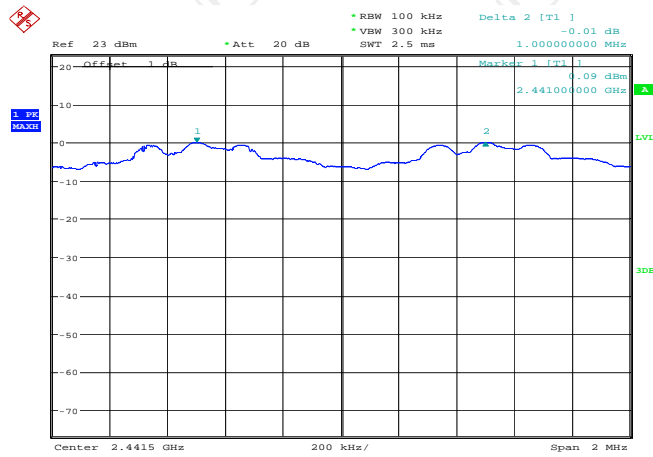

Date: 14.JUL.2016 15:55:55

Highest channel

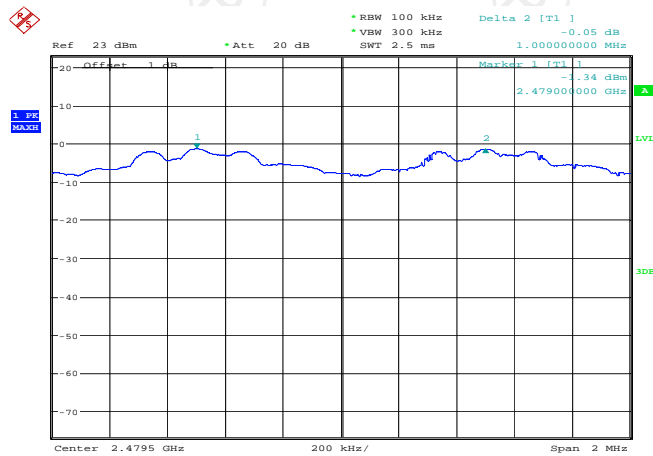

Date: 14.JUL.2016 15:57:17

Lowest channel

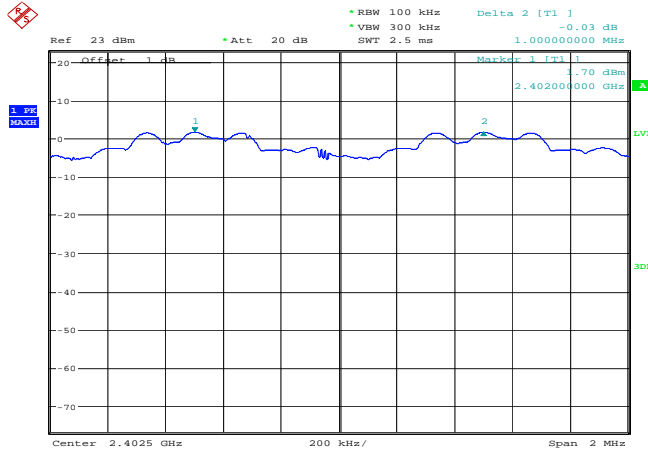

Date: 14.JUL.2016 15:58:59

Middle channel

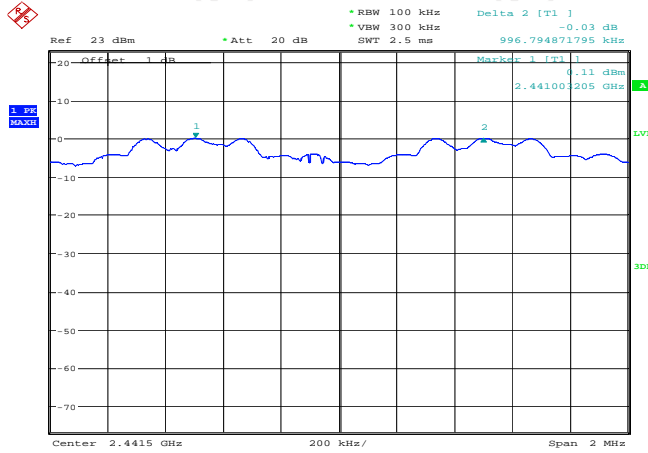

Date: 14.JUL.2016 16:01:02

Highest channel

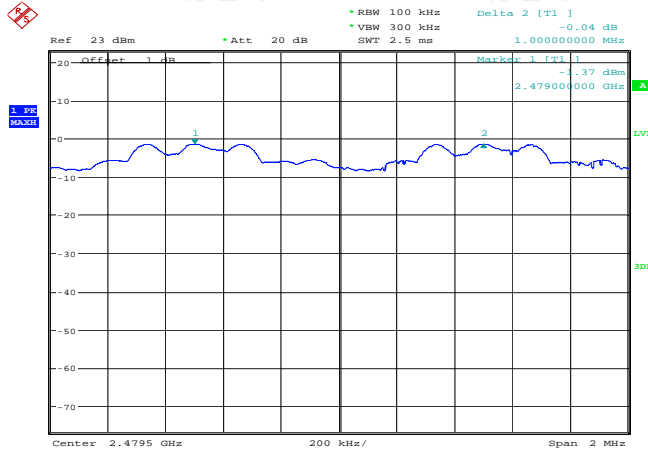

Date: 14.JUL.2016 16:02:27

6.6. Hopping Channel Number

6.6.1. Test Specification

Test Requirement:	FCC Part15 C Section 15.247 (a)(1)
Test Method:	ANSI C63.10:2013 and DA00-705
Limit:	Frequency hopping systems in the 2400-2483.5 MHz band shall use at least 15 channels.
Test Setup:	 <p style="text-align: center;">Spectrum Analyzer EUT</p>
Test Mode:	Hopping mode
Test Procedure:	<ol style="list-style-type: none"> 1. The testing follows FCC Public Notice DA 00-705 Measurement Guidelines. 2. The RF output of EUT was connected to the spectrum analyzer by RF cable and attenuator. The path loss was compensated to the results for each measurement. 3. Set to the maximum power setting and enable the EUT transmit continuously. 4. Enable the EUT hopping function. 5. Use the following spectrum analyzer settings: Span = the frequency band of operation; RBW $\geq 1\%$ of the span; VBW \geq RBW; Sweep = auto; Detector function = peak; Trace = max hold. 6. The number of hopping frequency used is defined as the number of total channel. 7. Record the measurement data derived from spectrum analyzer.
Test Result:	PASS

6.6.2. Test Instruments

RF Test Room				
Equipment	Manufacturer	Model	Serial Number	Calibration Due
Spectrum Analyzer	R&S	FSU	200054	Sep. 11, 2016
RF cable	TCT	RE-06	N/A	Sep. 12, 2016
Antenna Connector	TCT	RFC-01	N/A	Sep. 12, 2016

Note: The calibration interval of the above test instruments is 12 months and the calibrations are traceable to international system unit (SI).

6.6.3. Test data

Mode	Hopping channel numbers	Limit	Result
GFSK, P/4-DQPSK, 8DPSK	79	15	PASS

Test plots as follows:



GFSK

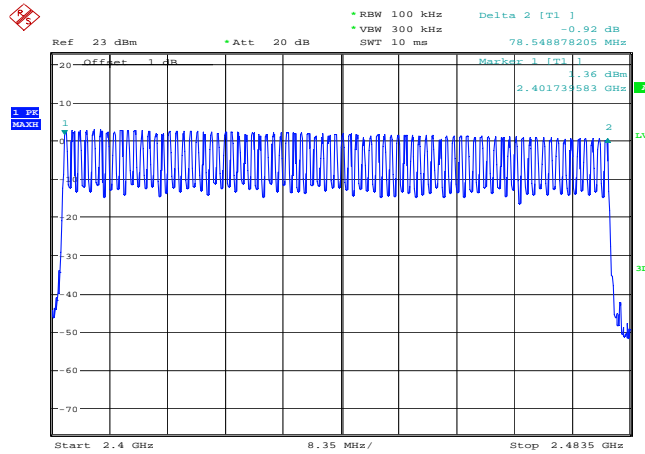

Date: 14.JUL.2016 16:11:24

Pi/4DQPSK

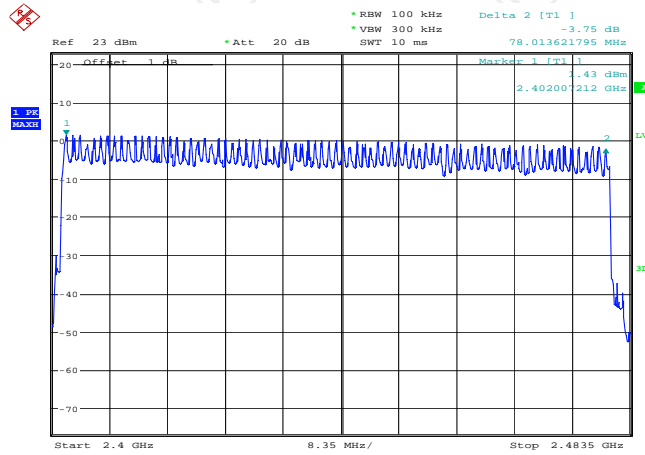

Date: 14.JUL.2016 16:14:11

8DPSK

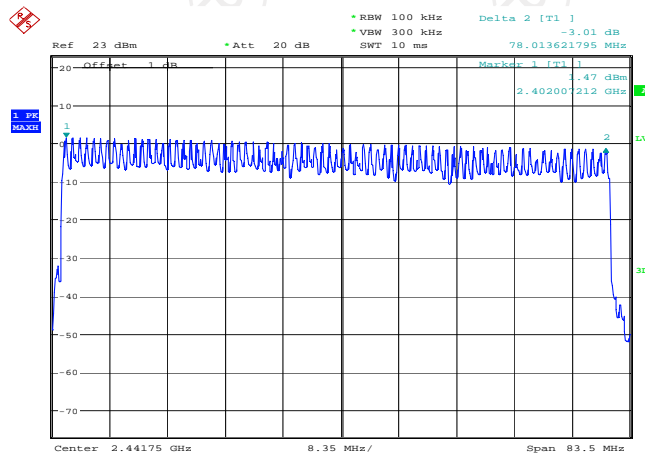

Date: 14.JUL.2016 16:16:37

6.7. Dwell Time

6.7.1. Test Specification

Test Requirement:	FCC Part15 C Section 15.247 (a)(1)
Test Method:	ANSI C63.10:2013 and DA00-705
Limit:	The average time of occupancy on any channel shall not be greater than 0.4 seconds within a period of 0.4 seconds multiplied by the number of hopping channels employed.
Test Setup:	 <p style="text-align: center;">Spectrum Analyzer EUT</p>
Test Mode:	Hopping mode
Test Procedure:	<ol style="list-style-type: none"> 1. The testing follows FCC Public Notice DA 00-705 Measurement Guidelines. 2. The RF output of EUT was connected to the spectrum analyzer by RF cable and attenuator. The path loss was compensated to the results for each measurement. 3. Set to the maximum power setting and enable the EUT transmit continuously. 4. Enable the EUT hopping function. 5. Use the following spectrum analyzer settings: Span = zero span, centered on a hopping channel; RBW = 1 MHz; VBW≥RBW; Sweep = as necessary to capture the entire dwell time per hopping channel; Detector function = peak; Trace = max hold. 6. Measure and record the results in the test report.
Test Result:	PASS

6.7.2. Test Instruments

RF Test Room				
Equipment	Manufacturer	Model	Serial Number	Calibration Due
Spectrum Analyzer	R&S	FSU	200054	Sep. 11, 2016
RF cable	TCT	RE-06	N/A	Sep. 12, 2016
Antenna Connector	TCT	RFC-01	N/A	Sep. 12, 2016

Note: The calibration interval of the above test instruments is 12 months and the calibrations are traceable to international system unit (SI).

6.7.3. Test Data

Mode	Packet	Hops Over Occupancy Time (hops)	Package Transfer Time (ms)	Dwell time (second)	Limit (second)	Result
GFSK	DH5	106.67	3.06	0.33	0.4	PASS
Pi/4 DQPSK	2-DH5	106.67	3.06	0.33	0.4	PASS
8DPSK	3-DH5	106.67	3.08	0.33	0.4	PASS

Note: 1. In normal mode, hopping rate is 1600 hops/s with 6 slots in 79 hopping channels.

With channel hopping rate (1600 / 6 / 79) in Occupancy Time Limit (0.4 x 79) (s), Hops Over Occupancy Time comes to (1600 / 6 / 79) x (0.4 x 79) = 106.67 hops

2. Dwell Time(s) = Hops Over Occupancy Time (hops) x Package Transfer Time

Test plots as follows:

GFSK

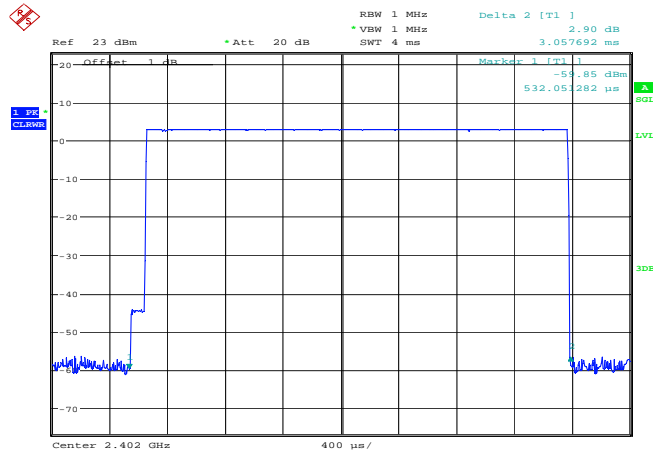

Date: 14.JUL.2016 16:22:47

Pi/4DQPSK

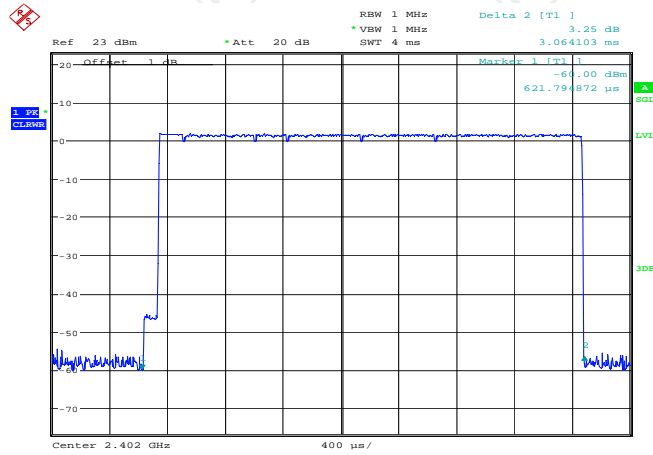

Date: 14.JUL.2016 16:25:35

8DPSK

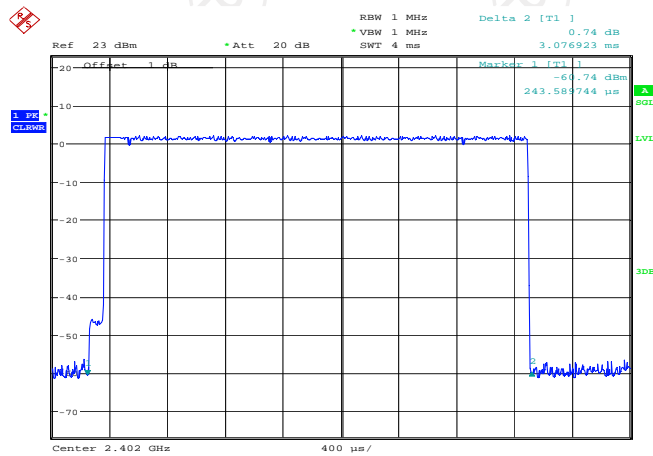

Date: 14.JUL.2016 16:29:03

6.8. Pseudorandom Frequency Hopping Sequence

Test Requirement: FCC Part15 C Section 15.247 (a)(1) requirement:

Frequency hopping systems shall have hopping channel carrier frequencies separated by a minimum of 25 kHz or the 20 dB bandwidth of the hopping channel, whichever is greater.

Alternatively. Frequency hopping systems operating in the 2400-2483.5 MHz band may have hopping channel carrier frequencies that are separated by 25 kHz or two-thirds of the 20 dB bandwidth of the hopping channel, whichever is greater, provided the systems operate with an output power no greater than 125 mW. The system shall hop to channel frequencies that are selected at the system hopping rate from a Pseudorandom ordered list of hopping frequencies. Each frequency must be used equally on the average by each transmitter. The system receivers shall have input bandwidths that match the hopping channel bandwidths of their corresponding transmitters and shall shift frequencies in synchronization with the transmitted signals.

EUT Pseudorandom Frequency Hopping Sequence

The pseudorandom sequence may be generated in a nine-stage shift register whose 5th and 9th stage outputs are added in a modulo-two addition stage. And the result is fed back to the input of the first stage. The sequence begins with the first one of 9 consecutive ones; i.e. the shift register is initialized with nine ones.

- Number of shift register stages: 9
- Length of pseudo-random sequence: $2^9 - 1 = 511$ bits
- Longest sequence of zeros: 8 (non-inverted signal)

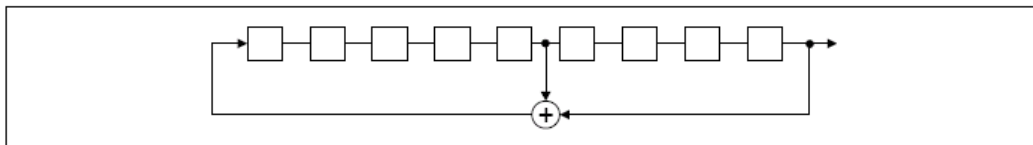

Linear Feedback Shift Register for Generation of the PRBS sequence

An example of Pseudorandom Frequency Hopping Sequence as follow:

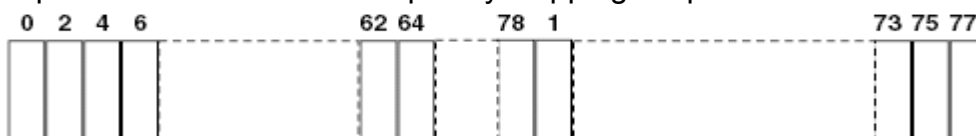

Each frequency used equally on the average by each transmitter. The system receivers have input bandwidths that match the hopping channel bandwidths of their corresponding transmitters and shift frequencies in synchronization with the transmitted signals.