

HYUNDAI CALIBRATION & CERTIFICATION TECH. CO., LTD.



PRODUCT COMPLIANCE DIVISION
SAN 136-1, AMI-RI, BUBAL-EUP, ICHEON-SI, KYOUNGKI-DO, 467-701, KOREA
TEL : +82 31 639 8518 FAX : +82 31 639 8525 www.hct.co.kr



CERTIFICATE OF COMPLIANCE

FCC Part 24 & 22 Certification

Permissive Change Class II

KTF Technologies Co., Ltd.

9th Fl. Shinyoung Tower 265-3(4), Seohyun-Dong,
Bundang-Gu, Sungnam-City, Kyunggi-Do, Korea 463-769

FRN: 0011287885

Date of Issue : April 18, 2005

Test Report No.: HCT-SAR05-0406

Test Site: HYUNDAI CALIBRATION & CERTIFICATION
TECHNOLOGIES CO., LTD.

FRN: 0005866421

FCC ID :

SDJKTFT-UX200

APPLICANT :

KTF Technologies Co., Ltd.

Change of contents:

Antenna have been changed

EUT Type: Tri-Mode Dual-Band Phone (AMPS/CDMA/ PCS CDMA) - Prototype
Tx Frequency: 824.04 — 848.97 MHz (AMPS) / 824.70 — 848.31 MHz (CDMA)
1851.25 — 1908.75 MHz (PCS CDMA)
Rx Frequency: 869.04 — 893.97 MHz (AMPS) / 869.70 — 893.31 MHz (CDMA)
1931.25 — 1988.75 MHz (PCS CDMA)
Max. RF Output Power: 0.337W ERP AMPS (25.27dBm) / 0.276W ERP CDMA (24.41dBm)
0.233W EIRP PCS CDMA (23.67dBm)
Trade Name/Model(s): KTFT / KTFT-UX200
FCC Classification: Licensed Portable Transmitter Held to Ear (PCE)
Application Type: Certification
FCC Rule Part(s): §24(E), §22(H), §2
Maximum SAR: 0.943 W/kg AMPS Head SAR / 0.714 W/kg AMPS Body SAR
0.742 W/kg CDMA Head SAR / 0.550 W/kg CDMA Body SAR
1.310 W/kg PCS CDMA Head SAR / 0.734W/kg PCS CDMA Body SAR
Antenna Specifications: Manufacturer: MRW Technologies Ltd.
PN: MRT-06600 (Length= 85 mm)
Emission Designator(s): 40K0F8W, 40K0F1D, 1M28F9W

This equipment has been shown to be capable of compliance with the applicable technical standards as indicated in the measurement report and was tested in accordance with the measurement procedures specified in § 2.947.

I attest to the accuracy of data. All measurements reported herein were performed by me or were made under my supervision and are correct to the best of my knowledge and belief. I assume full responsibility for the completeness of these measurements and vouch for the qualifications of all persons taking them.

Hyundai C-Tech Co., Ltd. Certifies that no party to this application has been denied FCC benefits pursuant to section 5301 of the Anti- Drug Abuse Act of 1998, 21 U.S. C. 853(a)

Report prepared by: **Ki-Soo Kim**

Manager of Product Compliance Team



This report only responds to the tested sample and may not be reproduced, except in full, without written approval of the HCT Co., Ltd.

Table of Contents

ATTACHMENT A: COVER LETTER(S)

ATTACHMENT B: ATTESTATION STATEMENT(S)

ATTACHMENT C: TEST REPORT

1.1 SCOPE -----	3
2.1 INTRODUCTION -----	4
3.1 INSERTS PER §2.1033(d)-----	5
4.1 DESCRIPTION OF TESTS-----	6-15
5.1 EFFECTIVE RADIATED POWER OUTPUT -----	16-17
6.1 EQUIVALENT ISOTROPIC RADIATED POWER-----	18
7.1 RADIATED MEASUREMENTS-----	19-27
8.1 FREQUENCY STABILITY -----	28-29
9.1 PLOTS OF EMISSIONS-----	30
10.1 LIST OF TEST EQUIPMENT -----	31
11.1 SAMPLE CALCULATIONS -----	32
12.1 CONCLUSION-----	33

ATTACHMENT D: TEST PLOTS

ATTACHMENT E: FCC ID LABEL & LOCATION

ATTACHMENT F: TEST SETUP PHOTOGRAPHS

ATTACHMENT G: EXTERNAL PHOTOGRAPHS

ATTACHMENT H: INTERNAL PHOTOGRAPHS

ATTACHMENT I: BLOCK DIAGRAM (S)

ATTACHMENT J: CIRCUIT DIAGRAMS & DESCRIPTION

ATTACHMENT K: PARTS LIST

ATTACHMENT L: OPERATIONAL DESCRIPTION

ATTACHMENT M: USER'S MANUAL

ATTACHMENT N: SAR MEASUREMENT REPORT

ATTACHMENT O: SAR TEST DATA

ATTACHMENT P: SAR TEST SETUP PHOTOGRAPHS

ATTACHMENT Q: DIPOLE VALIDATION

ATTACHMENT R: PROBE CALIBRATION

ATTACHMENT S: DIPOLE CALIBRATION

MEASUREMENT REPORT

1.1 SCOPE

Measurement and determination of electromagnetic emissions (EME) of radio frequency devices including intentional and/or unintentional radiators for compliance with the technical rules and regulations of the Federal Communications Commission.

General Information

Company Name:	KTF Technologies Co., Ltd.
Address:	9th Fl. Shinyoung Tower 265-3(4), Seohyun-Dong, Bundang-Gu, Sungnam-City, Kyunggi-Do, Korea 463-769
Attention:	Mr. Chul- Gyoo Park
Tel. / Fax :	+82-31-788-4430 / +82-31-788-2959
E-Mail :	cgpark@ktftech.com

- FCC ID: SDJKTFT-UX200
- Quantity: Quantity production is planned
- EUT Type: Tri-Mode Dual-Band Phone (AMPS/CDMA/PCS CDMA) - Prototype
- Trade Name: KTFT
- Model(s): KTFT-UX200
- Serial Number(s): SDJ20050400001
- Emission Designator(s): 40K0F8W, 40K0F1D, 1M28F9W
- Tx Frequency: 824.04 – 848.97 MHz (AMPS)
824.70 – 848.31 MHz (CDMA)
1851.25 – 1908.75 MHz (PCS CDMA)
- Rx Frequency: 869.04 – 893.97 MHz (AMPS)
869.70 – 893.31 MHz (CDMA)
1931.25 – 1988.75 MHz (PCS CDMA)
- Application Type: Certification
- FCC Classification: Licensed Portable Transmitter Held to Ear (PCE)
- FCC Rule Part(s): §24(E), §22(H), §2
- Modulation(s): AMPS/ CDMA/ PCS CDMA
- Antenna Type: Fixed
- Max RF. Output Power: 0.337W ERP AMPS (25.27dBm) / 0.276W ERP CDMA (24.41dBm)
0.233W EIRP PCS CDMA (23.67dBm)
- Date(s) of Tests: April 11, 2005 - April 13, 2005
- Place of Tests: Hyundai C-Tech. EMC Lab.
Icheon, Kyounki-Do, KOREA
- Report Serial No.: HCT-SAR05-0406

2.1 INTRODUCTION

EUT DESCRIPTION

The KTFT Technologies KTFT-UX200 Tri-Mode Dual-Band Phone (AMPS/ CDMA/ PCS CDMA) phone. Its basic purpose is used for communications. It transmits from AMPS (824.04~848.97), CDMA (824.70~848.31), PCS CDMA (1851.25~1908.75)MHz and receives from AMPS(869.04~893.97), CDMA(869.70~893.31), PCS CDMA(1931.25~1988.75)MHz. The RF power is rated at AMPS (0.337W), CDMA (0.276W), and PCS CDMA (0.233W).

MEASURING INSTRUMENT CALIBRATION

The measuring equipment, which was utilized in performing the tests documented herein, has been calibrated in accordance with the manufacturer's recommendations for utilizing calibration equipment, which is traceable to recognized national standards.

Test Facility

The open area test site and conducted measurement facility used to collect the radiated data are located at the 254-1, Maekok-Ri, Hobup-Myun, Ichon-Si, Kyoungki-Do, 467-701, KOREA. The site is constructed in conformance with the requirements of ANSI C63.4 and CISPR Publication 22. Detailed description of test facility was submitted to the Commission and accepted dated July 23, 2003(Registration Number: 90661)

3.1 INSERTS

Function of Active Devices (Confidential)

The Function of active devices are shown in Attachment K.

Block/Circuit Diagrams & Description (Confidential)

The circuit diagrams & description are shown in Attachment J, and the block diagrams are shown in Attachment I.

Operating Instructions

The instruction manual is shown in Attachment M.

Parts List & Tune-Up Procedure (Confidential)

The parts list & tune-up procedure are shown in Attachment L.

Description of Freq. Stabilization Circuit (Confidential)

The description of frequency stabilization circuit is shown in Attachment K.

Description for Suppression of Spurious Radiation, for Limiting Modulation, and Harmonic Suppression Circuits (Confidential)

The description of suppression stabilization circuits are shown in Attachment K

4.1 DESCRIPTION OF TESTS

4.1 RF Power output.

Test Set-up

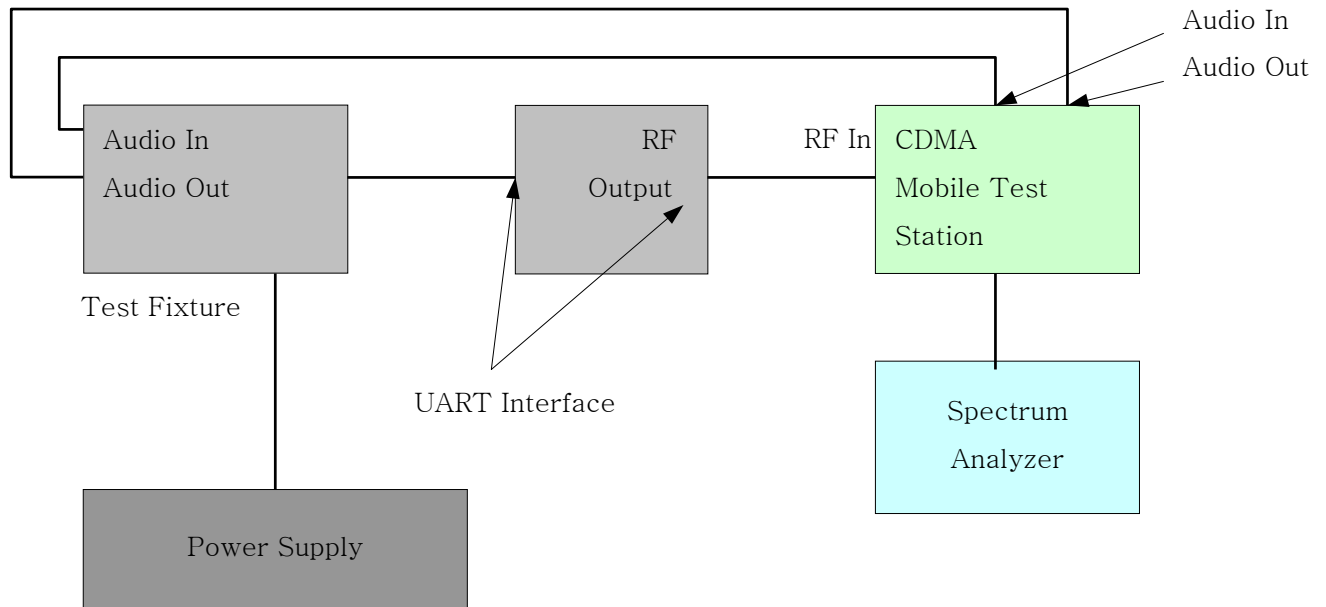

UART Interface: The UART Interface has a serial communication link and RF Interface port that can be used to test , debug or upgrade the phone's functions and characteristics.

EUT : Equipment Under Test

Test Procedure

The power is read at the specturm anlyazer through the duplex port of CDMA mobile test station.

RF power output is measured at the RF output terminal (UART Interface) on the bottom side of the EUT.

4.2 Effective Radiated Power.

Test Set-up

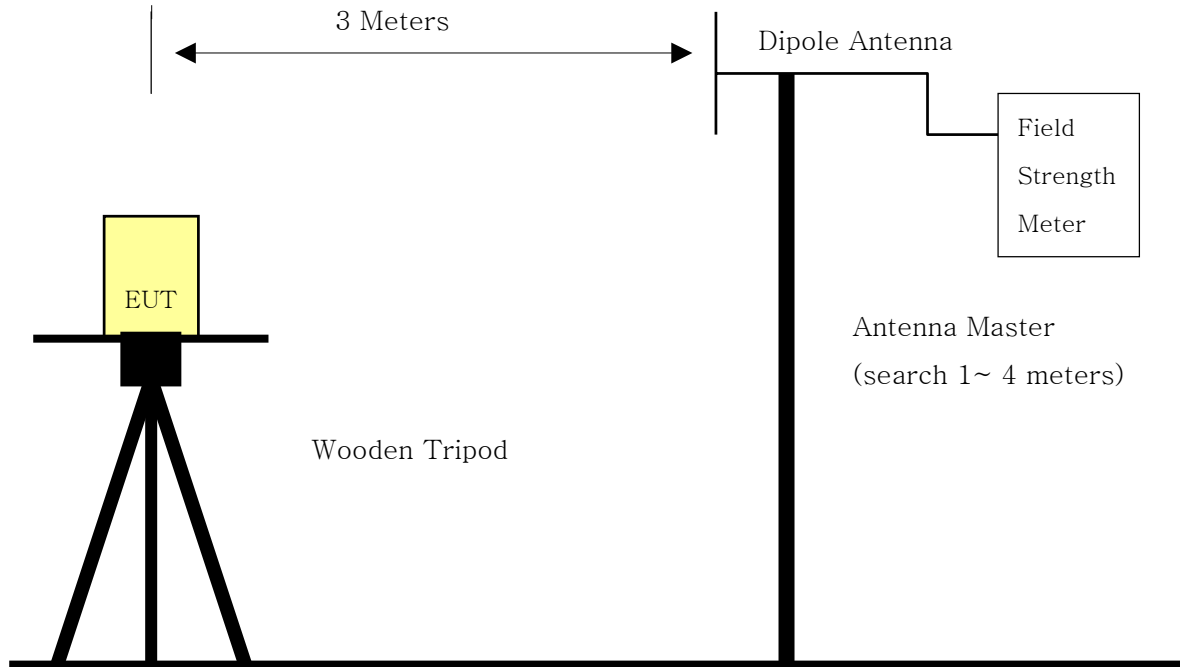

Open Field Test Site

Test Procedure

The measurement facilities used for this test have been documented in previous filings with the commission pursuant to section 2.948.

The open field test site is situated in open field with ground screen whose site attenuation characteristics meet ANSI C63.4 –2003. A mast capable of lifting the receiving antenna from a height of one to four meters is used together with a rotatable wooden platform mounted at three from the antenna mast.

- 1) The EUT mounted on a wooden tripod is 0.8 meter above test site ground level.
- 2) During the test , the turn table is rotated and the antenna height is also varied from 1 to 4 meters until the maximum signal is found.
- 3) Record the field strength meter's level.
- 4) Replace the EUT with $\lambda / 2$ dipole antenna that is connected to a calibrated signal generator.
- 5) Increase the signal generator output till the field strength meter's level is equal to the item(4).
- 6) The signal generator output level is the rating of effective radiated power(ERP).
- 7) The instrument settings used (RBW/ VBW) during ERP/ EIRP output power measurement are as Belows ;
 - . Below 1GHz : RBW 3MHz, VBW 3MHz
 - . Above 1GHz : RBW 3MHz, VBW 3MHz

4.3 Modulation Requirements.

4.3.1 Frequency response of the audio modulation circuit.

Test Set-up

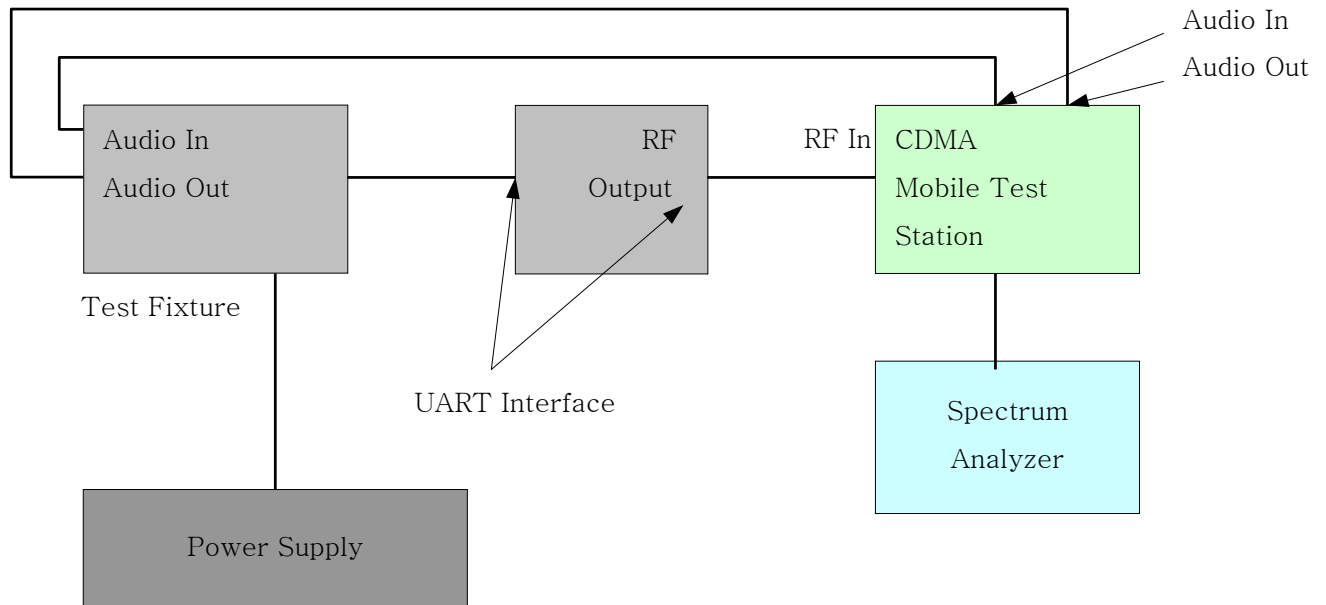

UART Interface: The UART Interface has a serial communication link that can be used to test , debug or upgrade the phone's functions and characteristics.

Test Procedure

- 1) Set the frequency deviation $\pm 2.9\text{KHz}$ at the audio tone by adjusting the audio generator and record the demod out level at 1KHz.
- 2) Change the frequency of audio generator from 300KHz to 3000Hz and record the demod out level relative to the level at 1KHz.
- 3) Adjust the audio input frequency to 1000KHz and adjust the input level to 20dB greater than that required to produce $\pm 8\text{KHz}$ deviation.
- 4) Change the frequency of audio generator from 3000Hz to 30,000Hz and record the demod out level relative to the level at 1KHz.

4.3.2 Modulation levels and response of modulation limiting circuitry.

Test Set-up

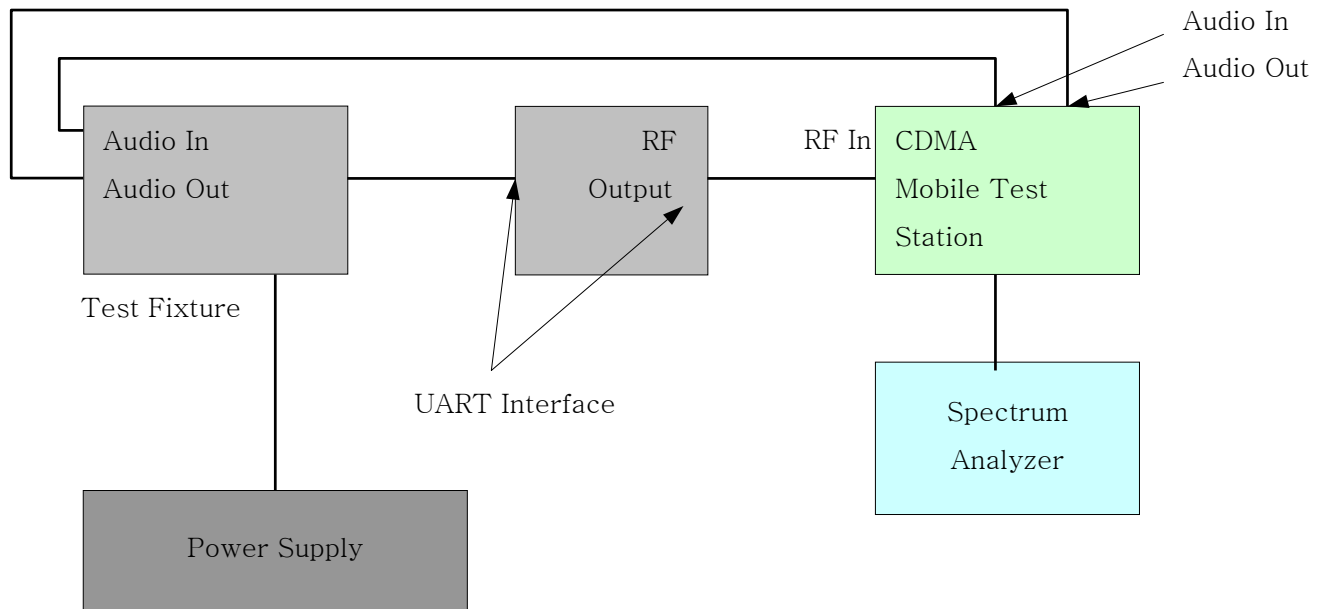

UART Interface: The UART Interface has a serial communication link that can be used to test , debug or upgrade the phone's functions and characteristics.

Test Procedure

- 1) Set the frequency deviation $\pm 7.2\text{KHz}$ at the audio tone by adjusting the audio generator. This level will be the 0 dB reference.
- 2) Increase the audio level from 0 dB reference to 30 dB in increments of 5 dB and record the frequency deviation.
- 3) This measurement is then repeated at 300Hz, 1004Hz and 3000Hz audio tone.

4.3.3 Levels of modulating signals.

Test Set-up

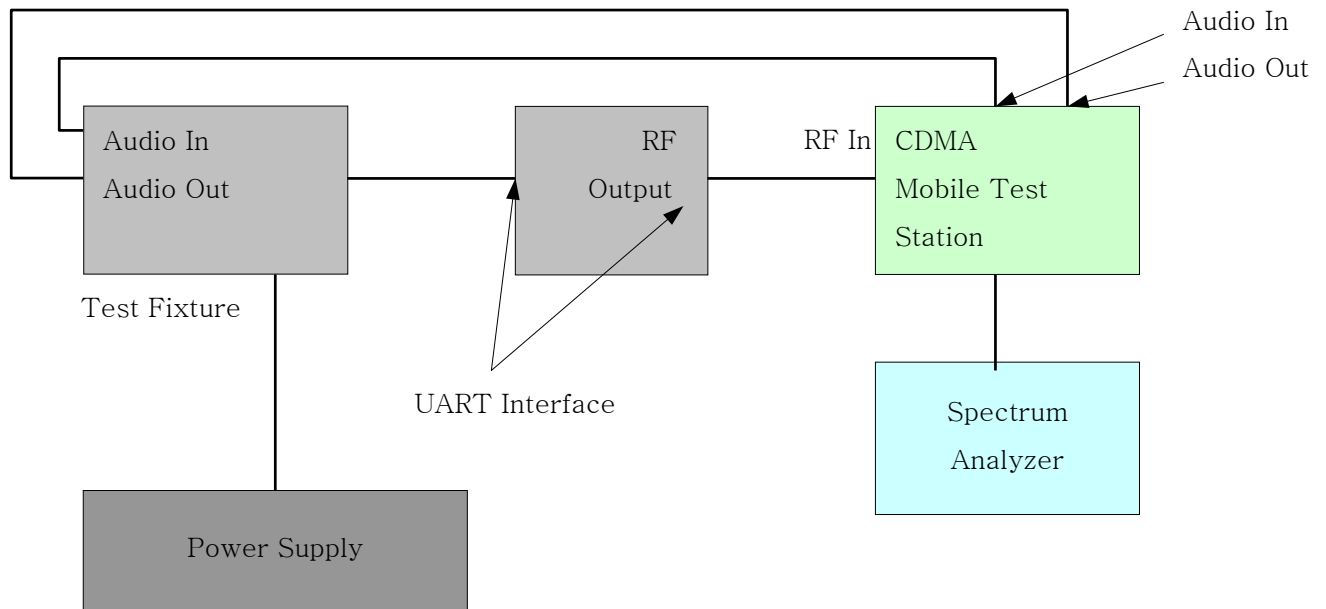

UART Interface: The UART Interface has a serial communication link that can be used to test , debug or upgrade the phone's functions and characteristics.

Test Procedure

- 1) Select the supervisory audio tone test mode pursuant to "Tune – up procedure" and record the frequency deviation on the modulation analyzer.
- 2) Select the signalling tone test mode pursuant to "Tune – up procedure" and record the frequency deviation on the modulation analyzer.
- 3) Select the TX data test mode pursuant to "Tune – up procedure" and record the frequency deviation on the modulation analyzer .

4.3.4 Occupied bandwidth.

Test Set-up

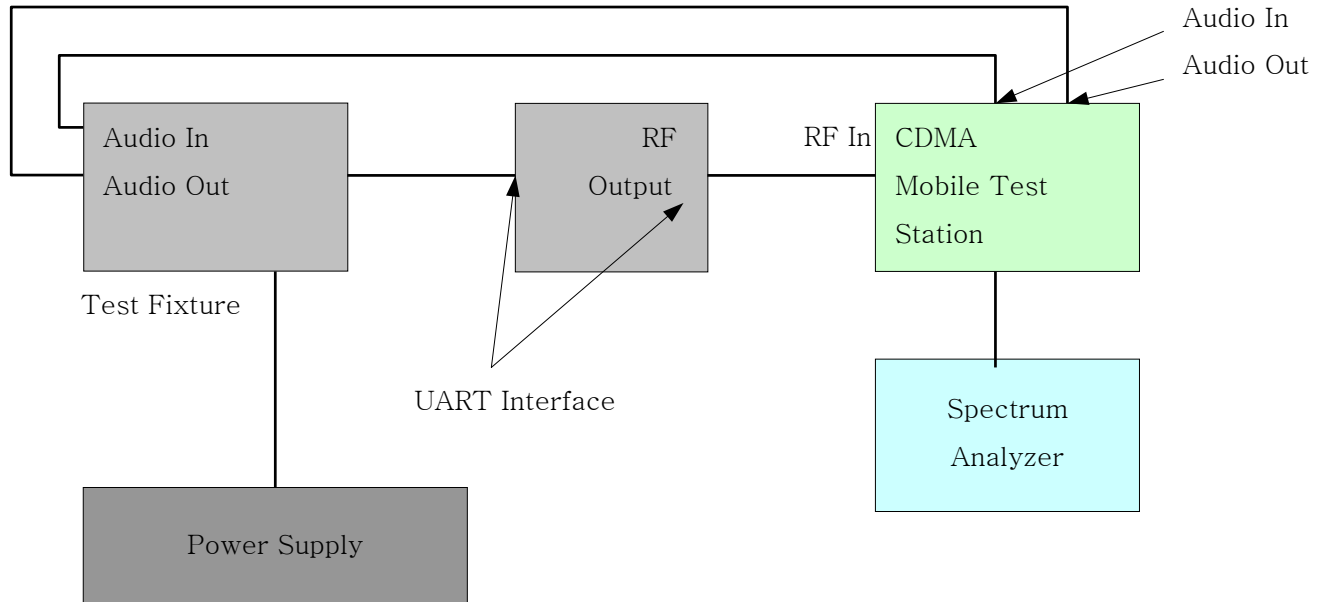

UART Interface: The UART Interface has a serial communication link that can be used to test , debug or upgrade the phone's functions and characteristics.

Test Procedure

1. F3E radiotelephony mode.
 - 1) The audio generator is set on the frequency of maximum audio response of the audio modulating circuit and its level adjusted for 50% modulation.
 - 2) Increase the audio level 16 dB greater than that necessary to produce 50 percent modulation and change the audio frequency to 2,500 Hz tone.
 - 3) The occupied bandwidth is drawn from the spectrum analyzer display.
2. F1D wideband data mode.
 - 1) Select the TX data test mode pursuant to "Tune-up procedure ".
 - 2) The occupied bandwidth is drawn from the spectrum analyzer display.
3. F3D supervisory audio tone mode.
 - 1) Select the supervisory tone test mode pursuant to "Tune-up procedure ".
 - 2) The occupied bandwidth is drawn from the spectrum analyzer display.
4. F3D signalling tone mode.
 - 1) Select the signalling audio tone test mode pursuant to "Tune-up procedure ".
 - 2) The occupied bandwidth is drawn from the spectrum analyzer display.

4.3.5 Spurious and Harmonic Emissions at Antenna Terminal.

Test Set-up

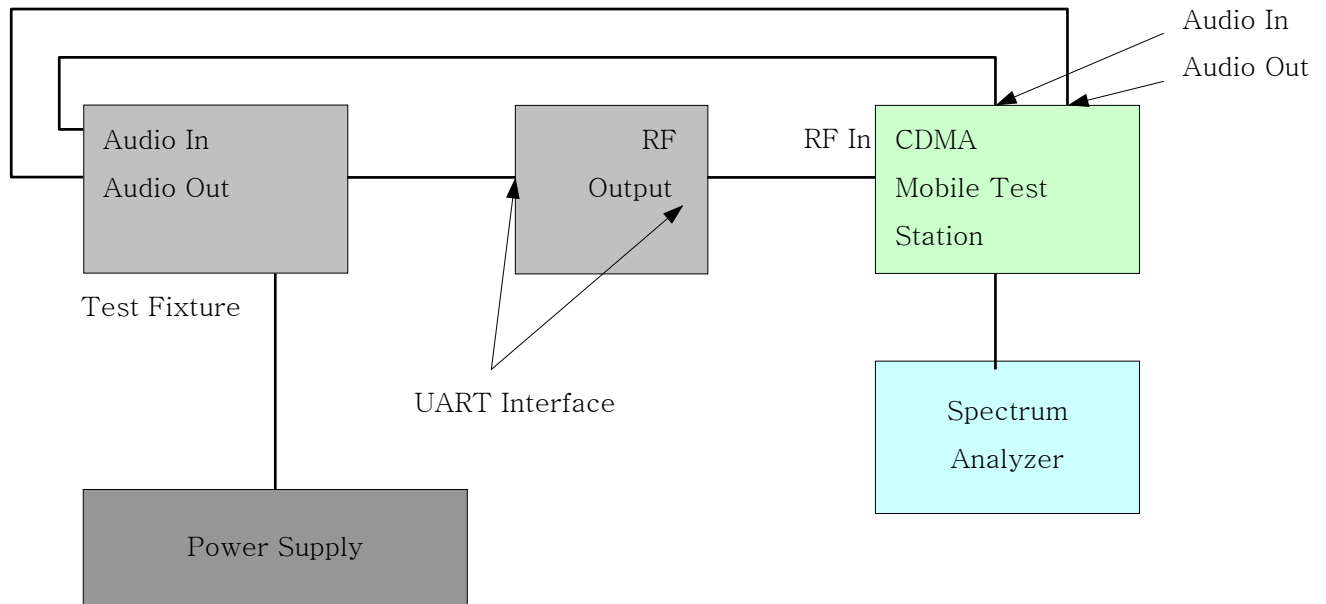

Test Procedure

The level of the carrier and the various conducted spurious and harmonic frequencies is measured by means of a calibrated spectrum analyzer. The spectrum is scanned from the lowest frequency generated in the equipment up to 10 GHz. The transmitter is modulated with a 2500Hz tone at a level of 16dB greater than that required to provide 50% modulation. At the input terminals of the spectrum analyzer, an isolator (RF circulator with one port terminated with 50 ohms) and an 870 MHz to 890 MHz bandpass filter is connected between the test transceiver (for conducted tests) or the receive antenna (for radiated tests) and the analyzer. The rejection of the bandpass filter to signals in the 825 — 845 MHz range is adequate to limit the transmit energy from the test transceiver which appears to a level which will allow the analyzer to measure signals less than —90dBm. Calibration of the test receiver is performed in the 870 — 890 MHz range to insure accuracy to allow variation in the bandpass filter insertion loss to be calibrated.

4.3.6 Field strength of spurious radiation .

Test Set-up

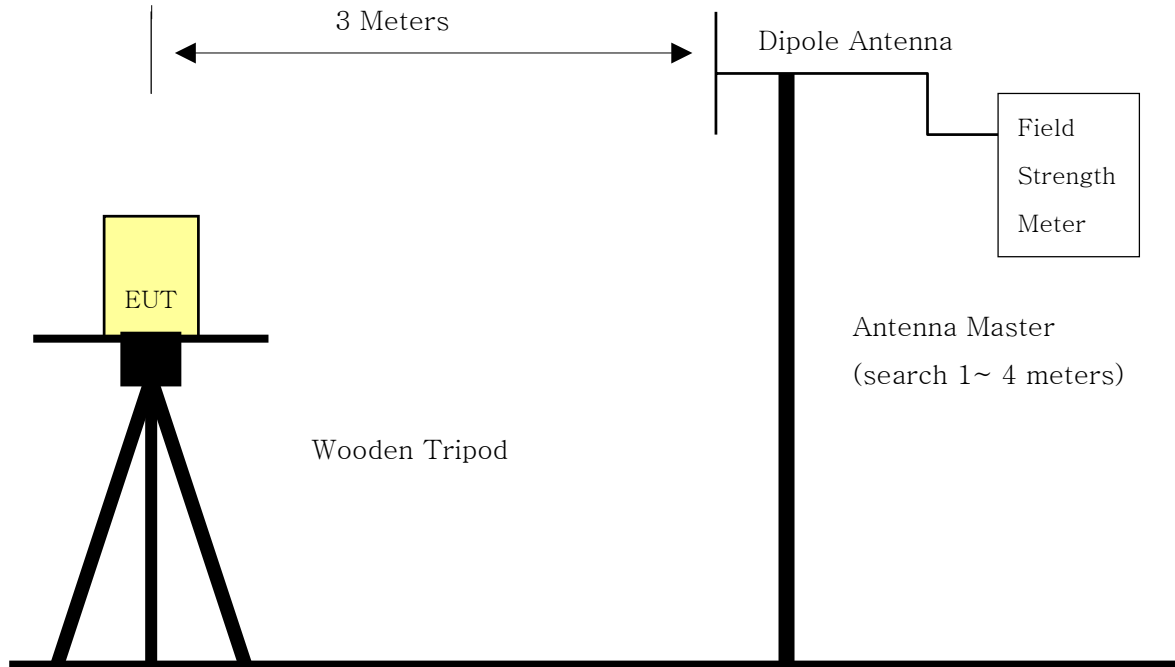

Open Field Test Site

Test Procedure

The measurement facilities used for this test have been documented in previous filings with the commission pursuant to section 2.948.

The open field test site is situated in open field with ground screen whose site attenuation characteristics meet ANSI C63.4 –2003. A mast capable of lifting the receiving antenna from a height of one to four meters is used together with a rotatable wooden platform mounted at three from the antenna mast.

- 1) The unit mounted on a wooden table $1.5\text{m} \times 1.0\text{m} \times 0.80$ is 0.8 meter above test site ground level.
- 2) During the emission test , the turntable is rotated and the EUT is manipulated to find the configuration resulting in maximum emission under normal condition of installation and operation.
- 3) The antenna height and polarization are also varied from 1 to 4 meters until the maximum signal is found.
- 4) The spectrum shall be scanned up to the 10th harmonic of the fundamental frequency.
- 5) The instrument settings used (RBW/ VBW) during ERP/ EIRP output power measurement are as follows ;
 - . Below 1GHz : RBW 3MHz, VBW 3MHz
 - . Above 1GHz : RBW 3MHz, VBW 3MHz

4.3.7 Frequency stability .

4.3.7.1 Frequency stability with variation of ambient temperature.

Test Set-up

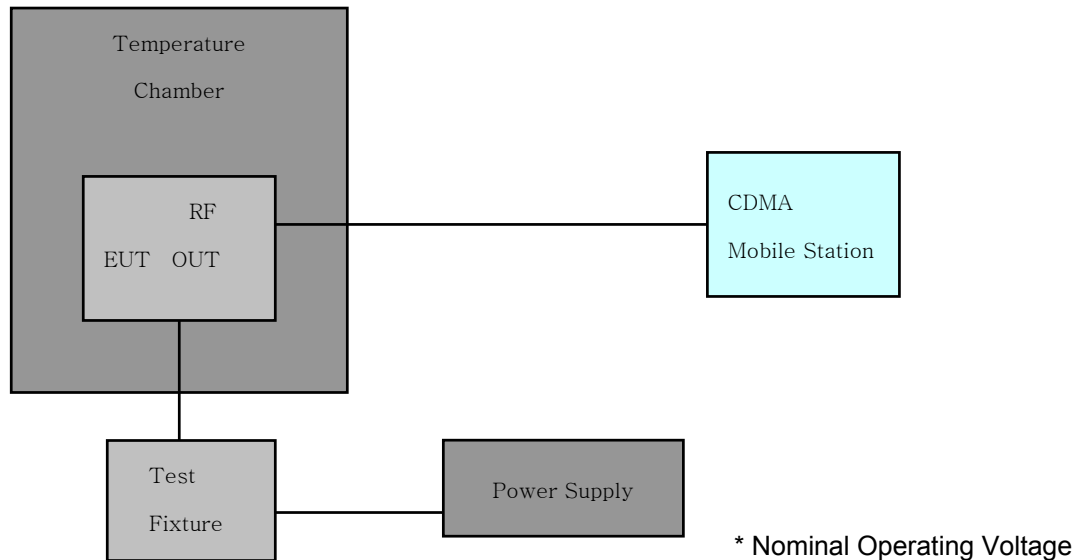

Test Procedure

The frequency stability of the transmitter is measured by:

- Temperature:** The temperature is varied from -30 °C to +60 °C using an environmental chamber.
- Primary Supply Voltage:** The primary supply voltage is varied from 85% to 115% of the voltage normally at the input to the device or at the power supply terminals if cables are not normally supplied.

Specification — The frequency stability shall be sufficient to ensure that the fundamental emission stays within the authorized frequency block. The frequency stability of the transmitter shall be maintained within ± 0.0001 (± 1 ppm) of the center frequency.

Time Period and Procedure:

- The carrier frequency of the transmitter and the individual oscillators is measured at room temperature (25 °C to 27 °C to provide a reference).
- The equipment is subjected to an overnight "soak" at -30 °C without any power applied.
- After the overnight "soak" at 30 °C (usually 14-16 hours), the equipment is turned on in a "standby" condition for one minute before applying power to the transmitter. Measurement of the carrier frequency of the transmitter and the individual oscillators is made within a three minute interval after applying power to the transmitter.
- Frequency measurements are made at 10 °C interval up to room temperature. At least a period of one and one half-hour is provided to allow stabilization of the equipment at each temperature level.
- Again the transmitter carrier frequency and the individual oscillators is measured at room temperature to begin measurement of the upper temperature levels.
- Frequency were made at 10 intervals starting at 30 °C up to +50 °C allowing at least two hours at each temperature for stabilization. In all measurements the frequency is measured within three minutes after applying power to the transmitter.
- The artificial load is mounted external to the temperature chamber.

NOTE: The EUT is tested down to the battery endpoint.

4.3.7.2 Frequency stability with variation of primary supply voltage.

Test Set-up

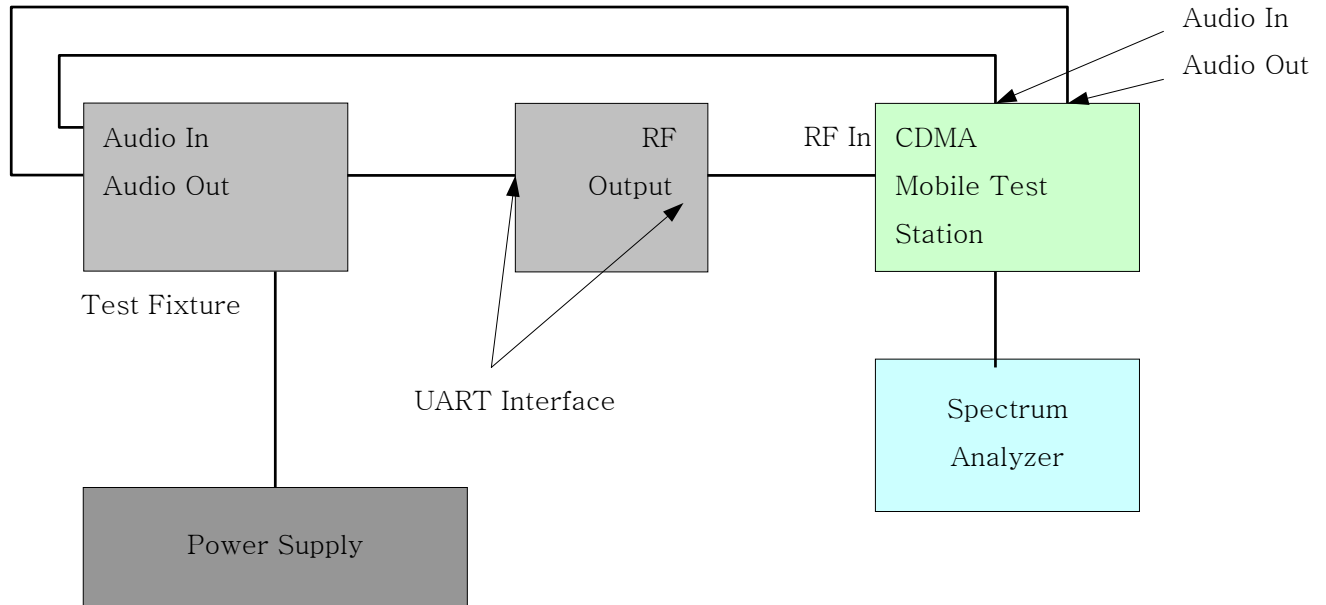

Test Procedure

- 1) The primary supply is varied in steps of 5% from 85 to 115% of the nominal supply voltage, or reduce primary supply voltage to the battery operating end point.
- 2) The frequency is recorded each 5% step.

5.1 Test Data

5.2 Effective Radiated Power Output (AMPS)

Freq. Tuned (MHz)	REF. LEVEL (dBm)	POL (H/V)	ERP (W)	ERP (dBm)	BATTERY
824.04	-22.8	V	0.270	24.31	Standard
836.49	-22.4	V	0.302	24.80	Standard
848.97	-21.9	V	0.337	25.27	Standard

NOTES:

Effective Radiated Power Output Measurements by Substitution Method
according to ANSI/TIA/EIA-603-A-2001, Aug. 15, 2001:

The EUT was placed on a wooden turn table 3-meters from the receive antenna. The receive antenna height and turntable rotation was adjusted for the highest reading on the receive spectrum analyzer. For CDMA signals, a peak detector is used, with RBW=VBW=3MHz. For AMPS, GSM, and NADC TDMA signals, a peak detector is used, with RBW=VBW=1MHz. A Horn antenna was substituted in place of the EUT. This Horn antenna was driven by a signal generator and the level of the signal generator was adjusted to obtain the same receive spectrum analyzer reading. The conducted power at the terminals of the Horn antenna is measured. The difference between the gain of the horn and an isotropic antenna is taken into consideration and the EIRP is recorded.

5.1 Test Data (Continued)

5.3 Effective Radiated Power Output (CDMA)

Radiated measurements at 3 meters

Modulation: CDMA

Freq. Tuned (MHz)	REF. LEVEL (dBm)	POL (H/V)	ERP (W)	ERP (dBm)	BATTERY
824.70	-23.1	V	0.254	24.05	Standard
835.89	-23.3	V	0.244	23.87	Standard
848.31	-22.7	V	0.276	24.41	Standard

NOTES:

Effective Radiated Power Output Measurements by Substitution Method
according to ANSI/TIA/EIA-603-A-2001, Aug. 15, 2001:

The EUT was placed on a wooden turn table 3-meters from the receive antenna. The receive antenna height and turntable rotation was adjusted for the highest reading on the receive spectrum analyzer. For CDMA signals, a peak detector is used, with RBW=VBW=3MHz. For AMPS, GSM, and NADC TDMA signals, a peak detector is used, with RBW=VBW=1MHz. A Horn antenna was substituted in place of the EUT. This Horn antenna was driven by a signal generator and the level of the signal generator was adjusted to obtain the same receive spectrum analyzer reading. The conducted power at the terminals of the Horn antenna is measured. The difference between the gain of the horn and an isotropic antenna is taken into consideration and the EIRP is recorded.

6.1 Test Data (Continued)

6.1 Equivalent Isotropic Radiated Power (E.I.R.P.) PCS CDMA

Radiated measurements at 3 meters

Modulation: PCS CDMA

Freq. Tuned (MHz)	RFF. LEVEL (dBm)	POL (H/V)	Azimuth (0 angle)	EIRP (W)	EIRP (dBm)	BATTERY
1851.25	-29.9	V	70	0.233	23.67	Standard
1880.00	-30.2	V	70	0.217	23.37	Standard
1908.75	-30.1	V	70	0.220	23.42	Standard

NOTES:

Equivalent Isotropic Radiated Power Measurements by Substitution Method
according to ANSI/TIA/EIA-603-A-2001, Aug. 15, 2001:

The EUT was placed on a wooden turn table 3-meters from the receive antenna. The receive antenna height and turntable rotation was adjusted for the highest reading on the receive spectrum analyzer. For CDMA signals, a peak detector is used, with RBW=VBW=3MHz. For AMPS, GSM, and NADC TDMA signals, a peak detector is used, with RBW=VBW=1MHz. A Horn antenna was substituted in place of the EUT. This Horn antenna was driven by a signal generator and the level of the signal generator was adjusted to obtain the same receive spectrum analyzer reading. The conducted power at the terminals of the Horn antenna is measured. The difference between the gain of the horn and an isotropic antenna is taken into consideration and the EIRP is recorded.

7.1 Test Data (Continued)

7.2 AMPS Radiated Measurements

Field Strength of SPURIOUS Radiation

■ OPERATING FREQUENCY:	_____	824.04 MHz
■ CHANNEL:	_____	0991 (Low)
■ MEASURED OUTPUT POWER:	_____	25.27 dBm = 0.337 W
■ MODULATION SIGNAL:	_____	FM (Internal)
■ DISTANCE:	_____	3 meters
■ LIMIT: $-(43 + 10 \log_{10} (W)) =$	_____	-38.28 dBc

Freq. (MHz)	LEVEL@ ANTENNA TERMINALS (dBm)	SUBSTITUTE ANTENNA GAIN (dBd)	CORRECT GENERATOR LEVEL (dBm)	POL (H/V)	(dBc)
1648.08	-57.8	7.3	-50.5	V	-70.43
2472.12	-51.1	8.3	-42.8	V	-62.27
3296.16	-63.1	9.7	-53.4	V	-71.97

NOTES:

Radiated Spurious Emission Measurements by Substitution Method
 according to ANSI/TIA/EIA-603-A-2001, Aug. 15, 2001:

The EUT was placed on a wooden turn table 3-meters from the receive antenna. The receive antenna height and turntable rotation was adjusted for the highest reading on the receive spectrum analyzer. For CDMA signals, a peak detector is used, with RBW=VBW=3MHz. For AMPS, GSM, and NADC TDMA signals, a peak detector is used, with RBW=VBW=1MHz. A half-wave dipole was substituted in place of the EUT. This dipole antenna was driven by a signal generator and the level of the signal generator was adjusted to obtain the same receive spectrum analyzer reading. This spurious level is recorded. For readings above 1GHz, the above procedure is repeated using horn antennas and the difference between the gain of the horn and an isotropic or dipole antenna are taken into consideration.

7.1 Test Data (Continued)

7.3 AMPS Radiated Measurements

Field Strength of SPURIOUS Radiation

■ OPERATING FREQUENCY:	836.49 MHz
■ CHANNEL:	0383 (Mid)
■ MEASURED OUTPUT POWER:	25.27 dBm = 0.337 W
■ MODULATION SIGNAL:	FM (Internal)
■ DISTANCE:	3 meters
■ LIMIT: $-(43 + 10 \log_{10} (W)) =$	-38.28 dBc

Freq. (MHz)	LEVEL@ ANTENNA TERMINALS (dBm)	SUBSTITUTE ANTENNA GAIN (dBd)	CORRECT GENERATOR LEVEL (dBm)	POL (H/V)	(dBc)
1672.98	-58.7	7.3	-51.4	V	-71.37
2509.47	-53.0	8.3	-44.7	V	-64.17
3345.96	-65.3	9.7	-55.6	V	-74.17

NOTES:

Radiated Spurious Emission Measurements by Substitution Method
according to ANSI/TIA/EIA-603-A-2001, Aug. 15, 2001:

The EUT was placed on a wooden turn table 3-meters from the receive antenna. The receive antenna height and turntable rotation was adjusted for the highest reading on the receive spectrum analyzer. For CDMA signals, a peak detector is used, with RBW=VBW=3MHz. For AMPS, GSM, and NADC TDMA signals, a peak detector is used, with RBW=VBW=1MHz. A half-wave dipole was substituted in place of the EUT. This dipole antenna was driven by a signal generator and the level of the signal generator was adjusted to obtain the same receive spectrum analyzer reading. This spurious level is recorded. For readings above 1GHz, the above procedure is repeated using horn antennas and the difference between the gain of the horn and an isotropic or dipole antenna are taken into consideration.

7.1 Test Data (Continued)

7.4 AMPS Radiated Measurements

Field Strength of SPURIOUS Radiation

■ OPERATING FREQUENCY:	_____	848.97 MHz
■ CHANNEL:	_____	0799 (High)
■ MEASURED OUTPUT POWER:	_____	25.27 dBm = 0.337 W
■ MODULATION SIGNAL:	_____	FM (Internal)
■ DISTANCE:	_____	3 meters
■ LIMIT: $-(43 + 10 \log_{10} (W)) =$	_____	-38.28 dBc

Freq. (MHz)	LEVEL@ ANTENNA TERMINALS (dBm)	SUBSTITUTE ANTENNA GAIN (dBd)	CORRECT GENERATOR LEVEL (dBm)	POL (H/V)	(dBc)
1697.94	-59.3	7.3	-52.0	V	-71.97
2546.91	-55.8	8.3	-47.5	V	-66.97
3395.88	-62.9	9.7	-53.2	V	-71.77

NOTES:

Radiated Spurious Emission Measurements by Substitution Method
according to ANSI/TIA/EIA-603-A-2001, Aug. 15, 2001:

The EUT was placed on a wooden turn table 3-meters from the receive antenna. The receive antenna height and turntable rotation was adjusted for the highest reading on the receive spectrum analyzer. For CDMA signals, a peak detector is used, with RBW=VBW=3MHz. For AMPS, GSM, and NADC TDMA signals, a peak detector is used, with RBW=VBW=1MHz. A half-wave dipole was substituted in place of the EUT. This dipole antenna was driven by a signal generator and the level of the signal generator was adjusted to obtain the same receive spectrum analyzer reading. This spurious level is recorded. For readings above 1GHz, the above procedure is repeated using horn antennas and the difference between the gain of the horn and an isotropic or dipole antenna are taken into consideration.

7.1 Test Data (Continued)

7.5 CELLULAR CDMA Radiated Measurements

Field Strength of SPURIOUS Radiation

■ OPERATING FREQUENCY:	824.70 MHz
■ CHANNEL:	1013 (Low)
■ MEASURED OUTPUT POWER:	24.41 dBm = 0.276 W
■ MODULATION SIGNAL:	CDMA (Internal)
■ DISTANCE:	3 meters
■ LIMIT: $-(43 + 10 \log_{10} (W)) =$	-37.41 dBc

Freq. (MHz)	LEVEL@ ANTENNA TERMINALS (dBm)	SUBSTITUTE ANTENNA GAIN (dBd)	CORRECT GENERATOR LEVEL (dBm)	POL (H/V)	(dBc)
1649.40	-60.1	7.3	-52.8	V	-71.91
2474.10	-46.7	8.3	-38.4	V	-57.01
3298.80	-57.3	9.7	-47.6	V	-65.31

NOTES:

Radiated Spurious Emission Measurements by Substitution Method
according to ANSI/TIA/EIA-603-A-2001, Aug. 15, 2001:

The EUT was placed on a wooden turn table 3-meters from the receive antenna. The receive antenna height and turntable rotation was adjusted for the highest reading on the receive spectrum analyzer. For CDMA signals, a peak detector is used, with RBW=VBW=3MHz. For AMPS, GSM, and NADC TDMA signals, a peak detector is used, with RBW=VBW=1MHz. A half-wave dipole was substituted in place of the EUT. This dipole antenna was driven by a signal generator and the level of the signal generator was adjusted to obtain the same receive spectrum analyzer reading. This spurious level is recorded. For readings above 1GHz, the above procedure is repeated using horn antennas and the difference between the gain of the horn and an isotropic or dipole antenna are taken into consideration.

7.1 Test Data (Continued)

7.6 CELLULAR CDMA Radiated Measurements

Field Strength of SPURIOUS Radiation

■ OPERATING FREQUENCY:	835.89 MHz
■ CHANNEL:	0363 (Mid)
■ MEASURED OUTPUT POWER:	24.41 dBm = 0.276 W
■ MODULATION SIGNAL:	CDMA (Internal)
■ DISTANCE:	3 meters
■ LIMIT: $-(43 + 10 \log_{10} (W)) =$	-37.41 dBc

Freq. (MHz)	LEVEL@ ANTENNA TERMINALS (dBm)	SUBSTITUTE ANTENNA GAIN (dBd)	CORRECT GENERATOR LEVEL (dBm)	POL (H/V)	(dBc)
1671.78	-61.9	7.3	-54.6	V	-73.71
2507.67	-49.8	8.3	-41.5	V	-60.11
3343.56	-59.5	9.7	-49.8	V	-67.51

NOTES:

Radiated Spurious Emission Measurements by Substitution Method
according to ANSI/TIA/EIA-603-A-2001, Aug. 15, 2001:

The EUT was placed on a wooden turn table 3-meters from the receive antenna. The receive antenna height and turntable rotation was adjusted for the highest reading on the receive spectrum analyzer. For CDMA signals, a peak detector is used, with RBW=VBW=3MHz. For AMPS, GSM, and NADC TDMA signals, a peak detector is used, with RBW=VBW=1MHz. A half-wave dipole was substituted in place of the EUT. This dipole antenna was driven by a signal generator and the level of the signal generator was adjusted to obtain the same receive spectrum analyzer reading. This spurious level is recorded. For readings above 1GHz, the above procedure is repeated using horn antennas and the difference between the gain of the horn and an isotropic or dipole antenna are taken into consideration.

7.1 Test Data (Continued)

7.7 CELLULAR CDMA Radiated Measurements

Field Strength of SPURIOUS Radiation

■ OPERATING FREQUENCY:	_____	848.31 MHz
■ CHANNEL:	_____	0777 (High)
■ MEASURED OUTPUT POWER:	_____	24.41 dBm = 0.276 W
■ MODULATION SIGNAL:	_____	CDMA (Internal)
■ DISTANCE:	_____	3 meters
■ LIMIT: $-(43 + 10 \log_{10} (W)) =$	_____	-37.41 dBc

Freq. (MHz)	LEVEL@ ANTENNA TERMINALS (dBm)	SUBSTITUTE ANTENNA GAIN (dBd)	CORRECT GENERATOR LEVEL (dBm)	POL (H/V)	(dBc)
1696.62	-60.9	7.3	-53.6	V	-72.71
2544.93	-50.4	8.3	-42.1	V	-60.71
3393.24	-58.3	9.7	-48.6	V	-66.31

NOTES:

Radiated Spurious Emission Measurements by Substitution Method
 according to ANSI/TIA/EIA-603-A-2001, Aug. 15, 2001:

The EUT was placed on a wooden turn table 3-meters from the receive antenna. The receive antenna height and turntable rotation was adjusted for the highest reading on the receive spectrum analyzer. For CDMA signals, a peak detector is used, with RBW=VBW=3MHz. For AMPS, GSM, and NADC TDMA signals, a peak detector is used, with RBW=VBW=1MHz. A half-wave dipole was substituted in place of the EUT. This dipole antenna was driven by a signal generator and the level of the signal generator was adjusted to obtain the same receive spectrum analyzer reading. This spurious level is recorded. For readings above 1GHz, the above procedure is repeated using horn antennas and the difference between the gain of the horn and an isotropic or dipole antenna are taken into consideration.

7.1 Test Data (Continued)

7.8 CELLULAR PCS CDMA Radiated Measurements

Field Strength of SPURIOUS Radiation

■ OPERATING FREQUENCY:	_____	1851.25 MHz
■ CHANNEL:	_____	0025 (Low)
■ MEASURED OUTPUT POWER:	_____	23.67 dBm = 0.233 W
■ MODULATION SIGNAL:	_____	CDMA (Internal)
■ DISTANCE:	_____	3 meters
■ LIMIT: $-(43 + 10 \log_{10} (W)) =$	_____	-36.67 dBc

Freq. (MHz)	LEVEL@ ANTENNA TERMINALS (dBm)	SUBSTITUTE ANTENNA GAIN (dBi)	CORRECT GENERATOR LEVEL (dBm)	POL (H/V)	(dBc)
3702.50	-57.3	12.4	-44.9	V	-59.17
5553.75	-58.2	11.7	-46.5	V	-61.97
7405.00	-61.3	11.5	-49.8	V	-65.97

NOTES:

Radiated Spurious Emission Measurements by Substitution Method
according to ANSI/TIA/EIA-603-A-2001, Aug. 15, 2001:

The EUT was placed on a wooden turn table 3-meters from the receive antenna. The receive antenna height and turntable rotation was adjusted for the highest reading on the receive spectrum analyzer. For CDMA signals, a peak detector is used, with RBW=VBW=3MHz. For AMPS, GSM, and NADC TDMA signals, a peak detector is used, with RBW=VBW=1MHz. A half-wave dipole was substituted in place of the EUT. This dipole antenna was driven by a signal generator and the level of the signal generator was adjusted to obtain the same receive spectrum analyzer reading. This spurious level is recorded. For readings above 1GHz, the above procedure is repeated using horn antennas and the difference between the gain of the horn and an isotropic or dipole antenna are taken into consideration.

7.1 Test Data (Continued)

7.9 CELLULAR PCS CDMA Radiated Measurements

Field Strength of SPURIOUS Radiation

■ OPERATING FREQUENCY:	_____	1880.00 MHz
■ CHANNEL:	_____	0600 (Middle)
■ MEASURED OUTPUT POWER:	_____	23.67 dBm = 0.233 W
■ MODULATION SIGNAL:	_____	CDMA (Internal)
■ DISTANCE:	_____	3 meters
■ LIMIT: $-(43 + 10 \log_{10} (W)) =$	_____	-36.67 dBc

Freq. (MHz)	LEVEL@ ANTENNA TERMINALS (dBm)	SUBSTITUTE ANTENNA GAIN (dBi)	CORRECT GENERATOR LEVEL (dBm)	POL (H/V)	(dBc)
3760.00	-55.6	12.4	-43.2	V	-57.47
5640.00	-56.8	11.7	-45.1	V	-60.57
7520.00	-60.2	11.5	-48.7	V	-64.87

NOTES:

Radiated Spurious Emission Measurements by Substitution Method
according to ANSI/TIA/EIA-603-A-2001, Aug. 15, 2001:

The EUT was placed on a wooden turn table 3-meters from the receive antenna. The receive antenna height and turntable rotation was adjusted for the highest reading on the receive spectrum analyzer. For CDMA signals, a peak detector is used, with RBW=VBW=3MHz. For AMPS, GSM, and NADC TDMA signals, a peak detector is used, with RBW=VBW=1MHz. A half-wave dipole was substituted in place of the EUT. This dipole antenna was driven by a signal generator and the level of the signal generator was adjusted to obtain the same receive spectrum analyzer reading. This spurious level is recorded. For readings above 1GHz, the above procedure is repeated using horn antennas and the difference between the gain of the horn and an isotropic or dipole antenna are taken into consideration.

7.1 Test Data (Continued)

7.10 CELLULAR PCS CDMA Radiated Measurements

Field Strength of SPURIOUS Radiation

■ OPERATING FREQUENCY:	_____	1908.75 MHz
■ CHANNEL:	_____	1175 (High)
■ MEASURED OUTPUT POWER:	_____	23.67 dBm = 0.233 W
■ MODULATION SIGNAL:	_____	CDMA (Internal)
■ DISTANCE:	_____	3 meters
■ LIMIT: $-(43 + 10 \log_{10} (W)) =$	_____	-36.67 dBc

Freq. (MHz)	LEVEL@ ANTENNA TERMINALS (dBm)	SUBSTITUTE ANTENNA GAIN (dBi)	CORRECT GENERATOR LEVEL (dBm)	POL (H/V)	(dBc)
3817.50	-45.2	12.4	-32.8	V	-47.07
5726.25	-56.4	11.7	-44.7	V	-60.17
7635.00	-57.8	11.5	-46.3	V	-62.47

NOTES:

Radiated Spurious Emission Measurements by Substitution Method
according to ANSI/TIA/EIA-603-A-2001, Aug. 15, 2001:

The EUT was placed on a wooden turn table 3-meters from the receive antenna. The receive antenna height and turntable rotation was adjusted for the highest reading on the receive spectrum analyzer. For CDMA signals, a peak detector is used, with RBW=VBW=3MHz. For AMPS, GSM, and NADC TDMA signals, a peak detector is used, with RBW=VBW=1MHz. A half-wave dipole was substituted in place of the EUT. This dipole antenna was driven by a signal generator and the level of the signal generator was adjusted to obtain the same receive spectrum analyzer reading. This spurious level is recorded. For readings above 1GHz, the above procedure is repeated using horn antennas and the difference between the gain of the horn and an isotropic or dipole antenna are taken into consideration.

8.1 Test Data

8.2 FREQUENCY STABILITY (AMPS)

OPERATING FREQUENCY: 835,890,093 Hz
 CHANNEL: 383
 REFERENCE VOLTAGE: 3.7 VDC
 DEVIATION LIM IT: ± 0.00025 % or 2.5 ppm

Voltage (%)	Power (VDC)	Temp. (°C)	Frequency (Hz)	Deviation (%)	Deviation (ppm)
100	3.7	+20 (Ref)	835,890,093	0.000000	0.00000
100		-30	835,890,042	0.000006	0.06101
100		-20	835,890,183	-0.000011	-0.10767
100		-10	835,890,112	-0.000002	-0.02273
100		0	835,890,091	0.000000	0.00239
100		+10	835,890,185	-0.000011	-0.11006
100		+20	835,890,126	-0.000004	-0.03948
100		+30	835,890,124	-0.000004	-0.03709
100		+40	835,890,056	0.000004	0.04426
100		+50	835,890,183	-0.000011	-0.10767
100		+60	835,890,076	0.000002	0.02034
85		3.15	+20	835,890,193	-0.000012
115	4.26	+20	835,890,157	-0.000008	-0.07657
BATT.END POINT	2.81	+20	835,890,128	-0.000004	-0.04187

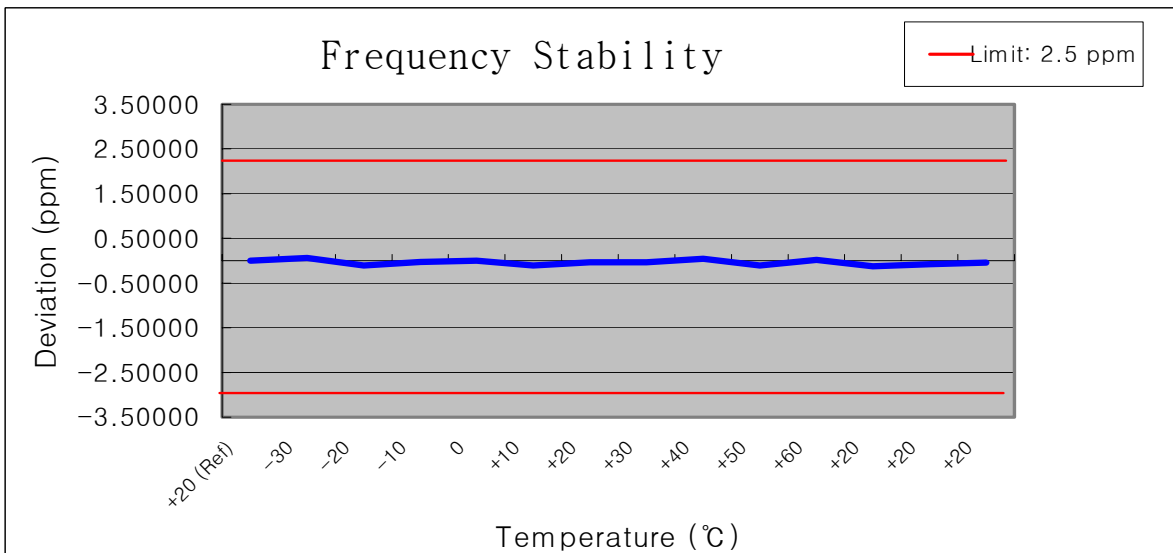

8.1 Test Data(Continued)

8.3 FREQUENCY STABILITY (PCS CDMA)

OPERATING FREQUENCY: 1,880,000,091 Hz
 CHANNEL: 0600
 REFERENCE VOLTAGE: 3.7 VDC
 DEVIATION LIM IT: ± 0.00025 % or 2.5 ppm

Voltage (%)	Power (VDC)	Temp. (°C)	Frequency (Hz)	Deviation (%)	Deviation (ppm)
100	3.7	+20 (Ref)	1,880,000,091	0.000000	0.00000
100		-30	1,880,000,027	0.000003	0.03404
100		-20	1,880,000,151	-0.000003	-0.03191
100		-10	1,880,000,127	-0.000002	-0.01915
100		0	1,880,000,169	-0.000004	-0.04149
100		+10	1,880,000,127	-0.000002	-0.01915
100		+20	1,880,000,103	-0.000001	-0.00638
100		+30	1,880,000,084	0.000000	0.00372
100		+40	1,880,000,132	-0.000002	-0.02181
100		+50	1,880,000,189	-0.000005	-0.05213
100		+60	1,880,000,121	-0.000002	-0.01596
85		3.15	+20	1,880,000,128	-0.000002
115	4.26	+20	1,880,000,108	-0.000001	-0.00904
BATT.END POINT	2.84	+20	1,880,000,079	0.000001	0.00638

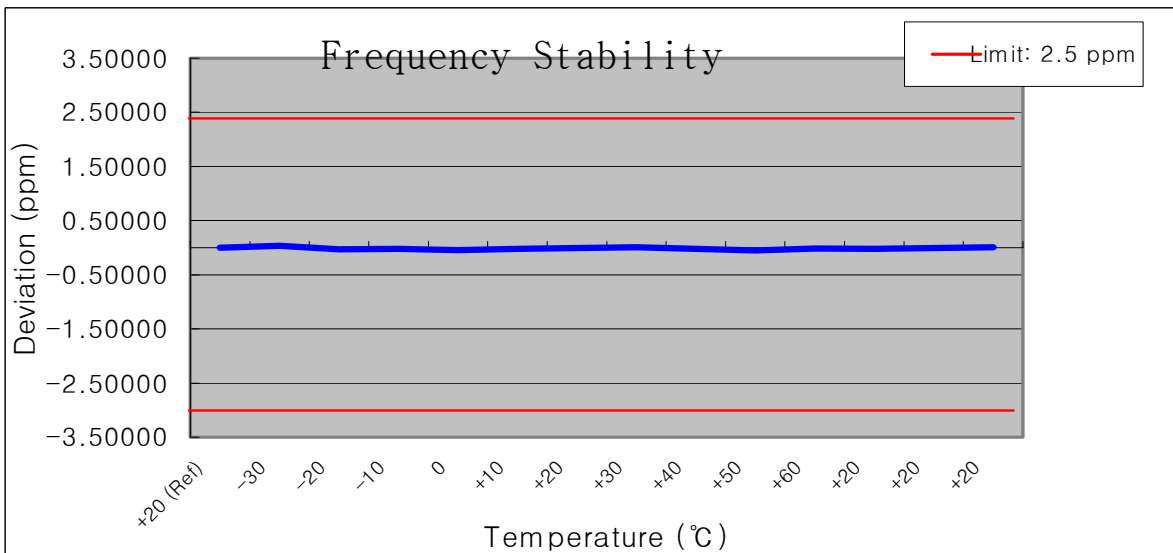

9.1 PLOT(S) OF EMISSION

(SEE ATTACHMENT D)

10.1 LIST OF TEST EQUIPMENT

Type / Model	Calib. Date	S/N
Spectrum Analyzer (20Hz~40GHz) R&S ESI40	Dec. 04	1088.7410
Spectrum Analyzer(100Hz~26.5GHz) R3273	April 04	J04821
Signal Generator HP8373ED (10MHz ~ 20GHz)	July 04	US8710152
Signal Generator MARCONI(10kHz ~ 2.7GHz)	Sep. 04	119331
Power Meter(A) HP 438A	July 04	2822A05909
Power Sensor(A) HP8481B	July 04	3318A08777
Power Meter(B) HP 438A	Nov. 04	2427A00963
Power Sensor(B) HP8481A	Oct. 04	2349A37617
Power Amp A0825-4343-R(800~2.5GHz) +43dB	Sep. 04	A00450
Network Analyzer HP-8753D (30kHz ~ 3GHz)	Sep. 04	3401J02111
Modulation Analyzer HP8901A	June 04	3438A05231
Dipole Antenna UHAP	June 04	557
Dipole Antenna UHAP	June 04	558
AMF-4D-001180-26-10P(0.1~18GHz)	Feb.05	671009
AMF-4D-001180-26-10P(18~26.5GHz)	Feb.05	667624
AMF-4D-001180-26-10P(26~40GHz)	Feb.05	671314
Audio Analyzer HP 8903A	Feb.05	2433A04322
Function Generator HP 8116A	Feb.05	3001A08285
Horn Antenna BBHA 9120D(1~18GHz)	June 04	1099
Horn Antenna BBHA 9120D(1~18GHz)	March 05	1201
Horn Antenna BBHA 9170(15~40GHz)	Feb.05	BBHA9170124
CDMA Mobile Station Test Set HP8924C	June 04	US39063847
PCS Interface HP83236B 1.7 ~ 2.0GHz	June 04	3711J04841
EMI Test Receiver Rohde & Schwarz ESH3	June 04	335.8017
EMI Test Receiver Rohde & Schwarz ESVP	Feb. 05	354.3000
EMI Test Receiver Rohde & Schwarz ESVS30	June 04	826006/013
Spectrum Analyzer HP 8591EM	July 04	3509A00155
LISN EMCO 3825/2	July 04	9706-1070
LISN Rohde & Schwarz ESH2-Z5	July 04	9706-1071
Amplifier Hewlett-Packard 8447E	March 05	2805A03141
Biconical Antenna BBA-9106(30~1000MHz)	June 04	D6901
Log-Periodic Antenna UHALP-9107(300~1000MHz)	June 04	91071107
Antenna VULB9160 (25MHz~1800MHz)	June 04	91071107
Antenna Position Tower HD240	N.A	3241
Turn Table EMCO 1060-06	N.A	1253A
AC Power Source PACIFIC Magnetic Module	N.A	45321
AC Power Source PACIFIC 360AMX	N.A	22B87

11.1 SAMPLE CALCULATIONS

A. ERP Sample Calculation

Freq. Tuned (MHz)	LEVEL(1) (dBm)	POL (H/V)	ERP (W)	ERP(2) (dBm)	BATTERY
824.70	-29.73	H	0.346	25.393	Standard

- 1) The EUT mounted on a wooden tripod is 0.8 meter above test site ground level.
- 2) During the test , the turn table is rotated and the antenna height is also varied from 1 to 4 meters until the maximum signal is found.
- 3) Record the field strength meter's level.(**LEVEL**)
- 4) Replace the EUT with dipole antenna that is connected to a calibrated signal generator.
- 5) Increase the signal generator output till the field strength meter's level is equal to the item(3).
- 6) The signal generator output level with cable loss is the rating of effective radiated power(**ERP**).
(Cable loss means the factor between Signal Generator and Transmitting Antenna.)

For more details, please refer to the test set-up procedure.

B. Emission Designator

Emission Designator = 1M28F9W

CDMA BW = 1.28 MHz

F = Frequency Modulation

9 = Composite Digital Info

W = Combination (Audio/Data)

(Measured at the 99.75% power bandwidth)

Emission Designator = 40K0F1D

Necessary Bandwidth:

Necessary Bandwidth (Bn), kHz = 40.0

(Measured at the 99.75% power bandwidth)

Emission Designator = 40K0F8W

Necessary Bandwidth:

Necessary Bandwidth (Bn), kHz = 40.0

(Measured at the 99.75% power bandwidth)

12.1 CONCLUSION

The data collected shows that the Tri-Mode Dual-Band Phone (AMPS/CDMA/ PCS CDMA)

FCC ID: SDJKTFT-UX200 complies with all the requirements of Parts 2 and 22, 24 of the FCC rules.

ATTACHMENT D – TEST PLOTS

■ **AMPS MODE (0383 CH.) Test Mode: Unmodulated Signal**

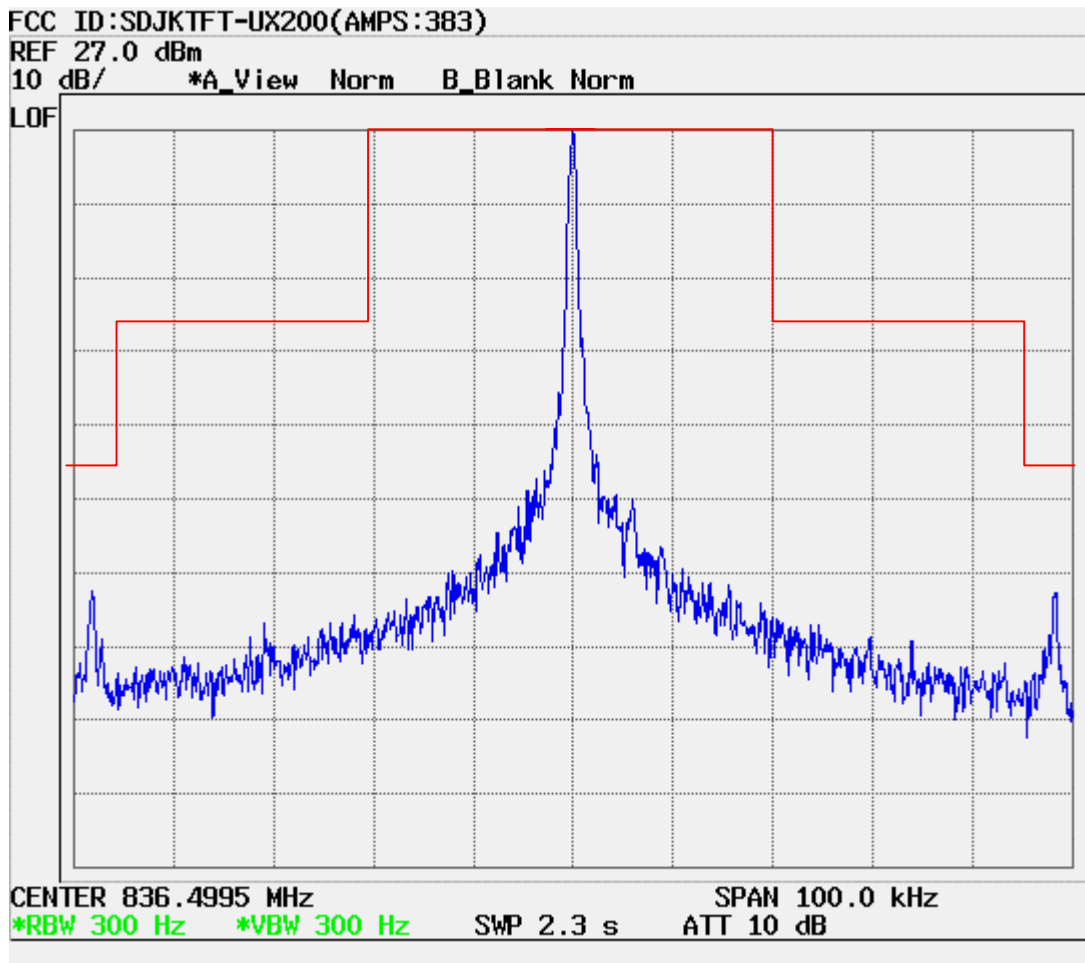

■ AMPS MODE (0383 CH.) Test Mode: SAT

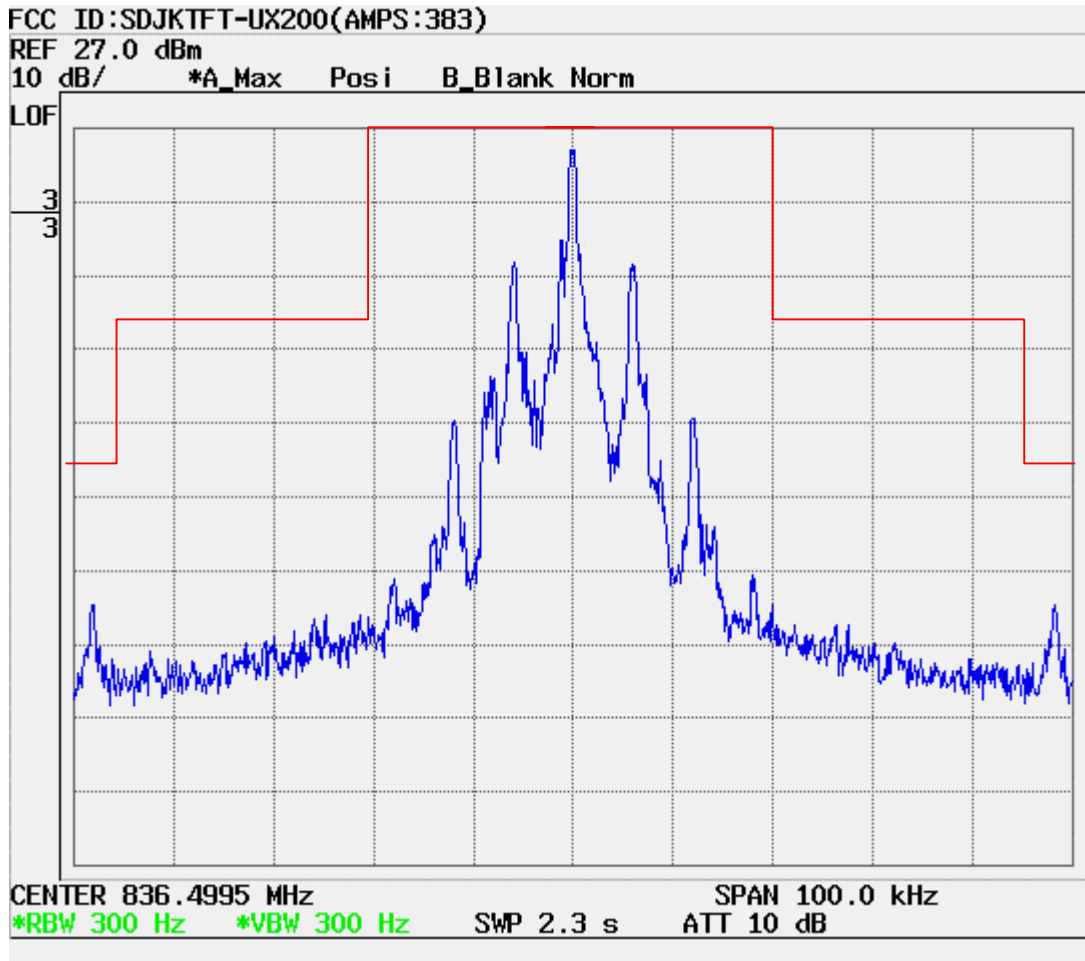

■ **AMPS MODE (0383 CH.) Test Mode: ST**

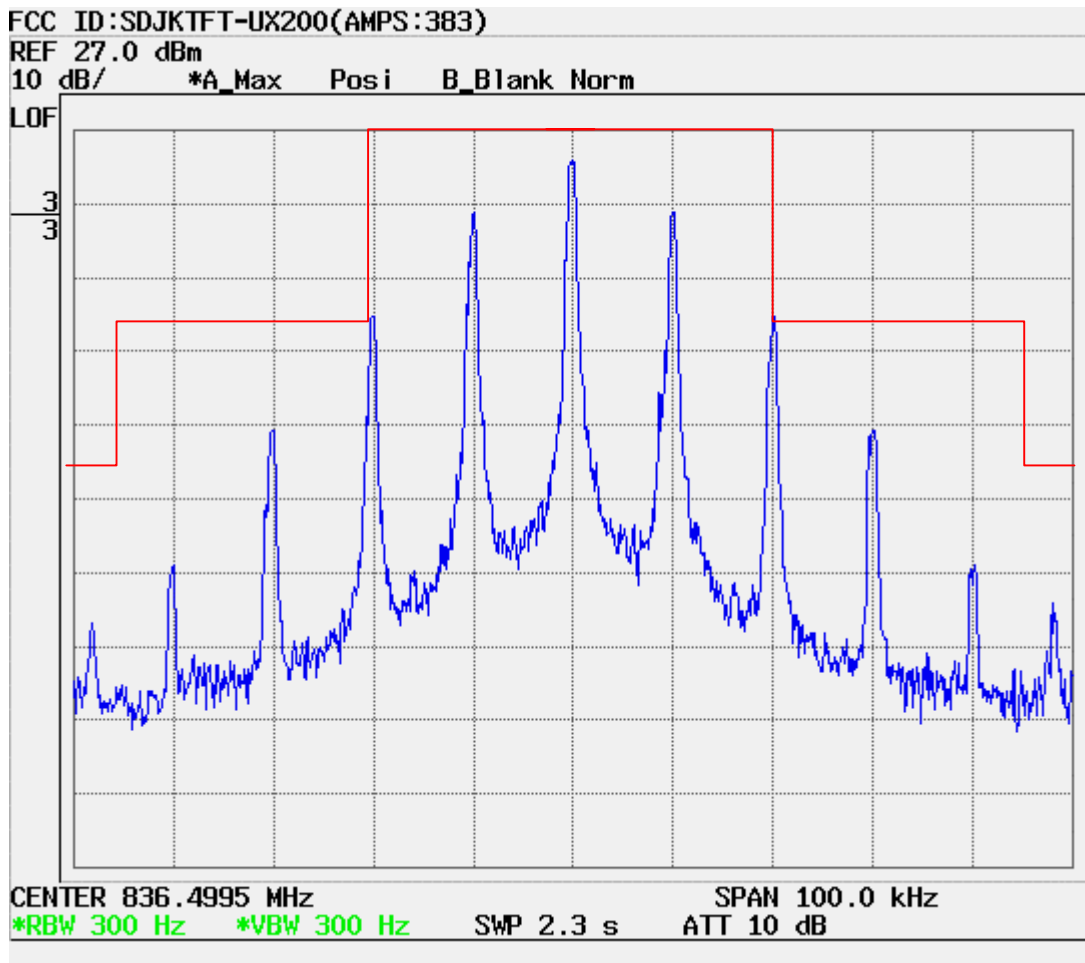

■ **AMPS MODE (0383 CH.) Test Mode: SAT+ST**

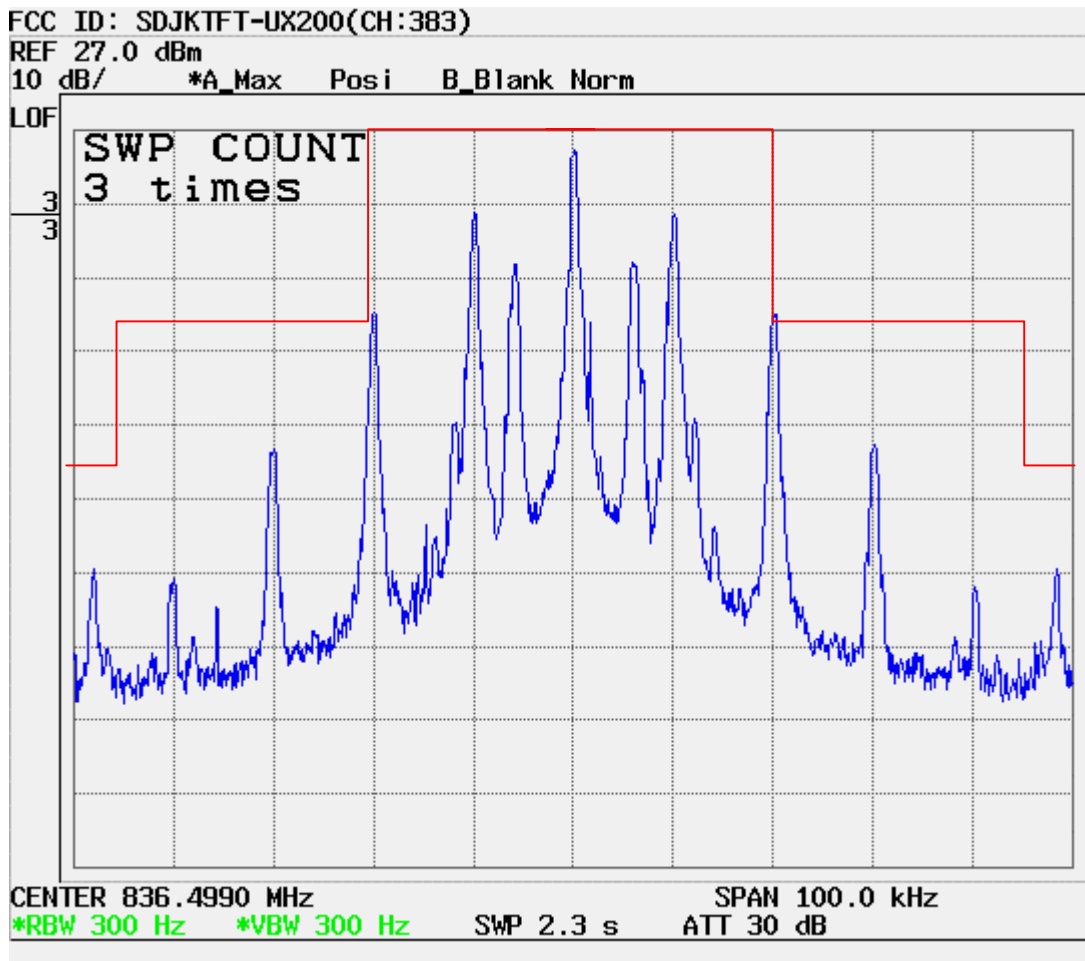

■ AMPS MODE (0383 CH.) Test Mode: Voice

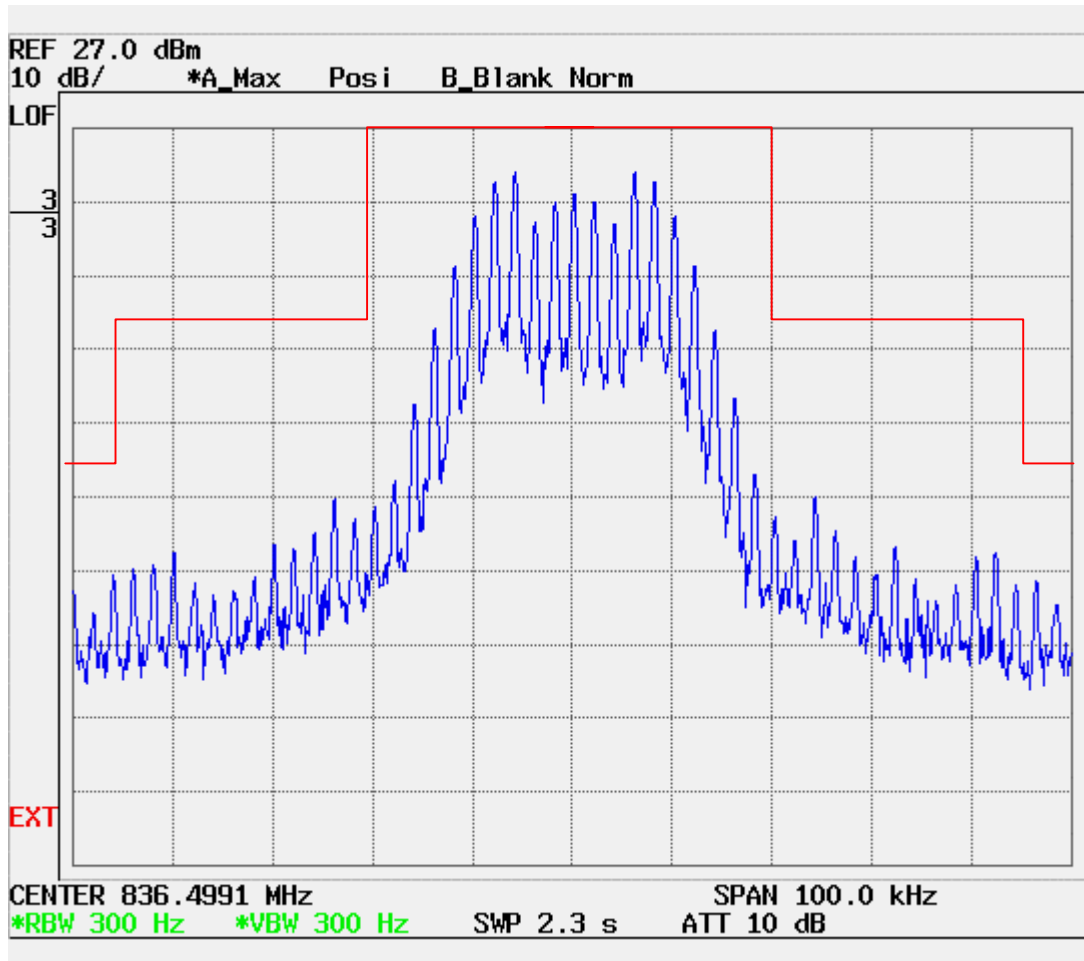

■ **AMPS MODE (0383 CH.) Test Mode: Wide Band Data**

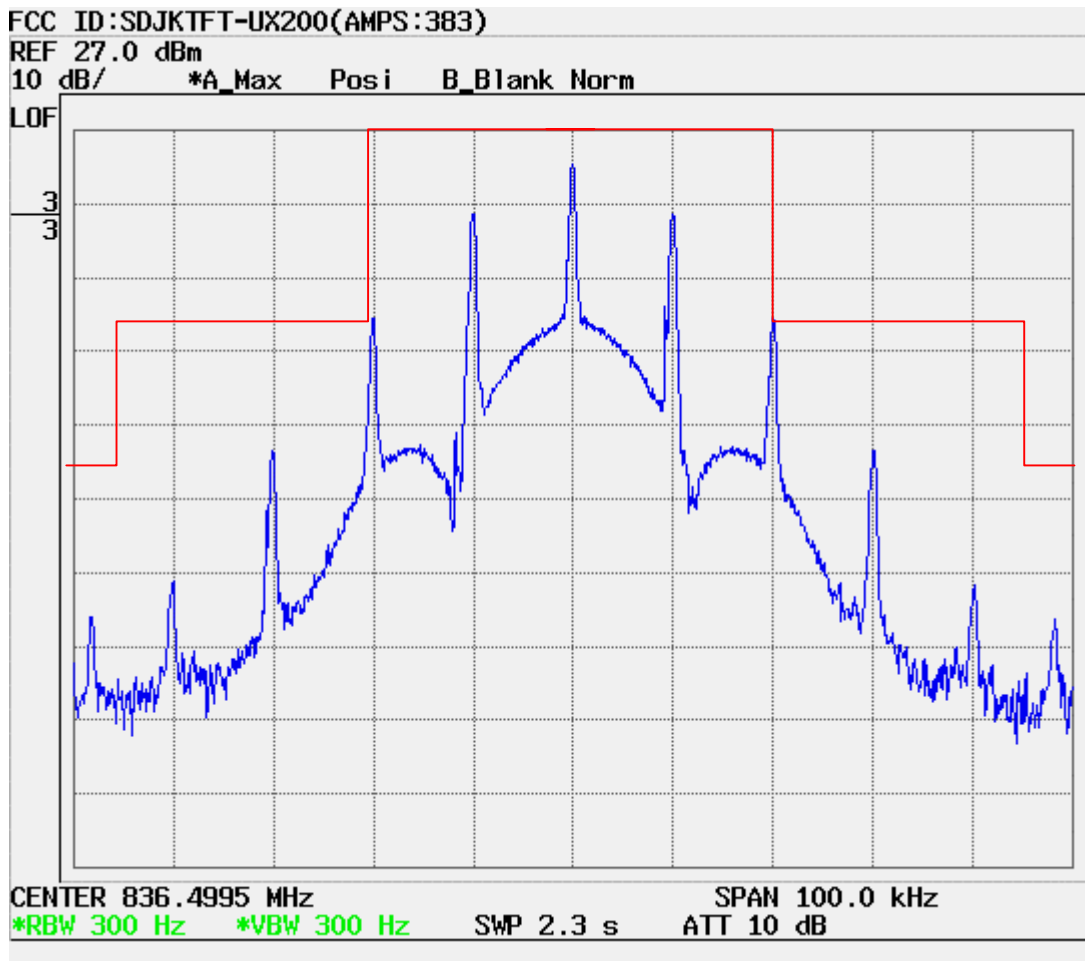

■ AMPS MODE (0991 CH.) Conducted Spurious

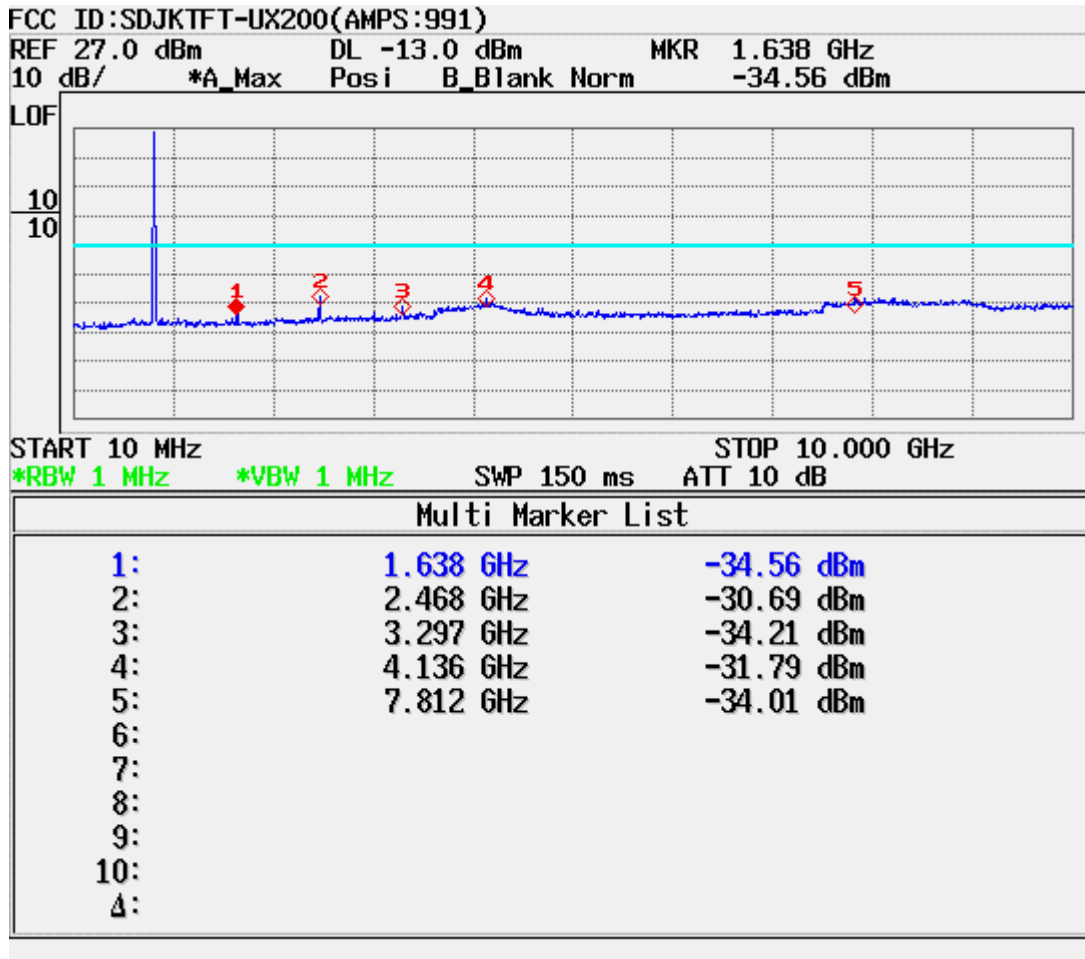

■ AMPS MODE (0383 CH.) Conducted Spurious

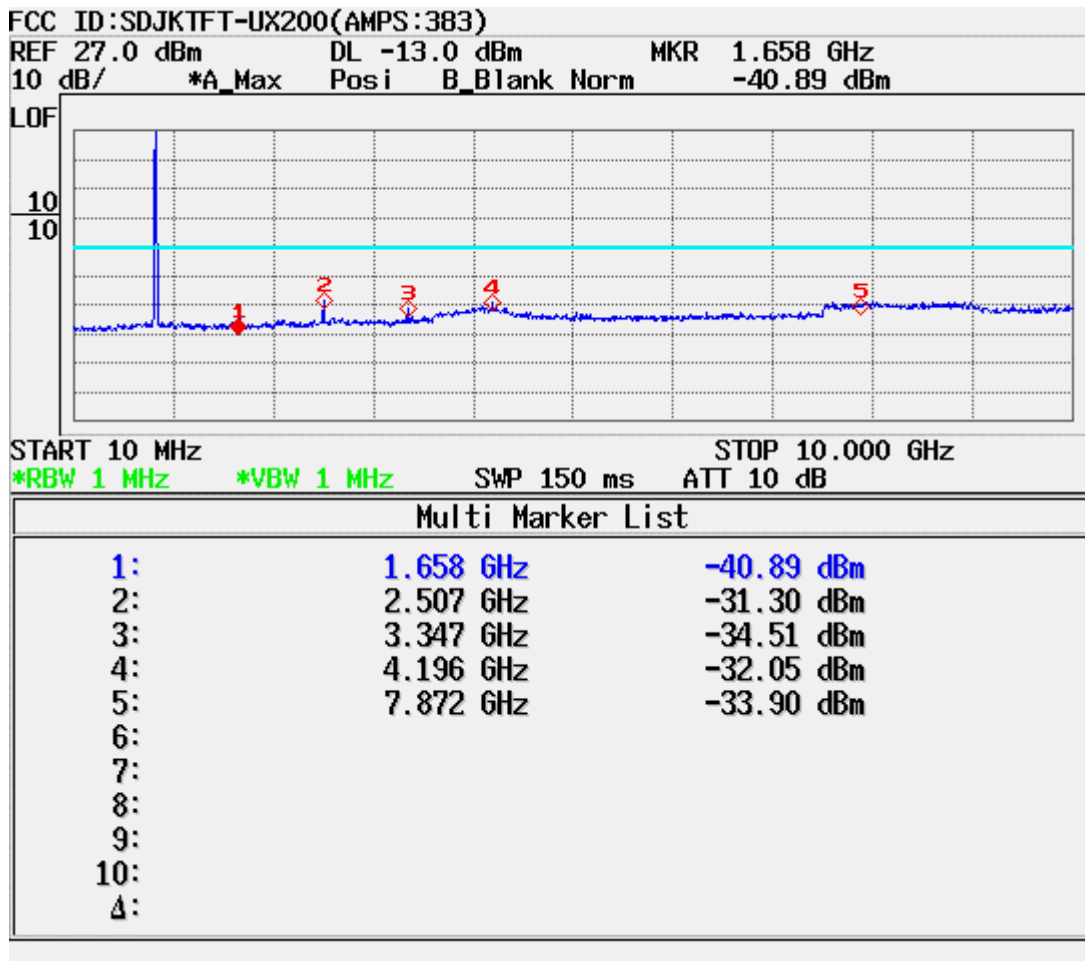

■ AMPS MODE (0799 CH.) Conducted Spurious

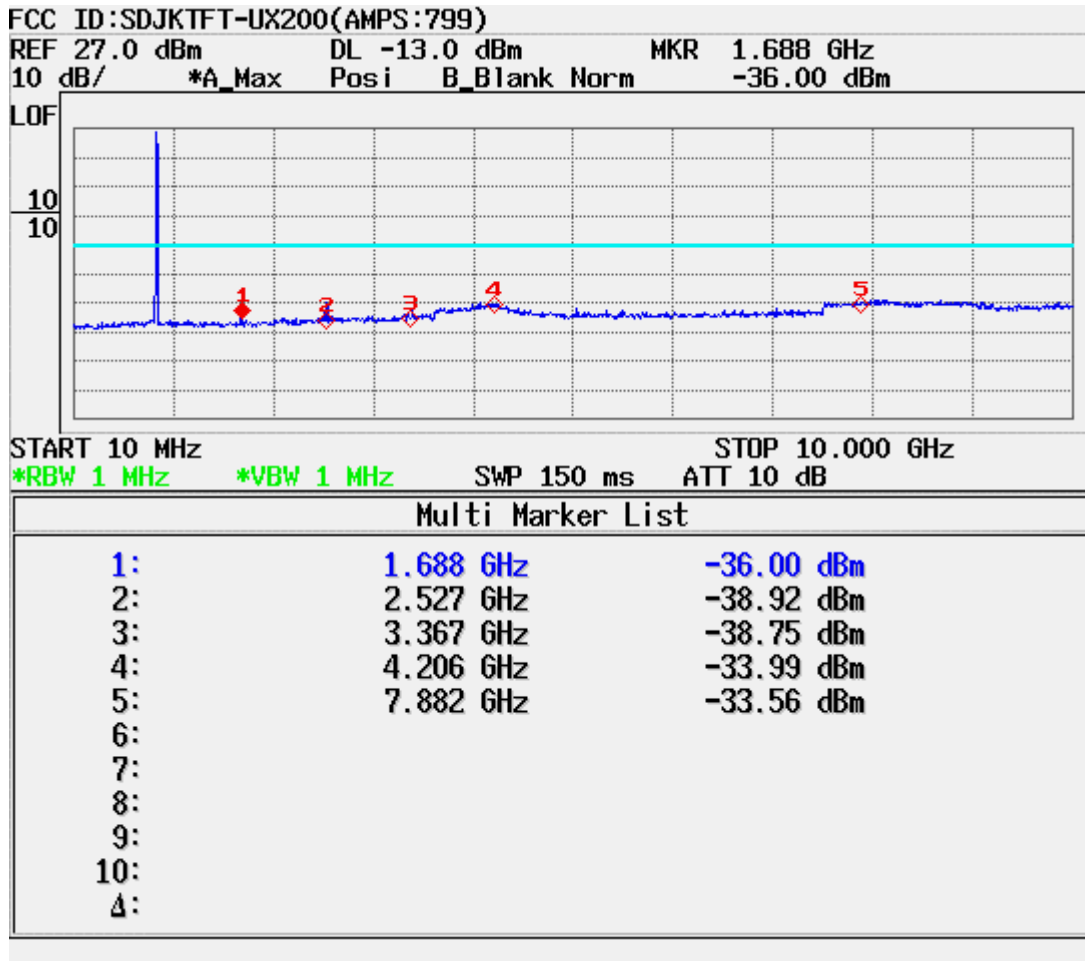

■ CDMA MODE (1013 CH.) Conducted Spurious

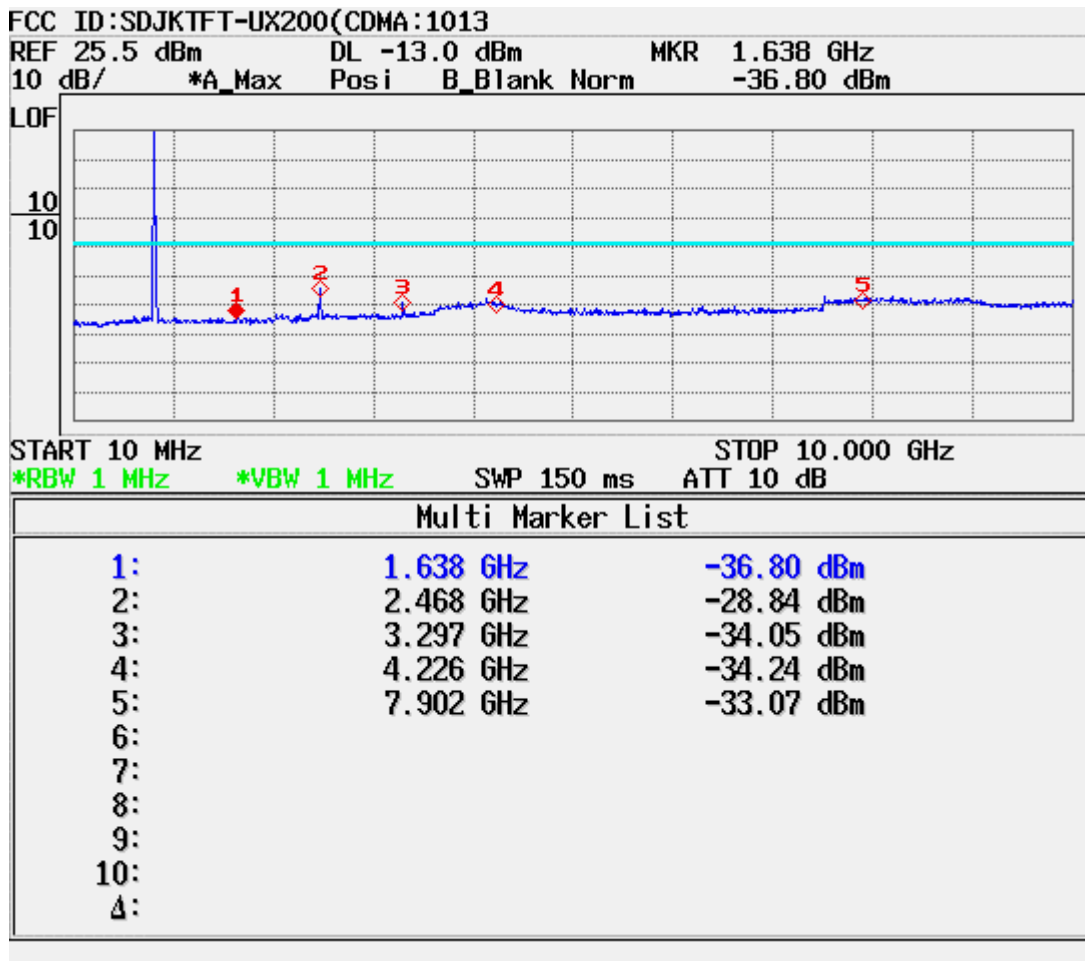

■ CDMA MODE (0363 CH.) Conducted Spurious

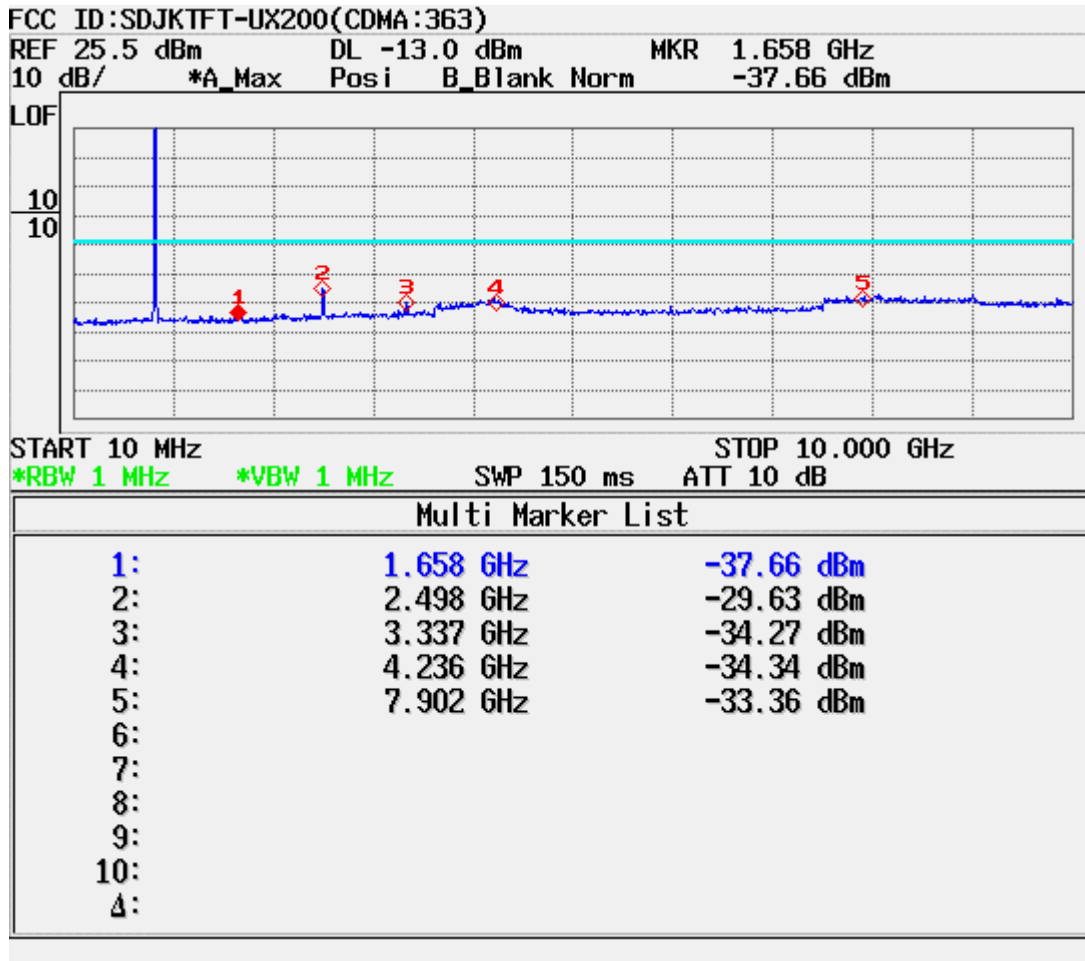

■ CDMA MODE (0777 CH.) Conducted Spurious

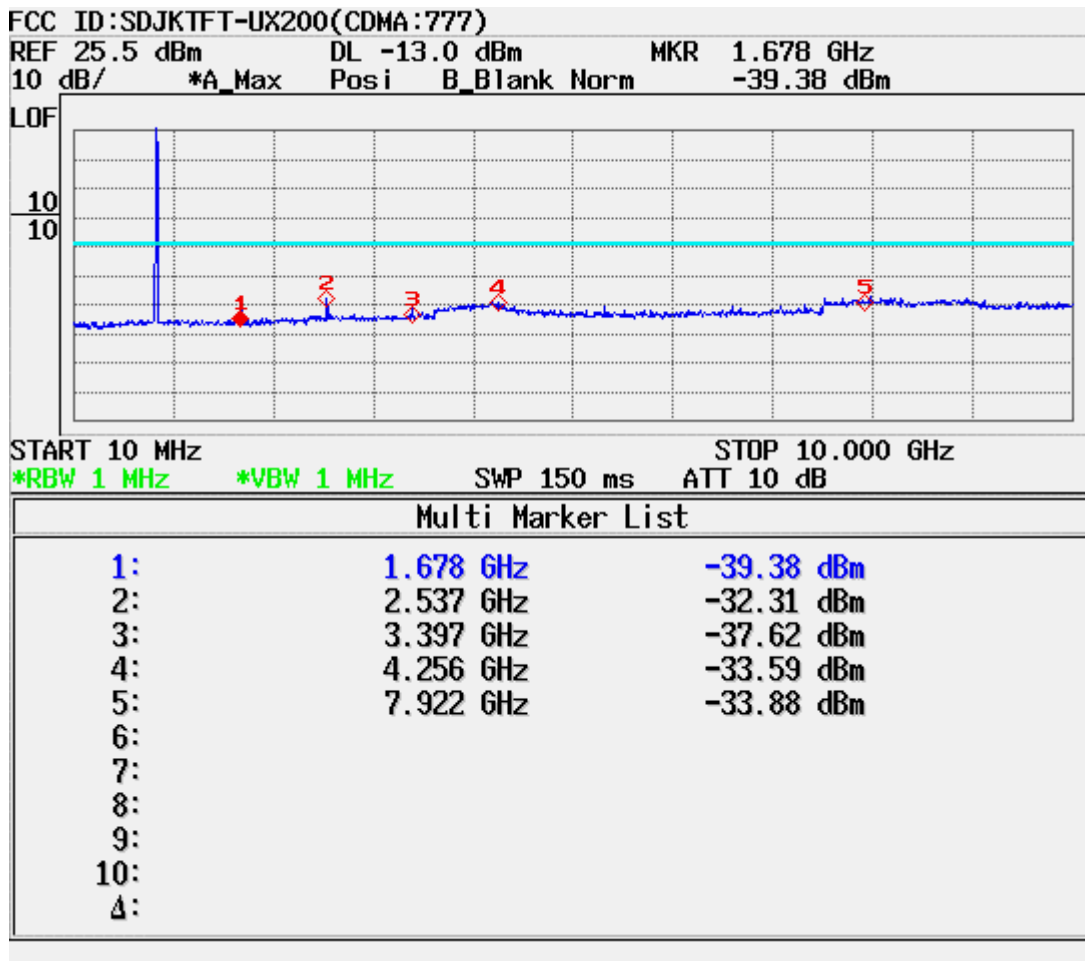

■ **PCS CDMA MODE (0025 CH.) Conducted Spurious**

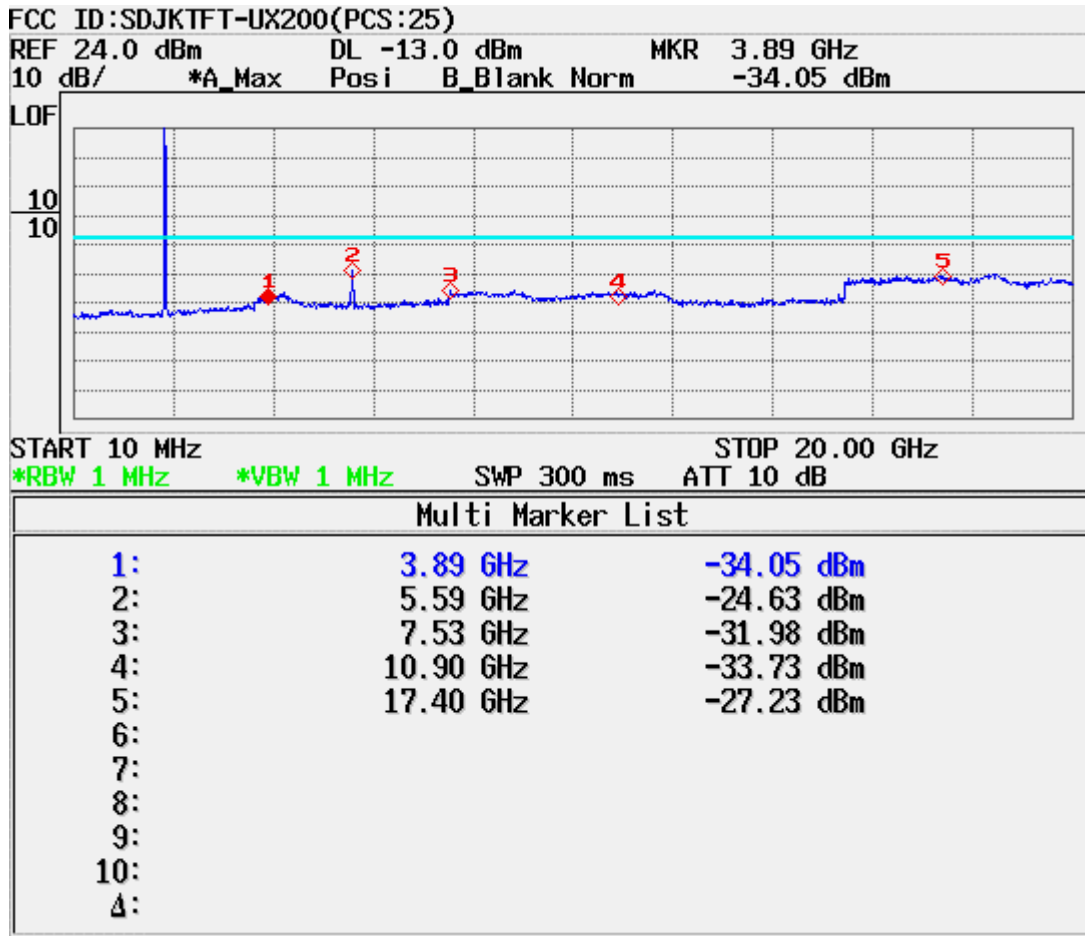

■ **PCS CDMA MODE (0600 CH.) Conducted Spurious**

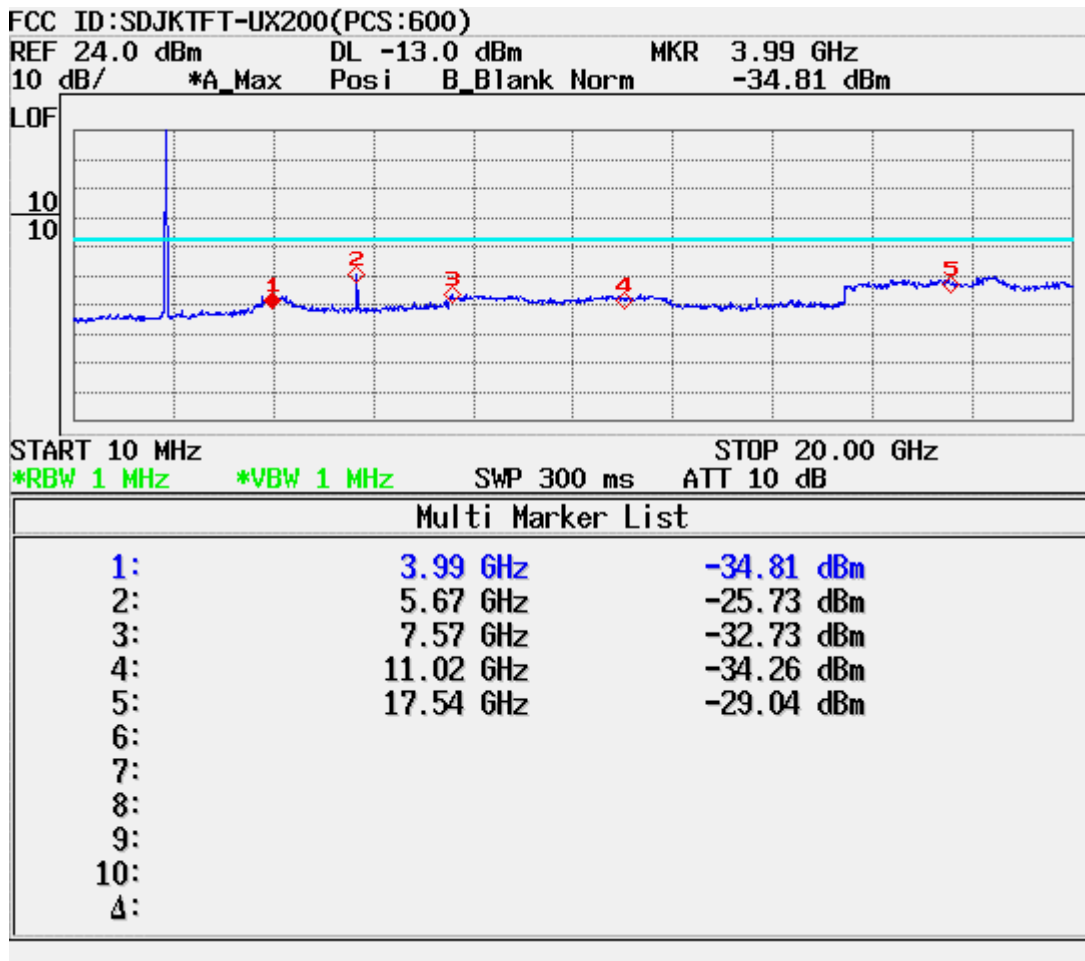

■ **PCS CDMA MODE (1175 CH.) Conducted Spurious**

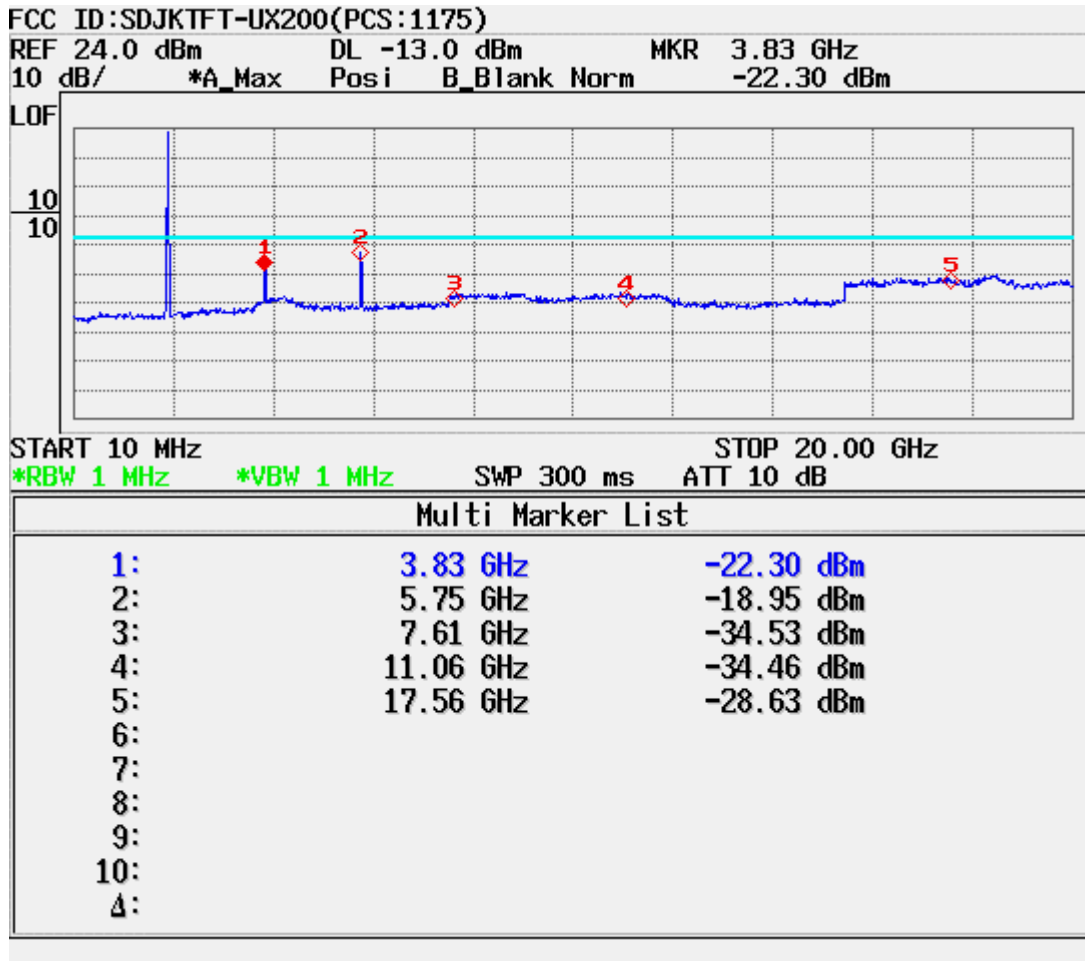

■ CDMA MODE (0363 CH.) : Channel Power

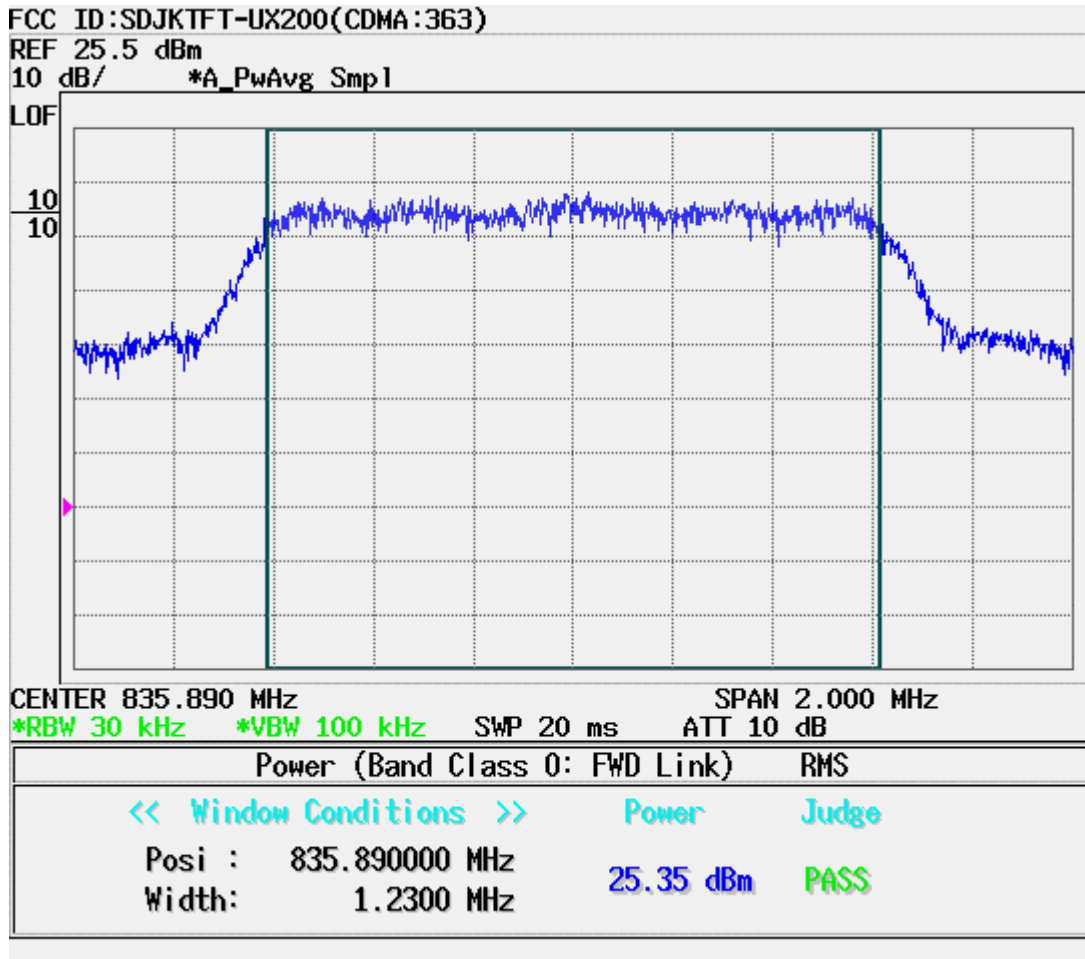

■ PCS CDMA MODE (0600 CH.) : Channel Power

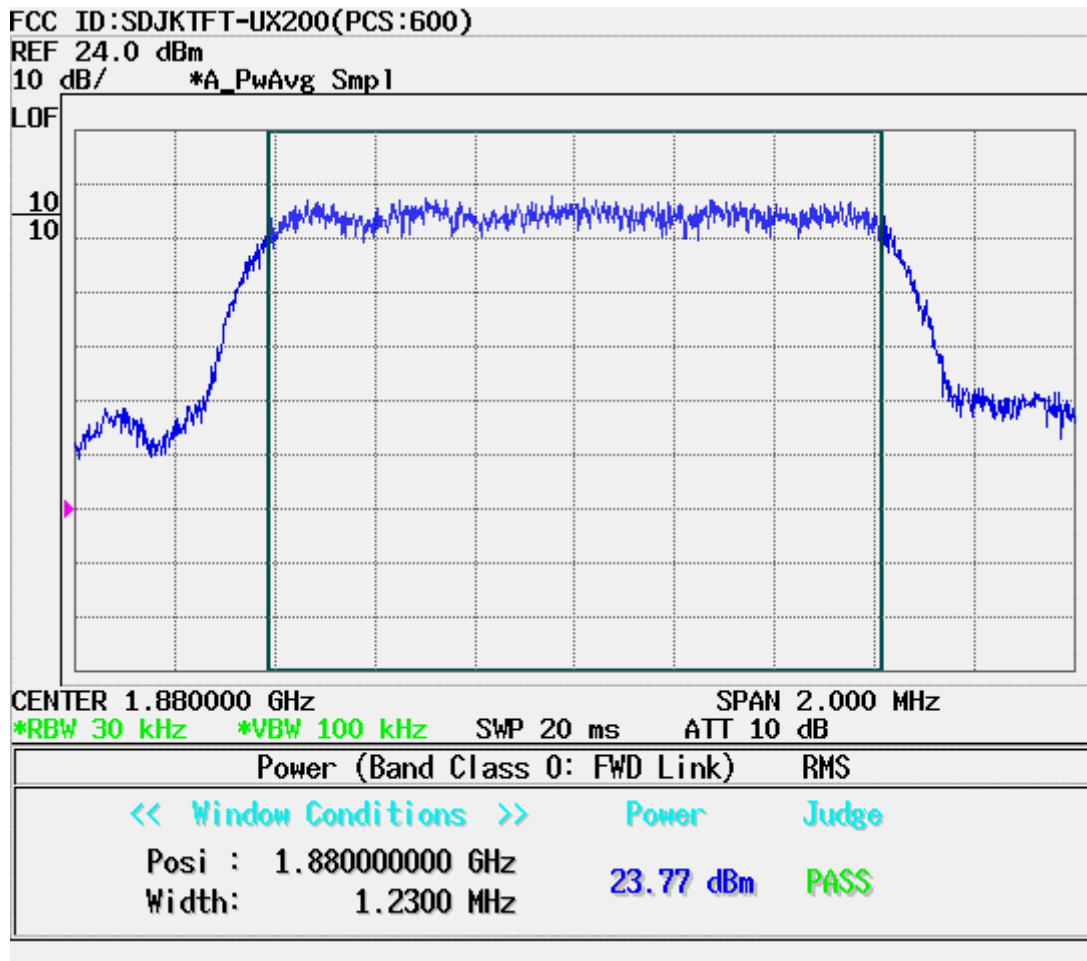

■ CDMA Mode (0363 CH.) : Occupied Bandwidth

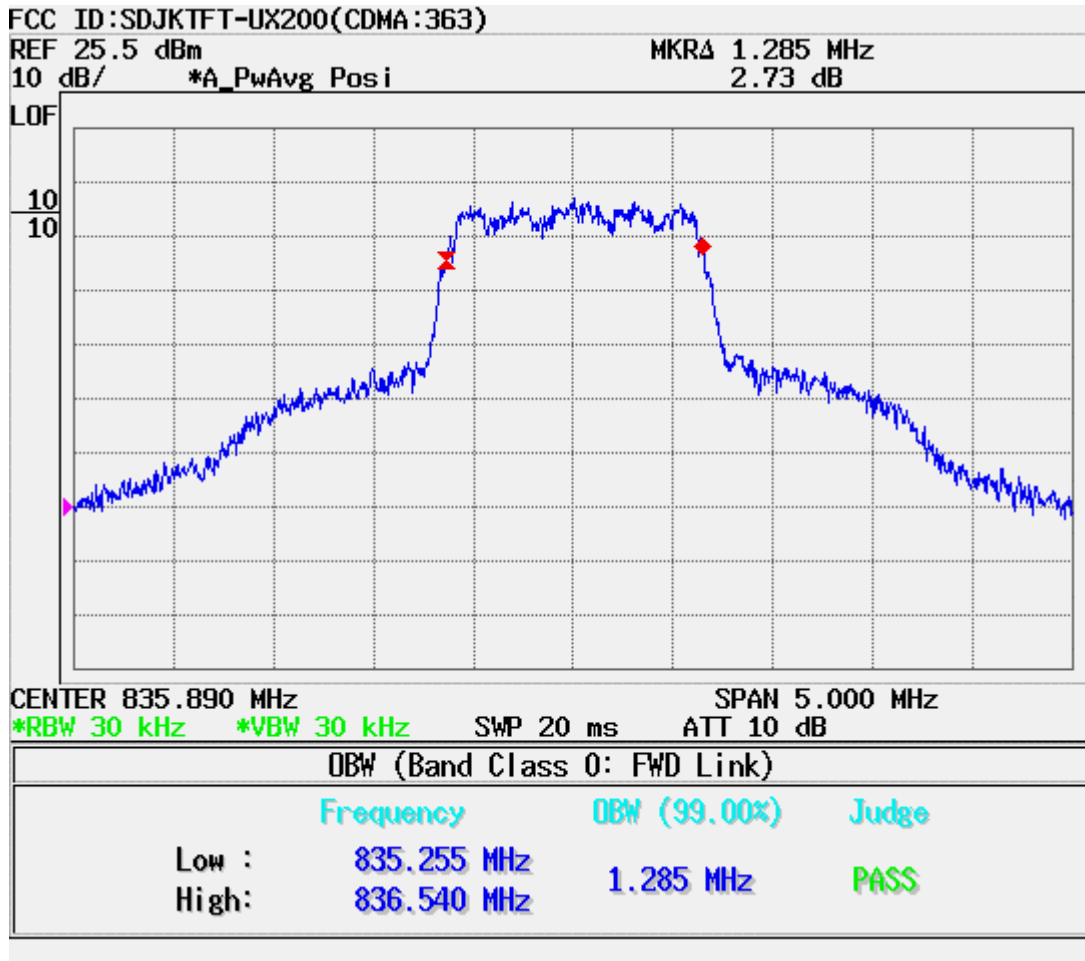

■ AMPS Mode (991 CH.) Block edge

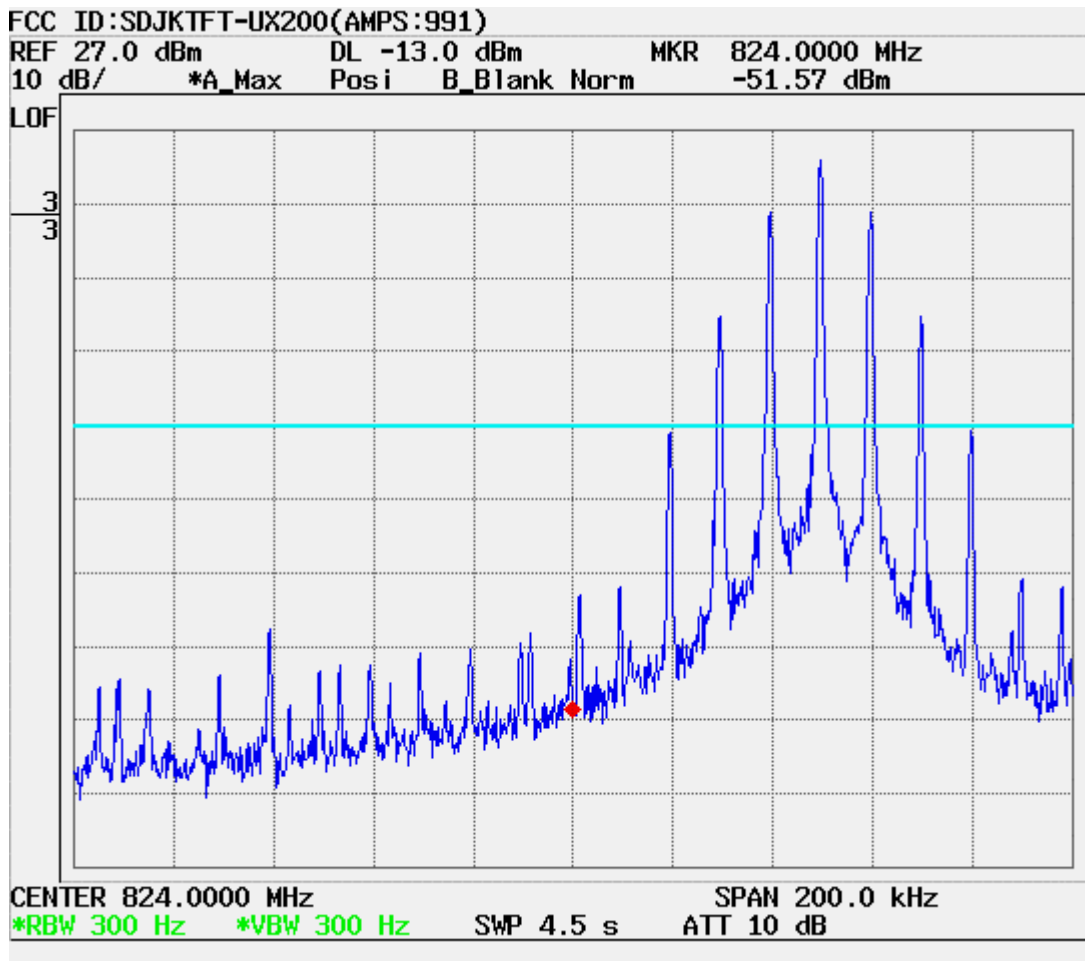

■ AMPS Mode (799 CH.) Band edge

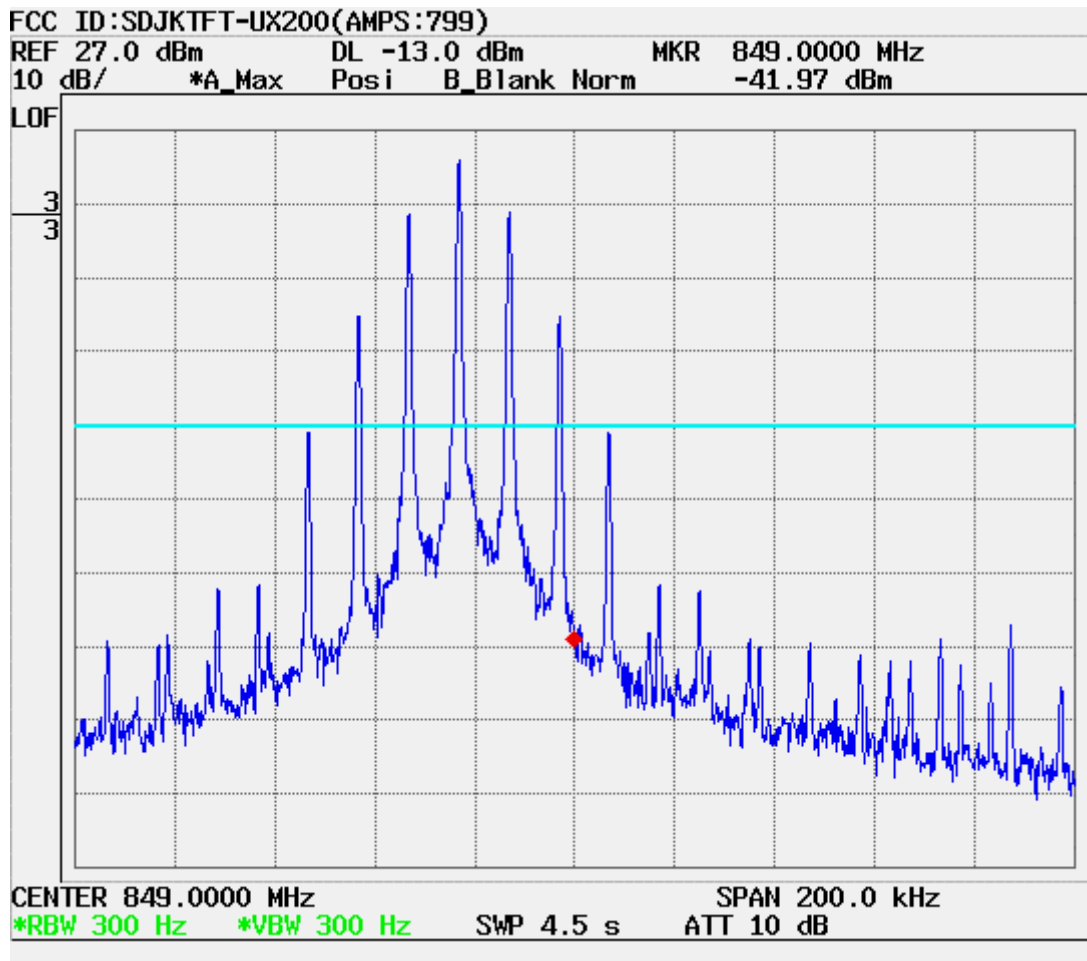

■ CDMA Cellular (1013 CH.) Band Edge

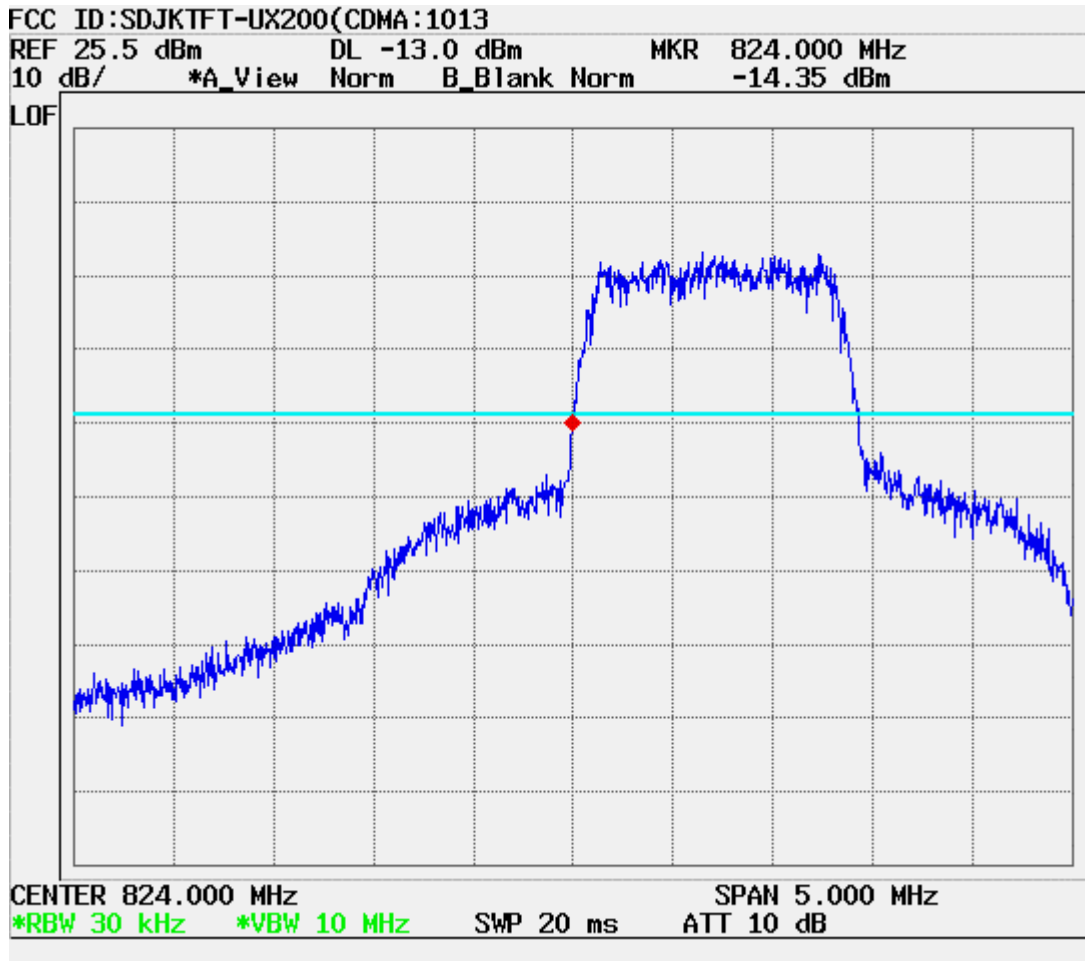

■ CDMA Cellular (777 CH.) Band Edge

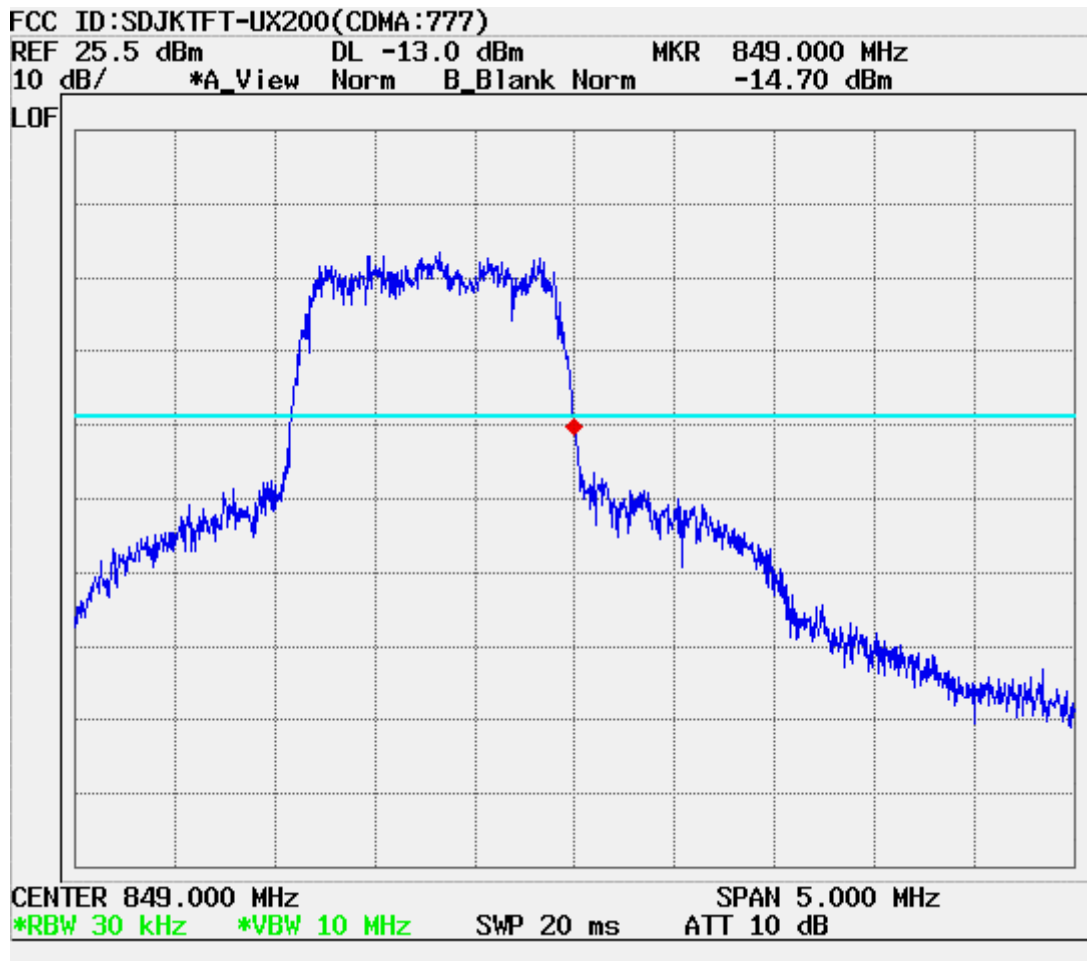

■ PCS Mode Band Edge (25 CH.)

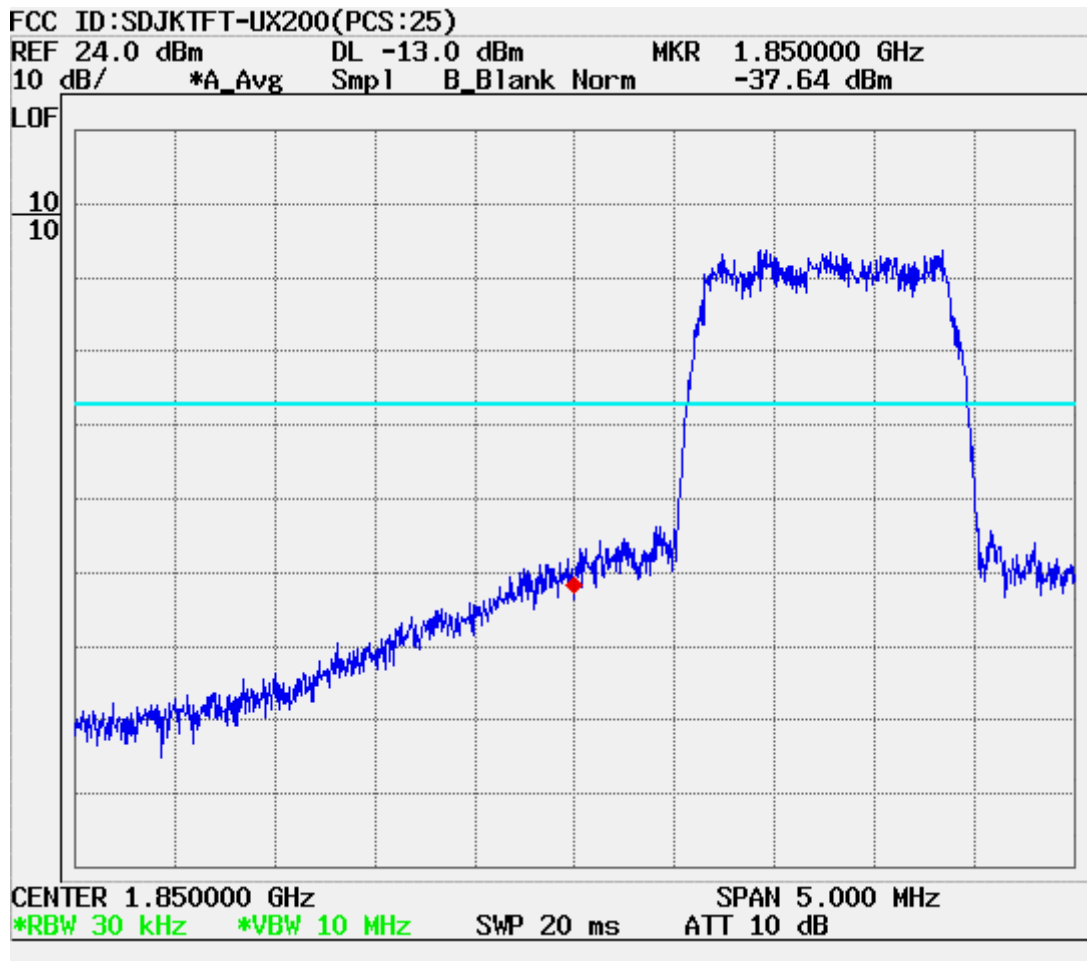

■ PCS Mode Band Edge (1175 CH.)

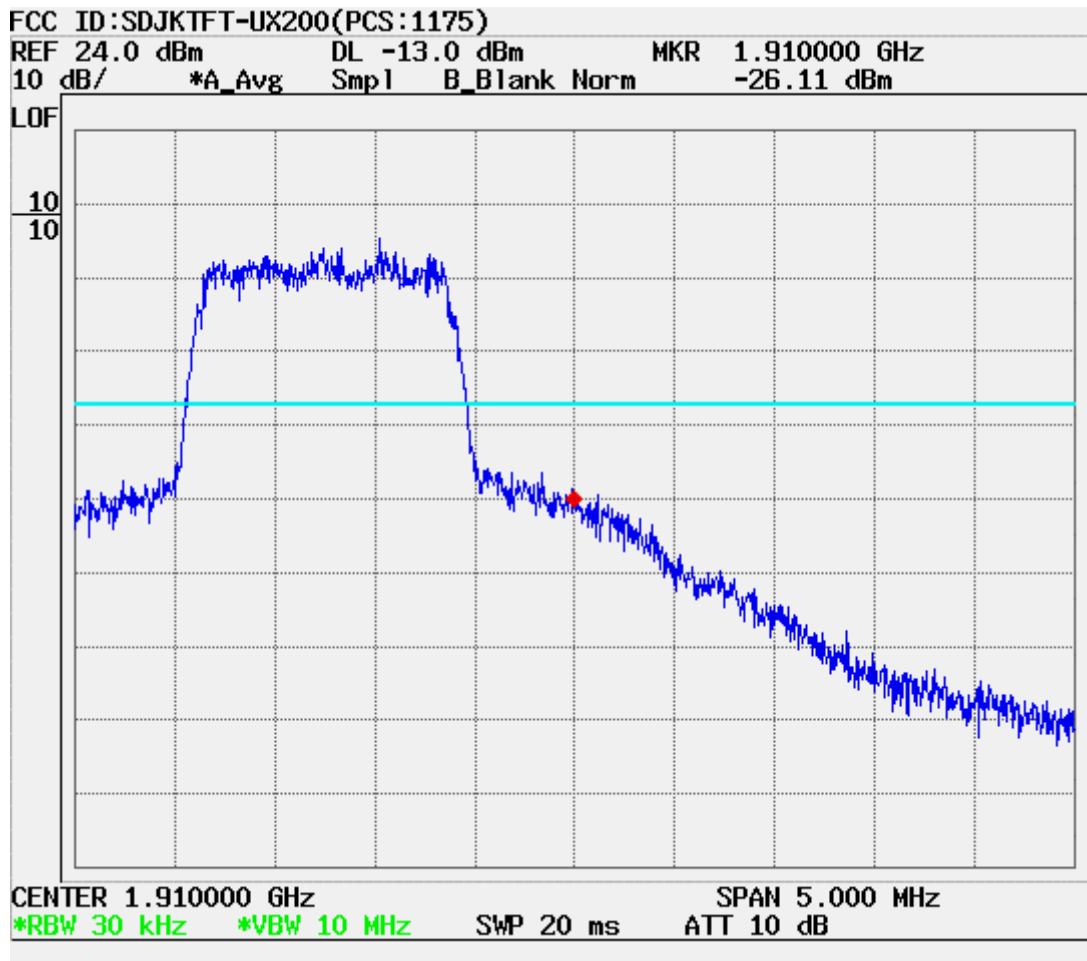

■ CDMA (1013 CH) Test Mode: POWER OUT

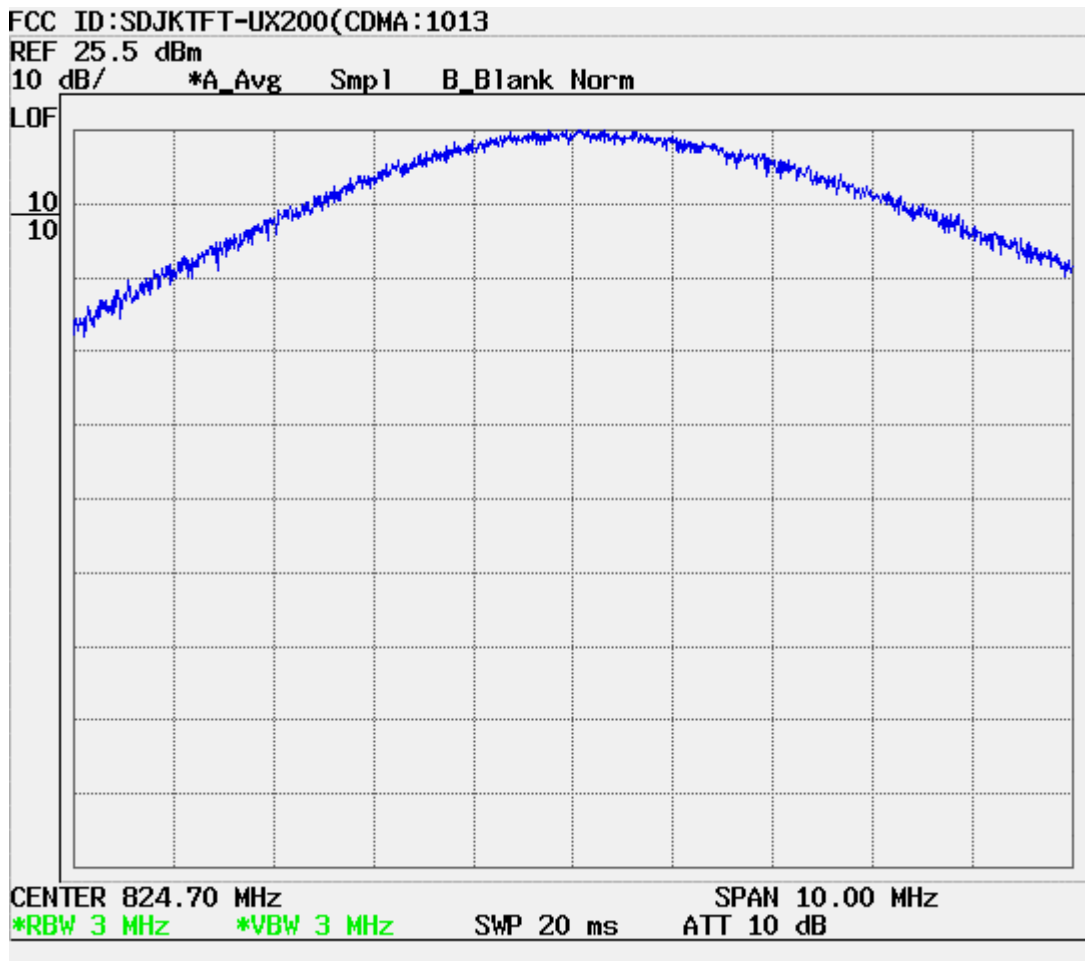

■ CDMA (0363 CH) Test Mode: POWER OUT

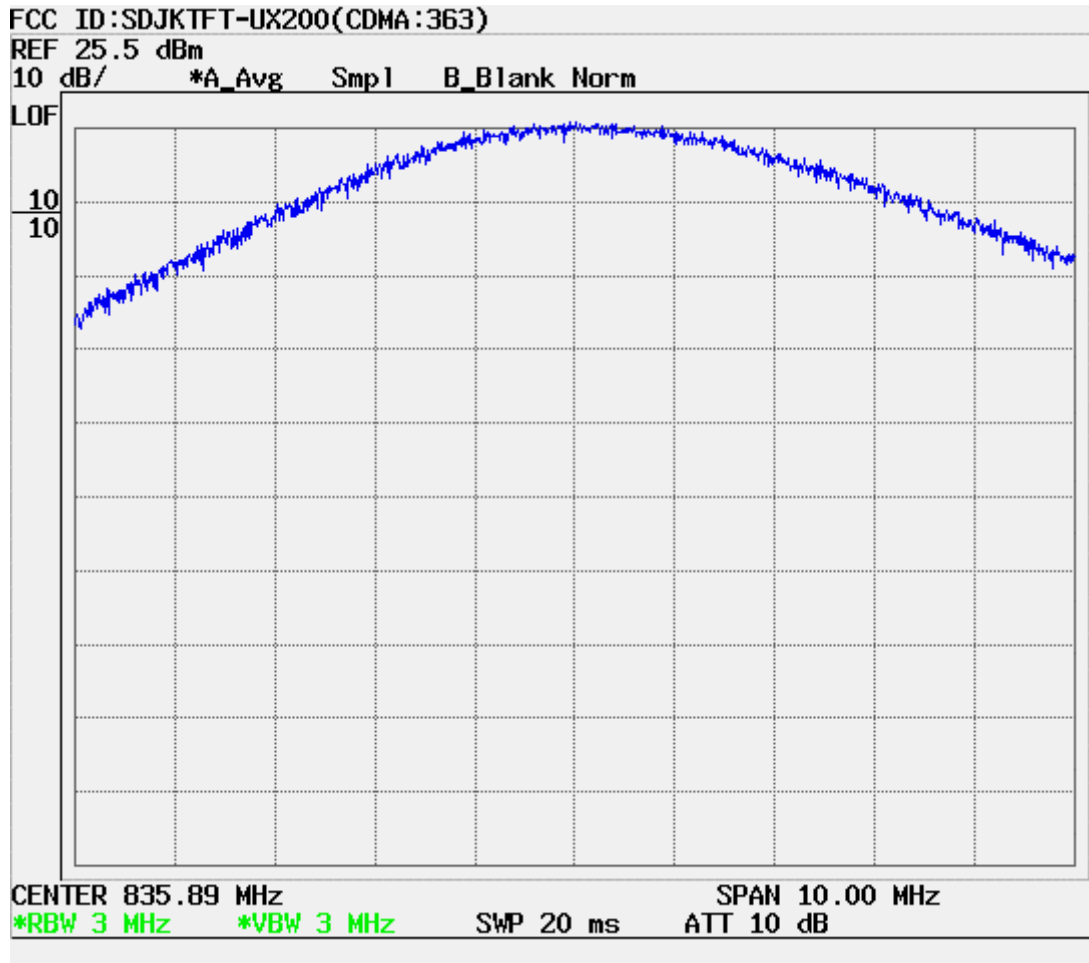

■ CDMA (0777 CH) Test Mode: POWER OUT

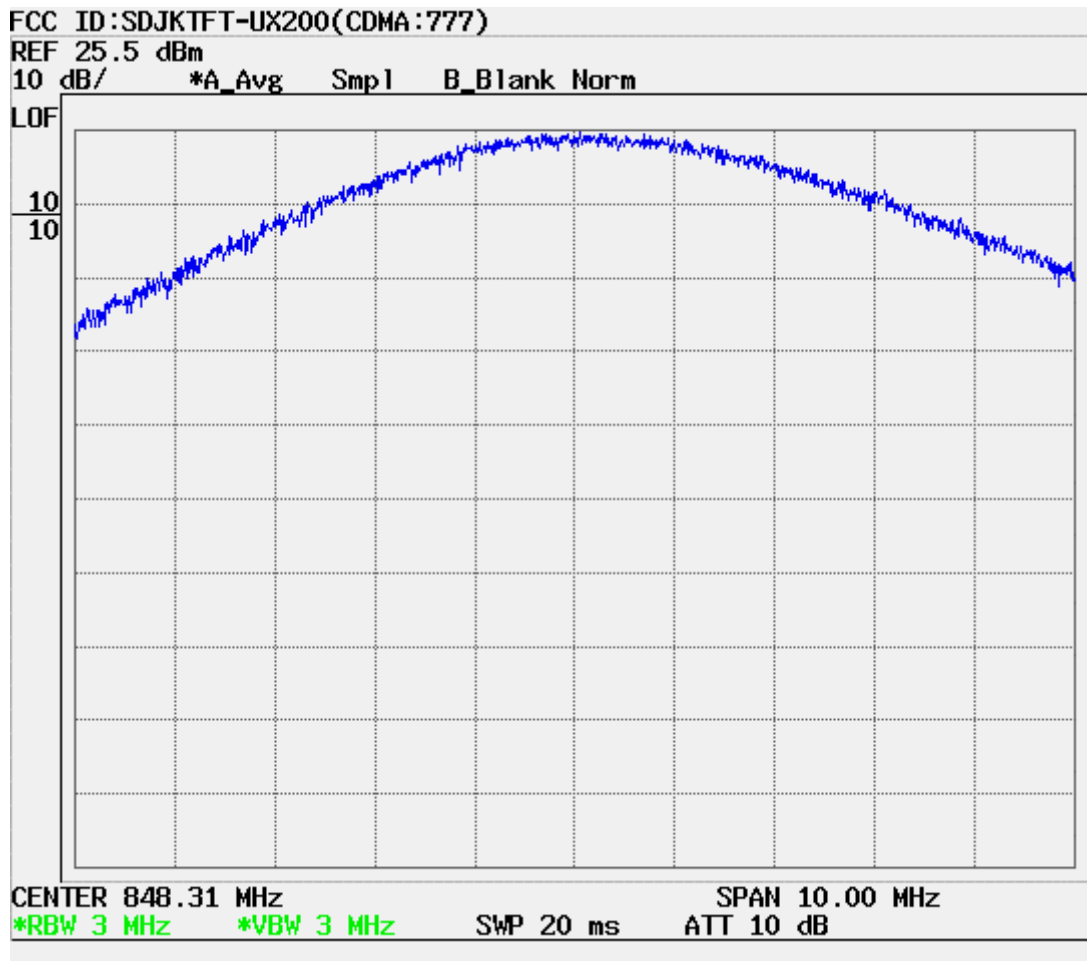

■ PCS CDMA (0025 CH) Test Mode: POWER OUT

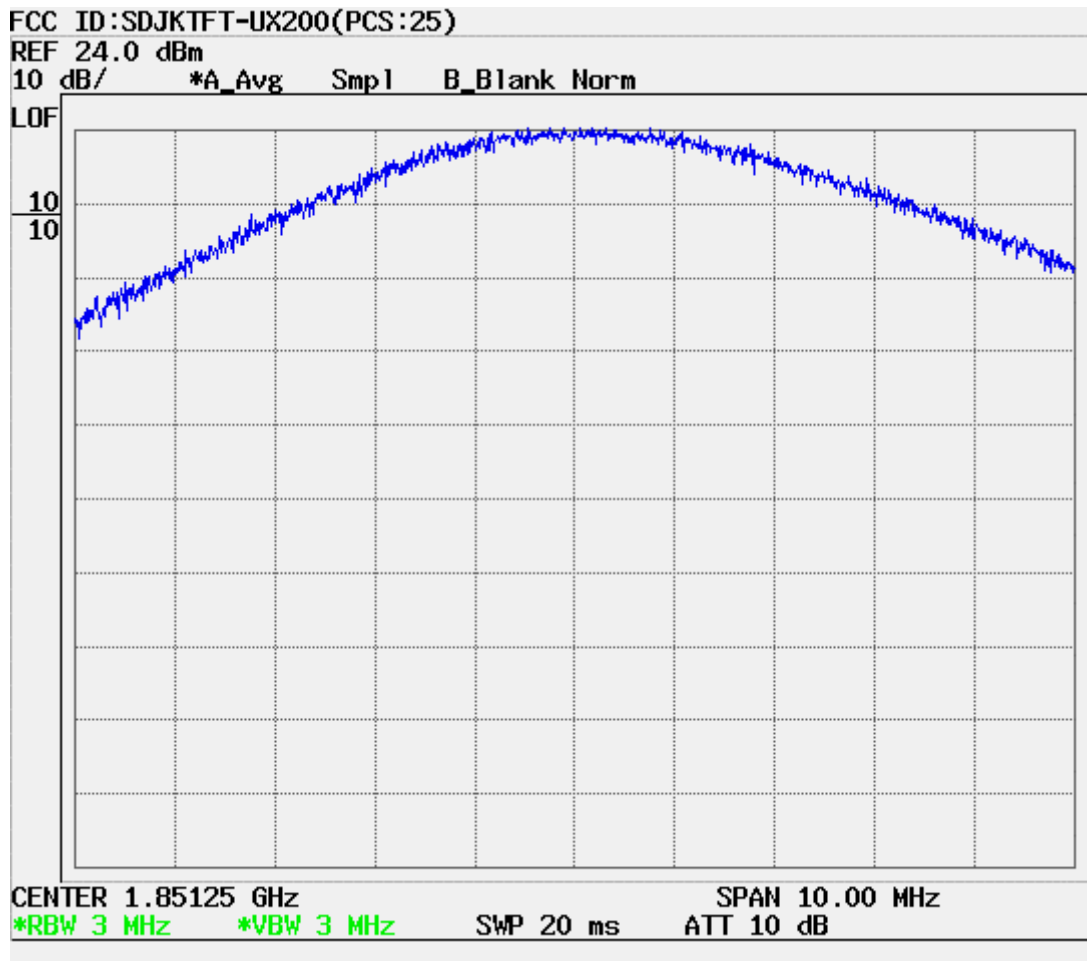

■ PCS CDMA (0600 CH) Test Mode: POWER OUT

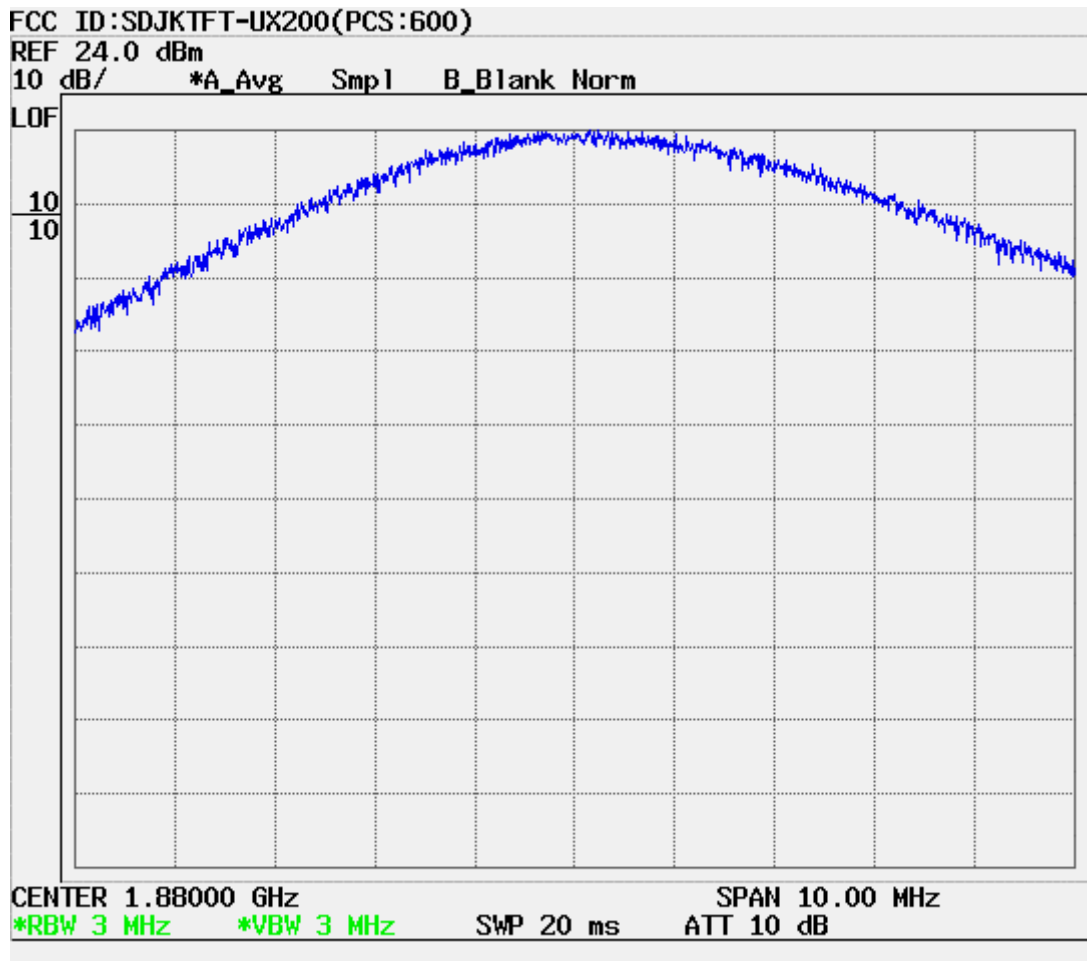

■ **PCS CDMA (1175 CH) Test Mode: POWER OUT**

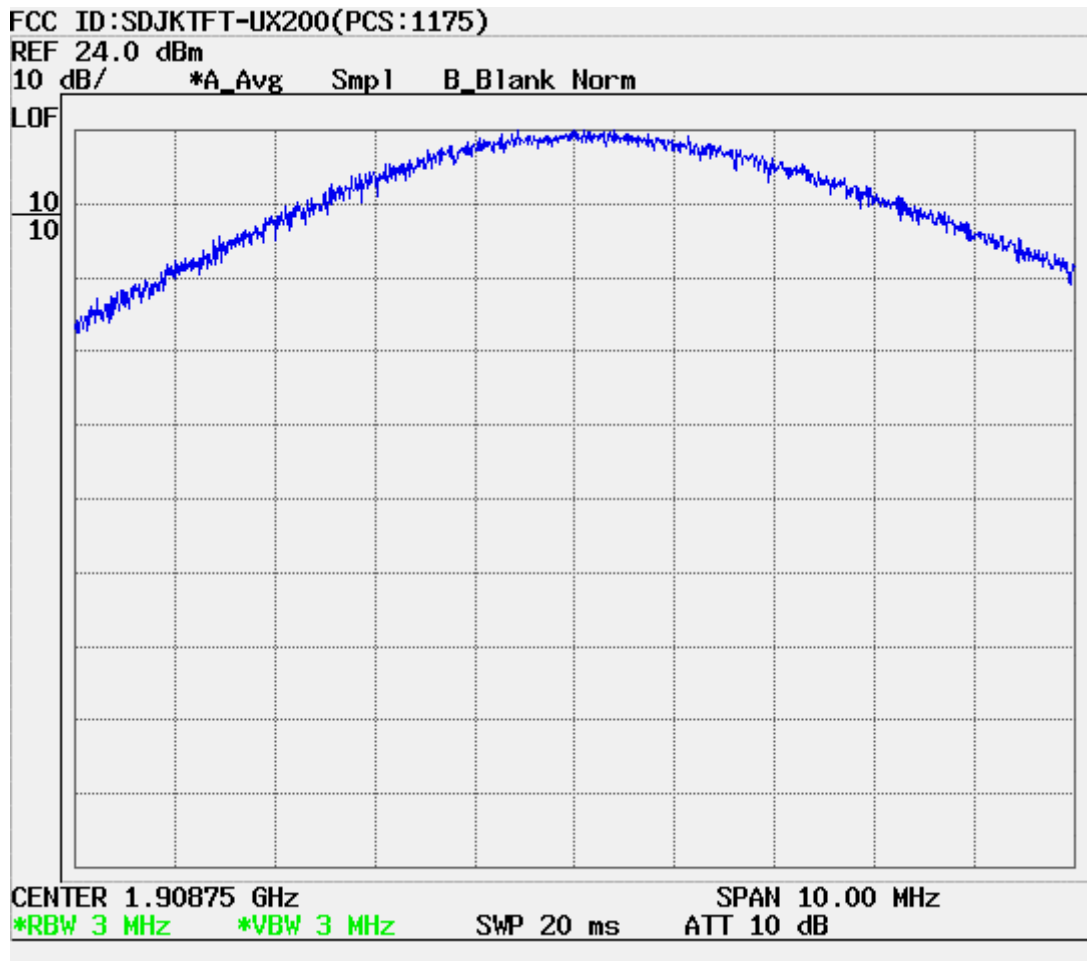

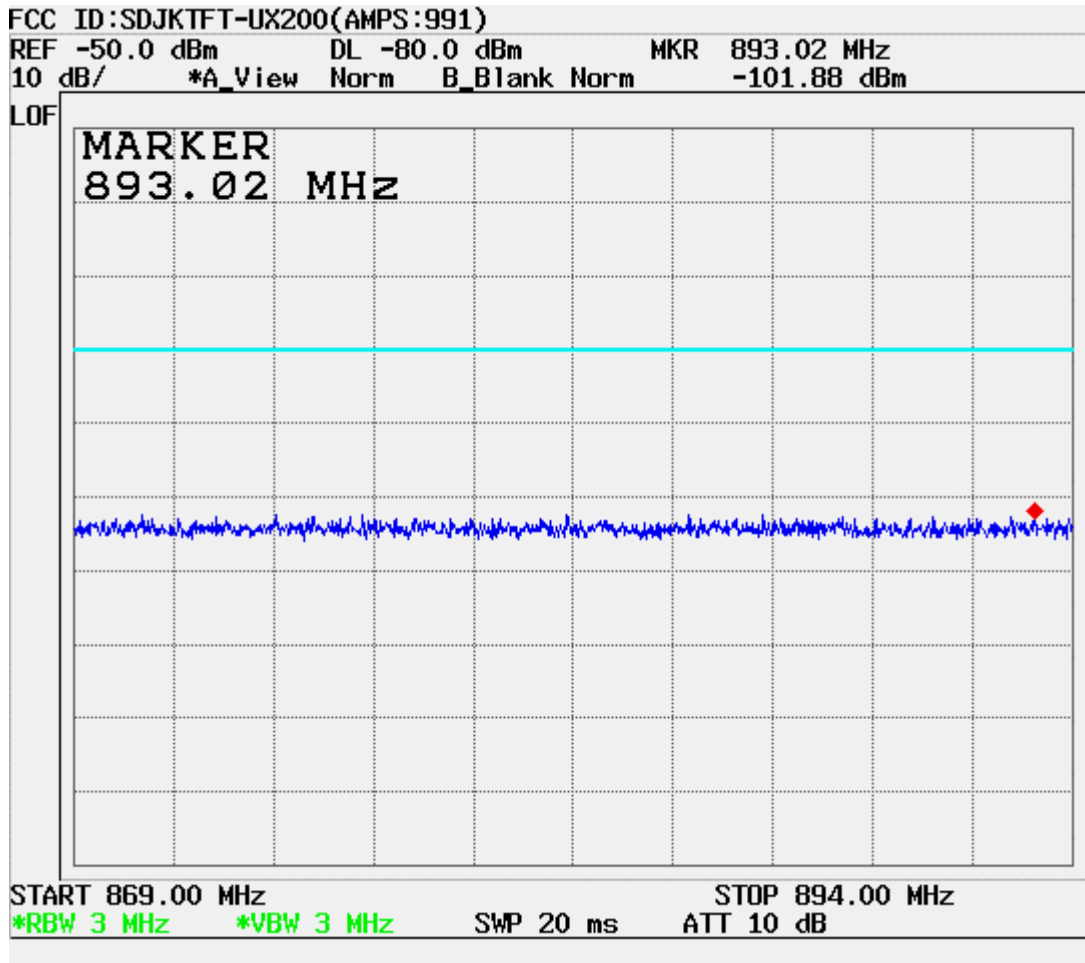

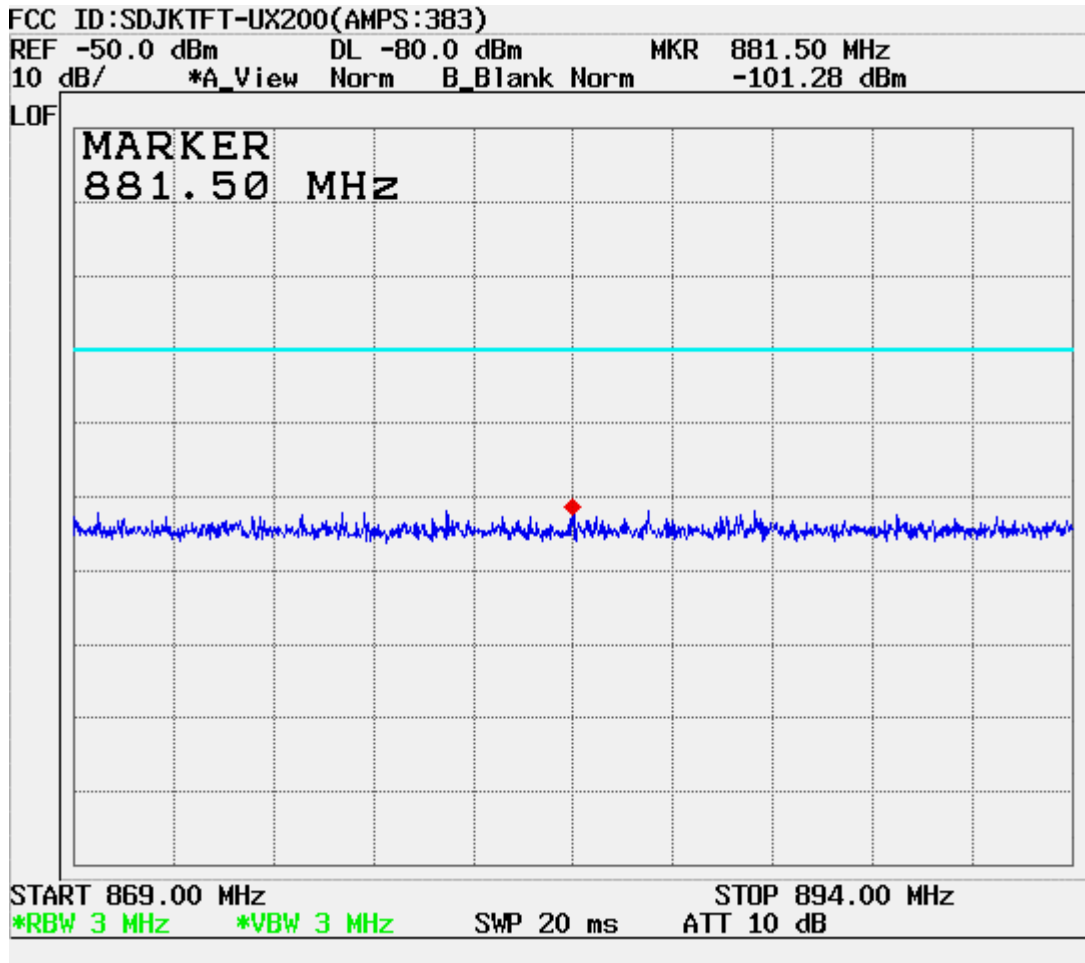

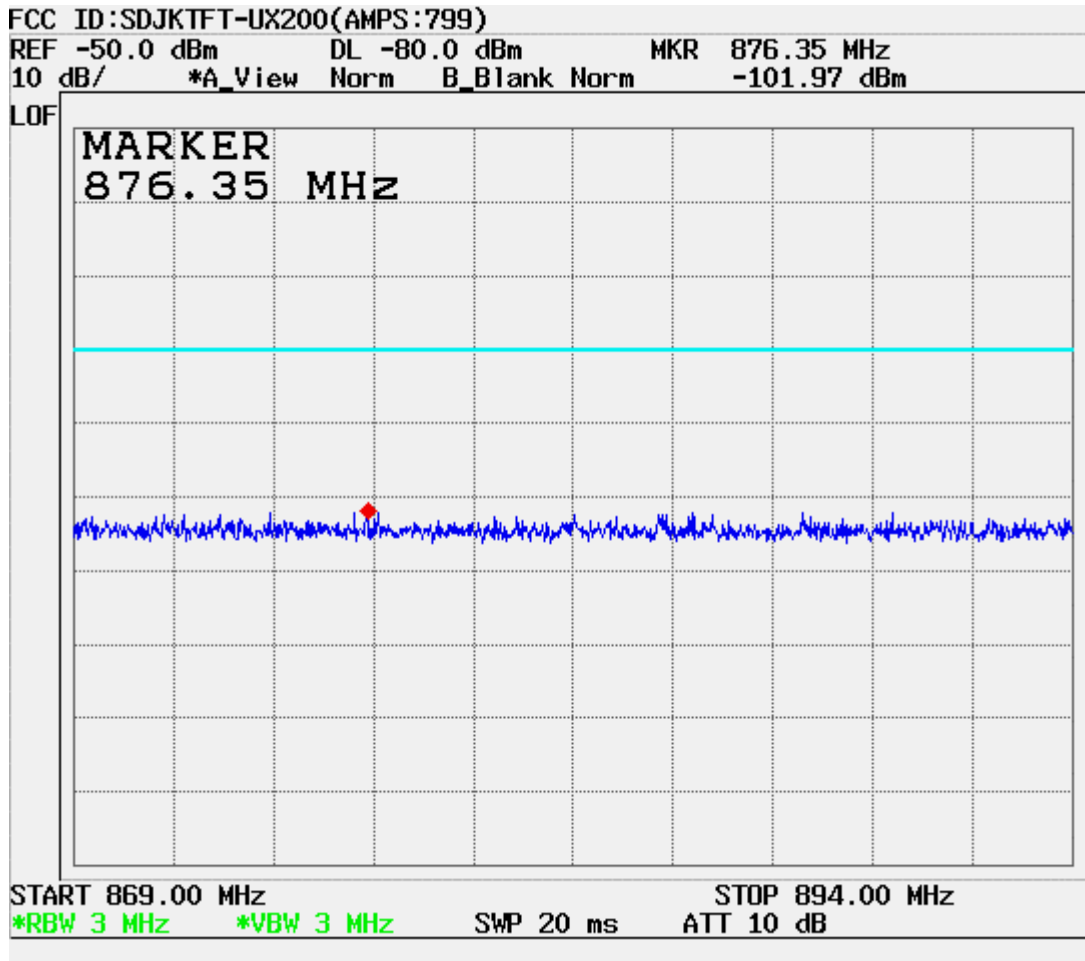

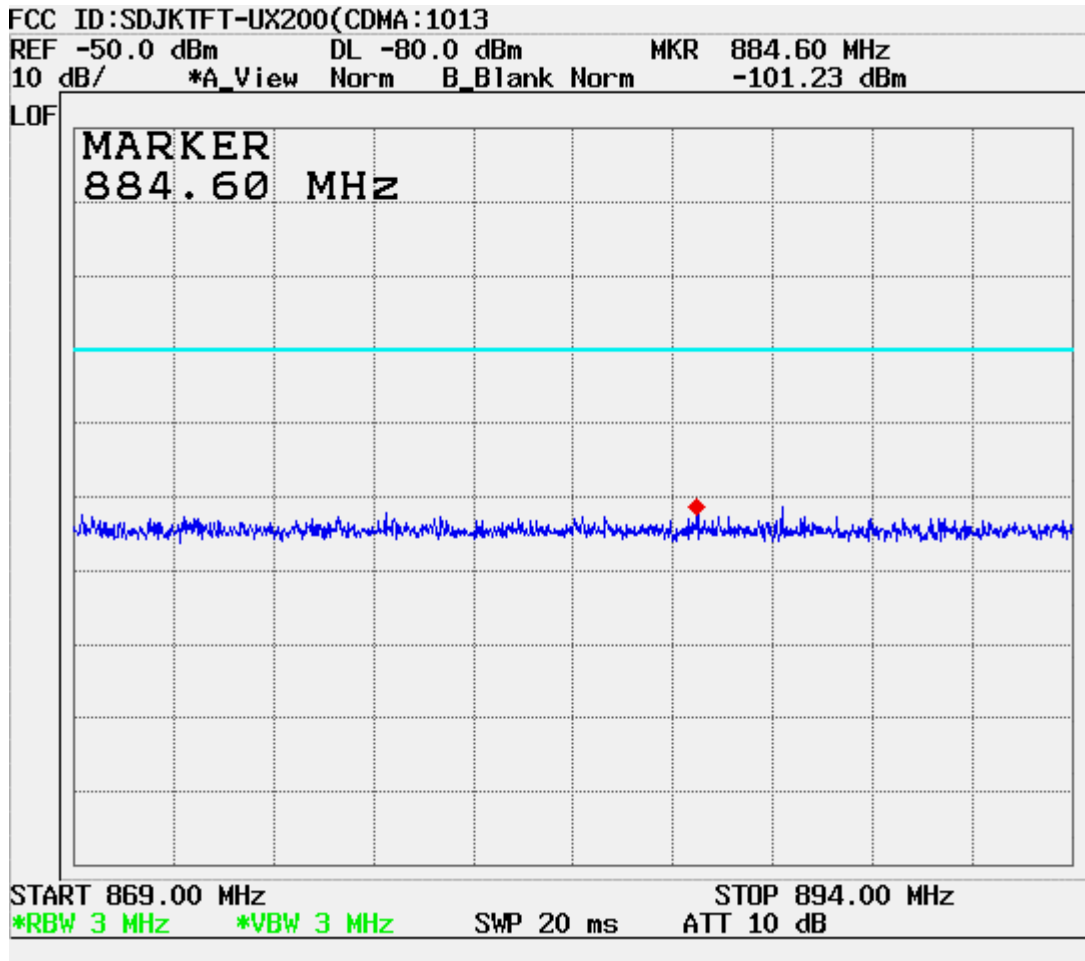

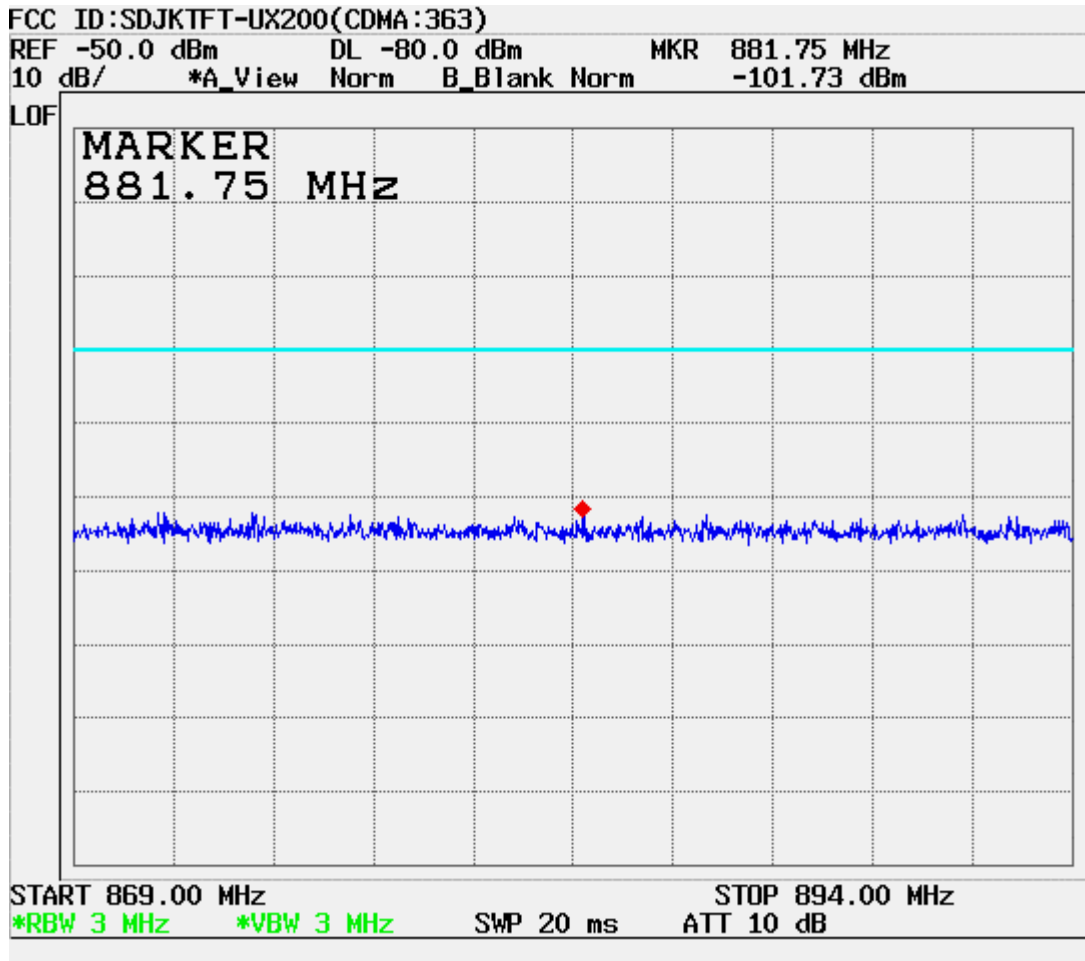

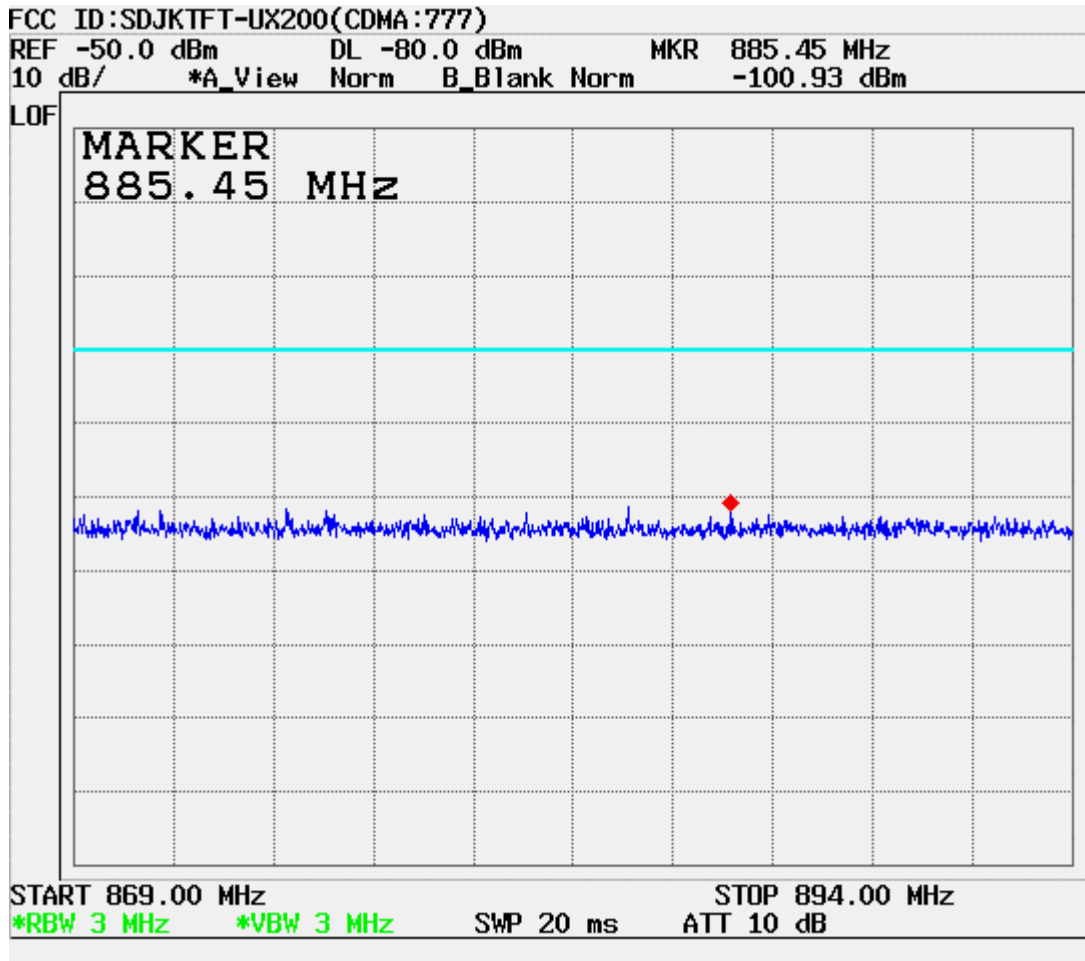

Frequency Response of Audio Low Pass Filter

- SUBJECT: Modulation Characteristics(FCC Part 22)
- FCC ID: SDJKTFT-UX200
- EUT:KTF Technologies Co., Ltd. / Tri-Mode Phone

FREQ	RESPONSE	LIMIT
1000	0	0.00
1500	0	0.00
2000	-2.53	0.00
2500	-4.01	0.00
3000	-5.28	0.00
3500	-8.71	-2.68
4000	-16.59	-5.00
4500	-26.54	-7.04
5000	-38.28	-8.87
5500	-39.18	-10.53
6000	-39.18	-12.04
6500	-39.18	-13.43
7000	-39.18	-14.72
7500	-39.18	-15.92
8000	-39.18	-17.04
8500	-39.18	-18.09
9000	-39.18	-19.08
9500	-39.18	-20.02
10000	-39.18	-20.92
15000	-39.18	-27.96
30000	-39.18	-28
60000	-39.18	-28
100000	-39.18	-28

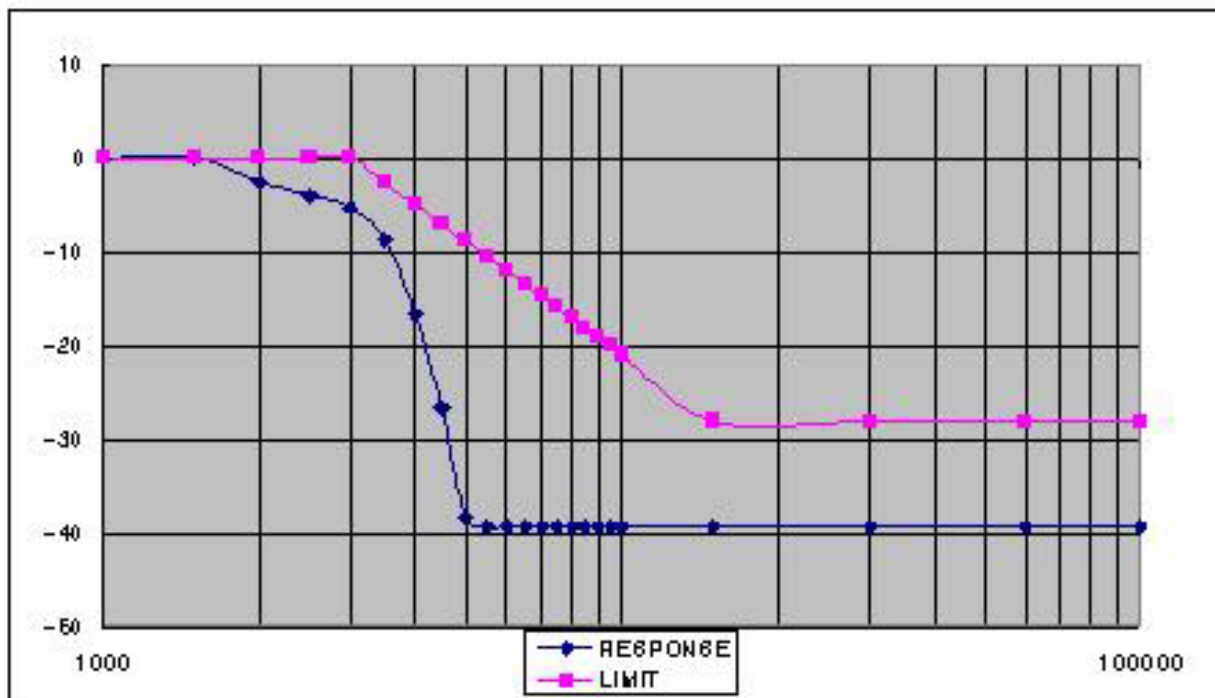

Modulation Limiting

- SUBJECT: Modulation Characteristics(FCC Part 22)
- FCC ID: SDJKTFT-UX200
- EUT:KTF Technologies Co., Ltd. / Tri-Mode Phone

Input(dBV)	300Hz	1004Hz	3000Hz	LIMIT(±12KHz)
20	7.48	11.27	10.54	12
15	6.52	11.14	10.28	12
10	3.64	11.06	10.12	12
5	3.16	9.07	9.56	12
0	2.67	7.2	9.21	12
-5	2.29	5.68	8.85	12
-10	2.32	4.52	7.89	12
-15	1.84	3.69	6.86	12
-20	1.82	3.42	5.26	12

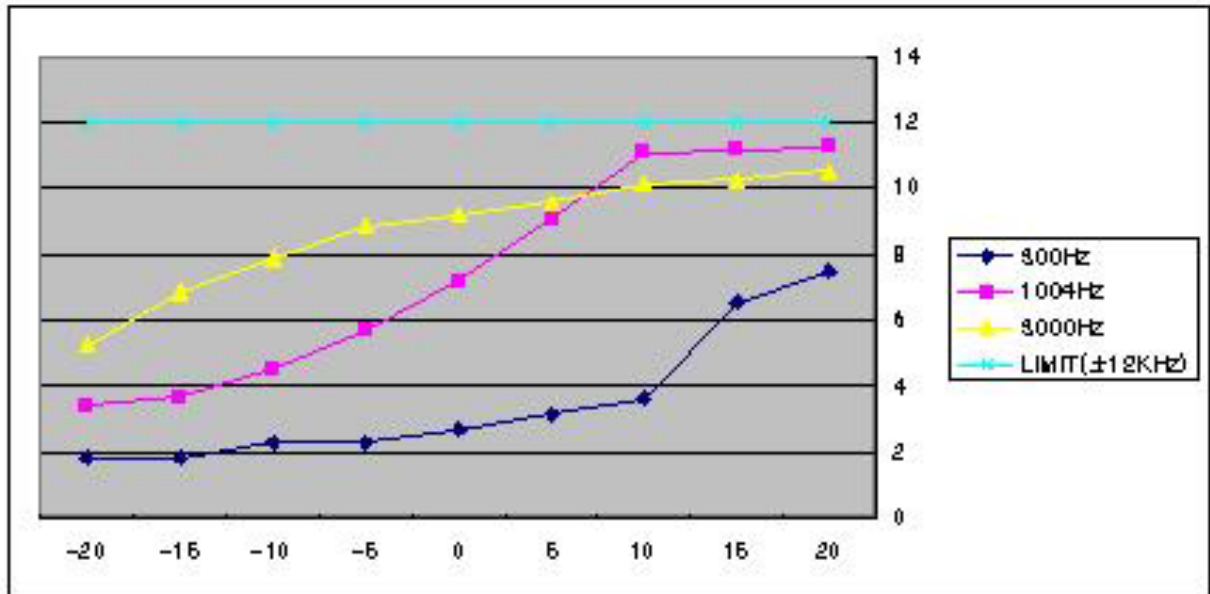

TEST METHOD

1. CONNECT MODULATION
2. 1KHz 60% DEVIATION(7.2KHz) ADJUST
3. VARY INPUT LEVEL(5dB)
4. VARY FREQUENCY AT 300Hz, 1004Hz, 3000Hz)

Transmitter Audio Frequency Response

- SUBJECT: Modulation Characteristics(FCC Part 22)
- FCC ID: SDJKTFT-UX200
- EUT:KTF Technologies Co., Ltd. / Tri-Mode Phone

FREQUENCY	RESONSE	LIMIT	
		-3	1
300	-12.4	-13.46	-9.46
400	-9.1	-10.96	-6.96
500	-7.2	-9.02	-5.02
600	-5.3	-7.44	-3.44
700	-3.9	-6.10	-2.10
800	-2.8	-4.94	-0.94
900	-1.7	-3.92	0.08
1000	0.0	-3.00	1.00
1200	1.4	-1.42	2.58
1400	2.5	-0.08	3.92
1600	3.9	1.08	5.08
1800	5.1	2.11	6.11
2000	6.1	3.02	7.02
2200	6.4	3.85	7.85
2500	7.2	4.96	8.96
2600	7.7	4.96	9.30
2800	7.8	4.96	9.94
3000	6.5	4.96	10.54
3000	6.4	-40.00	10.54
3200	6.1	-40.00	9.42
3400	4.8	-40.00	8.37
3600	-0.4	-40.00	7.37
3800	-10.9	-40.00	6.43
4000	-14.7	-40.00	5.54
4200	-26.0	-40.00	4.69
4500	-26.0	-40.00	3.50
4800	-26.0	-40.00	2.38
5100	-26.0	-40.00	1.32
5400	-26.0	-40.00	0.33
5700	-26.0	-40.00	-0.61
5900	-26.0	-40.00	-1.21
5900	-26.0	-40.00	-24.46
6100	-26.0	-40.00	-24.46
6100	-26.0	-40.00	-1.79
6500	-26.0	-40.00	-2.89
8000	-26.0	-40.00	-6.50
10000	-26.0	-40.00	-10.38
13000	-26.0	-40.00	-14.93
15000	-26.0	-40.00	-17.42
15000	-26.0	-40.00	-17.46
30000	-26.0	-40.00	-17.46

