

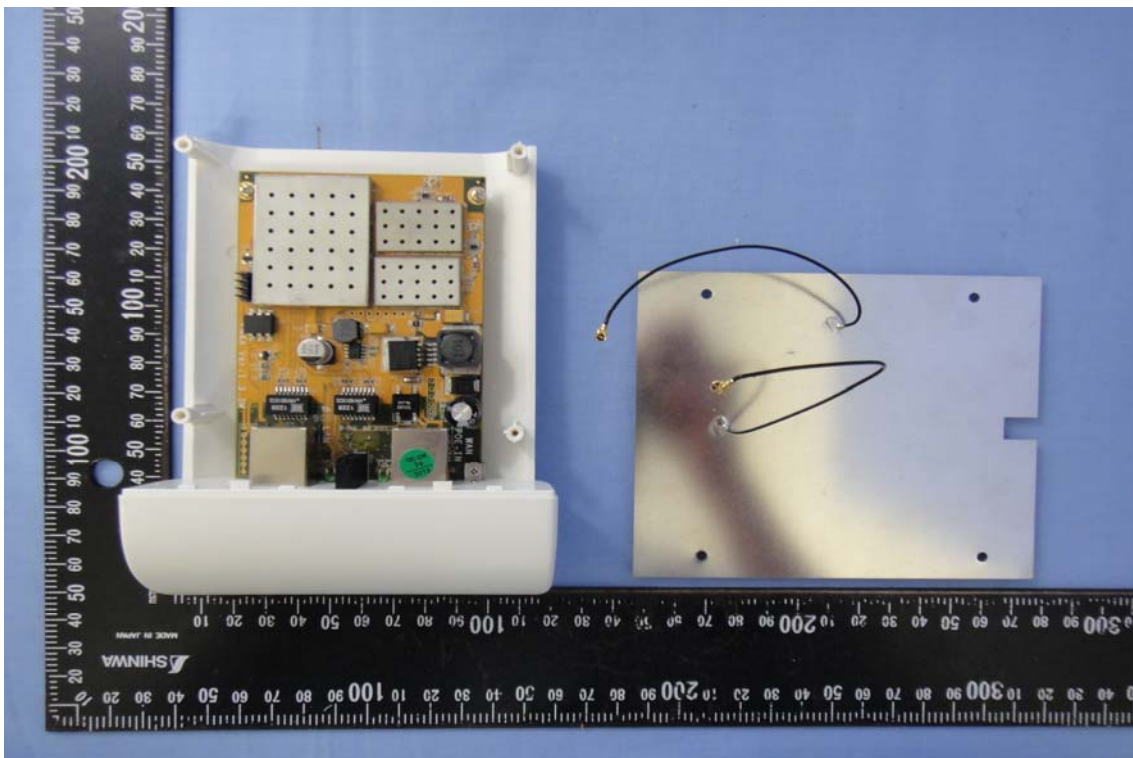

## INTERNAL PHOTOGRAPHS OF EUT

Model: DAP-3310

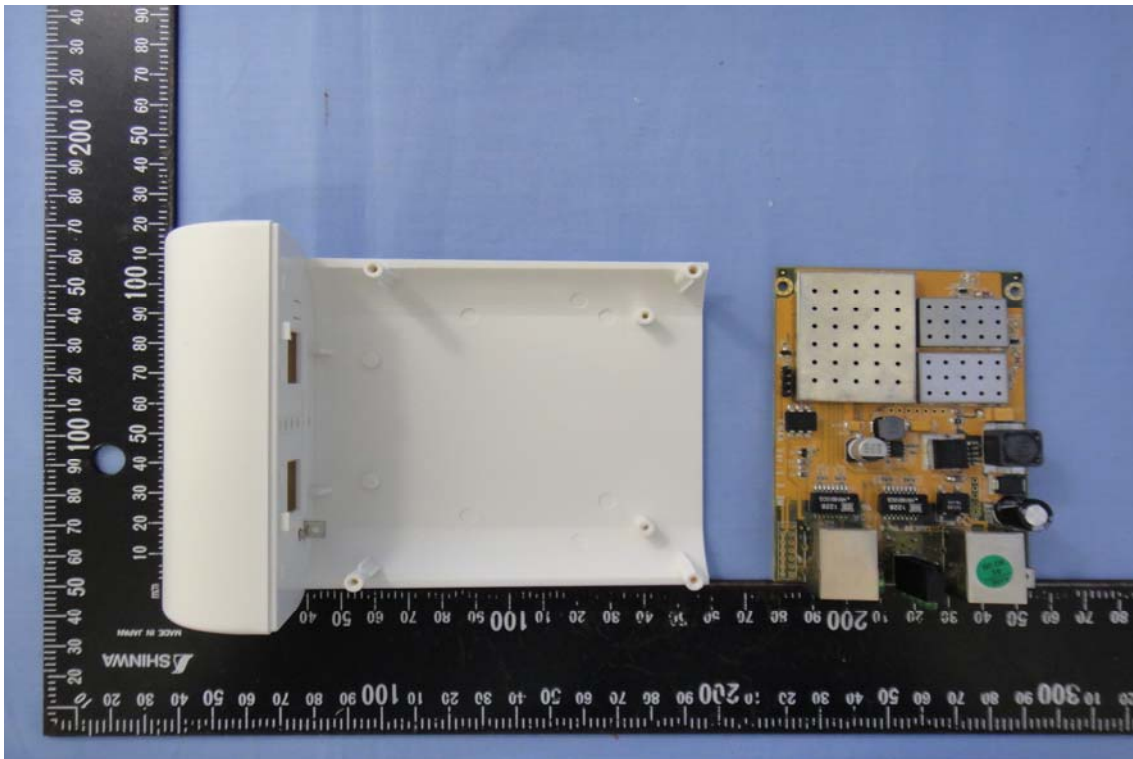

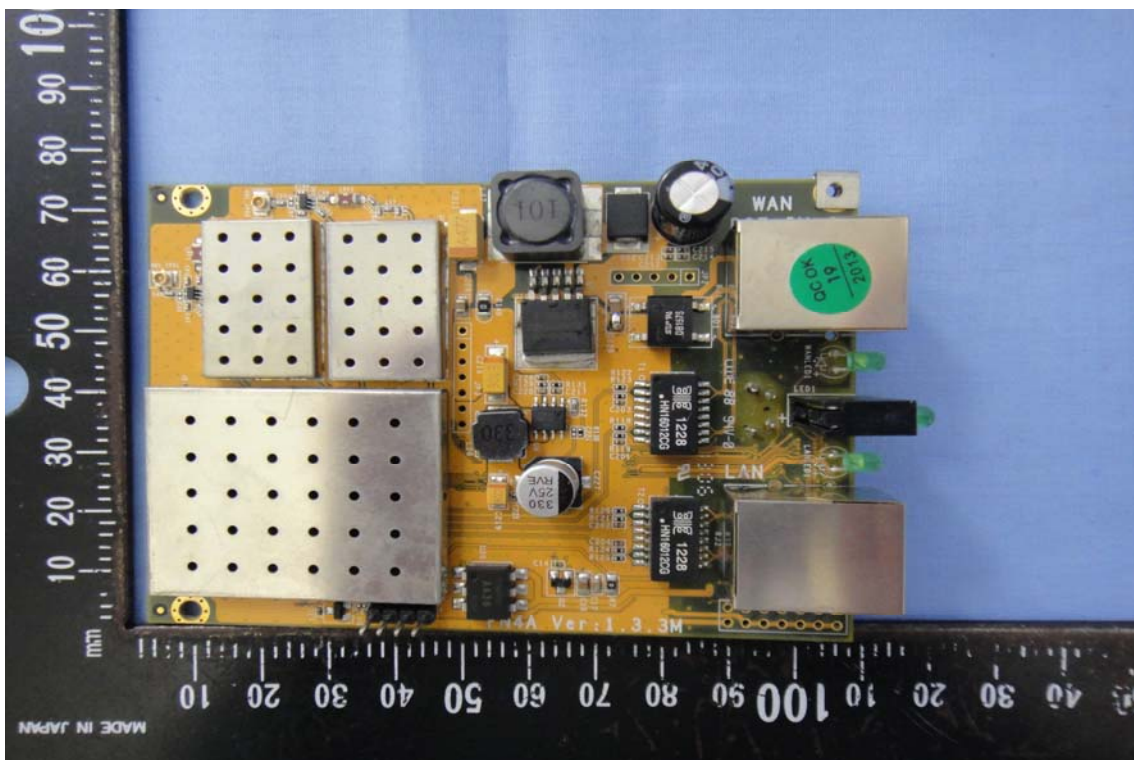
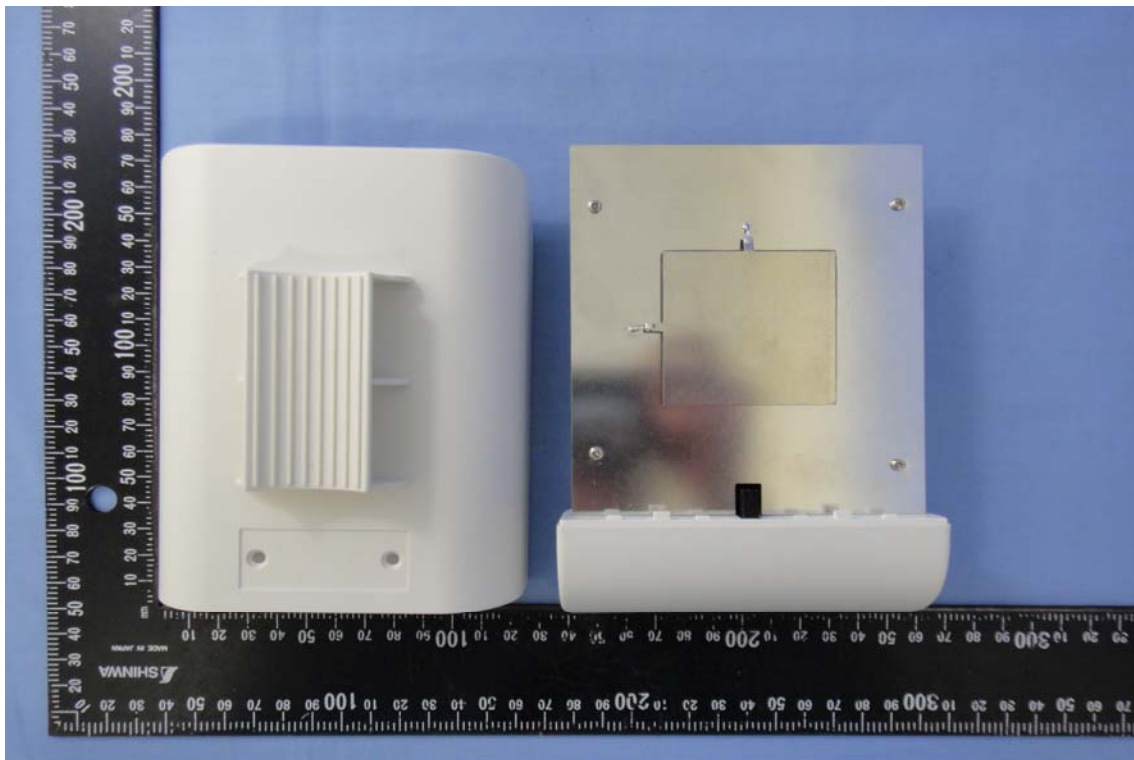



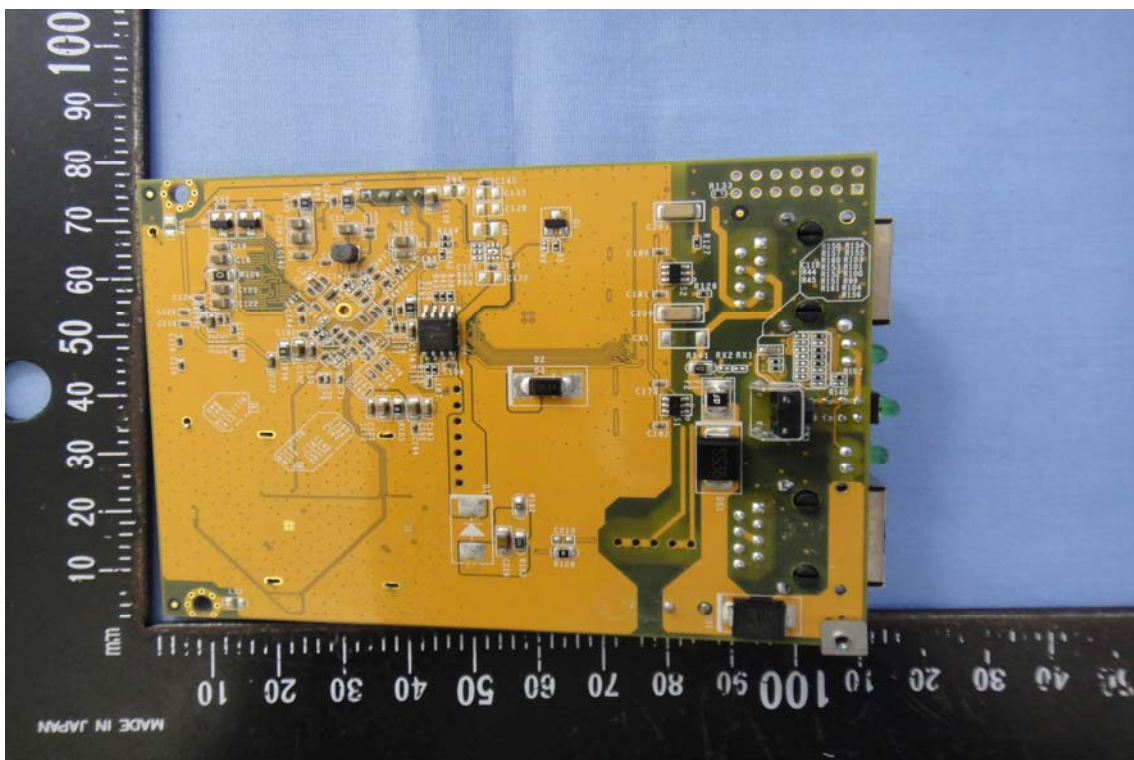
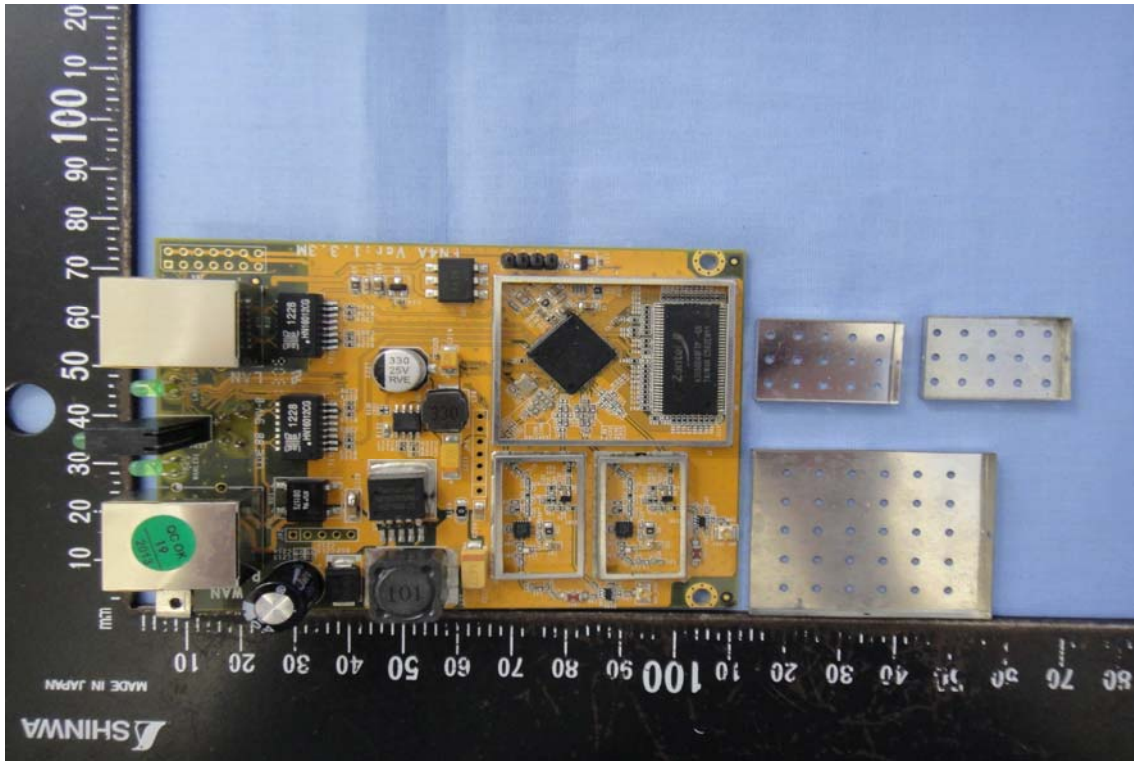

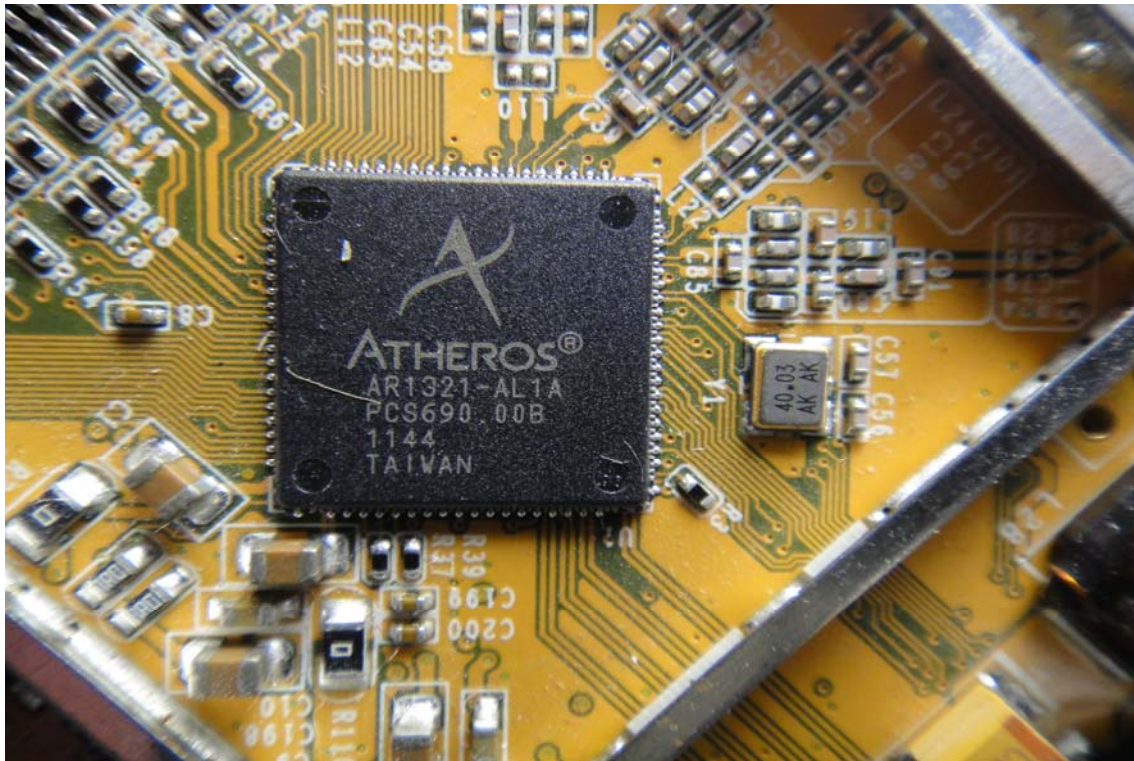





## Antenna

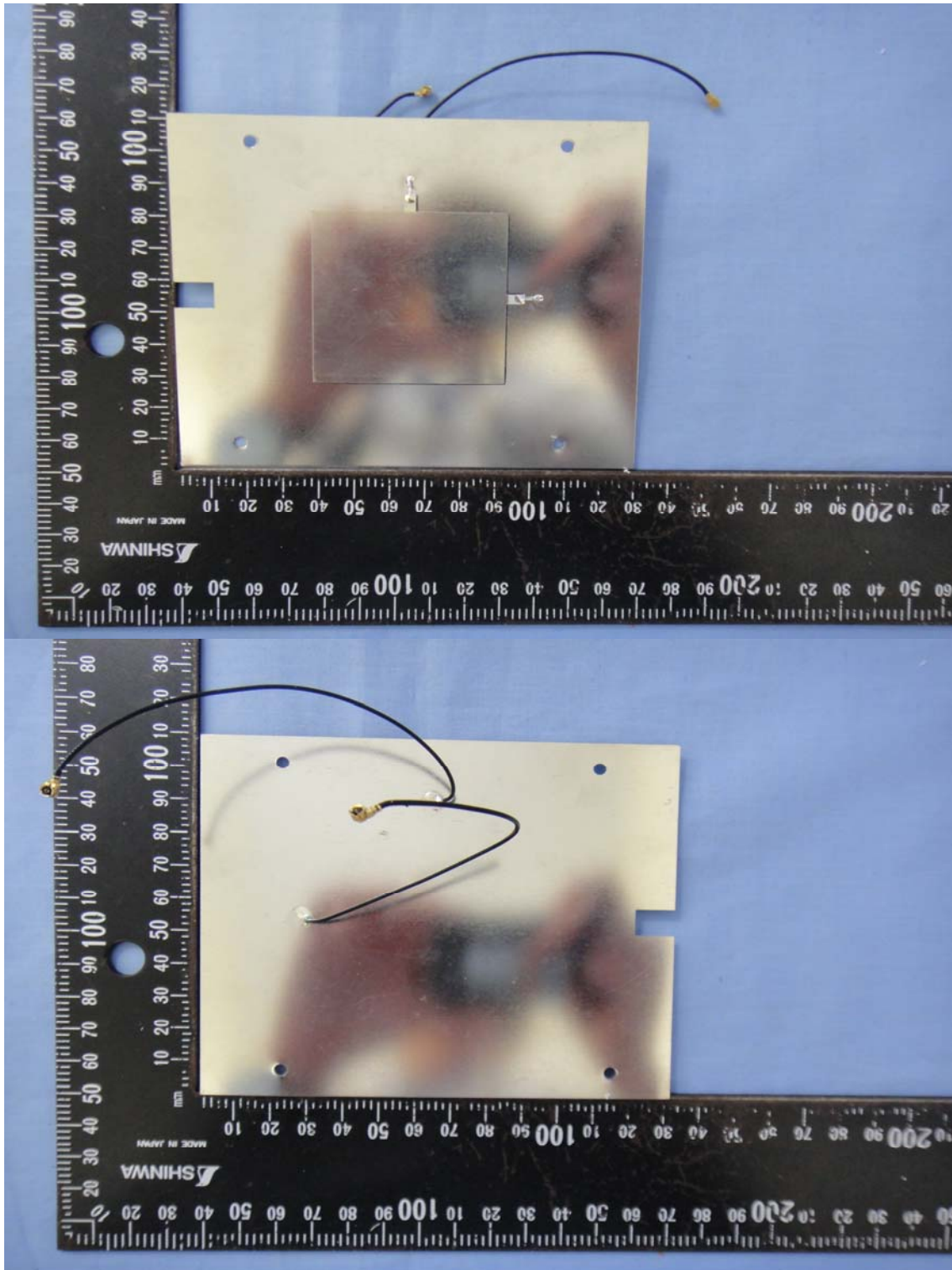



**Model: WCB1105H10DX**

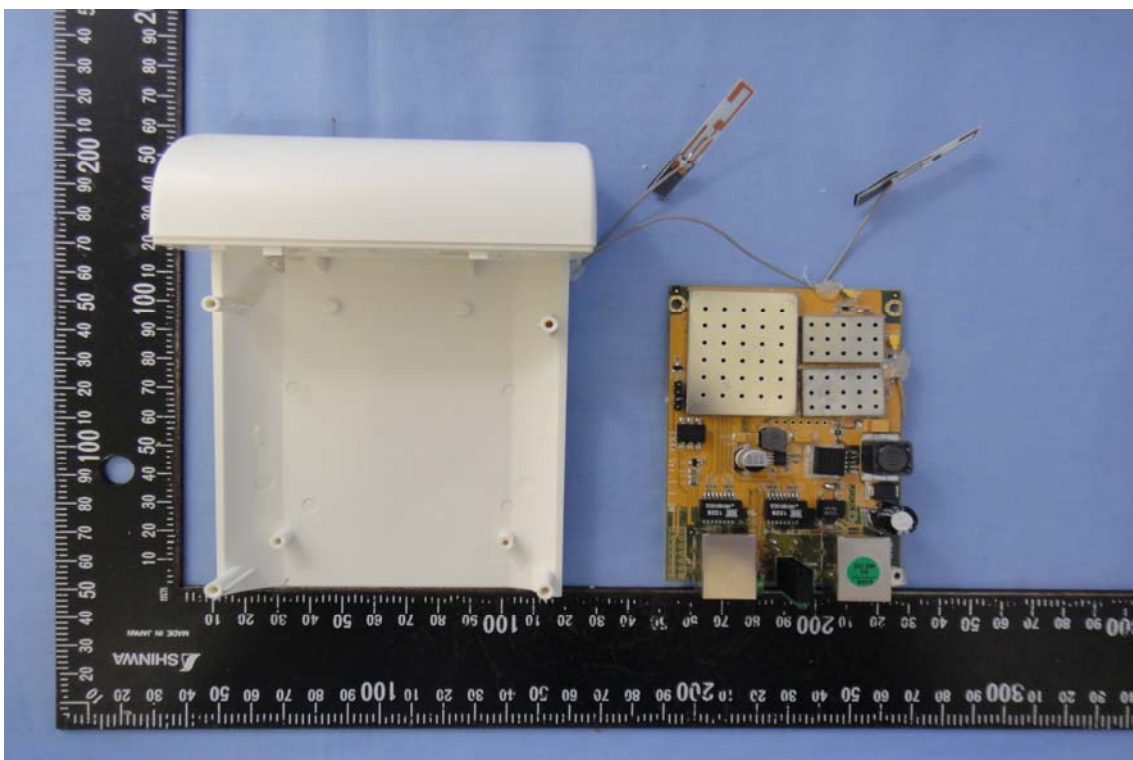
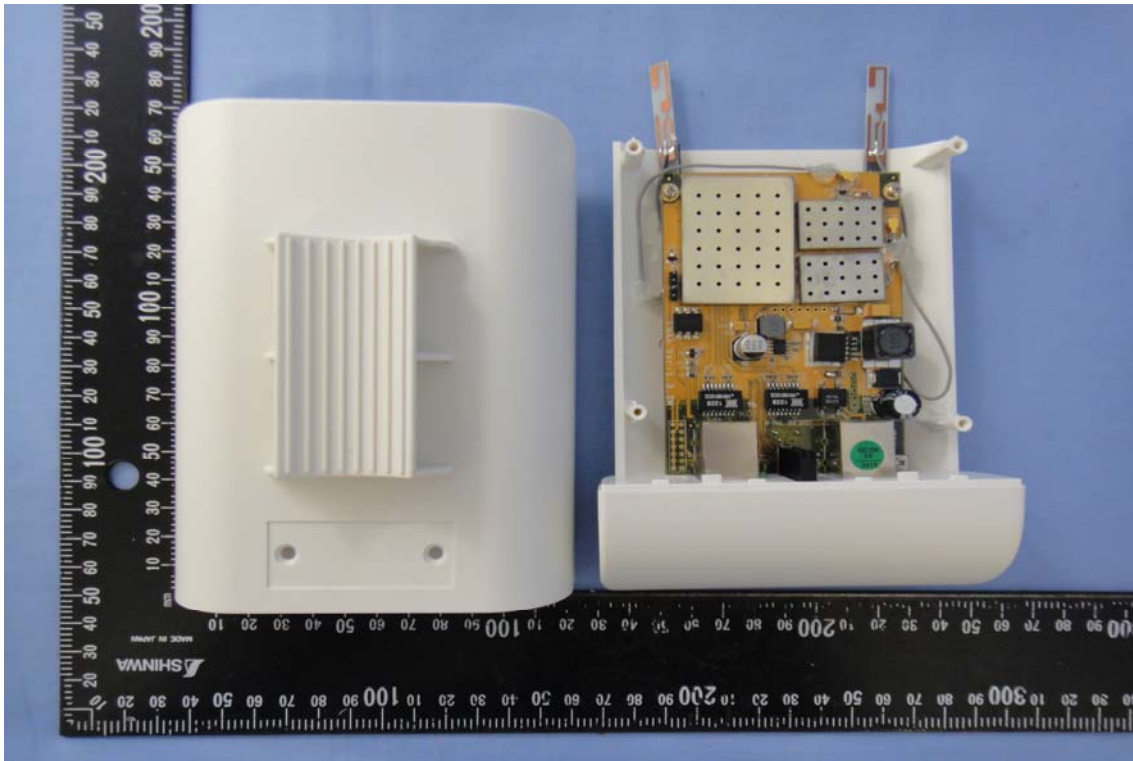



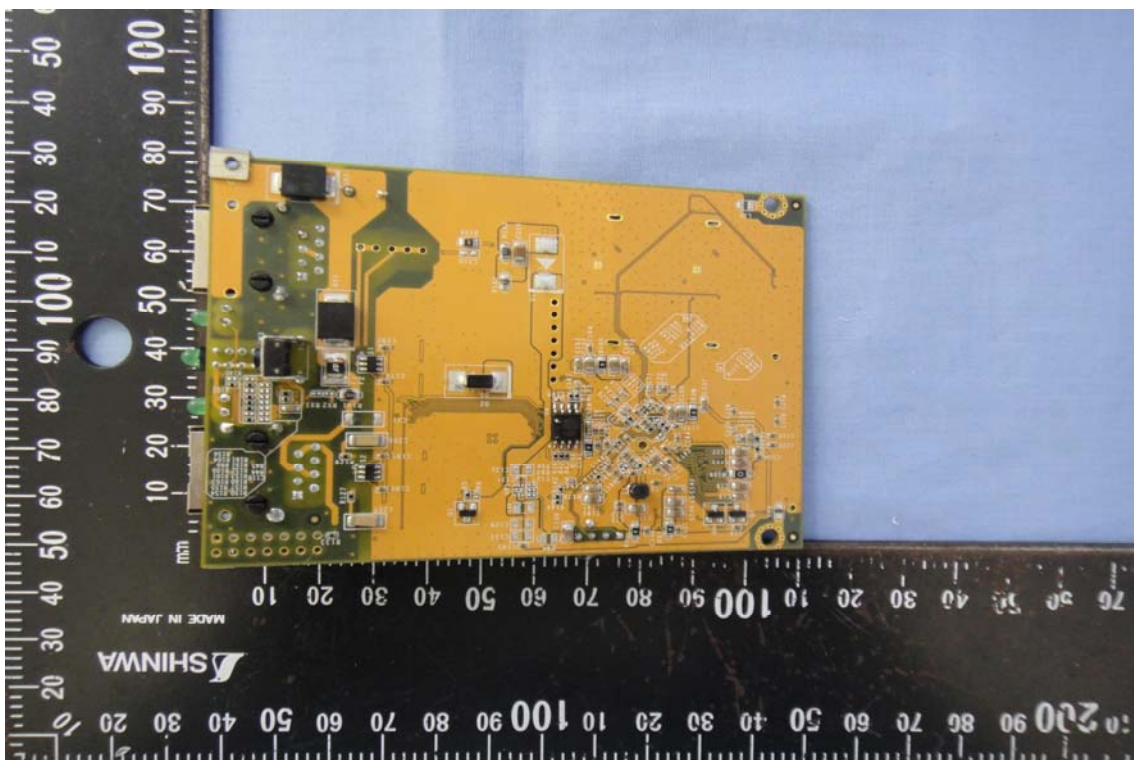
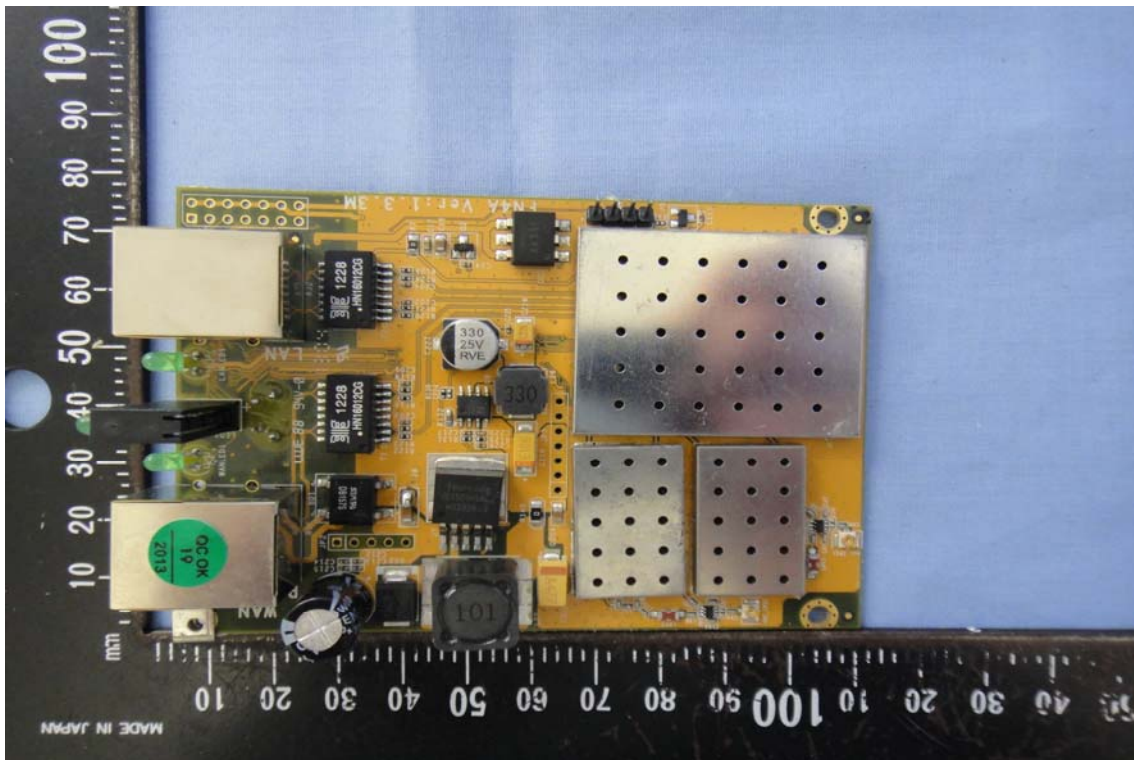

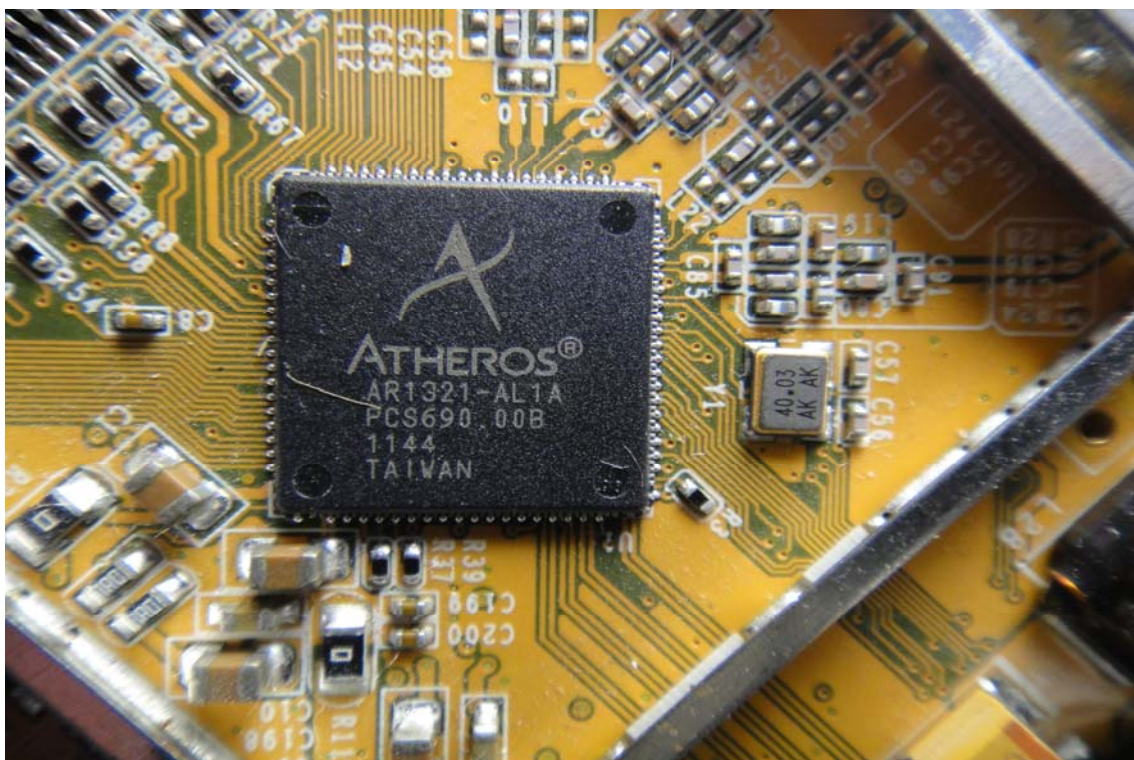
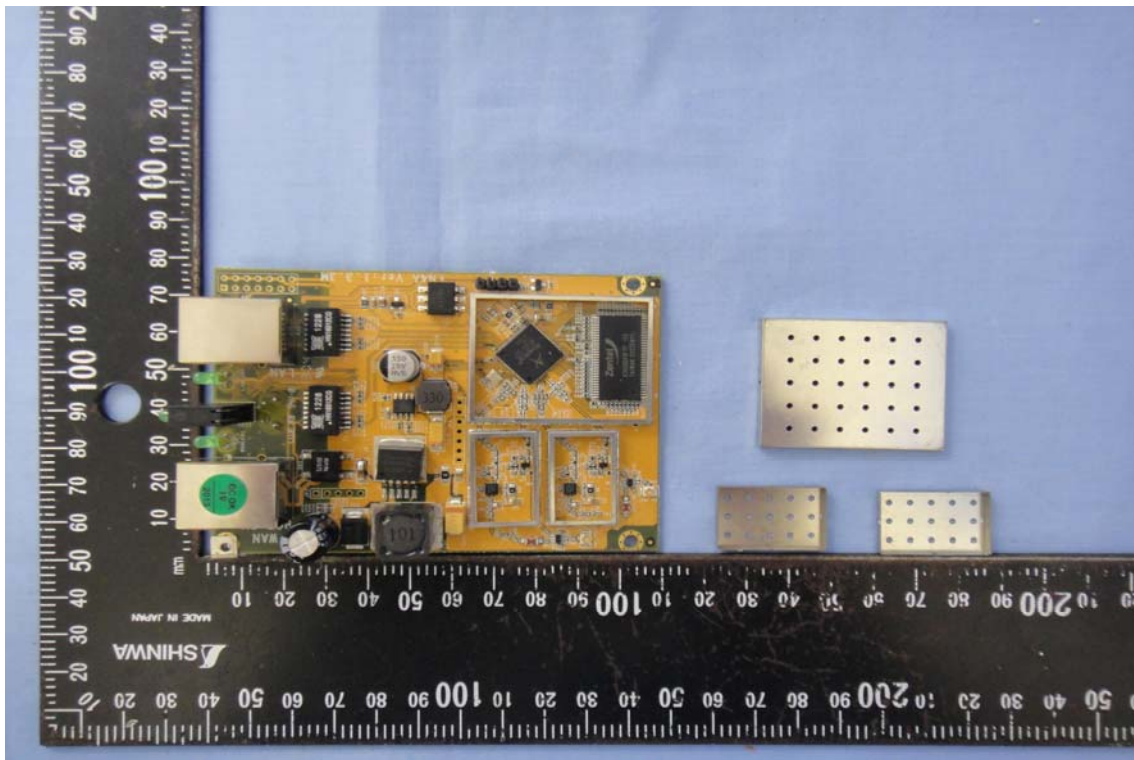





## Antenna

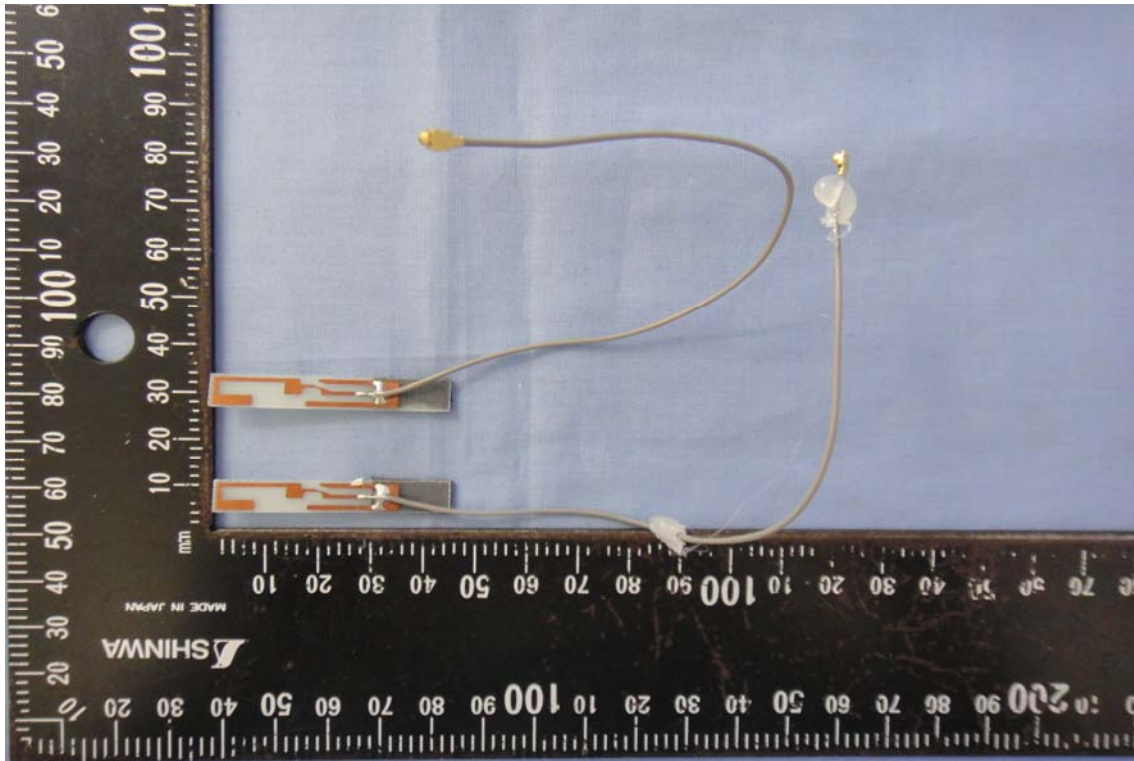



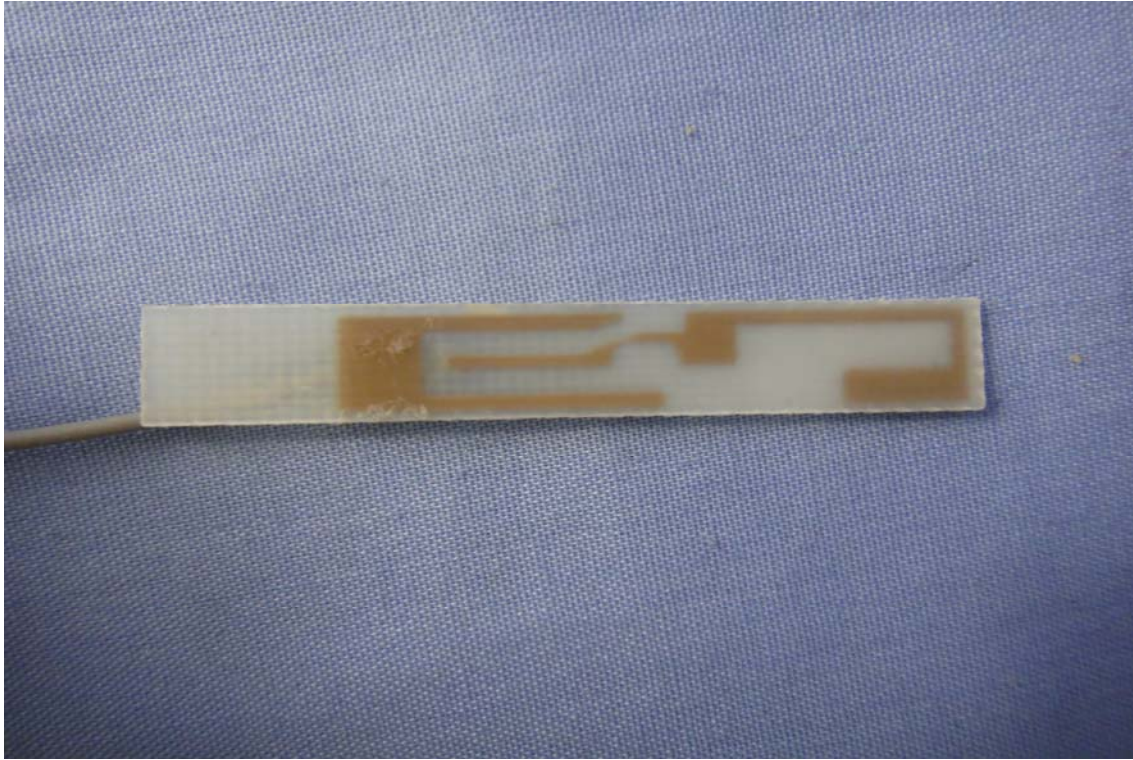





**Model: WCB1100H10DX**

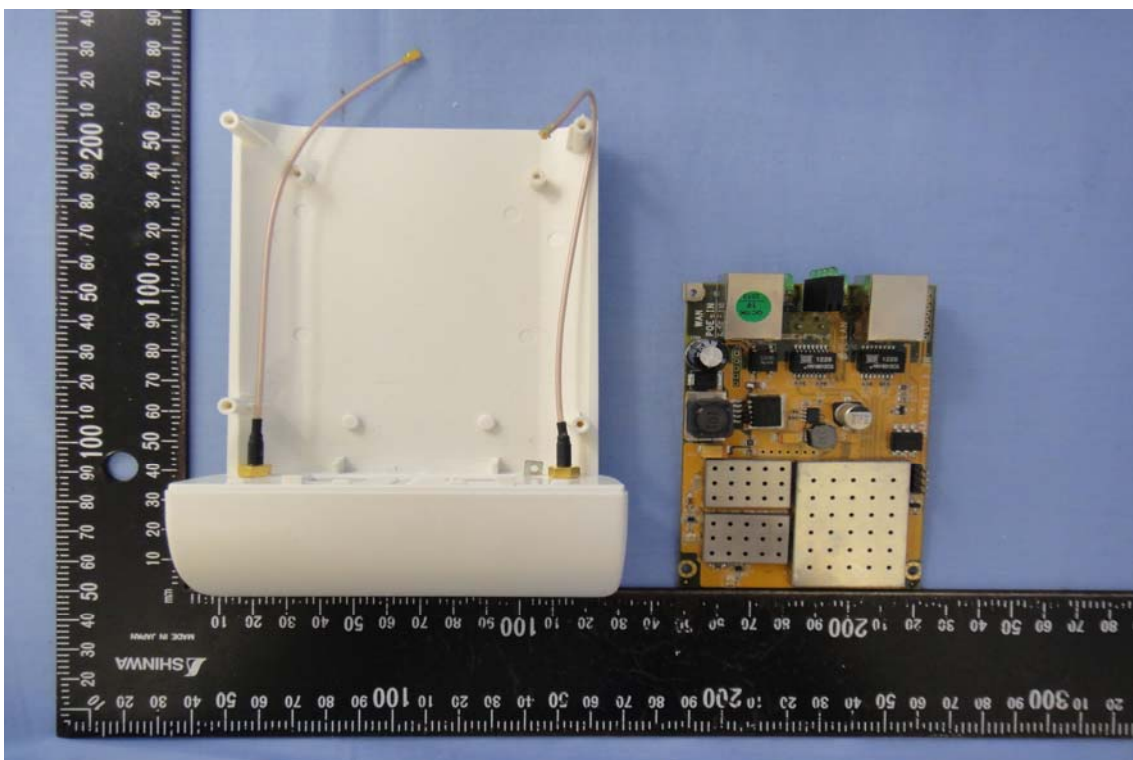

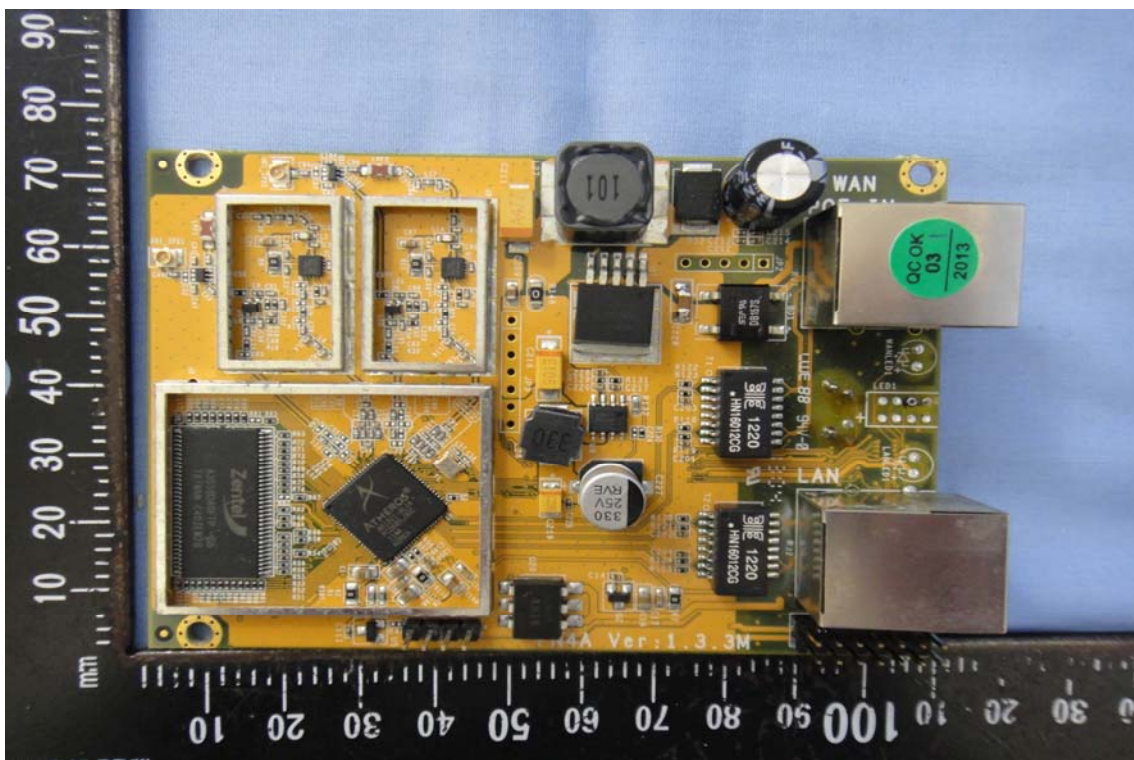
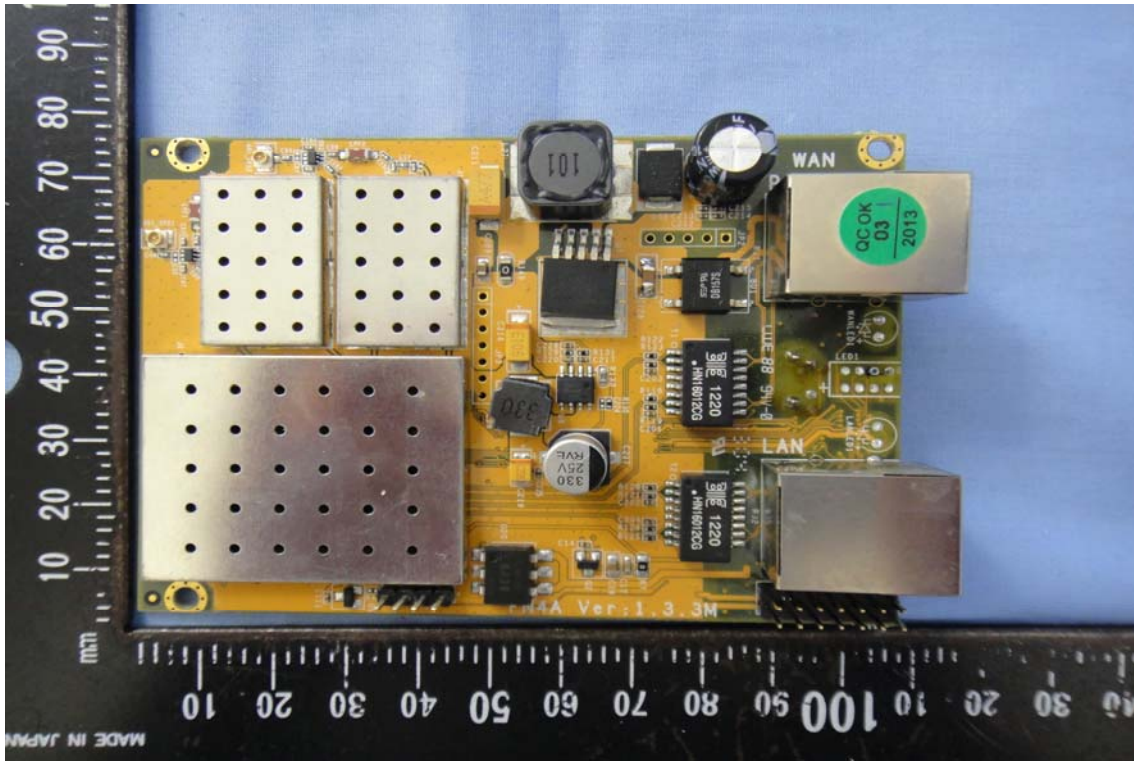



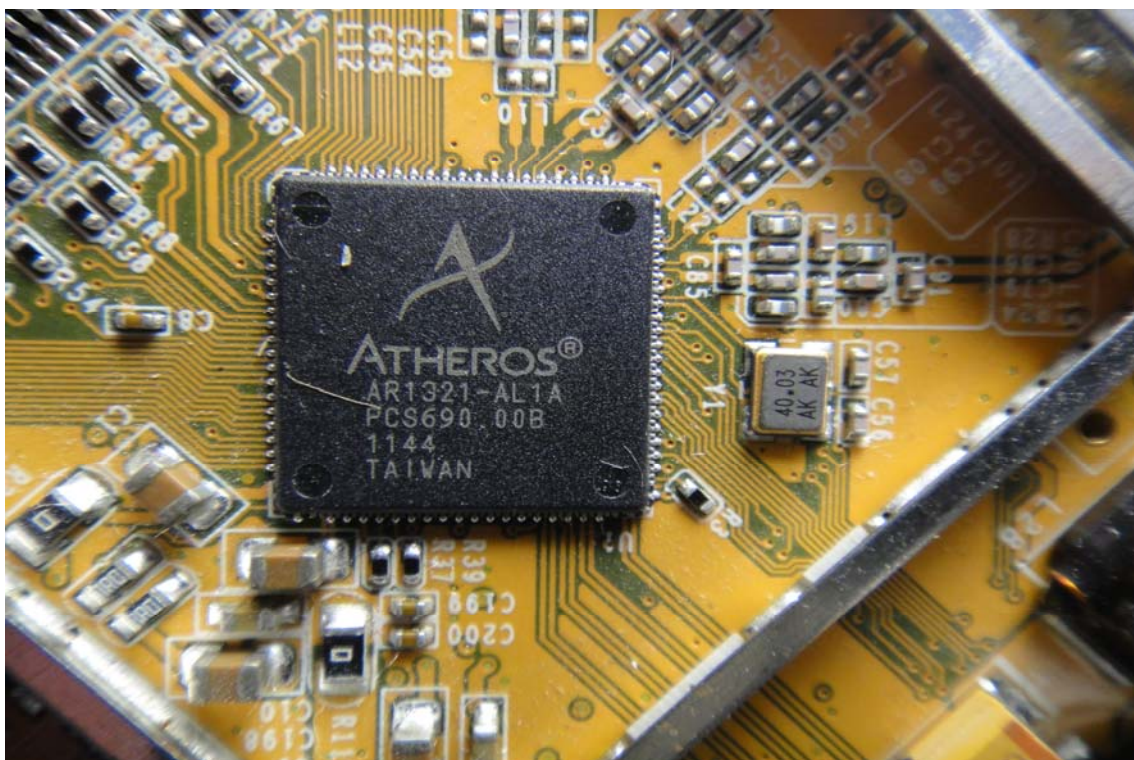
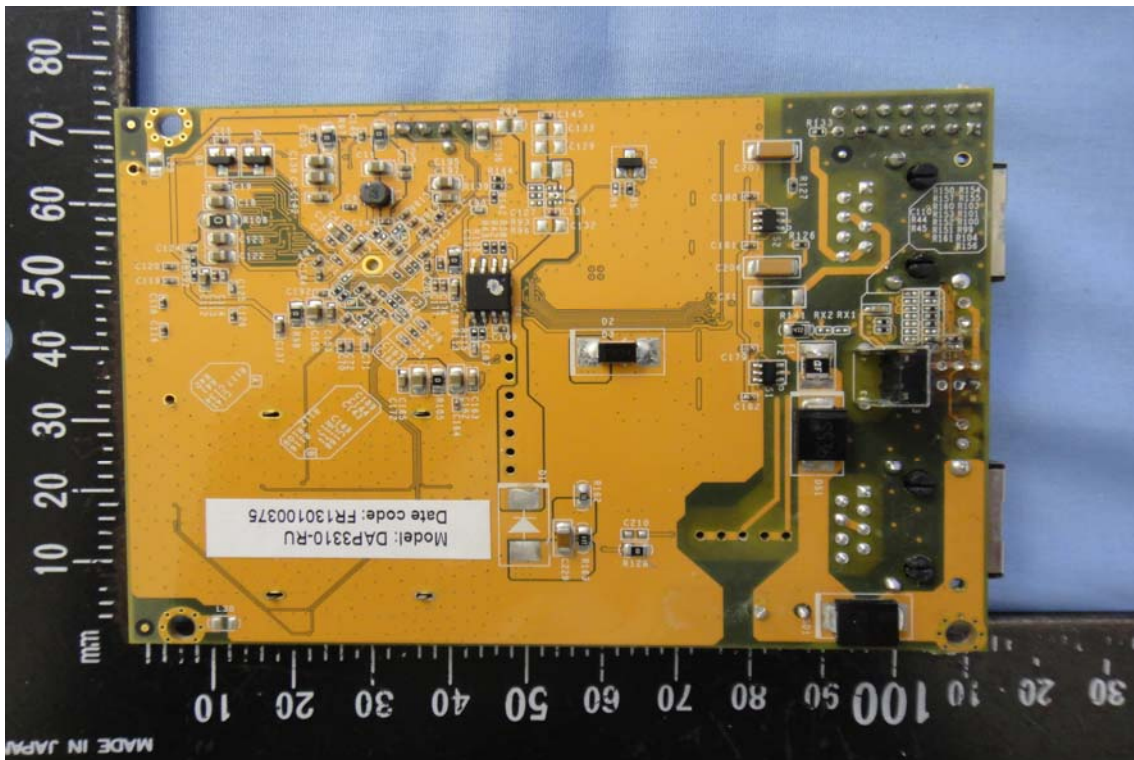



## Antenna







**Model: AC-GTT-11N-D**

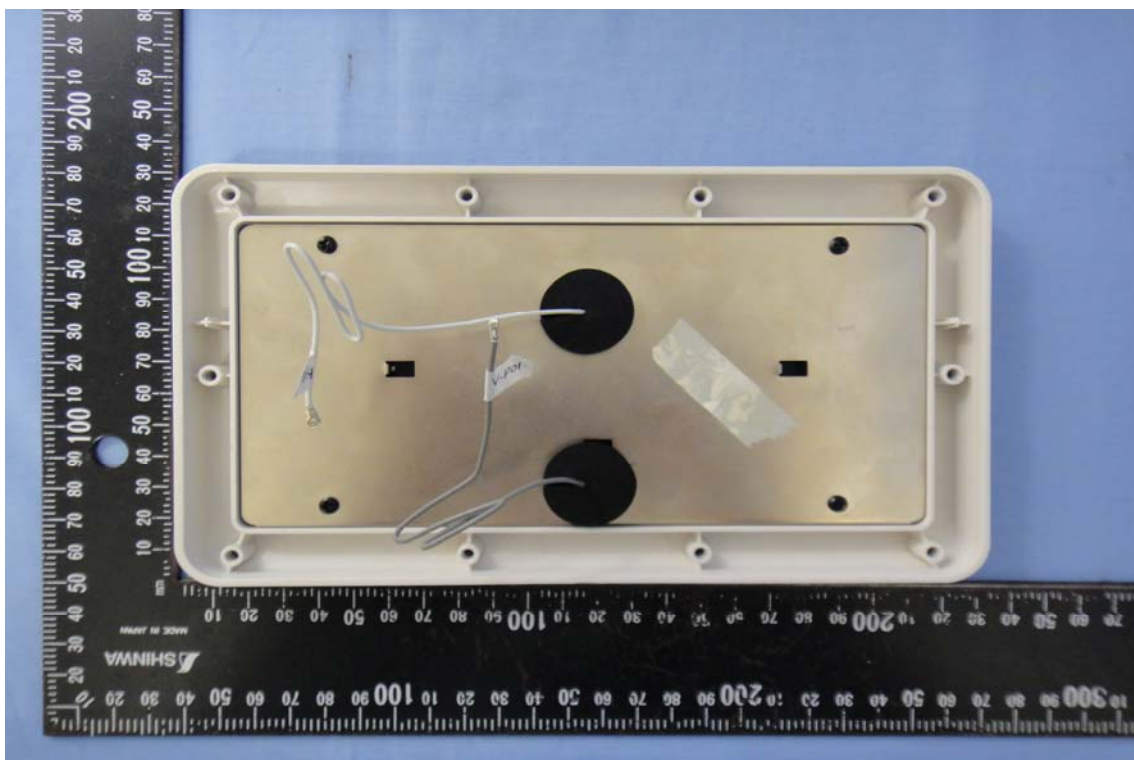
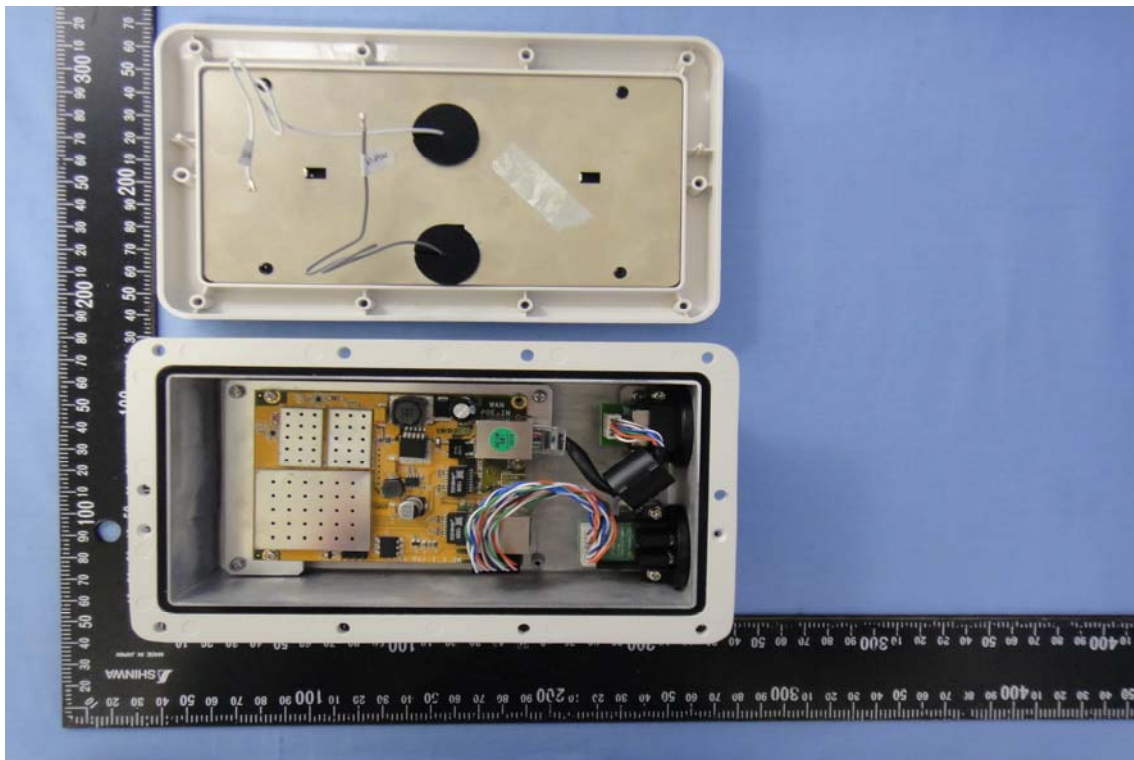

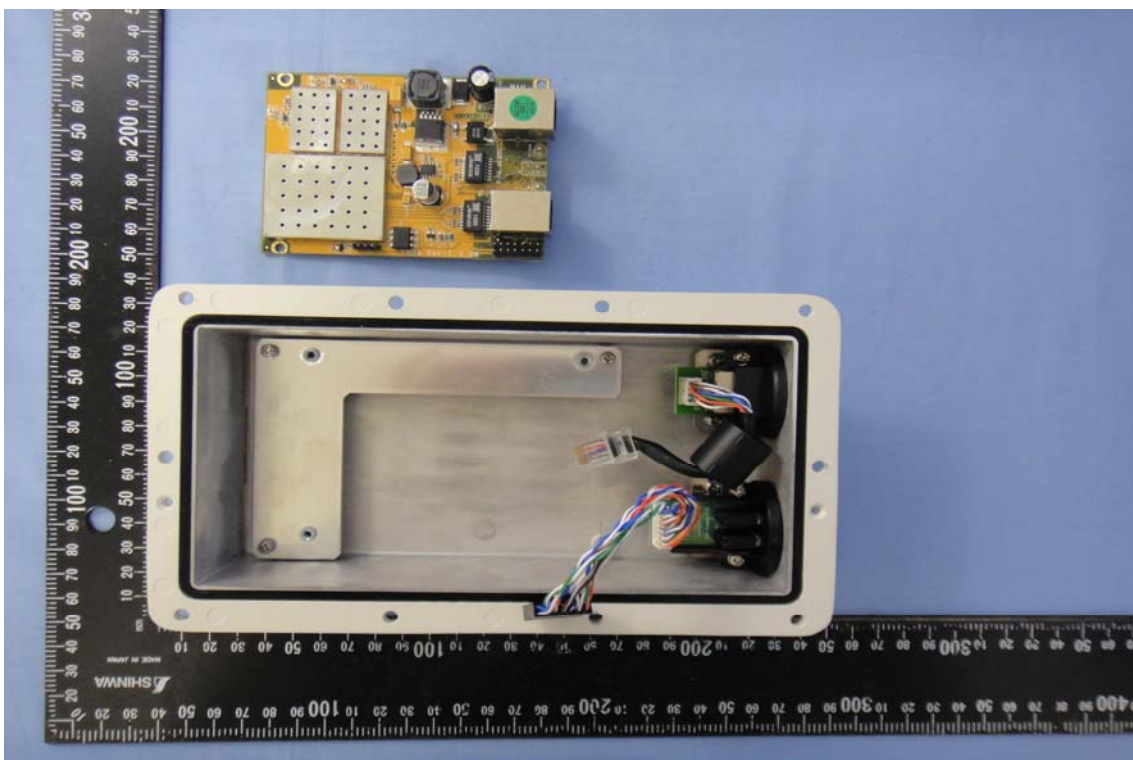
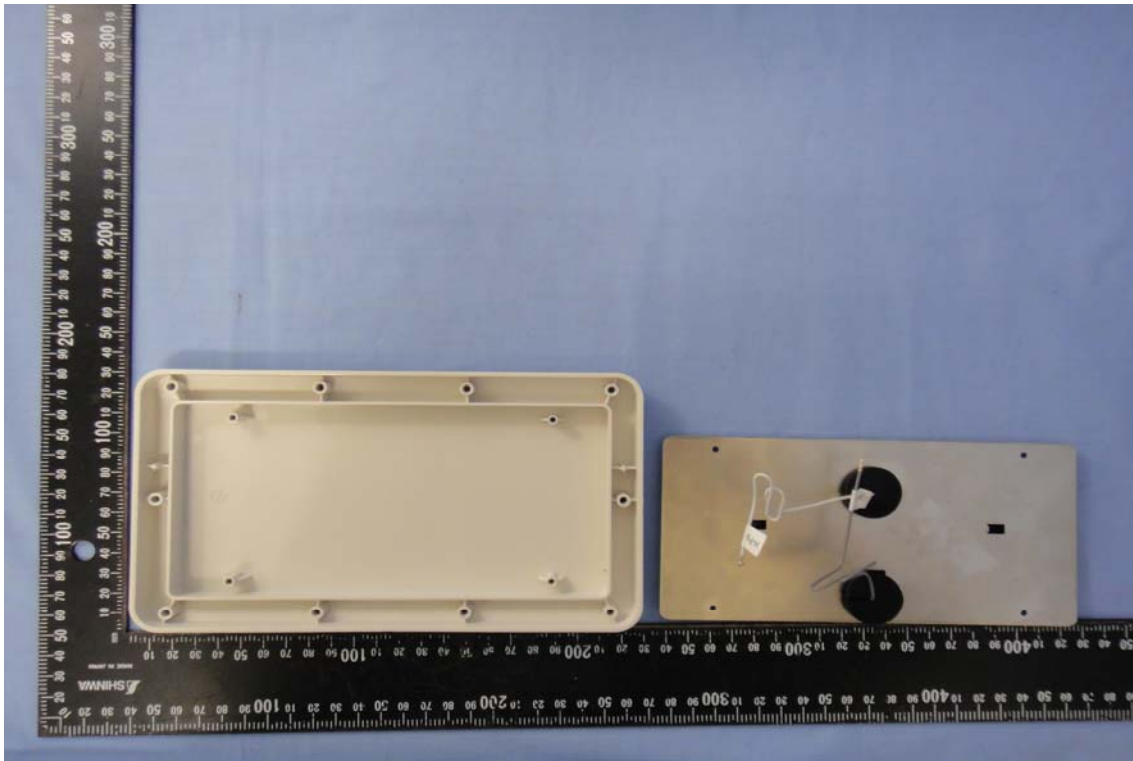



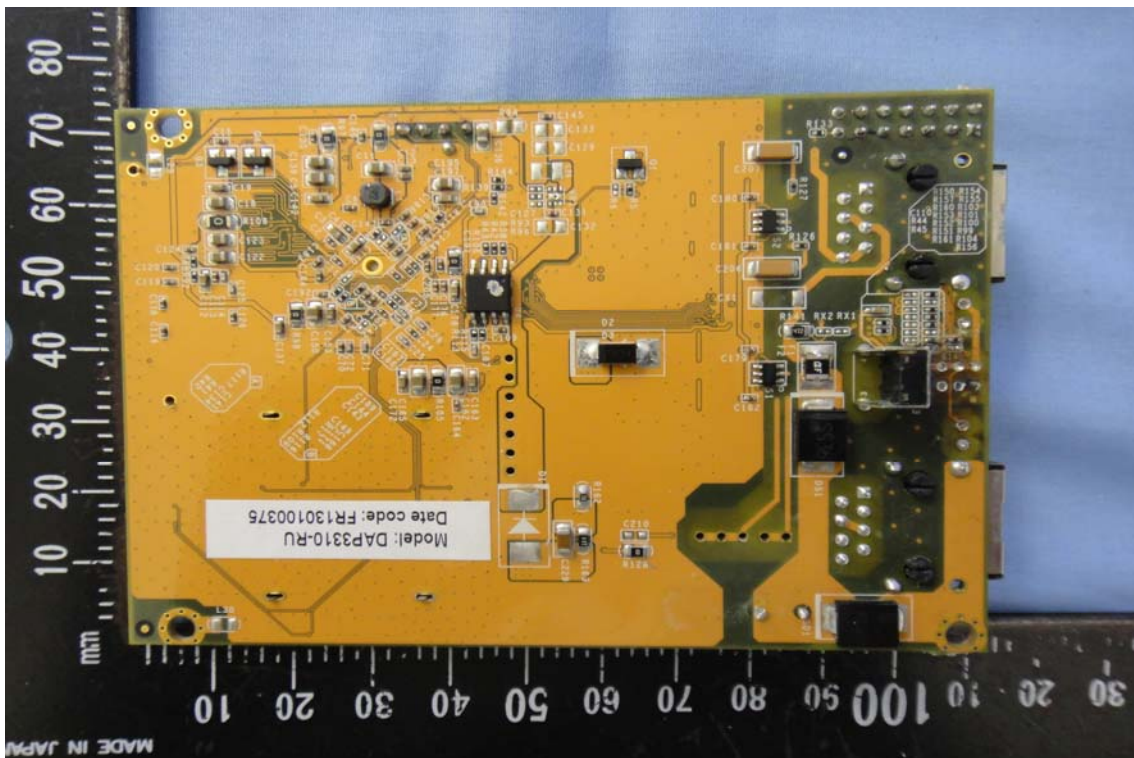
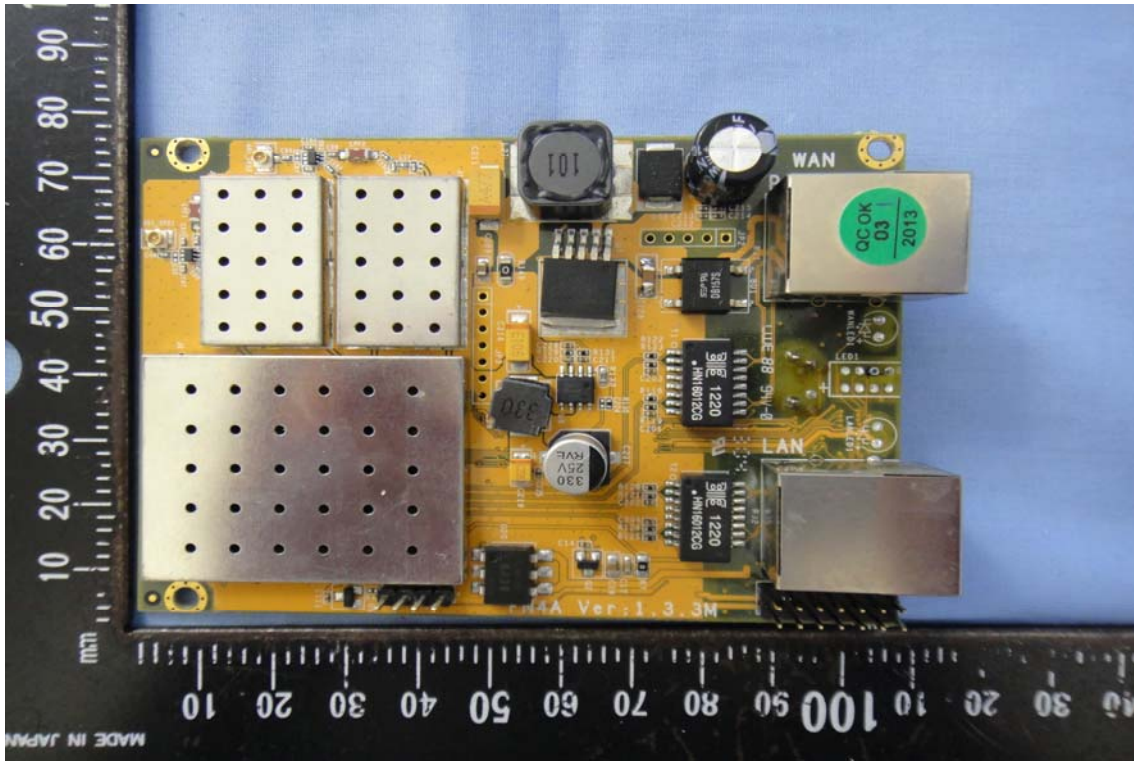

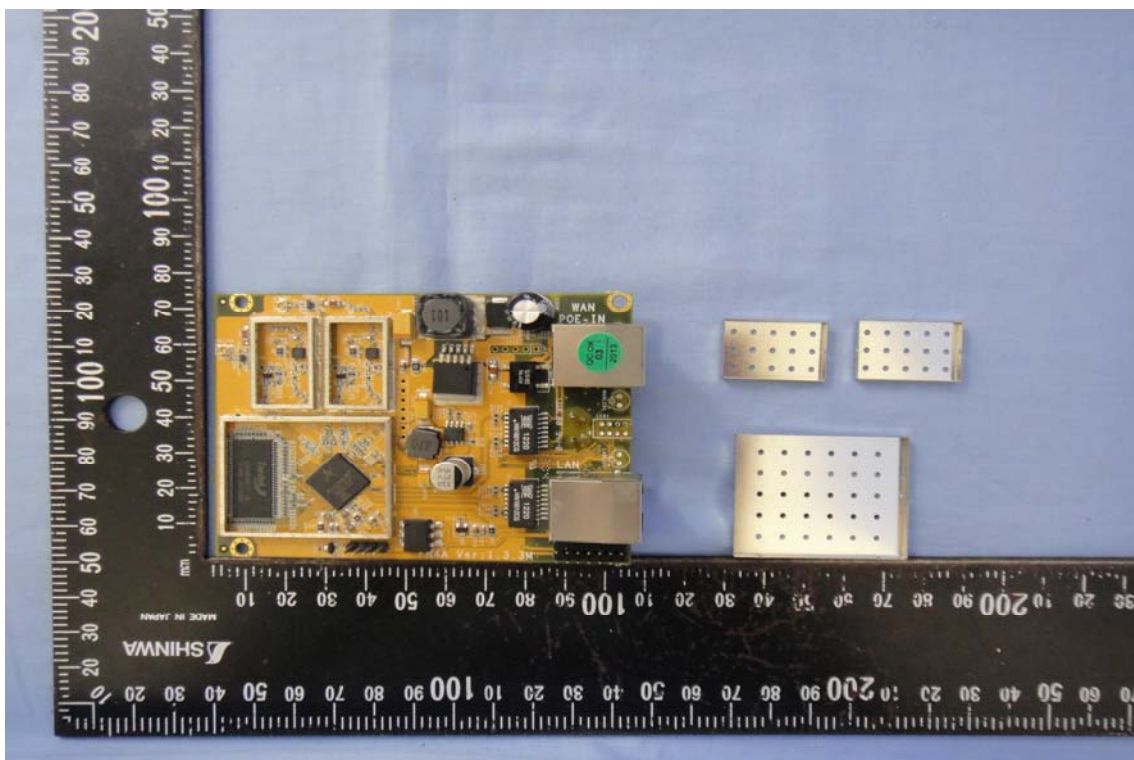
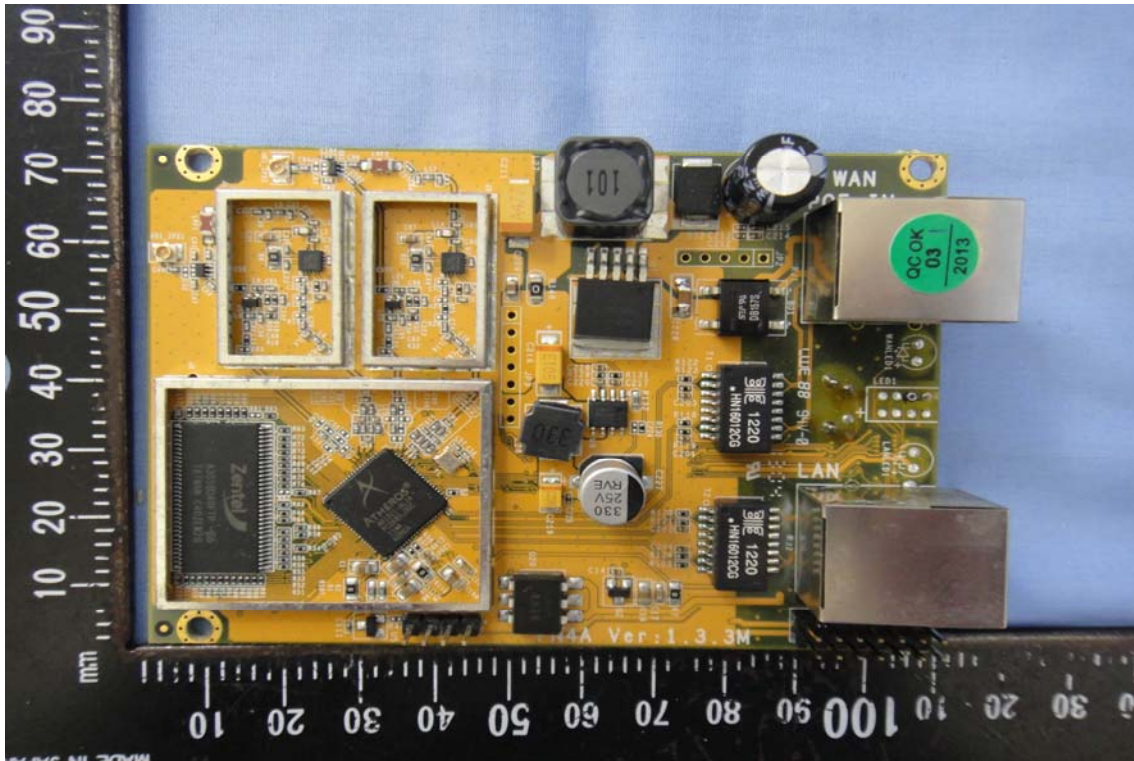



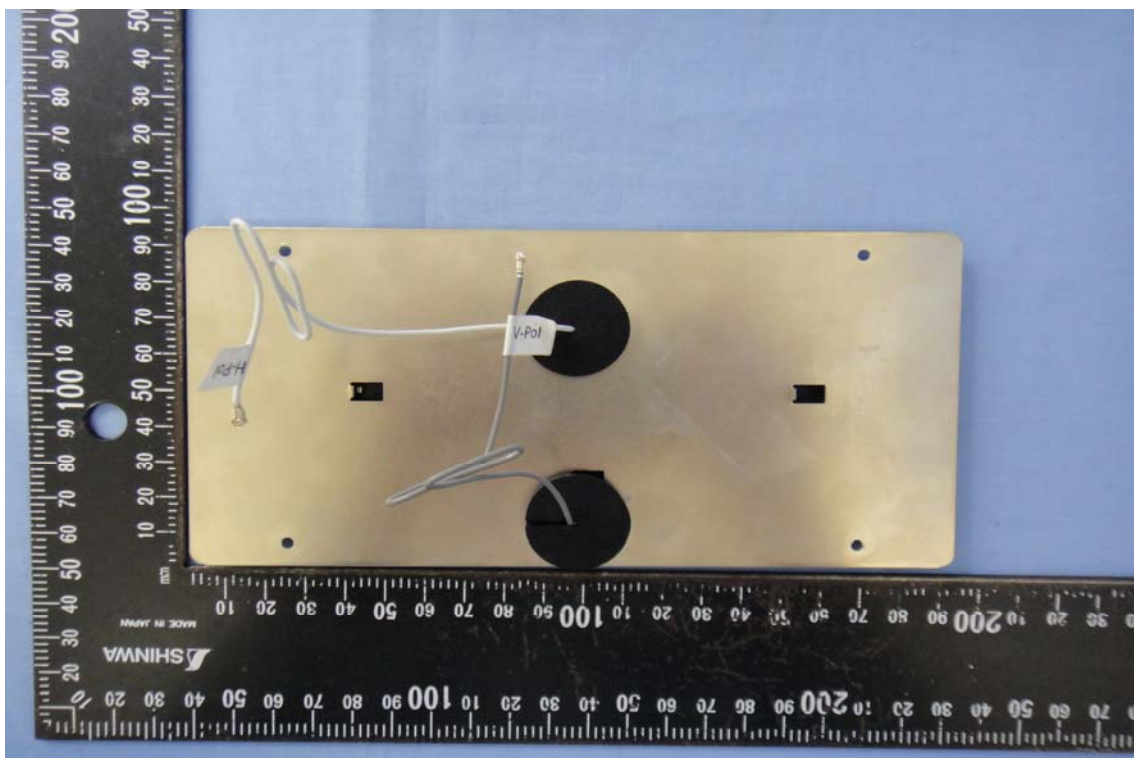
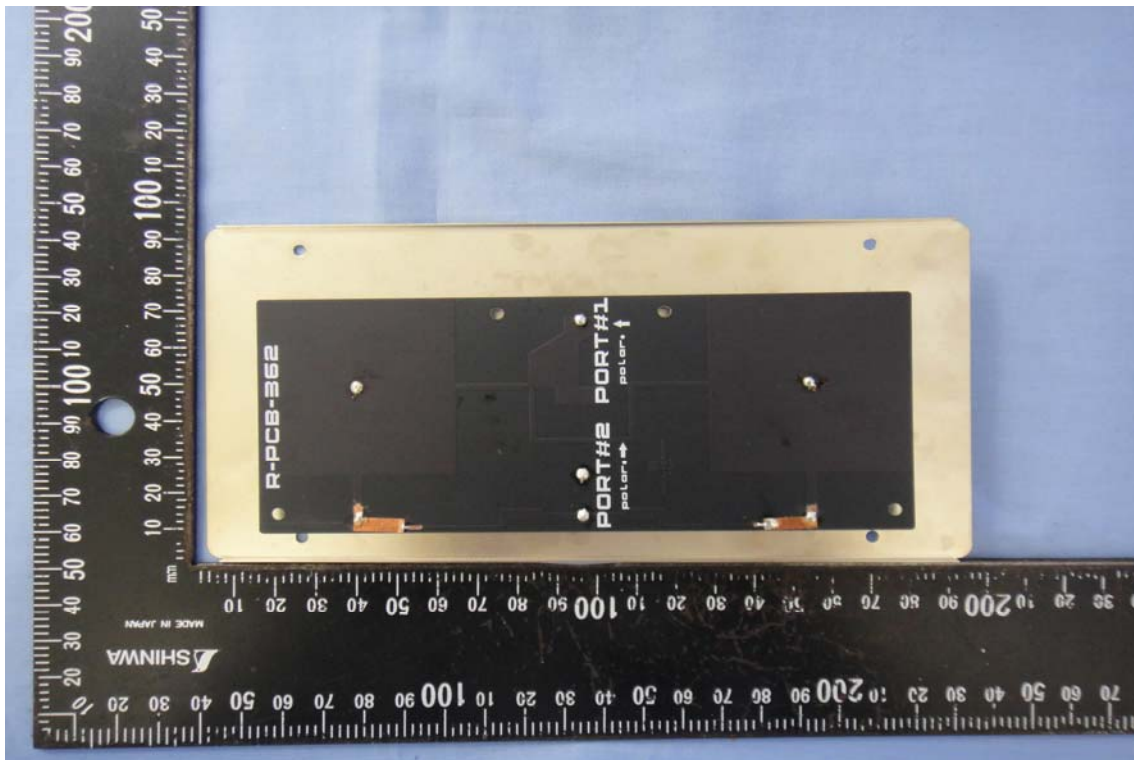



**Model: AC-GTT-11N-O**

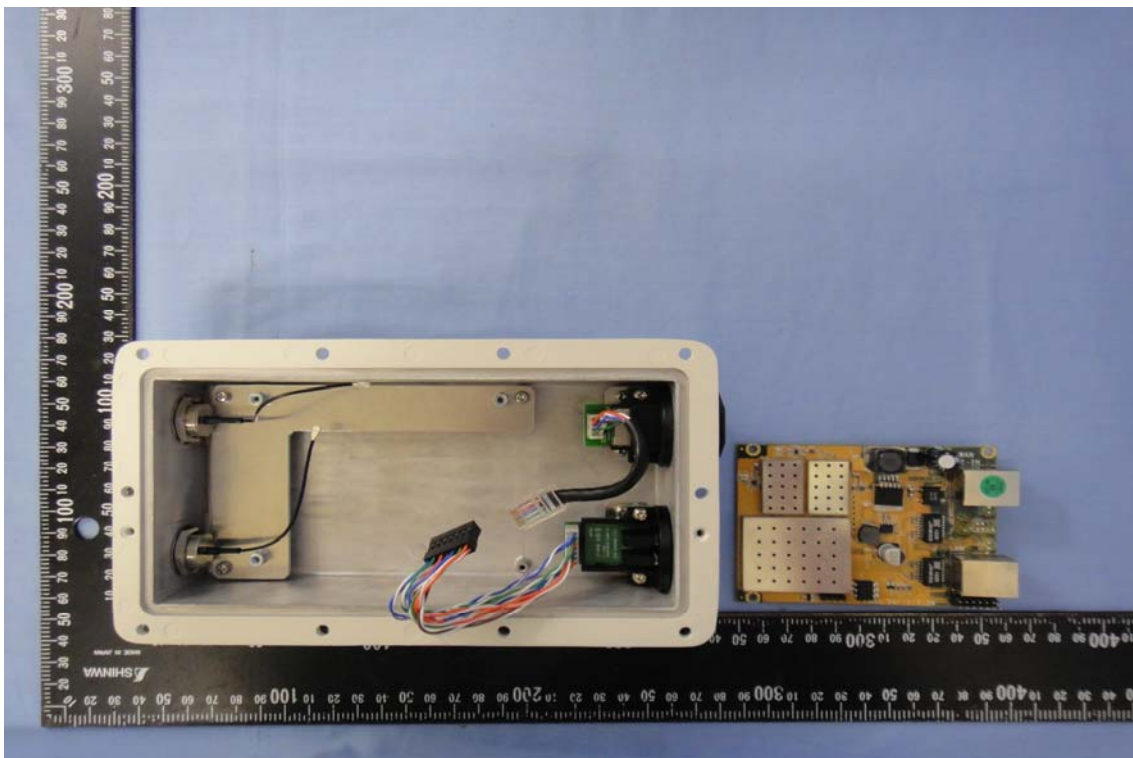



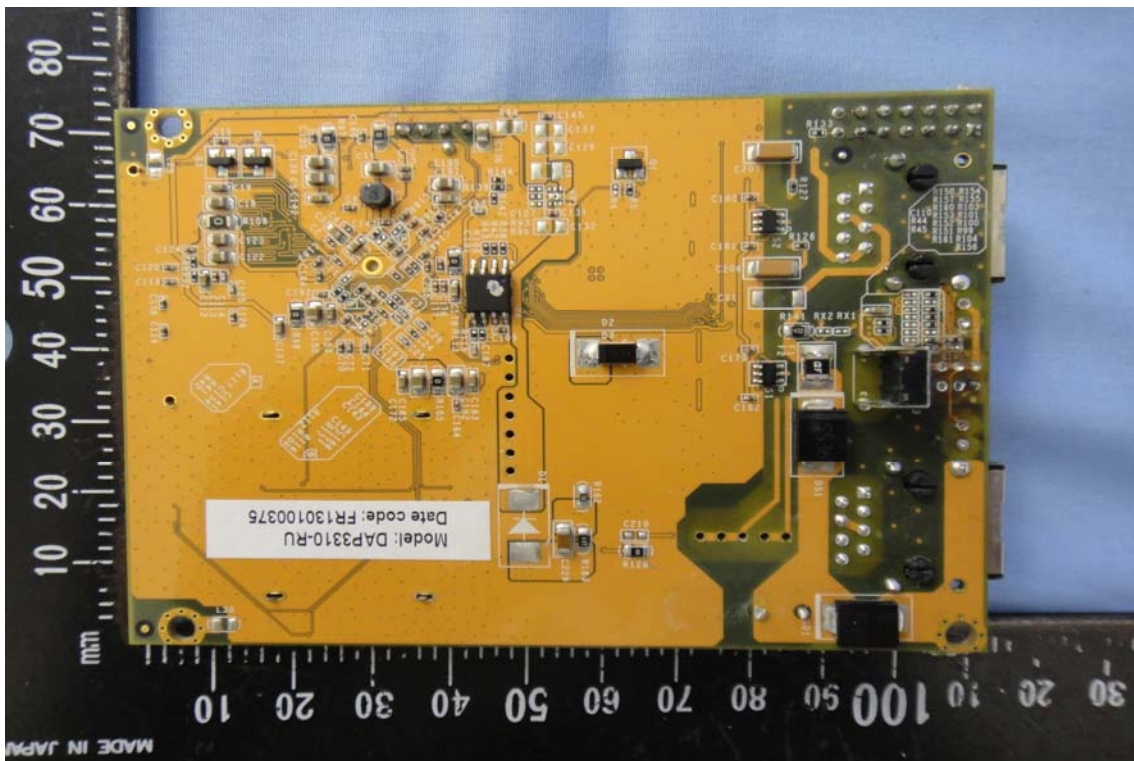
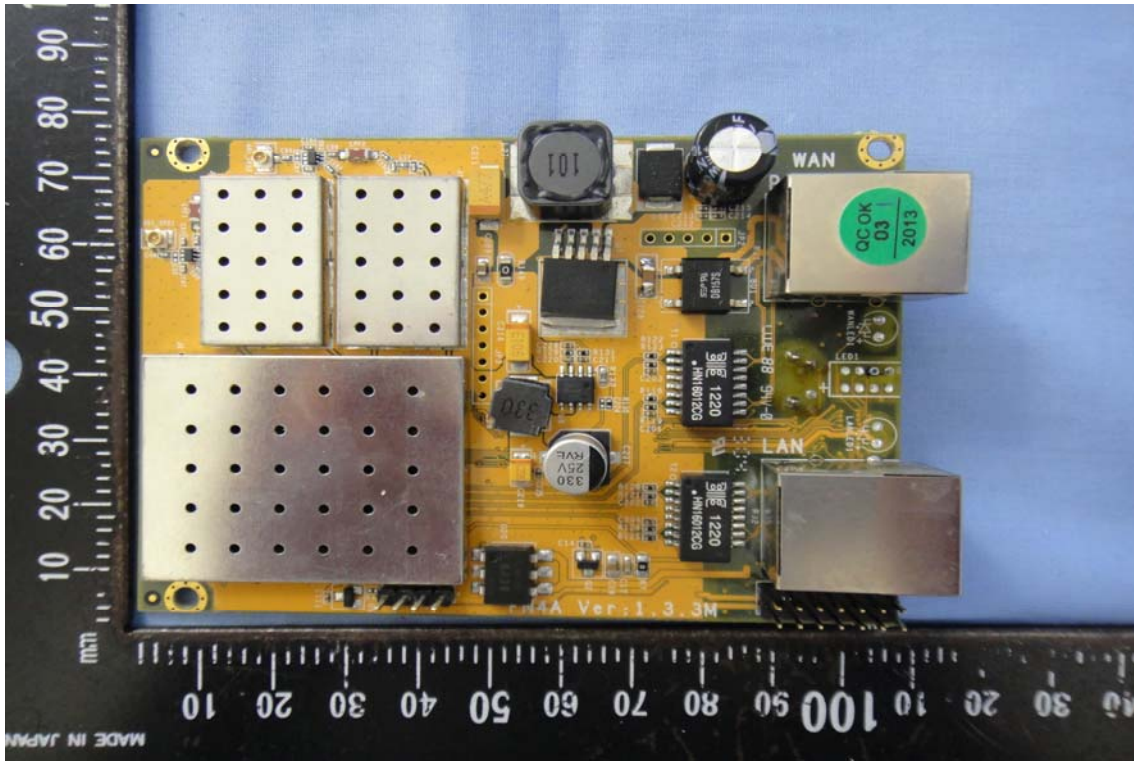

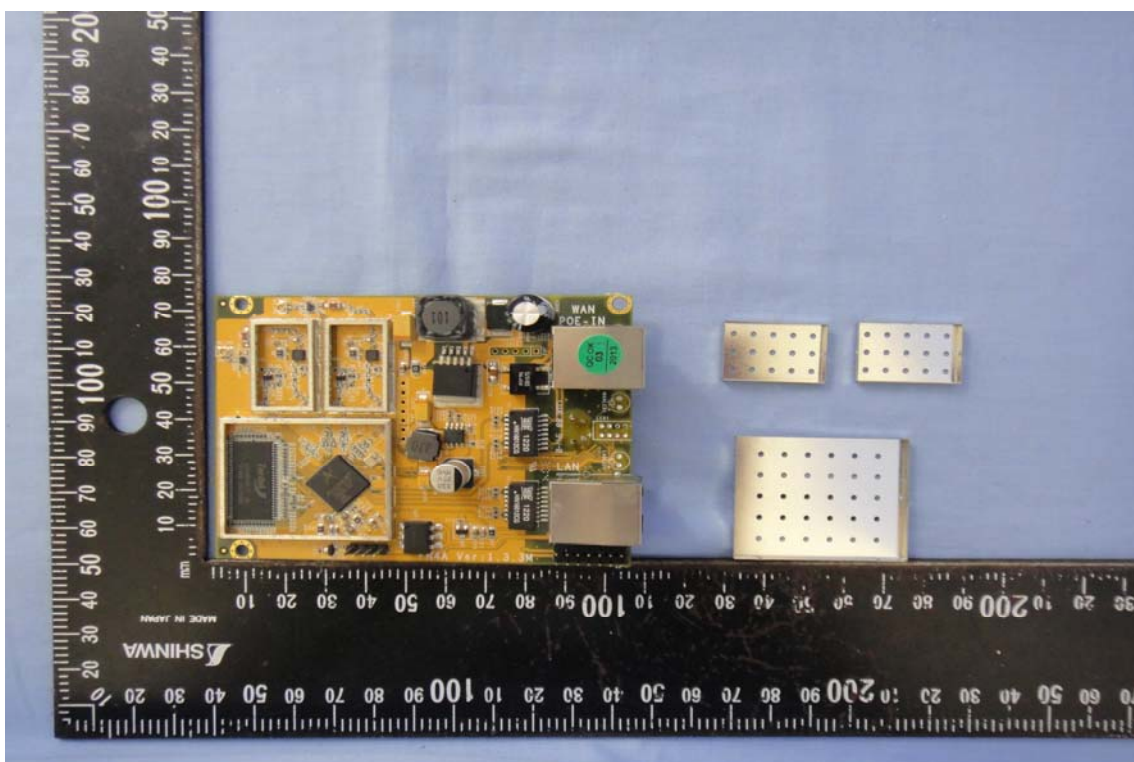
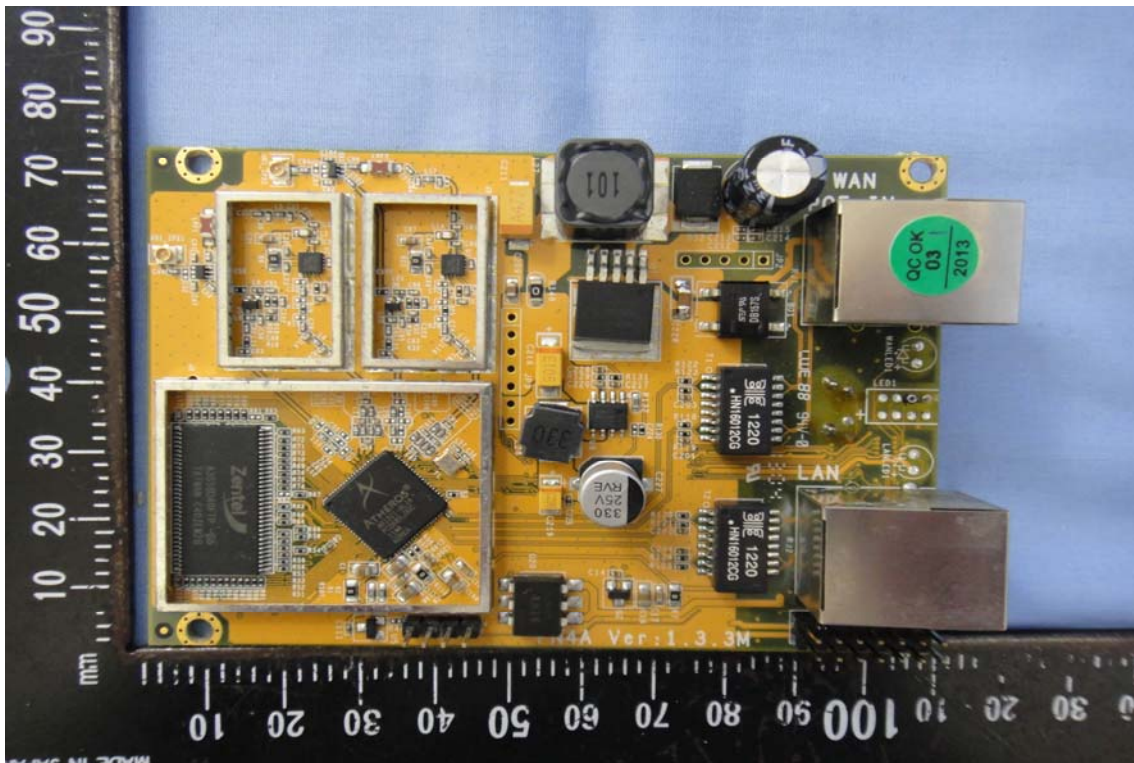



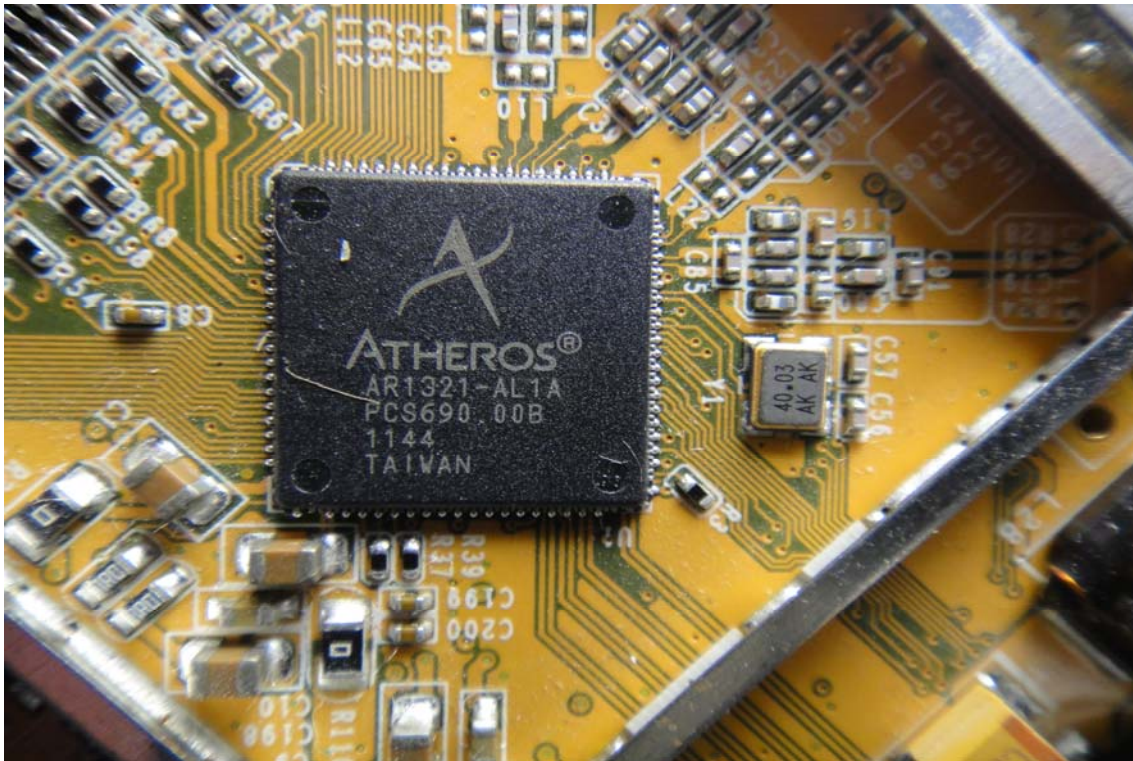







**Model: WLO-12410N**

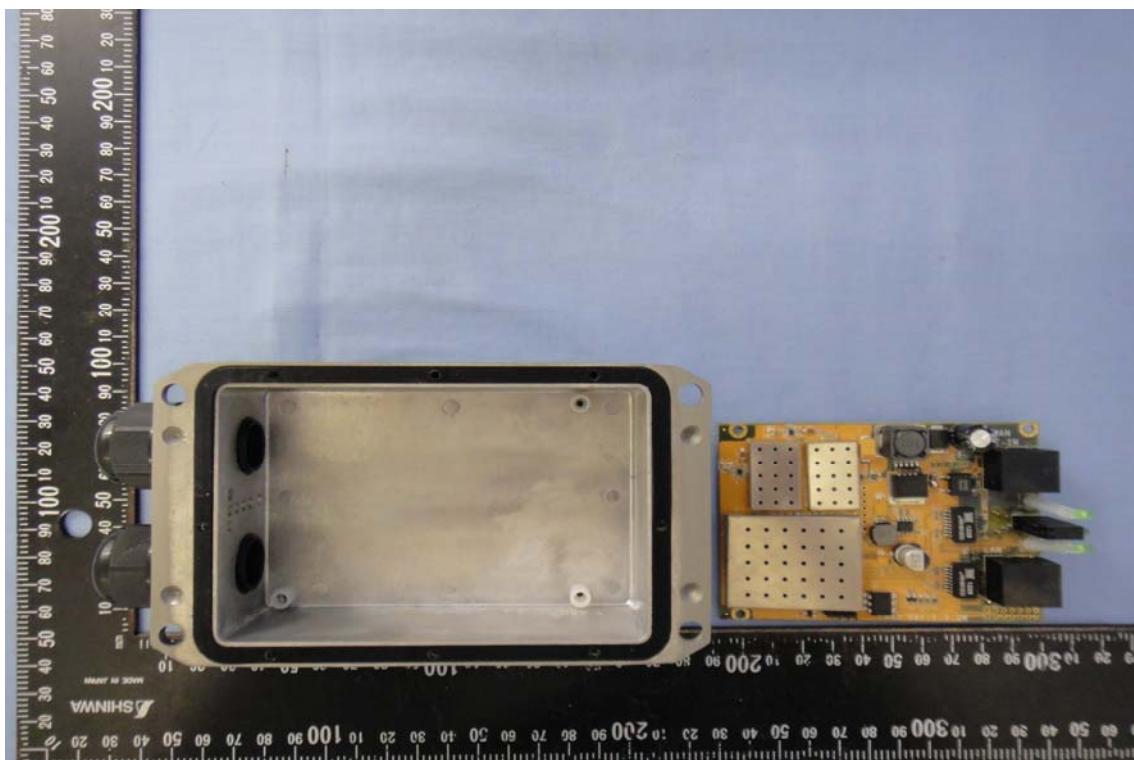
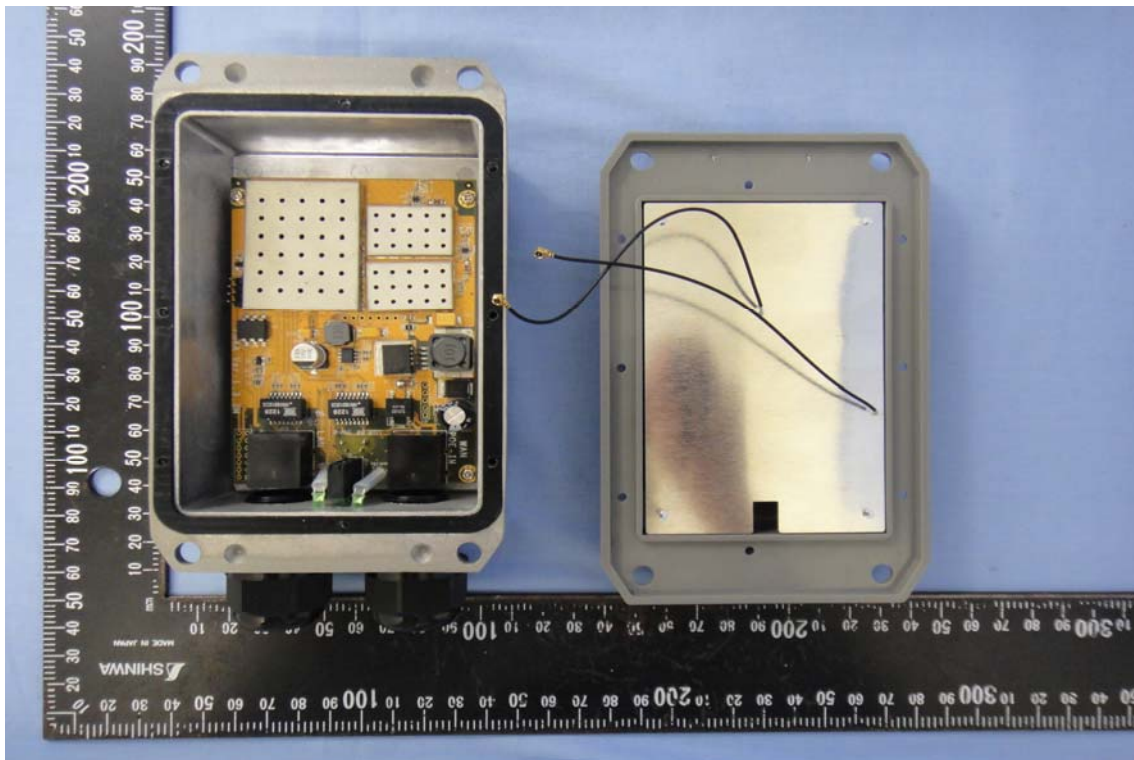

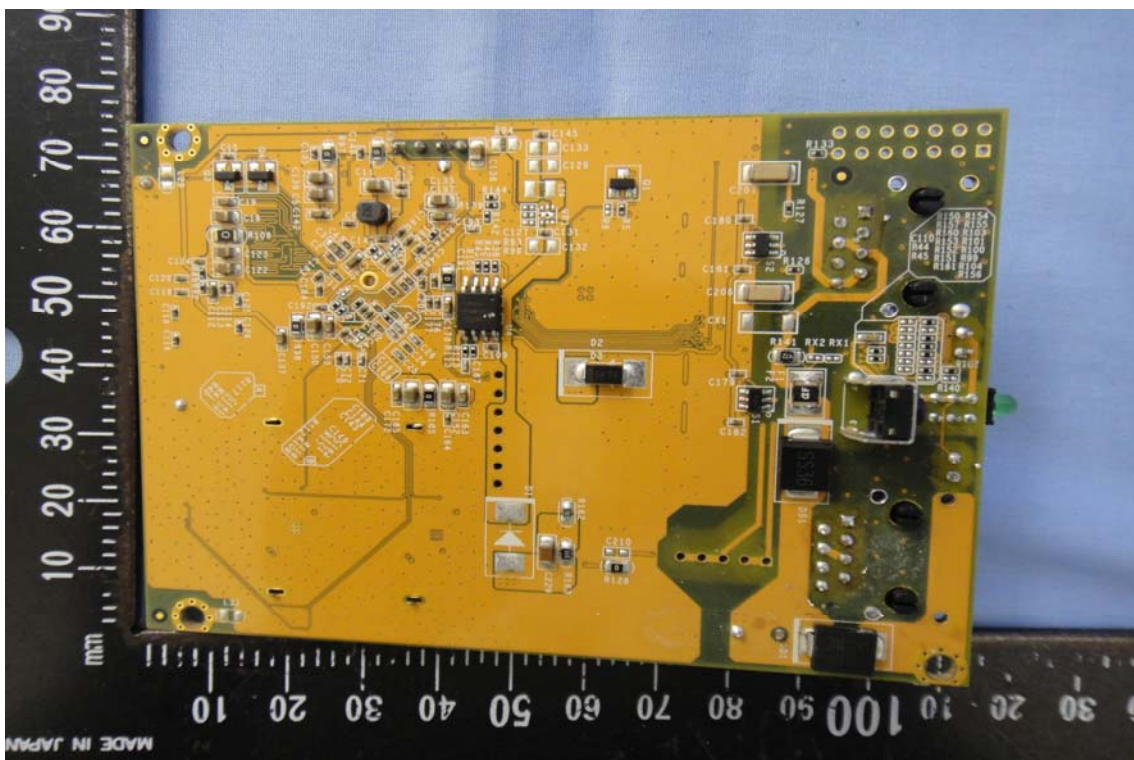
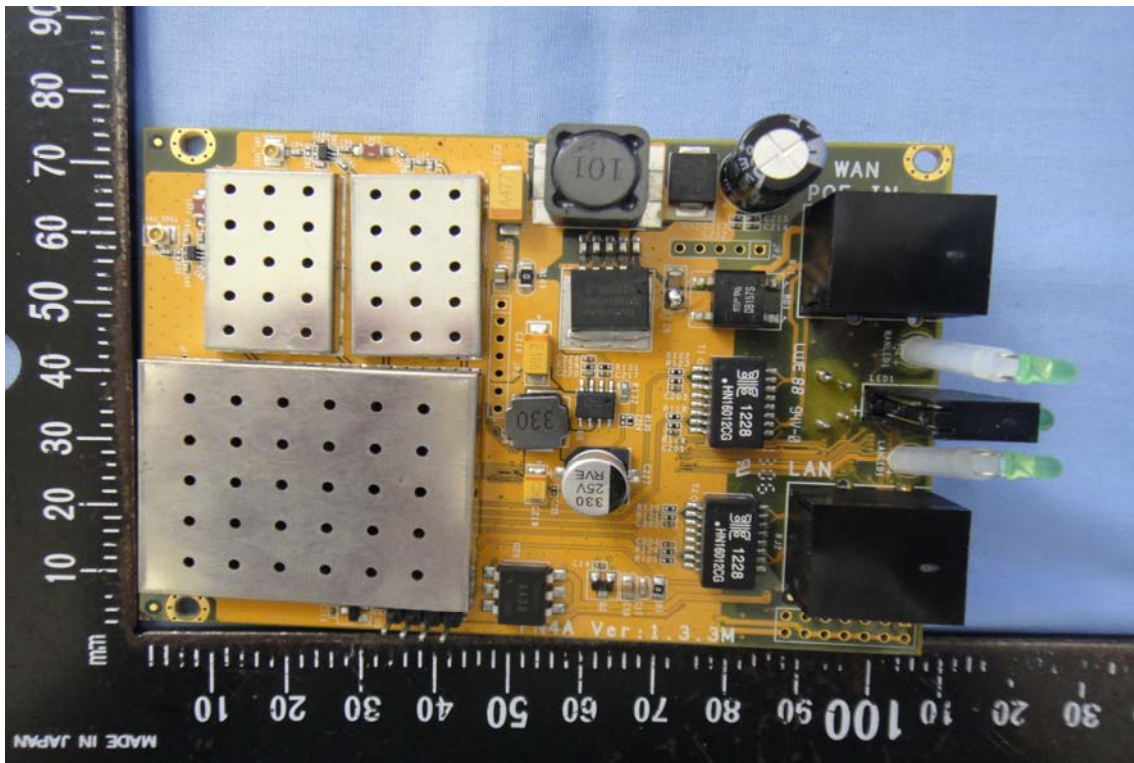



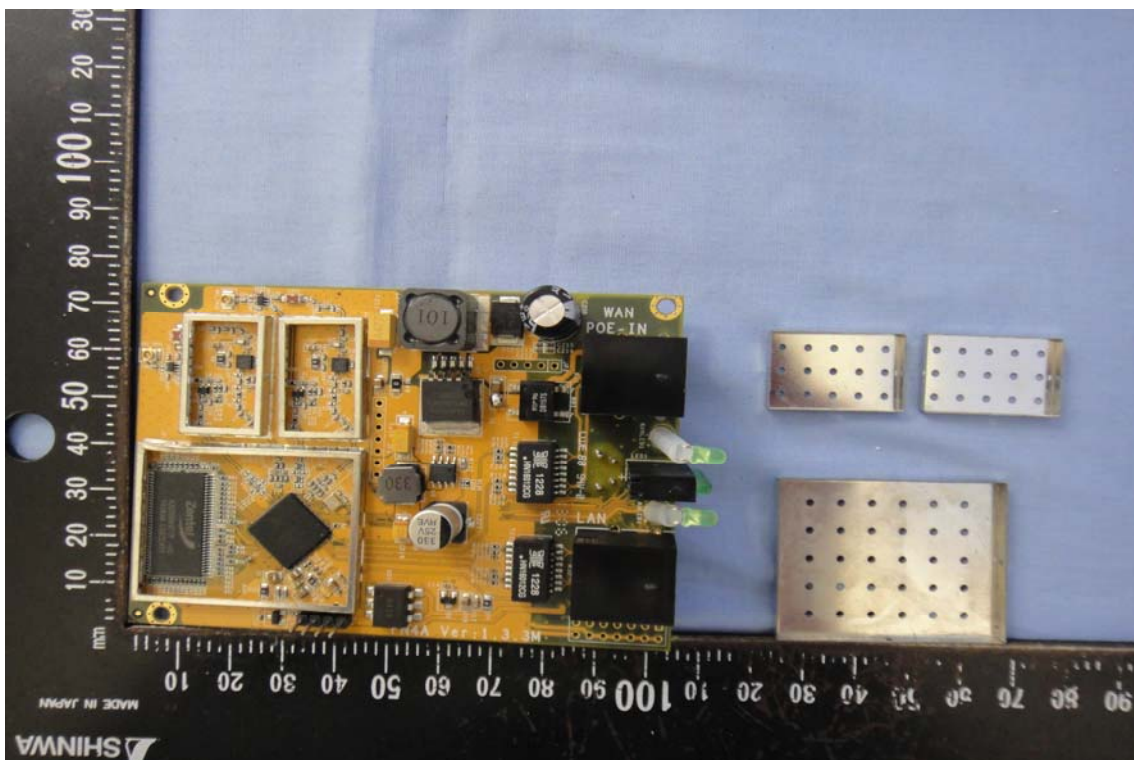
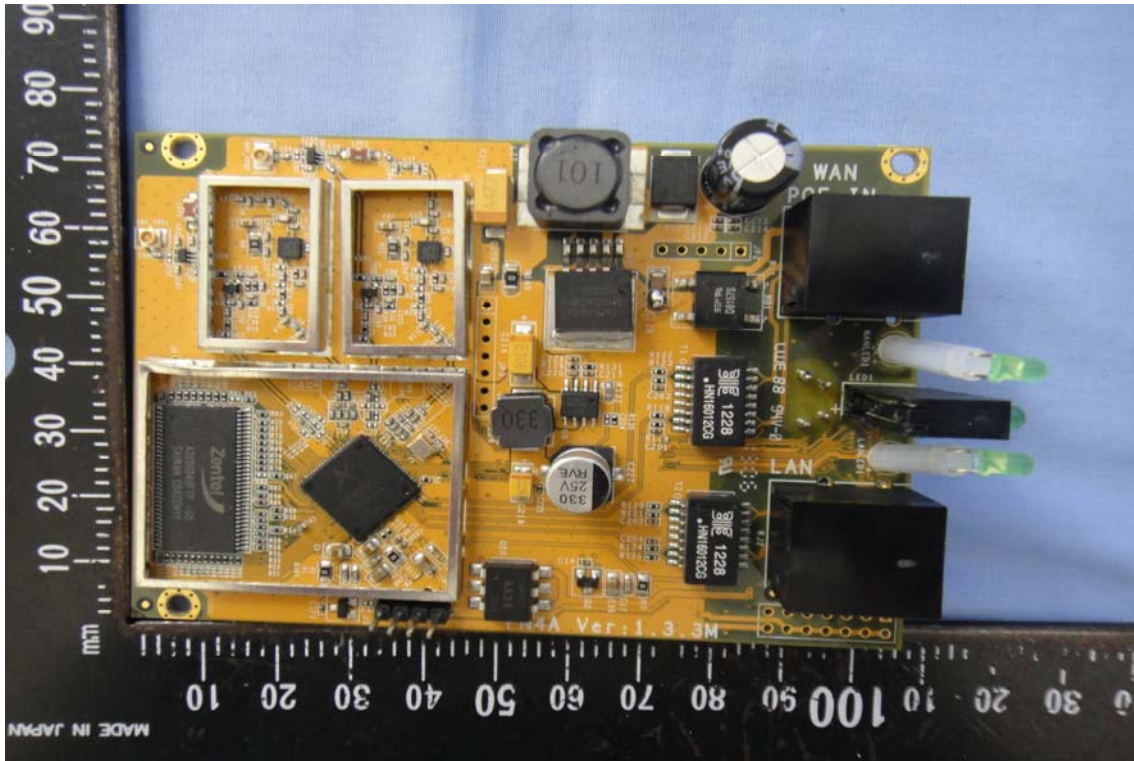

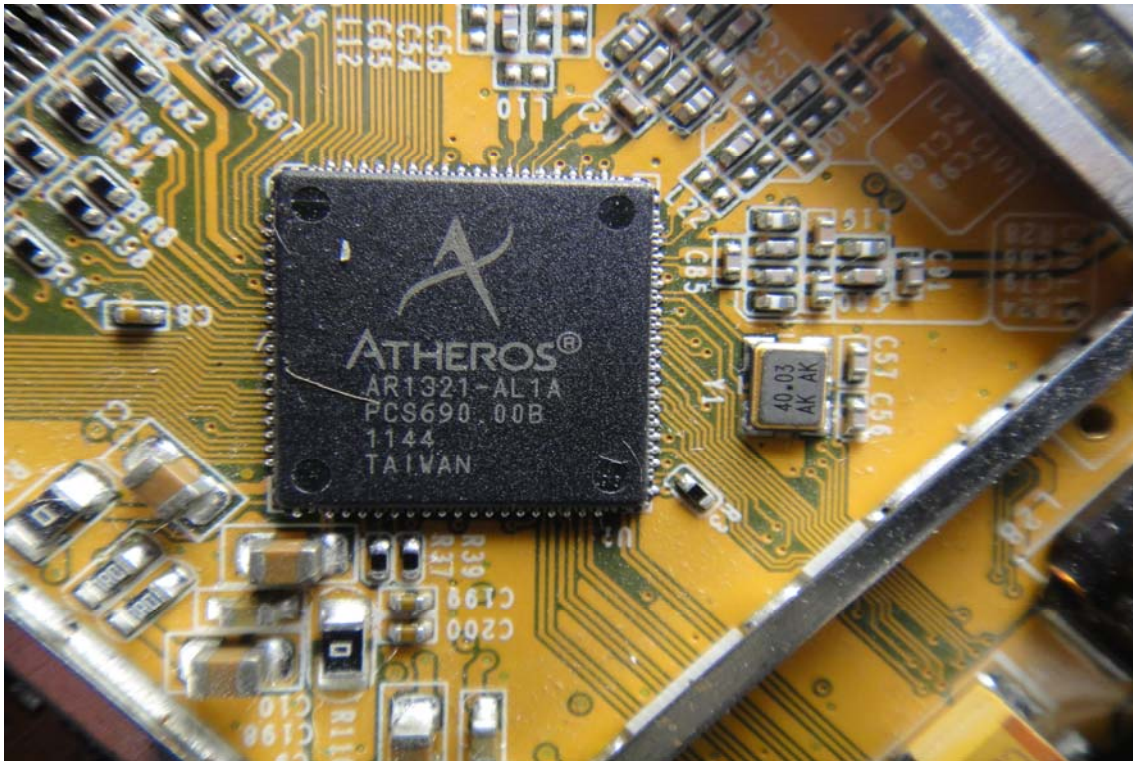





## Antenna

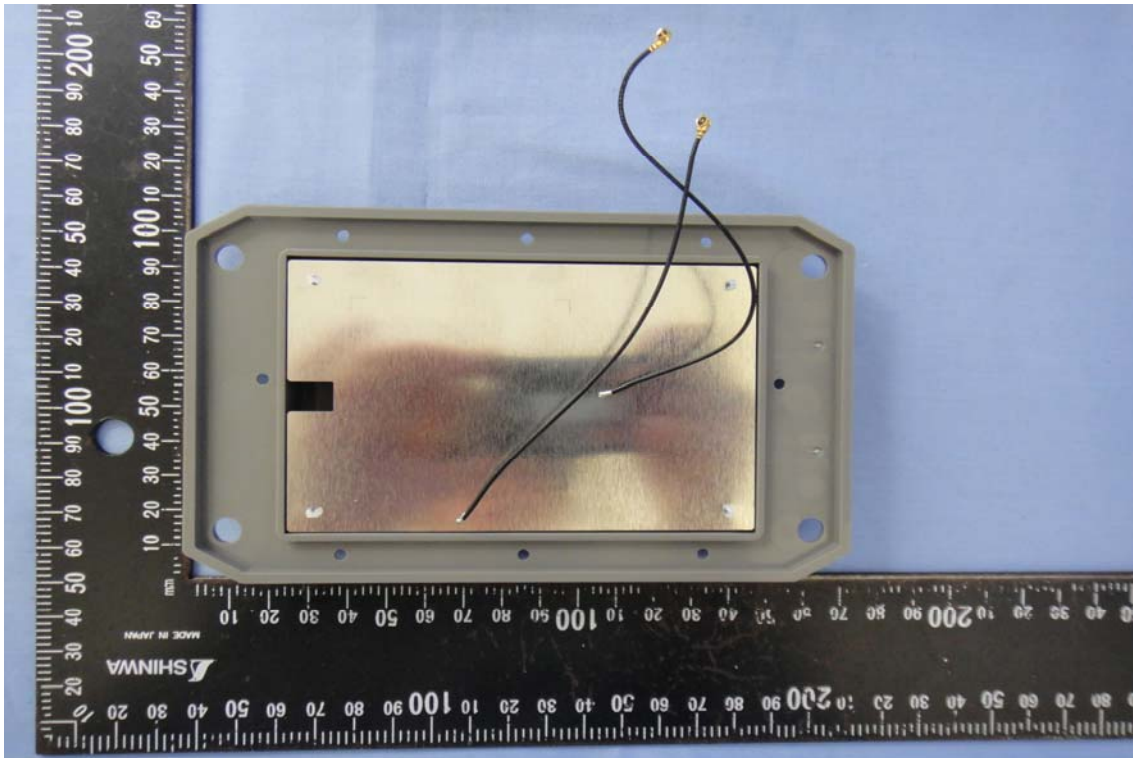

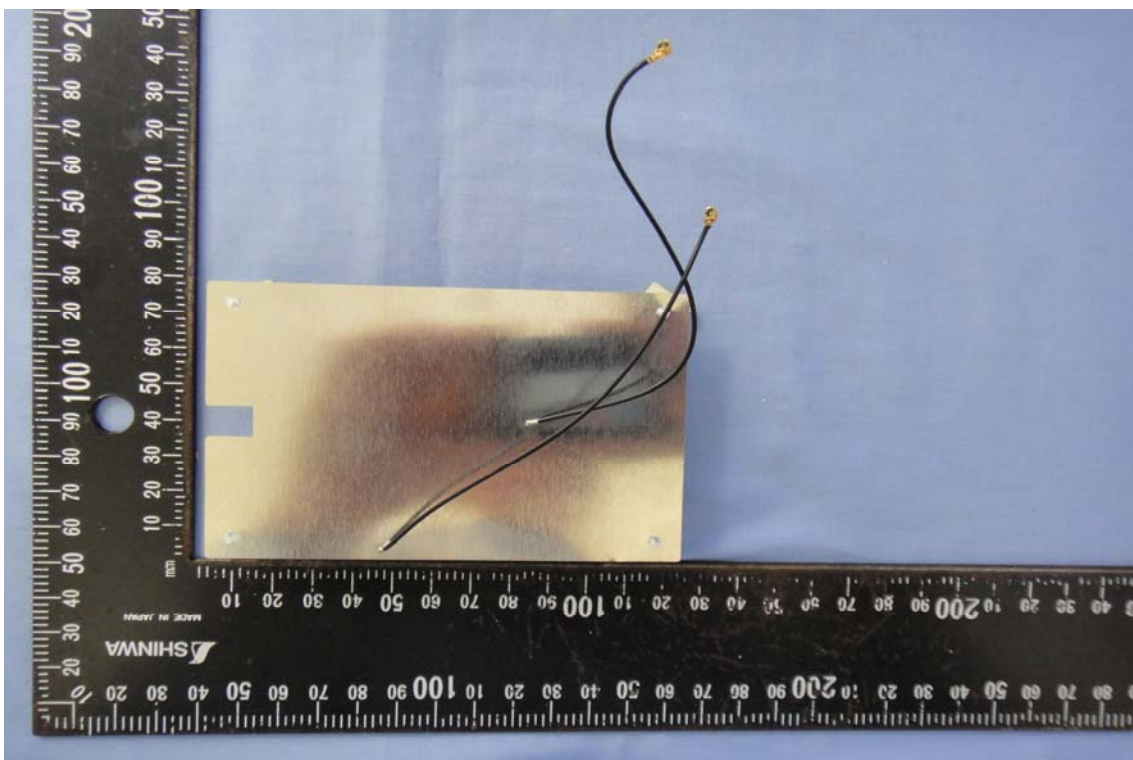
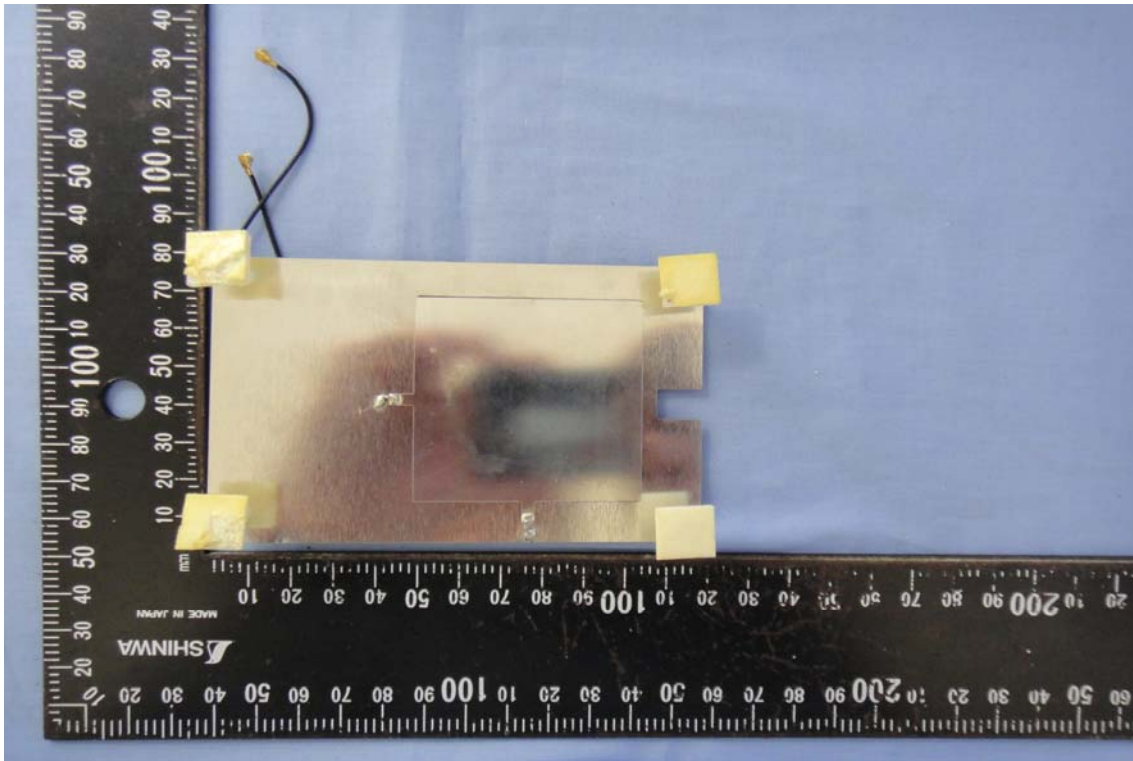





**Model: WLO-12400N**

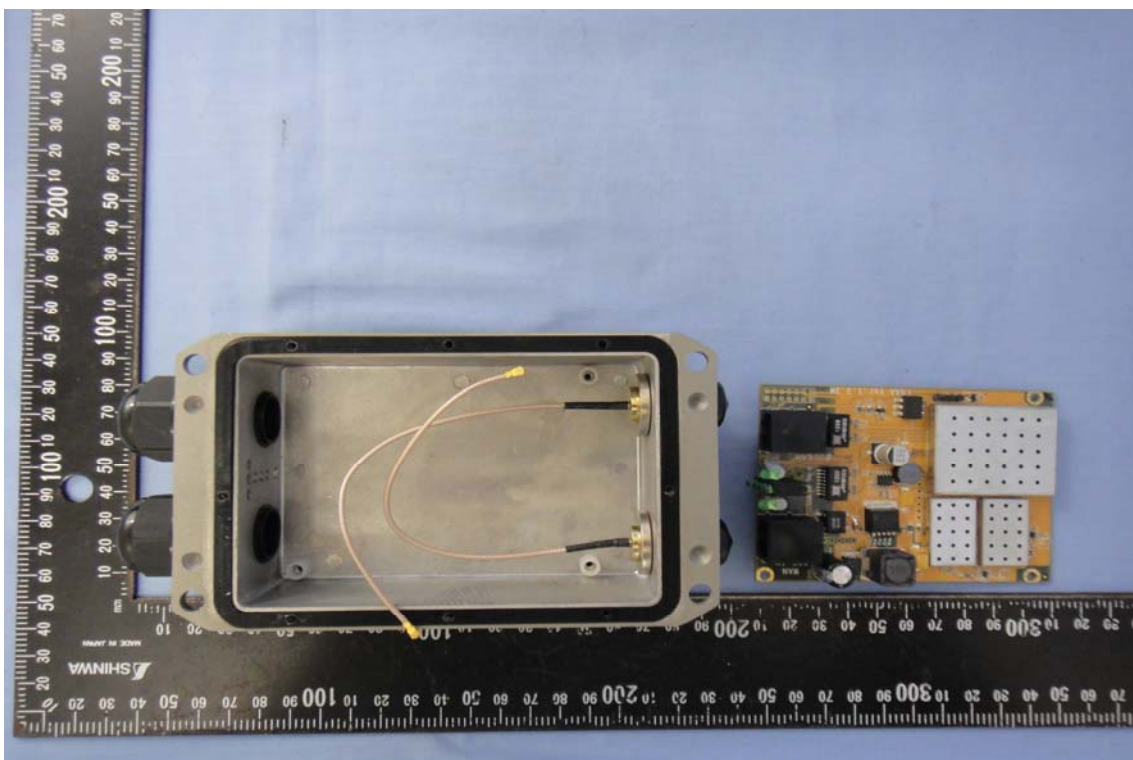
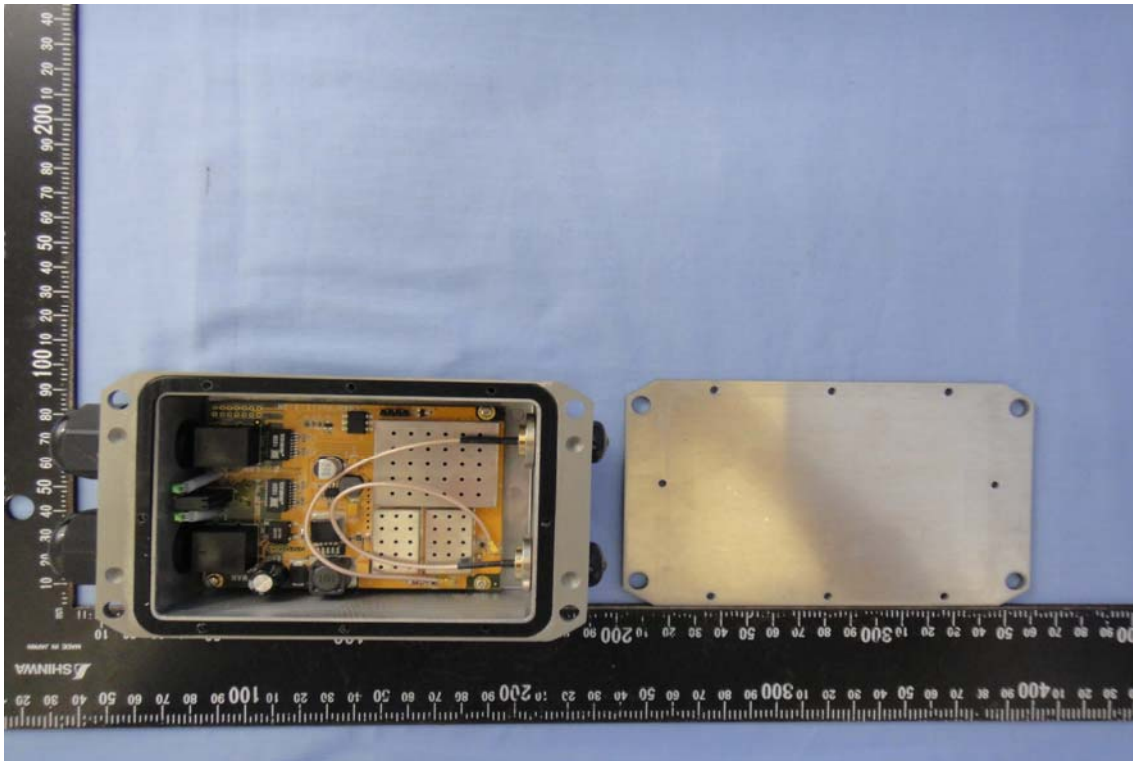

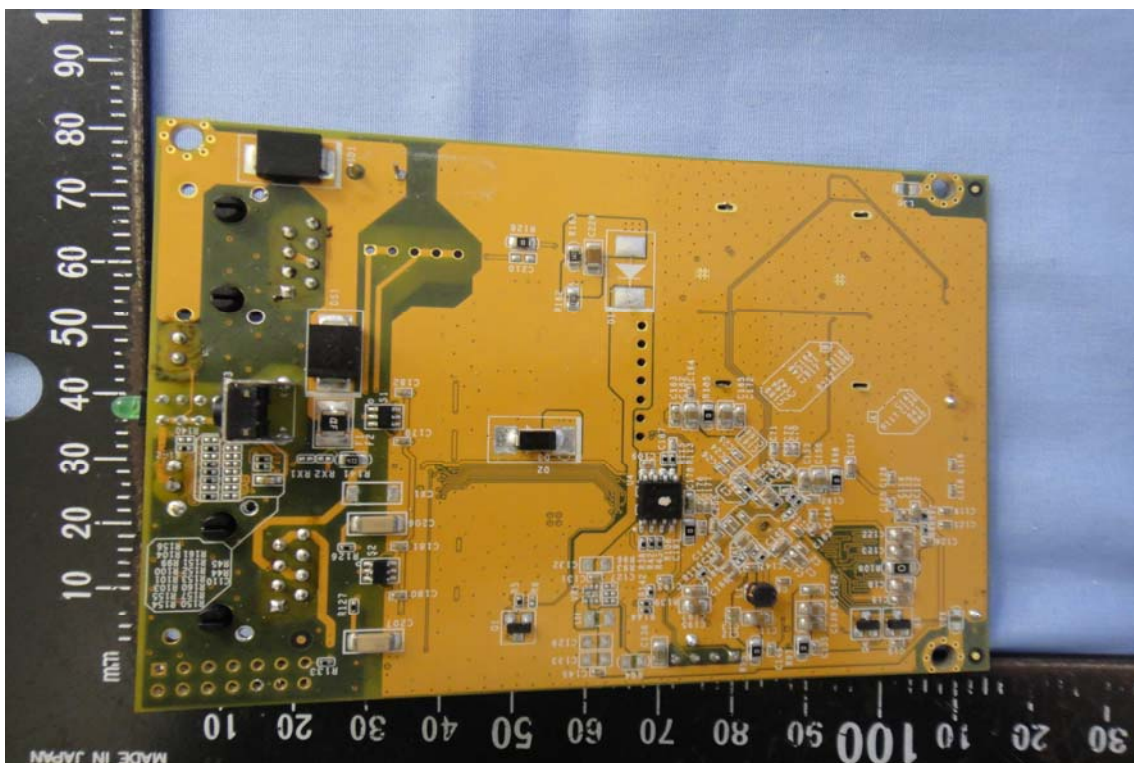
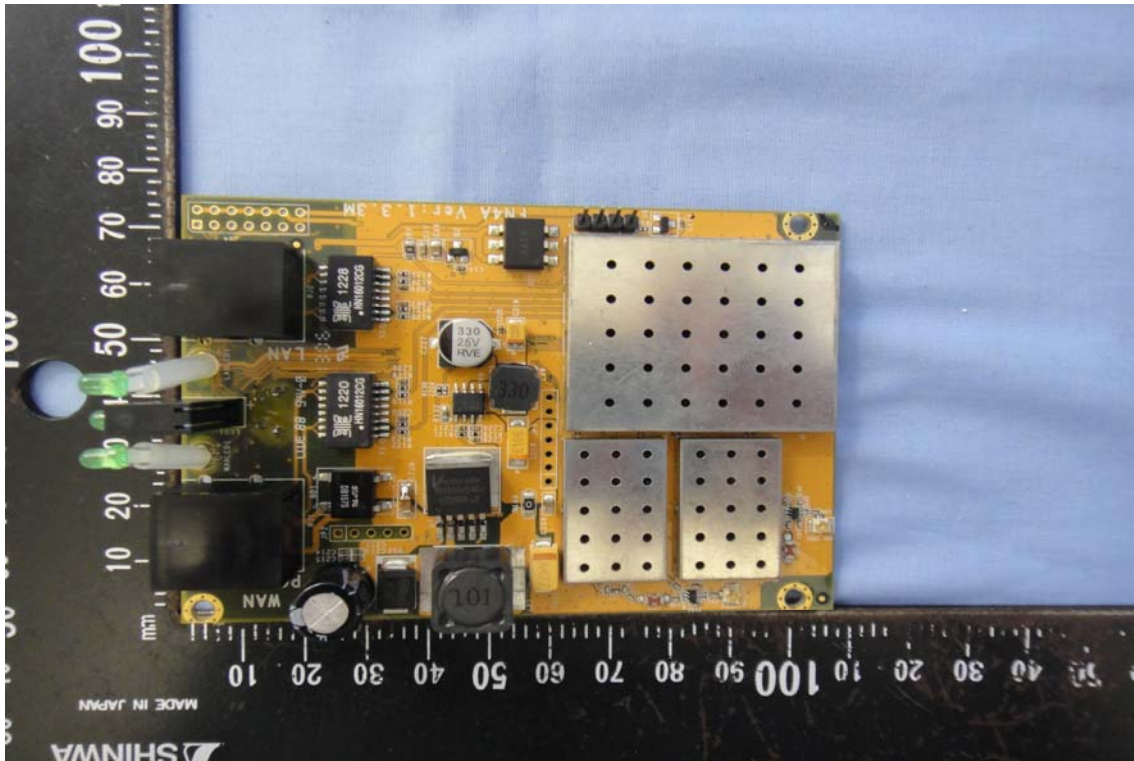



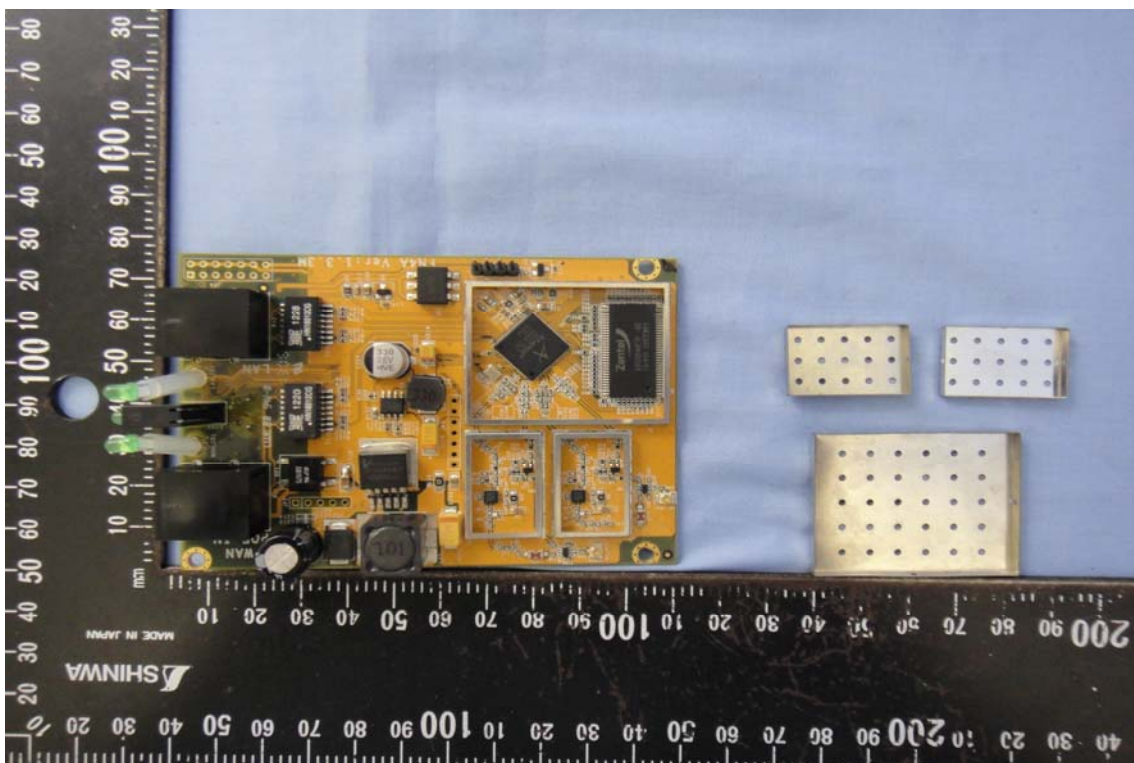
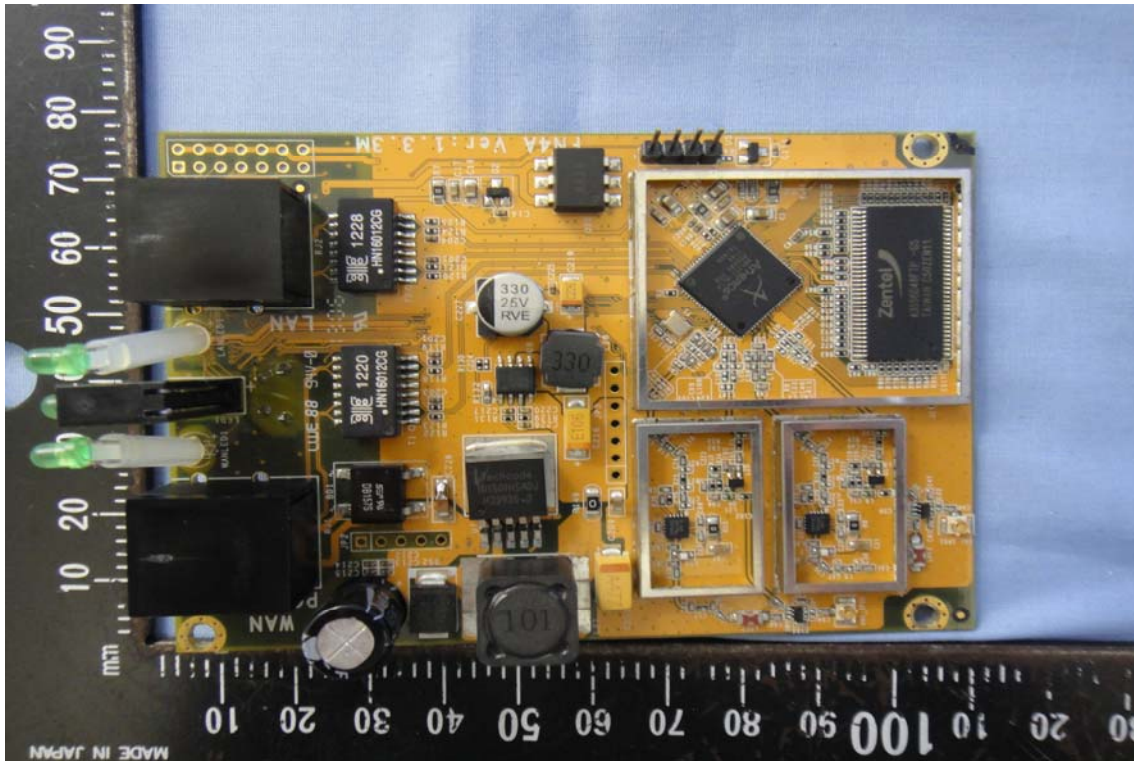

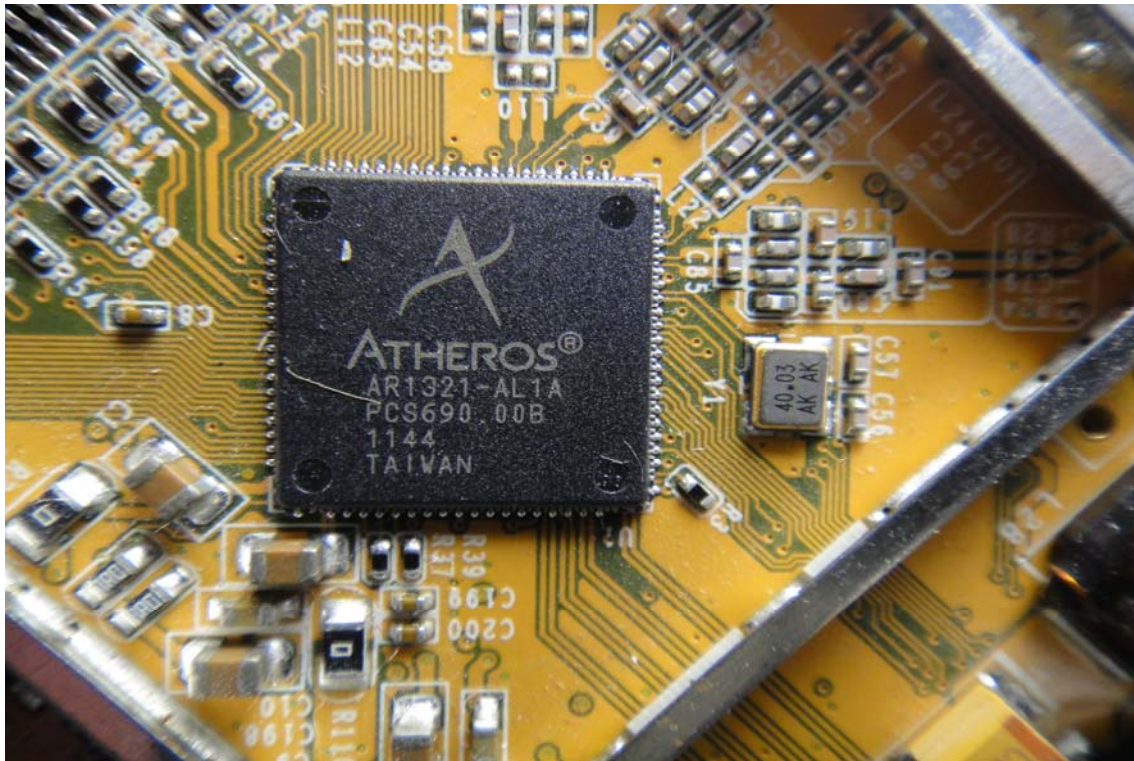





## Antenna

