



FCC 47 CFR PART 15 SUBPART C

TEST REPORT

For

802.11b/g/n USB Dongle

Model / Trade Name:

**WUB1900H5 / Lanready, CUD-1102H5 / Cenwell,
WUB1902H5 / Lanready, WLU-105N / Pheenet,
UW-200NH-2 / Cerio, WWP313SS / Signal Seeker,
TEW-646UBH / Trendnet, K-500MWUN / Kozumi,
WL150H2-USB / Ambeon, UW-200NH / Cerio, WUB1905H5 / Lanready,
AWLL5166HP / AirLink 101, WL150H5-USB / Ambeon,
UWC100N / 4ipnet, CUD-1105H5 / Cenwell**

Issued to

**LanReady Technologies Inc.
3F, No.116, Sinhu 2nd Rd., Neihu District,
Taipei City 114, Taiwan (R.O.C.)**

Issued by

**Compliance Certification Services Inc.
No. 11, Wu-Gong 6th Rd., Wugu Industrial Park,
Taipei Hsien 248, Taiwan (R.O.C.)
<http://www.ccsrf.com>
service@ccsrf.com**



Note: This report shall not be reproduced except in full, without the written approval of Compliance Certification Services Inc. This document may be altered or revised by Compliance Certification Services Inc. personnel only, and shall be noted in the revision section of the document.



TABLE OF CONTENTS

1. TEST RESULT CERTIFICATION.....	3
2. EUT DESCRIPTION	4
3. TEST METHODOLOGY	5
3.1 EUT CONFIGURATION	5
3.2 EUT EXERCISE.....	5
3.3 GENERAL TEST PROCEDURES.....	5
3.4 FCC PART 15.205 RESTRICTED BANDS OF OPERATIONS.....	6
3.5 DESCRIPTION OF TEST MODES	7
4. INSTRUMENT CALIBRATION.....	8
4.1 MEASURING INSTRUMENT CALIBRATION	8
4.2 MEASUREMENT EQUIPMENT USED	9
4.3 MEASUREMENT UNCERTAINTY	10
5. FACILITIES AND ACCREDITATIONS	11
5.1 FACILITIES	11
5.2 EQUIPMENT.....	11
5.3 TABLE OF ACCREDITATIONS AND LISTINGS.....	12
6. SETUP OF EQUIPMENT UNDER TEST	13
6.1 SETUP CONFIGURATION OF EUT.....	13
6.2 SUPPORT EQUIPMENT	13
7. FCC PART 15.247 REQUIREMENTS.....	14
7.1 6DB BANDWIDTH.....	14
7.2 PEAK POWER.....	22
7.3 AVERAGE POWER	24
7.4 BAND EDGES MEASUREMENT	26
7.5 PEAK POWER SPECTRAL DENSITY.....	43
7.6 SPURIOUS EMISSIONS.....	51
7.7 RADIATED EMISSIONS	58
7.8 POWERLINE CONDUCTED EMISSIONS.....	75
APPENDIX I RADIO FREQUENCY EXPOSURE.....	78
APPENDIX II PHOTOGRAPHS OF TEST SETUP	79
APPENDIX 1 - PHOTOGRAPHS OF EUT	



1. TEST RESULT CERTIFICATION

Applicant: LanReady Technologies Inc.
3F, No.116, Sinhu 2nd Rd., Neihu District,
Taipei City 114, Taiwan (R.O.C.)

Equipment Under Test: 802.11b/g/n USB Dongle

Model / Trade Name: WUB1900H5 / Lanready, CUD-1102H5 / Cenwell,
WUB1902H5 / Lanready, WLU-105N / Pheenet,
UW-200NH-2 / Cerio, WWP313SS / Signal Seeker,
TEW-646UBH / Trendnet, K-500MWUN / Kozumi,
WL150H2-USB / Ambeon, UW-200NH / Cerio,
WUB1905H5 / Lanready, AWLL5166HP / AirLink 101,
WL150H5-USB / Ambeon, UWC100N / 4ipnet,
CUD-1105H5 / Cenwell

Date of Test: August 31, 2010 ~ January 9, 2011

APPLICABLE STANDARDS	
STANDARD	TEST RESULT
FCC 47 CFR Part 15 Subpart C	No non-compliance noted

We hereby certify that:

The above equipment was tested by Compliance Certification Services Inc. The test data, data evaluation, test procedures, and equipment configurations shown in this report were made in accordance with the procedures given in ANSI C63.4: 2003 and the energy emitted by the sample EUT tested as described in this report is in compliance with the requirements of FCC Rules Part 15.207, 15.209, 15.247.

The test results of this report relate only to the tested sample EUT identified in this report.

Approved by:

Reviewed by:

Rex Lai
Section Manager
Compliance Certification Services Inc.

Gina Lo
Section Manager
Compliance Certification Services Inc.



2. EUT DESCRIPTION

Product	802.11b/g/n USB Dongle
Model / Trade Name	WUB1900H5 / Lanready, CUD-1102H5 / Cenwell, WUB1902H5 / Lanready, WLU-105N / Pheenet, UW-200NH-2 / Cerio, WWP313SS / Signal Seeker, TEW-646UBH / Trendnet, K-500MWUN / Kozumi, WL150H2-USB / Ambeon, UW-200NH / Cerio, WUB1905H5 / Lanready, AWLL5166HP / AirLink 101, WL150H5-USB / Ambeon, UWC100N / 4ipnet, CUD-1105H5 / Cenwell
Model Discrepancy	For 2dBi Omni Antenna
	WUB1902H5 / Lanready, CUD-1102H5 / Cenwell, WLU-105N / Pheenet, UW-200NH-2 / Cerio, WWP313SS / Signal Seeker, TEW-646UBH / Trendnet, K-500MWUN / Kozumi, WL150H2-USB / Ambeon
	For 5dBi Omni Antenna
	WUB1905H5 / Lanready, UWC100N / 4ipnet, UW-200NH / Cerio, AWLL5166HP / AirLink 101, WL150H5-USB / Ambeon, CUD-1105H5 / Cenwell, WUB1900H5 / Lanready
Power Supply	Powered from host PC.
Frequency Range	2412 ~ 2462 MHz
Transmit Power	IEEE 802.11b mode: 19.08 dBm IEEE 802.11g mode: 18.67 dBm IEEE 802.11n HT 20 MHz mode: 18.84 dBm IEEE 802.11n HT 40 MHz mode: 18.16 dBm
Modulation Technique	IEEE 802.11b mode: DSSS (1, 2, 5.5 and 11 Mbps) IEEE 802.11g mode: OFDM (6, 9, 12, 18, 24, 36, 48 and 54 Mbps) IEEE 802.11n HT 20 MHz mode: OFDM (6.5, 13, 19.5, 26, 39, 52, 58.5, 65.0Mbps) IEEE 802.11n HT 40 MHz mode: OFDM (13.5, 27, 40.5, 54, 81, 108, 121.5, 135Mbps)
Number of Channels	IEEE 802.11b/g mode: 11 Channels IEEE 802.11n HT 20 MHz mode: 11 Channels IEEE 802.11n HT 40 MHz mode: 7 Channels
Antenna Specification	1. Dipole Antenna / Gain: 3.22dBi 2. Dipole Antenna / Gain: 4.16dBi

Remark:

1. The sample selected for test was engineering sample that approximated to production product and was provided by manufacturer.
2. This submittal(s) (test report) is intended for FCC ID: **SCD030021** filing to comply with Section 15.207, 15.209 and 15.247 of the FCC Part 15, Subpart C Rules.



3. TEST METHODOLOGY

The tests documented in this report were performed in accordance with ANSI C63.4 and FCC CFR 47 2.1046, 2.1047, 2.1049, 2.1051, 2.1053, 2.1055, 2.1057, 15.207, 15.209 and 15.247.

3.1 EUT CONFIGURATION

The EUT configuration for testing is installed on RF field strength measurement to meet the Commissions requirement and operating in a manner that intends to maximize its emission characteristics in a continuous normal application.

3.2 EUT EXERCISE

The EUT was operated in the engineering mode to fix the TX frequency that was for the purpose of the measurements.

According to its specifications, the EUT must comply with the requirements of the Section 15.207, 15.209 and 15.247 under the FCC Rules Part 15 Subpart C.

3.3 GENERAL TEST PROCEDURES

Conducted Emissions

The EUT is placed on the turntable, which is 0.8 m above ground plane. According to the requirements in Section 13.1.4.1 of ANSI C63.4 Conducted emissions from the EUT measured in the frequency range between 0.15 MHz and 30MHz using CISPR Quasi-peak and average detector modes.

Radiated Emissions

The EUT is placed on a turn table, which is 0.8 m above ground plane. The turntable shall rotate 360 degrees to determine the position of maximum emission level. EUT is set 3m away from the receiving antenna, which varied from 1m to 4m to find out the highest emission. And also, each emission was to be maximized by changing the polarization of receiving antenna both horizontal and vertical. In order to find out the maximum emissions, exploratory radiated emission measurements were made according to the requirements in Section 13.1.4.1 of ANSI C63.4.



3.4 FCC PART 15.205 RESTRICTED BANDS OF OPERATIONS

(a) Except as shown in paragraph (d) of this section, only spurious emissions are permitted in any of the frequency bands listed below:

MHz	MHz	MHz	GHz
0.090 - 0.110	16.42 - 16.423	399.9 - 410	4.5 - 5.15
¹ 0.495 - 0.505	16.69475 - 16.69525	608 - 614	5.35 - 5.46
2.1735 - 2.1905	16.80425 - 16.80475	960 - 1240	7.25 - 7.75
4.125 - 4.128	25.5 - 25.67	1300 - 1427	8.025 - 8.5
4.17725 - 4.17775	37.5 - 38.25	1435 - 1626.5	9.0 - 9.2
4.20725 - 4.20775	73 - 74.6	1645.5 - 1646.5	9.3 - 9.5
6.215 - 6.218	74.8 - 75.2	1660 - 1710	10.6 - 12.7
6.26775 - 6.26825	108 - 121.94	1718.8 - 1722.2	13.25 - 13.4
6.31175 - 6.31225	123 - 138	2200 - 2300	14.47 - 14.5
8.291 - 8.294	149.9 - 150.05	2310 - 2390	15.35 - 16.2
8.362 - 8.366	156.52475 -	2483.5 - 2500	17.7 - 21.4
8.37625 - 8.38675	156.52525	2655 - 2900	22.01 - 23.12
8.41425 - 8.41475	156.7 - 156.9	3260 - 3267	23.6 - 24.0
12.29 - 12.293	162.0125 - 167.17	3332 - 3339	31.2 - 31.8
12.51975 - 12.52025	167.72 - 173.2	3345.8 - 3358	36.43 - 36.5
12.57675 - 12.57725	240 - 285	3600 - 4400	(²)
13.36 - 13.41	322 - 335.4		

¹ Until February 1, 1999, this restricted band shall be 0.490-0.510 MHz.

² Above 38.6

(b) Except as provided in paragraphs (d) and (e), the field strength of emissions appearing within these frequency bands shall not exceed the limits shown in Section 15.209. At frequencies equal to or less than 1000 MHz, compliance with the limits in Section 15.209 shall be demonstrated using measurement instrumentation employing a CISPR quasi-peak detector. Above 1000 MHz, compliance with the emission limits in Section 15.209 shall be demonstrated based on the average value of the measured emissions. The provisions in Section 15.35 apply to these measurements.



3.5 DESCRIPTION OF TEST MODES

The EUT (model: WUB1900H5) had been tested under operating condition.

Software used to control the EUT for staying in continuous transmitting mode was programmed.

After verification, all tests were carried out with the worst case test modes as shown below except radiated spurious emission below 1GHz and power line conducted emissions below 30MHz, which worst case was in normal link mode only.

IEEE 802.11b mode:

Channel Low (2412MHz), Channel Mid (2437MHz) and Channel High (2462MHz) with 1Mbps data rate were chosen for full testing.

IEEE 802.11g mode:

Channel Low (2412MHz), Channel Mid (2437MHz) and Channel High (2462MHz) with 6Mbps data rate were chosen for full testing.

IEEE 802.11n HT 20 MHz mode:

Channel Low (2412MHz), Channel Mid (2437MHz) and Channel High (2462MHz) with 6.5Mbps data rate were chosen for full testing.

IEEE 802.11n HT 40 MHz mode:

Channel Low (2422MHz), Channel Mid (2437MHz) and Channel High (2452MHz) with 13.5Mbps data rate were chosen for full testing.



4. INSTRUMENT CALIBRATION

4.1 MEASURING INSTRUMENT CALIBRATION

The measuring equipment, which was utilized in performing the tests documented herein, has been calibrated in accordance with the manufacturer's recommendations for utilizing calibration equipment, which is traceable to recognized national standards.



4.2 MEASUREMENT EQUIPMENT USED

Equipment Used for Emissions Measurement

Remark: Each piece of equipment is scheduled for calibration once a year and Loop Antenna is scheduled for calibration once three years.

Conducted Emissions Test Site				
Name of Equipment	Manufacturer	Model	Serial Number	Calibration Due
Spectrum Analyzer	Agilent	E4446A	MY43360131	03/03/2011
Spectrum Analyzer	R&S	FSEK30	100264	04/13/2011
Power Meter	Anritsu	E4416A	GB41291611	09/26/2011
Power Sensor	Anritsu	E9327A	US40441097	09/16/2011

3M Semi Anechoic Chamber				
Name of Equipment	Manufacturer	Model	Serial Number	Calibration Due
Spectrum Analyzer	Agilent	E4446A	US42510252	10/25/2011
EMI Test Receiver	R&S	ESCI	100064	02/04/2011
Pre-Amplifier	Mini-Circuits	ZFL-1000LN	SF350700823	01/12/2012
Pre-Amplifier	MITEQ	AFS44-00102650-42-10P-44	1415367	11/19/2011
Bilog Antenna	Sunol Sciences	JB3	A030105	09/10/2011
Horn Antenna	EMCO	3117	00055165	12/06/2011
Loop Antenna	EMCO	6502	8905/2356	06/10/2013
Turn Table	CCS	CC-T-1F	N/A	N.C.R
Antenna Tower	CCS	CC-A-1F	N/A	N.C.R
Controller	CCS	CC-C-1F	N/A	N.C.R
Site NSA	CCS	N/A	N/A	12/30/2011
Test S/W	EZ-EMC (CCS-3A1RE)			

Powerline Conducted Emissions Test Site				
Name of Equipment	Manufacturer	Model	Serial Number	Calibration Due
EMI Test Receiver	R&S	ESHS10	843743/015	03/25/2011
LISN	SCHWARZBECK	NSLK 8127	8127-541	03/14/2011
LISN	SCHAFFNER	NNB 41	03/10013	12/02/2011
Test S/W	CCS-3A1-CE			



4.3 MEASUREMENT UNCERTAINTY

PARAMETER	UNCERTAINTY
Powerline Conducted Emission	+/- 1.6202
3M Semi Anechoic Chamber / 30M~200M	+/- 4.0606
3M Semi Anechoic Chamber / 200M~1000M	+/- 3.9979
3M Semi Anechoic Chamber / 1G~8G	+/- 2.5790
3M Semi Anechoic Chamber / 8G~18G	+/- 2.5928
3M Semi Anechoic Chamber / 18G~26G	+/- 2.7212
3M Semi Anechoic Chamber / 26G~40G	+/- 2.9520

Remark: This uncertainty represents an expanded uncertainty expressed at approximately the 95% confidence level using a coverage factor of $k=2$.



5. FACILITIES AND ACCREDITATIONS

5.1 FACILITIES

All measurement facilities used to collect the measurement data are located at

No.199, Chunghsen Road, Hsintien City, Taipei Hsien, Taiwan, R.O.C.

Tel: 886-2-2217-0894 / Fax: 886-2-2217-1029

No.11, Wugong 6th Rd., Wugu Industrial Park, Taipei Hsien 248, Taiwan

Tel: 886-2-2299-9720 / Fax: 886-2-2298-4045

No.81-1, Lane 210, Bade 2nd Rd., Luchu Hsiang, Taoyuan Hsien 338, Taiwan

Tel: 886-3-324-0332 / Fax: 886-3-324-5235

The sites are constructed in conformance with the requirements of ANSI C63.7, ANSI C63.4 and CISPR Publication 22.

5.2 EQUIPMENT

Radiated emissions are measured with one or more of the following types of linearly polarized antennas: tuned dipole, biconical, log periodic, bi-log, and/or ridged waveguide, horn. Spectrum analyzers with pre-selectors and quasi-peak detectors are used to perform radiated measurements.



Conducted emissions are measured with Line Impedance Stabilization Networks and EMI Test Receivers.

Calibrated wideband preamplifiers, coaxial cables, and coaxial attenuators are also used for making measurements.

All receiving equipment conforms to CISPR Publication 16-1, "Radio Interference Measuring Apparatus and Measurement Methods."



5.3 TABLE OF ACCREDITATIONS AND LISTINGS

Country	Agency	Scope of Accreditation	Logo
USA	FCC	3M Semi Anechoic Chamber (FCC MRA: TW1039) to perform FCC Part 15 measurements	 FCC MRA: TW1039
Taiwan	TAF	LP0002, RTTE01, FCC Method-47 CFR Part 15 Subpart C, D, E, RSS-210, RSS-310 IDA TS SRD, AS/NZS 4268, AS/NZS 4771, TS 12.1 & 12.2, ETSI EN 300 440-1, ETSI EN 300 440-2, ETSI EN 300 328, ETSI EN 300 220-1, ETSI EN 300 220-2, ETSI EN 301 893, ETSI EN 301 489-1/3/7/17 FCC OET Bulletin 65 + Supplement C, EN 50360, EN 50361, EN 50371, RSS 102, EN 50383, EN 50385, EN 50392, IEC 62209, CNS 14958-1, CNS 14959 FCC Method -47 CFR Part 15 Subpart B IEC / EN 61000-3-2, IEC / EN 61000-3-3, IEC / EN 61000-4-2/3/4/5/6/8/11	
Canada	Industry Canada	3M Semi Anechoic Chamber (IC 2324G-1 / IC 2324G-2) to perform	 IC 2324G-1 IC 2324G-2

* No part of this report may be used to claim or imply product endorsement by A2LA or any agency of the US Government.



6. SETUP OF EQUIPMENT UNDER TEST

6.1 SETUP CONFIGURATION OF EUT

See test photographs attached in Appendix II for the actual connections between EUT and support equipment.

6.2 SUPPORT EQUIPMENT

No	Device Type	Brand	Model	Series No.	FCC ID	Data Cable	Power Cord
1.	LCD Monitor	DELL	3008WFP	CN-0XK290-71618-846-169L	FCC DoC	Unshielded, 1.8m	shielded, 1.8m
2.	USB Mouse	DELL	Sk-8115	N/A	FCC DoC	Shielded, 1.8m	N/A
3.	Notebook PC	DELL	PP10L	7B3ZP1S	FCC DoC	N/A	AC I/P: Unshielded, 1.8m DC O/P: Unshielded, 1.8m with a core
4.	320GB 2.5" HDD	Seagate	9ZA2MG-500	538224 2806	FCC DoC	Shielded, 1.8m	N/A
5.	Notebook PC	HP	dv6-1332TX	CNF9491GLJ	PD9112BNHU	N/A	AC I/P: Unshielded, 1.8m DC O/P: Unshielded, 1.8m with a core
6.	Wireless Router (Remote)	ASUS	WL-500g	471GA12838	MSQWL500G	N/A	Unshielded, 1.8m

Remark:

1. All the equipment/cables were placed in the worst-case configuration to maximize the emission during the test.
2. Grounding was established in accordance with the manufacturer's requirements and conditions for the intended use.



7. FCC PART 15.247 REQUIREMENTS

7.1 6DB BANDWIDTH

LIMIT

According to §15.247(a)(2), systems using digital modulation techniques may operate in the 902 - 928 MHz, 2400 - 2483.5 MHz, and 5725 - 5850 MHz bands. The minimum 6dB bandwidth shall be at least 500 kHz.

Test Configuration

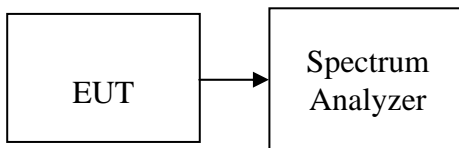

TEST PROCEDURE

1. Place the EUT on the table and set it in the transmitting mode.
2. Remove the antenna from the EUT and then connect a low loss RF cable from the antenna port to the spectrum analyzer.
3. Set the spectrum analyzer as RBW = 100 kHz, VBW = RBW, Span = 50 MHz, Sweep = auto.
4. Mark the peak frequency and -6dB (upper and lower) frequency.
5. Repeat until all the rest channels are investigated.

TEST RESULTS

No non-compliance noted



Test Data

Test mode: IEEE 802.11b mode

Channel	Frequency (MHz)	6dB Bandwidth (kHz)	Limit (kHz)	Result
Low	2412	9500	>500	PASS
Mid	2437	9830		PASS
High	2462	9330		PASS

Test mode: IEEE 802.11g mode

Channel	Frequency (MHz)	6dB Bandwidth (kHz)	Limit (kHz)	Result
Low	2412	16500	>500	PASS
Mid	2437	16500		PASS
High	2462	16500		PASS

Test mode: IEEE 802.11n HT 20 MHz mode

Channel	Frequency (MHz)	6dB Bandwidth (kHz)	Limit (kHz)	Result
Low	2412	17830	>500	PASS
Mid	2437	17750		PASS
High	2462	17750		PASS

Test mode: IEEE 802.11n HT 40 MHz mode

Channel	Frequency (MHz)	6dB Bandwidth (kHz)	Limit (kHz)	Result
Low	2422	36420	>500	PASS
Mid	2437	36420		PASS
High	2452	36420		PASS



IEEE 802.11b mode

6dB Bandwidth (CH Low)

Agilent 13:43:52 Dec 16, 2010

R T

Δ Mkr1 9.50 MHz
-1.31 dB

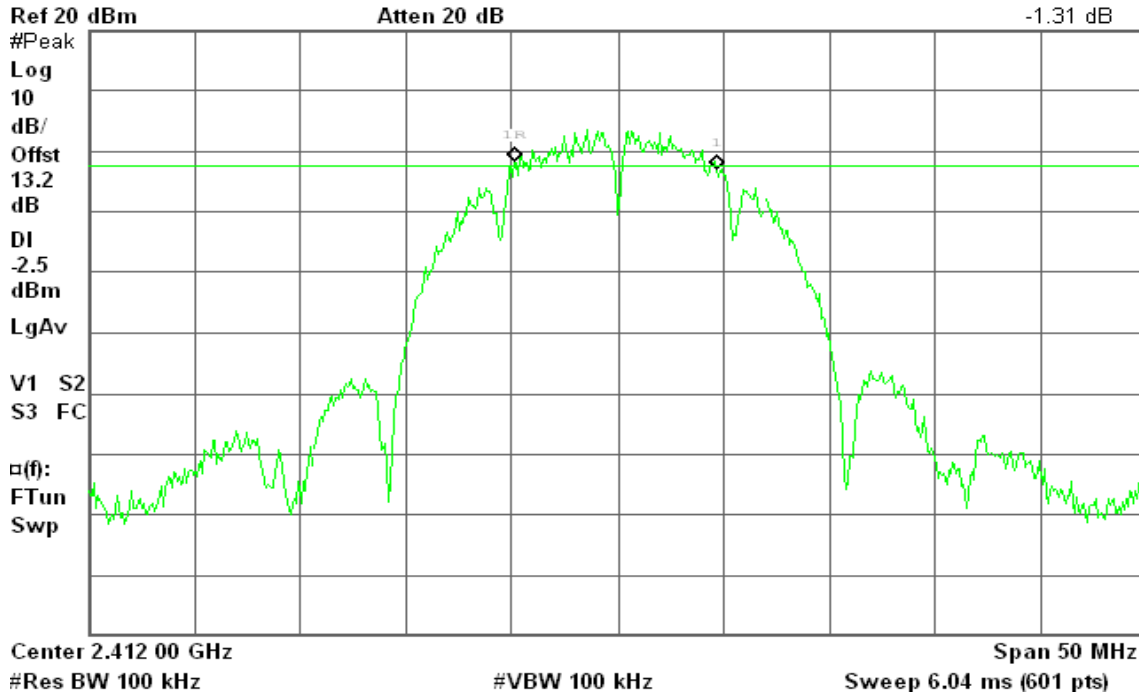

6dB Bandwidth (CH Mid)

Agilent 13:50:45 Dec 16, 2010

R T

Δ Mkr1 9.83 MHz
0.47 dB

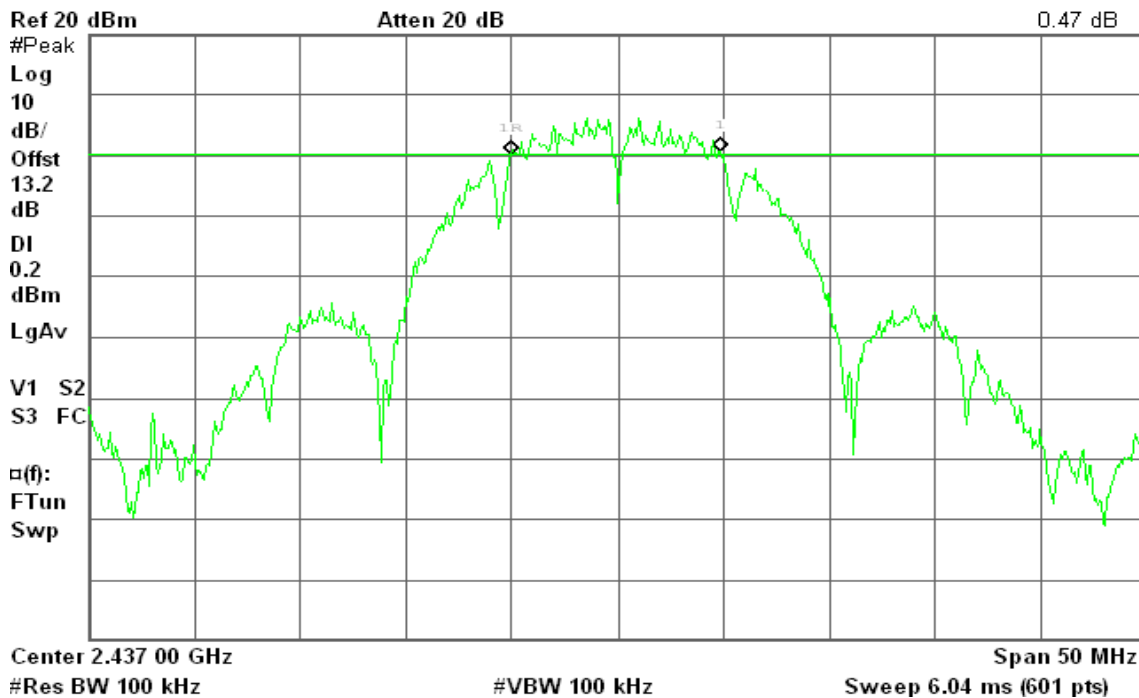



6dB Bandwidth (CH High)

Agilent 14:15:48 Dec 16, 2010

R T

Δ Mkr1 9.33 MHz
0.52 dB

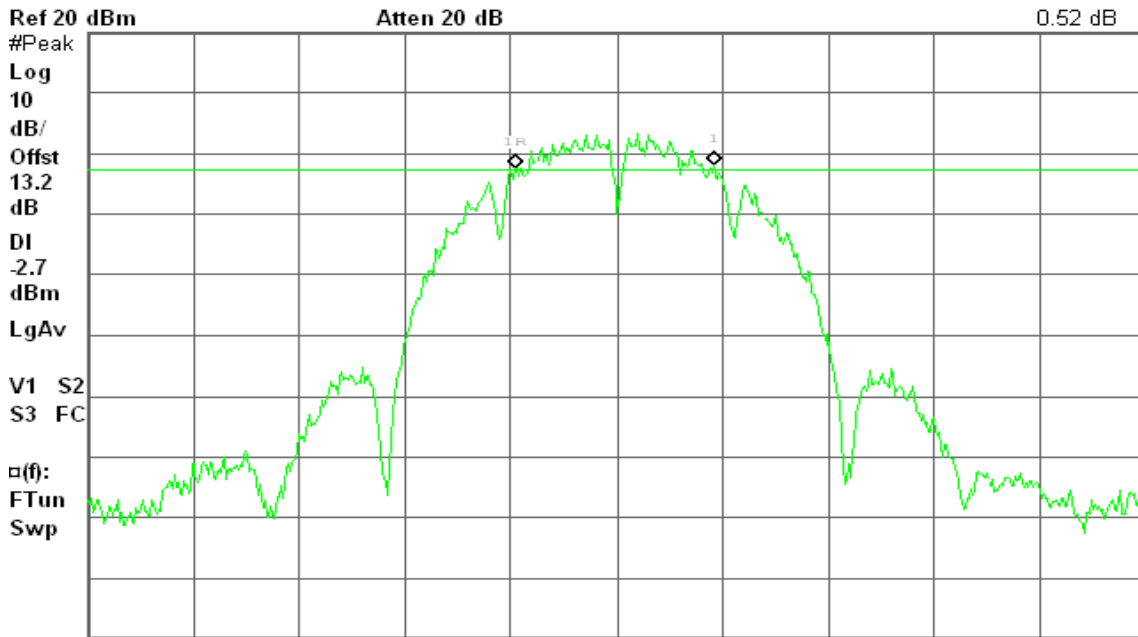

Center 2.462 00 GHz Span 50 MHz
#Res BW 100 kHz #VBW 100 kHz Sweep 6.04 ms (601 pts)

IEEE 802.11g mode

6dB Bandwidth (CH Low)

Agilent 14:20:21 Dec 16, 2010

R T

Δ Mkr1 16.50 MHz
-0.82 dB

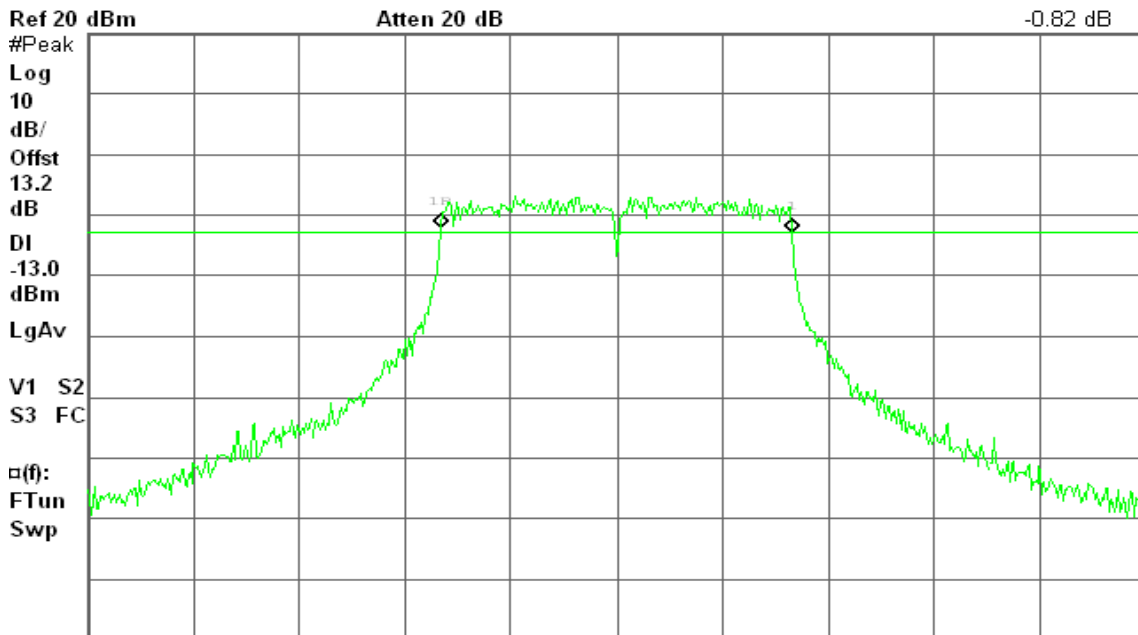

Center 2.412 00 GHz Span 50 MHz
#Res BW 100 kHz #VBW 100 kHz Sweep 6.04 ms (601 pts)



6dB Bandwidth (CH Mid)

Agilent 14:24:41 Dec 16, 2010

R T

Δ Mkr1 16.50 MHz
-0.13 dB

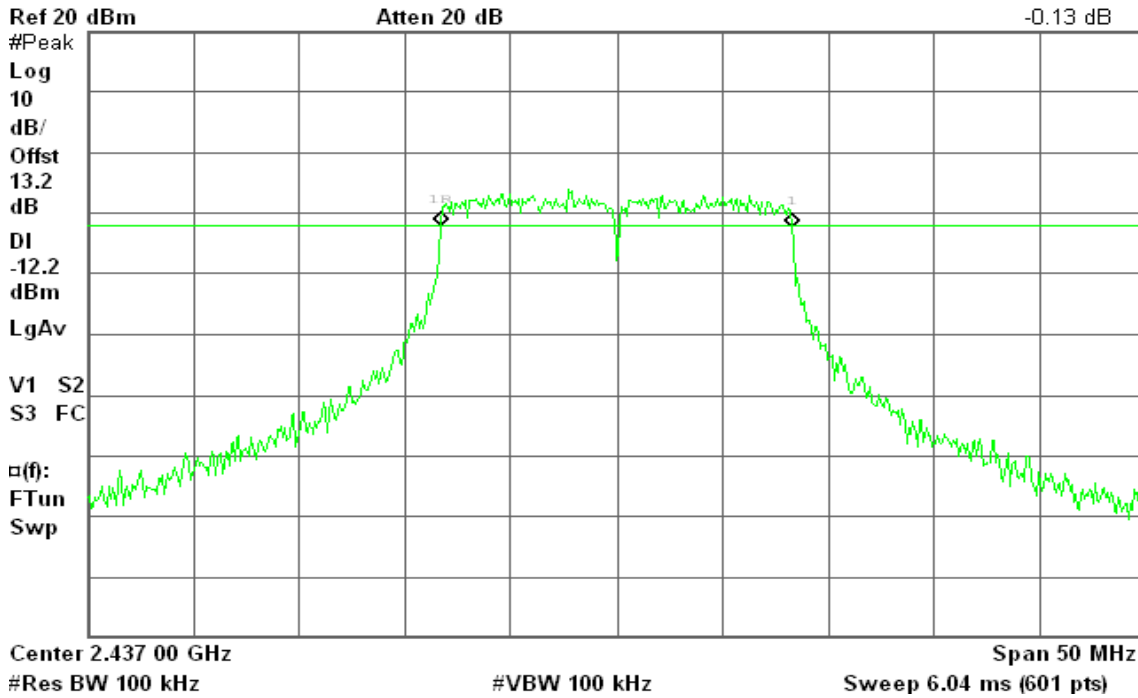

6dB Bandwidth (CH High)

Agilent 14:28:28 Dec 16, 2010

R T

Δ Mkr1 16.50 MHz
0.01 dB

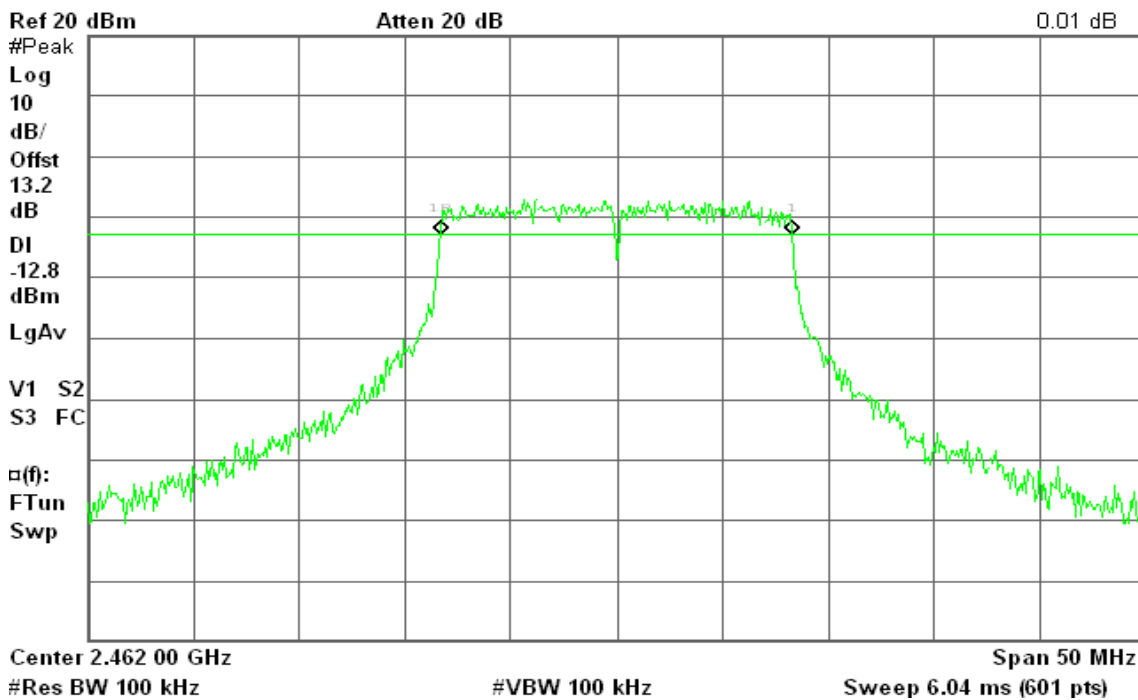



IEEE 802.11n HT 20 MHz mode

6dB Bandwidth (CH Low)

Agilent 14:32:56 Dec 16, 2010

R T

Δ Mkr1 17.83 MHz
1.05 dB

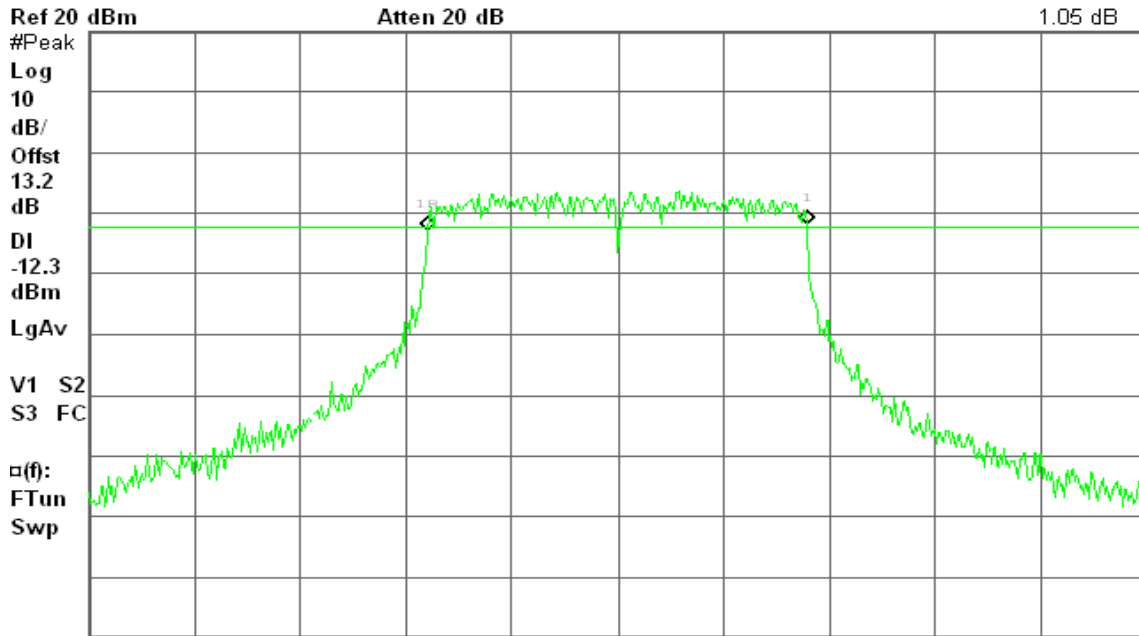

Center 2.412 00 GHz Span 50 MHz
#Res BW 100 kHz #VBW 100 kHz Sweep 6.04 ms (601 pts)

6dB Bandwidth (CH Mid)

Agilent 14:36:48 Dec 16, 2010

R T

Δ Mkr1 17.75 MHz
0.31 dB

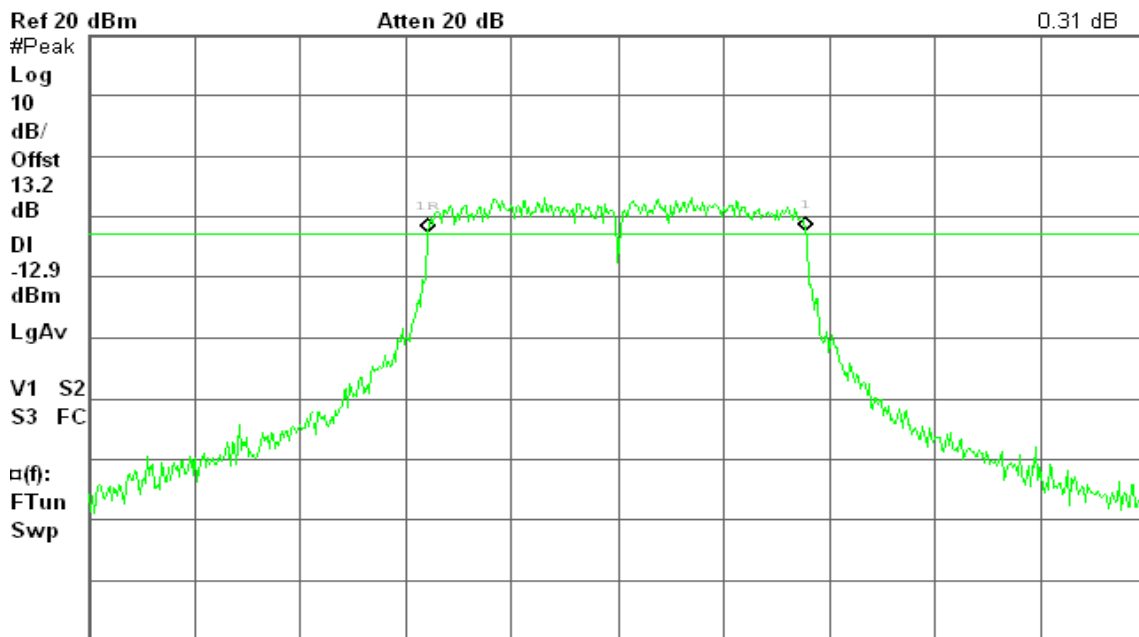

Center 2.437 00 GHz Span 50 MHz
#Res BW 100 kHz #VBW 100 kHz Sweep 6.04 ms (601 pts)



6dB Bandwidth (CH High)

Agilent 14:41:55 Dec 16, 2010

R T

Δ Mkr1 17.75 MHz
2.74 dB

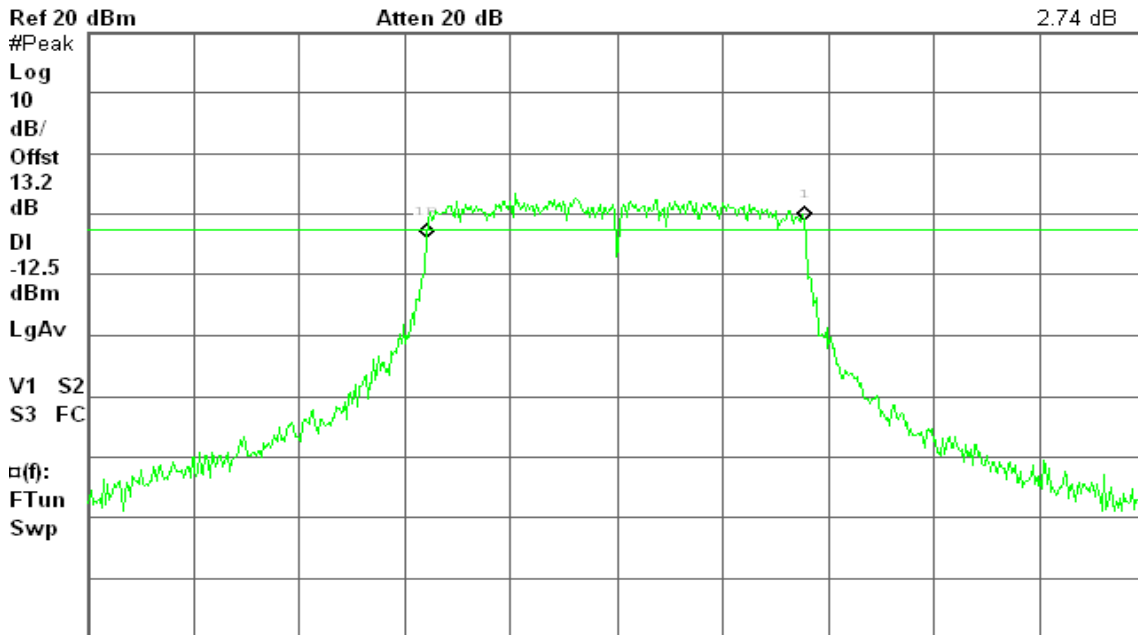

IEEE 802.11n HT 40 MHz mode

6dB Bandwidth (CH Low)

Agilent 14:46:17 Dec 16, 2010

R T

Δ Mkr1 36.42 MHz
2.40 dB

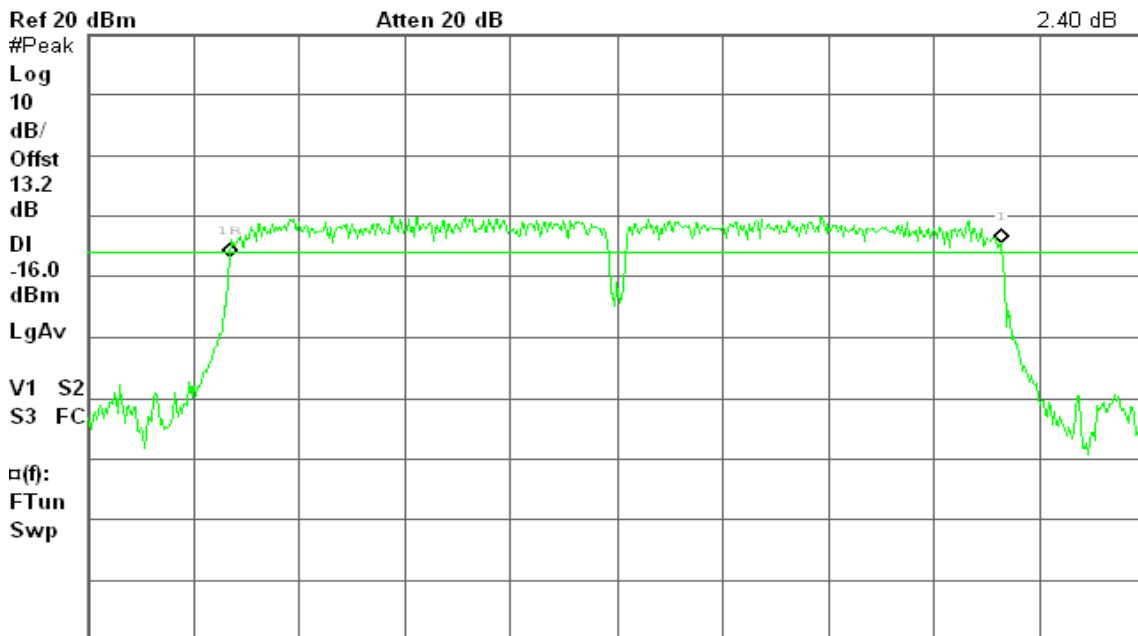



6dB Bandwidth (CH Mid)

Agilent 14:52:20 Dec 16, 2010

R T

Δ Mkr1 36.42 MHz
0.80 dB

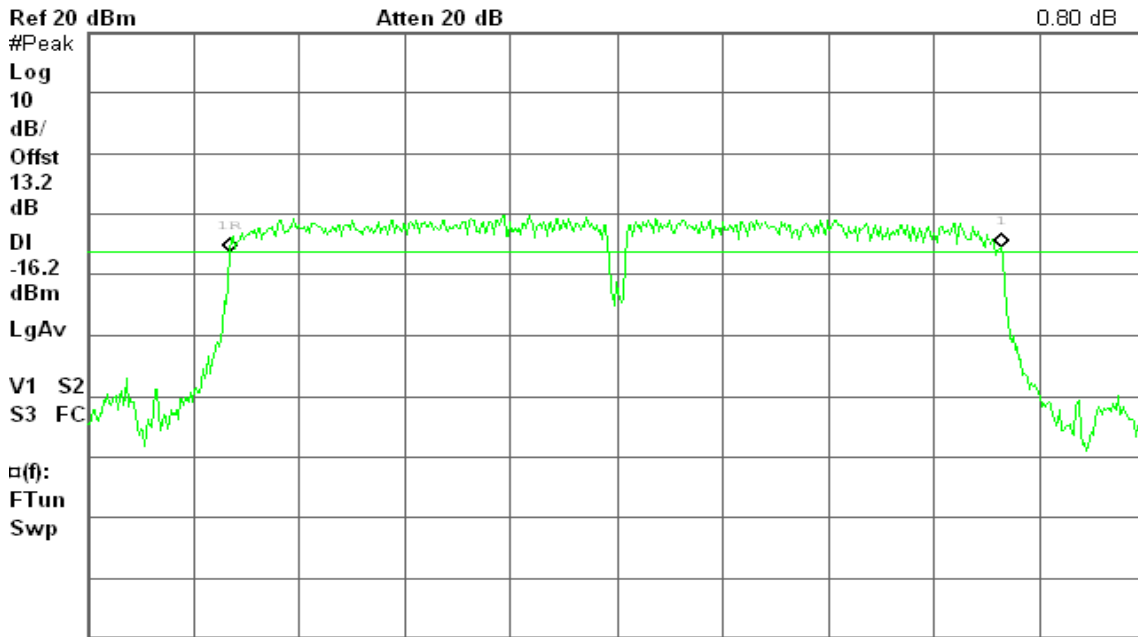

Center 2.437 00 GHz

Span 50 MHz

#Res BW 100 kHz

#VBW 100 kHz

Sweep 6.04 ms (601 pts)

6dB Bandwidth (CH High)

Agilent 14:56:27 Dec 16, 2010

R T

Δ Mkr1 36.42 MHz
0.66 dB

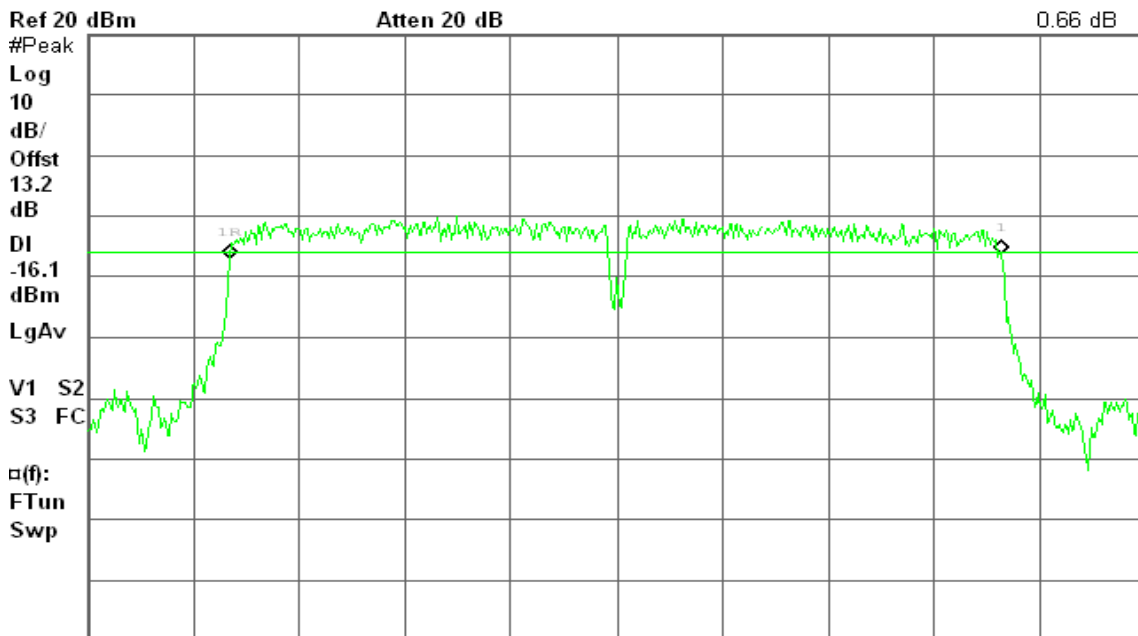

Center 2.452 00 GHz

Span 50 MHz

#Res BW 100 kHz

#VBW 100 kHz

Sweep 6.04 ms (601 pts)



7.2 PEAK POWER

LIMIT

The maximum peak output power of the intentional radiator shall not exceed the following:

1. According to §15.247(b)(3), for systems using digital modulation in the bands of 902-928 MHz, 2400-2483.5 MHz, and 5725-5850 MHz: 1 Watt.
2. According to §15.247(b)(4), the conducted output power limit specified in paragraph (b) of this section is based on the use of antennas with directional gains that do not exceed 6 dBi. Except as shown in paragraph (c) of this section, if transmitting antennas of directional gain greater than 6 dBi are used, the conducted output power from the intentional radiator shall be reduced below the stated values in paragraphs (b)(1), (b)(2), and (b)(3) of this section, as appropriate, by the amount in dB that the directional gain of the antenna exceeds 6 dBi.

Test Configuration

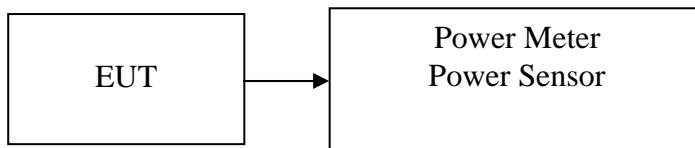

TEST PROCEDURE

The transmitter output is connected to the Power Meter. The Power Meter is set to the peak power detection.



Test Data

Test mode: IEEE 802.11b mode

Channel	Frequency (MHz)	Output Power (dBm)	Output Power (W)	Limit (W)	Result
Low	2412	16.58	0.0455	1.00	PASS
Mid	2437	19.08	0.0809		PASS
High	2462	17.38	0.0547		PASS

Test mode: IEEE 802.11g mode

Channel	Frequency (MHz)	Output Power (dBm)	Output Power (W)	Limit (W)	Result
Low	2412	18.67	0.0736	1.00	PASS
Mid	2437	18.34	0.0682		PASS
High	2462	18.01	0.0632		PASS

Test mode: IEEE 802.11n HT 20 MHz mode

Channel	Frequency (MHz)	Output Power (dBm)	Output Power (W)	Limit (W)	Result
Low	2412	18.84	0.0766	1.00	PASS
Mid	2437	18.48	0.0705		PASS
High	2462	18.11	0.0647		PASS

Test mode: IEEE 802.11n HT 40 MHz mode

Channel	Frequency (MHz)	Output Power (dBm)	Output Power (W)	Limit (W)	Result
Low	2422	18.16	0.0655	1.00	PASS
Mid	2437	17.94	0.0622		PASS
High	2452	17.87	0.0612		PASS



7.3 AVERAGE POWER

LIMIT

None; for reporting purposes only.

Test Configuration

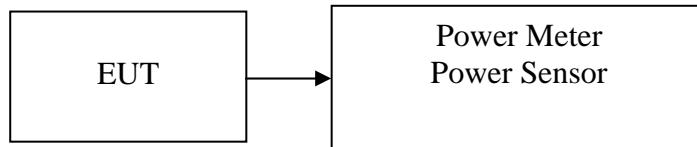

TEST PROCEDURE

The transmitter output is connected to the Power Meter. The Power Meter is set to the peak power detection.



TEST RESULTS

No non-compliance noted

Test Data

Test mode: IEEE 802.11b mode

Channel	Frequency (MHz)	Output Power (dBm)	Output Power (W)
Low	2412	14.26	0.0267
Mid	2437	17.5	0.0562
High	2462	15.31	0.0340

Test mode: IEEE 802.11g mode

Channel	Frequency (MHz)	Output Power (dBm)	Output Power (W)
Low	2412	9.12	0.0082
Mid	2437	8.79	0.0076
High	2462	8.51	0.0071

Test mode: IEEE 802.11n HT 20 MHz mode

Channel	Frequency (MHz)	Output Power (dBm)	Output Power (W)
Low	2412	9.12	0.0082
Mid	2437	8.73	0.0075
High	2462	8.43	0.0070

Test mode: IEEE 802.11n HT 40 MHz mode

Channel	Frequency (MHz)	Output Power (dBm)	Output Power (W)
Low	2422	8.38	0.0069
Mid	2437	8.17	0.0066
High	2452	8.13	0.0065



7.4 BAND EDGES MEASUREMENT

LIMIT

According to §15.247(d), in any 100 kHz bandwidth outside the frequency bands in which the spread spectrum intentional radiator is operating, the radio frequency power that is produced by the intentional radiator shall be at least 20 dB below that in the 100 kHz bandwidth within the band that contains the highest level of the desired power, based on either an RF conducted or a radiated measurement, provided the transmitter demonstrates compliance with the peak conducted power limits. In addition, radiated emissions which fall in the restricted bands, as defined in §15.205(a), must also comply with the radiated emission limits specified in 15.209(a) (see Section 15.205(c)).

Test Configuration

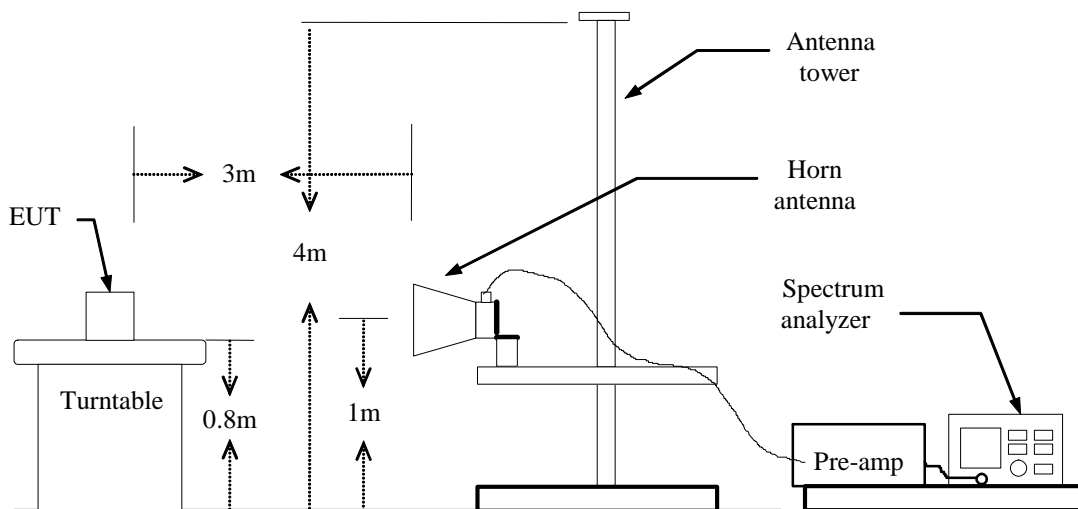

TEST PROCEDURE

1. The EUT is placed on a turntable, which is 0.8m above the ground plane.
2. The turntable shall be rotated for 360 degrees to determine the position of maximum emission level.
3. EUT is set 3m away from the receiving antenna, which is varied from 1m to 4m to find out the highest emission.
4. Set the spectrum analyzer in the following setting in order to capture the lower and upper band-edges of the emission:
 - (a) PEAK: RBW=VBW=1MHz / Sweep=AUTO
 - (b) AVERAGE: RBW=1MHz / VBW=10Hz / Sweep=AUTO
5. Repeat the procedures until all the PEAK and AVERAGE versus POLARIZATION are measured.

TEST RESULTS

Refer to attach spectrum analyzer data chart.



Band Edges (IEEE 802.11b mode / CH Low)

Detector mode: Peak

Polarity: Vertical

Agilent 16:06:07 Nov 23, 2010

R T

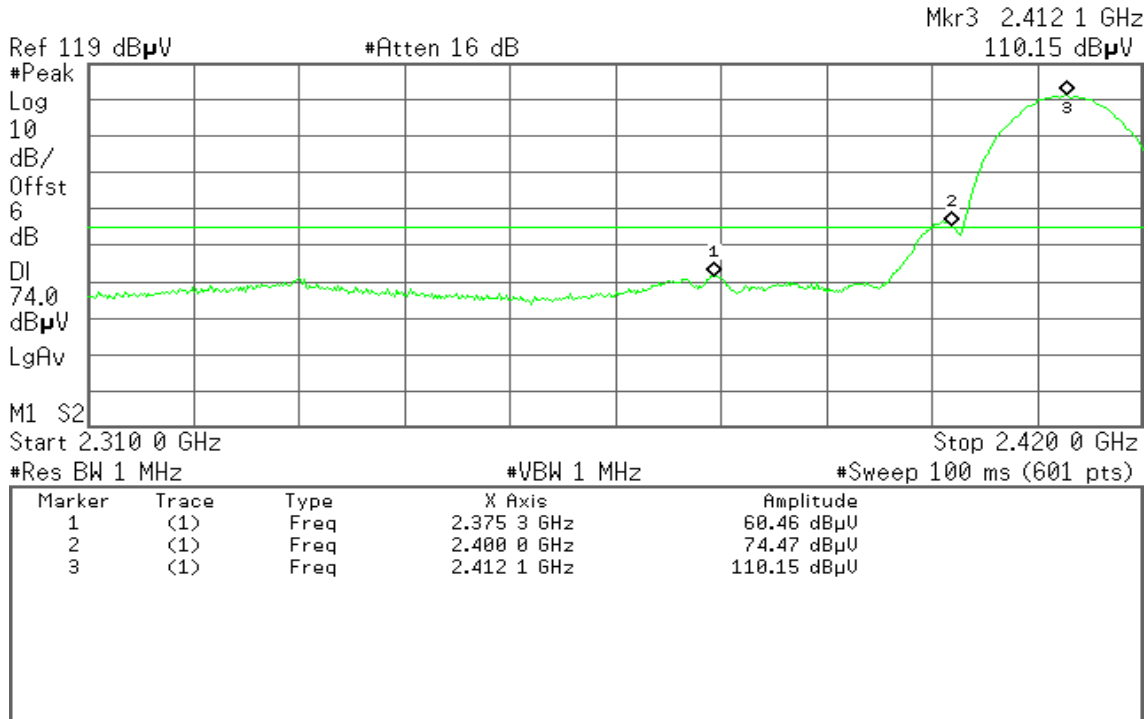

Detector mode: Average

Polarity: Vertical

Agilent 16:05:29 Nov 23, 2010

R T

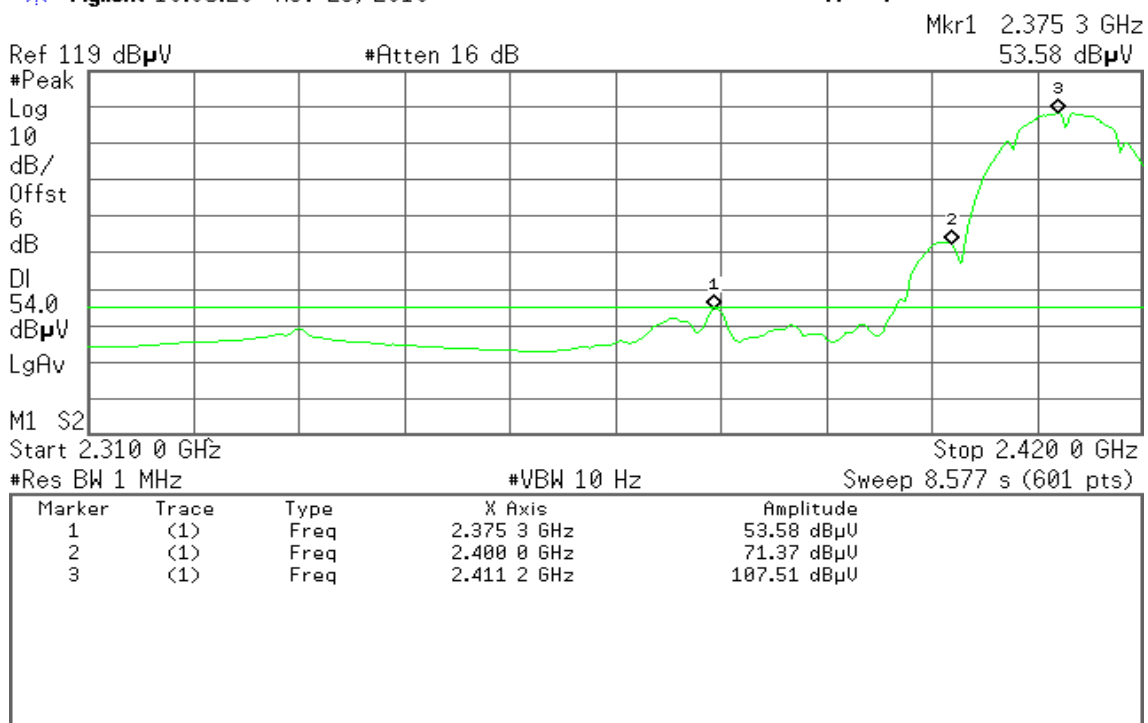



Detector mode: Peak

Polarity: Horizontal

Agilent 16:10:58 Nov 23, 2010

R T

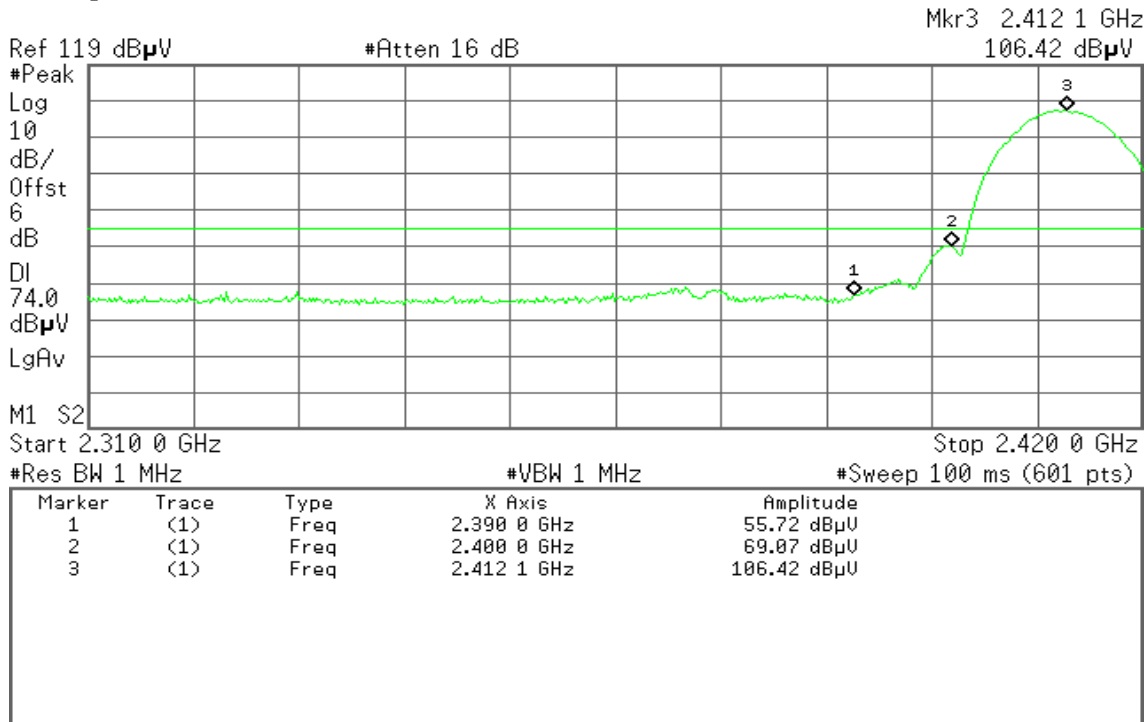

Detector mode: Average

Polarity: Horizontal

Agilent 16:11:29 Nov 23, 2010

R T

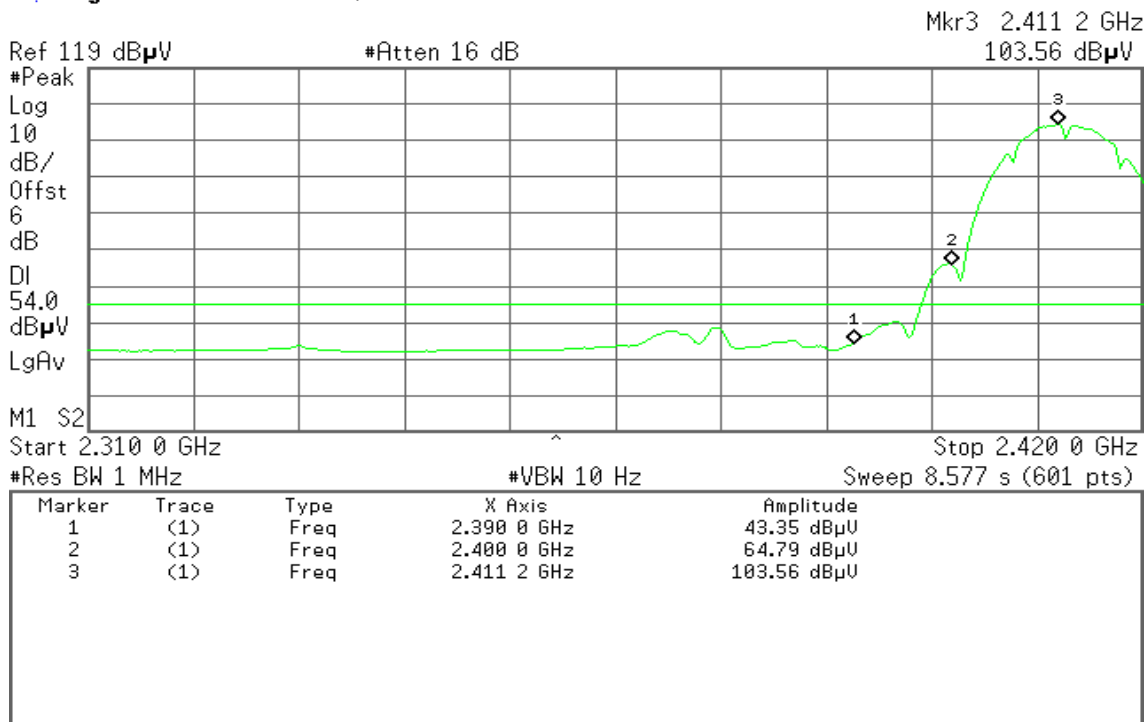



Band Edges (IEEE 802.11b mode / CH High)

Detector mode: Peak

Polarity: Vertical

Agilent 16:17:53 Nov 23, 2010

R T

Mkr1 2.483 50 GHz
58.25 dB μ V

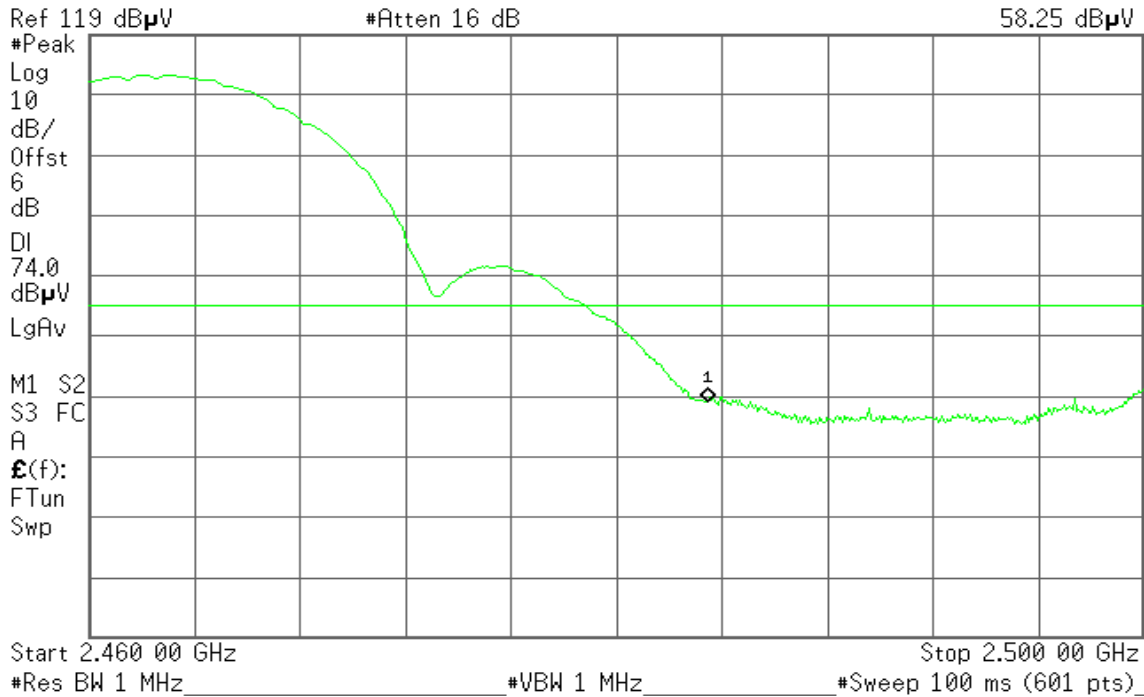

Detector mode: Average

Polarity: Vertical

Agilent 16:17:23 Nov 23, 2010

R T

Mkr1 2.483 50 GHz
48.58 dB μ V

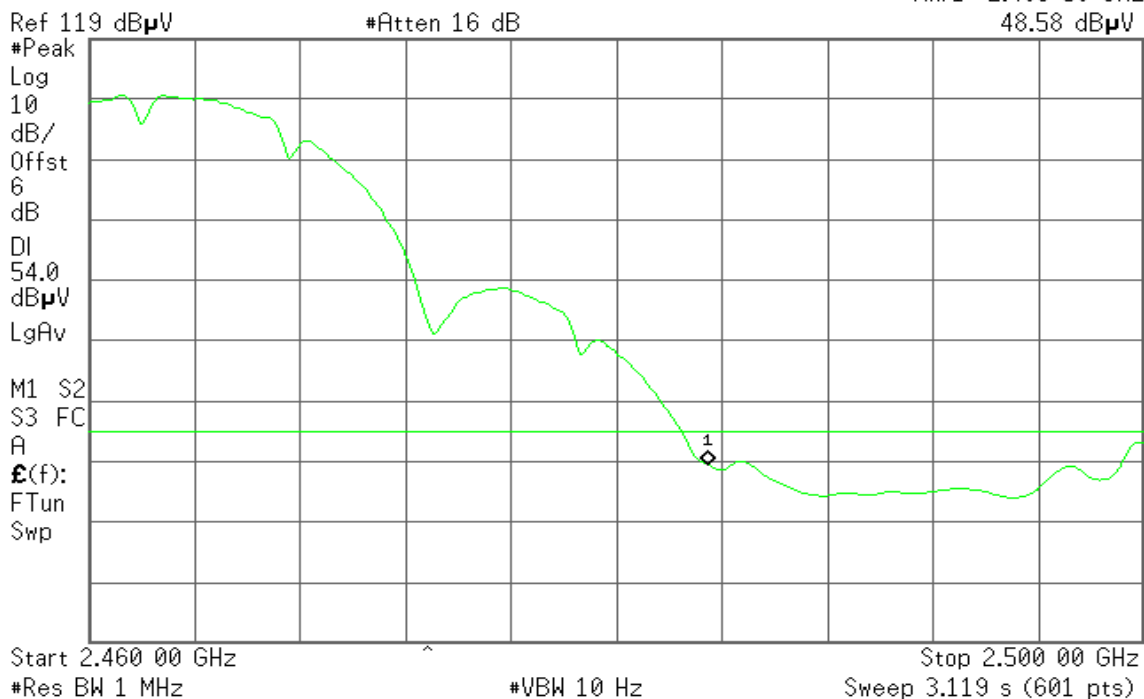



Detector mode: Peak

Polarity: Horizontal

Agilent 16:21:54 Nov 23, 2010

R T

Mkr1 2.483 50 GHz
55.62 dB μ V

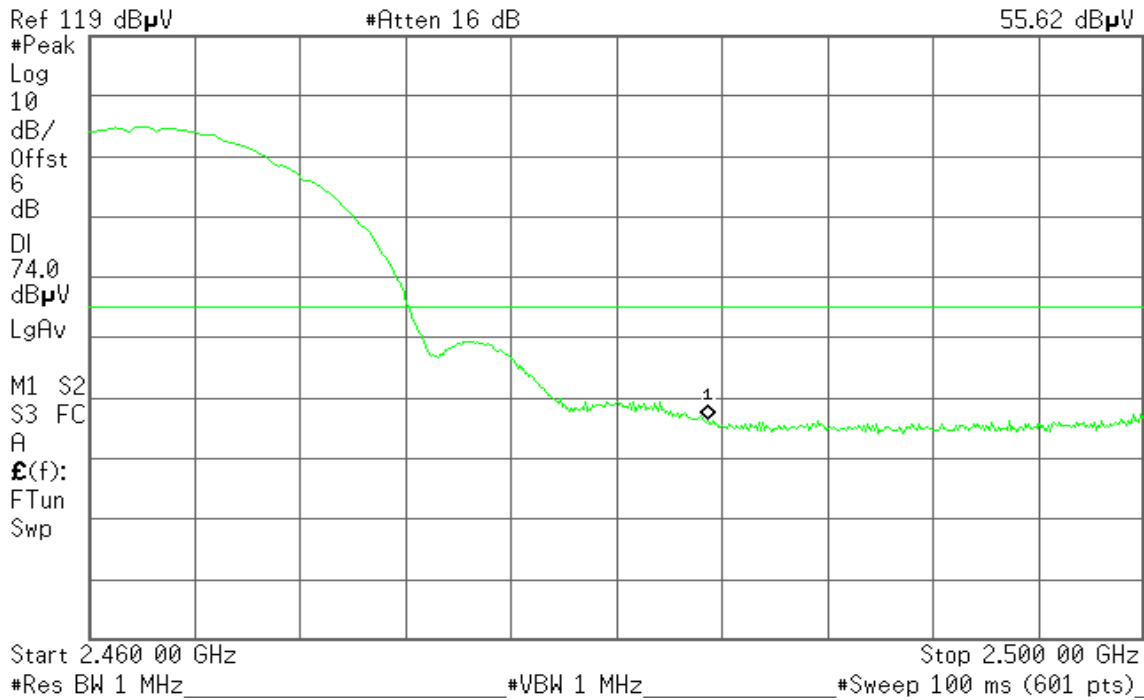

Detector mode: Average

Polarity: Horizontal

Agilent 16:22:18 Nov 23, 2010

R T

Mkr1 2.483 50 GHz
43.85 dB μ V

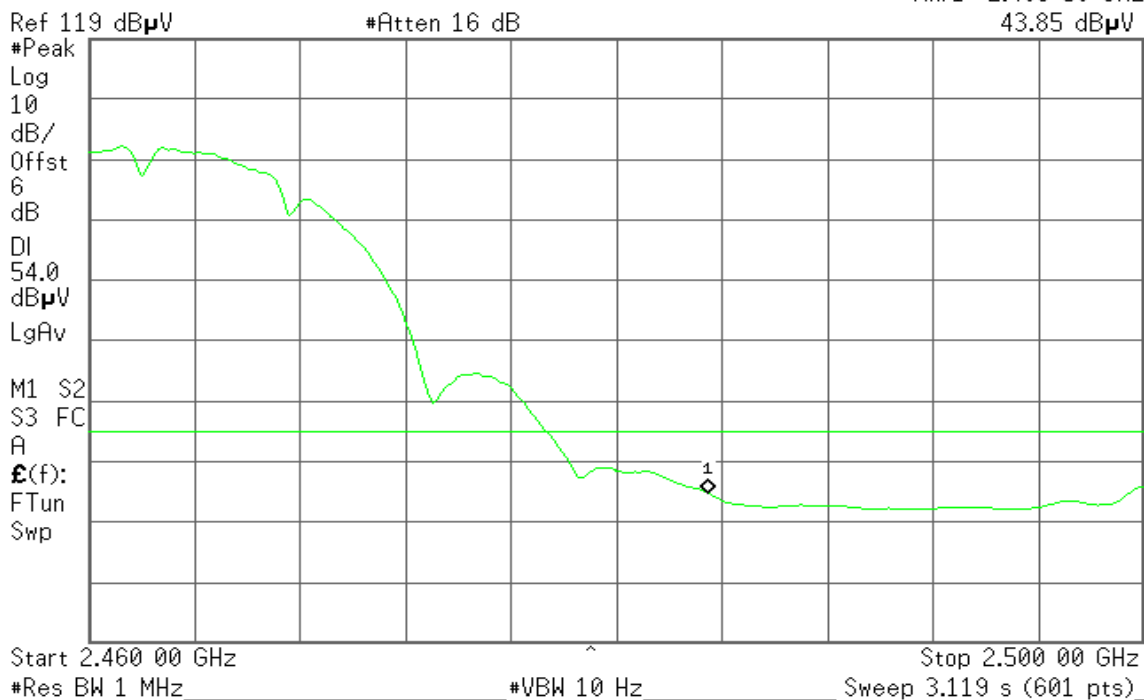



Band Edges (IEEE 802.11g mode / CH Low)

Detector mode: Peak

Polarity: Vertical

Agilent 16:40:24 Nov 23, 2010

R T

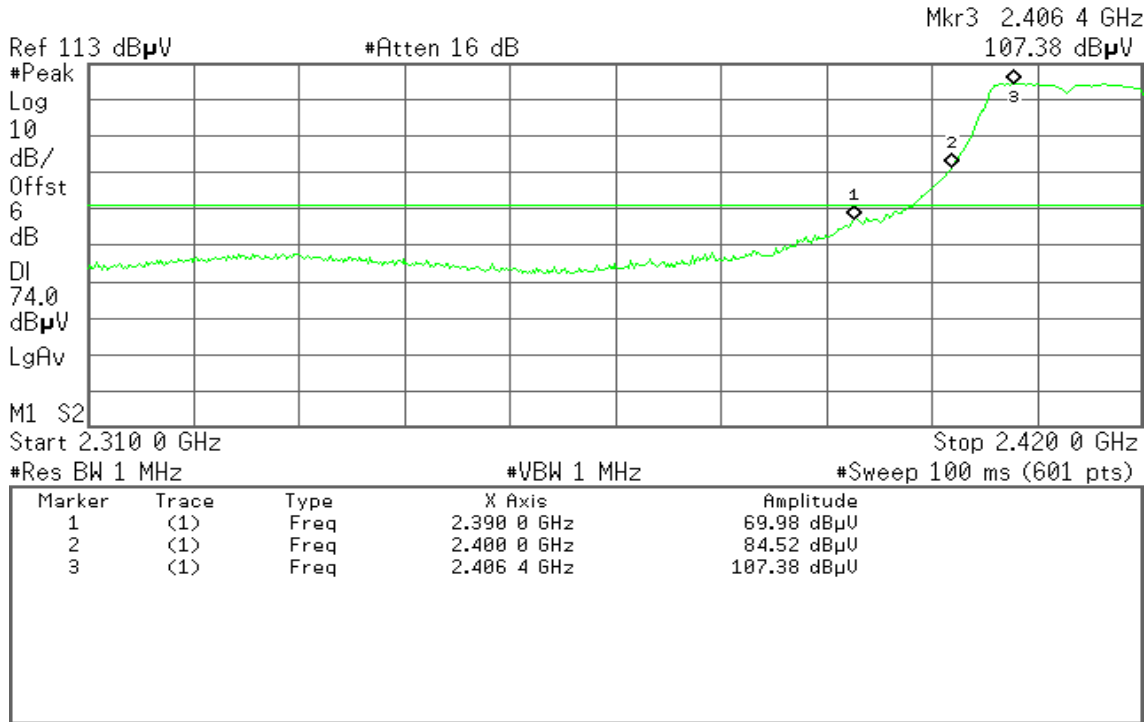

Detector mode: Average

Polarity: Vertical

Agilent 16:40:04 Nov 23, 2010

R T

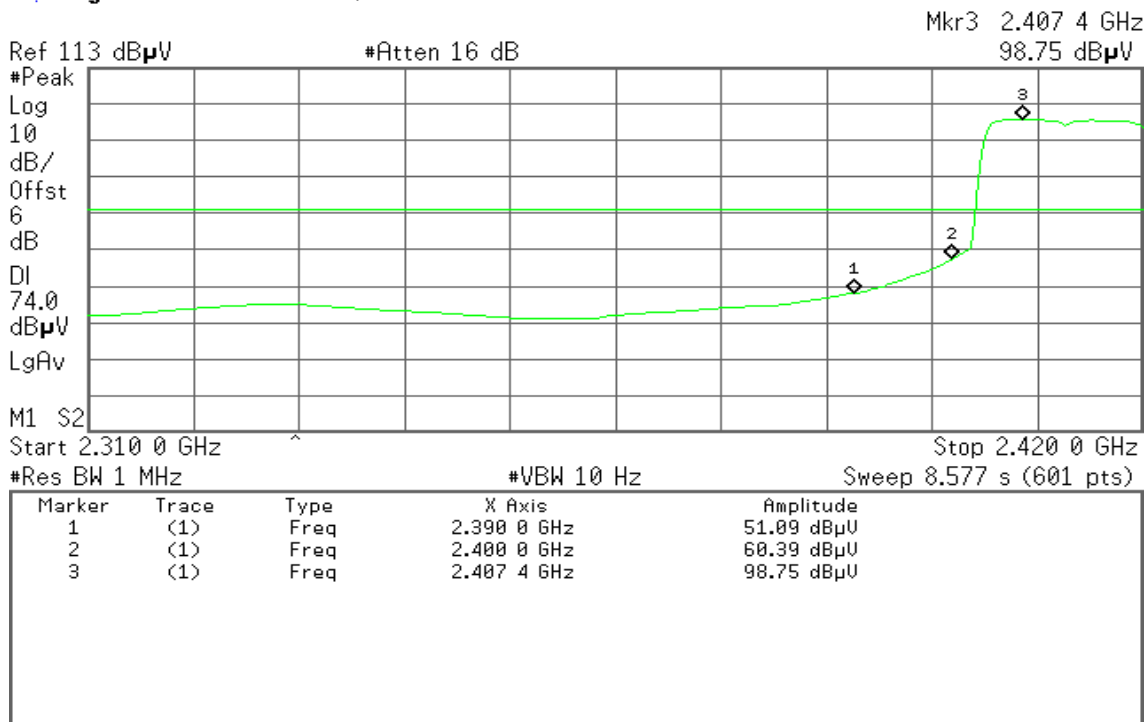



Detector mode: Peak

Polarity: Horizontal

Agilent 16:46:04 Nov 23, 2010

R T

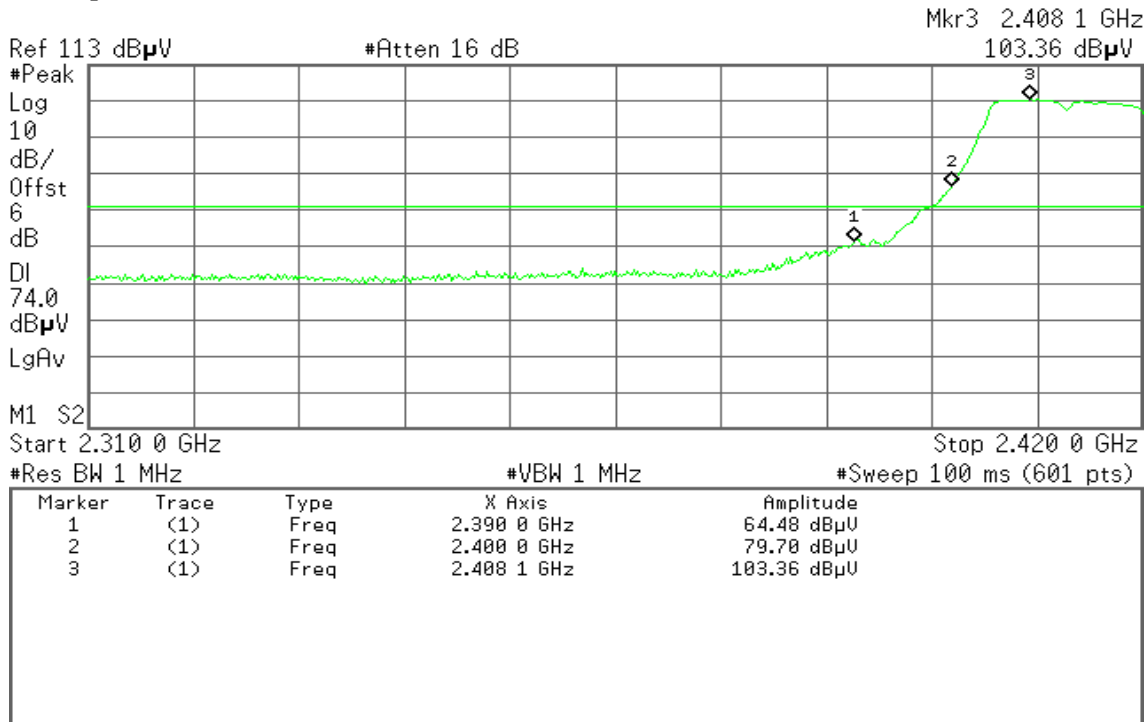

Detector mode: Average

Polarity: Horizontal

Agilent 16:46:37 Nov 23, 2010

R T

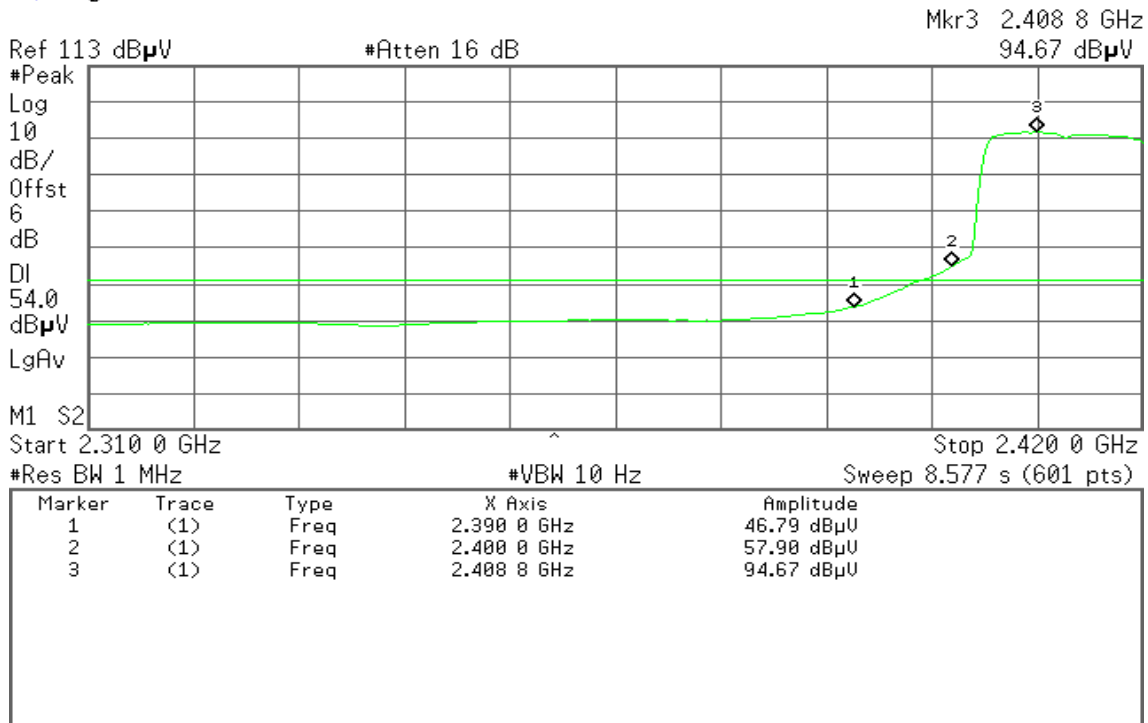



Band Edges (IEEE 802.11g mode / CH High)

Detector mode: Peak

Polarity: Vertical

Agilent 16:27:36 Nov 23, 2010

R T

Mkr1 2.483 50 GHz
67.22 dB μ V

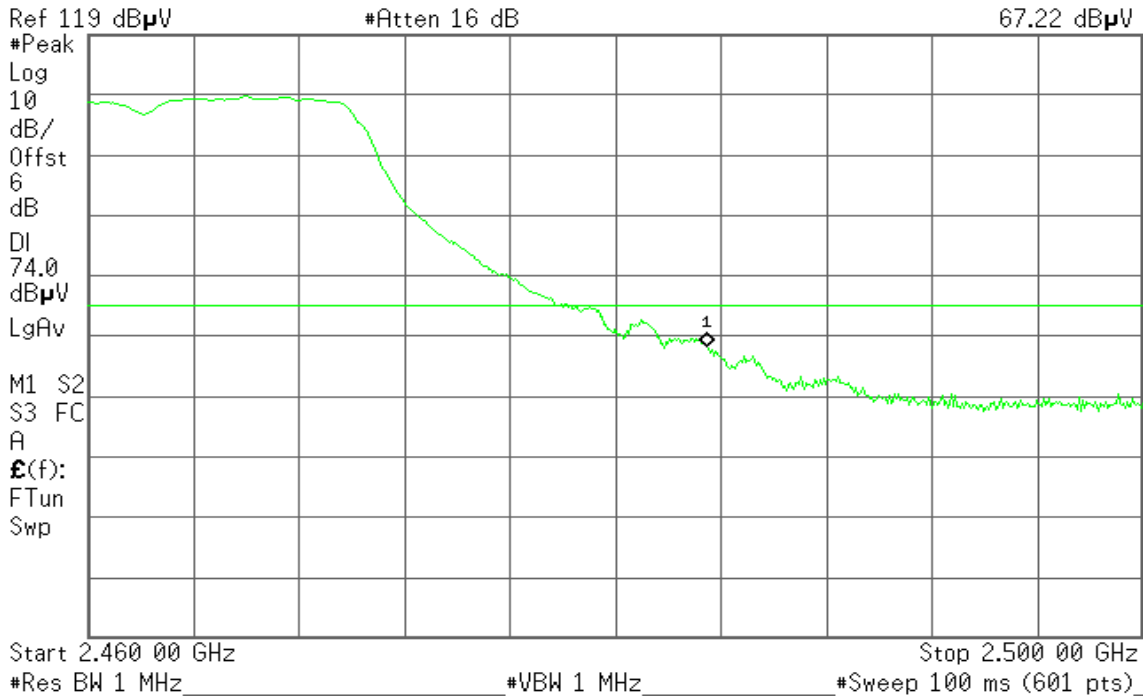

Detector mode: Average

Polarity: Vertical

Agilent 16:27:57 Nov 23, 2010

R T

Mkr1 2.483 50 GHz
50.10 dB μ V

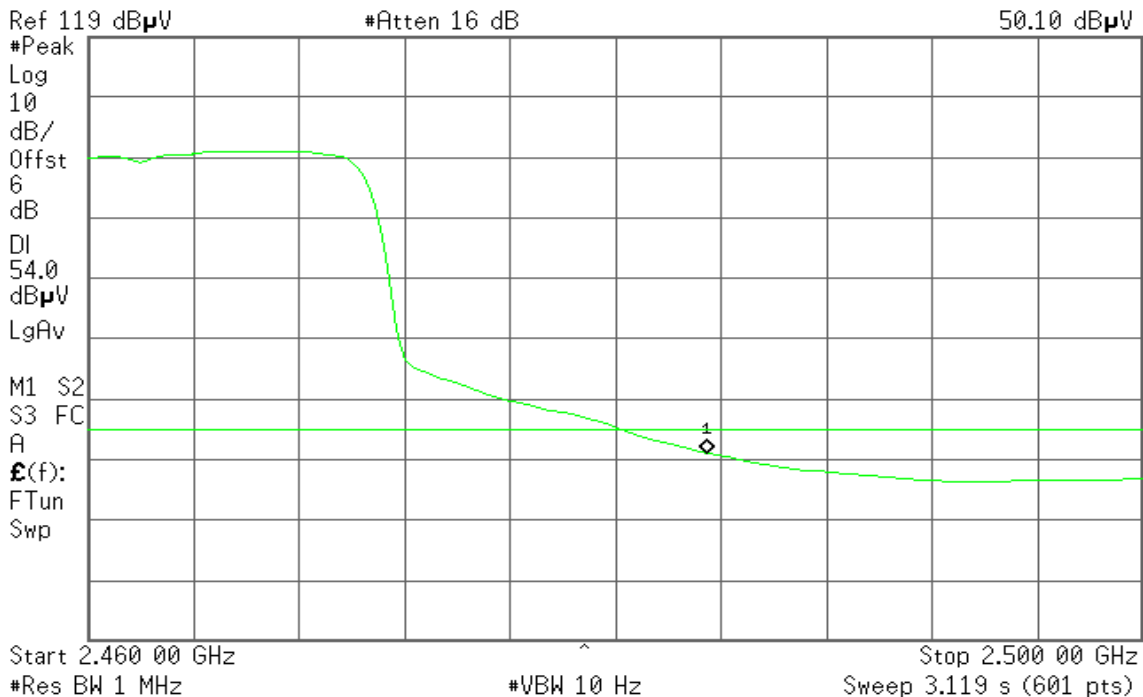



Detector mode: Peak

Polarity: Horizontal

Agilent 16:33:20 Nov 23, 2010

R T

Mkr1 2.483 50 GHz
59.78 dB μ V

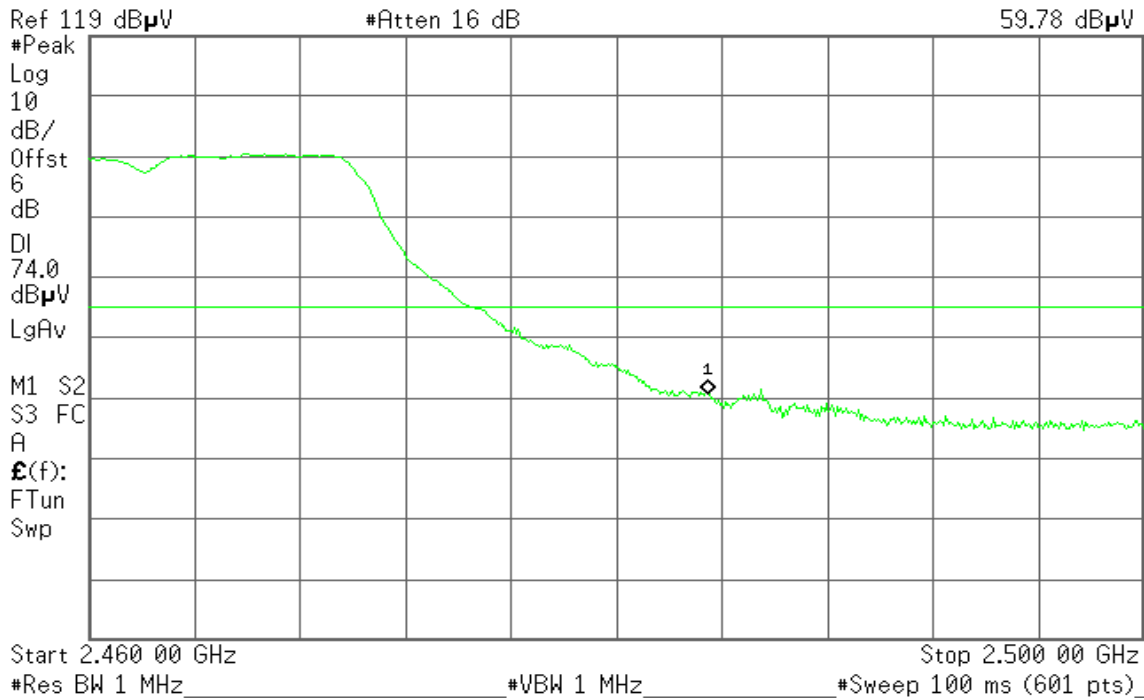

Detector mode: Average

Polarity: Horizontal

Agilent 16:33:42 Nov 23, 2010

R T

Mkr1 2.483 50 GHz
45.25 dB μ V

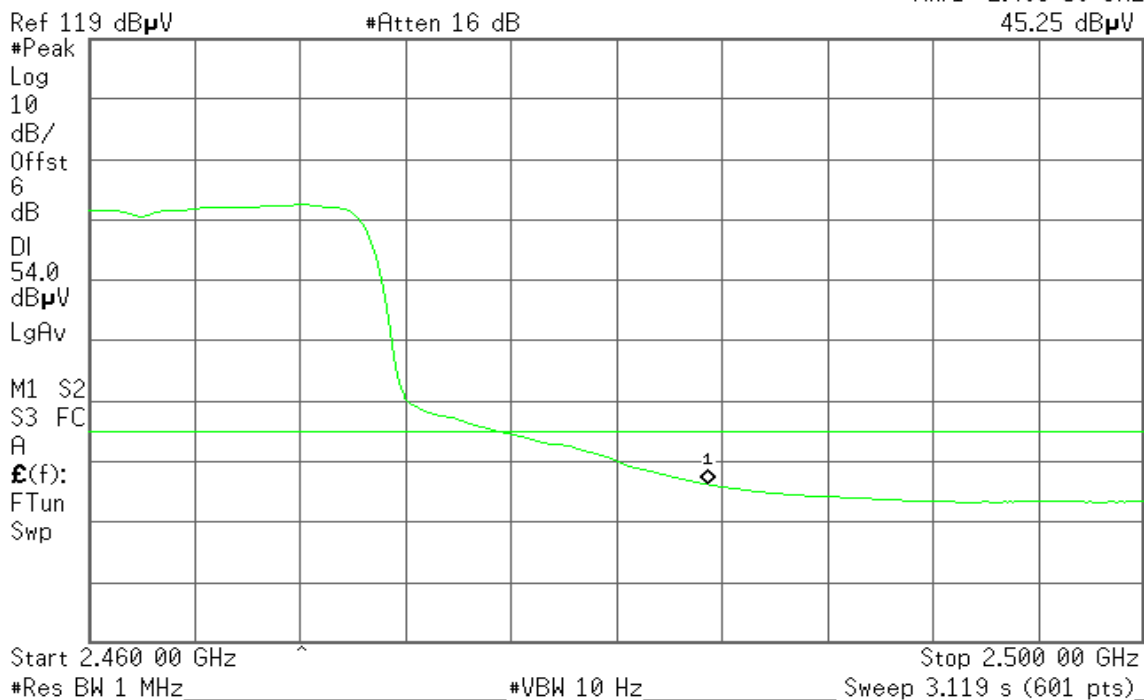



Band Edges (IEEE 802.11n HT 20 MHz mode / CH Low)

Detector mode: Peak

Polarity: Vertical

Agilent 17:26:55 Nov 24, 2010

R T

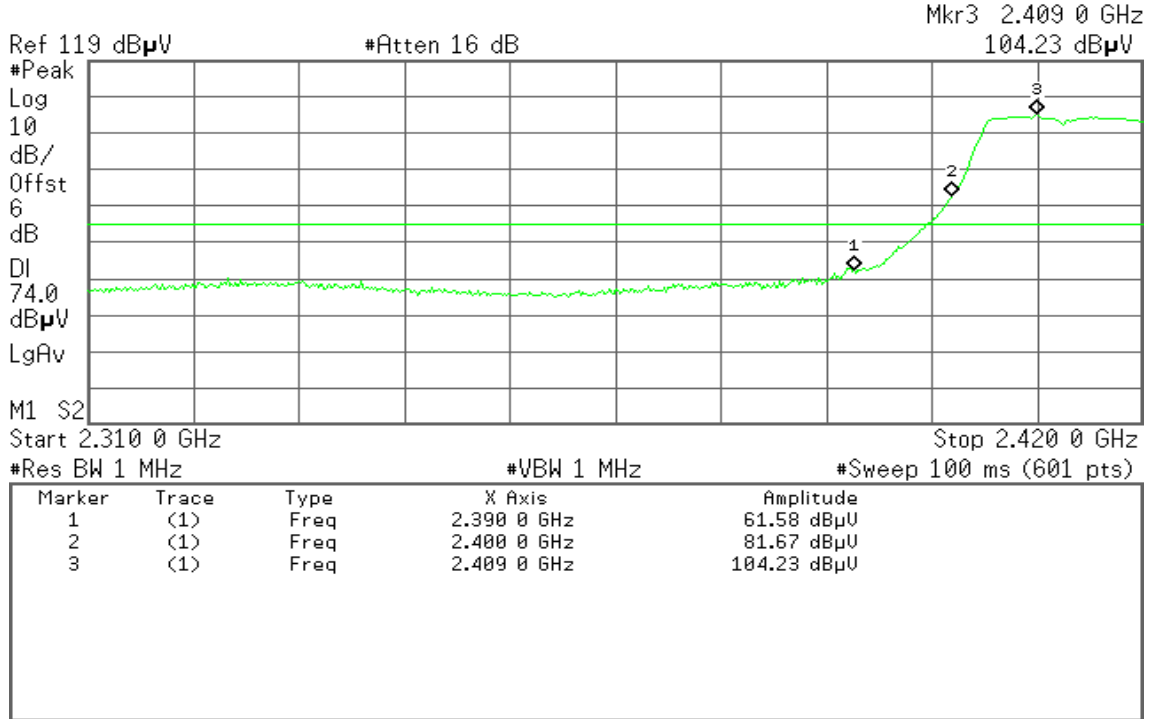

Detector mode: Average

Polarity: Vertical

Agilent 17:27:29 Nov 24, 2010

R T

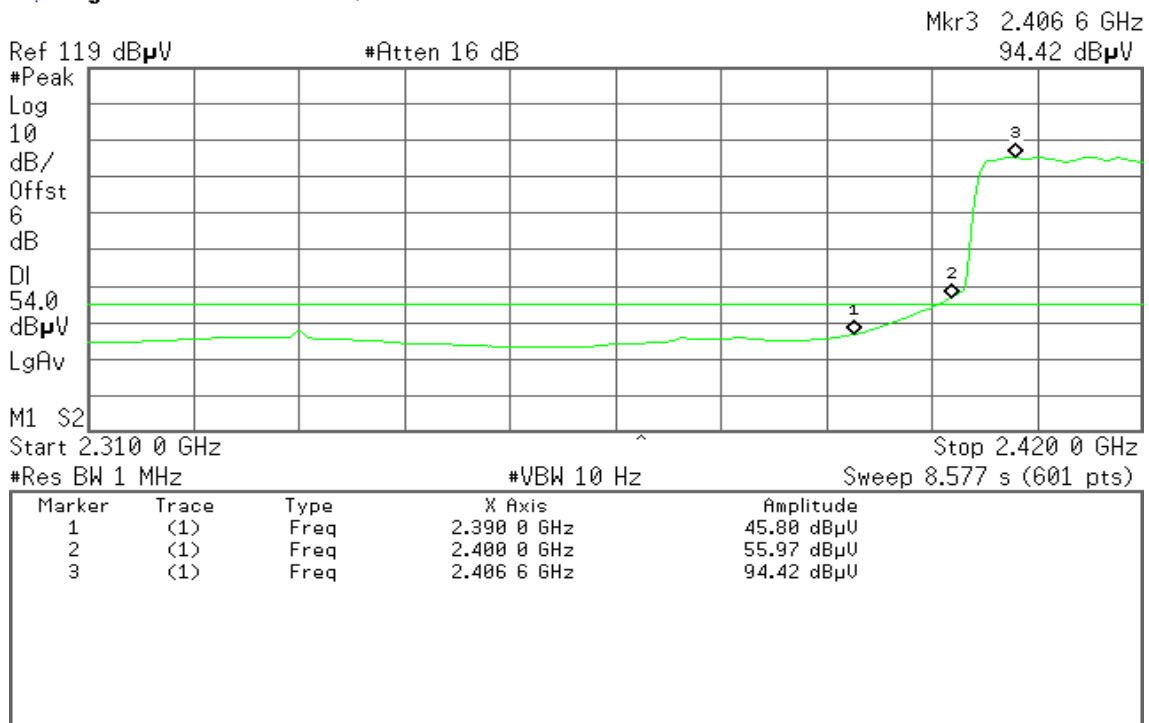



Detector mode: Peak

Polarity: Horizontal

Agilent 17:32:40 Nov 24, 2010

R T

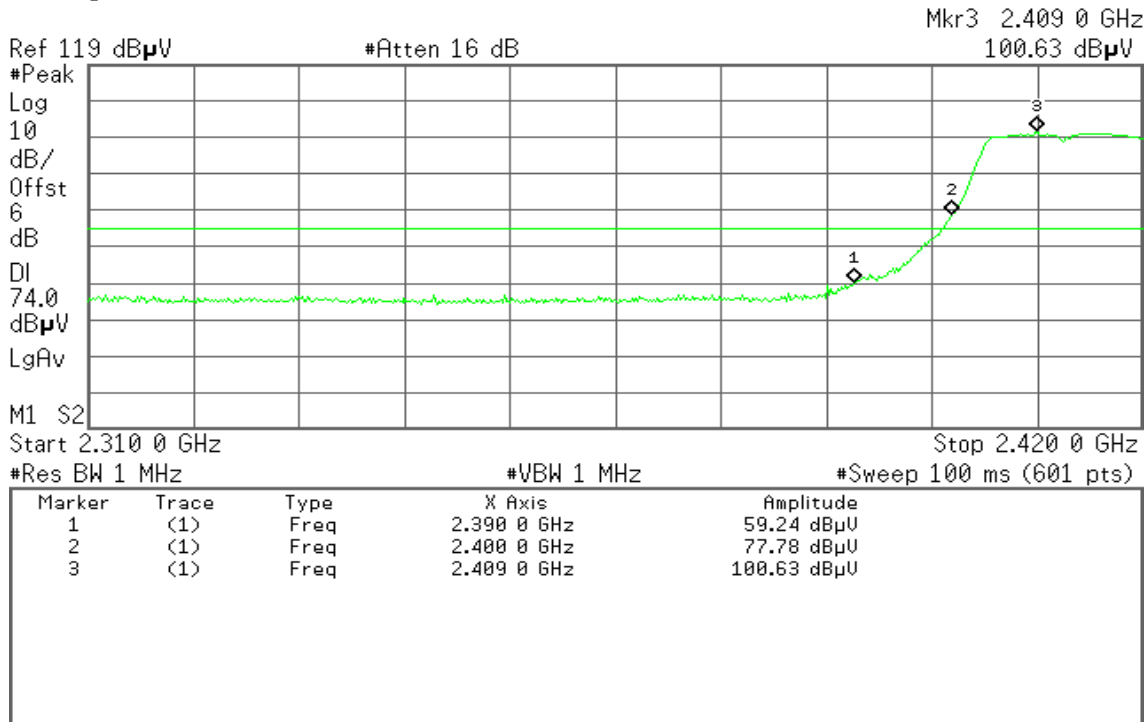

Detector mode: Average

Polarity: Horizontal

Agilent 17:33:13 Nov 24, 2010

R T

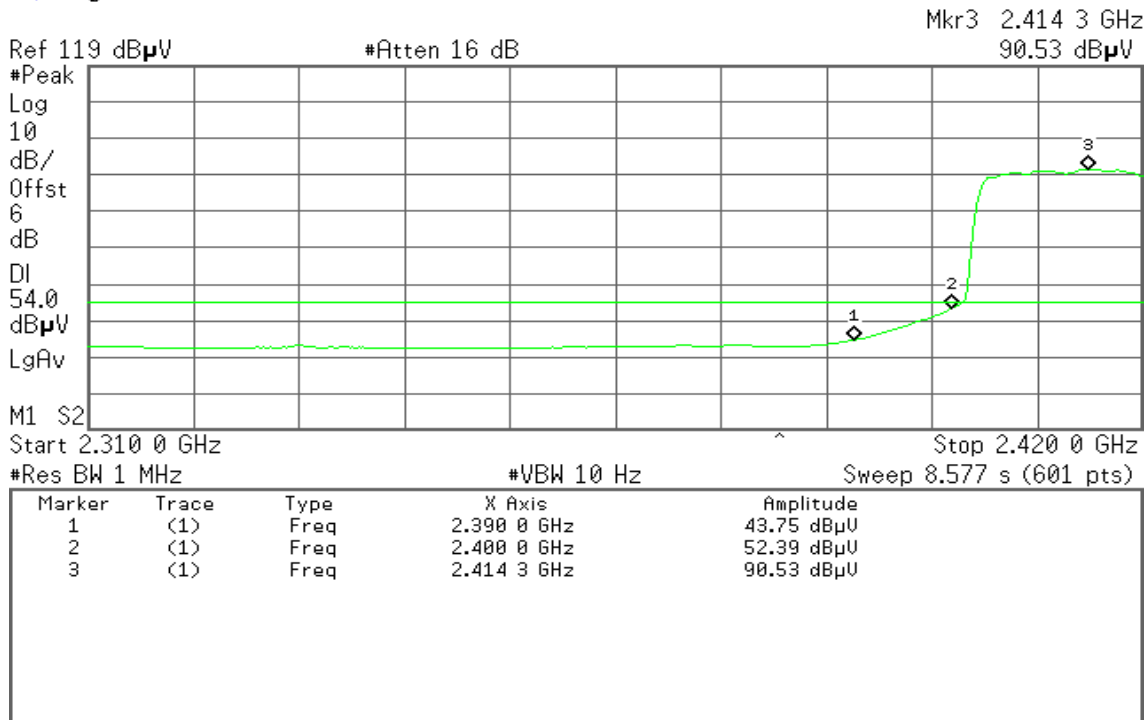



Band Edges (IEEE 802.11n HT 20 MHz mode / CH High)

Detector mode: Peak

Polarity: Vertical

Agilent 17:19:11 Nov 24, 2010

R T

Mkr1 2.483 50 GHz
62.77 dB μ V

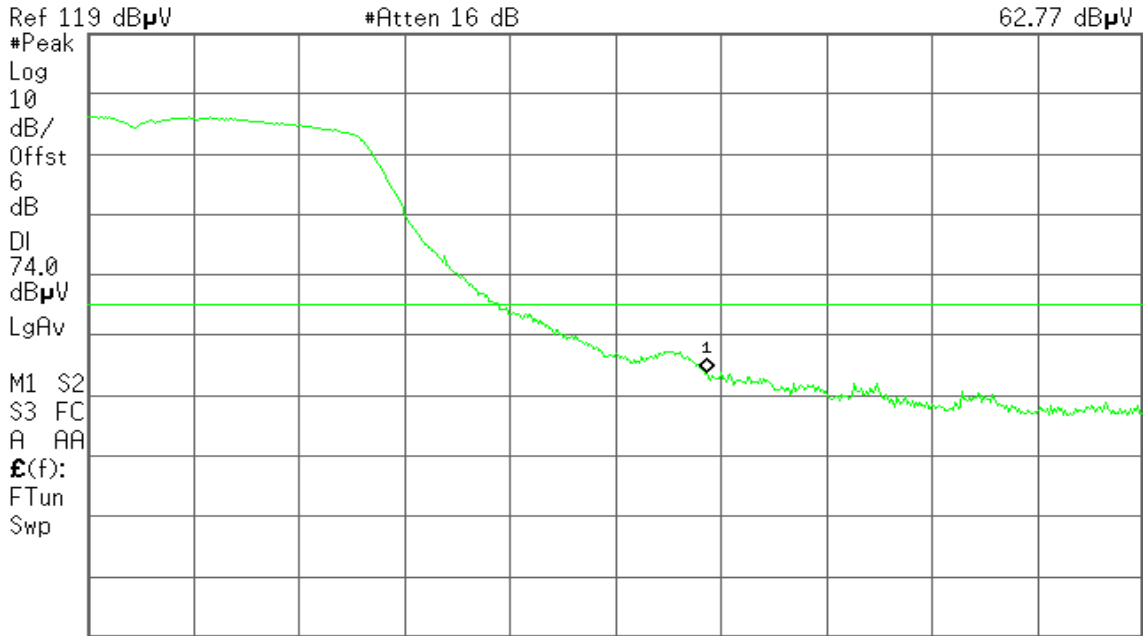

Start 2.460 00 GHz

Stop 2.500 00 GHz

#Res BW 1 MHz

#VBW 1 MHz

#Sweep 100 ms (601 pts)

Detector mode: Average

Polarity: Vertical

Agilent 17:19:36 Nov 24, 2010

R T

Mkr1 2.483 50 GHz
47.04 dB μ V

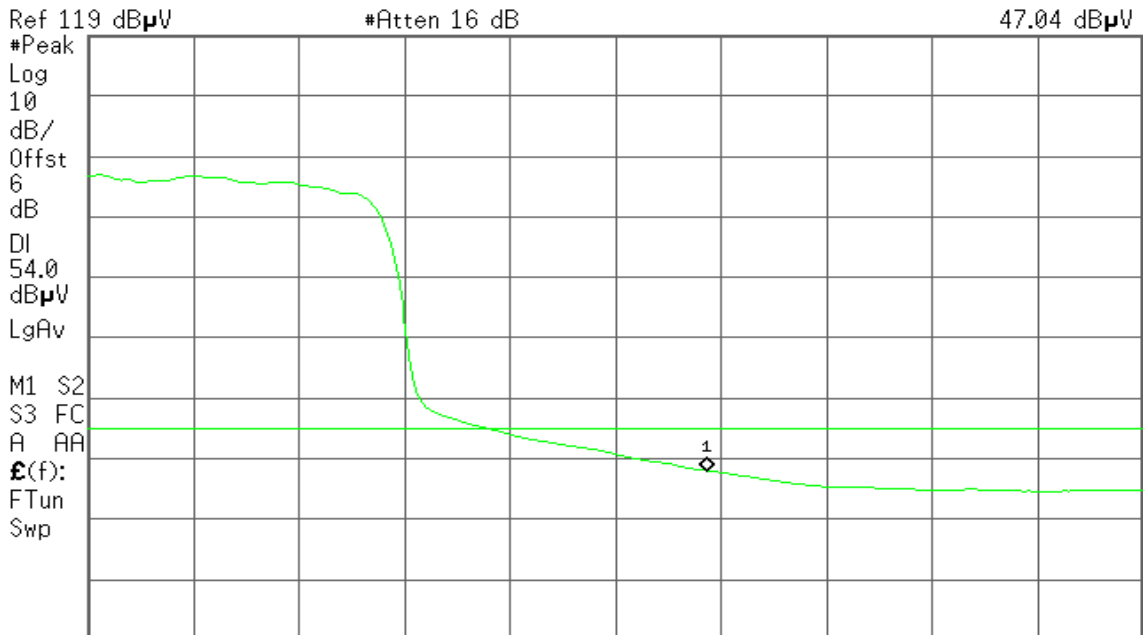

Start 2.460 00 GHz

Stop 2.500 00 GHz

#Res BW 1 MHz

#VBW 10 Hz

Sweep 3.119 s (601 pts)



Detector mode: Peak

Polarity: Horizontal

Agilent 17:15:06 Nov 24, 2010

R T

Mkr1 2.483 50 GHz
58.73 dB μ V

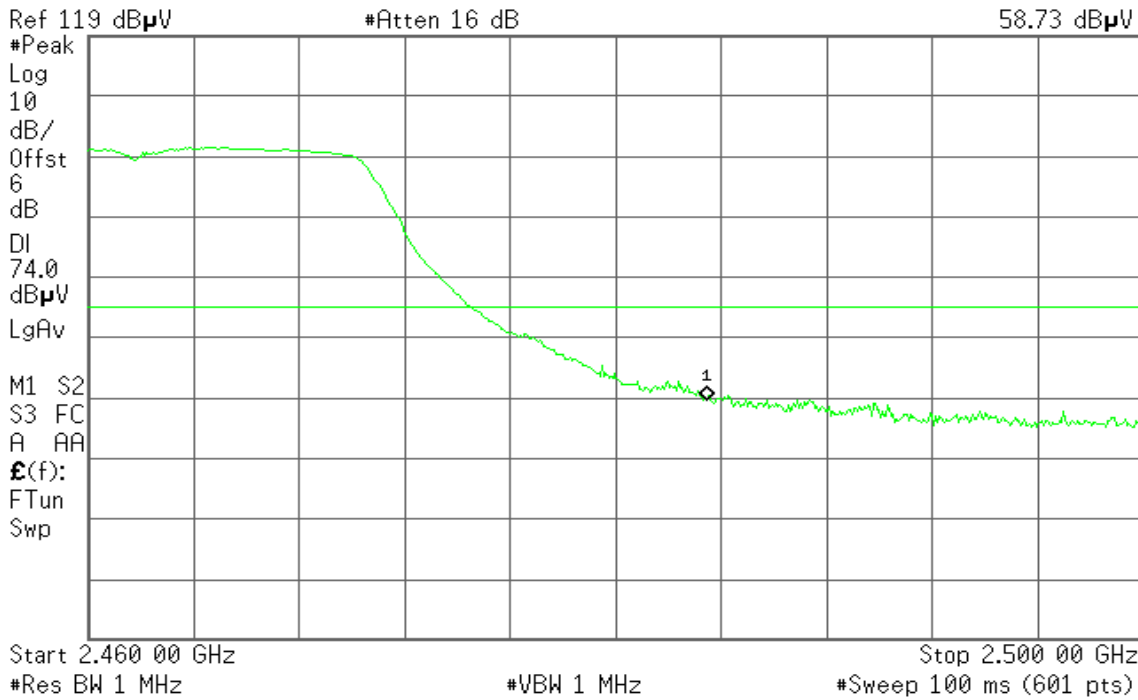

Detector mode: Average

Polarity: Horizontal

Agilent 17:15:30 Nov 24, 2010

R T

Mkr1 2.483 50 GHz
44.58 dB μ V

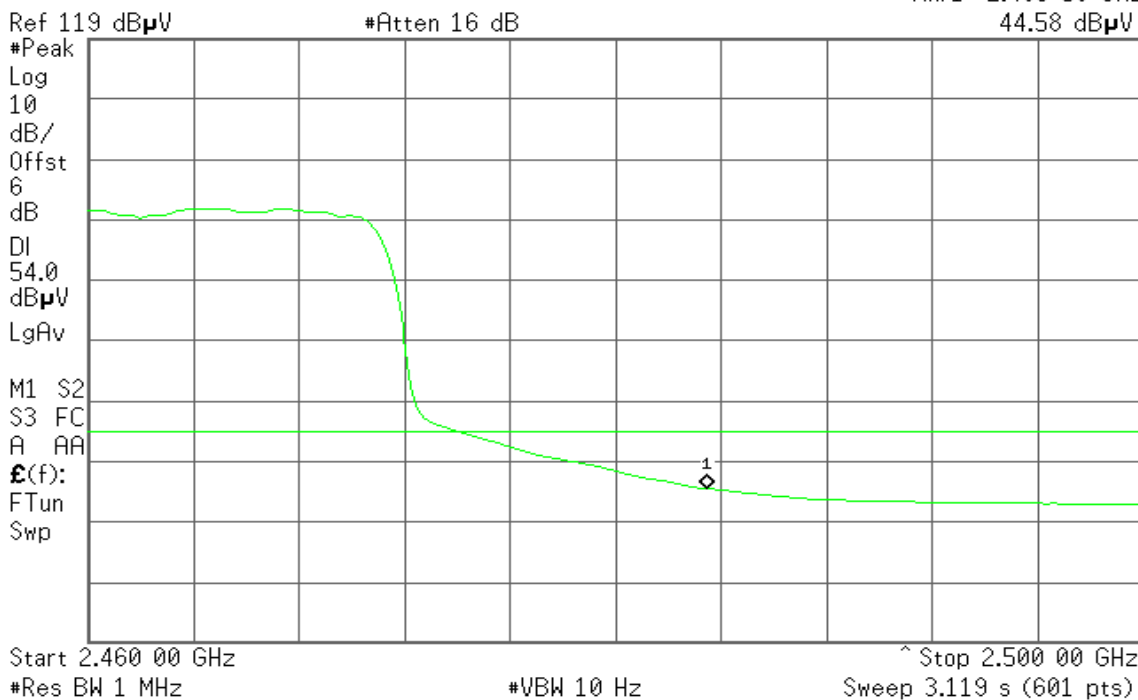



Band Edges (IEEE 802.11n HT 40 MHz mode / CH Low)

Detector mode: Peak

Polarity: Vertical

Agilent 17:41:55 Nov 24, 2010

R T

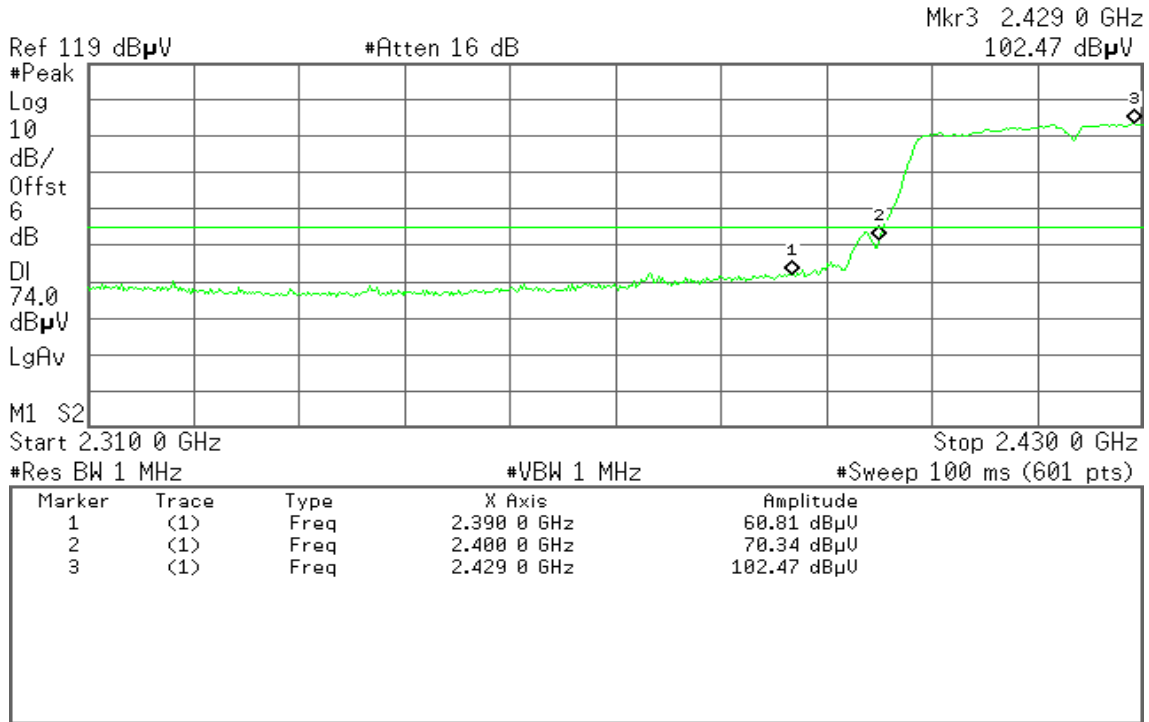

Detector mode: Average

Polarity: Vertical

Agilent 17:42:24 Nov 24, 2010

R T

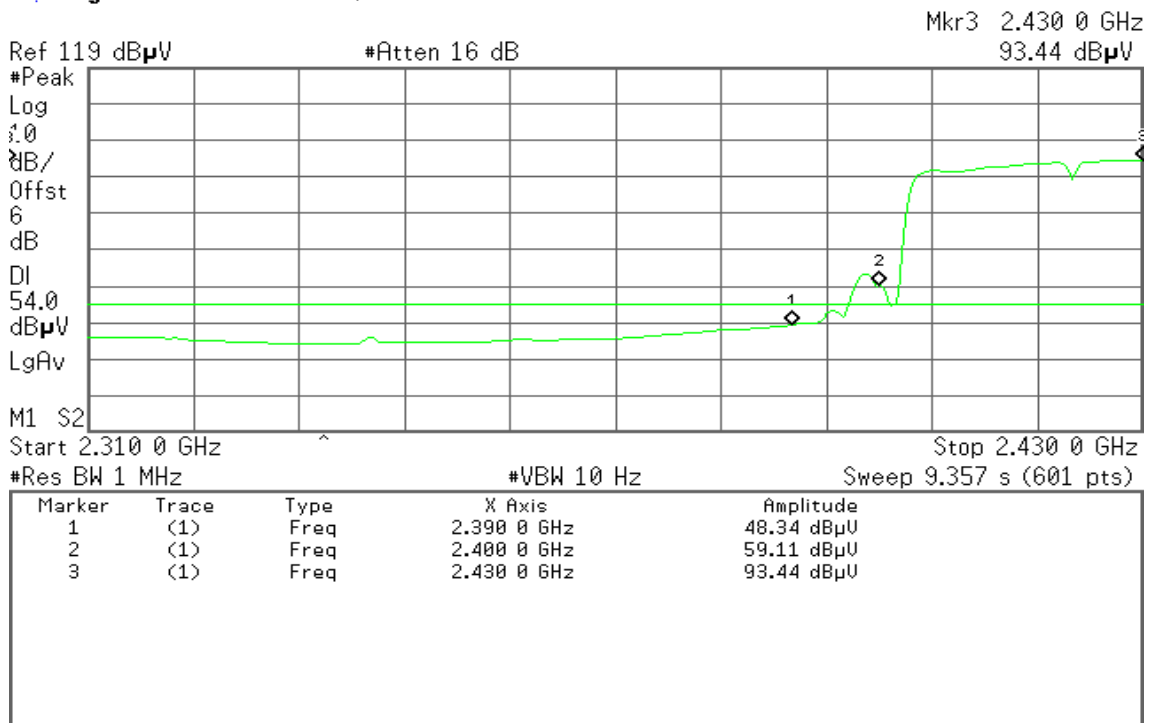



Detector mode: Peak

Polarity: Horizontal

Agilent 17:38:25 Nov 24, 2010

R T

Mkr3 2.412 2 GHz
96.41 dBµV

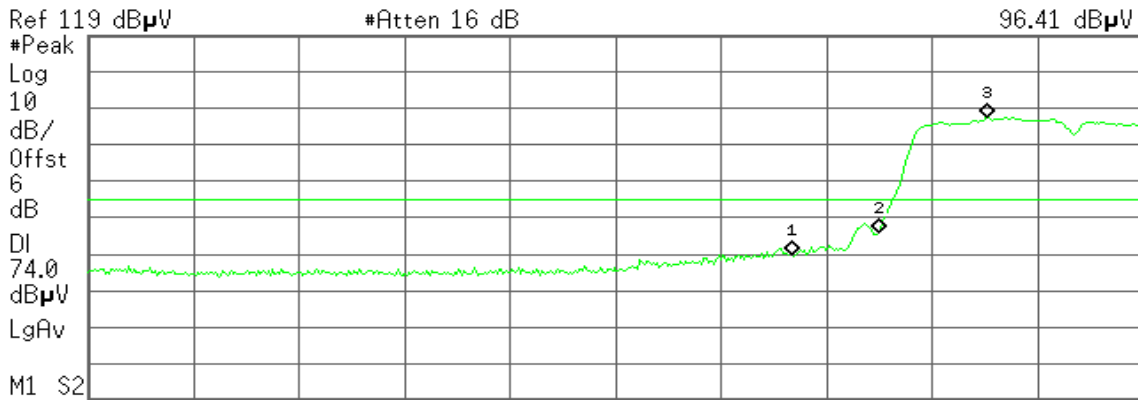

Start 2.310 0 GHz Stop 2.430 0 GHz
#Res BW 1 MHz #VBW 1 MHz #Sweep 100 ms (601 pts)

Marker	Trace	Type	X Axis	Amplitude
1	(1)	Freq	2.390 0 GHz	58.74 dBµU
2	(1)	Freq	2.400 0 GHz	64.96 dBµU
3	(1)	Freq	2.412 2 GHz	96.41 dBµU

Detector mode: Average

Polarity: Horizontal

Agilent 17:39:09 Nov 24, 2010

R T

Mkr3 2.413 2 GHz
87.28 dBµV

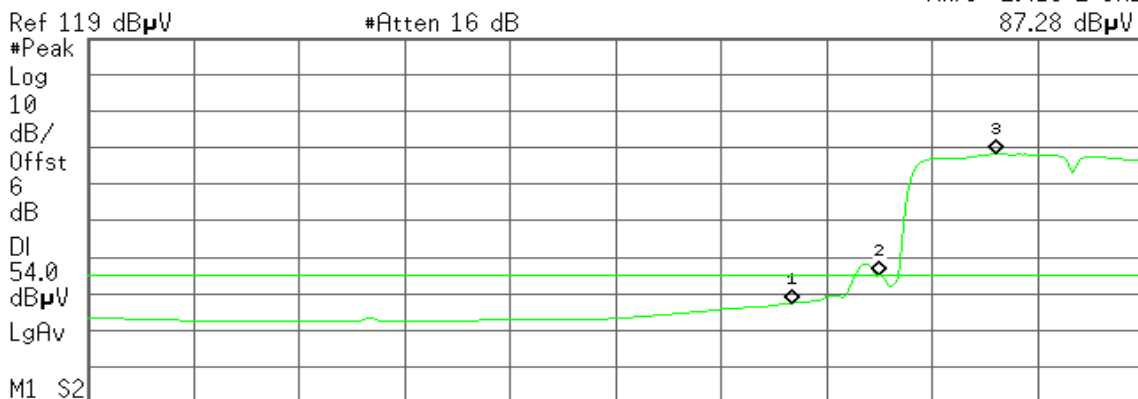

Start 2.310 0 GHz Stop 2.430 0 GHz
#Res BW 1 MHz #VBW 10 Hz Sweep 9.357 s (601 pts)

Marker	Trace	Type	X Axis	Amplitude
1	(1)	Freq	2.390 0 GHz	46.42 dBµU
2	(1)	Freq	2.400 0 GHz	53.94 dBµU
3	(1)	Freq	2.413 2 GHz	87.28 dBµU



Band Edges (IEEE 802.11n HT 40 MHz mode / CH High)

Detector mode: Peak

Polarity: Vertical

Agilent 17:04:54 Nov 24, 2010

R T

Mkr1 2.483 50 GHz
65.81 dBμV

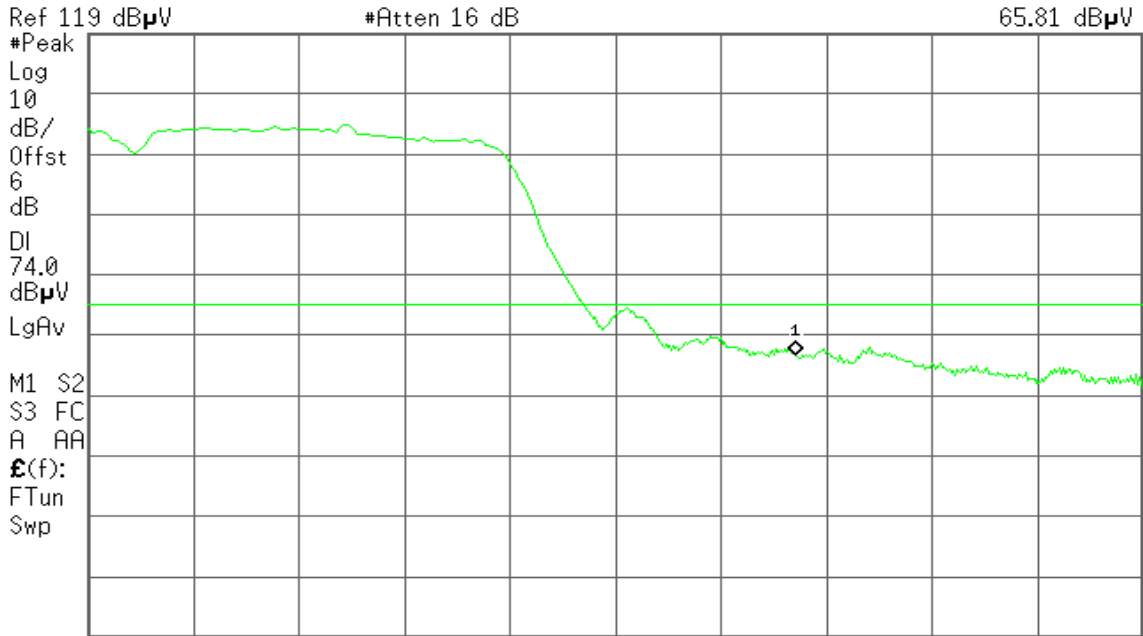

Start 2.450 00 GHz #Res BW 1 MHz #VBW 1 MHz Stop 2.500 00 GHz #Sweep 100 ms (601 pts)

Detector mode: Average

Polarity: Vertical

Agilent 17:05:33 Nov 24, 2010

R T

Mkr1 2.483 50 GHz
52.13 dBμV



Start 2.450 00 GHz #Res BW 1 MHz #VBW 10 Hz Stop 2.500 00 GHz Sweep 3.899 s (601 pts)



Detector mode: Peak

Polarity: Horizontal

Agilent 17:09:45 Nov 24, 2010

R T

Mkr1 2.483 50 GHz
59.12 dB μ V

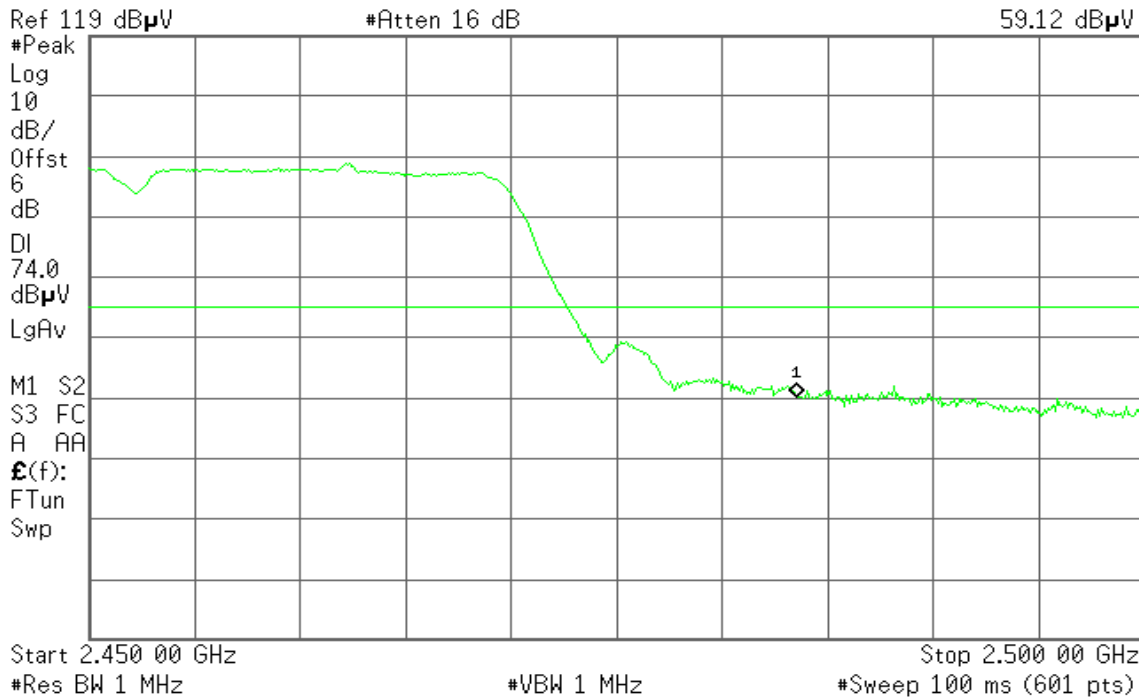

Detector mode: Average

Polarity: Horizontal

Agilent 17:10:21 Nov 24, 2010

R T

Mkr1 2.483 50 GHz
46.62 dB μ V

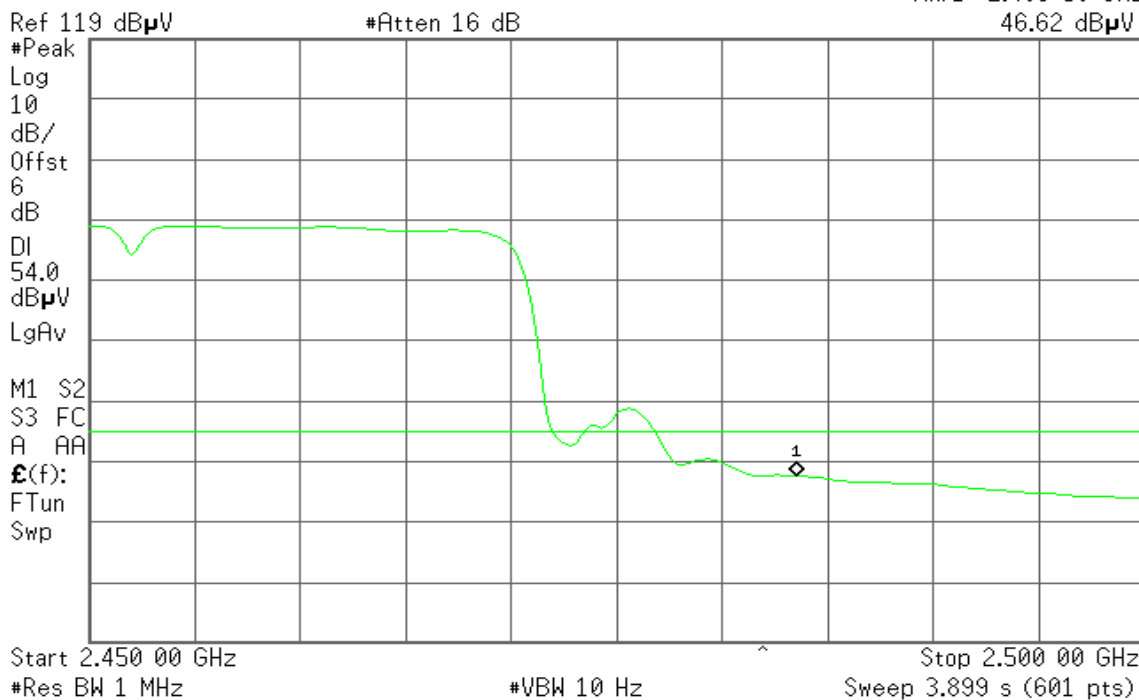



7.5 PEAK POWER SPECTRAL DENSITY

LIMIT

1. According to §15.247(e), for digitally modulated systems, the power spectral density conducted from the intentional radiator to the antenna shall not be greater than 8 dBm in any 3 kHz band during any time interval of continuous transmission.
2. According to §15.247(f), the digital modulation operation of the hybrid system, with the frequency hopping turned off, shall comply with the power density requirements of paragraph (d) of this section.

Test Configuration

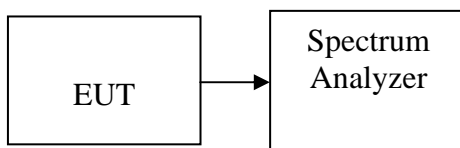

TEST PROCEDURE

1. Place the EUT on the table and set it in transmitting mode.
Remove the antenna from the EUT and then connect a low loss RF cable from the antenna port to the spectrum analyzer.
2. Set the spectrum analyzer as RBW = 3 kHz, VBW = 10 kHz, Span = 300 kHz, Sweep time = 100 s
3. Record the max reading.
4. Repeat the above procedure until the measurements for all frequencies are completed.



TEST RESULTS

No non-compliance noted

Test Data

Test mode: IEEE 802.11b mode

Channel	Frequency (MHz)	PPSD (dBm)	Limit (dBm)	Result
Low	2412	-16.94	8.00	PASS
Mid	2437	-14.28		PASS
High	2462	-16.85		PASS

Test mode: IEEE 802.11g mode

Channel	Frequency (MHz)	PPSD (dBm)	Limit (dBm)	Result
Low	2412	-20.98	8.00	PASS
Mid	2437	-20.64		PASS
High	2462	-21.13		PASS

Test mode: IEEE 802.11n HT 20 MHz mode

Channel	Frequency (MHz)	PPSD (dBm)	Limit (dBm)	Result
Low	2412	-19.32	8.00	PASS
Mid	2437	-20.24		PASS
High	2462	-20.60		PASS

Test mode: IEEE 802.11n HT 40 MHz mode

Channel	Frequency (MHz)	PPSD (dBm)	Limit (dBm)	Result
Low	2422	-21.34	8.00	PASS
Mid	2437	-21.55		PASS
High	2452	-23.11		PASS



Test Plot

IEEE 802.11b mode

PPSD (CH Low)

Agilent 13:49:30 Dec 16, 2010

R T
Mkr1 2.412 664 0 GHz
-16.94 dBm

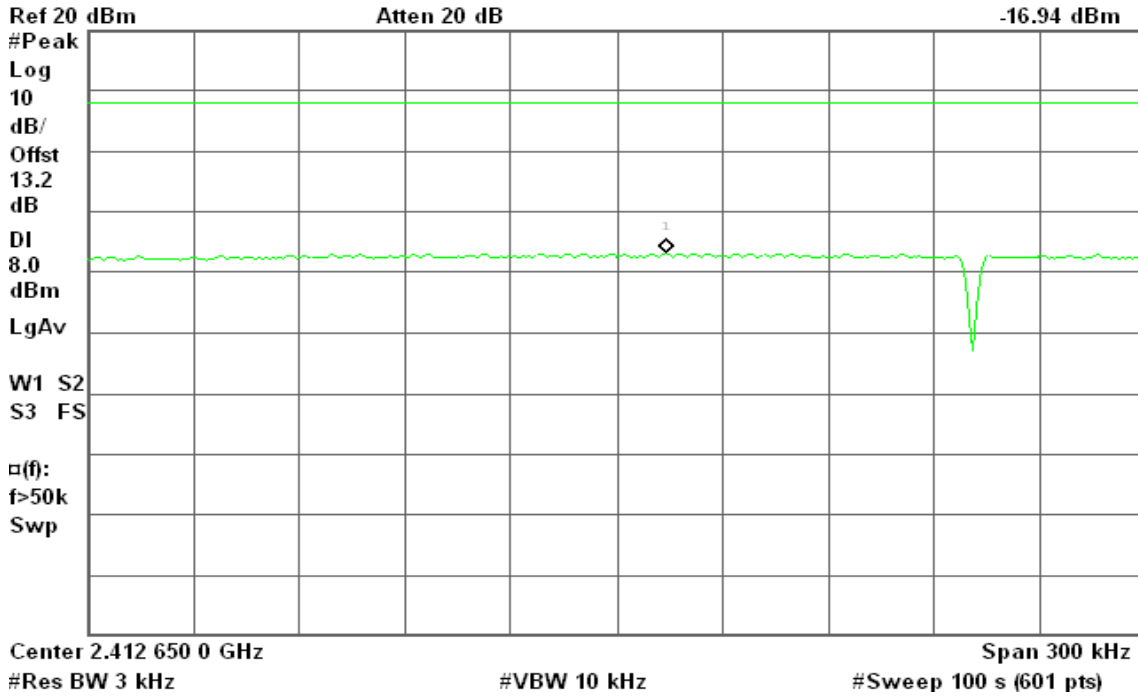

PPSD (CH Mid)

Agilent 14:00:39 Dec 16, 2010

R L
Mkr1 2.436 317 7 GHz
-14.28 dBm

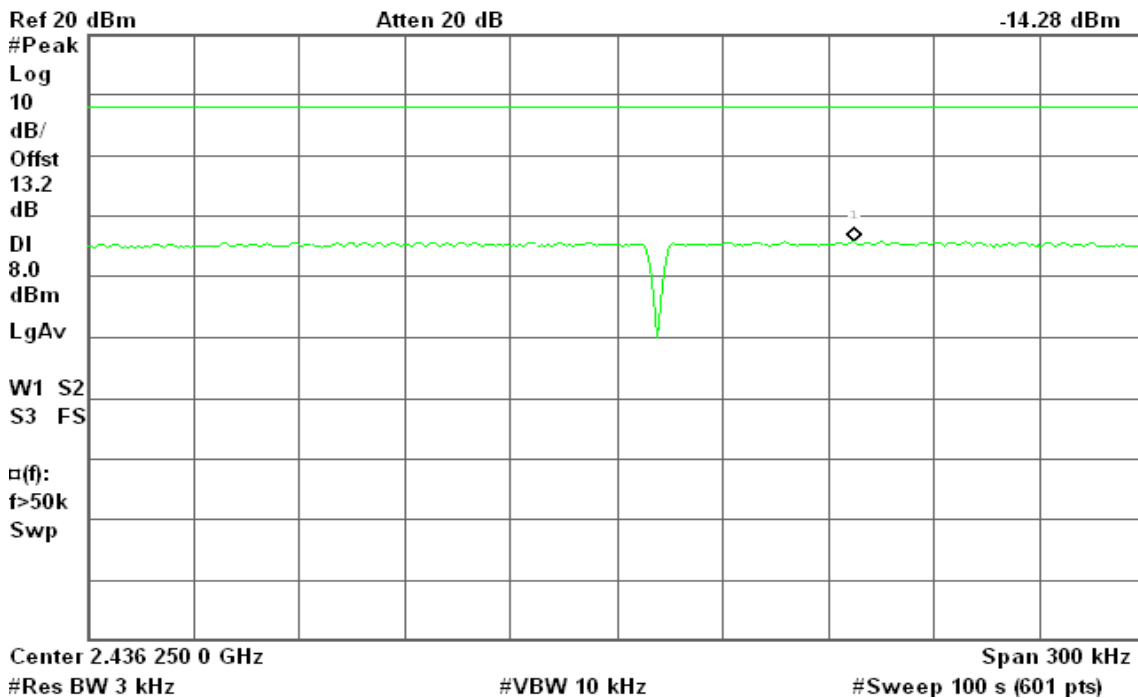



PPSD (CH High)

Agilent 14:18:26 Dec 16, 2010

R T

Mkr1 2.461 316 4 GHz
-16.85 dBm



IEEE 802.11g mode

PPSD (CH Low)

Agilent 14:23:23 Dec 16, 2010

R L

Mkr1 2.411 080 1 GHz
-20.98 dBm

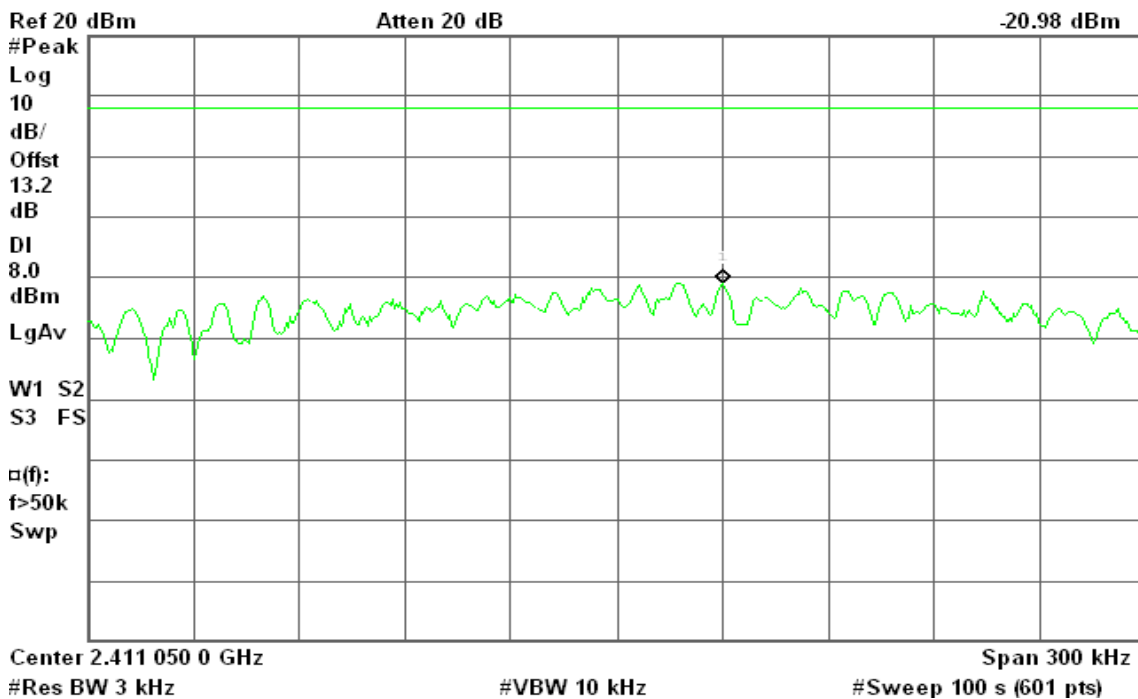



PPSD (CH Mid)

Agilent 14:27:30 Dec 16, 2010

R T

Mkr1 2.433 875 4 GHz
-20.64 dBm

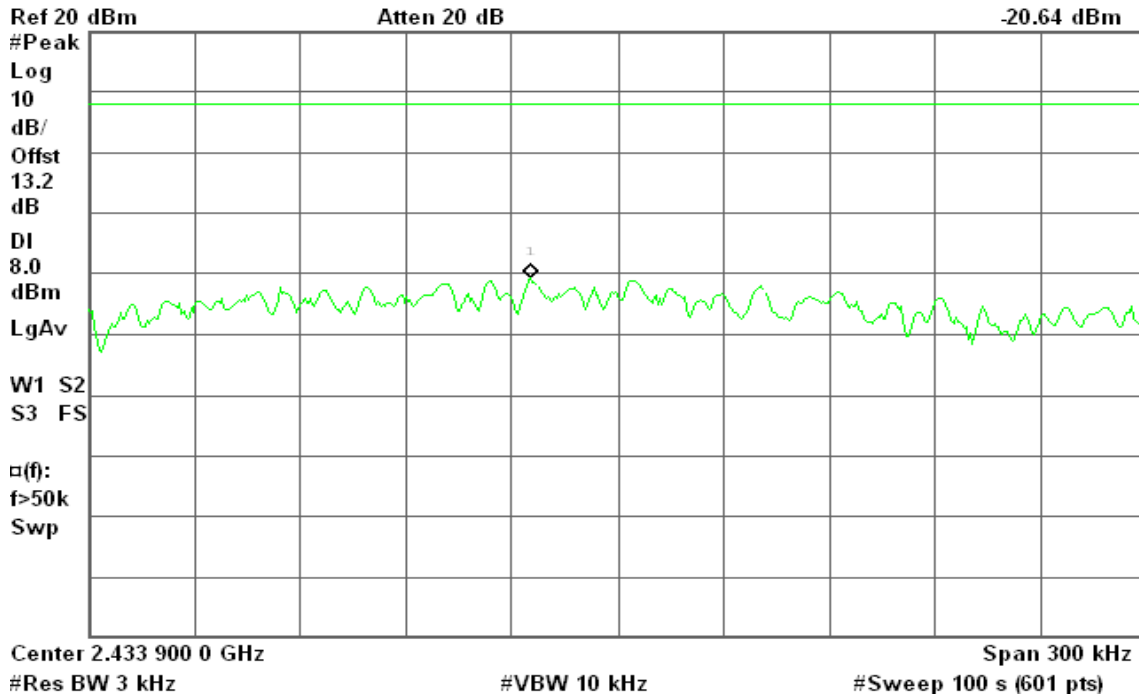

PPSD (CH High)

Agilent 14:31:17 Dec 16, 2010

R L

Mkr1 2.461 065 6 GHz
-21.13 dBm

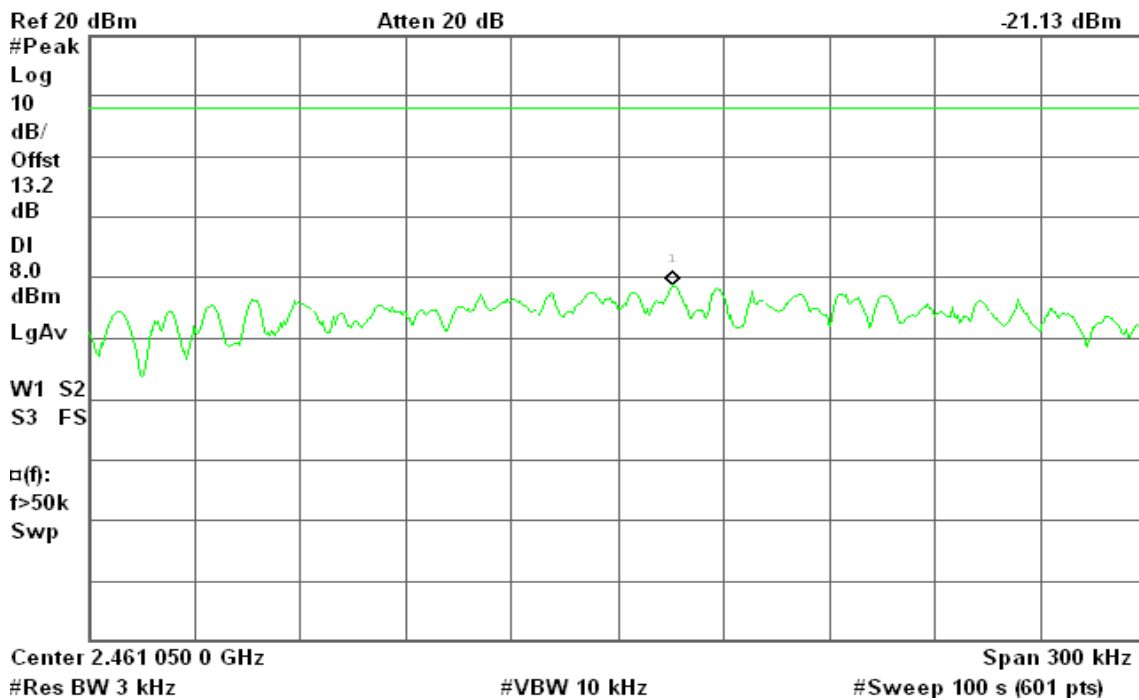



IEEE 802.11n HT 20 MHz mode

PPSD (CH Low)

Agilent 14:35:25 Dec 16, 2010

R T

Mkr1 2.414 167 1 GHz
-19.32 dBm

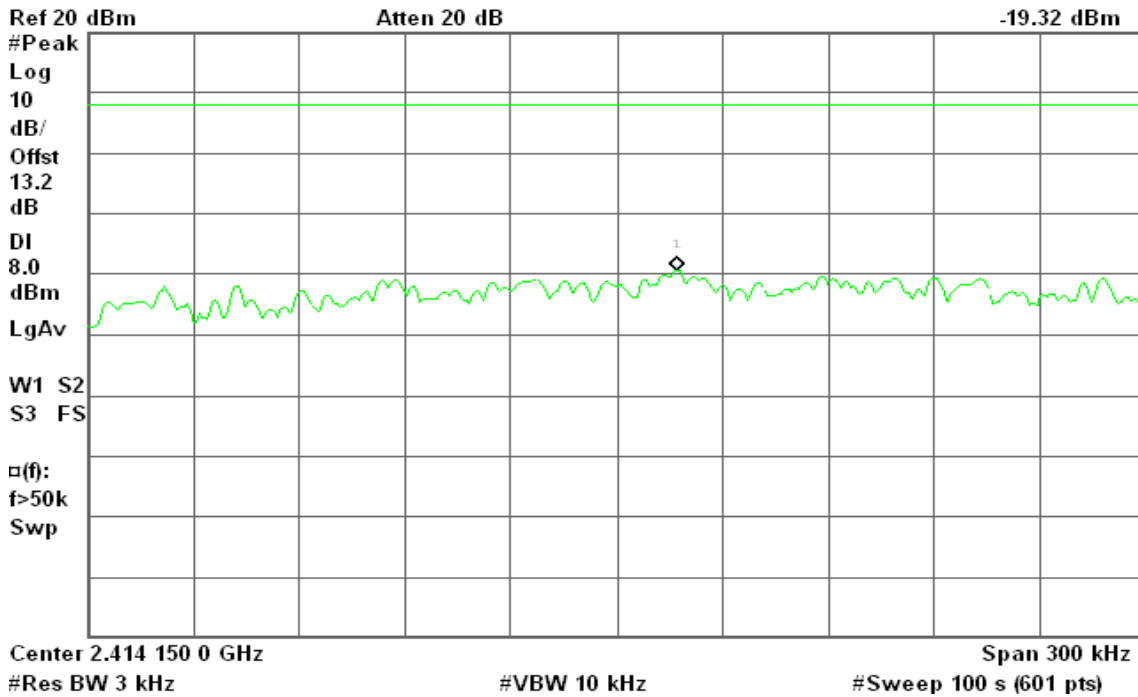

PPSD (CH Mid)

Agilent 14:40:51 Dec 16, 2010

R T

Mkr1 2.443 627 6 GHz
-20.24 dBm

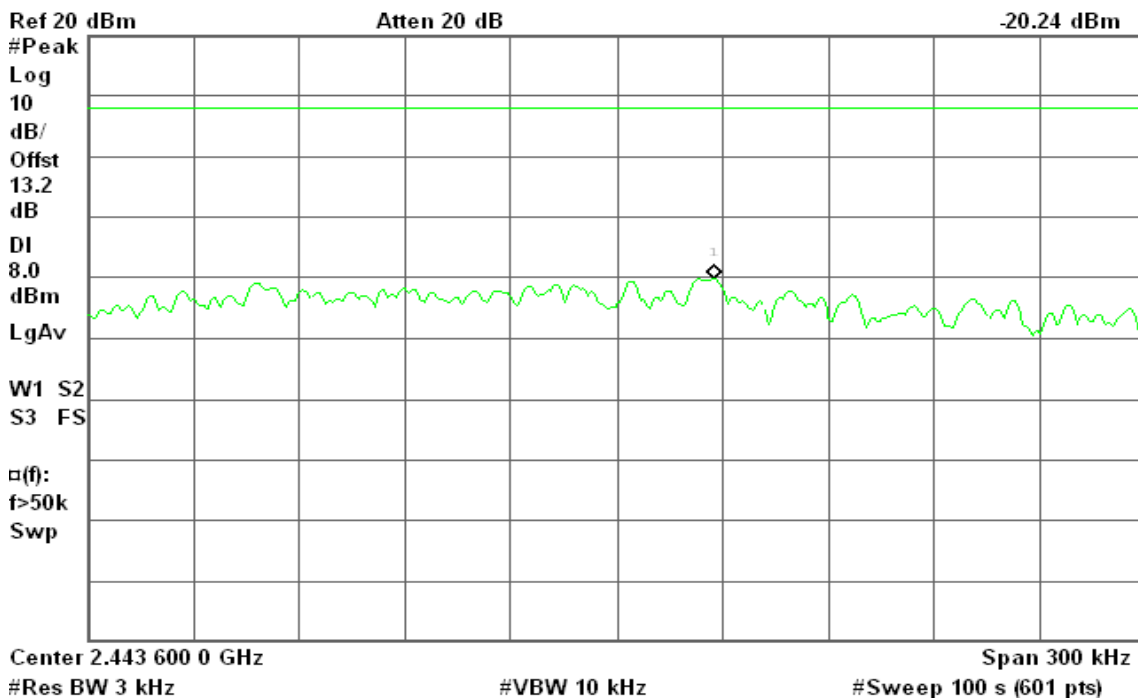



PPSD (CH High)

Agilent 14:44:55 Dec 16, 2010

R L

Mkr1 2.459 771 6 GHz
-20.60 dBm

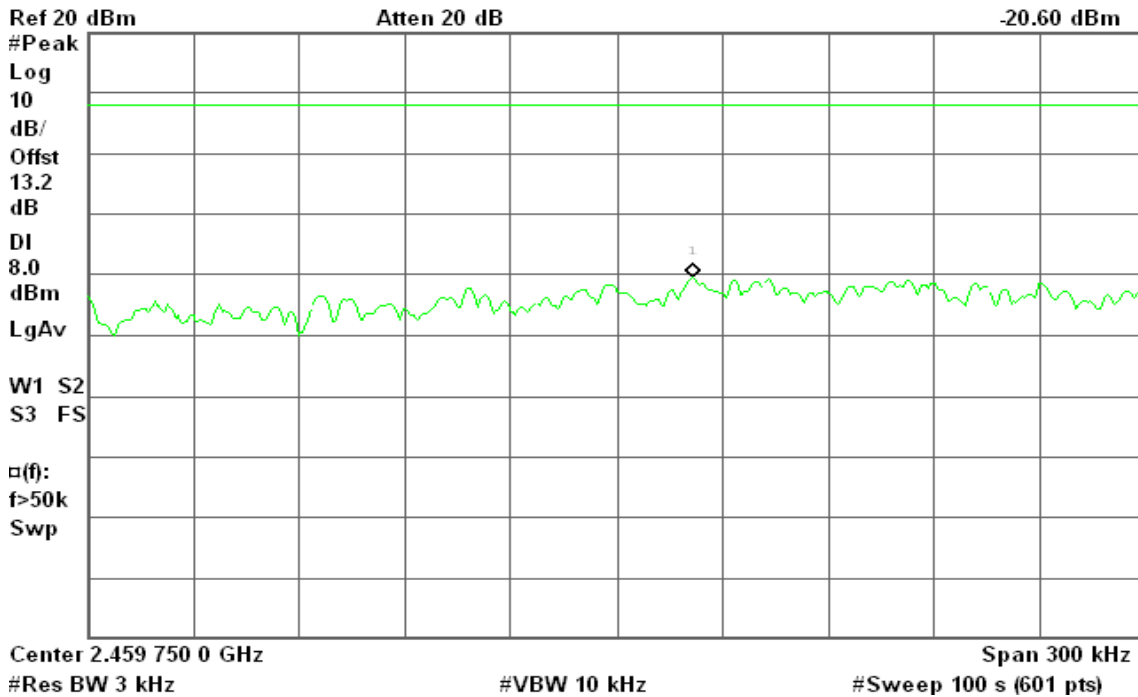

IEEE 802.11n HT 40 MHz mode

PPSD (CH Low)

Agilent 14:49:29 Dec 16, 2010

R T

Mkr1 2.425 403 0 GHz
-21.34 dBm

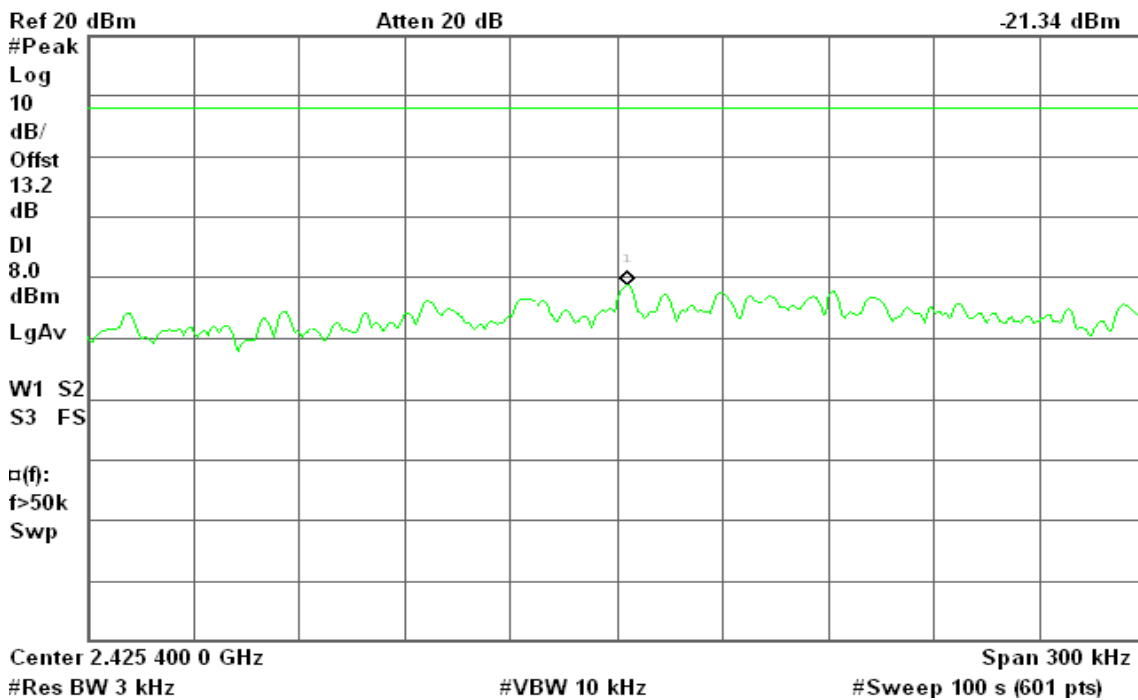



PPSD (CH Mid)

Agilent 14:55:24 Dec 16, 2010

R T

Mkr1 2.440 403 0 GHz
-21.55 dBm

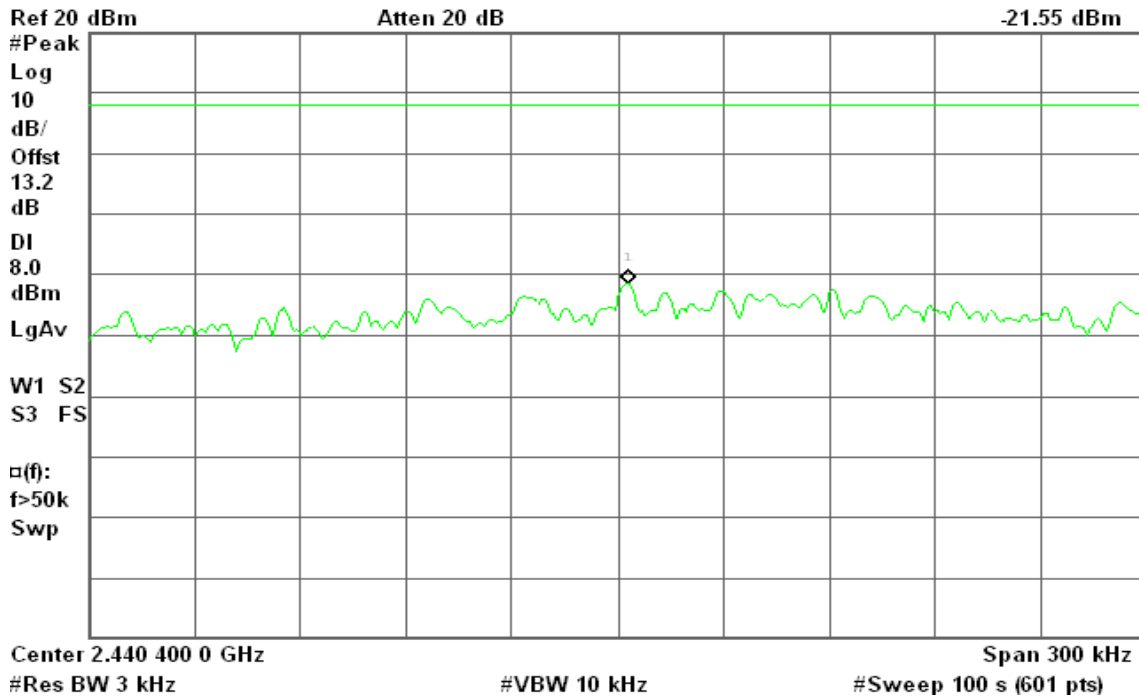

PPSD (CH High)

Agilent 14:58:55 Dec 16, 2010

R T

Mkr1 2.444 225 1 GHz
-23.11 dBm

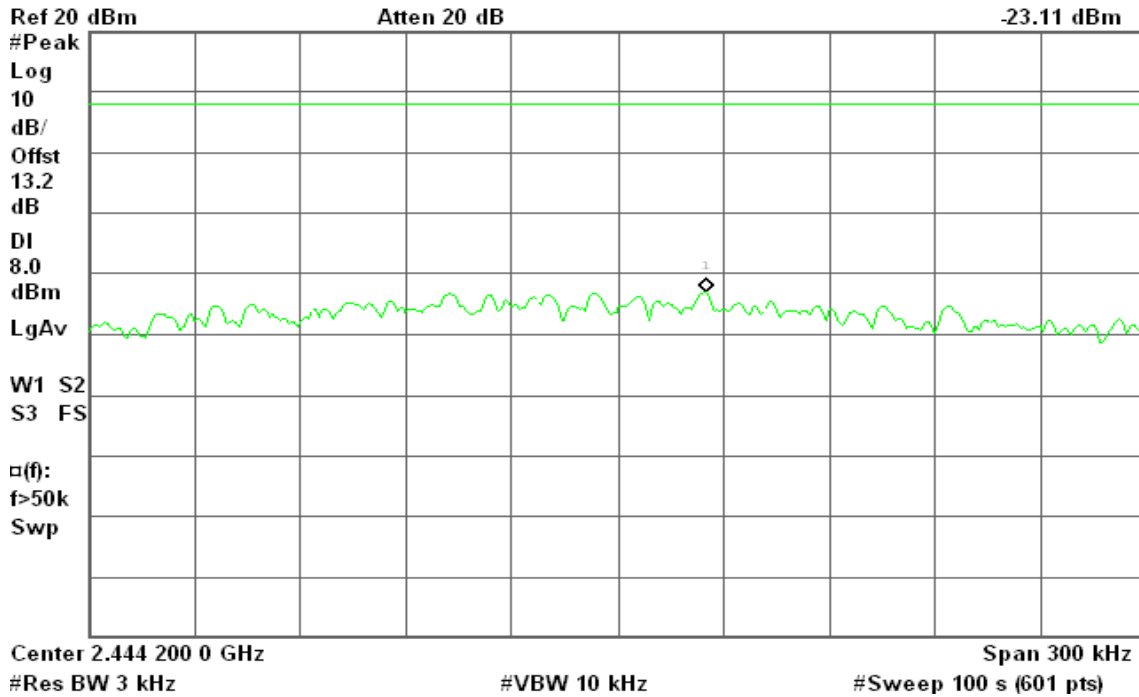



7.6 SPURIOUS EMISSIONS

7.6.1 Conducted Measurement

LIMIT

According to §15.247(d), in any 100 kHz bandwidth outside the frequency bands in which the spread spectrum intentional radiator is operating, the radio frequency power that is produced by the intentional radiator shall be at least 20 dB below that in the 100 kHz bandwidth within the band that contains the highest level of the desired power, based on either an RF conducted or a radiated measurement, provided the transmitter demonstrates compliance with the peak conducted power limits. In addition, radiated emissions which fall in the restricted bands, as defined in §15.205(a), must also comply with the radiated emission limits specified in 15.209(a) (see Section 15.205(c)).

Test Configuration

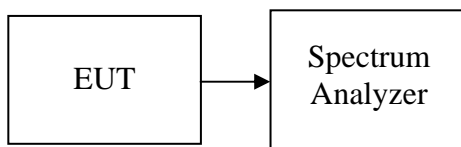

TEST PROCEDURE

Conducted RF measurements of the transmitter output were made to confirm that the EUT antenna port conducted emissions meet the specified limit and to identify any spurious signals that require further investigation or measurements on the radiated emissions site.

The transmitter output is connected to the spectrum analyzer. The resolution bandwidth is set to 100 kHz. The video bandwidth is set to 100 kHz.

Measurements are made over the 30MHz to 26GHz range with the transmitter set to the lowest, middle, and highest channels.

TEST RESULTS

No non-compliance noted



Test Plot

IEEE 802.11b mode

CH Low

Agilent 13:50:14 Dec 16, 2010

R T



CH Mid

Agilent 14:01:27 Dec 16, 2010

R T





CH Mid

Agilent 14:28:05 Dec 16, 2010

R T

Mkr1 2.45 GHz
-7.05 dBm

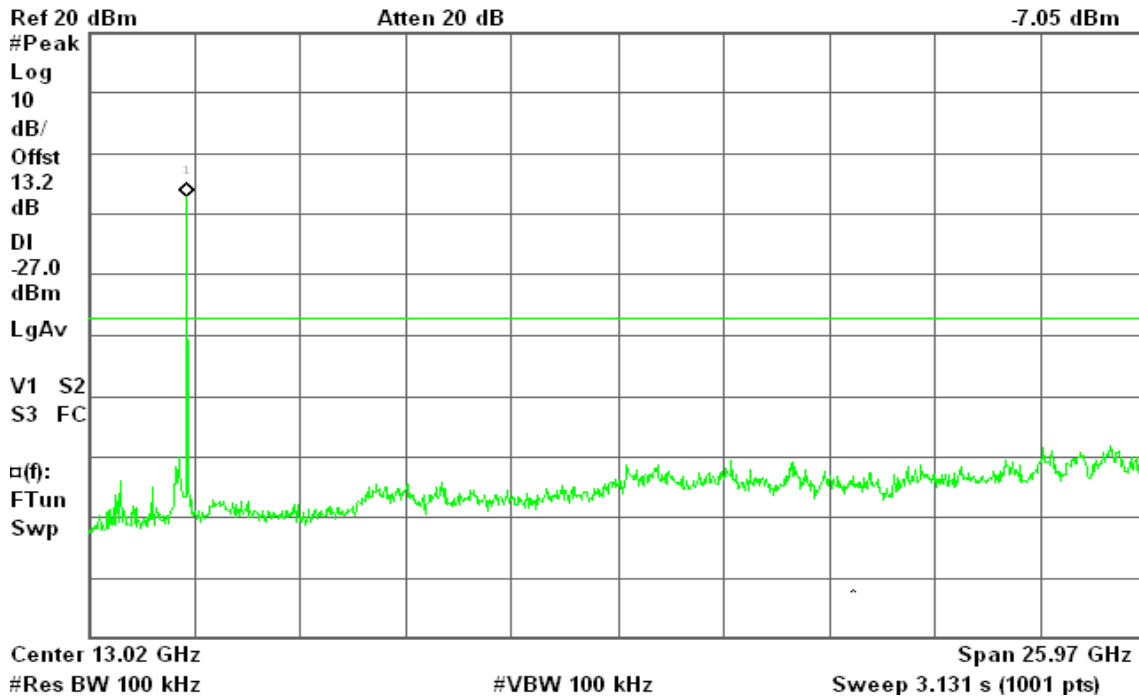

CH High

Agilent 14:31:51 Dec 16, 2010

R T

Mkr1 2.47 GHz
-7.67 dBm

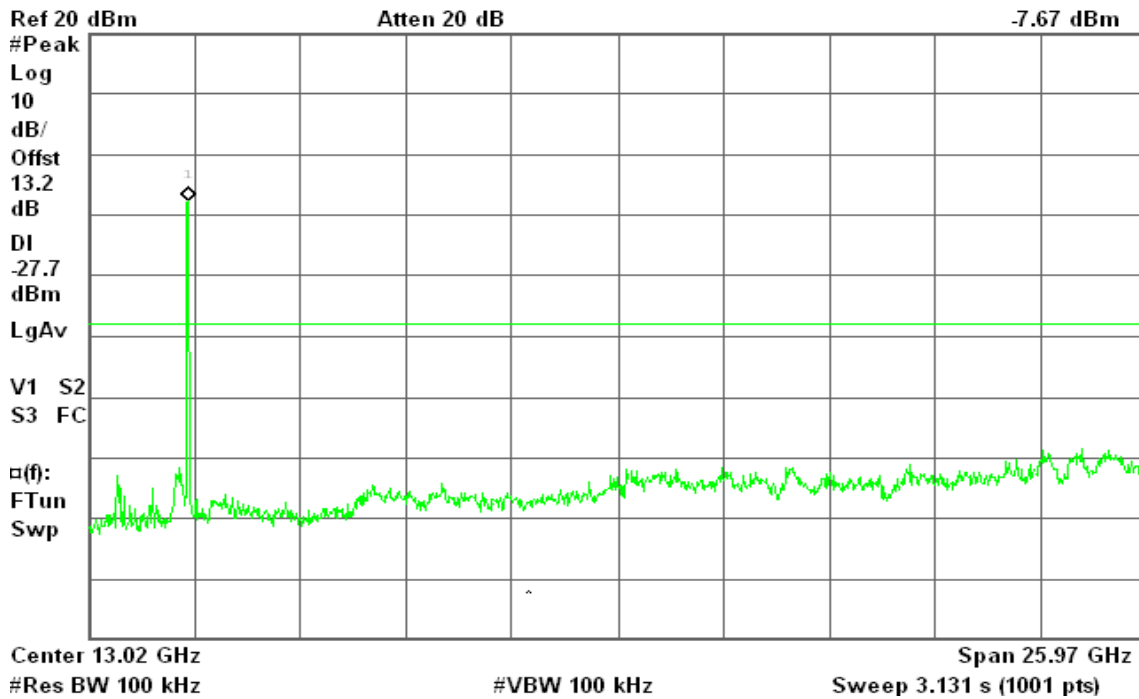



IEEE 802.11n HT 20 MHz mode

CH Low

Agilent 14:36:26 Dec 16, 2010

R T

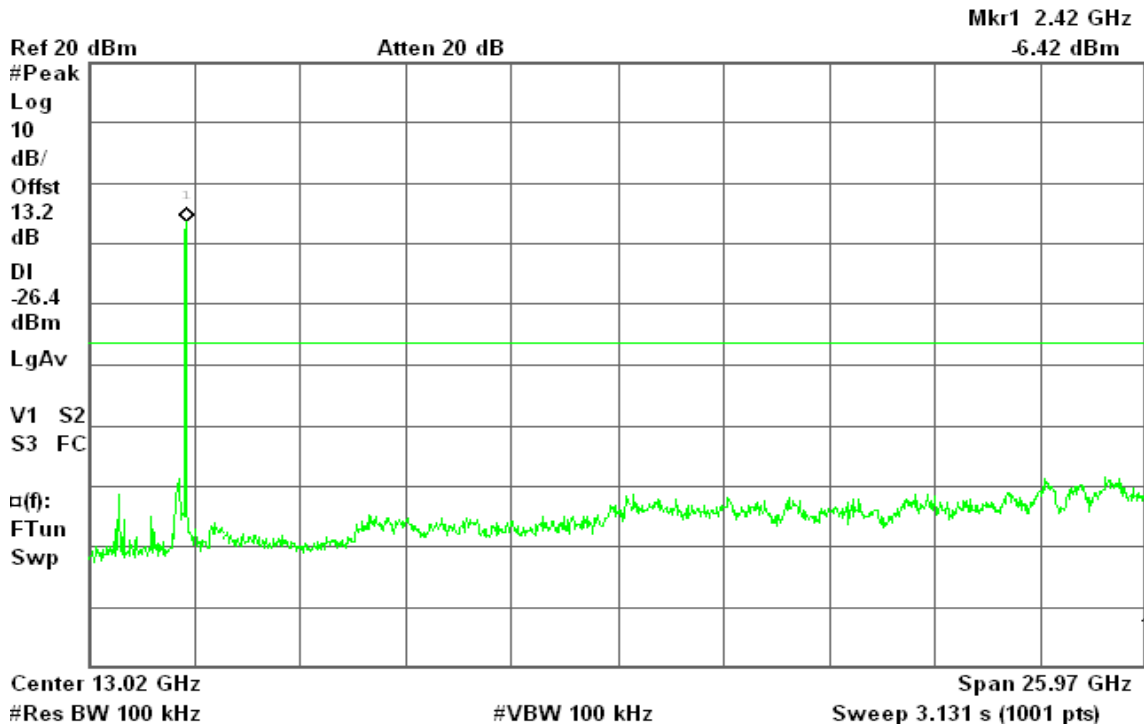

CH Mid

Agilent 14:41:28 Dec 16, 2010

R T

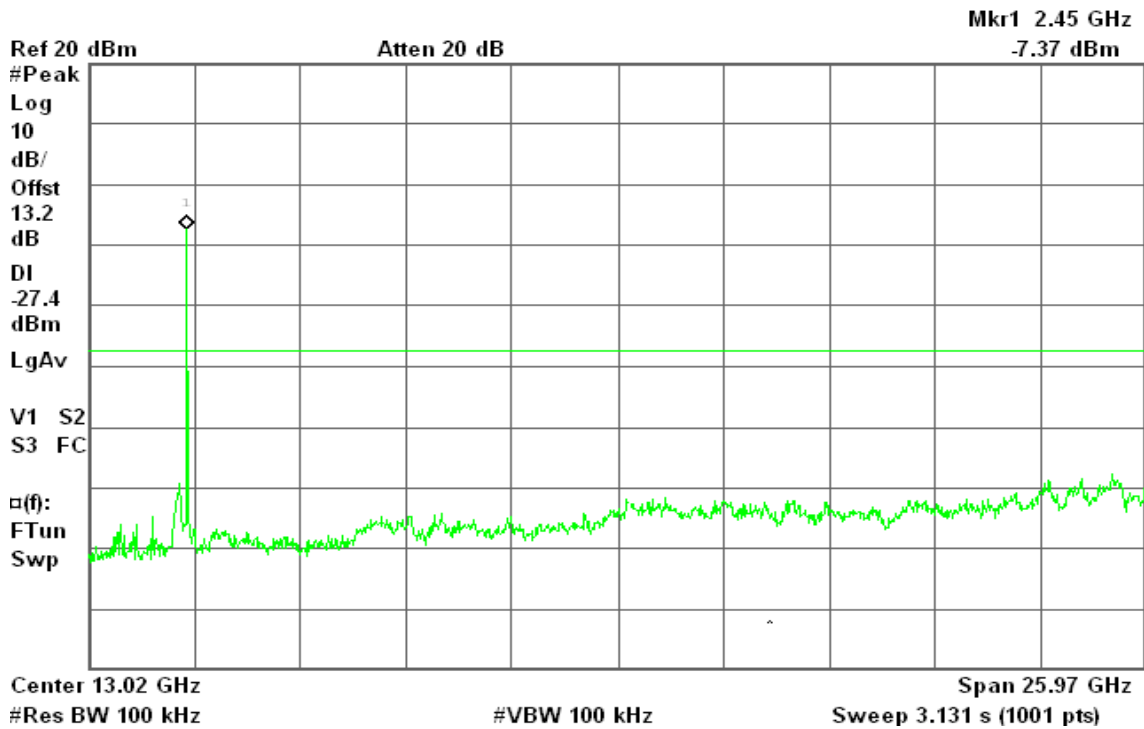



CH High

Agilent 14:45:31 Dec 16, 2010

R T

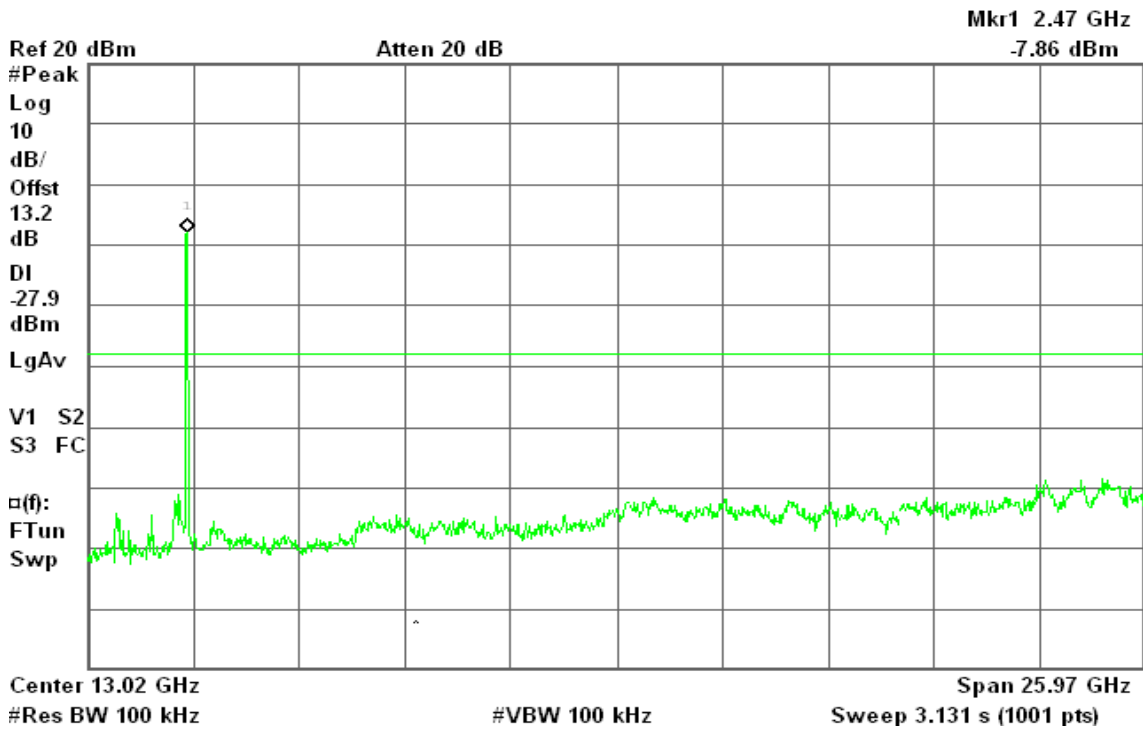

IEEE 802.11n HT 40 MHz mode

CH Low

Agilent 14:51:54 Dec 16, 2010

R T

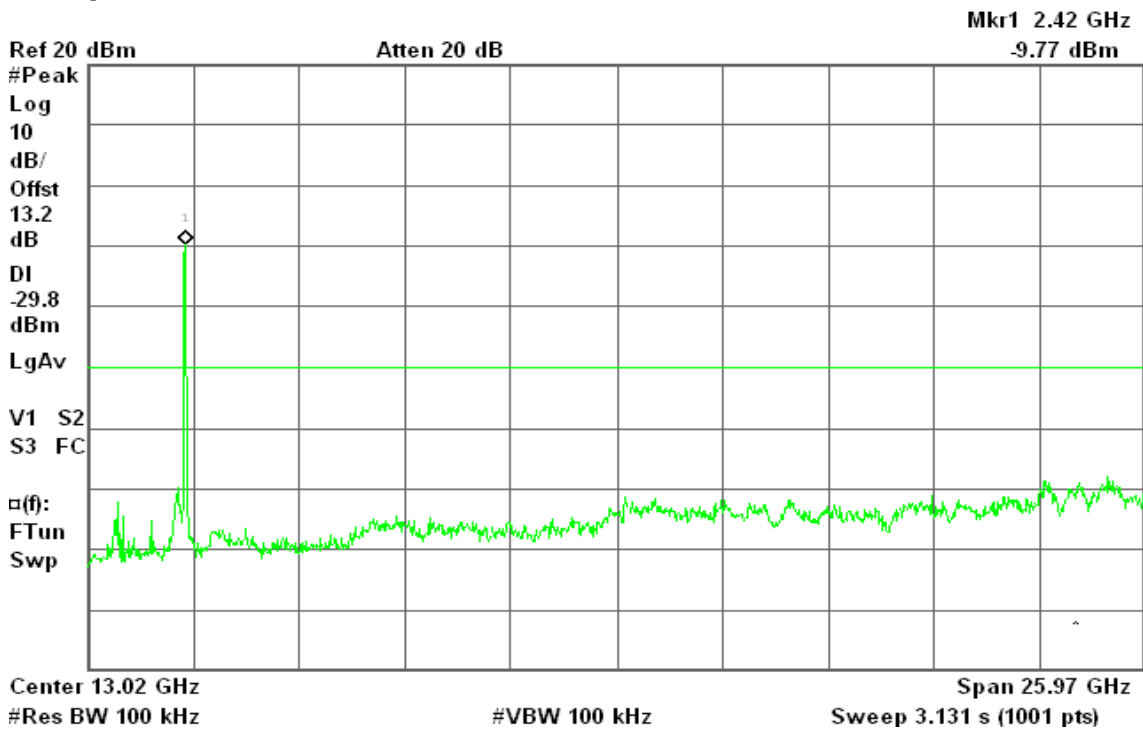



CH Mid

Agilent 14:55:58 Dec 16, 2010

R T

Mkr1 2.42 GHz
-10.27 dBm

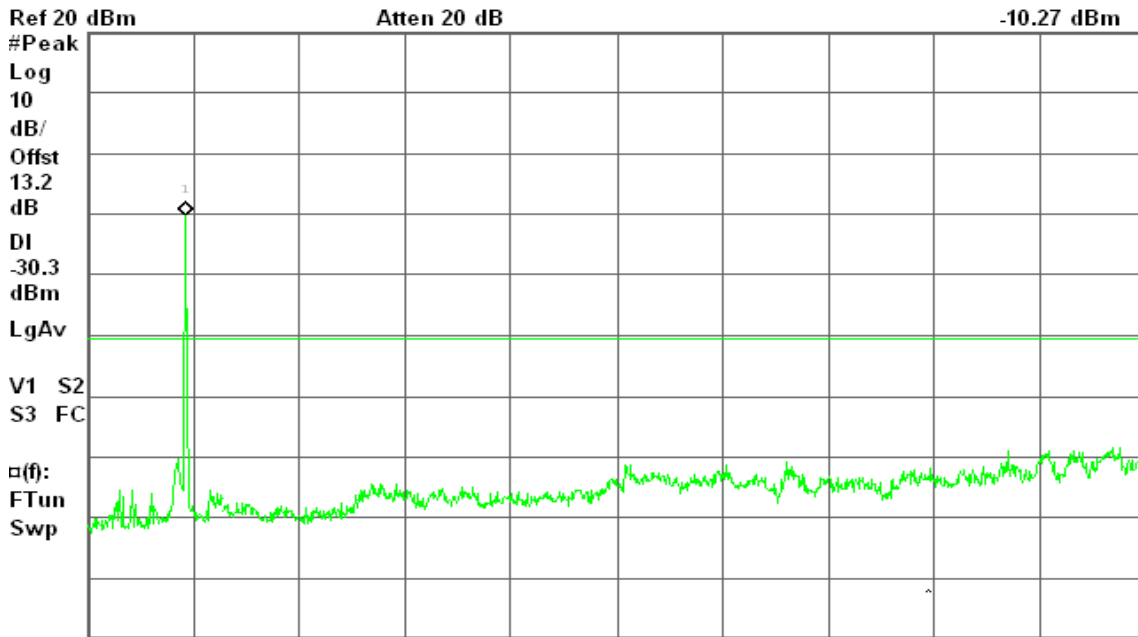

CH High

Agilent 15:00:10 Dec 16, 2010

R T

Mkr1 2.45 GHz
-10.68 dBm

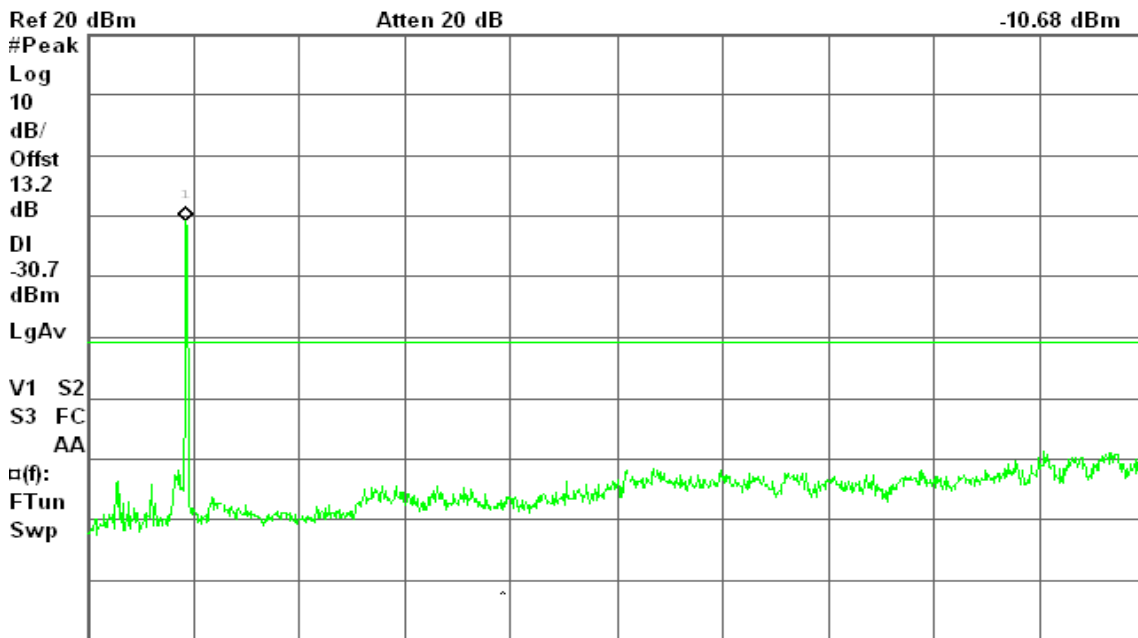



7.7 RADIATED EMISSIONS

LIMIT

1. According to §15.209(a), except as provided elsewhere in this Subpart, the emissions from an intentional radiator shall not exceed the field strength levels specified in the following table:

Frequency (MHz)	Field Strength ($\mu\text{V}/\text{m}$)	Measurement Distance (m)
30-88	100*	3
88-216	150*	3
216-960	200*	3
Above 960	500	3

Remark: Except as provided in paragraph (g), fundamental emissions from intentional radiators operating under this Section shall not be located in the frequency bands 54-72 MHz, 76-88 MHz, 174-216 MHz or 470-806 MHz. However, operation within these frequency bands is permitted under other sections of this Part, e.g., Sections 15.231 and 15.241.

2. In the emission table above, the tighter limit applies at the band edges.

Frequency (MHz)	Field Strength ($\mu\text{V}/\text{m}$ at 3-meter)	Field Strength (dB $\mu\text{V}/\text{m}$ at 3-meter)
30-88	100	40
88-216	150	43.5
216-960	200	46
Above 960	500	54



Test Configuration

9kHz ~ 30MHz

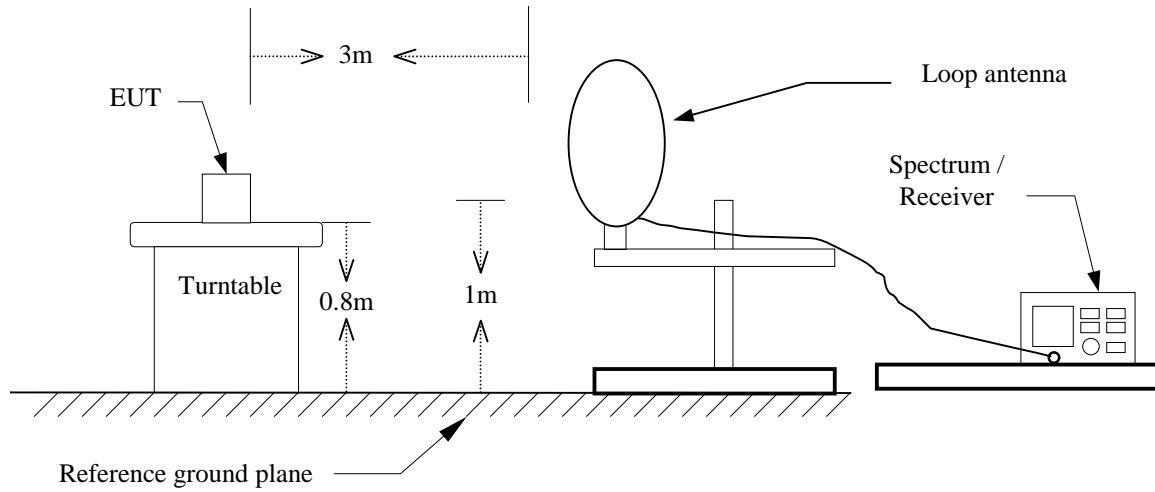

30MHz ~ 1GHz

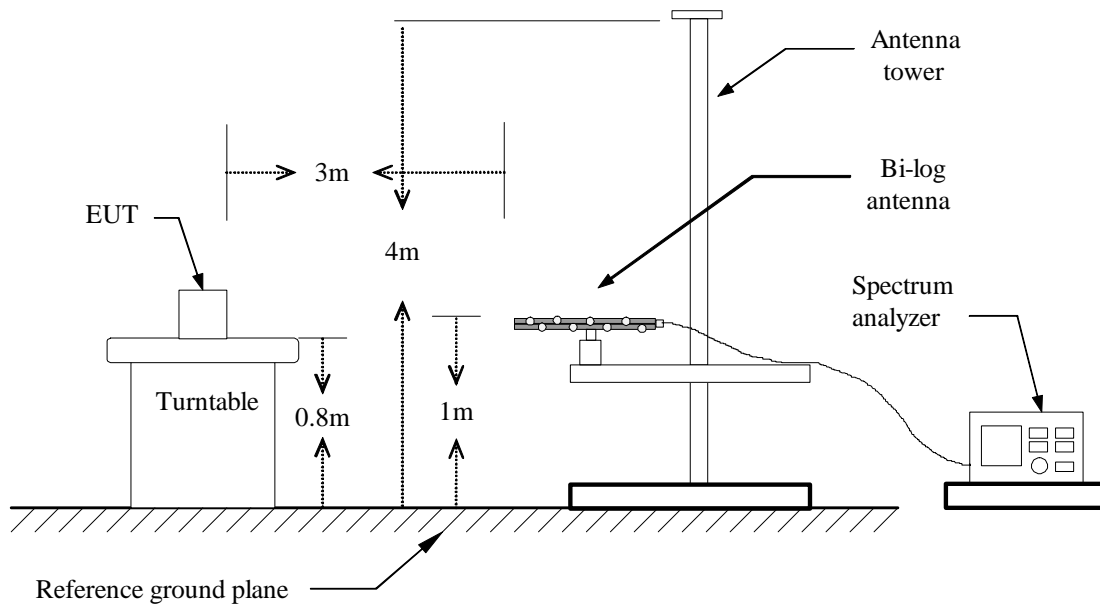



Above 1 GHz

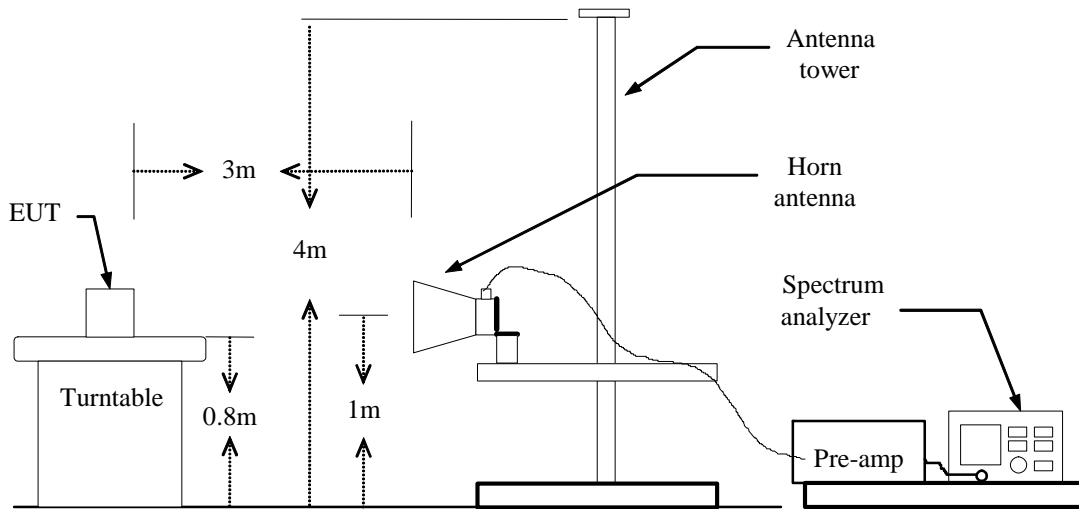



TEST PROCEDURE

1. The EUT is placed on a turntable, which is 0.8m above ground plane.
2. The turntable shall be rotated for 360 degrees to determine the position of maximum emission level.
3. EUT is set 3m away from the receiving antenna, which is varied from 1m to 4m to find out the highest emissions.
4. Maximum procedure was performed on the six highest emissions to ensure EUT compliance.
5. And also, each emission was to be maximized by changing the polarization of receiving antenna both horizontal and vertical.
6. Set the spectrum analyzer in the following setting as:
Below 1GHz:
RBW=100kHz / VBW=300kHz / Sweep=AUTO
Above 1GHz:
(a) PEAK: RBW=VBW=1MHz / Sweep=AUTO
(b) AVERAGE: RBW=1MHz / VBW=10Hz / Sweep=AUTO
7. Repeat above procedures until the measurements for all frequencies are complete.



TEST RESULTS

Below 1GHz

Operation Mode: Normal Link

Test Date: August 31, 2010

Temperature: 25°C

Tested by: Tom Jen

Humidity: 40% RH

Polarity: Ver. / Hor.

Frequency (MHz)	Reading (dBuV)	Correction Factor (dB/m)	Result (dBuV/m)	Limit (dBuV/m)	Margin (dB)	Remark	Ant. Pol. (H/V)
245.02	47.34	-10.99	36.34	46.00	-9.66	Peak	V
316.15	47.13	-8.86	38.28	46.00	-7.72	Peak	V
343.63	47.01	-8.20	38.81	46.00	-7.19	Peak	V
720.32	43.08	-2.25	40.83	46.00	-5.17	Peak	V
760.73	43.85	-1.72	42.14	46.00	-3.86	Peak	V
799.53	38.12	-1.34	36.77	46.00	-9.23	Peak	V
253.10	49.83	-10.69	39.14	46.00	-6.86	QP	H
314.53	50.20	-8.89	41.31	46.00	-4.69	QP	H
679.90	40.91	-2.68	38.23	46.00	-7.77	Peak	H
760.73	46.70	-1.72	44.98	46.00	-1.02	QP	H
772.05	44.10	-1.61	42.49	46.00	-3.51	Peak	H
799.53	45.17	-1.34	43.83	46.00	-2.17	Peak	H

Remark:

1. No emission found between lowest internal used/generated frequency to 30MHz (9kHz~30MHz)
2. Radiated emissions measured in frequency range from 30 MHz to 1000MHz were made with an instrument using peak/quasi-peak detector mode.
3. Quasi-peak test would be performed if the peak result were greater than the quasi-peak limit or as required by the applicant.
4. Measurements above show only up to 6 maximum emissions noted, or would be lesser, with " N/A " remark, if no specific emissions from the EUT are recorded (ie: margin>20dB from the applicable limit) and considered that's already beyond the background noise floor.
5. $Margin (dB) = Result (dBuV/m) - Limit (dBuV/m)$.



Above 1 GHz

Operation Mode: TX / IEEE 802.11b / CH Low

Test Date: November 24, 2010

Temperature: 23°C

Tested by: Wolf Huang

Humidity: 51 % RH

Polarity: Ver. / Hor.

Frequency (MHz)	Reading (Peak) (dBuV)	Reading (Average) (dBuV)	Correction Factor (dB/m)	Result (Peak) (dBuV/m)	Result (Average) (dBuV/m)	Limit (Peak) (dBuV/m)	Limit (Average) (dBuV/m)	Margin (dB)	Remark	Ant. Pol. (H/V)
2413.33	109.00	106.02	-2.92	106.08	103.10	Fundamental				
2253.33	70.34	57.29	-3.40	66.94	53.89	74.00	54.00	-0.11	AVG	V
4825.00	50.47	---	1.18	51.65	---	74.00	54.00	-2.35	Peak	V
9650.00	52.00	49.34	12.15	64.15	61.49	86.08	83.10	-21.61	20dBc AVG Fundamental	V
N/A										
2413.33	104.17	101.34	-2.92	101.25	98.42	Fundamental				
2243.33	64.23	50.32	-3.42	60.81	46.90	74.00	54.00	-7.10	AVG	H
9650.00	51.58	48.21	12.15	63.73	60.36	81.25	78.42	-18.06	20dBc AVG Fundamental	H
N/A										

Remark:

1. Measuring frequencies from 1 GHz to the 10th harmonic of highest fundamental frequency.
2. Radiated emissions measured in frequency above 1000MHz were made with an instrument using peak/average detector mode.
3. Average test would be performed if the peak result were greater than the average limit or as required by the applicant.
4. Data of measurement within this frequency range shown " --- " in the table above means the reading of emissions are attenuated more than 20dB below the permissible limits or the field strength is too small to be measured.
5. Measurements above show only up to 6 maximum emissions noted, or would be lesser, with " N/A " remark, if no specific emissions from the EUT are recorded (ie: margin > 20dB from the applicable limit) and considered that's already beyond the background noise floor.
6. Margin (dB) = Remark result (dBuV/m) – Average limit (dBuV/m).
7. Data of measurement within this frequency range shown " --- " in the table above means the reading of emissions are attenuated more than 20dB below the permissible limits or the field strength is too small to be measured.



Operation Mode: TX / IEEE 802.11b / CH Mid

Test Date: November 24, 2010

Temperature: 23°C

Tested by: Wolf Huang

Humidity: 51 % RH

Polarity: Ver. / Hor.

Frequency (MHz)	Reading (Peak) (dBuV)	Reading (Average) (dBuV)	Correction Factor (dB/m)	Result (Peak) (dBuV/m)	Result (Average) (dBuV/m)	Limit (Peak) (dBuV/m)	Limit (Average) (dBuV/m)	Margin (dB)	Remark	Ant. Pol. (H/V)
2436.67	109.58	106.78	-2.85	106.73	103.93	Fundamental				
2256.67	69.65	57.16	-3.39	66.26	53.77	74.00	54.00	-0.23	AVG	V
4875.00	54.24	49.26	1.16	55.40	50.42	74.00	54.00	-3.58	AVG	V
9750.00	54.07	51.11	12.38	66.45	63.49	86.73	83.93	-20.44	20dBc AVG Fundamental	V
N/A										
2436.67	107.44	104.34	-2.85	104.59	101.49	Fundamental				
2250.00	61.88	49.33	-3.41	58.47	45.92	74.00	54.00	-8.08	AVG	H
4875.00	50.49	---	1.16	51.65	---	74.00	54.00	-2.35	Peak	H
9750.00	51.11	48.09	12.38	63.49	60.47	84.59	81.49	-21.02	20dBc AVG Fundamental	H
N/A										

Remark:

1. Measuring frequencies from 1 GHz to the 10th harmonic of highest fundamental frequency.
2. Radiated emissions measured in frequency above 1000MHz were made with an instrument using peak/average detector mode.
3. Average test would be performed if the peak result were greater than the average limit or as required by the applicant.
4. Data of measurement within this frequency range shown " --- " in the table above means the reading of emissions are attenuated more than 20dB below the permissible limits or the field strength is too small to be measured.
5. Measurements above show only up to 6 maximum emissions noted, or would be lesser, with " N/A " remark, if no specific emissions from the EUT are recorded (ie: margin > 20dB from the applicable limit) and considered that's already beyond the background noise floor.
6. Margin (dB) = Remark result (dBuV/m) – Average limit (dBuV/m).
7. Data of measurement within this frequency range shown " --- " in the table above means the reading of emissions are attenuated more than 20dB below the permissible limits or the field strength is too small to be measured.



Operation Mode: TX / IEEE 802.11b / CH High

Test Date: November 24, 2010

Temperature: 23°C

Tested by: Wolf Huang

Humidity: 51 % RH

Polarity: Ver. / Hor.

Frequency (MHz)	Reading (Peak) (dBuV)	Reading (Average) (dBuV)	Correction Factor (dB/m)	Result (Peak) (dBuV/m)	Result (Average) (dBuV/m)	Limit (Peak) (dBuV/m)	Limit (Average) (dBuV/m)	Margin (dB)	Remark	Ant. Pol. (H/V)
2460.00	110.25	107.41	-2.78	107.47	104.63	Fundamental				
2276.67	71.25	57.20	-3.33	67.92	53.87	74.00	54.00	-0.13	AVG	V
4925.00	54.83	50.30	1.14	55.97	51.44	74.00	54.00	-2.56	AVG	V
7391.67	50.45	41.33	5.35	55.80	46.68	74.00	54.00	-7.32	AVG	V
9850.00	53.71	49.56	12.61	66.32	62.17	84.47	84.63	-22.46	20dBc AVG Fundamental	V
N/A										
2463.33	104.16	100.84	-2.77	101.39	98.07	Fundamental				
2276.67	65.33	51.84	-3.33	62.00	48.51	74.00	54.00	-5.49	AVG	H
4925.00	50.00	---	1.14	51.15	---	74.00	54.00	-2.85	Peak	H
7391.67	50.47	41.93	5.35	55.82	47.28	74.00	54.00	-6.72	AVG	H
9850.00	50.94	47.83	12.61	63.55	60.44	81.39	78.07	-17.63	20dBc AVG Fundamental	H
N/A										

Remark:

1. Measuring frequencies from 1 GHz to the 10th harmonic of highest fundamental frequency.
2. Radiated emissions measured in frequency above 1000MHz were made with an instrument using peak/average detector mode.
3. Average test would be performed if the peak result were greater than the average limit or as required by the applicant.
4. Data of measurement within this frequency range shown " --- " in the table above means the reading of emissions are attenuated more than 20dB below the permissible limits or the field strength is too small to be measured.
5. Measurements above show only up to 6 maximum emissions noted, or would be lesser, with " N/A " remark, if no specific emissions from the EUT are recorded (ie: margin>20dB from the applicable limit) and considered that's already beyond the background noise floor.
6. Margin (dB) = Remark result (dBuV/m) – Average limit (dBuV/m).
7. Data of measurement within this frequency range shown " --- " in the table above means the reading of emissions are attenuated more than 20dB below the permissible limits or the field strength is too small to be measured.



Operation Mode: TX / IEEE 802.11g / CH Low

Test Date: November 24, 2010

Temperature: 23°C

Tested by: Wolf Huang

Humidity: 51 % RH

Polarity: Ver. / Hor.

Frequency (MHz)	Reading (Peak) (dBuV)	Reading (Average) (dBuV)	Correction Factor (dB/m)	Result (Peak) (dBuV/m)	Result (Average) (dBuV/m)	Limit (Peak) (dBuV/m)	Limit (Average) (dBuV/m)	Margin (dB)	Remark	Ant. Pol. (H/V)
2246.67	66.81	56.44	-3.41	63.40	53.03	74.00	54.00	-0.97	AVG	V
4825.00	54.82	42.31	1.18	56.00	43.49	74.00	54.00	-10.51	AVG	V
N/A										
2246.67	64.33	49.83	-3.41	60.92	46.42	74.00	54.00	-7.58	AVG	H
4825.00	50.03	---	1.18	51.20	---	74.00	54.00	-2.80	Peak	H
N/A										

Remark:

1. Measuring frequencies from 1 GHz to the 10th harmonic of highest fundamental frequency.
2. Radiated emissions measured in frequency above 1000MHz were made with an instrument using peak/average detector mode.
3. Average test would be performed if the peak result were greater than the average limit or as required by the applicant.
4. Data of measurement within this frequency range shown " --- " in the table above means the reading of emissions are attenuated more than 20dB below the permissible limits or the field strength is too small to be measured.
5. Measurements above show only up to 6 maximum emissions noted, or would be lesser, with " N/A " remark, if no specific emissions from the EUT are recorded (ie: margin > 20dB from the applicable limit) and considered that's already beyond the background noise floor.
6. Margin (dB) = Remark result (dBuV/m) – Average limit (dBuV/m).



Operation Mode: TX / IEEE 802.11g / CH Mid

Test Date: November 24, 2010

Temperature: 23°C

Tested by: Wolf Huang

Humidity: 51 % RH

Polarity: Ver. / Hor.

Frequency (MHz)	Reading (Peak) (dBuV)	Reading (Average) (dBuV)	Correction Factor (dB/m)	Result (Peak) (dBuV/m)	Result (Average) (dBuV/m)	Limit (Peak) (dBuV/m)	Limit (Average) (dBuV/m)	Margin (dB)	Remark	Ant. Pol. (H/V)
2253.33	70.49	56.08	-3.40	67.09	52.68	74.00	54.00	-1.32	AVG	V
N/A										
2250.00	61.66	48.45	-3.41	58.25	45.04	74.00	54.00	-8.96	AVG	H
N/A										

Remark:

1. Measuring frequencies from 1 GHz to the 10th harmonic of highest fundamental frequency.
2. Radiated emissions measured in frequency above 1000MHz were made with an instrument using peak/average detector mode.
3. Average test would be performed if the peak result were greater than the average limit or as required by the applicant.
4. Data of measurement within this frequency range shown " --- " in the table above means the reading of emissions are attenuated more than 20dB below the permissible limits or the field strength is too small to be measured.
5. Measurements above show only up to 6 maximum emissions noted, or would be lesser, with " N/A " remark, if no specific emissions from the EUT are recorded (ie: margin > 20dB from the applicable limit) and considered that's already beyond the background noise floor.
6. Margin (dB) = Remark result (dBuV/m) – Average limit (dBuV/m).



Operation Mode: TX / IEEE 802.11g / CH High

Test Date: November 24, 2010

Temperature: 23°C

Tested by: Wolf Huang

Humidity: 51 % RH

Polarity: Ver. / Hor.

Frequency (MHz)	Reading (Peak) (dBuV)	Reading (Average) (dBuV)	Correction Factor (dB/m)	Result (Peak) (dBuV/m)	Result (Average) (dBuV/m)	Limit (Peak) (dBuV/m)	Limit (Average) (dBuV/m)	Margin (dB)	Remark	Ant. Pol. (H/V)
2280.00	69.77	54.50	-3.32	66.45	51.18	74.00	54.00	-2.82	AVG	V
4925.00	55.12	42.26	1.14	56.26	43.40	74.00	54.00	-10.60	AVG	V
N/A										
2273.33	65.48	49.70	-3.34	62.14	46.36	74.00	54.00	-7.64	AVG	H
4925.00	50.48	---	1.14	51.63	---	74.00	54.00	-2.37	Peak	H
N/A										

Remark:

1. Measuring frequencies from 1 GHz to the 10th harmonic of highest fundamental frequency.
2. Radiated emissions measured in frequency above 1000MHz were made with an instrument using peak/average detector mode.
3. Average test would be performed if the peak result were greater than the average limit or as required by the applicant.
4. Data of measurement within this frequency range shown " --- " in the table above means the reading of emissions are attenuated more than 20dB below the permissible limits or the field strength is too small to be measured.
5. Measurements above show only up to 6 maximum emissions noted, or would be lesser, with " N/A " remark, if no specific emissions from the EUT are recorded (ie: margin > 20dB from the applicable limit) and considered that's already beyond the background noise floor.
6. Margin (dB) = Remark result (dBuV/m) – Average limit (dBuV/m).



Operation Mode: TX / IEEE 802.11n HT 20 MHz mode / CH Low Test Date: November 24, 2010

Temperature: 23°C

Tested by: Wolf Huang

Humidity: 51 % RH

Polarity: Ver. / Hor.

Frequency (MHz)	Reading (Peak) (dBuV)	Reading (Average) (dBuV)	Correction Factor (dB/m)	Result (Peak) (dBuV/m)	Result (Average) (dBuV/m)	Limit (Peak) (dBuV/m)	Limit (Average) (dBuV/m)	Margin (dB)	Remark	Ant. Pol. (H/V)
2243.33	71.19	57.15	-3.42	67.77	53.73	74.00	54.00	-0.27	AVG	V
N/A										
2243.33	63.55	49.65	-3.42	60.13	46.23	74.00	54.00	-7.77	AVG	H
N/A										

Remark:

1. Measuring frequencies from 1 GHz to the 10th harmonic of highest fundamental frequency.
2. Radiated emissions measured in frequency above 1000MHz were made with an instrument using peak/average detector mode.
3. Average test would be performed if the peak result were greater than the average limit or as required by the applicant.
4. Data of measurement within this frequency range shown " --- " in the table above means the reading of emissions are attenuated more than 20dB below the permissible limits or the field strength is too small to be measured.
5. Measurements above show only up to 6 maximum emissions noted, or would be lesser, with " N/A " remark, if no specific emissions from the EUT are recorded (ie: margin > 20dB from the applicable limit) and considered that's already beyond the background noise floor.
6. Margin (dB) = Remark result (dBuV/m) – Average limit (dBuV/m).



Operation Mode: TX / IEEE 802.11n HT 20 MHz mode / CH Mid Test Date: November 24, 2010

Temperature: 23°C

Tested by: Wolf Huang

Humidity: 51 % RH

Polarity: Ver. / Hor.

Frequency (MHz)	Reading (Peak) (dBuV)	Reading (Average) (dBuV)	Correction Factor (dB/m)	Result (Peak) (dBuV/m)	Result (Average) (dBuV/m)	Limit (Peak) (dBuV/m)	Limit (Average) (dBuV/m)	Margin (dB)	Remark	Ant. Pol. (H/V)
2256.67	71.53	56.13	-3.39	68.14	52.74	74.00	54.00	-1.26	AVG	V
N/A										
2253.33	62.14	49.51	-3.40	58.74	46.11	74.00	54.00	-7.89	AVG	H
N/A										

Remark:

1. Measuring frequencies from 1 GHz to the 10th harmonic of highest fundamental frequency.
2. Radiated emissions measured in frequency above 1000MHz were made with an instrument using peak/average detector mode.
3. Average test would be performed if the peak result were greater than the average limit or as required by the applicant.
4. Data of measurement within this frequency range shown " --- " in the table above means the reading of emissions are attenuated more than 20dB below the permissible limits or the field strength is too small to be measured.
5. Measurements above show only up to 6 maximum emissions noted, or would be lesser, with " N/A " remark, if no specific emissions from the EUT are recorded (ie: margin > 20dB from the applicable limit) and considered that's already beyond the background noise floor.
6. Margin (dB) = Remark result (dBuV/m) – Average limit (dBuV/m).



Operation Mode: TX / IEEE 802.11n HT 20 MHz mode / CH High Test Date: November 24, 2010

Temperature: 23°C

Tested by: Wolf Huang

Humidity: 51 % RH

Polarity: Ver. / Hor.

Frequency (MHz)	Reading (Peak) (dBuV)	Reading (Average) (dBuV)	Correction Factor (dB/m)	Result (Peak) (dBuV/m)	Result (Average) (dBuV/m)	Limit (Peak) (dBuV/m)	Limit (Average) (dBuV/m)	Margin (dB)	Remark	Ant. Pol. (H/V)
2270.00	69.44	53.38	-3.35	66.09	50.03	74.00	54.00	-3.97	AVG	V
N/A										
2273.33	64.56	49.47	-3.34	61.22	46.13	74.00	54.00	-7.87	AVG	H
N/A										

Remark:

1. Measuring frequencies from 1 GHz to the 10th harmonic of highest fundamental frequency.
2. Radiated emissions measured in frequency above 1000MHz were made with an instrument using peak/average detector mode.
3. Average test would be performed if the peak result were greater than the average limit or as required by the applicant.
4. Data of measurement within this frequency range shown " --- " in the table above means the reading of emissions are attenuated more than 20dB below the permissible limits or the field strength is too small to be measured.
5. Measurements above show only up to 6 maximum emissions noted, or would be lesser, with " N/A " remark, if no specific emissions from the EUT are recorded (ie: margin > 20dB from the applicable limit) and considered that's already beyond the background noise floor.
6. Margin (dB) = Remark result (dBuV/m) – Average limit (dBuV/m).



Operation Mode: TX / IEEE 802.11n HT 40 MHz mode / CH Low
Temperature: 23°C
Humidity: 51 % RH

Test Date: November 24, 2010
Tested by: Wolf Huang
Polarity: Ver. / Hor.

Frequency (MHz)	Reading (Peak) (dBuV)	Reading (Average) (dBuV)	Correction Factor (dB/m)	Result (Peak) (dBuV/m)	Result (Average) (dBuV/m)	Limit (Peak) (dBuV/m)	Limit (Average) (dBuV/m)	Margin (dB)	Remark	Ant. Pol. (H/V)
2253.33	68.00	55.05	-3.40	64.60	51.65	74.00	54.00	-2.35	AVG	V
N/A										
2243.33	62.53	49.63	-3.42	59.11	46.21	74.00	54.00	-7.79	AVG	H
N/A										

Remark:

1. Measuring frequencies from 1 GHz to the 10th harmonic of highest fundamental frequency.
2. Radiated emissions measured in frequency above 1000MHz were made with an instrument using peak/average detector mode.
3. Average test would be performed if the peak result were greater than the average limit or as required by the applicant.
4. Data of measurement within this frequency range shown " --- " in the table above means the reading of emissions are attenuated more than 20dB below the permissible limits or the field strength is too small to be measured.
5. Measurements above show only up to 6 maximum emissions noted, or would be lesser, with " N/A " remark, if no specific emissions from the EUT are recorded (ie: margin > 20dB from the applicable limit) and considered that's already beyond the background noise floor.
6. Margin (dB) = Remark result (dBuV/m) – Average limit (dBuV/m).



Operation Mode: TX / IEEE 802.11n HT 40 MHz mode
/ CH Mid

Temperature: 23°C

Humidity: 51 % RH

Test Date: November 24, 2010

Tested by: Wolf Huang

Polarity: Ver. / Hor.

Frequency (MHz)	Reading (Peak) (dBuV)	Reading (Average) (dBuV)	Correction Factor (dB/m)	Result (Peak) (dBuV/m)	Result (Average) (dBuV/m)	Limit (Peak) (dBuV/m)	Limit (Average) (dBuV/m)	Margin (dB)	Remark	Ant. Pol. (H/V)
2250.00	69.04	55.58	-3.41	65.63	52.17	74.00	54.00	-1.83	AVG	V
N/A										
2243.33	61.58	48.97	-3.42	58.16	45.55	74.00	54.00	-8.45	AVG	H
N/A										

Remark:

1. Measuring frequencies from 1 GHz to the 10th harmonic of highest fundamental frequency.
2. Radiated emissions measured in frequency above 1000MHz were made with an instrument using peak/average detector mode.
3. Average test would be performed if the peak result were greater than the average limit or as required by the applicant.
4. Data of measurement within this frequency range shown " --- " in the table above means the reading of emissions are attenuated more than 20dB below the permissible limits or the field strength is too small to be measured.
5. Measurements above show only up to 6 maximum emissions noted, or would be lesser, with " N/A " remark, if no specific emissions from the EUT are recorded (ie: margin > 20dB from the applicable limit) and considered that's already beyond the background noise floor.
6. Margin (dB) = Remark result (dBuV/m) – Average limit (dBuV/m).



Operation Mode: TX / IEEE 802.11n HT 40 MHz mode / CH High

Test Date: November 24, 2010

Temperature: 23°C

Tested by: Wolf Huang

Humidity: 51 % RH

Polarity: Ver. / Hor.

Frequency (MHz)	Reading (Peak) (dBuV)	Reading (Average) (dBuV)	Correction Factor (dB/m)	Result (Peak) (dBuV/m)	Result (Average) (dBuV/m)	Limit (Peak) (dBuV/m)	Limit (Average) (dBuV/m)	Margin (dB)	Remark	Ant. Pol. (H/V)
2266.67	67.10	53.12	-3.36	63.74	49.76	74.00	54.00	-4.24	AVG	V
N/A										
2276.67	63.12	48.79	-3.33	59.79	45.46	74.00	54.00	-8.54	AVG	H
N/A										

Remark:

1. Measuring frequencies from 1 GHz to the 10th harmonic of highest fundamental frequency.
2. Radiated emissions measured in frequency above 1000MHz were made with an instrument using peak/average detector mode.
3. Average test would be performed if the peak result were greater than the average limit or as required by the applicant.
4. Data of measurement within this frequency range shown " --- " in the table above means the reading of emissions are attenuated more than 20dB below the permissible limits or the field strength is too small to be measured.
5. Measurements above show only up to 6 maximum emissions noted, or would be lesser, with " N/A " remark, if no specific emissions from the EUT are recorded (ie: margin > 20dB from the applicable limit) and considered that's already beyond the background noise floor.
6. Margin (dB) = Remark result (dBuV/m) – Average limit (dBuV/m).



7.8 POWERLINE CONDUCTED EMISSIONS

LIMIT

According to §15.207(a), except as shown in paragraphs (b) and (c) of this section, for an intentional radiator that is designed to be connected to the public utility (AC) power line, the radio frequency voltage that is conducted back onto the AC power line on any frequency or frequencies within the band 150 kHz to 30 MHz shall not exceed the limits in the following table, as measured using a 50 μ H/50 ohms line impedance stabilization network (LISN). Compliance with the provisions of this paragraph shall be based on the measurement of the radio frequency voltage between each power line and ground at the power terminal. The lower limit applies at the boundary between the frequency ranges.

Frequency Range (MHz)	Limits (dB μ V)	
	Quasi-peak	Average
0.15 to 0.50	66 to 56*	56 to 46*
0.50 to 5	56	46
5 to 30	60	50

* Decreases with the logarithm of the frequency.

Test Configuration

See test photographs attached in Appendix 1 for the actual connections between EUT and support equipment.

TEST PROCEDURE

1. The EUT was placed on a table, which is 0.8m above ground plane.
2. Maximum procedure was performed on the six highest emissions to ensure EUT compliance.
3. Repeat above procedures until all frequency measured were complete.



TEST RESULTS

The initial step in collecting conducted data is a spectrum analyzer peak scan of the measurement range. Significant peaks are then marked as shown on the following data page, and these signals are then quasi-peaked.

Test Data

Operation Mode: Normal Link **Test Date:** January 9, 2011
Temperature: 26°C **Tested by:** David Shu
Humidity: 60% RH

Freq. (MHz)	QP Reading (dBuV)	AV Reading (dBuV)	Corr. factor (dB/m)	QP Result (dBuV/m)	AV Result (dBuV/m)	QP Limit (dBuV)	AV Limit (dBuV)	QP Margin (dB)	AV Margin (dB)	Note
0.1700	50.13	40.03	0.17	50.30	40.20	64.96	54.96	-14.66	-14.76	L1
2.6400	26.78	20.28	0.22	27.00	20.50	56.00	46.00	-29.00	-25.50	L1
3.9800	36.93	25.93	0.27	37.20	26.20	56.00	46.00	-18.80	-19.80	L1
4.8200	29.00	19.00	0.30	29.30	19.30	56.00	46.00	-26.70	-26.70	L1
11.5600	30.69	23.19	0.51	31.20	23.70	60.00	50.00	-28.80	-26.30	L1
24.0600	31.46	27.76	0.74	32.20	28.50	60.00	50.00	-27.80	-21.50	L1
0.2800	42.05	33.15	0.25	42.30	33.40	60.82	50.82	-18.52	-17.42	L2
2.0200	31.43	27.83	0.27	31.70	28.10	56.00	46.00	-24.30	-17.90	L2
3.5900	34.70	24.60	0.30	35.00	24.90	56.00	46.00	-21.00	-21.10	L2
4.0400	34.39	24.29	0.31	34.70	24.60	56.00	46.00	-21.30	-21.40	L2
11.7100	33.32	26.02	0.48	33.80	26.50	60.00	50.00	-26.20	-23.50	L2
24.0600	29.88	27.38	0.72	30.60	28.10	60.00	50.00	-29.40	-21.90	L2

Remark:

1. Measuring frequencies from 0.15 MHz to 30MHz.
2. The emissions measured in frequency range from 0.15 MHz to 30MHz were made with an instrument using Quasi-peak detector and average detector.
3. The IF bandwidth of SPA between 0.15MHz and 30MHz was 10 kHz; the IF bandwidth of Test Receiver between 0.15MHz and 30MHz was 9 kHz;
4. L1 = Line One (Live Line) / L2 = Line Two (Neutral Line)



Test Plots

Conducted emissions (Line 1)

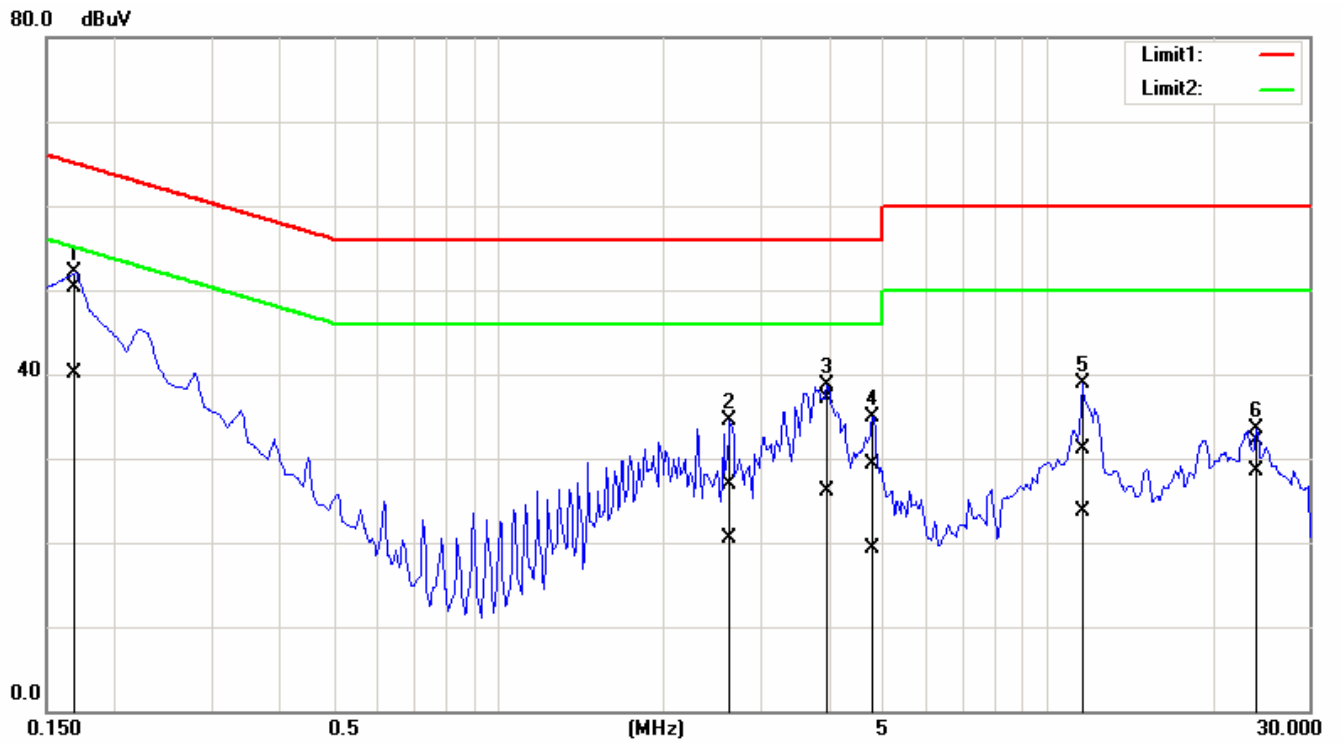

Conducted emissions (Line 2)

