

ELECTROMAGNETIC EMISSIONS COMPLIANCE REPORT

INTENTIONAL RADIATOR CERTIFICATION TO FCC PART 15 SUBPART C REQUIREMENT

OF

Product Name: High Power Wireless Outdoor Bridge/AP/CPE
LanReady, CenWell, Cerio, 4ipnet, CLYDON, Grand-tek,

Brand Name: Phenet, RASPBERRY, Trendware, Wavcore, PCI, USC, CIPHERIUM
WCB1000H5PX, WCB1000H5PZ, WCB1010H5PX, WCB1010H5PZ, CRB-1000H5PX, CRB-1010H5PX, OW-100HG, OW-110HG, OWL500, OWL510,

Model Name: WaveMax 2450, AC-1022-SG, GLB-1022-SG, CPE-2000GN-1, CPE-2010G, SuperStorm2, TEW-455APBO v2, TEW-456APBO, WV-100CPE, WV-110CPE, CQW-1000OD, CQW-1010OD, A561, A560

Model Difference: Please refer to page 6 for detail

FCC ID: SCD020052

Report No.: ER/2009/50032

Issue Date: Jul. 06, 2009

FCC Rule Part: §15.247, Cat: DTS

Prepared for: LanReady Technologies Inc.
3F, No. 116, Sinhu 2nd Rd., Neihu District, Taipei City 114, Taiwan (R.O.C.)

Prepared by: SGS Taiwan Ltd.
Electronics & Communication Laboratory
No. 134, Wu Kung Rd., Wuku Industrial Zone, Taipei County, Taiwan



Note: This report shall not be reproduced except in full, without the written approval of SGS Taiwan Ltd. This document may be altered or revised by SGS Taiwan Ltd. personnel only, and shall be noted in the revision section of the document.

Unless otherwise stated the results shown in this test report refer only to the sample(s) tested. This test report cannot be reproduced, except in full, without prior written permission of the Company. 除非另有說明，此報告結果僅對測試之樣品負責。本報告未經本公司書面許可，不可部份複製。
This Test Report is issued by the Company under its General Conditions of Service which is available on request or accessible at http://www.sgs.com/terms_and_conditions.htm. Attention is drawn to the limitation of liability, indemnification and jurisdiction issues defined therein. Any holder of this Test Report is advised that information contained hereon reflects the Company's findings at the time of its intervention only and within the limits of Client's instructions, if any. The Company's sole responsibility is to its Client and this document does not exonerate parties to a transaction from exercising all their rights and obligations under the transaction documents. Any unauthorized alteration, forgery or falsification of the content or appearance of this document is unlawful and offenders may be prosecuted to the fullest extent of the law.

VERIFICATION OF COMPLIANCE

Applicant: LanReady Technologies Inc.
3F, No. 116, Sinhu 2nd Rd., Neihsu District, Taipei City 114, Taiwan (R.O.C.)

Equipment Under Test: High Power Wireless Outdoor Bridge/AP/CPE
LanReady, CenWell, Cerio, 4ipnet, CLYDON, Grand-tek,

Brand Name: Pheenet, RASPBERRY, Trendware, Wavecore, PCI, USC,
Cipherium

Model No.: WCB1000H5PX, WCB1000H5PZ, WCB1010H5PX, WCB1010H5PZ,
CRB-1000H5PX, CRB-1010H5PX, OW-100HG, OW-110HG, OWL500, OWL510,
WaveMax 2450, AC-1022-SG, GLB-1022-SG, CPE-2000GN-1, CPE-2010G,
SuperStorm2, TEW-455APBO v2, TEW-456APBO, WV-100CPE, WV-110CPE,
CQW-1000OD, CQW-1010OD, A561, A560

Model Difference: Please refer to page 6 for detail

FCC ID: SCD020052

File Number: ER/2009/50032



Date of test: May. 25, 2009 ~ Jul. 05, 2009

Date of EUT Received: May. 25, 2009

We hereby certify that:

The above equipment was tested by SGS Taiwan Ltd. The test data, data evaluation, test procedures, and equipment configurations shown in this report were made in accordance with the procedures given in ANSI C63.4 (2003) and the energy emitted by the sample EUT tested as described in this report is in compliance with conducted and radiated emission limits of FCC Rules Part 15.247.

The test results of this report relate only to the tested sample identified in this report.

Test By:		Date	Jul. 06, 2009
	_____ <i>Brian Chang / Engineer</i>		_____
Prepared By:		Date	Jul. 06, 2009
	_____ <i>Alex Hsieh / Sr. Engineer</i>		_____
Approved By:		Date	Jul. 06, 2009
	_____ <i>Jim Chang / Supervisor</i>		_____

Unless otherwise stated the results shown in this test report refer only to the sample(s) tested. This test report cannot be reproduced, except in full, without prior written permission of the Company. 除非另有說明，此報告結果僅對測試之樣品負責。本報告未經本公司書面許可，不可部份複製。
This Test Report is issued by the Company under its General Conditions of Service which is available on request or accessible at http://www.sgs.com/terms_and_conditions.htm. Attention is drawn to the limitation of liability, indemnification and jurisdiction issues defined therein. Any holder of this Test Report is advised that information contained hereon reflects the Company's findings at the time of its intervention only and within the limits of Client's instructions, if any. The Company's sole responsibility is to its Client and this document does not exonerate parties to a transaction from exercising all their rights and obligations under the transaction documents. Any unauthorized alteration, forgery or falsification of the content or appearance of this document is unlawful and offenders may be prosecuted to the fullest extent of the law.

Version

Version No.	Date	Description
00	Jul. 06, 2009	Initial creation of document
01	Aug. 28, 2009	Update spurious emission below 30MHz data
02	Sep. 03, 2009	Revise peak output power data
03	Sep. 04, 2009	Change Omni antenna to Patch antenna
04	Sep. 29, 2009	Add Patch 4 external antenna
05	Oct. 12, 2009	Revise incorrect information of antenna
06	Oct. 21, 2009	Revise of section 11.2 for antenna connector description

Unless otherwise stated the results shown in this test report refer only to the sample(s) tested. This test report cannot be reproduced, except in full, without prior written permission of the Company. 除非另有說明，此報告結果僅對測試之樣品負責。本報告未經本公司書面許可，不可部份複製。

This Test Report is issued by the Company under its General Conditions of Service which is available on request or accessible at http://www.sgs.com/terms_and_conditions.htm. Attention is drawn to the limitation of liability, indemnification and jurisdiction issues defined therein. Any holder of this Test Report is advised that information contained hereon reflects the Company's findings at the time of its intervention only and within the limits of Client's instructions, if any. The Company's sole responsibility is to its Client and this document does not exonerate parties to a transaction from exercising all their rights and obligations under the transaction documents. Any unauthorized alteration, forgery or falsification of the content or appearance of this document is unlawful and offenders may be prosecuted to the fullest extent of the law. ◦

Table of Contents

1. GENERAL INFORMATION	7
1.1. Related Submittal(s) / Grant (s)	8
1.2. Test Methodology	8
1.3. Test Facility	8
1.4. Special Accessories	8
1.5. Equipment Modifications	8
2. SYSTEM TEST CONFIGURATION	9
2.1. EUT Configuration	9
2.2. EUT Exercise	9
2.3. Test Procedure	9
2.4. Configuration of Tested System	10
3. SUMMARY OF TEST RESULTS	11
4. DESCRIPTION OF TEST MODES	11
5. CONDUCTED EMISSION TEST	12
5.1. Standard Applicable	12
5.2. EUT Setup	12
5.3. Measurement Procedure	12
5.4. Measurement Equipment Used:	13
5.5. Measurement Result	13
6. PEAK OUTPUT POWER MEASUREMENT	18
6.1. Standard Applicable	18
6.2. Measurement Procedure	19
6.3. Measurement Equipment Used:	19
6.4. Measurement Result	20
7. 6dB Bandwidth	25
7.1. Standard Applicable	25
7.2. Measurement Procedure	25
7.3. Measurement Equipment Used:	25
7.4. Measurement Result	26
8. 100KHz BANDWIDTH OF BAND EDGES MEASUREMENT	31
8.1. Standard Applicable	31
8.2. Measurement Procedure	31
8.3. Measurement Equipment Used:	31
8.4. Measurement Result	31

Unless otherwise stated the results shown in this test report refer only to the sample(s) tested. This test report cannot be reproduced, except in full, without prior written permission of the Company. 除非另有說明，此報告結果僅對測試之樣品負責。本報告未經本公司書面許可，不可部份複製。
 This Test Report is issued by the Company under its General Conditions of Service which is available on request or accessible at http://www.sgs.com/terms_and_conditions.htm. Attention is drawn to the limitation of liability, indemnification and jurisdiction issues defined therein. Any holder of this Test Report is advised that information contained hereon reflects the Company's findings at the time of its intervention only and within the limits of Client's instructions, if any. The Company's sole responsibility is to its Client and this document does not exonerate parties to a transaction from exercising all their rights and obligations under the transaction documents. Any unauthorized alteration, forgery or falsification of the content or appearance of this document is unlawful and offenders may be prosecuted to the fullest extent of the law.

9. SPURIOUS RADIATED EMISSION TEST.....	38
9.1. Standard Applicable	38
9.2. EUT Setup.....	38
9.3. Measurement Procedure.....	38
9.4. Test SET-UP (Block Diagram of Configuration).....	39
9.5. Measurement Equipment Used:	40
9.6. Field Strength Calculation	40
9.7. Measurement Result.....	40
10. Peak Power Spectral Density	65
10.1. Standard Applicable	65
10.2. Measurement Procedure.....	65
10.3. Measurement Equipment Used:	65
10.4. Measurement Result.....	66
11. ANTENNA REQUIREMENT	71
11.1. Standard Applicable	71
11.2. Antenna Connected Construction	71

Unless otherwise stated the results shown in this test report refer only to the sample(s) tested. This test report cannot be reproduced, except in full, without prior written permission of the Company. 除非另有說明，此報告結果僅對測試之樣品負責。本報告未經本公司書面許可，不可部份複製。

This Test Report is issued by the Company under its General Conditions of Service which is available on request or accessible at http://www.sgs.com/terms_and_conditions.htm. Attention is drawn to the limitation of liability, indemnification and jurisdiction issues defined therein. Any holder of this Test Report is advised that information contained hereon reflects the Company's findings at the time of its intervention only and within the limits of Client's instructions, if any. The Company's sole responsibility is to its Client and this document does not exonerate parties to a transaction from exercising all their rights and obligations under the transaction documents. Any unauthorized alteration, forgery or falsification of the content or appearance of this document is unlawful and offenders may be prosecuted to the fullest extent of the law. ◦

Model difference table					
		Big Housing	Mid Housing	Small Housing	Small Housing
Antenna	Brand	Patch 1	Patch 2	Patch 3	Patch 4
1	Grand-tek	GLB-1022-SG	AC-1022-SG		
2	Trendware	TEW-455APBO v2			
3	Trendware	TEW-456APBO			
4	Pheenet			CPE2010G	CPE-2000GN-1
5	Cerio			OW-110HG	OW-100HG
6	CLYDON				WaveMax 2450
7	RASPBERRY			SuperStorm2	
8	4ipnet			OWL510	OWL500
9	LanReady			WCB1010H5PX	WCB1000H5PX
				WCB1010H5PZ	WCB1000H5PZ
10	CenWell			CRB-1010H5PX	CRB-1000H5PX
11	Wavecore			WV-110CPE	WV-100CPE
12	PCI			CQW-1010OD	CQW-1000OD
13	USC			A561	A560
14	Cipherium			A561	A560

Unless otherwise stated the results shown in this test report refer only to the sample(s) tested. This test report cannot be reproduced, except in full, without prior written permission of the Company. 除非另有說明，此報告結果僅對測試之樣品負責。本報告未經本公司書面許可，不可部份複製。

This Test Report is issued by the Company under its General Conditions of Service which is available on request or accessible at http://www.sgs.com/terms_and_conditions.htm. Attention is drawn to the limitation of liability, indemnification and jurisdiction issues defined therein. Any holder of this Test Report is advised that information contained hereon reflects the Company's findings at the time of its intervention only and within the limits of Client's instructions, if any. The Company's sole responsibility is to its Client and this document does not exonerate parties to a transaction from exercising all their rights and obligations under the transaction documents. Any unauthorized alteration, forgery or falsification of the content or appearance of this document is unlawful and offenders may be prosecuted to the fullest extent of the law.

1. GENERAL INFORMATION

General:

Product Name	High Power Wireless Outdoor Bridge/AP/CPE	
Brand Name	LanReady, CenWell, Cerio, 4ipnet,CLYDON, Grand-tek, Pheenet, RASPBERRY, Trendware, Wavecore, PCI, USC, CIPHERIUM	
Model Name	WCB1000H5PX, WCB1000H5PZ, WCB1010H5PX, WCB1010H5PZ, CRB-1000H5PX, CRB-1010H5PX, OW-100HG, OW-110HG, OWL500, OWL510, WaveMax 2450, AC-1022-SG, GLB-1022-SG, CPE-2000GN-1, CPE-2010G, SuperStorm2, TEW-455APBO v2, TEW-456APBO, WV-100CPE, WV-110CPE, CQW-1000OD, CQW-1010OD, A561, A560	
Model Difference	Please refer to page 6 for detail	
Power Supply	18V or 48V dc by AC/DC power adapter	
	Adapter:	<ol style="list-style-type: none"> 1. Model No.: A5-20S48V 2. Model No.: SW1801000-W01

WLAN:

Frequency Range:	2412 – 2462 MHz
Channel number:	11 channels
Max. Output Power:	Patch 1 Internal Antenna 802.11 b: 26.85 dBm (Peak) 802.11 g: 24.15 dBm (Peak)
Modulation Technology:	DSSS, OFDM
Modulation type:	CCK, DQPSK, DBPSK for DSSS 64QAM, 16QAM, QPSK, BPSK for OFDM
Transition Rate:	802.11 b: 1/2/5.5/11 Mbps; 802.11 g: 6/9/12/18/24/36/48/54 Mbps
Antenna Designation:	Patch 4 External Antenna, Gain:8.66dBi Patch 3 Internal Antenna, Gain:8.94dBi Patch 2 Internal Antenna, Gain:11.29dBi Patch 1 Internal Antenna, Gain:12.84dBi
Type of Emission	16M48M4D

The EUT is compliance with IEEE 802.11 b/g Standard.

This test report applies for 802.11b/g WLAN.

Unless otherwise stated the results shown in this test report refer only to the sample(s) tested. This test report cannot be reproduced, except in full, without prior written permission of the Company. 除非另有說明，此報告結果僅對測試之樣品負責。本報告未經本公司書面許可，不可部份複製。
 This Test Report is issued by the Company under its General Conditions of Service which is available on request or accessible at http://www.sgs.com/terms_and_conditions.htm. Attention is drawn to the limitation of liability, indemnification and jurisdiction issues defined therein. Any holder of this Test Report is advised that information contained hereon reflects the Company's findings at the time of its intervention only and within the limits of Client's instructions, if any. The Company's sole responsibility is to its Client and this document does not exonerate parties to a transaction from exercising all their rights and obligations under the transaction documents. Any unauthorized alteration, forgery or falsification of the content or appearance of this document is unlawful and offenders may be prosecuted to the fullest extent of the law.

1.1. Related Submittal(s) / Grant (s)

This submittal(s) (test report) is intended for FCC ID: SCD020052 filing to comply with Section 15.247 of the FCC Part 15, Subpart C Rules. The composite system (digital device) is compliance with Subpart B is authorized under a Doc procedure.

1.2. Test Methodology

Both conducted and radiated testing were performed according to the procedures in ANSI C63.4 (2003). Radiated testing was performed at an antenna to EUT distance 3 meters.

1.3. Test Facility

The measurement facilities used to collect the 3m Radiated Emission and AC power line conducted data are located on the address of SGS Taiwan Ltd. Electronics & Communication Laboratory No. 134, Wu Kung Rd., Wuku Industrial Zone, Taipei Country, Taiwan which are constructed and calibrated to meet the FCC requirements in documents ANSI C63.4: 2003. FCC Registration Number are: 990257 and 236194, Canada Registration Number: 4620A-1

The 10 m Open Area Test Sites located on the address of SGS Taiwan Ltd. Electronics & Communication Laboratory No. 29, Pau-Tou-Tsuo Valley Chia-Pau Tsuen, Linkou Hsiang, Taipei county, which is constructed and calibrated to meet the CISPR 22/EN 55022 requirements. SGS Site No. 1(3 &10 meters) and FCC Registration Number: 94644.

1.4. Special Accessories

Not available for this EUT intended for grant.

1.5. Equipment Modifications

Not available for this EUT intended for grant.

Unless otherwise stated the results shown in this test report refer only to the sample(s) tested. This test report cannot be reproduced, except in full, without prior written permission of the Company. 除非另有說明，此報告結果僅對測試之樣品負責。本報告未經本公司書面許可，不可部份複製。

This Test Report is issued by the Company under its General Conditions of Service which is available on request or accessible at http://www.sgs.com/terms_and_conditions.htm. Attention is drawn to the limitation of liability, indemnification and jurisdiction issues defined therein. Any holder of this Test Report is advised that information contained hereon reflects the Company's findings at the time of its intervention only and within the limits of Client's instructions, if any. The Company's sole responsibility is to its Client and this document does not exonerate parties to a transaction from exercising all their rights and obligations under the transaction documents. Any unauthorized alteration, forgery or falsification of the content or appearance of this document is unlawful and offenders may be prosecuted to the fullest extent of the law. ◦

2. SYSTEM TEST CONFIGURATION

2.1. EUT Configuration

The EUT configuration for testing is installed on RF field strength measurement to meet the Commissions requirement and operating in a manner which intends to maximize its emission characteristics in a continuous normal application.

2.2. EUT Exercise

The EUT (Transmitter) was operated in the engineering mode to fix the Tx frequency that was for the purpose of the measurements.

2.3. Test Procedure

2.3.1 Conducted Emissions

The EUT is a placed on as turn table which is 0.8 m above ground plane. According to the requirements in Section 7 and 13 of ANSI C63.4-2003. Conducted emissions from the EUT measured in the frequency range between 0.15 MHz and 30MHz using CISPR Quasi-Peak and Average detector mode.

2.3.2 Radiated Emissions

The EUT is a placed on as turn table which is 0.8 m above ground plane. The turn table shall rotate 360 degrees to determine the position of maximum emission level. EUT is set 3m away from the receiving antenna which varied from 1m to 4m to find out the highest emission. And also, each emission was to be maximized by changing the polarization of receiving antenna both horizontal and vertical. In order to find out the max. emission, the relative positions of this hand-held transmitter (EUT) was rotated through three orthogonal axes and measurement procedures for electric field radiated emissions above 1 GHz the EUT measurement is to be made "while keeping the antenna in the 'cone of radiation' from that area and pointed at the area both in azimuth and elevation, with polarization oriented for maximum response." is still within the 3dB illumination BW of the measurement antenna. according to the requirements in Section 8 and 13 and Subclause 8.3.1.2 of ANSI C63.4-2003.

Unless otherwise stated the results shown in this test report refer only to the sample(s) tested. This test report cannot be reproduced, except in full, without prior written permission of the Company. 除非另有說明，此報告結果僅對測試之樣品負責。本報告未經本公司書面許可，不可部份複製。

This Test Report is issued by the Company under its General Conditions of Service which is available on request or accessible at http://www.sgs.com/terms_and_conditions.htm. Attention is drawn to the limitation of liability, indemnification and jurisdiction issues defined therein. Any holder of this Test Report is advised that information contained hereon reflects the Company's findings at the time of its intervention only and within the limits of Client's instructions, if any. The Company's sole responsibility is to its Client and this document does not exonerate parties to a transaction from exercising all their rights and obligations under the transaction documents. Any unauthorized alteration, forgery or falsification of the content or appearance of this document is unlawful and offenders may be prosecuted to the fullest extent of the law.

2.4. Configuration of Tested System

Fig. 2-1 AC Power line Configuration

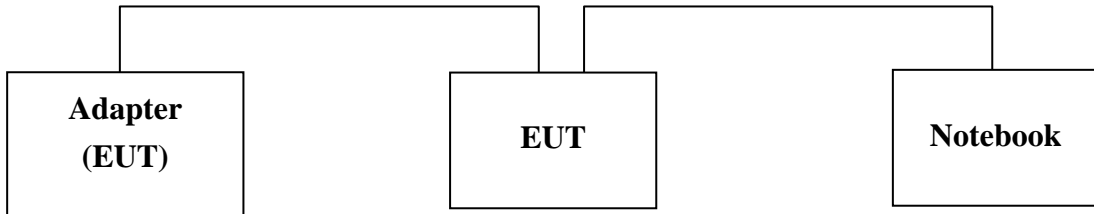

Fig. 2-2 Radiated Emission Configuration

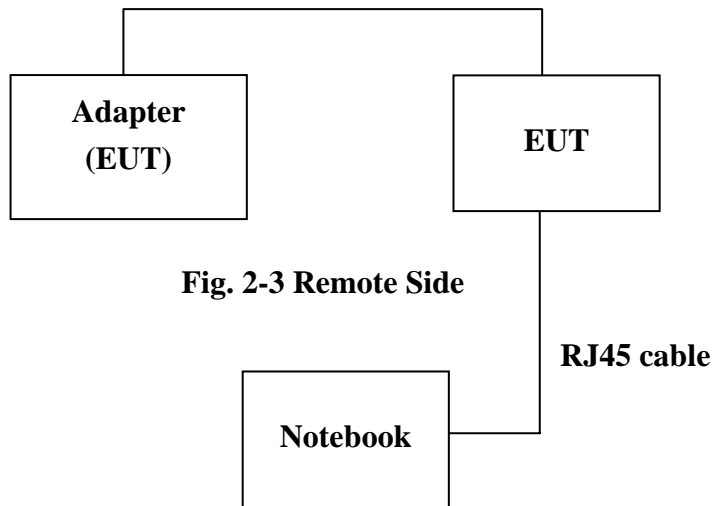

Fig. 2-3 Remote Side

Table 2-1 Equipment Used in Tested System

Item	Equipment	Mfr/Brand	Model/ Type No.	Series No.	Data Cable	Power Cord
1.	WiFi Software	N/A	TFTPD32 V3.28	N/A	N/A	N/A
2.	Notebook	IBM	T43	L3LHHN6	N/A	180cm, Un-shielded
3.	AC Adaptor	N/A	A5-20S48V	N/A	N/A	180cm, Un-shielded
4.	AC Adaptor	N/A	SW1801000-W01	N/A	N/A	180cm, Un-shielded
5.	RJ45 cable	N/A	N/A	N/A	Un-shielded	N/A

Unless otherwise stated the results shown in this test report refer only to the sample(s) tested. This test report cannot be reproduced, except in full, without prior written permission of the Company. 除非另有說明，此報告結果僅對測試之樣品負責。本報告未經本公司書面許可，不可部份複製。
 This Test Report is issued by the Company under its General Conditions of Service which is available on request or accessible at http://www.sgs.com/terms_and_conditions.htm. Attention is drawn to the limitation of liability, indemnification and jurisdiction issues defined therein. Any holder of this Test Report is advised that information contained hereon reflects the Company's findings at the time of its intervention only and within the limits of Client's instructions, if any. The Company's sole responsibility is to its Client and this document does not exonerate parties to a transaction from exercising all their rights and obligations under the transaction documents. Any unauthorized alteration, forgery or falsification of the content or appearance of this document is unlawful and offenders may be prosecuted to the fullest extent of the law.

3. SUMMARY OF TEST RESULTS

FCC Rules	Description Of Test	Result
§15.207(a)	AC Power Line Conducted Emission	Compliant
§15.247(b) (3),(4)(c)	Peak Output Power	Compliant
§15.247(a)(2)	6dB Bandwidth	Compliant
§15.247(d)	100 KHz Bandwidth Of Frequency Band Edges	Compliant
§15.247(d)	Spurious Emission	Compliant
§15.247(e)	Peak Power Density	Compliant
§15.203	Antenna Requirement	Compliant

4. DESCRIPTION OF TEST MODES

The EUT has been tested under operating condition.

Test program used to control the EUT for staying in continuous transmitting and receiving mode is programmed.

802.11 b mode: Channel low (2412MHz) 、 mid (2437MHz) and high (2462MHz) with 1Mbps data rate are chosen for full testing.

802.11 g mode: Channel low (2412MHz) 、 mid (2437MHz) and high (2462MHz) with 6Mbps data rate are chosen for full testing.

The field strength of radiation emission was measured as EUT stand-up position E1 mode for 802.11b/g WLAN Transmitter for channel Low, Mid and High, the worst case E1 position was reported.

All measurement data are test by worst case WLAN antenna:
Patch 1 internal antenna has worst data.

5. CONDUCTED EMISSION TEST

5.1. Standard Applicable

According to §15.207. frequency within 150KHz to 30MHz shall not exceed the Limit table as below.

Frequency range MHz	Limits dB(uV)	
	Quasi-peak	Average
0.15 to 0.50	66 to 56	56 to 46
0.50 to 5	56	46
5 to 30	60	50

Note

- 1.The lower limit shall apply at the transition frequencies
- 2.The limit decreases linearly with the logarithm of the frequency in the range 0.15 MHz to 0.50 MHz.

5.2. EUT Setup

1. The conducted emission tests were performed in the test site, using the setup in accordance with the ANSI C63.4-2003.
2. The AC/DC Power adaptor of EUT was plug-in LISN. The rear of the EUT and peripherals were placed flushed with the rear of the tabletop.
3. The LISN was connected with 120Vac/60Hz power source.

5.3. Measurement Procedure

1. The EUT was placed on a table which is 0.8m above ground plane.
2. Maximum procedure was performed on the six highest emissions to ensure EUT compliance.
3. Repeat above procedures until all frequency measured were complete.

Unless otherwise stated the results shown in this test report refer only to the sample(s) tested. This test report cannot be reproduced, except in full, without prior written permission of the Company. 除非另有說明，此報告結果僅對測試之樣品負責。本報告未經本公司書面許可，不可部份複製。
 This Test Report is issued by the Company under its General Conditions of Service which is available on request or accessible at http://www.sgs.com/terms_and_conditions.htm. Attention is drawn to the limitation of liability, indemnification and jurisdiction issues defined therein. Any holder of this Test Report is advised that information contained hereon reflects the Company's findings at the time of its intervention only and within the limits of Client's instructions, if any. The Company's sole responsibility is to its Client and this document does not exonerate parties to a transaction from exercising all their rights and obligations under the transaction documents. Any unauthorized alteration, forgery or falsification of the content or appearance of this document is unlawful and offenders may be prosecuted to the fullest extent of the law.

5.4. Measurement Equipment Used:

Conducted Emission Test Site					
EQUIPMENT TYPE	MFR	MODEL NUMBER	SERIAL NUMBER	LAST CAL.	CAL DUE.
EMI Test Receiver	R&S	ESCS30	828985/004	09/15/2008	09/14/2009
LISN	Rolf-Heine	NNB-2/16Z	99012	02/18/2009	02/17/2010
LISN	FCC	FCC-LISN-50/250-25-2-01	04034	02/18/2009	02/17/2010
Coaxial Cables	N/A	WK CE Cable	N/A	10/30/2008	10/29/2009

5.5. Measurement Result

The initial step in collecting conducted data is a spectrum analyzer peak scan of the measurement range. Significant peaks are then marked as shown on the following data page, and these signals are then quasi-peaked.

Unless otherwise stated the results shown in this test report refer only to the sample(s) tested. This test report cannot be reproduced, except in full, without prior written permission of the Company. 除非另有說明，此報告結果僅對測試之樣品負責。本報告未經本公司書面許可，不可部份複製。

This Test Report is issued by the Company under its General Conditions of Service which is available on request or accessible at http://www.sgs.com/terms_and_conditions.htm. Attention is drawn to the limitation of liability, indemnification and jurisdiction issues defined therein. Any holder of this Test Report is advised that information contained hereon reflects the Company's findings at the time of its intervention only and within the limits of Client's instructions, if any. The Company's sole responsibility is to its Client and this document does not exonerate parties to a transaction from exercising all their rights and obligations under the transaction documents. Any unauthorized alteration, forgery or falsification of the content or appearance of this document is unlawful and offenders may be prosecuted to the fullest extent of the law. ◦

AC POWER LINE CONDUCTED EMISSION TEST DATA

Operation Mode:	WLAN Link (Adapter 1)		Test Date:	Jun. 30, 2009	
Temperature:	23 °C	Humidity:	58 %	Test By:	Brian

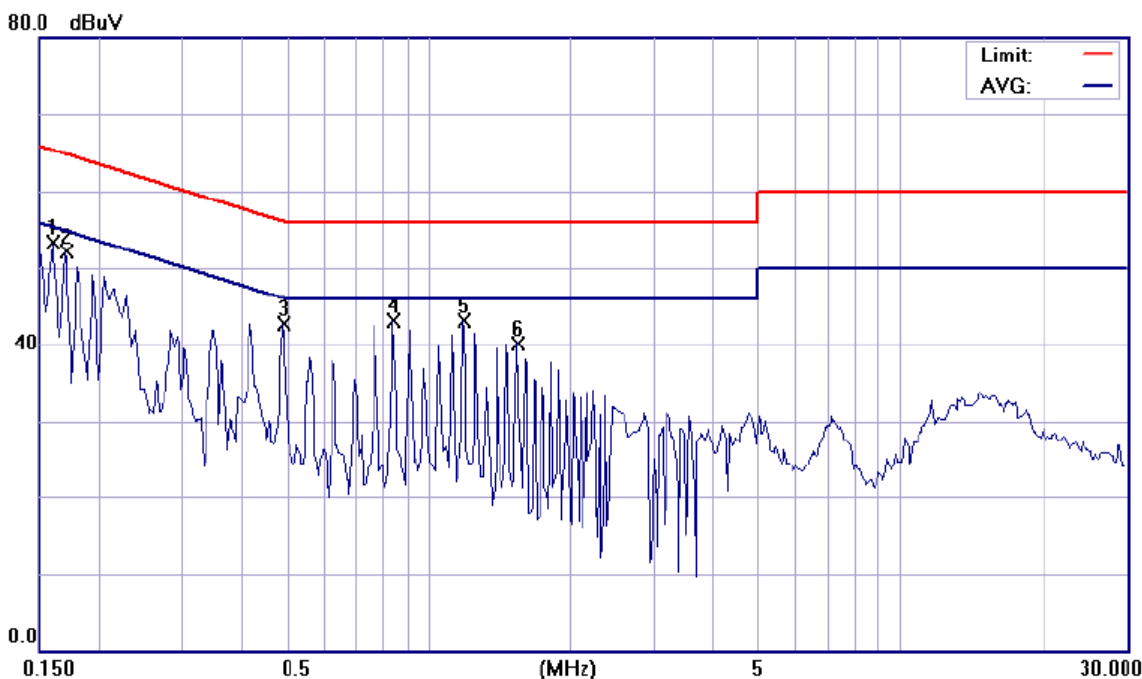

Site SGS CONDUCTED #1 Phase: **L1** Temperature: 23 °C
 Limit: FCC Class B Conduction(QP) Power: AC 120V/60Hz Humidity: 58 %
 EUT: IEEE802.11b/g AP Distance: Air Pressure: hpa
 M/N: WCB1000H5P
 Note: WLAN LINK-Adapter#1(A5-20S48-V)

No.	Mk.	Freq.	Reading Level	Factor	Measurement	Limit	Over	Detector	Comment
		MHz	dBuV	dB	dBuV	dBuV	dB		
1	*	0.1600	53.12	0.16	53.28	65.46	-12.18	peak	
2		0.1700	52.02	0.15	52.17	64.96	-12.79	peak	
3		0.4900	42.60	0.07	42.67	56.17	-13.50	peak	
4		0.8400	43.09	0.08	43.17	56.00	-12.83	peak	
5		1.1900	43.06	0.10	43.16	56.00	-12.84	peak	
6		1.5400	40.09	0.11	40.20	56.00	-15.80	peak	

Unless otherwise stated the results shown in this test report refer only to the sample(s) tested. This test report cannot be reproduced, except in full, without prior written permission of the Company. 除非另有說明，此報告結果僅對測試之樣品負責。本報告未經本公司書面許可，不可部份複製。
 This Test Report is issued by the Company under its General Conditions of Service which is available on request or accessible at http://www.sgs.com/terms_and_conditions.htm. Attention is drawn to the limitation of liability, indemnification and jurisdiction issues defined therein. Any holder of this Test Report is advised that information contained hereon reflects the Company's findings at the time of its intervention only and within the limits of Client's instructions, if any. The Company's sole responsibility is to its Client and this document does not exonerate parties to a transaction from exercising all their rights and obligations under the transaction documents. Any unauthorized alteration, forgery or falsification of the content or appearance of this document is unlawful and offenders may be prosecuted to the fullest extent of the law.

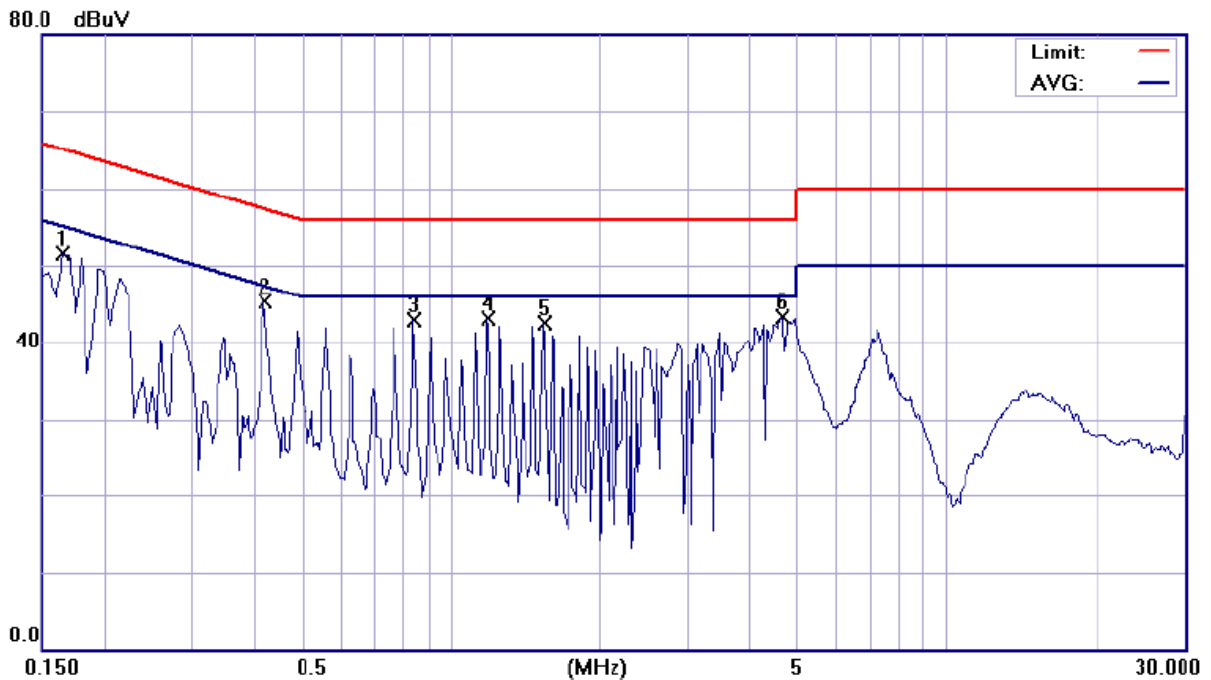

Site: SGS CONDUCTED #1
 Limit: FCC Class B Conduction(QP)
 EUT: IEEE802.11b/g AP
 M/N: WCB1000H5P
 Note: WLAN LINK-Adapter#1(A5-20S48-V)

Phase: N
 Power: AC 120V/60Hz
 Distance:

Temperature: 23 °C
 Humidity: 58 %
 Air Pressure: hpa

No.	Mk.	Freq. MHz	Reading Level dBuV	Factor dB	Measure- ment dBuV	Limit dBuV	Over dB	Detector	Comment
1		0.1650	51.24	0.17	51.41	65.21	-13.80	peak	
2	*	0.4200	45.22	0.09	45.31	57.45	-12.14	peak	
3		0.8400	42.79	0.09	42.88	56.00	-13.12	peak	
4		1.1900	43.00	0.11	43.11	56.00	-12.89	peak	
5		1.5400	42.42	0.12	42.54	56.00	-13.46	peak	
6		4.6250	43.09	0.17	43.26	56.00	-12.74	peak	

Unless otherwise stated the results shown in this test report refer only to the sample(s) tested. This test report cannot be reproduced, except in full, without prior written permission of the Company. 除非另有說明，此報告結果僅對測試之樣品負責。本報告未經本公司書面許可，不可部份複製。
 This Test Report is issued by the Company under its General Conditions of Service which is available on request or accessible at http://www.sgs.com/terms_and_conditions.htm. Attention is drawn to the limitation of liability, indemnification and jurisdiction issues defined therein. Any holder of this Test Report is advised that information contained hereon reflects the Company's findings at the time of its intervention only and within the limits of Client's instructions, if any. The Company's sole responsibility is to its Client and this document does not exonerate parties to a transaction from exercising all their rights and obligations under the transaction documents. Any unauthorized alteration, forgery or falsification of the content or appearance of this document is unlawful and offenders may be prosecuted to the fullest extent of the law.

Operation Mode:	WLAN Link (Adapter 2)		Test Date:	Jun. 30, 2009	
Temperature:	24 °C	Humidity:	60 %	Test By:	Brian

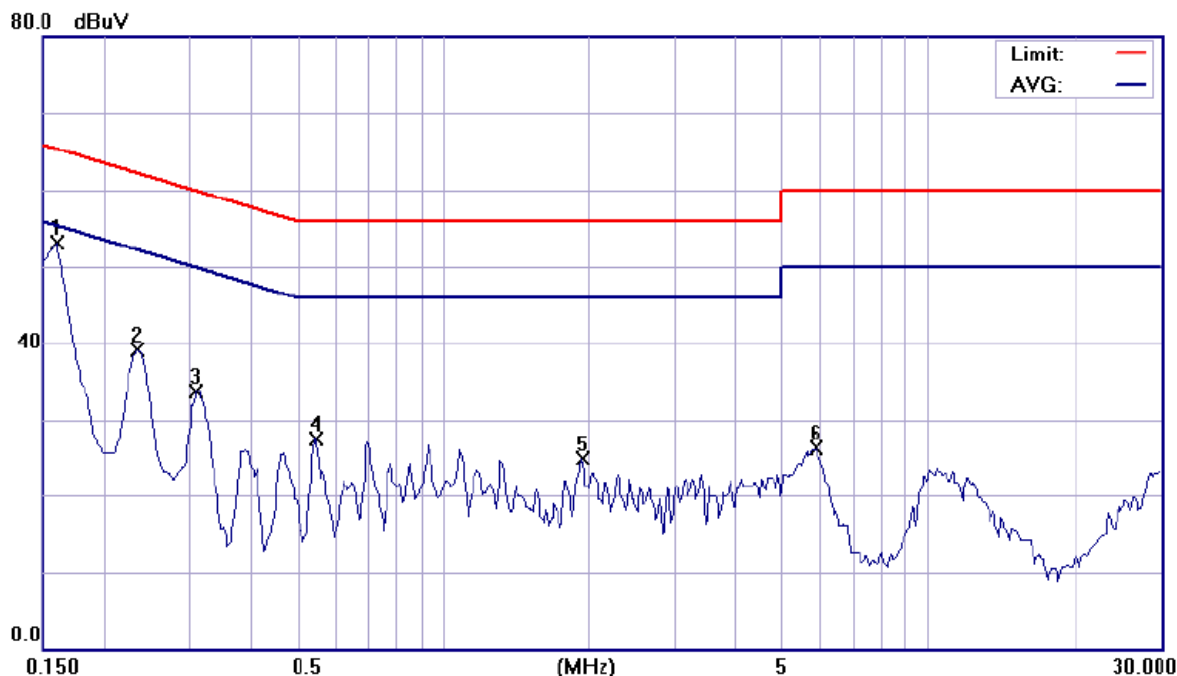

Site SGS CONDUCTED #1	Phase: L1	Temperature: 23 °C
Limit: FCC Class B Conduction(QP)	Power: AC 120V/60Hz	Humidity: 58 %
EUT: IEEE802.11b/g AP	Distance:	Air Pressure: hpa
M/N: WCB1000H5P		
Note: WLAN LINK-Adapter#2(SW1801000-W01)		

No.	Mk.	Freq. MHz	Reading Level dBuV	Factor dB	Measure- ment dBuV	Limit dBuV	Over dB	Detector	Comment
1	*	0.1600	52.87	0.16	53.03	65.46	-12.43	peak	
2		0.2350	38.97	0.11	39.08	62.27	-23.19	peak	
3		0.3100	33.66	0.10	33.76	59.97	-26.21	peak	
4		0.5450	27.53	0.07	27.60	56.00	-28.40	peak	
5		1.9350	24.75	0.13	24.88	56.00	-31.12	peak	
6		5.8900	26.02	0.20	26.22	60.00	-33.78	peak	

Unless otherwise stated the results shown in this test report refer only to the sample(s) tested. This test report cannot be reproduced, except in full, without prior written permission of the Company. 除非另有說明，此報告結果僅對測試之樣品負責。本報告未經本公司書面許可，不可部份複製。
 This Test Report is issued by the Company under its General Conditions of Service which is available on request or accessible at http://www.sgs.com/terms_and_conditions.htm. Attention is drawn to the limitation of liability, indemnification and jurisdiction issues defined therein. Any holder of this Test Report is advised that information contained hereon reflects the Company's findings at the time of its intervention only and within the limits of Client's instructions, if any. The Company's sole responsibility is to its Client and this document does not exonerate parties to a transaction from exercising all their rights and obligations under the transaction documents. Any unauthorized alteration, forgery or falsification of the content or appearance of this document is unlawful and offenders may be prosecuted to the fullest extent of the law.

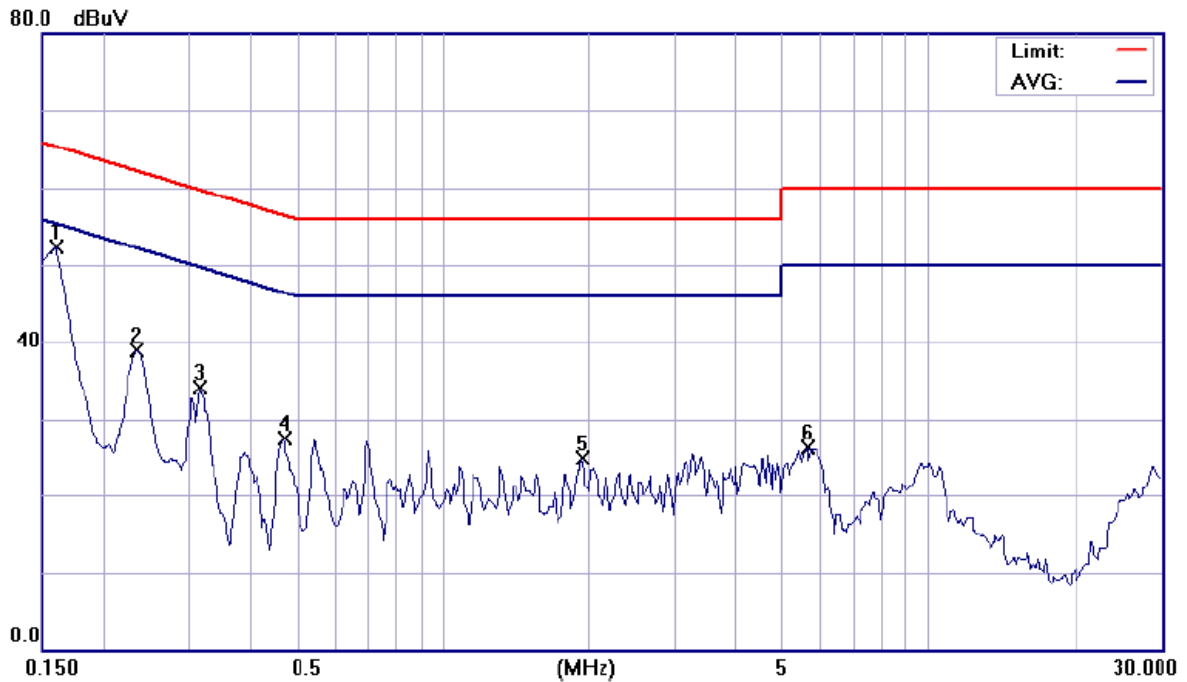

Site SGS CONDUCTED #1

Phase: **N**

Temperature: 23 °C

Limit: FCC Class B Conduction(QP)

Power: AC 120V/60Hz

Humidity: 58 %

EUT: IEEE802.11b/g AP

Distance:

Air Pressure: hpa

M/N: WCB1000H5P

Note: WLAN LINK-Adapter#2(SW1801000-W01)

No.	Mk.	Freq. MHz	Reading Level dBuV	Factor dB	Measure- ment dBuV	Limit dBuV	Over dB	Detector	Comment
1	*	0.1600	52.15	0.17	52.32	65.46	-13.14	peak	
2		0.2350	38.83	0.12	38.95	62.27	-23.32	peak	
3		0.3150	33.98	0.11	34.09	59.84	-25.75	peak	
4		0.4700	27.43	0.08	27.51	56.51	-29.00	peak	
5		1.9350	24.75	0.13	24.88	56.00	-31.12	peak	
6		5.6500	26.18	0.20	26.38	60.00	-33.62	peak	

Unless otherwise stated the results shown in this test report refer only to the sample(s) tested. This test report cannot be reproduced, except in full, without prior written permission of the Company. 除非另有說明，此報告結果僅對測試之樣品負責。本報告未經本公司書面許可，不可部份複製。
 This Test Report is issued by the Company under its General Conditions of Service which is available on request or accessible at http://www.sgs.com/terms_and_conditions.htm. Attention is drawn to the limitation of liability, indemnification and jurisdiction issues defined therein. Any holder of this Test Report is advised that information contained hereon reflects the Company's findings at the time of its intervention only and within the limits of Client's instructions, if any. The Company's sole responsibility is to its Client and this document does not exonerate parties to a transaction from exercising all their rights and obligations under the transaction documents. Any unauthorized alteration, forgery or falsification of the content or appearance of this document is unlawful and offenders may be prosecuted to the fullest extent of the law.

6. PEAK OUTPUT POWER MEASUREMENT

6.1. Standard Applicable

According to §15.247(a)(2), (b)

(3) For systems using digital modulation in the 902-928 MHz, 2400-2483.5 MHz, and 5725-5850 MHz bands: 1 Watt. As an alternative to a peak power measurement, compliance with the one Watt limit can be based on a measurement of the maximum conducted output power. Maximum Conducted Output Power is defined as the total transmit power delivered to all antennas and antenna elements averaged across all symbols in the signaling alphabet when the transmitter is operating at its maximum power control level. Power must be summed across all antennas and antenna elements. The average must not include any time intervals during which the transmitter is off or is transmitting at a reduced power level. If multiple modes of operation are possible (e.g., alternative modulation methods), the maximum conducted output power is the highest total transmit power occurring in any mode.

(4) The conducted output power limit specified in paragraph (b) of this section is based on the use of antennas with directional gains that do not exceed 6 dBi. Except as shown in paragraph (c) of this section, if transmitting antennas of directional gain greater than 6 dBi are used, the conducted output power from the intentional radiator shall be reduced below the stated values in paragraphs (b)(1), (b)(2), and (b)(3) of this section, as appropriate, by the amount in dB that the directional gain of the antenna exceeds 6 dBi.

(c) Operation with directional antenna gains greater than 6 dBi.

(1) Fixed point-to-point operation:

(i) Systems operating in the 2400-2483.5 MHz band that are used exclusively for fixed, point-to-point operations may employ transmitting antennas with directional gain greater than 6 dBi provided the maximum conducted output power of the intentional radiator is reduced by 1 dB for every 3 dB that the directional gain of the antenna exceeds 6 dBi.

(ii) Systems operating in the 5725-5850 MHz band that are used exclusively for fixed, point-to-point operations may employ transmitting antennas with directional gain greater than 6 dBi without any corresponding reduction in transmitter conducted output power.

6.2. Measurement Procedure

1. Place the EUT on the table and set it in transmitting mode.
2. Remove the antenna from the EUT and then connect a low loss RF cable from the antenna port to the power meter or spectrum. (Channel power function, RBW= 1MHz, VBW = 1MHz, Bandwidth=26dB occupied Bandwidth)
3. Record the max. reading.
4. Repeat above procedures until all frequency measured were complete.

6.3. Measurement Equipment Used:

Conducted Emission Test Site					
EQUIPMENT TYPE	MFR	MODEL NUMBER	SERIAL NUMBER	LAST CAL.	CAL DUE.
Spectrum Analyzer	Agilent	E4446A	MY43360126	04/19/2008	04/18/2010
Spectrum Analyzer	Agilent	E4440A	MY45304525	01/23/2008	01/22/2010
DC Block	Agilent	BLK-18	155452	07/05/2009	07/04/2010
Low Loss Cable	HUBER+SUHNER	SUCOFLEX 104PEA	N/A	01/05/2009	01/04/2010
Attenuator	Mini-Circuit	BW-S6W5	001	07/05/2009	07/04/2010
Attenuator	Mini-Circuit	BW-S10W5	001	07/05/2009	07/04/2010
Attenuator	Mini-Circuit	BW-S20W5	001	07/05/2009	07/04/2010
Splitter	Agilent	11636B	N/A	07/05/2009	07/04/2010

Unless otherwise stated the results shown in this test report refer only to the sample(s) tested. This test report cannot be reproduced, except in full, without prior written permission of the Company. 除非另有說明，此報告結果僅對測試之樣品負責。本報告未經本公司書面許可，不可部份複製。

This Test Report is issued by the Company under its General Conditions of Service which is available on request or accessible at http://www.sgs.com/terms_and_conditions.htm. Attention is drawn to the limitation of liability, indemnification and jurisdiction issues defined therein. Any holder of this Test Report is advised that information contained hereon reflects the Company's findings at the time of its intervention only and within the limits of Client's instructions, if any. The Company's sole responsibility is to its Client and this document does not exonerate parties to a transaction from exercising all their rights and obligations under the transaction documents. Any unauthorized alteration, forgery or falsification of the content or appearance of this document is unlawful and offenders may be prosecuted to the fullest extent of the law.

6.4. Measurement Result

Patch 1 Internal Antenna (the Patch 1 Antenna Gain is 12.84dBi)

802.11b

		Peak Power Output				
CH	Frequency (MHz)	Data Rate				Required Limit
		1	2	5.5	11	
1	2412	18.34	18.23	17.96	17.71	28 dBm
6	2437	26.85	26.30	26.15	25.95	28 dBm
11	2462	16.77	16.58	16.54	16.32	28 dBm

802.11g

		Peak Power Output								
CH	Frequency (MHz)	Data Rate								Required Limit
		6	9	12	18	24	36	48	54	
1	2412	16.51	16.11	15.97	15.93	15.83	15.68	15.56	15.49	28 dBm
6	2437	24.15	24.01	23.97	23.86	23.76	23.71	23.65	23.57	28 dBm
11	2462	11.29	11.10	10.98	10.85	10.72	10.55	10.34	10.16	28 dBm

Cable loss = 0

Offset 0.5dB

**Noted: The peak output power of channel 1 and 11 are modified for Band edge test by firmware upgrade. The manufacturer will follow and fix the above maximum output power table in production.*

802.11b, 1Mbps (Patch 1 Internal Antenna)

Power Output Plot (CH Low)

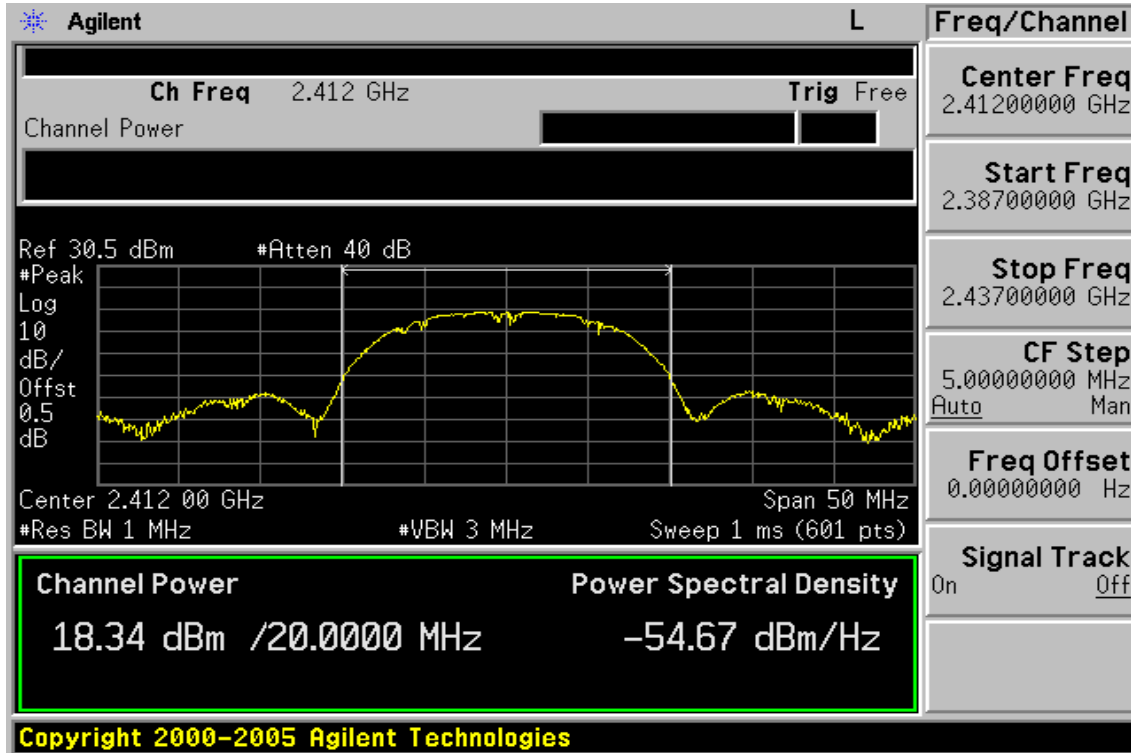

Power Output Plot (CH Mid)

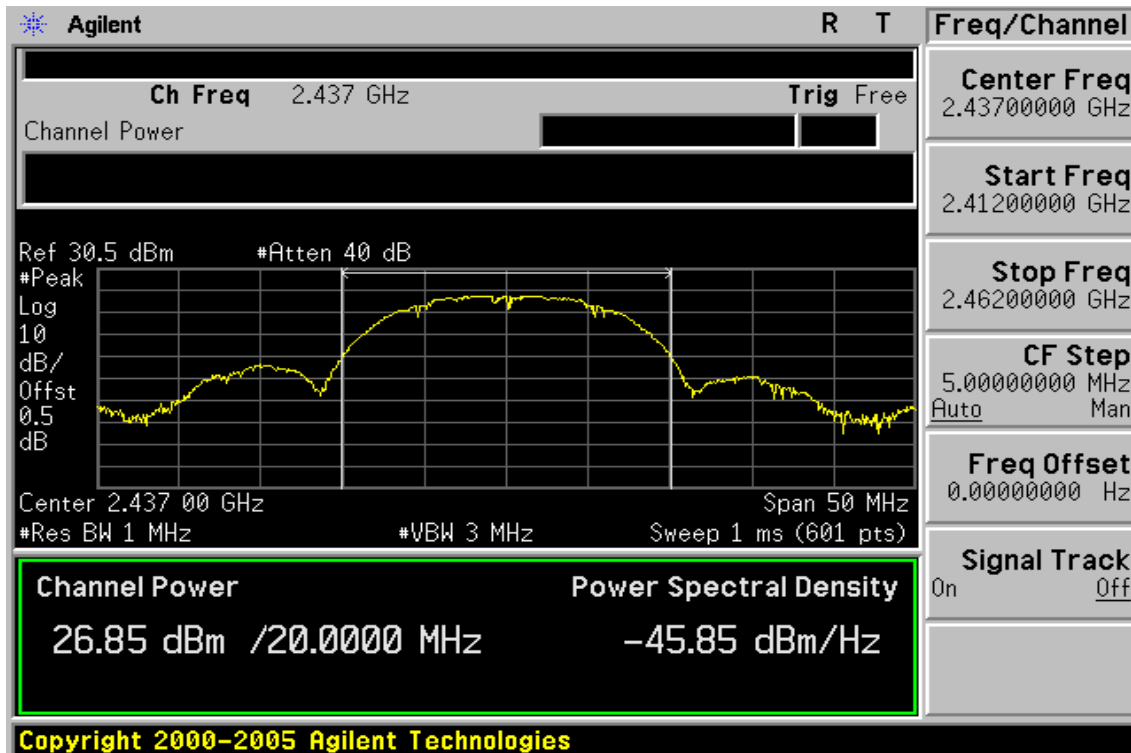

Unless otherwise stated the results shown in this test report refer only to the sample(s) tested. This test report cannot be reproduced, except in full, without prior written permission of the Company. 除非另有說明，此報告結果僅對測試之樣品負責。本報告未經本公司書面許可，不可部份複製。
 This Test Report is issued by the Company under its General Conditions of Service which is available on request or accessible at http://www.sgs.com/terms_and_conditions.htm. Attention is drawn to the limitation of liability, indemnification and jurisdiction issues defined therein. Any holder of this Test Report is advised that information contained hereon reflects the Company's findings at the time of its intervention only and within the limits of Client's instructions, if any. The Company's sole responsibility is to its Client and this document does not exonerate parties to a transaction from exercising all their rights and obligations under the transaction documents. Any unauthorized alteration, forgery or falsification of the content or appearance of this document is unlawful and offenders may be prosecuted to the fullest extent of the law.

Power Output Plot (CH High)

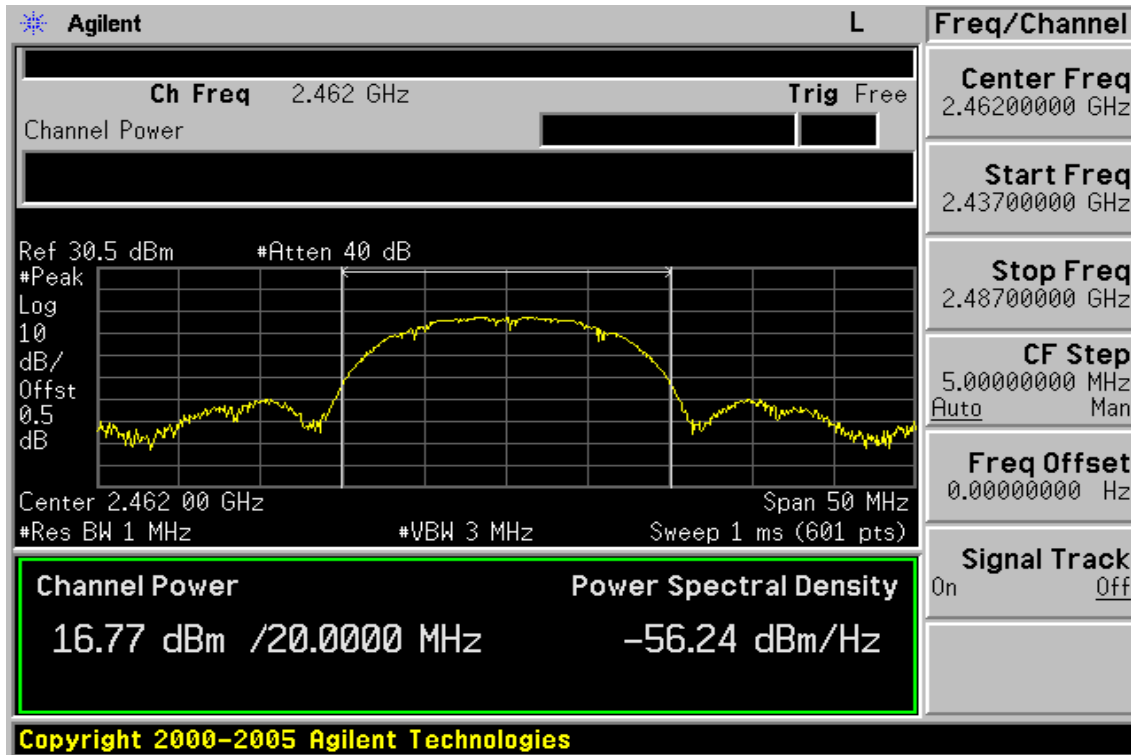

Unless otherwise stated the results shown in this test report refer only to the sample(s) tested. This test report cannot be reproduced, except in full, without prior written permission of the Company. 除非另有說明，此報告結果僅對測試之樣品負責。本報告未經本公司書面許可，不可部份複製。
 This Test Report is issued by the Company under its General Conditions of Service which is available on request or accessible at http://www.sgs.com/terms_and_conditions.htm. Attention is drawn to the limitation of liability, indemnification and jurisdiction issues defined therein. Any holder of this Test Report is advised that information contained hereon reflects the Company's findings at the time of its intervention only and within the limits of Client's instructions, if any. The Company's sole responsibility is to its Client and this document does not exonerate parties to a transaction from exercising all their rights and obligations under the transaction documents. Any unauthorized alteration, forgery or falsification of the content or appearance of this document is unlawful and offenders may be prosecuted to the fullest extent of the law.

802.11g, 6Mbps (Patch 1 Internal Antenna)

Power Output Plot (CH Low)

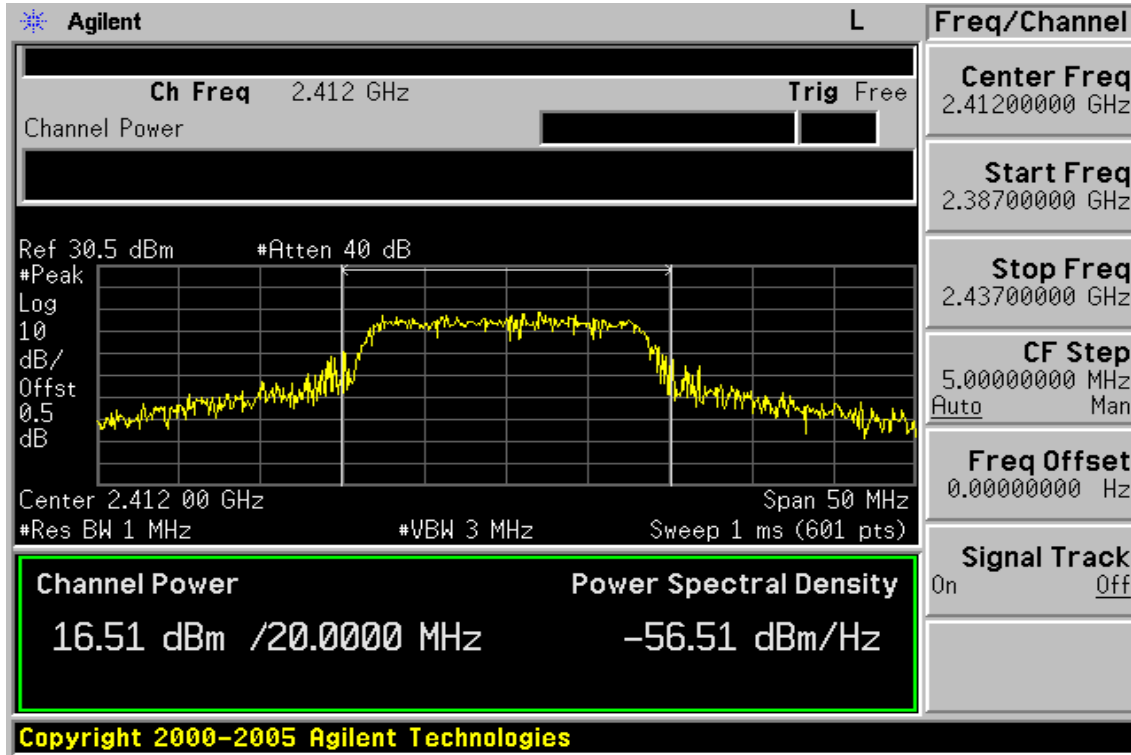

Power Output Plot (CH Mid)

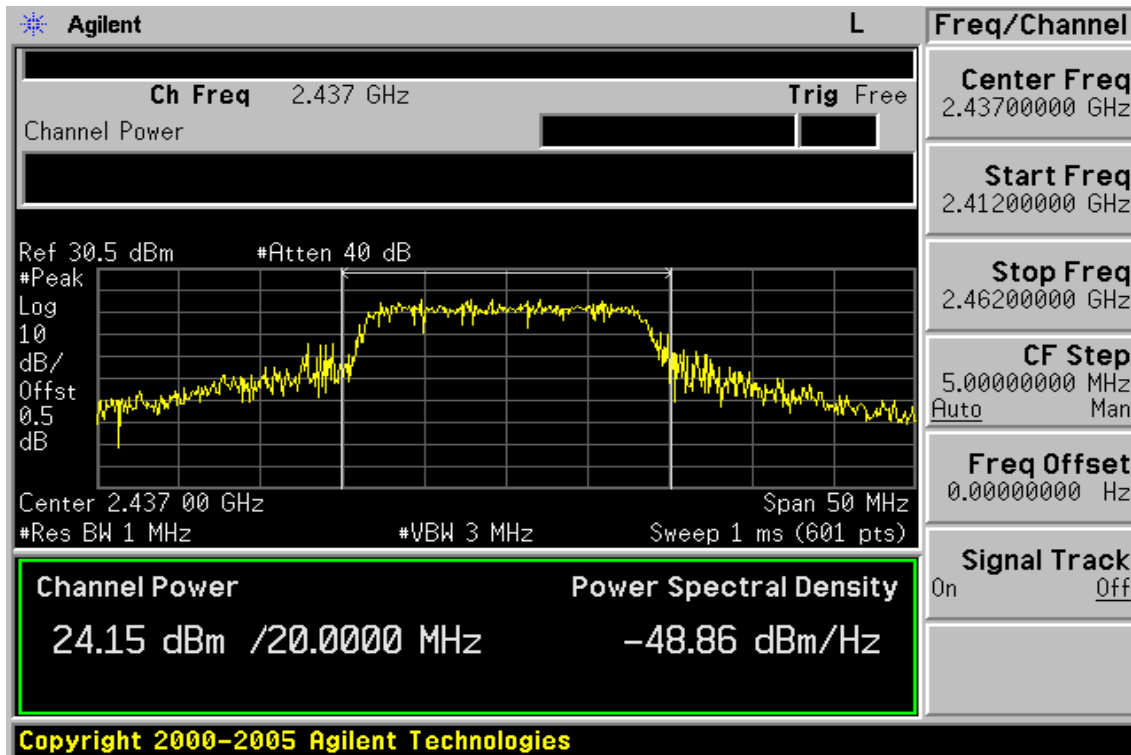

Unless otherwise stated the results shown in this test report refer only to the sample(s) tested. This test report cannot be reproduced, except in full, without prior written permission of the Company. 除非另有說明，此報告結果僅對測試之樣品負責。本報告未經本公司書面許可，不可部份複製。
 This Test Report is issued by the Company under its General Conditions of Service which is available on request or accessible at http://www.sgs.com/terms_and_conditions.htm. Attention is drawn to the limitation of liability, indemnification and jurisdiction issues defined therein. Any holder of this Test Report is advised that information contained hereon reflects the Company's findings at the time of its intervention only and within the limits of Client's instructions, if any. The Company's sole responsibility is to its Client and this document does not exonerate parties to a transaction from exercising all their rights and obligations under the transaction documents. Any unauthorized alteration, forgery or falsification of the content or appearance of this document is unlawful and offenders may be prosecuted to the fullest extent of the law.

Power Output Plot (CH High)

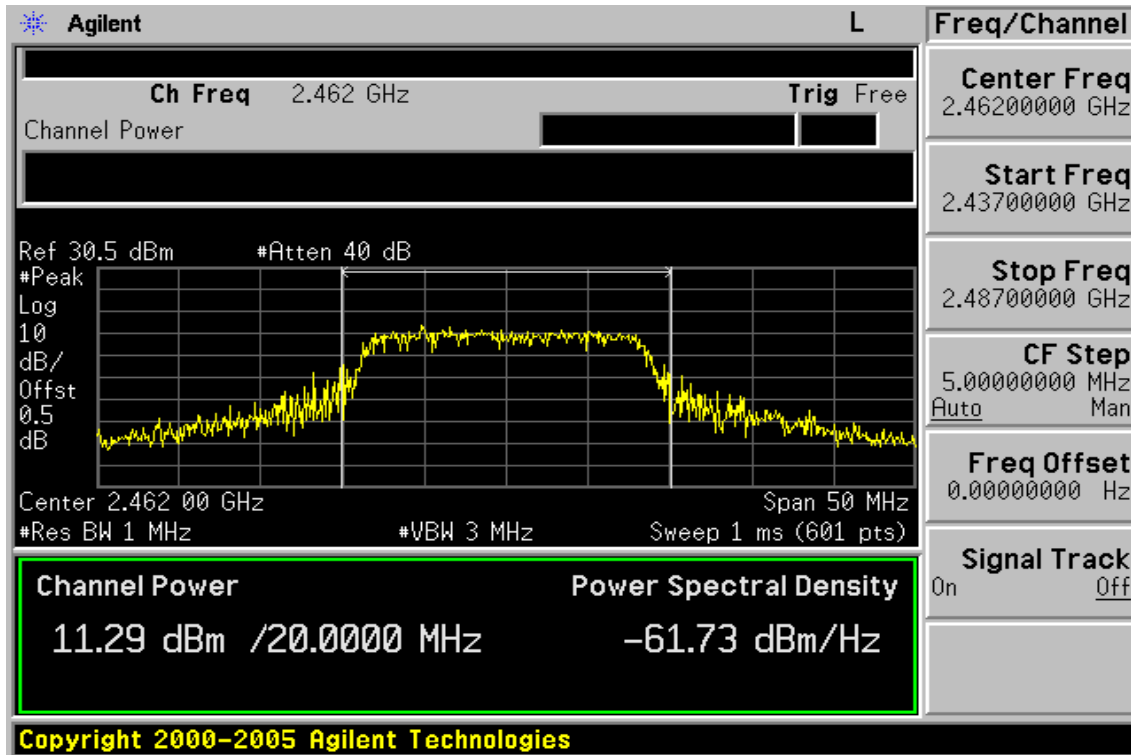

Unless otherwise stated the results shown in this test report refer only to the sample(s) tested. This test report cannot be reproduced, except in full, without prior written permission of the Company. 除非另有說明，此報告結果僅對測試之樣品負責。本報告未經本公司書面許可，不可部份複製。
 This Test Report is issued by the Company under its General Conditions of Service which is available on request or accessible at http://www.sgs.com/terms_and_conditions.htm. Attention is drawn to the limitation of liability, indemnification and jurisdiction issues defined therein. Any holder of this Test Report is advised that information contained hereon reflects the Company's findings at the time of its intervention only and within the limits of Client's instructions, if any. The Company's sole responsibility is to its Client and this document does not exonerate parties to a transaction from exercising all their rights and obligations under the transaction documents. Any unauthorized alteration, forgery or falsification of the content or appearance of this document is unlawful and offenders may be prosecuted to the fullest extent of the law.

7. 6dB Bandwidth

7.1. Standard Applicable

According to §15.247(a)(2), Systems using digital modulation techniques may operate in the 902 - 928 MHz, 2400 - 2483.5 MHz, and 5725 - 5850 MHz bands. The minimum 6 dB bandwidth shall be at least 500kHz.

7.2. Measurement Procedure

1. Place the EUT on the table and set it in transmitting mode.
2. Remove the antenna from the EUT and then connect a low loss RF cable from the 3. antenna port to the spectrum analyzer.
3. Set the spectrum analyzer as RBW=100KHz, VBW =3* RBW, Span= 50MHz, Sweep=auto
4. Mark the peak frequency and -6dB (upper and lower) frequency.
5. Repeat above procedures until all frequency measured were complete.

7.3. Measurement Equipment Used:

Conducted Emission Test Site					
EQUIPMENT TYPE	MFR	MODEL NUMBER	SERIAL NUMBER	LAST CAL.	CAL DUE.
Spectrum Analyzer	Agilent	E4446A	MY43360126	04/19/2008	04/18/2010
Spectrum Analyzer	Agilent	E4440A	MY45304525	01/23/2008	01/22/2010
DC Block	Agilent	BLK-18	155452	07/05/2009	07/04/2010
Low Loss Cable	HUBER+SUHNER	SUCOFLEX 104PEA	N/A	01/05/2009	01/04/2010
Attenuator	Mini-Circuit	BW-S6W5	001	07/05/2009	07/04/2010
Attenuator	Mini-Circuit	BW-S10W5	001	07/05/2009	07/04/2010
Attenuator	Mini-Circuit	BW-S20W5	001	07/05/2009	07/04/2010
Splitter	Agilent	11636B	N/A	07/05/2009	07/04/2010

Unless otherwise stated the results shown in this test report refer only to the sample(s) tested. This test report cannot be reproduced, except in full, without prior written permission of the Company. 除非另有說明，此報告結果僅對測試之樣品負責。本報告未經本公司書面許可，不可部份複製。

This Test Report is issued by the Company under its General Conditions of Service which is available on request or accessible at http://www.sgs.com/terms_and_conditions.htm. Attention is drawn to the limitation of liability, indemnification and jurisdiction issues defined therein. Any holder of this Test Report is advised that information contained hereon reflects the Company's findings at the time of its intervention only and within the limits of Client's instructions, if any. The Company's sole responsibility is to its Client and this document does not exonerate parties to a transaction from exercising all their rights and obligations under the transaction documents. Any unauthorized alteration, forgery or falsification of the content or appearance of this document is unlawful and offenders may be prosecuted to the fullest extent of the law.

7.4. Measurement Result

Patch 1 Internal Antenna

802.11b

CH	Bandwidth (MHz)	Bandwidth (KHz)	Result
Lower	12.108	> 500	PASS
Mid	12.048	> 500	PASS
Higher	11.173	> 500	PASS

**Offset 0.1dB*

802.11g

CH	Bandwidth (MHz)	Bandwidth (KHz)	Result
Lower	16.483	> 500	PASS
Mid	16.425	> 500	PASS
Higher	16.460	> 500	PASS

**Offset 0.5dB*

Unless otherwise stated the results shown in this test report refer only to the sample(s) tested. This test report cannot be reproduced, except in full, without prior written permission of the Company. 除非另有說明，此報告結果僅對測試之樣品負責。本報告未經本公司書面許可，不可部份複製。

This Test Report is issued by the Company under its General Conditions of Service which is available on request or accessible at http://www.sgs.com/terms_and_conditions.htm. Attention is drawn to the limitation of liability, indemnification and jurisdiction issues defined therein. Any holder of this Test Report is advised that information contained hereon reflects the Company's findings at the time of its intervention only and within the limits of Client's instructions, if any. The Company's sole responsibility is to its Client and this document does not exonerate parties to a transaction from exercising all their rights and obligations under the transaction documents. Any unauthorized alteration, forgery or falsification of the content or appearance of this document is unlawful and offenders may be prosecuted to the fullest extent of the law.

**802.11b (Patch 1 Internal Antenna)
6dB Band Width Test Data CH-Low**

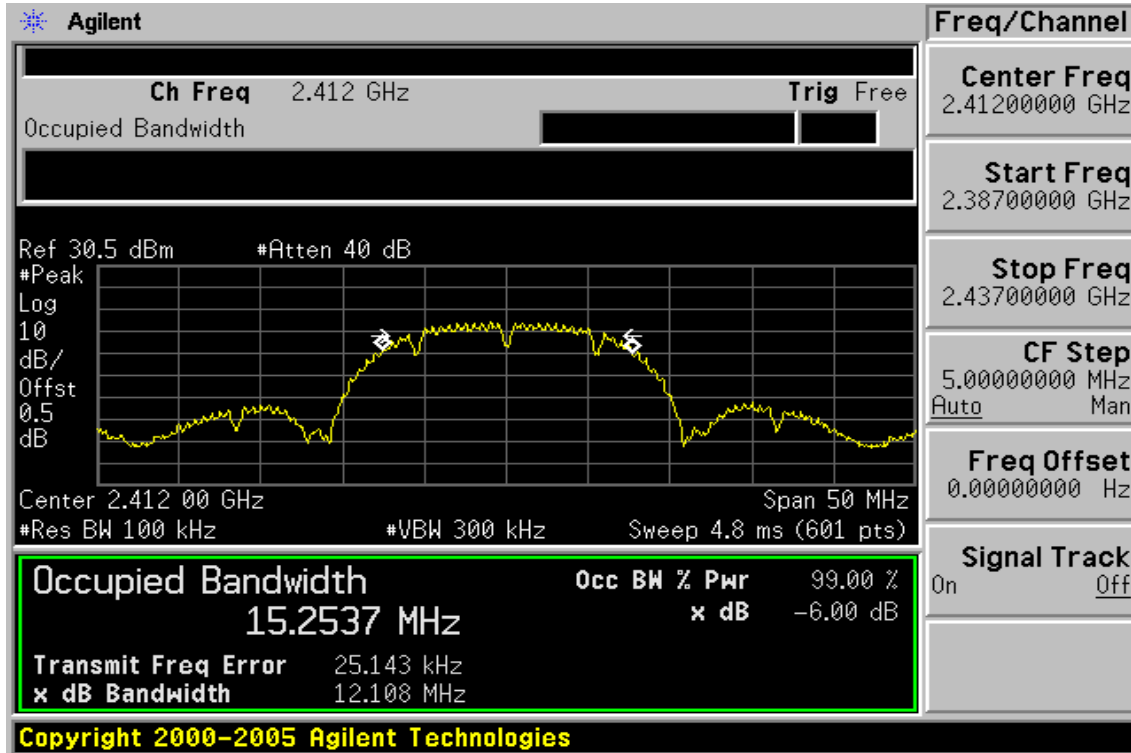

6dB Band Width Test Data CH-Mid

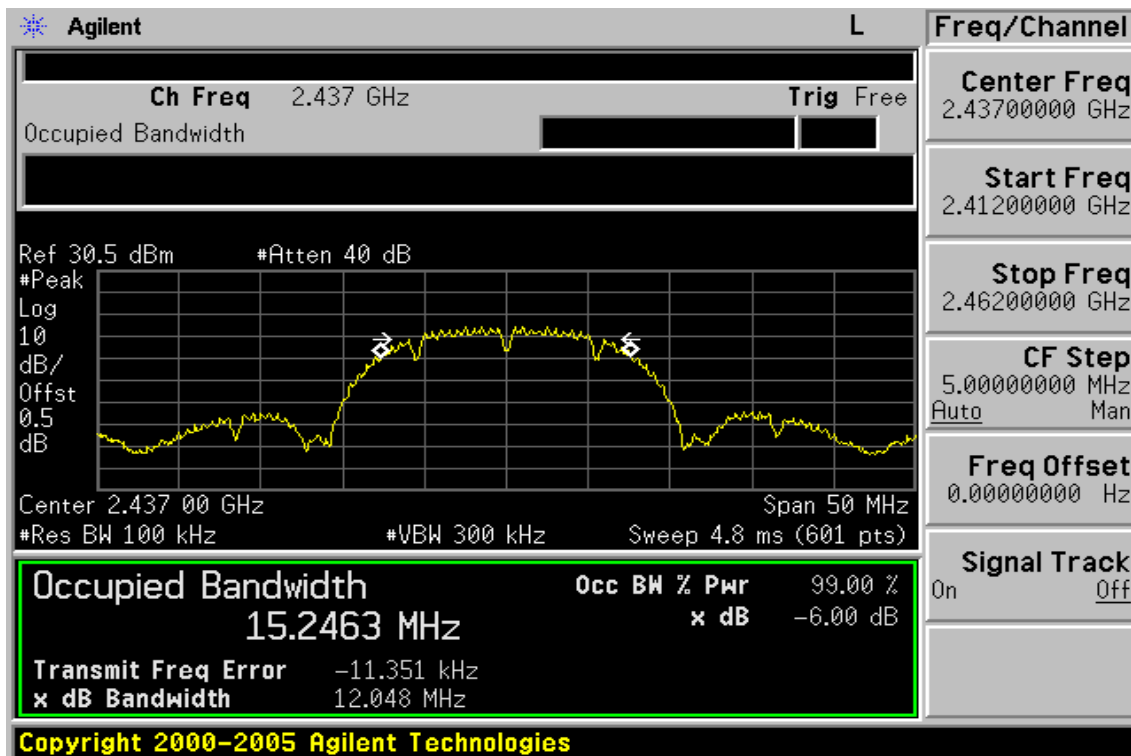

Unless otherwise stated the results shown in this test report refer only to the sample(s) tested. This test report cannot be reproduced, except in full, without prior written permission of the Company. 除非另有說明，此報告結果僅對測試之樣品負責。本報告未經本公司書面許可，不可部份複製。
This Test Report is issued by the Company under its General Conditions of Service which is available on request or accessible at http://www.sgs.com/terms_and_conditions.htm. Attention is drawn to the limitation of liability, indemnification and jurisdiction issues defined therein. Any holder of this Test Report is advised that information contained hereon reflects the Company's findings at the time of its intervention only and within the limits of Client's instructions, if any. The Company's sole responsibility is to its Client and this document does not exonerate parties to a transaction from exercising all their rights and obligations under the transaction documents. Any unauthorized alteration, forgery or falsification of the content or appearance of this document is unlawful and offenders may be prosecuted to the fullest extent of the law.

6dB Band Width Test Data CH-High

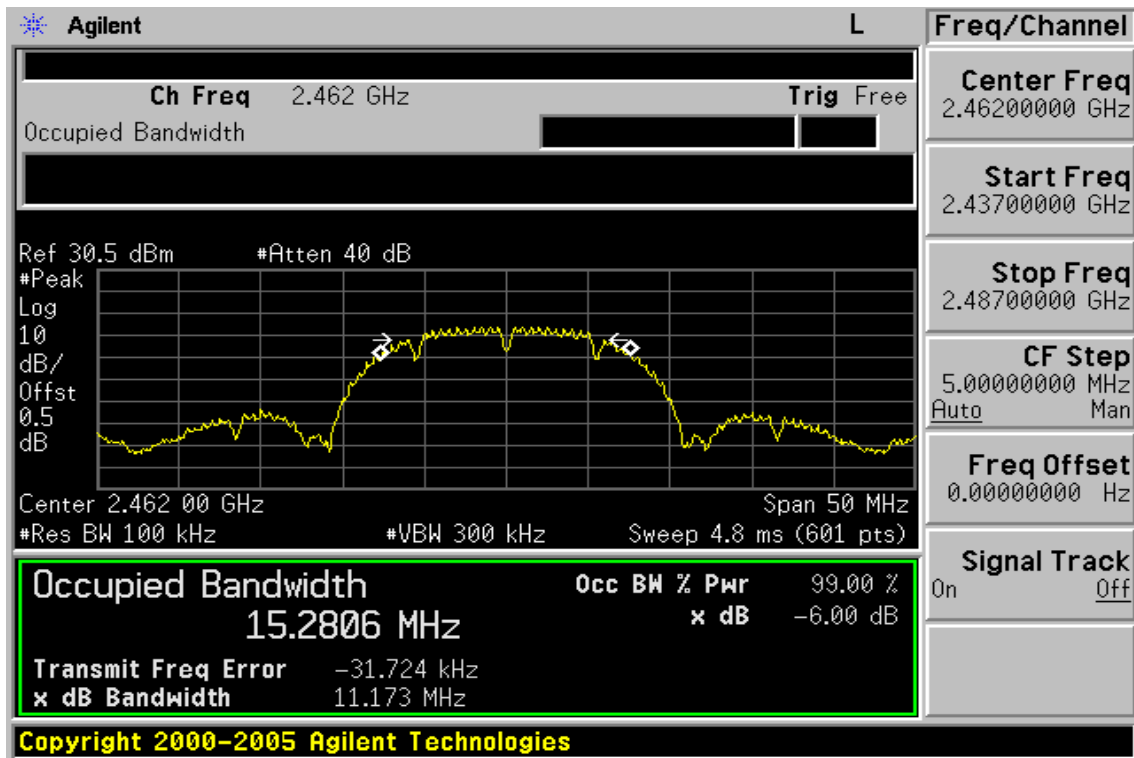

Unless otherwise stated the results shown in this test report refer only to the sample(s) tested. This test report cannot be reproduced, except in full, without prior written permission of the Company. 除非另有說明，此報告結果僅對測試之樣品負責。本報告未經本公司書面許可，不可部份複製。
 This Test Report is issued by the Company under its General Conditions of Service which is available on request or accessible at http://www.sgs.com/terms_and_conditions.htm. Attention is drawn to the limitation of liability, indemnification and jurisdiction issues defined therein. Any holder of this Test Report is advised that information contained hereon reflects the Company's findings at the time of its intervention only and within the limits of Client's instructions, if any. The Company's sole responsibility is to its Client and this document does not exonerate parties to a transaction from exercising all their rights and obligations under the transaction documents. Any unauthorized alteration, forgery or falsification of the content or appearance of this document is unlawful and offenders may be prosecuted to the fullest extent of the law.

**802.11g (Patch 1 Internal Antenna)
6dB Band Width Test Data CH-Low**

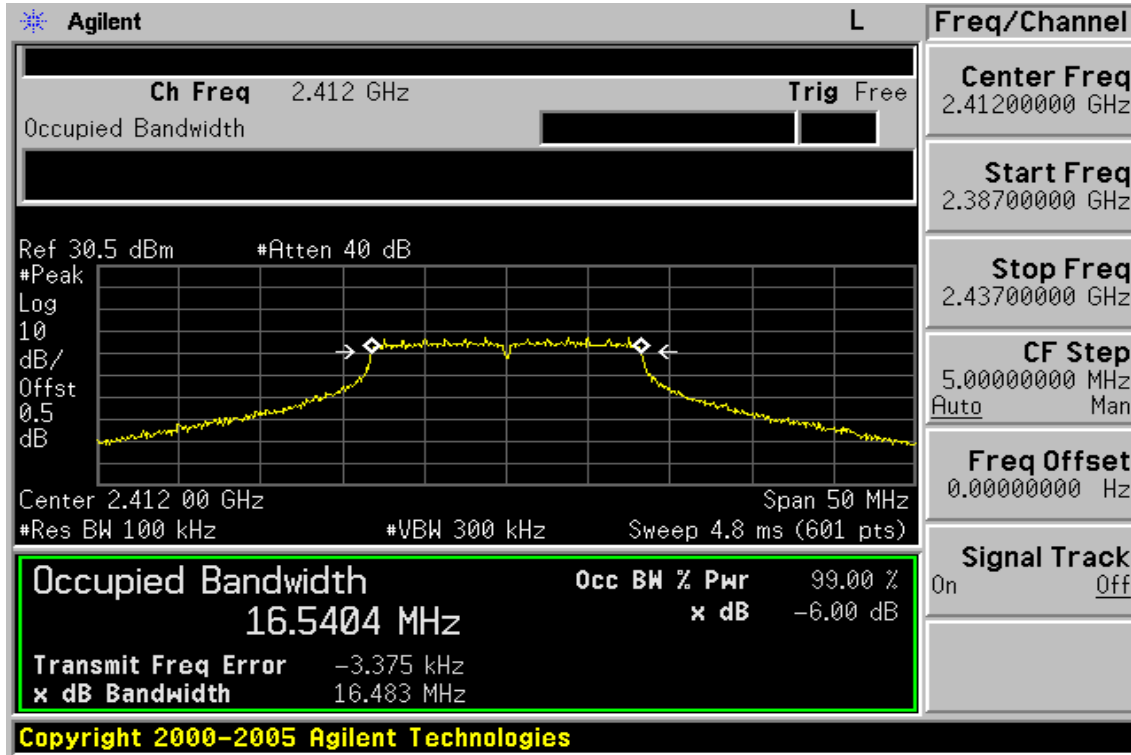

6dB Band Width Test Data CH-Mid

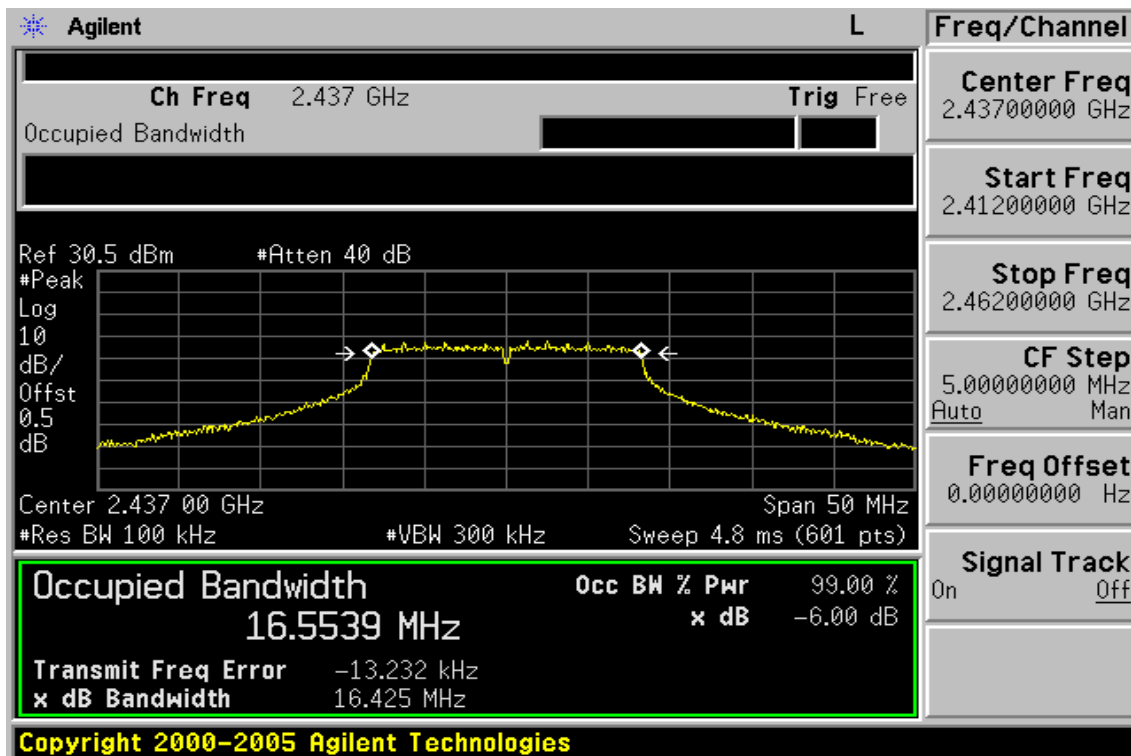

Unless otherwise stated the results shown in this test report refer only to the sample(s) tested. This test report cannot be reproduced, except in full, without prior written permission of the Company. 除非另有說明，此報告結果僅對測試之樣品負責。本報告未經本公司書面許可，不可部份複製。
This Test Report is issued by the Company under its General Conditions of Service which is available on request or accessible at http://www.sgs.com/terms_and_conditions.htm. Attention is drawn to the limitation of liability, indemnification and jurisdiction issues defined therein. Any holder of this Test Report is advised that information contained hereon reflects the Company's findings at the time of its intervention only and within the limits of Client's instructions, if any. The Company's sole responsibility is to its Client and this document does not exonerate parties to a transaction from exercising all their rights and obligations under the transaction documents. Any unauthorized alteration, forgery or falsification of the content or appearance of this document is unlawful and offenders may be prosecuted to the fullest extent of the law.

6dB Band Width Test Data CH-High

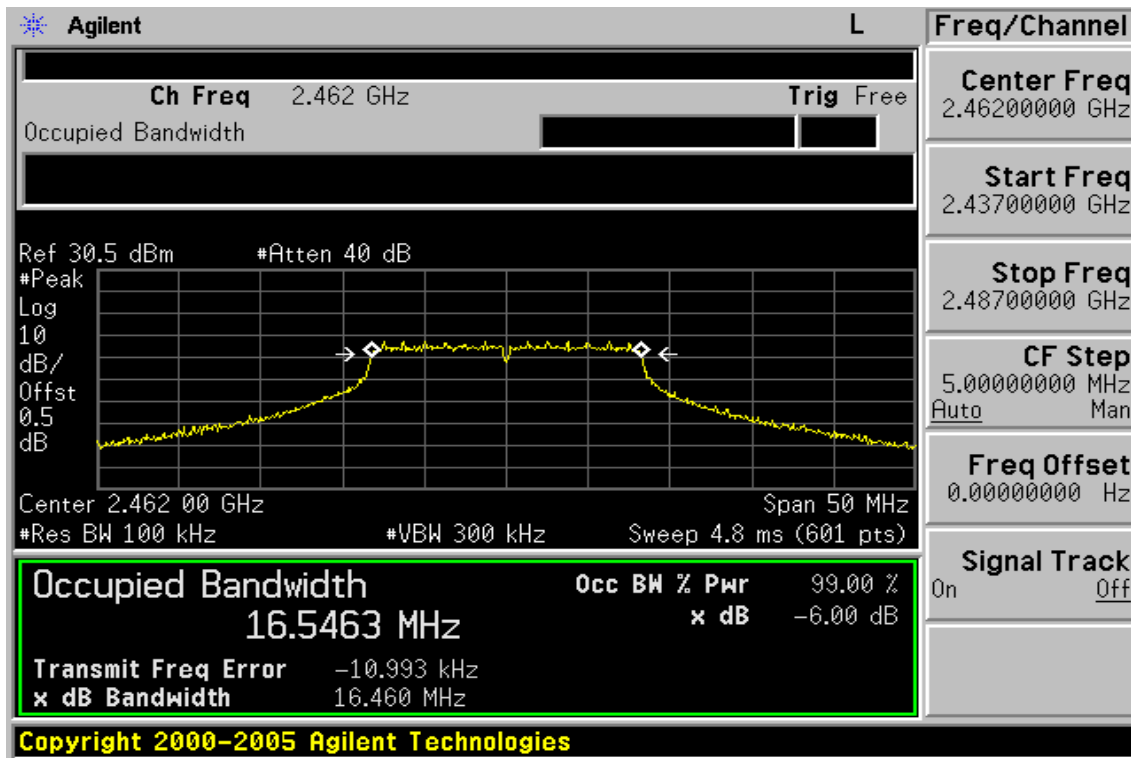

Unless otherwise stated the results shown in this test report refer only to the sample(s) tested. This test report cannot be reproduced, except in full, without prior written permission of the Company. 除非另有說明，此報告結果僅對測試之樣品負責。本報告未經本公司書面許可，不可部份複製。
 This Test Report is issued by the Company under its General Conditions of Service which is available on request or accessible at http://www.sgs.com/terms_and_conditions.htm. Attention is drawn to the limitation of liability, indemnification and jurisdiction issues defined therein. Any holder of this Test Report is advised that information contained hereon reflects the Company's findings at the time of its intervention only and within the limits of Client's instructions, if any. The Company's sole responsibility is to its Client and this document does not exonerate parties to a transaction from exercising all their rights and obligations under the transaction documents. Any unauthorized alteration, forgery or falsification of the content or appearance of this document is unlawful and offenders may be prosecuted to the fullest extent of the law.

8. 100KHz BANDWIDTH OF BAND EDGES MEASUREMENT

8.1. Standard Applicable

According to §15.247(c), in any 100 KHz bandwidth outside the frequency bands in which the spread spectrum intentional radiator is operating, the radio frequency power that is produced by the intentional radiator shall be at least 20dB below that in the 100KHz bandwidth within the band that contains the highest level of the desired power, In addition, radiated emissions which fall in the restricted bands, as defined in §15.205(a), must also comply with the radiated emission limits specified in 15.209(a).

8.2. Measurement Procedure

1. Place the EUT on the table and set it in transmitting mode.
2. Remove the antenna from the EUT and then connect a low loss RF cable from the antenna port to the spectrum analyzer.
3. Set center frequency of spectrum analyzer = operating frequency.
4. Set the spectrum analyzer as RBW, VBW=100KHz, Span=50MHz, Sweep = auto
5. Mark Peak, 2.390GHz and 2.4835GHz and record the max. level.
6. Repeat above procedures until all frequency measured were complete.

8.3. Measurement Equipment Used:

Conducted Emission Test Site					
EQUIPMENT TYPE	MFR	MODEL NUMBER	SERIAL NUMBER	LAST CAL.	CAL DUE.
Spectrum Analyzer	Agilent	E4446A	MY43360126	04/19/2008	04/18/2010
Spectrum Analyzer	Agilent	E4440A	MY45304525	01/23/2008	01/22/2010
DC Block	Agilent	BLK-18	155452	07/05/2009	07/04/2010
Low Loss Cable	HUBER+SUHNER	SUCOFLEX 104PEA	N/A	01/05/2009	01/04/2010
Attenuator	Mini-Circuit	BW-S6W5	001	07/05/2009	07/04/2010
Attenuator	Mini-Circuit	BW-S10W5	001	07/05/2009	07/04/2010
Attenuator	Mini-Circuit	BW-S20W5	001	07/05/2009	07/04/2010
Splitter	Agilent	11636B	N/A	07/05/2009	07/04/2010

8.4. Measurement Result

Refer to attach spectrum analyzer data chart.

Unless otherwise stated the results shown in this test report refer only to the sample(s) tested. This test report cannot be reproduced, except in full, without prior written permission of the Company. 除非另有說明，此報告結果僅對測試之樣品負責。本報告未經本公司書面許可，不可部份複製。
 This Test Report is issued by the Company under its General Conditions of Service which is available on request or accessible at http://www.sgs.com/terms_and_conditions.htm. Attention is drawn to the limitation of liability, indemnification and jurisdiction issues defined therein. Any holder of this Test Report is advised that information contained hereon reflects the Company's findings at the time of its intervention only and within the limits of Client's instructions, if any. The Company's sole responsibility is to its Client and this document does not exonerate parties to a transaction from exercising all their rights and obligations under the transaction documents. Any unauthorized alteration, forgery or falsification of the content or appearance of this document is unlawful and offenders may be prosecuted to the fullest extent of the law.

802.11b (Patch 1 Internal Antenna)

Band Edges Test Data CH-Low

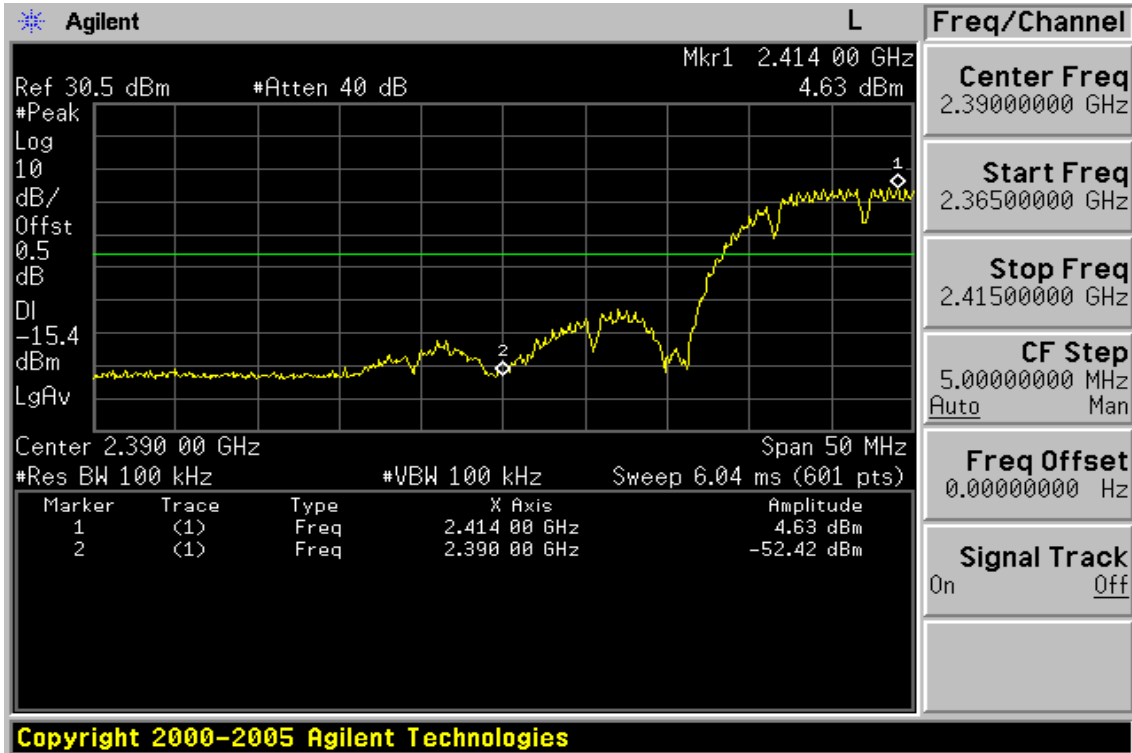

Band Edges Test Data CH-High



Unless otherwise stated the results shown in this test report refer only to the sample(s) tested. This test report cannot be reproduced, except in full, without prior written permission of the Company. 除非另有說明，此報告結果僅對測試之樣品負責。本報告未經本公司書面許可，不可部份複製。
 This Test Report is issued by the Company under its General Conditions of Service which is available on request or accessible at http://www.sgs.com/terms_and_conditions.htm. Attention is drawn to the limitation of liability, indemnification and jurisdiction issues defined therein. Any holder of this Test Report is advised that information contained hereon reflects the Company's findings at the time of its intervention only and within the limits of Client's instructions, if any. The Company's sole responsibility is to its Client and this document does not exonerate parties to a transaction from exercising all their rights and obligations under the transaction documents. Any unauthorized alteration, forgery or falsification of the content or appearance of this document is unlawful and offenders may be prosecuted to the fullest extent of the law.

Radiated Emission: 802.11 b mode

Operation Mode	TX CH Low	Test Date	Jun. 30, 2009
Fundamental Frequency	2412 MHz	Test By	Brian
Temperature	25 °C	Pol	Ver.
Humidity	65 %		

Freq. (MHz)	Peak	AV	Ant./CL CF(dB)	Actual FS		Peak	AV	Margin (dB)	Remark
	Reading (dBuV)	Reading (dBuV)		Peak (dBuV/m)	AV (dBuV/m)	Limit (dBuV/m)	Limit (dBuV/m)		
2386.85	70.87	62.27	-10.76	60.11	51.51	74.00	54.00	-2.49	Av
2390.00	68.44	59.79	-10.76	57.68	49.03	74.00	54.00	-4.97	Av

Operation Mode	TX CH Low	Test Date	Jun. 30, 2009
Fundamental Frequency	2412 MHz	Test By	Brian
Temperature	25 °C	Pol	Hor.
Humidity	65 %		

Freq. (MHz)	Peak	AV	Ant./CL CF(dB)	Actual FS		Peak	AV	Margin (dB)	Remark
	Reading (dBuV)	Reading (dBuV)		Peak (dBuV/m)	AV (dBuV/m)	Limit (dBuV/m)	Limit (dBuV/m)		
2390.00	67.38	58.29	-10.76	56.62	47.53	74.00	54.00	-6.47	Peak

Remark :

- (1) Data of measurement within this frequency range shown “ - ” in the table above means the reading of emissions are attenuated more than 20dB below the permissible limits or the field strength is too small to be measured.
- (2) Radiated emissions measured in frequency above 1000MHz were made with an instrument using Peak detector mode and average detector mode of the emission shown in Actual FS column ◦
- (3) Spectrum Peak Setting : 1GHz- 26GHz, RBW= 1MHz, VBW= 3MHz, Sweep time= 200 ms.
- (4) Spectrum AV Setting : 1GHz- 26GHz, RBW= 1MHz, VBW= 10Hz, Sweep time= 200 ms.

Unless otherwise stated the results shown in this test report refer only to the sample(s) tested. This test report cannot be reproduced, except in full, without prior written permission of the Company. 除非另有說明，此報告結果僅對測試之樣品負責。本報告未經本公司書面許可，不可部份複製。
 This Test Report is issued by the Company under its General Conditions of Service which is available on request or accessible at http://www.sgs.com/terms_and_conditions.htm. Attention is drawn to the limitation of liability, indemnification and jurisdiction issues defined therein. Any holder of this Test Report is advised that information contained hereon reflects the Company's findings at the time of its intervention only and within the limits of Client's instructions, if any. The Company's sole responsibility is to its Client and this document does not exonerate parties to a transaction from exercising all their rights and obligations under the transaction documents. Any unauthorized alteration, forgery or falsification of the content or appearance of this document is unlawful and offenders may be prosecuted to the fullest extent of the law. ◦

Radiated Emission: 802.11 b mode

Operation Mode	TX CH High	Test Date	Jun. 30, 2009
Fundamental Frequency	2462 MHz	Test By	Brian
Temperature	25 °C	Pol	Ver.
Humidity	65 %		

Freq. (MHz)	Peak	AV	Ant./CL CF(dB)	Actual FS		Peak	AV	Margin (dB)	Remark
	Reading (dBuV)	Reading (dBuV)		Peak (dBuV/m)	AV (dBuV/m)	Limit (dBuV/m)	Limit (dBuV/m)		
2483.56	69.40	60.52	-10.46	58.94	50.06	74.00	54.00	-3.94	Av
2487.51	73.11	62.53	-10.40	62.71	52.13	74.00	54.00	-1.87	Av

Operation Mode	TX CH High	Test Date	Jun. 30, 2009
Fundamental Frequency	2462 MHz	Test By	Brian
Temperature	25 °C	Pol	Hor.
Humidity	65 %		

Freq. (MHz)	Peak	AV	Ant./CL CF(dB)	Actual FS		Peak	AV	Margin (dB)	Remark
	Reading (dBuV)	Reading (dBuV)		Peak (dBuV/m)	AV (dBuV/m)	Limit (dBuV/m)	Limit (dBuV/m)		
2483.56	67.40	58.39	-10.46	56.94	47.93	74.00	54.00	-6.07	Av

Remark :

- (1) Data of measurement within this frequency range shown “ - ” in the table above means the reading of emissions are attenuated more than 20dB below the permissible limits or the field strength is too small to be measured.
- (2) Radiated emissions measured in frequency above 1000MHz were made with an instrument using Peak detector mode and average detector mode of the emission shown in Actual FS column ◦
- (3) Spectrum Peak Setting: 1GHz- 26GHz, RBW= 1MHz, VBW= 3MHz, Sweep time= 200 ms.
- (4) Spectrum AV Setting: 1GHz- 26GHz, RBW= 1MHz, VBW= 10Hz, Sweep time= 200 ms.

Unless otherwise stated the results shown in this test report refer only to the sample(s) tested. This test report cannot be reproduced, except in full, without prior written permission of the Company. 除非另有說明，此報告結果僅對測試之樣品負責。本報告未經本公司書面許可，不可部份複製。
 This Test Report is issued by the Company under its General Conditions of Service which is available on request or accessible at http://www.sgs.com/terms_and_conditions.htm. Attention is drawn to the limitation of liability, indemnification and jurisdiction issues defined therein. Any holder of this Test Report is advised that information contained hereon reflects the Company's findings at the time of its intervention only and within the limits of Client's instructions, if any. The Company's sole responsibility is to its Client and this document does not exonerate parties to a transaction from exercising all their rights and obligations under the transaction documents. Any unauthorized alteration, forgery or falsification of the content or appearance of this document is unlawful and offenders may be prosecuted to the fullest extent of the law. ◦

802.11g

Band Edges Test Data CH-Low

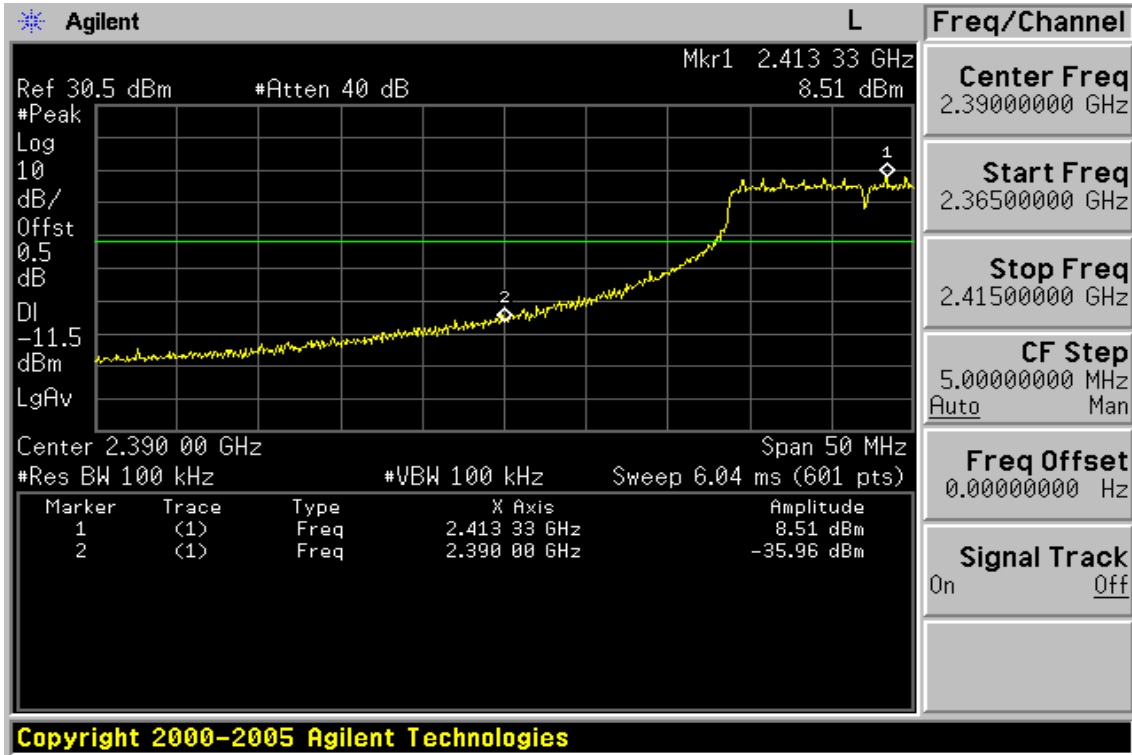

Band Edges Test Data CH-High



Unless otherwise stated the results shown in this test report refer only to the sample(s) tested. This test report cannot be reproduced, except in full, without prior written permission of the Company. 除非另有說明，此報告結果僅對測試之樣品負責。本報告未經本公司書面許可，不可部份複製。
 This Test Report is issued by the Company under its General Conditions of Service which is available on request or accessible at http://www.sgs.com/terms_and_conditions.htm. Attention is drawn to the limitation of liability, indemnification and jurisdiction issues defined therein. Any holder of this Test Report is advised that information contained hereon reflects the Company's findings at the time of its intervention only and within the limits of Client's instructions, if any. The Company's sole responsibility is to its Client and this document does not exonerate parties to a transaction from exercising all their rights and obligations under the transaction documents. Any unauthorized alteration, forgery or falsification of the content or appearance of this document is unlawful and offenders may be prosecuted to the fullest extent of the law.

Radiated Emission: 802.11 g mode

Operation Mode TX CH Low
 Fundamental Frequency 2412 MHz
 Temperature 25 °C
 Humidity 65 %

Test Date Jun. 30, 2009
 Test By Brian
 Pol Ver.

Freq. (MHz)	Peak	AV	Ant./CL CF(dB)	Actual FS		Peak	AV	Margin (dB)	Remark
	Reading (dBuV)	Reading (dBuV)		Peak (dBuV/m)	AV (dBuV/m)	Limit (dBuV/m)	Limit (dBuV/m)		
2390.00	79.96	63.27	-10.76	69.20	52.51	74.00	54.00	-1.49	Av

Operation Mode TX CH Low
 Fundamental Frequency 2412 MHz
 Temperature 25 °C
 Humidity 65 %

Test Date Jun. 30, 2009
 Test By Brian
 Pol Hor.

Freq. (MHz)	Peak	AV	Ant./CL CF(dB)	Actual FS		Peak	AV	Margin (dB)	Remark
	Reading (dBuV)	Reading (dBuV)		Peak (dBuV/m)	AV (dBuV/m)	Limit (dBuV/m)	Limit (dBuV/m)		
2390.00	67.37	58.24	-10.76	56.61	47.48	74.00	54.00	-6.52	Av

Remark :

- (1) Data of measurement within this frequency range shown “ - ” in the table above means the reading of emissions are attenuated more than 20dB below the permissible limits or the field strength is too small to be measured.
- (2) Radiated emissions measured in frequency above 1000MHz were made with an instrument using Peak detector mode and average detector mode of the emission shown in Actual FS column ◦
- (3) Spectrum Peak Setting : 1GHz- 26GHz, RBW= 1MHz, VBW= 3MHz, Sweep time= 200 ms.
- (4) Spectrum AV Setting : 1GHz- 26GHz, RBW= 1MHz, VBW= 10Hz, Sweep time= 200 ms.

Unless otherwise stated the results shown in this test report refer only to the sample(s) tested. This test report cannot be reproduced, except in full, without prior written permission of the Company. 除非另有說明，此報告結果僅對測試之樣品負責。本報告未經本公司書面許可，不可部份複製。
 This Test Report is issued by the Company under its General Conditions of Service which is available on request or accessible at http://www.sgs.com/terms_and_conditions.htm. Attention is drawn to the limitation of liability, indemnification and jurisdiction issues defined therein. Any holder of this Test Report is advised that information contained hereon reflects the Company's findings at the time of its intervention only and within the limits of Client's instructions, if any. The Company's sole responsibility is to its Client and this document does not exonerate parties to a transaction from exercising all their rights and obligations under the transaction documents. Any unauthorized alteration, forgery or falsification of the content or appearance of this document is unlawful and offenders may be prosecuted to the fullest extent of the law. ◦

Radiated Emission: 802.11 g mode

Operation Mode TX CH High
 Fundamental Frequency 2462 MHz
 Temperature 25 °C
 Humidity 65 %

Test Date Jun. 30, 2009
 Test By Brian
 Pol Ver.

Freq. (MHz)	Peak	AV	Ant./CL CF(dB)	Actual FS		Peak	AV	Margin (dB)	Remark
	Reading (dBuV)	Reading (dBuV)		Peak (dBuV/m)	AV (dBuV/m)	Limit (dBuV/m)	Limit (dBuV/m)		
2483.56	76.39	63.74	-10.46	65.93	53.28	74.00	54.00	-0.72	Av

Operation Mode TX CH High
 Fundamental Frequency 2462 MHz
 Temperature 25 °C
 Humidity 65 %

Test Date Jun. 30, 2009
 Test By Brian
 Pol Hor.

Freq. (MHz)	Peak	AV	Ant./CL CF(dB)	Actual FS		Peak	AV	Margin (dB)	Remark
	Reading (dBuV)	Reading (dBuV)		Peak (dBuV/m)	AV (dBuV/m)	Limit (dBuV/m)	Limit (dBuV/m)		
2483.56	67.93	58.76	-10.46	57.47	48.30	74.00	54.00	-5.70	Peak

Remark :

- (1) Data of measurement within this frequency range shown “ - ” in the table above means the reading of emissions are attenuated more than 20dB below the permissible limits or the field strength is too small to be measured.
- (2) Radiated emissions measured in frequency above 1000MHz were made with an instrument using Peak detector mode and average detector mode of the emission shown in Actual FS column ◦
- (3) Spectrum Peak Setting: 1GHz- 26GHz, RBW= 1MHz, VBW= 3MHz, Sweep time= 200 ms.
- (4) Spectrum AV Setting: 1GHz- 26GHz, RBW= 1MHz, VBW= 10Hz, Sweep time= 200 ms.

Unless otherwise stated the results shown in this test report refer only to the sample(s) tested. This test report cannot be reproduced, except in full, without prior written permission of the Company. 除非另有說明，此報告結果僅對測試之樣品負責。本報告未經本公司書面許可，不可部份複製。
 This Test Report is issued by the Company under its General Conditions of Service which is available on request or accessible at http://www.sgs.com/terms_and_conditions.htm. Attention is drawn to the limitation of liability, indemnification and jurisdiction issues defined therein. Any holder of this Test Report is advised that information contained hereon reflects the Company's findings at the time of its intervention only and within the limits of Client's instructions, if any. The Company's sole responsibility is to its Client and this document does not exonerate parties to a transaction from exercising all their rights and obligations under the transaction documents. Any unauthorized alteration, forgery or falsification of the content or appearance of this document is unlawful and offenders may be prosecuted to the fullest extent of the law. ◦

9. SPURIOUS RADIATED EMISSION TEST

9.1. Standard Applicable

According to §15.247(c), all other emissions outside these bands shall not exceed the general radiated emission limits specified in §15.209(a). And according to §15.33(a)(1), for an intentional radiator operates below 10GHz, the frequency range of measurements: to the tenth harmonic of the highest fundamental frequency or to 40GHz, whichever is lower.

9.2. EUT Setup

1. The radiated emission tests were performed in the 3 meter open-test site, using the setup in accordance with the ANSI C63.4-2003.
2. The EUT was put in the front of the test table. The rear of the EUT and peripherals were placed flushed with the rear of the tabletop.
3. The spacing between the peripherals was 10 centimeters.
4. External I/O cables were draped along the edge of the test table and bundle when necessary.

9.3. Measurement Procedure

1. The EUT was placed on a turn table which is 0.8m above ground plane.
2. The turn table shall rotate 360 degrees to determine the position of maximum emission level.
3. EUT is set 3m away from the receiving antenna which varied from 1m to 4m to find out the highest emissions.
4. When measurement procedures for electric field radiated emissions above 1 GHz the EUT measurement is to be made “while keeping the antenna in the ‘cone of radiation’ from that area and pointed at the area both in azimuth and elevation, with polarization oriented for maximum response.” is still within the 3dB illumination BW of the measurement antenna
5. Maximum procedure was performed on the six highest emissions to ensure EUT compliance.
6. And also, each emission was to be maximized by changing the polarization of receiving antenna both horizontal and vertical.
7. Repeat above procedures until all frequency measured were complete.

Unless otherwise stated the results shown in this test report refer only to the sample(s) tested. This test report cannot be reproduced, except in full, without prior written permission of the Company. 除非另有說明，此報告結果僅對測試之樣品負責。本報告未經本公司書面許可，不可部份複製。
This Test Report is issued by the Company under its General Conditions of Service which is available on request or accessible at http://www.sgs.com/terms_and_conditions.htm. Attention is drawn to the limitation of liability, indemnification and jurisdiction issues defined therein. Any holder of this Test Report is advised that information contained hereon reflects the Company's findings at the time of its intervention only and within the limits of Client's instructions, if any. The Company's sole responsibility is to its Client and this document does not exonerate parties to a transaction from exercising all their rights and obligations under the transaction documents. Any unauthorized alteration, forgery or falsification of the content or appearance of this document is unlawful and offenders may be prosecuted to the fullest extent of the law.

9.4. Test SET-UP (Block Diagram of Configuration)

(A) Radiated Emission Test Set-Up, Frequency Below 30MHz

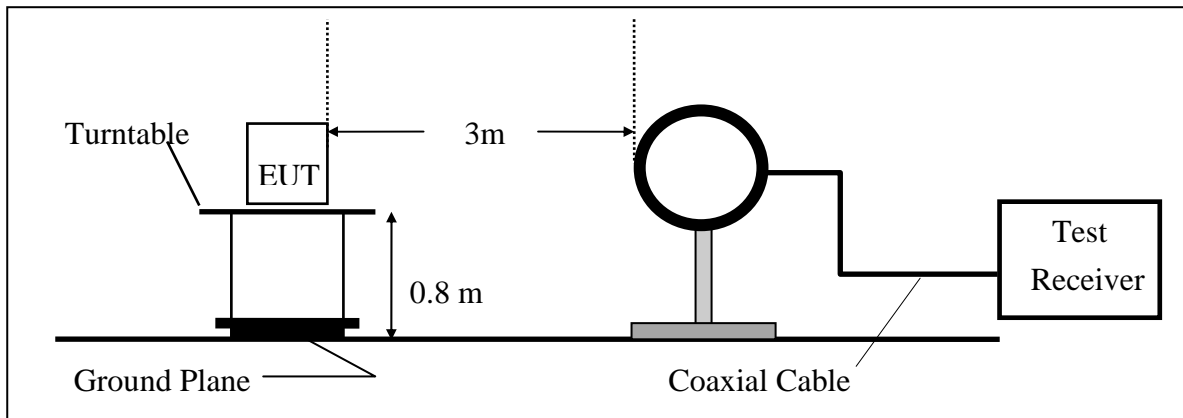

(B) Radiated Emission Test Set-Up, Frequency Below 1000MHz

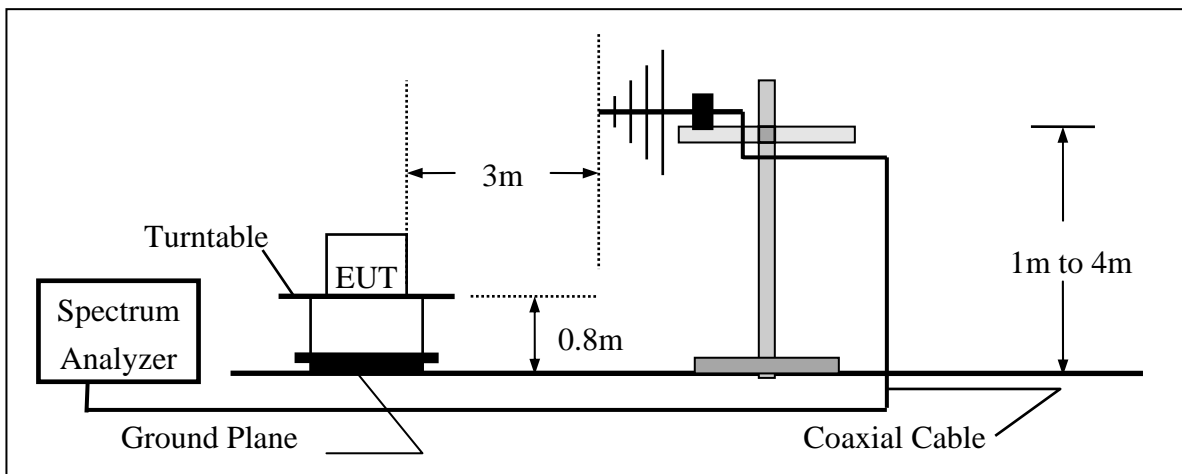

(C) Radiated Emission Test Set-UP Frequency Over 1 GHz

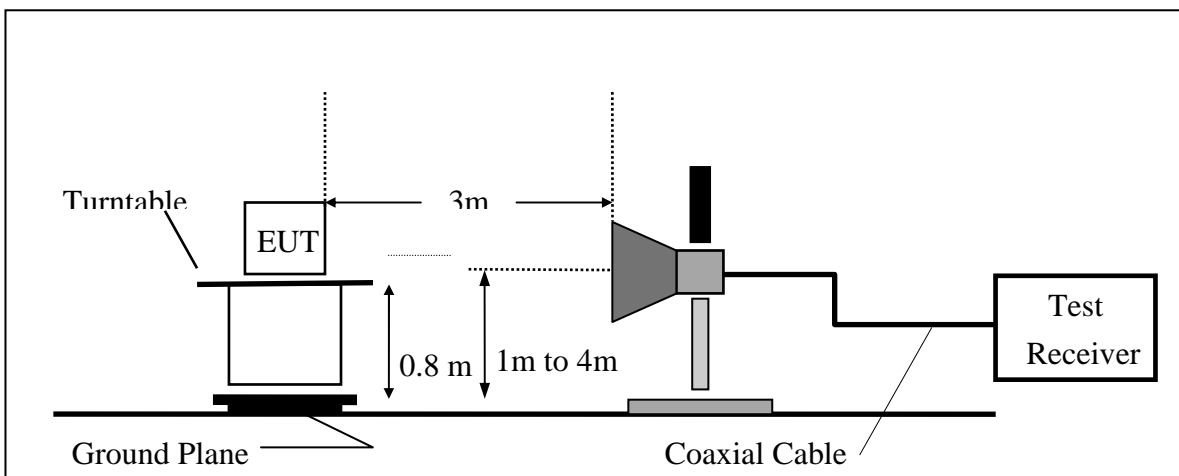

Unless otherwise stated the results shown in this test report refer only to the sample(s) tested. This test report cannot be reproduced, except in full, without prior written permission of the Company. 除非另有說明，此報告結果僅對測試之樣品負責。本報告未經本公司書面許可，不可部份複製。
 This Test Report is issued by the Company under its General Conditions of Service which is available on request or accessible at http://www.sgs.com/terms_and_conditions.htm. Attention is drawn to the limitation of liability, indemnification and jurisdiction issues defined therein. Any holder of this Test Report is advised that information contained hereon reflects the Company's findings at the time of its intervention only and within the limits of Client's instructions, if any. The Company's sole responsibility is to its Client and this document does not exonerate parties to a transaction from exercising all their rights and obligations under the transaction documents. Any unauthorized alteration, forgery or falsification of the content or appearance of this document is unlawful and offenders may be prosecuted to the fullest extent of the law.

Measurement Equipment Used:

966 Chamber					
EQUIPMENT TYPE	MFR	MODEL NUMBER	SERIAL NUMBER	LAST CAL.	CAL DUE.
Spectrum Analyzer	R&S	FSP 40	100034	02/12/2009	02/11/2010
Loop antenna	MESSTEC	FLA30	03/10086	06/06/2008	06/05/2010
Bilog Antenna	SCHWAZBECK	VULB9160	9160-3136	11/15/2008	11/14/2009
Horn antenna	SCHWAZBECK	BBHA 9120D	9120D-673	05/09/2008	05/08/2010
Pre-Amplifier	Agilent	8447D	1937A02834	11/30/2008	11/29/2009
Pre-Amplifier	Agilent	8449B	3008A01973	01/05/2009	01/04/2010
Turn Table	HD	DT420	N/A	N.C.R	N.C.R
Antenna Tower	HD	MA240-N	240/657	N.C.R	N.C.R
Controller	HD	HD100	N/A	N.C.R	N.C.R
Low Loss Cable	HUBER+SUHNER	SUCOFLEX 104PEA-10M	10m	01/05/2009	01/04/2010
Low Loss Cable	HUBER+SUHNER	SUCOFLEX 104PEA-3M	3m	01/05/2009	01/04/2010
3m Site	SGS	966 chamber	N/A	11/08/2008	11/09/2009

9.5. Field Strength Calculation

The field strength is calculated by adding the Antenna Factor and Cable Factor and subtracting the Amplifier Gain and Duty Cycle Correction Factor(if any) from the measured reading. The basic equation with a sample calculation is as follows:

$$FS = RA + AF + CL - AG$$

Where	FS = Field Strength	CL = Cable Attenuation Factor (Cable Loss)
	RA = Reading Amplitude	AG = Amplifier Gain
	AF = Antenna Factor	

9.6. Measurement Result

Refer to attach tabular data sheets.

Unless otherwise stated the results shown in this test report refer only to the sample(s) tested. This test report cannot be reproduced, except in full, without prior written permission of the Company. 除非另有說明，此報告結果僅對測試之樣品負責。本報告未經本公司書面許可，不可部份複製。
 This Test Report is issued by the Company under its General Conditions of Service which is available on request or accessible at http://www.sgs.com/terms_and_conditions.htm. Attention is drawn to the limitation of liability, indemnification and jurisdiction issues defined therein. Any holder of this Test Report is advised that information contained hereon reflects the Company's findings at the time of its intervention only and within the limits of Client's instructions, if any. The Company's sole responsibility is to its Client and this document does not exonerate parties to a transaction from exercising all their rights and obligations under the transaction documents. Any unauthorized alteration, forgery or falsification of the content or appearance of this document is unlawful and offenders may be prosecuted to the fullest extent of the law.

Conducted Spurious Emission Measurement Result (802.11b)
Ch Low 30MHz – 3GHz (Patch 1 Internal Antenna)

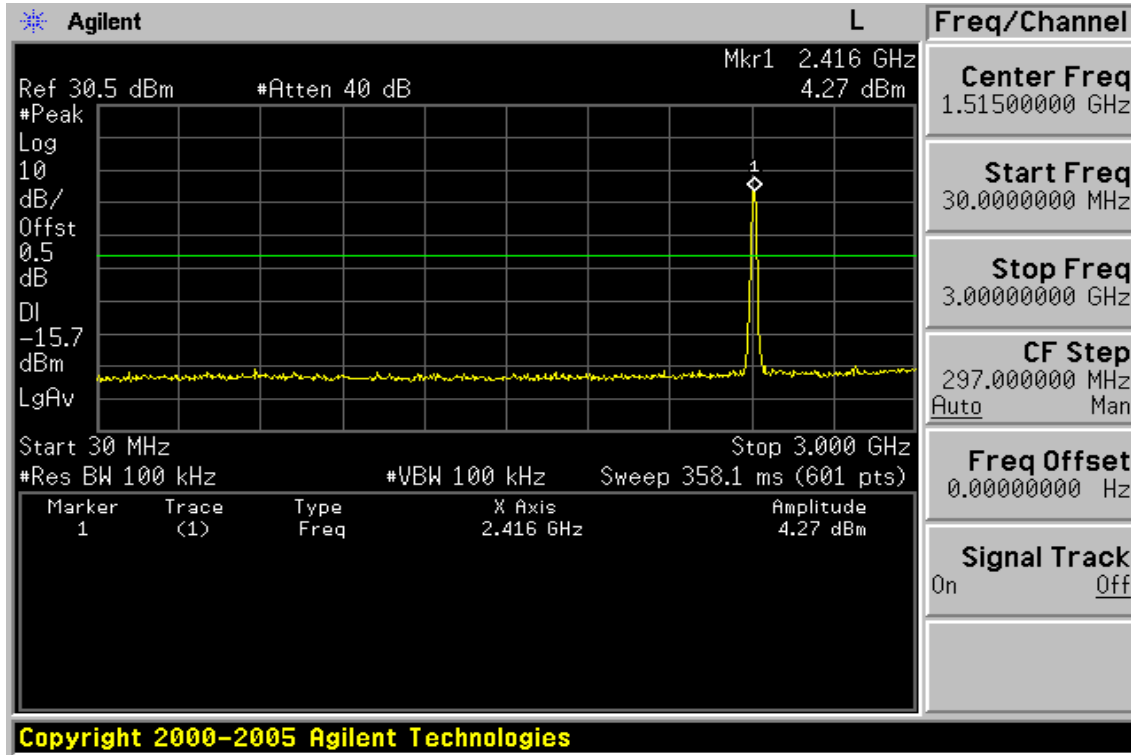

Ch Low 3GHz – 26.5GHz

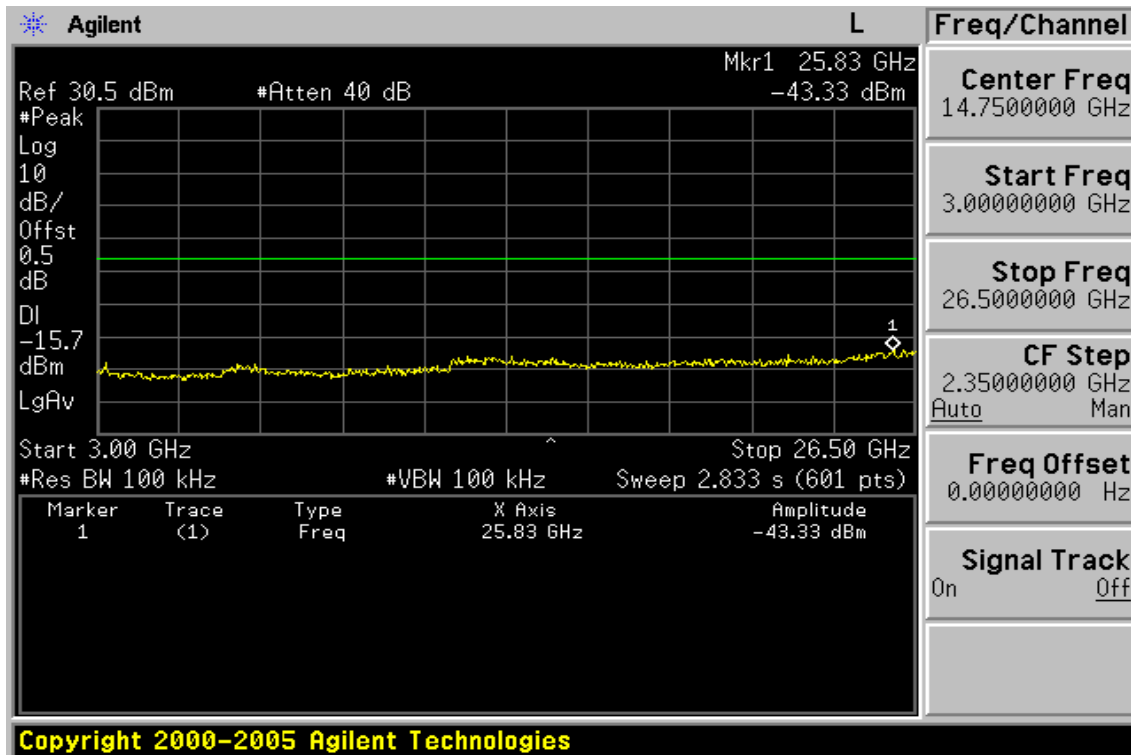

Unless otherwise stated the results shown in this test report refer only to the sample(s) tested. This test report cannot be reproduced, except in full, without prior written permission of the Company. 除非另有說明，此報告結果僅對測試之樣品負責。本報告未經本公司書面許可，不可部份複製。
 This Test Report is issued by the Company under its General Conditions of Service which is available on request or accessible at http://www.sgs.com/terms_and_conditions.htm. Attention is drawn to the limitation of liability, indemnification and jurisdiction issues defined therein. Any holder of this Test Report is advised that information contained hereon reflects the Company's findings at the time of its intervention only and within the limits of Client's instructions, if any. The Company's sole responsibility is to its Client and this document does not exonerate parties to a transaction from exercising all their rights and obligations under the transaction documents. Any unauthorized alteration, forgery or falsification of the content or appearance of this document is unlawful and offenders may be prosecuted to the fullest extent of the law.

Ch Mid 30MHz – 3GHz

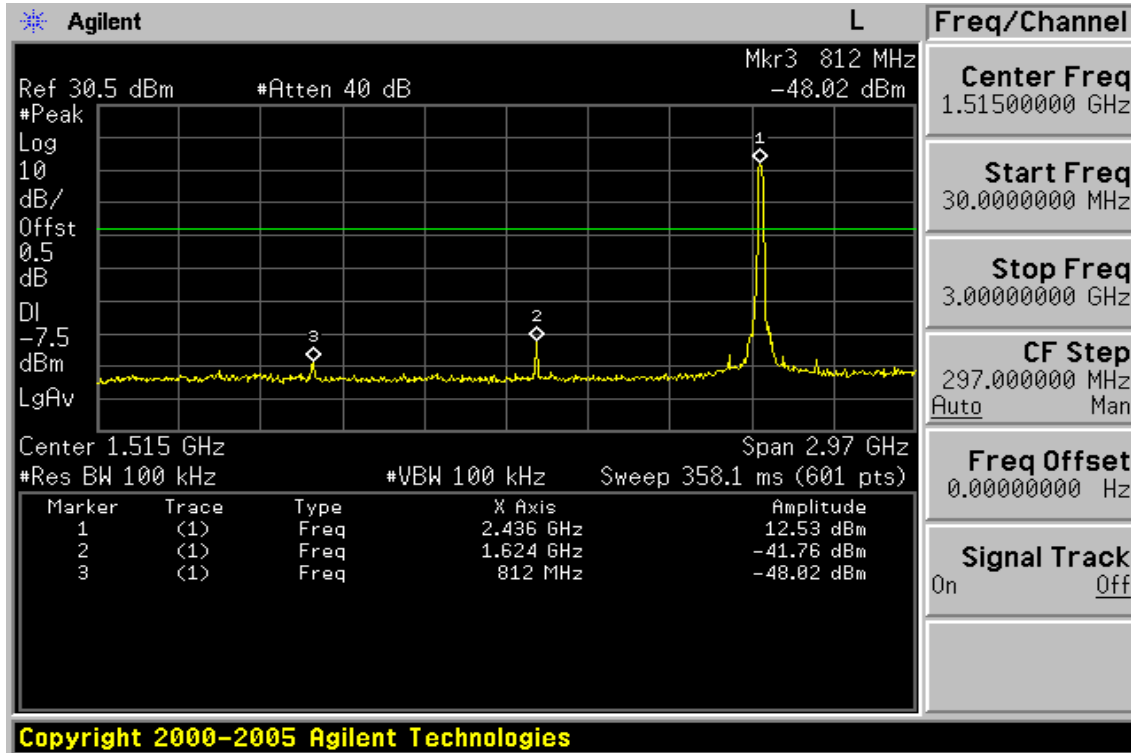

Ch Mid 3GHz – 26.5GHz

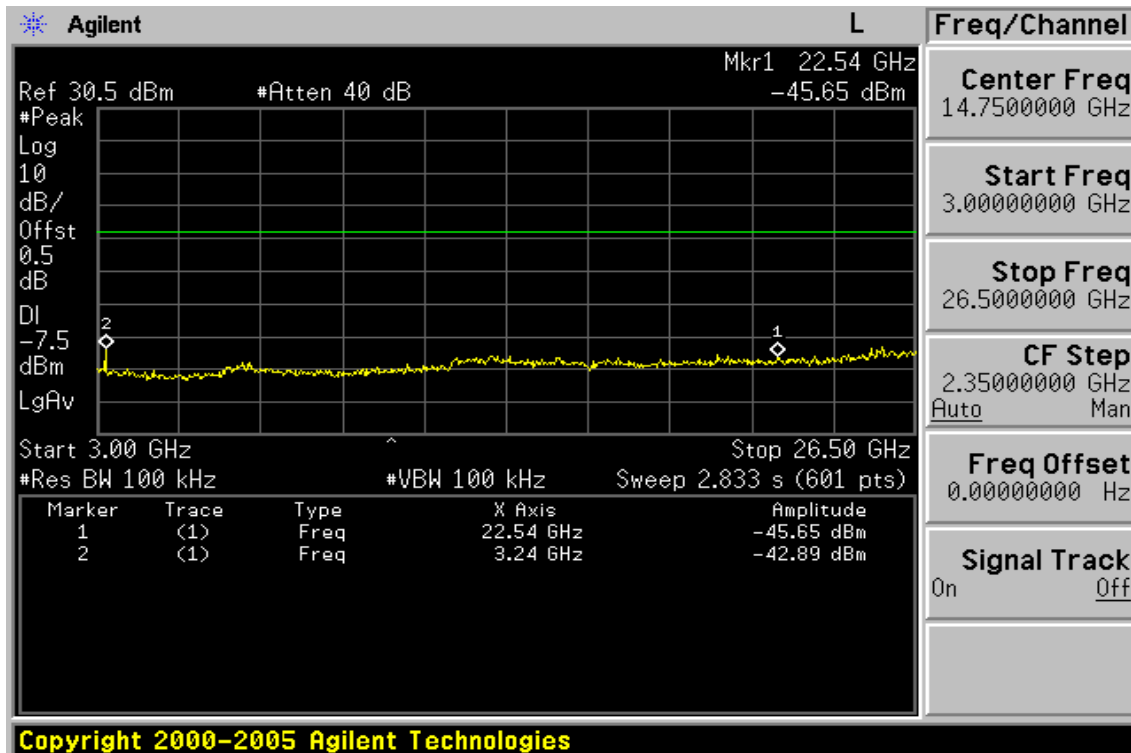

Unless otherwise stated the results shown in this test report refer only to the sample(s) tested. This test report cannot be reproduced, except in full, without prior written permission of the Company. 除非另有說明，此報告結果僅對測試之樣品負責。本報告未經本公司書面許可，不可部份複製。

This Test Report is issued by the Company under its General Conditions of Service which is available on request or accessible at http://www.sgs.com/terms_and_conditions.htm. Attention is drawn to the limitation of liability, indemnification and jurisdiction issues defined therein. Any holder of this Test Report is advised that information contained hereon reflects the Company's findings at the time of its intervention only and within the limits of Client's instructions, if any. The Company's sole responsibility is to its Client and this document does not exonerate parties to a transaction from exercising all their rights and obligations under the transaction documents. Any unauthorized alteration, forgery or falsification of the content or appearance of this document is unlawful and offenders may be prosecuted to the fullest extent of the law.

Ch High 30MHz – 3GHz

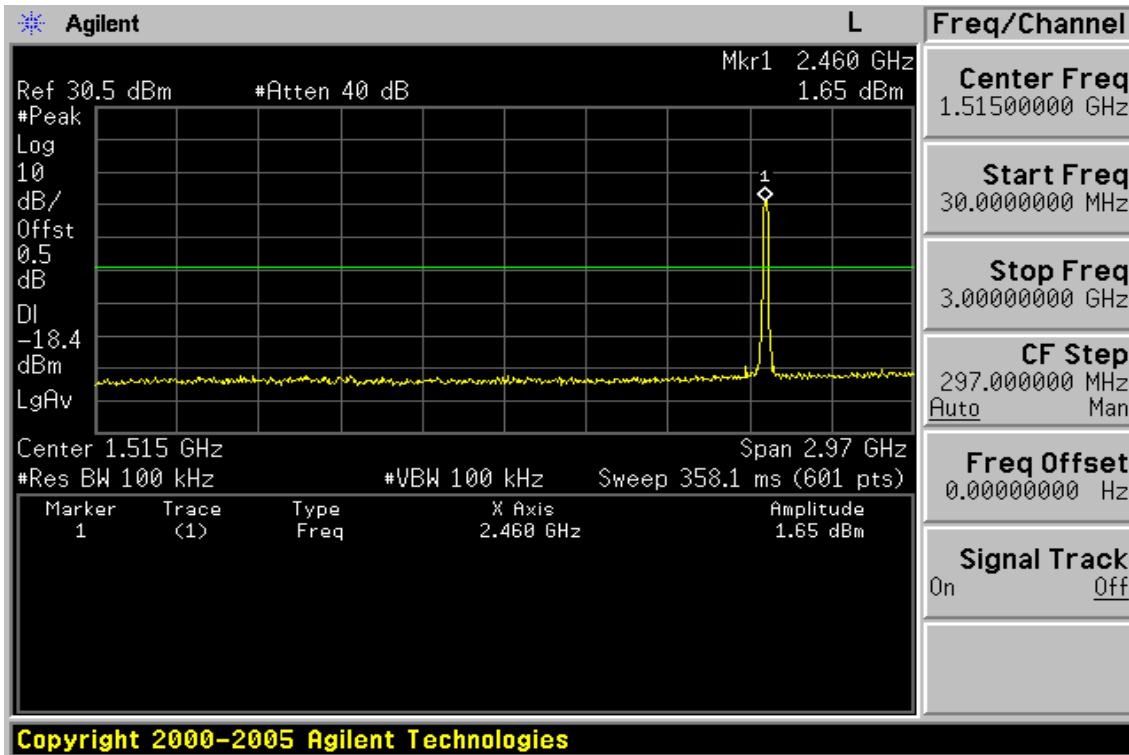

Ch High 3GHz – 26.5GHz

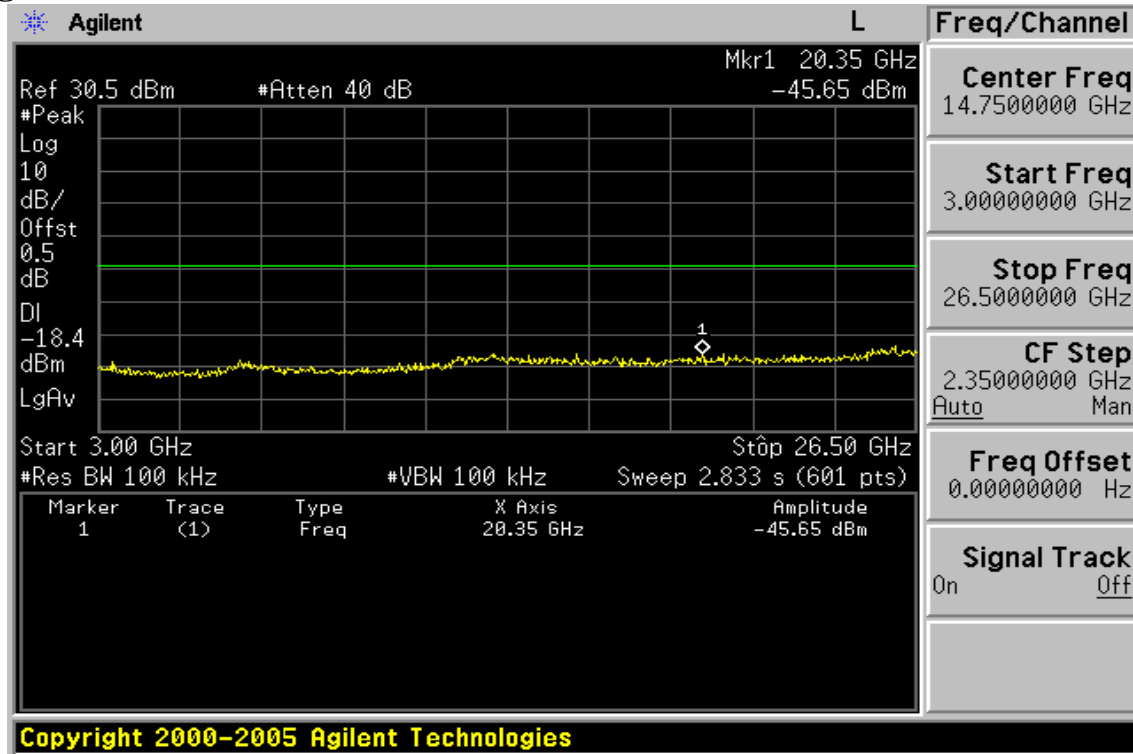

Unless otherwise stated the results shown in this test report refer only to the sample(s) tested. This test report cannot be reproduced, except in full, without prior written permission of the Company. 除非另有說明，此報告結果僅對測試之樣品負責。本報告未經本公司書面許可，不可部份複製。
 This Test Report is issued by the Company under its General Conditions of Service which is available on request or accessible at http://www.sgs.com/terms_and_conditions.htm. Attention is drawn to the limitation of liability, indemnification and jurisdiction issues defined therein. Any holder of this Test Report is advised that information contained hereon reflects the Company's findings at the time of its intervention only and within the limits of Client's instructions, if any. The Company's sole responsibility is to its Client and this document does not exonerate parties to a transaction from exercising all their rights and obligations under the transaction documents. Any unauthorized alteration, forgery or falsification of the content or appearance of this document is unlawful and offenders may be prosecuted to the fullest extent of the law.

Conducted Spurious Emission Measurement Result (802.11g)

Ch Low 30MHz – 3GHz

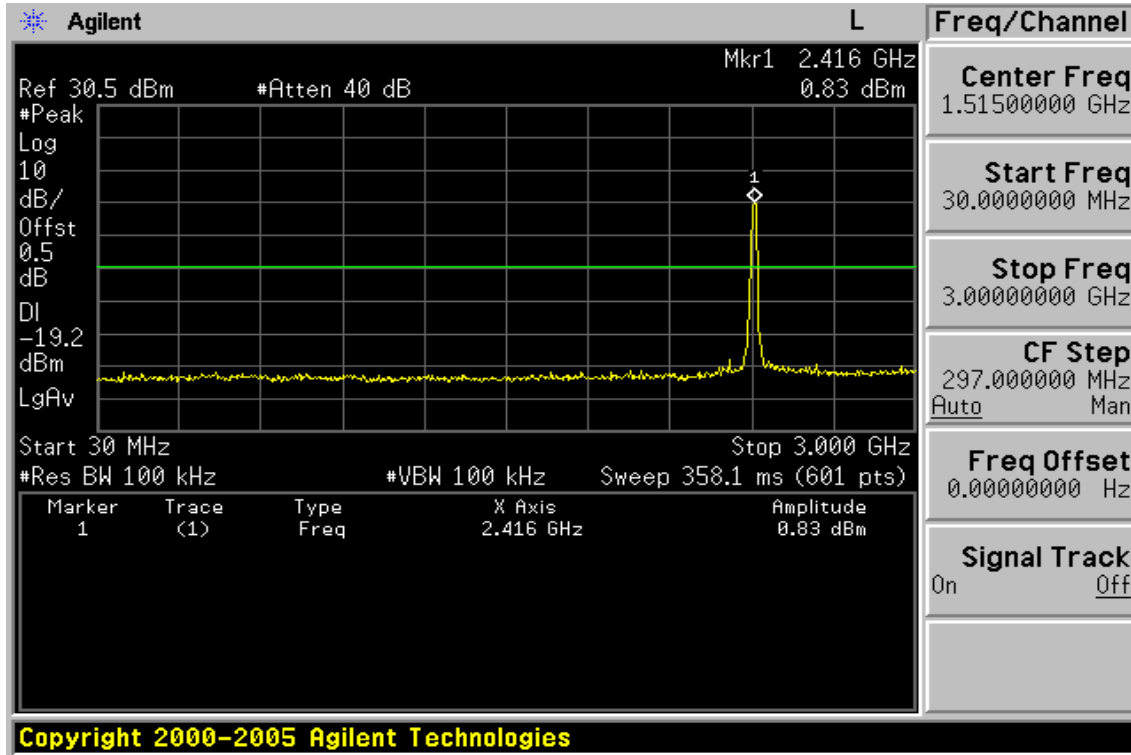

Ch Low 3GHz – 26.5GHz

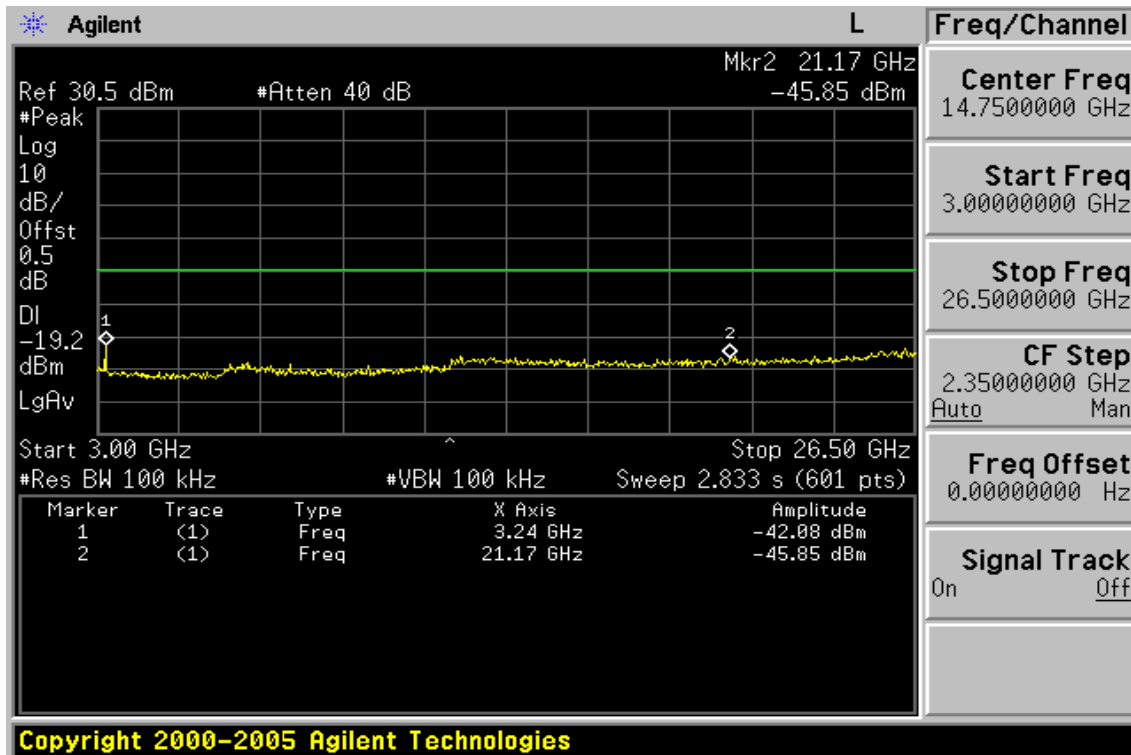

Unless otherwise stated the results shown in this test report refer only to the sample(s) tested. This test report cannot be reproduced, except in full, without prior written permission of the Company. 除非另有說明，此報告結果僅對測試之樣品負責。本報告未經本公司書面許可，不可部份複製。
 This Test Report is issued by the Company under its General Conditions of Service which is available on request or accessible at http://www.sgs.com/terms_and_conditions.htm. Attention is drawn to the limitation of liability, indemnification and jurisdiction issues defined therein. Any holder of this Test Report is advised that information contained hereon reflects the Company's findings at the time of its intervention only and within the limits of Client's instructions, if any. The Company's sole responsibility is to its Client and this document does not exonerate parties to a transaction from exercising all their rights and obligations under the transaction documents. Any unauthorized alteration, forgery or falsification of the content or appearance of this document is unlawful and offenders may be prosecuted to the fullest extent of the law.

Ch Mid 30MHz – 3GHz

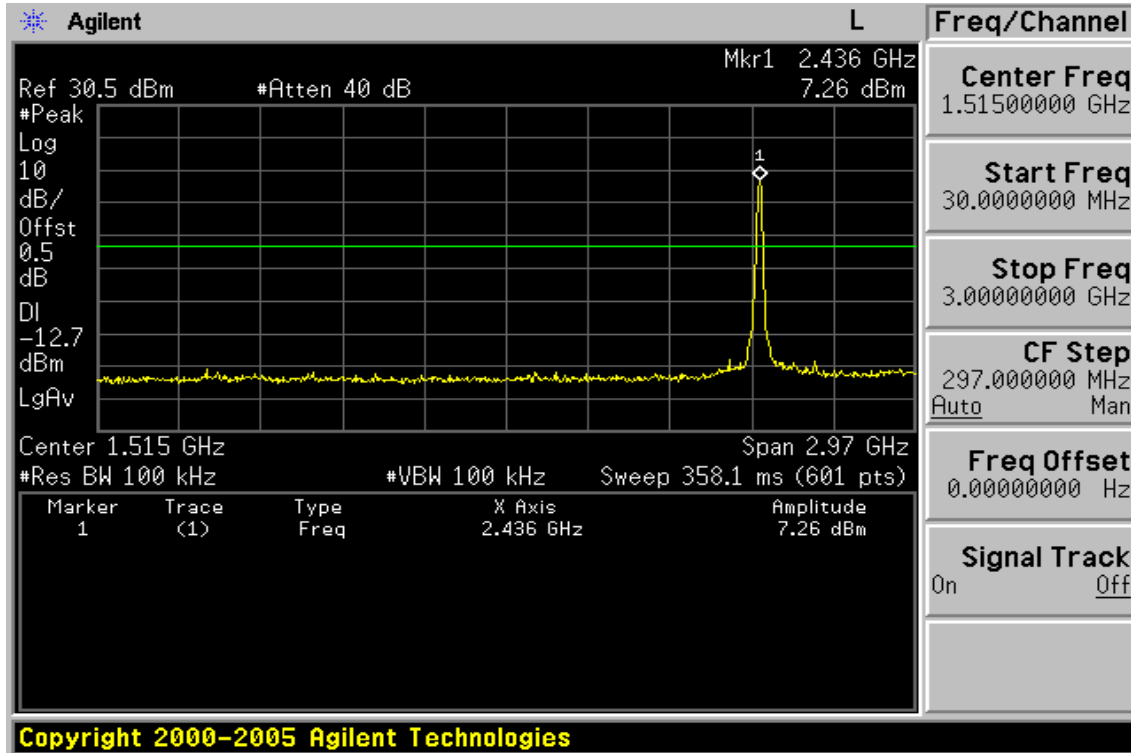

Ch Mid 3GHz – 26.5GHz

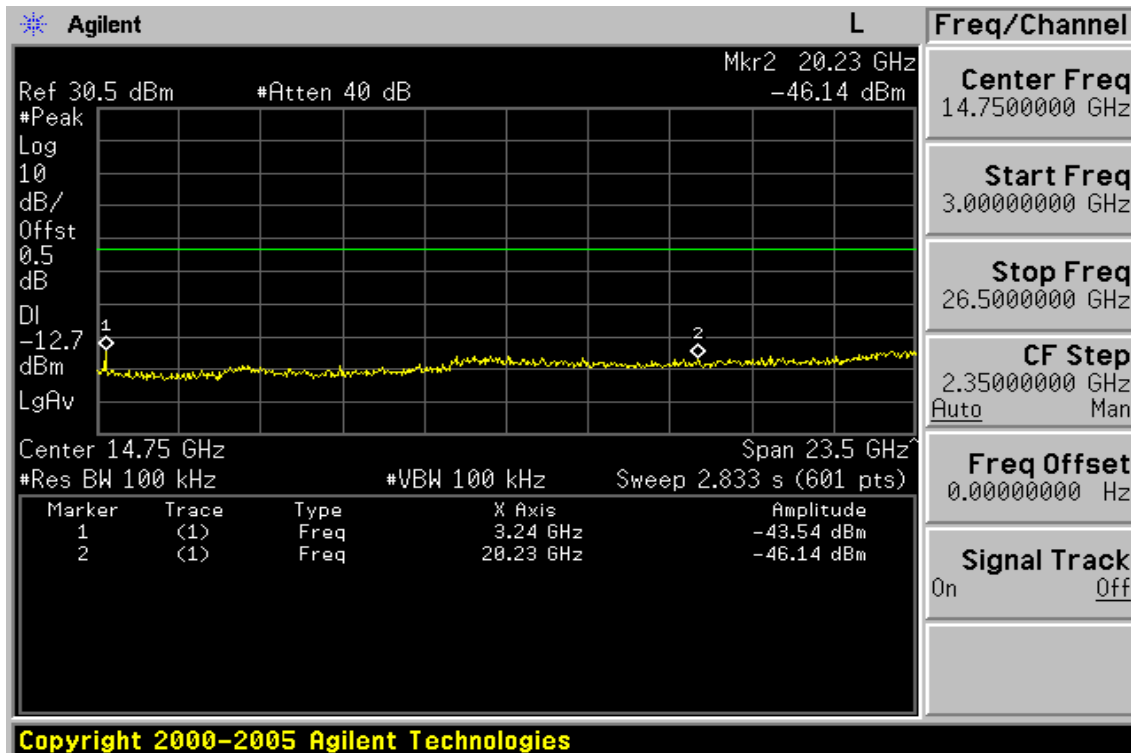

Unless otherwise stated the results shown in this test report refer only to the sample(s) tested. This test report cannot be reproduced, except in full, without prior written permission of the Company. 除非另有說明，此報告結果僅對測試之樣品負責。本報告未經本公司書面許可，不可部份複製。
 This Test Report is issued by the Company under its General Conditions of Service which is available on request or accessible at http://www.sgs.com/terms_and_conditions.htm. Attention is drawn to the limitation of liability, indemnification and jurisdiction issues defined therein. Any holder of this Test Report is advised that information contained hereon reflects the Company's findings at the time of its intervention only and within the limits of Client's instructions, if any. The Company's sole responsibility is to its Client and this document does not exonerate parties to a transaction from exercising all their rights and obligations under the transaction documents. Any unauthorized alteration, forgery or falsification of the content or appearance of this document is unlawful and offenders may be prosecuted to the fullest extent of the law.

Ch High 30MHz – 3GHz

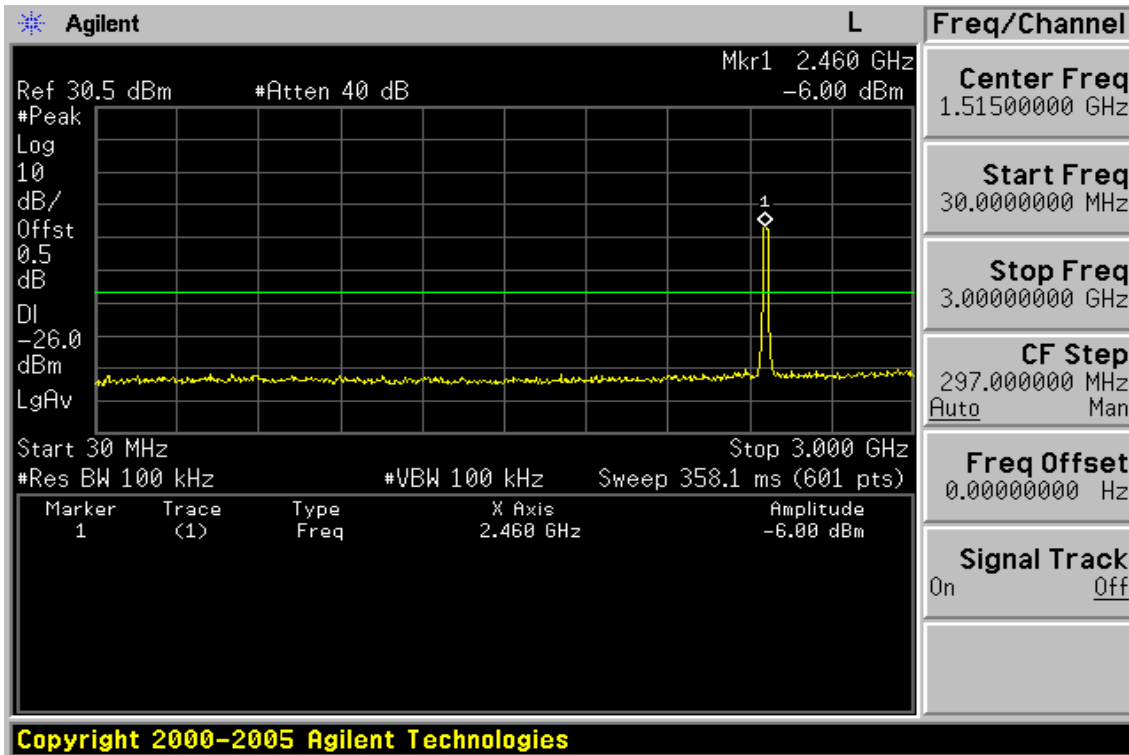

Ch High 3GHz – 26.5GHz

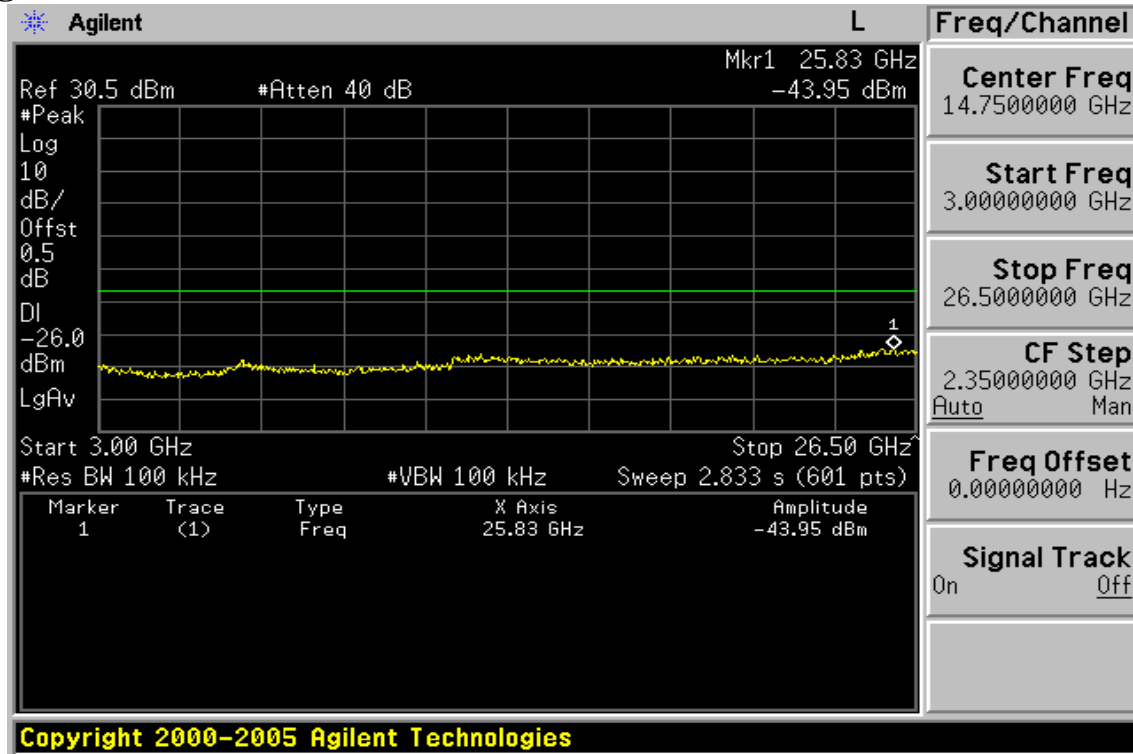

Unless otherwise stated the results shown in this test report refer only to the sample(s) tested. This test report cannot be reproduced, except in full, without prior written permission of the Company. 除非另有說明，此報告結果僅對測試之樣品負責。本報告未經本公司書面許可，不可部份複製。
 This Test Report is issued by the Company under its General Conditions of Service which is available on request or accessible at http://www.sgs.com/terms_and_conditions.htm. Attention is drawn to the limitation of liability, indemnification and jurisdiction issues defined therein. Any holder of this Test Report is advised that information contained hereon reflects the Company's findings at the time of its intervention only and within the limits of Client's instructions, if any. The Company's sole responsibility is to its Client and this document does not exonerate parties to a transaction from exercising all their rights and obligations under the transaction documents. Any unauthorized alteration, forgery or falsification of the content or appearance of this document is unlawful and offenders may be prosecuted to the fullest extent of the law.

Patch 1 Internal Antenna

Radiated Spurious Emission Measurement Result (below 1GHz) (802.11b)

Operation Mode	802.11b TX CH Low	Test Date	Jun. 30, 2009
Fundamental Frequency	2412MHz	Test By	Brian
Temperature	25 °C	Pol	Ver./Hor
Humidity	60 %		

Freq. (MHz)	Ant.Pol. H/V	Detector Mode (PK/QP)	Reading (dBuV)	Factor (dB)	Actual FS (dBuV/m)	Limit3m (dBuV/m)	Safe Mar- gin (dB)
23.54	V	Peak	35.53	0.54	36.07	69.50	-33.43
58.13	V	Peak	57.48	-26.67	30.81	40.00	-9.19
99.84	V	Peak	64.62	-30.49	34.13	43.50	-9.37
106.63	V	Peak	64.15	-29.71	34.44	43.50	-9.06
184.23	V	Peak	61.93	-30.00	31.93	43.50	-11.57
552.83	V	Peak	62.46	-23.68	38.78	46.00	-7.22
625.58	V	Peak	53.86	-22.33	31.53	46.00	-14.47
23.79	H	Peak	30.58	0.54	31.12	69.50	-38.38
99.84	H	Peak	54.72	-30.49	24.23	43.50	-19.27
126.03	H	Peak	53.00	-28.38	24.62	43.50	-18.88
184.23	H	Peak	61.12	-30.00	31.12	43.50	-12.38
276.38	H	Peak	53.68	-29.18	24.50	46.00	-21.50
812.79	H	Peak	48.82	-20.01	28.81	46.00	-17.19
919.49	H	Peak	54.28	-18.80	35.48	46.00	-10.52

Remark :

- (1) Measuring frequencies from 30 MHz to the 1GHz .
- (2) Radiated emissions measured in frequency range from 30 MHz to 1000MHz were made with an instrument using Peak/QP detector mode.
- (3) Data of measurement within this frequency range shown “ - ” in the table above means the reading of emissions are attenuated more than 20dB below the permissible limits or the field strength is too small to be measured.
- (4) The IF bandwidth of SPA between 30MHz to 1GHz was 100KHz.

Unless otherwise stated the results shown in this test report refer only to the sample(s) tested. This test report cannot be reproduced, except in full, without prior written permission of the Company. 除非另有說明，此報告結果僅對測試之樣品負責。本報告未經本公司書面許可，不可部份複製。
 This Test Report is issued by the Company under its General Conditions of Service which is available on request or accessible at http://www.sgs.com/terms_and_conditions.htm. Attention is drawn to the limitation of liability, indemnification and jurisdiction issues defined therein. Any holder of this Test Report is advised that information contained hereon reflects the Company's findings at the time of its intervention only and within the limits of Client's instructions, if any. The Company's sole responsibility is to its Client and this document does not exonerate parties to a transaction from exercising all their rights and obligations under the transaction documents. Any unauthorized alteration, forgery or falsification of the content or appearance of this document is unlawful and offenders may be prosecuted to the fullest extent of the law. .

Radiated Spurious Emission Measurement Result (below 1GHz) (802.11b)

Operation Mode	802.11b TX CH Mid	Test Date	Jun. 30, 2009
Fundamental Frequency	2437MHz	Test By	Brian
Temperature	25 °C	Pol	Ver./Hor
Humidity	60 %		

Freq. (MHz)	Ant.Pol. H/V	Detector Mode (PK/QP)	Reading (dBuV)	Factor (dB)	Actual FS (dBuV/m)	Limit3m (dBuV/m)	Safe Mar- gin (dB)
22.67	V	Peak	33.55	0.54	34.09	69.50	-35.41
58.13	V	Peak	58.23	-26.67	31.56	40.00	-8.44
99.84	V	Peak	65.93	-30.49	35.44	43.50	-8.06
106.63	V	Peak	64.67	-29.71	34.96	43.50	-8.54
184.23	V	Peak	62.39	-30.00	32.39	43.50	-11.11
552.83	V	Peak	56.68	-23.68	33.00	46.00	-13.00
625.58	V	Peak	54.79	-22.33	32.46	46.00	-13.54
24.04	H	Peak	30.37	0.54	30.91	69.50	-38.59
126.03	H	Peak	53.45	-28.38	25.07	43.50	-18.43
184.23	H	Peak	61.49	-30.00	31.49	43.50	-12.01
552.83	H	Peak	53.47	-23.68	29.79	46.00	-16.21
674.08	H	Peak	49.81	-21.52	28.29	46.00	-17.71
809.88	H	Peak	49.97	-20.02	29.95	46.00	-16.05
919.49	H	Peak	51.58	-18.80	32.78	46.00	-13.22

Remark :

- (1) Measuring frequencies from 30 MHz to the 1GHz .
- (2) Radiated emissions measured in frequency range from 30 MHz to 1000MHz were made with an instrument using Peak/QP detector mode.
- (3) Data of measurement within this frequency range shown “ - ” in the table above means the reading of emissions are attenuated more than 20dB below the permissible limits or the field strength is too small to be measured.
- (4) The IF bandwidth of SPA between 30MHz to 1GHz was 100KHz.

Unless otherwise stated the results shown in this test report refer only to the sample(s) tested. This test report cannot be reproduced, except in full, without prior written permission of the Company. 除非另有說明，此報告結果僅對測試之樣品負責。本報告未經本公司書面許可，不可部份複製。
 This Test Report is issued by the Company under its General Conditions of Service which is available on request or accessible at http://www.sgs.com/terms_and_conditions.htm. Attention is drawn to the limitation of liability, indemnification and jurisdiction issues defined therein. Any holder of this Test Report is advised that information contained hereon reflects the Company's findings at the time of its intervention only and within the limits of Client's instructions, if any. The Company's sole responsibility is to its Client and this document does not exonerate parties to a transaction from exercising all their rights and obligations under the transaction documents. Any unauthorized alteration, forgery or falsification of the content or appearance of this document is unlawful and offenders may be prosecuted to the fullest extent of the law. .

Radiated Spurious Emission Measurement Result (below 1GHz) (802.11b)

Operation Mode	802.11b TX CH High	Test Date	Jun. 30, 2009
Fundamental Frequency	2462MHz	Test By	Brian
Temperature	25 °C	Pol	Ver./Hor
Humidity	60 %		

Freq. (MHz)	Ant.Pol. H/V	Detector Mode (PK/QP)	Reading (dBuV)	Factor (dB)	Actual FS (dBuV/m)	Limit3m (dBuV/m)	Safe Mar- gin (dB)
23.32	V	Peak	36.17	0.54	36.71	69.50	-32.79
58.13	V	Peak	57.91	-26.67	31.24	40.00	-8.76
99.84	V	Peak	66.09	-30.49	35.60	43.50	-7.90
104.69	V	Peak	63.46	-29.90	33.56	43.50	-9.94
126.03	V	Peak	57.23	-28.38	28.85	43.50	-14.65
184.23	V	Peak	63.76	-30.00	33.76	43.50	-9.74
552.83	V	Peak	56.84	-23.68	33.16	46.00	-12.84
23.79	H	Peak	31.38	0.54	31.92	69.50	-37.58
104.69	H	Peak	54.82	-29.90	24.92	43.50	-18.58
126.03	H	Peak	54.40	-28.38	26.02	43.50	-17.48
184.23	H	Peak	62.69	-30.00	32.69	43.50	-10.81
276.38	H	Peak	53.68	-29.18	24.50	46.00	-21.50
809.88	H	Peak	49.50	-20.02	29.48	46.00	-16.52
919.49	H	Peak	52.88	-18.80	34.08	46.00	-11.92

Remark :

- (1) Measuring frequencies from 30 MHz to the 1GHz .
- (2) Radiated emissions measured in frequency range from 30 MHz to 1000MHz were made with an instrument using Peak/QP detector mode.
- (3) Data of measurement within this frequency range shown “ - ” in the table above means the reading of emissions are attenuated more than 20dB below the permissible limits or the field strength is too small to be measured.
- (4) The IF bandwidth of SPA between 30MHz to 1GHz was 100KHz.

Unless otherwise stated the results shown in this test report refer only to the sample(s) tested. This test report cannot be reproduced, except in full, without prior written permission of the Company. 除非另有說明，此報告結果僅對測試之樣品負責。本報告未經本公司書面許可，不可部份複製。
 This Test Report is issued by the Company under its General Conditions of Service which is available on request or accessible at http://www.sgs.com/terms_and_conditions.htm. Attention is drawn to the limitation of liability, indemnification and jurisdiction issues defined therein. Any holder of this Test Report is advised that information contained hereon reflects the Company's findings at the time of its intervention only and within the limits of Client's instructions, if any. The Company's sole responsibility is to its Client and this document does not exonerate parties to a transaction from exercising all their rights and obligations under the transaction documents. Any unauthorized alteration, forgery or falsification of the content or appearance of this document is unlawful and offenders may be prosecuted to the fullest extent of the law. .

Radiated Spurious Emission Measurement Result (below 1GHz) (802.11g)

Operation Mode	802.11g TX CH Low	Test Date	Jun. 30, 2009
Fundamental Frequency	2412MHz	Test By	Brian
Temperature	25 °C	Pol	Ver./Hor
Humidity	60 %		

Freq. (MHz)	Ant.Pol. H/V	Detector Mode (PK/QP)	Reading (dBuV)	Factor (dB)	Actual FS (dBuV/m)	Limit3m (dBuV/m)	Safe Mar- gin (dB)
23.07	V	Peak	34.68	0.54	35.22	69.50	-34.28
58.13	V	Peak	57.97	-26.67	31.30	40.00	-8.70
99.84	V	Peak	65.13	-30.49	34.64	43.50	-8.86
106.63	V	Peak	64.53	-29.71	34.82	43.50	-8.68
184.23	V	Peak	62.46	-30.00	32.46	43.50	-11.04
552.83	V	Peak	61.50	-23.68	37.82	46.00	-8.18
625.58	V	Peak	53.98	-22.33	31.65	46.00	-14.35
22.57	H	Peak	30.82	0.54	31.36	69.50	-38.14
106.63	H	Peak	54.72	-29.71	25.01	43.50	-18.49
126.03	H	Peak	53.82	-28.38	25.44	43.50	-18.06
184.23	H	Peak	61.68	-30.00	31.68	43.50	-11.82
674.08	H	Peak	48.75	-21.52	27.23	46.00	-18.77
812.79	H	Peak	49.25	-20.01	29.24	46.00	-16.76
919.49	H	Peak	54.00	-18.80	35.20	46.00	-10.80

Remark :

- (1) Measuring frequencies from 30 MHz to the 1GHz .
- (2) Radiated emissions measured in frequency range from 30 MHz to 1000MHz were made with an instrument using Peak/QP detector mode.
- (3) Data of measurement within this frequency range shown “ - ” in the table above means the reading of emissions are attenuated more than 20dB below the permissible limits or the field strength is too small to be measured.
- (4) The IF bandwidth of SPA between 30MHz to 1GHz was 100KHz.

Unless otherwise stated the results shown in this test report refer only to the sample(s) tested. This test report cannot be reproduced, except in full, without prior written permission of the Company. 除非另有說明，此報告結果僅對測試之樣品負責。本報告未經本公司書面許可，不可部份複製。
 This Test Report is issued by the Company under its General Conditions of Service which is available on request or accessible at http://www.sgs.com/terms_and_conditions.htm. Attention is drawn to the limitation of liability, indemnification and jurisdiction issues defined therein. Any holder of this Test Report is advised that information contained hereon reflects the Company's findings at the time of its intervention only and within the limits of Client's instructions, if any. The Company's sole responsibility is to its Client and this document does not exonerate parties to a transaction from exercising all their rights and obligations under the transaction documents. Any unauthorized alteration, forgery or falsification of the content or appearance of this document is unlawful and offenders may be prosecuted to the fullest extent of the law. .

Radiated Spurious Emission Measurement Result (below 1GHz) (802.11g)

Operation Mode	802.11g TX CH Mid	Test Date	Jun. 30, 2009
Fundamental Frequency	2437MHz	Test By	Brian
Temperature	25 °C	Pol	Ver./Hor
Humidity	60 %		

Freq. (MHz)	Ant.Pol. H/V	Detector Mode (PK/QP)	Reading (dBuV)	Factor (dB)	Actual FS (dBuV/m)	Limit3m (dBuV/m)	Safe Mar- gin (dB)
22.59	V	Peak	34.52	0.54	35.06	69.50	-34.44
58.13	V	Peak	57.75	-26.67	31.08	40.00	-8.92
99.84	V	Peak	64.77	-30.49	34.28	43.50	-9.22
106.63	V	Peak	64.98	-29.71	35.27	43.50	-8.23
126.03	V	Peak	57.50	-28.38	29.12	43.50	-14.38
184.23	V	Peak	62.38	-30.00	32.38	43.50	-11.12
552.83	V	Peak	56.75	-23.68	33.07	46.00	-12.93
23.80	H	Peak	29.87	0.54	30.41	69.50	-39.09
106.63	H	Peak	54.72	-29.71	25.01	43.50	-18.49
126.03	H	Peak	53.82	-28.38	25.44	43.50	-18.06
276.38	H	Peak	53.04	-29.18	23.86	46.00	-22.14
674.08	H	Peak	49.43	-21.52	27.91	46.00	-18.09
809.88	H	Peak	49.74	-20.02	29.72	46.00	-16.28
919.49	H	Peak	54.00	-18.80	35.20	46.00	-10.80

Remark :

- (1) Measuring frequencies from 30 MHz to the 1GHz .
- (2) Radiated emissions measured in frequency range from 30 MHz to 1000MHz were made with an instrument using Peak/QP detector mode.
- (3) Data of measurement within this frequency range shown “ - ” in the table above means the reading of emissions are attenuated more than 20dB below the permissible limits or the field strength is too small to be measured.
- (4) The IF bandwidth of SPA between 30MHz to 1GHz was 100KHz.

Unless otherwise stated the results shown in this test report refer only to the sample(s) tested. This test report cannot be reproduced, except in full, without prior written permission of the Company. 除非另有說明，此報告結果僅對測試之樣品負責。本報告未經本公司書面許可，不可部份複製。
 This Test Report is issued by the Company under its General Conditions of Service which is available on request or accessible at http://www.sgs.com/terms_and_conditions.htm. Attention is drawn to the limitation of liability, indemnification and jurisdiction issues defined therein. Any holder of this Test Report is advised that information contained hereon reflects the Company's findings at the time of its intervention only and within the limits of Client's instructions, if any. The Company's sole responsibility is to its Client and this document does not exonerate parties to a transaction from exercising all their rights and obligations under the transaction documents. Any unauthorized alteration, forgery or falsification of the content or appearance of this document is unlawful and offenders may be prosecuted to the fullest extent of the law. .

Radiated Spurious Emission Measurement Result (below 1GHz) (802.11g)

Operation Mode	802.11g TX CH High	Test Date	Jun. 30, 2009
Fundamental Frequency	2462MHz	Test By	Brian
Temperature	25 °C	Pol	Ver./Hor
Humidity	60 %		

Freq. (MHz)	Ant.Pol. H/V	Detector Mode (PK/QP)	Reading (dBuV)	Factor (dB)	Actual FS (dBuV/m)	Limit3m (dBuV/m)	Safe Mar- gin (dB)
23.32	V	Peak	35.72	0.54	36.26	69.50	-33.24
58.13	V	Peak	57.84	-26.67	31.17	40.00	-8.83
106.63	V	Peak	64.82	-29.71	35.11	43.50	-8.39
126.03	V	Peak	57.83	-28.38	29.45	43.50	-14.05
184.23	V	Peak	60.96	-30.00	30.96	43.50	-12.54
552.83	V	Peak	56.83	-23.68	33.15	46.00	-12.85
625.58	V	Peak	53.89	-22.33	31.56	46.00	-14.44
24.04	H	Peak	28.81	0.54	29.35	69.50	-40.15
106.63	H	Peak	55.48	-29.71	25.77	43.50	-17.73
126.03	H	Peak	53.71	-28.38	25.33	43.50	-18.17
184.23	H	Peak	60.90	-30.00	30.90	43.50	-12.60
276.38	H	Peak	52.78	-29.18	23.60	46.00	-22.40
674.08	H	Peak	49.78	-21.52	28.26	46.00	-17.74
812.79	H	Peak	49.22	-20.01	29.21	46.00	-16.79

Remark :

- (1) Measuring frequencies from 30 MHz to the 1GHz .
- (2) Radiated emissions measured in frequency range from 30 MHz to 1000MHz were made with an instrument using Peak/QP detector mode.
- (3) Data of measurement within this frequency range shown “ - ” in the table above means the reading of emissions are attenuated more than 20dB below the permissible limits or the field strength is too small to be measured.
- (4) The IF bandwidth of SPA between 30MHz to 1GHz was 100KHz.

Unless otherwise stated the results shown in this test report refer only to the sample(s) tested. This test report cannot be reproduced, except in full, without prior written permission of the Company. 除非另有說明，此報告結果僅對測試之樣品負責。本報告未經本公司書面許可，不可部份複製。
 This Test Report is issued by the Company under its General Conditions of Service which is available on request or accessible at http://www.sgs.com/terms_and_conditions.htm. Attention is drawn to the limitation of liability, indemnification and jurisdiction issues defined therein. Any holder of this Test Report is advised that information contained hereon reflects the Company's findings at the time of its intervention only and within the limits of Client's instructions, if any. The Company's sole responsibility is to its Client and this document does not exonerate parties to a transaction from exercising all their rights and obligations under the transaction documents. Any unauthorized alteration, forgery or falsification of the content or appearance of this document is unlawful and offenders may be prosecuted to the fullest extent of the law. .

Radiated Spurious Emission Measurement Result (above 1GHz) (802.11b)

Operation Mode	802.11b TX CH Low	Test Date	Jun. 30, 2009
Fundamental Frequency	2412MHz	Test By	Brian
Temperature	23 °C	Pol	Ver.
Humidity	54 %		

Freq. (MHz)	Peak	AV	Ant./CL CF(dB)	Actual FS		Peak	AV	Margin (dB)	
	Reading (dBuV)	Reading (dBuV)		Peak (dBuV/m)	AV (dBuV/m)	Limit (dBuV/m)	Limit (dBuV/m)		
3203.5	53.01	---	-10.39	42.62	---	74.00	54.00	-11.38	Peak
4824.0	49.17	---	-5.98	43.19	---	74.00	54.00	-10.81	Peak
7236.0	---					74.00	54.00		
9648.0	---					74.00	54.00		
12060.0	---					74.00	54.00		
14472.0	---					74.00	54.00		
16884.0	---					74.00	54.00		
19296.0	---					74.00	54.00		
21708.0	---					74.00	54.00		
24120.0	---					74.00	54.00		

Remark:

- (1) Measuring frequencies scanned from 1GHz to the 10th harmonic of highest fundamental frequency.
- (2) Data of measurement within this frequency range shown “ - ” in the table above means the reading of emissions are attenuated more than 20dB below the permissible limits or the field strength is too small to be measured.
- (3) Radiated emissions measured in frequency above 1000MHz were made with an instrument using Peak detector mode and average detector mode of the emission shown in Actual FS column.
- (4) Spectrum Peak Setting : 1GHz- 26GHz, RBW= 1MHz, VBW= 3MHz, Sweep time= 200 ms.
- (5) Spectrum AV Setting : 1GHz- 26GHz, RBW= 1MHz, VBW= 10Hz, Sweep time= 200 ms.

Unless otherwise stated the results shown in this test report refer only to the sample(s) tested. This test report cannot be reproduced, except in full, without prior written permission of the Company. 除非另有說明，此報告結果僅對測試之樣品負責。本報告未經本公司書面許可，不可部份複製。
 This Test Report is issued by the Company under its General Conditions of Service which is available on request or accessible at http://www.sgs.com/terms_and_conditions.htm. Attention is drawn to the limitation of liability, indemnification and jurisdiction issues defined therein. Any holder of this Test Report is advised that information contained hereon reflects the Company's findings at the time of its intervention only and within the limits of Client's instructions, if any. The Company's sole responsibility is to its Client and this document does not exonerate parties to a transaction from exercising all their rights and obligations under the transaction documents. Any unauthorized alteration, forgery or falsification of the content or appearance of this document is unlawful and offenders may be prosecuted to the fullest extent of the law.

Radiated Spurious Emission Measurement Result (above 1GHz) (802.11b)

Operation Mode	802.11b TX CH Low	Test Date	Jun. 30, 2009
Fundamental Frequency	2412MHz	Test By	Brian
Temperature	23 °C	Pol	Hor
Humidity	54 %		

Freq. (MHz)	Peak	AV	Ant./CL CF(dB)	Actual FS		Peak	AV	Margin (dB)	
	Reading (dBuV)	Reading (dBuV)		Peak (dBuV/m)	AV (dBuV/m)	Limit (dBuV/m)	Limit (dBuV/m)		
3203.5	48.37	---	-10.39	37.98	---	74.00	54.00	-16.02	Peak
4824.0	44.57	---	-5.98	38.59	---	74.00	54.00	-15.41	Peak
7236.0	----					74.00	54.00		
9648.0	----					74.00	54.00		
12060.0	----					74.00	54.00		
14472.0	----					74.00	54.00		
16884.0	----					74.00	54.00		
19296.0	----					74.00	54.00		
21708.0	----					74.00	54.00		
24120.0	----					74.00	54.00		

Remark:

- (1) Measuring frequencies scanned from 1GHz to the 10th harmonic of highest fundamental frequency
- (2) Data of measurement within this frequency range shown “ - ” in the table above means the reading of emissions are attenuated more than 20dB below the permissible limits or the field strength is too small to be measured.
- (3) Radiated emissions measured in frequency above 1000MHz were made with an instrument using Peak detector mode and average detector mode of the emission shown in Actual FS column
- (4) Spectrum Peak Setting : 1GHz- 26GHz, RBW= 1MHz, VBW= 3MHz, Sweep time= 200 ms.
- (5) Spectrum AV Setting : 1GHz- 26GHz, RBW= 1MHz, VBW= 10Hz, Sweep time= 200 ms.

Unless otherwise stated the results shown in this test report refer only to the sample(s) tested. This test report cannot be reproduced, except in full, without prior written permission of the Company. 除非另有說明，此報告結果僅對測試之樣品負責。本報告未經本公司書面許可，不可部份複製。
 This Test Report is issued by the Company under its General Conditions of Service which is available on request or accessible at http://www.sgs.com/terms_and_conditions.htm. Attention is drawn to the limitation of liability, indemnification and jurisdiction issues defined therein. Any holder of this Test Report is advised that information contained hereon reflects the Company's findings at the time of its intervention only and within the limits of Client's instructions, if any. The Company's sole responsibility is to its Client and this document does not exonerate parties to a transaction from exercising all their rights and obligations under the transaction documents. Any unauthorized alteration, forgery or falsification of the content or appearance of this document is unlawful and offenders may be prosecuted to the fullest extent of the law.

Radiated Spurious Emission Measurement Result (above 1GHz) (802.11b)

Operation Mode	802.11b TX CH Mid	Test Date	Jun. 30, 2009
Fundamental Frequency	2437MHz	Test By	Brian
Temperature	23 °C	Pol	Ver
Humidity	54 %		

Freq. (MHz)	Peak	AV	Ant./CL CF(dB)	Actual FS		Peak	AV	Margin (dB)	
	Reading (dBuV)	Reading (dBuV)		Peak (dBuV/m)	AV (dBuV/m)	Limit (dBuV/m)	Limit (dBuV/m)		
3236.0	52.15	---	-10.40	41.75	---	74.00	54.00	-12.25	Peak
4874.0	53.31	---	-5.97	47.34	---	74.00	54.00	-6.66	Peak
7311.0	---					74.00	54.00		
9748.0	---					74.00	54.00		
12185.0	---					74.00	54.00		
14622.0	---					74.00	54.00		
17059.0	---					74.00	54.00		
19496.0	---					74.00	54.00		
21933.0	---					74.00	54.00		
24370.0	---					74.00	54.00		

Remark:

- (1) Measuring frequencies scanned from 1GHz to the 10th harmonic of highest fundamental frequency
- (2) Data of measurement within this frequency range shown “ - ” in the table above means the reading of emissions are attenuated more than 20dB below the permissible limits or the field strength is too small to be measured.
- (3) Radiated emissions measured in frequency above 1000MHz were made with an instrument using Peak detector mode and average detector mode of the emission shown in Actual FS column
- (4) Spectrum Peak Setting : 1GHz- 26GHz, RBW= 1MHz, VBW= 3MHz, Sweep time= 200 ms.
- (5) Spectrum AV Setting : 1GHz- 26GHz, RBW= 1MHz, VBW= 10Hz, Sweep time= 200 ms.

Unless otherwise stated the results shown in this test report refer only to the sample(s) tested. This test report cannot be reproduced, except in full, without prior written permission of the Company. 除非另有說明，此報告結果僅對測試之樣品負責。本報告未經本公司書面許可，不可部份複製。
 This Test Report is issued by the Company under its General Conditions of Service which is available on request or accessible at http://www.sgs.com/terms_and_conditions.htm. Attention is drawn to the limitation of liability, indemnification and jurisdiction issues defined therein. Any holder of this Test Report is advised that information contained hereon reflects the Company's findings at the time of its intervention only and within the limits of Client's instructions, if any. The Company's sole responsibility is to its Client and this document does not exonerate parties to a transaction from exercising all their rights and obligations under the transaction documents. Any unauthorized alteration, forgery or falsification of the content or appearance of this document is unlawful and offenders may be prosecuted to the fullest extent of the law.

Radiated Spurious Emission Measurement Result (above 1GHz) (802.11b)

Operation Mode	802.11b TX CH Mid	Test Date	Jun. 30, 2009
Fundamental Frequency	2437MHz	Test By	Brian
Temperature	23 °C	Pol	Hor
Humidity	54 %		

Freq. (MHz)	Peak	AV	Ant./CL CF(dB)	Actual FS		Peak	AV	Margin (dB)	
	Reading (dBuV)	Reading (dBuV)		Peak (dBuV/m)	AV (dBuV/m)	Limit (dBuV/m)	Limit (dBuV/m)		
3236.0	48.99	---	-10.40	38.59	---	74.00	54.00	-15.41	Peak
4874.0	52.99	---	-5.97	47.02	---	74.00	54.00	-6.98	Peak
7311.0	---					74.00	54.00		
9748.0	---					74.00	54.00		
12185.0	---					74.00	54.00		
14622.0	---					74.00	54.00		
17059.0	---					74.00	54.00		
19496.0	---					74.00	54.00		
21933.0	---					74.00	54.00		
24370.0	---					74.00	54.00		

Remark:

- (1) Measuring frequencies scanned from 1GHz to the 10th harmonic of highest fundamental frequency
- (2) Data of measurement within this frequency range shown “ - ” in the table above means the reading of emissions are attenuated more than 20dB below the permissible limits or the field strength is too small to be measured.
- (3) Radiated emissions measured in frequency above 1000MHz were made with an instrument using Peak detector mode and average detector mode of the emission shown in Actual FS column
- (4) Spectrum Peak Setting : 1GHz- 26GHz, RBW= 1MHz, VBW= 3MHz, Sweep time= 200 ms.
- (5) Spectrum AV Setting : 1GHz- 26GHz, RBW= 1MHz, VBW= 10Hz, Sweep time= 200 ms.

Unless otherwise stated the results shown in this test report refer only to the sample(s) tested. This test report cannot be reproduced, except in full, without prior written permission of the Company. 除非另有說明，此報告結果僅對測試之樣品負責。本報告未經本公司書面許可，不可部份複製。
 This Test Report is issued by the Company under its General Conditions of Service which is available on request or accessible at http://www.sgs.com/terms_and_conditions.htm. Attention is drawn to the limitation of liability, indemnification and jurisdiction issues defined therein. Any holder of this Test Report is advised that information contained hereon reflects the Company's findings at the time of its intervention only and within the limits of Client's instructions, if any. The Company's sole responsibility is to its Client and this document does not exonerate parties to a transaction from exercising all their rights and obligations under the transaction documents. Any unauthorized alteration, forgery or falsification of the content or appearance of this document is unlawful and offenders may be prosecuted to the fullest extent of the law.

Radiated Spurious Emission Measurement Result (above 1GHz) (802.11b)

Operation Mode	802.11b TX CH High	Test Date	Jun. 30, 2009
Fundamental Frequency	2462MHz	Test By	Brian
Temperature	23 °C	Pol	Ver
Humidity	54 %		

Freq. (MHz)	Peak	AV	Ant./CL CF(dB)	Actual FS		Peak	AV	Margin (dB)	
	Reading (dBuV)	Reading (dBuV)		Peak (dBuV/m)	AV (dBuV/m)	Limit (dBuV/m)	Limit (dBuV/m)		
3288.0	49.75	---	-10.37	39.38	---	74.00	54.00	-14.62	Peak
4924.0	45.65	---	-5.91	39.74	---	74.00	54.00	-14.26	Peak
7386.0	---					74.00	54.00		
9848.0	---					74.00	54.00		
12310.0	---					74.00	54.00		
14772.0	---					74.00	54.00		
17234.0	---					74.00	54.00		
19696.0	---					74.00	54.00		
22158.0	---					74.00	54.00		
24620.0	---					74.00	54.00		

Remark:

- (1) Measuring frequencies scanned from 1GHz to the 10th harmonic of highest fundamental frequency
- (2) Data of measurement within this frequency range shown “ - ” in the table above means the reading of emissions are attenuated more than 20dB below the permissible limits or the field strength is too small to be measured.
- (3) Radiated emissions measured in frequency above 1000MHz were made with an instrument using Peak detector mode and average detector mode of the emission shown in Actual FS column
- (4) Spectrum Peak Setting : 1GHz- 26GHz, RBW= 1MHz, VBW= 3MHz, Sweep time= 200 ms.
- (5) Spectrum AV Setting : 1GHz- 26GHz, RBW= 1MHz, VBW= 10Hz, Sweep time= 200 ms.

Unless otherwise stated the results shown in this test report refer only to the sample(s) tested. This test report cannot be reproduced, except in full, without prior written permission of the Company. 除非另有說明，此報告結果僅對測試之樣品負責。本報告未經本公司書面許可，不可部份複製。
 This Test Report is issued by the Company under its General Conditions of Service which is available on request or accessible at http://www.sgs.com/terms_and_conditions.htm. Attention is drawn to the limitation of liability, indemnification and jurisdiction issues defined therein. Any holder of this Test Report is advised that information contained hereon reflects the Company's findings at the time of its intervention only and within the limits of Client's instructions, if any. The Company's sole responsibility is to its Client and this document does not exonerate parties to a transaction from exercising all their rights and obligations under the transaction documents. Any unauthorized alteration, forgery or falsification of the content or appearance of this document is unlawful and offenders may be prosecuted to the fullest extent of the law.

Radiated Spurious Emission Measurement Result (above 1GHz) (802.11b)

Operation Mode	802.11b TX CH High	Test Date	Jun. 30, 2009
Fundamental Frequency	2462MHz	Test By	Brian
Temperature	23 °C	Pol	Hor
Humidity	54 %		

Freq. (MHz)	Peak	AV	Ant./CL CF(dB)	Actual FS		Peak	AV	Margin (dB)	
	Reading (dBuV)	Reading (dBuV)		Peak (dBuV/m)	AV (dBuV/m)	Limit (dBuV/m)	Limit (dBuV/m)		
3288.0	47.57	---	-10.37	37.20	---	74.00	54.00	-16.80	Peak
4924.0	43.06	---	-5.91	37.15	---	74.00	54.00	-16.85	Peak
7386.0	---					74.00	54.00		
9848.0	---					74.00	54.00		
12310.0	---					74.00	54.00		
14772.0	---					74.00	54.00		
17234.0	---					74.00	54.00		
19696.0	---					74.00	54.00		
22158.0	---					74.00	54.00		
24620.0	---					74.00	54.00		

Remark:

- (1) Measuring frequencies scanned from 1GHz to the 10th harmonic of highest fundamental frequency
- (2) Data of measurement within this frequency range shown “ - ” in the table above means the reading of emissions are attenuated more than 20dB below the permissible limits or the field strength is too small to be measured.
- (3) Radiated emissions measured in frequency above 1000MHz were made with an instrument using Peak detector mode and average detector mode of the emission shown in Actual FS column
- (4) Spectrum Peak Setting : 1GHz- 26GHz, RBW= 1MHz, VBW= 3MHz, Sweep time= 200 ms.
- (5) Spectrum AV Setting : 1GHz- 26GHz, RBW= 1MHz, VBW= 10Hz, Sweep time= 200 ms.

Unless otherwise stated the results shown in this test report refer only to the sample(s) tested. This test report cannot be reproduced, except in full, without prior written permission of the Company. 除非另有說明，此報告結果僅對測試之樣品負責。本報告未經本公司書面許可，不可部份複製。
 This Test Report is issued by the Company under its General Conditions of Service which is available on request or accessible at http://www.sgs.com/terms_and_conditions.htm. Attention is drawn to the limitation of liability, indemnification and jurisdiction issues defined therein. Any holder of this Test Report is advised that information contained hereon reflects the Company's findings at the time of its intervention only and within the limits of Client's instructions, if any. The Company's sole responsibility is to its Client and this document does not exonerate parties to a transaction from exercising all their rights and obligations under the transaction documents. Any unauthorized alteration, forgery or falsification of the content or appearance of this document is unlawful and offenders may be prosecuted to the fullest extent of the law.

Radiated Spurious Emission Measurement Result (above 1GHz) (802.11g)

Operation Mode	802.11g TX CH Low	Test Date	Jun. 30, 2009
Fundamental Frequency	2412MHz	Test By	Brian
Temperature	25 °C	Pol	Ver.
Humidity	60 %		

Freq. (MHz)	Peak	AV	Ant./CL CF(dB)	Actual FS		Peak	AV	Margin (dB)	
	Reading (dBuV)	Reading (dBuV)		Peak (dBuV/m)	AV (dBuV/m)	Limit (dBuV/m)	Limit (dBuV/m)		
3203.5	52.18	---	-10.39	41.79	---	74.00	54.00	-12.21	Peak
4824.0	42.16	---	-5.98	36.18	---	74.00	54.00	-17.82	Peak
7236.0	---					74.00	54.00		
9648.0	---					74.00	54.00		
12060.0	---					74.00	54.00		
14472.0	---					74.00	54.00		
16884.0	---					74.00	54.00		
19296.0	---					74.00	54.00		
21708.0	---					74.00	54.00		
24120.0	---					74.00	54.00		

Remark:

- (1) Measuring frequencies scanned from 1GHz to the 10th harmonic of highest fundamental frequency
- (2) Data of measurement within this frequency range shown “ - ” in the table above means the reading of emissions are attenuated more than 20dB below the permissible limits or the field strength is too small to be measured.
- (3) Radiated emissions measured in frequency above 1000MHz were made with an instrument using Peak detector mode and average detector mode of the emission shown in Actual FS column
- (4) Spectrum Peak Setting : 1GHz- 26GHz, RBW= 1MHz, VBW= 3MHz, Sweep time= 200 ms.
- (5) Spectrum AV Setting : 1GHz- 26GHz, RBW= 1MHz, VBW= 10Hz, Sweep time= 200 ms.

Unless otherwise stated the results shown in this test report refer only to the sample(s) tested. This test report cannot be reproduced, except in full, without prior written permission of the Company. 除非另有說明，此報告結果僅對測試之樣品負責。本報告未經本公司書面許可，不可部份複製。
 This Test Report is issued by the Company under its General Conditions of Service which is available on request or accessible at http://www.sgs.com/terms_and_conditions.htm. Attention is drawn to the limitation of liability, indemnification and jurisdiction issues defined therein. Any holder of this Test Report is advised that information contained hereon reflects the Company's findings at the time of its intervention only and within the limits of Client's instructions, if any. The Company's sole responsibility is to its Client and this document does not exonerate parties to a transaction from exercising all their rights and obligations under the transaction documents. Any unauthorized alteration, forgery or falsification of the content or appearance of this document is unlawful and offenders may be prosecuted to the fullest extent of the law.

Radiated Spurious Emission Measurement Result (above 1GHz) (802.11g)

Operation Mode	802.11g TX CH Low	Test Date	Jun. 30, 2009
Fundamental Frequency	2412MHz	Test By	Brian
Temperature	23 °C	Pol	Hor
Humidity	54 %		

Freq. (MHz)	Peak	AV	Ant./CL CF(dB)	Actual FS		Peak	AV	Margin (dB)	
	Reading (dBuV)	Reading (dBuV)		Peak (dBuV/m)	AV (dBuV/m)	Limit (dBuV/m)	Limit (dBuV/m)		
3203.5	48.65	---	-10.39	38.26	---	74.00	54.00	-15.74	Peak
4824.0	42.91	---	-5.98	36.93	---	74.00	54.00	-17.07	Peak
7236.0	---					74.00	54.00		
9648.0	---					74.00	54.00		
12060.0	---					74.00	54.00		
14472.0	---					74.00	54.00		
16884.0	---					74.00	54.00		
19296.0	---					74.00	54.00		
21708.0	---					74.00	54.00		
24120.0	---					74.00	54.00		

Remark:

- (1) Measuring frequencies scanned from 1GHz to the 10th harmonic of highest fundamental frequency.
- (2) Data of measurement within this frequency range shown “ - ” in the table above means the reading of emissions are attenuated more than 20dB below the permissible limits or the field strength is too small to be measured.
- (3) Radiated emissions measured in frequency above 1000MHz were made with an instrument using Peak detector mode and average detector mode of the emission shown in Actual FS column.
- (4) Spectrum Peak Setting : 1GHz- 26GHz, RBW= 1MHz, VBW= 3MHz, Sweep time= 200 ms.
- (5) Spectrum AV Setting : 1GHz- 26GHz, RBW= 1MHz, VBW= 10Hz, Sweep time= 200 ms.

Unless otherwise stated the results shown in this test report refer only to the sample(s) tested. This test report cannot be reproduced, except in full, without prior written permission of the Company. 除非另有說明，此報告結果僅對測試之樣品負責。本報告未經本公司書面許可，不可部份複製。
 This Test Report is issued by the Company under its General Conditions of Service which is available on request or accessible at http://www.sgs.com/terms_and_conditions.htm. Attention is drawn to the limitation of liability, indemnification and jurisdiction issues defined therein. Any holder of this Test Report is advised that information contained hereon reflects the Company's findings at the time of its intervention only and within the limits of Client's instructions, if any. The Company's sole responsibility is to its Client and this document does not exonerate parties to a transaction from exercising all their rights and obligations under the transaction documents. Any unauthorized alteration, forgery or falsification of the content or appearance of this document is unlawful and offenders may be prosecuted to the fullest extent of the law.

Radiated Spurious Emission Measurement Result (above 1GHz) (802.11g)

Operation Mode	802.11g TX CH Mid	Test Date	Jun. 30, 2009
Fundamental Frequency	2437MHz	Test By	Brian
Temperature	23 °C	Pol	Ver
Humidity	54 %		

Freq. (MHz)	Peak	AV	Ant./CL CF(dB)	Actual FS		Peak	AV	Margin (dB)	
	Reading (dBuV)	Reading (dBuV)		Peak (dBuV/m)	AV (dBuV/m)	Limit (dBuV/m)	Limit (dBuV/m)		
3236.0	51.72	---	-10.40	41.32	---	74.00	54.00	-12.68	Peak
4874.0	42.52	---	-5.97	36.55	---	74.00	54.00	-17.45	Peak
7311.0	---					74.00	54.00		
9748.0	---					74.00	54.00		
12185.0	---					74.00	54.00		
14622.0	---					74.00	54.00		
17059.0	---					74.00	54.00		
19496.0	---					74.00	54.00		
21933.0	---					74.00	54.00		
24370.0	---					74.00	54.00		

Remark:

- (1) Measuring frequencies scanned from 1GHz to the 10th harmonic of highest fundamental frequency.
- (2) Data of measurement within this frequency range shown “ - ” in the table above means the reading of emissions are attenuated more than 20dB below the permissible limits or the field strength is too small to be measured.
- (3) Radiated emissions measured in frequency above 1000MHz were made with an instrument using Peak detector mode and average detector mode of the emission shown in Actual FS column.
- (4) Spectrum Peak Setting : 1GHz- 26GHz, RBW= 1MHz, VBW= 3MHz, Sweep time= 200 ms.
- (5) Spectrum AV Setting : 1GHz- 26GHz, RBW= 1MHz, VBW= 10Hz, Sweep time= 200 ms.

Unless otherwise stated the results shown in this test report refer only to the sample(s) tested. This test report cannot be reproduced, except in full, without prior written permission of the Company. 除非另有說明，此報告結果僅對測試之樣品負責。本報告未經本公司書面許可，不可部份複製。
 This Test Report is issued by the Company under its General Conditions of Service which is available on request or accessible at http://www.sgs.com/terms_and_conditions.htm. Attention is drawn to the limitation of liability, indemnification and jurisdiction issues defined therein. Any holder of this Test Report is advised that information contained hereon reflects the Company's findings at the time of its intervention only and within the limits of Client's instructions, if any. The Company's sole responsibility is to its Client and this document does not exonerate parties to a transaction from exercising all their rights and obligations under the transaction documents. Any unauthorized alteration, forgery or falsification of the content or appearance of this document is unlawful and offenders may be prosecuted to the fullest extent of the law.

Radiated Spurious Emission Measurement Result (above 1GHz) (802.11g)

Operation Mode	802.11g TX CH Mid	Test Date	Jun. 30, 2009
Fundamental Frequency	2437MHz	Test By	Brian
Temperature	23 °C	Pol	Hor
Humidity	54 %		

Freq. (MHz)	Peak	AV	Ant./CL CF(dB)	Actual FS		Peak	AV	Margin (dB)	
	Reading (dBuV)	Reading (dBuV)		Peak (dBuV/m)	AV (dBuV/m)	Limit (dBuV/m)	Limit (dBuV/m)		
3236.0	47.93	---	-10.40	37.53	---	74.00	54.00	-16.47	Peak
4874.0	41.92	---	-5.97	35.95	---	74.00	54.00	-18.05	Peak
7311.0	----					74.00	54.00		
9748.0	----					74.00	54.00		
12185.0	----					74.00	54.00		
14622.0	----					74.00	54.00		
17059.0	----					74.00	54.00		
19496.0	----					74.00	54.00		
21933.0	----					74.00	54.00		
24370.0	----					74.00	54.00		

Remark:

- (1) Measuring frequencies scanned from 1GHz to the 10th harmonic of highest fundamental frequency.
- (2) Data of measurement within this frequency range shown “ - ” in the table above means the reading of emissions are attenuated more than 20dB below the permissible limits or the field strength is too small to be measured.
- (3) Radiated emissions measured in frequency above 1000MHz were made with an instrument using Peak detector mode and average detector mode of the emission shown in Actual FS column.
- (4) Spectrum Peak Setting : 1GHz- 26GHz, RBW= 1MHz, VBW= 3MHz, Sweep time= 200 ms.
- (5) Spectrum AV Setting : 1GHz- 26GHz, RBW= 1MHz, VBW= 10Hz, Sweep time= 200 ms.

Unless otherwise stated the results shown in this test report refer only to the sample(s) tested. This test report cannot be reproduced, except in full, without prior written permission of the Company. 除非另有說明，此報告結果僅對測試之樣品負責。本報告未經本公司書面許可，不可部份複製。
 This Test Report is issued by the Company under its General Conditions of Service which is available on request or accessible at http://www.sgs.com/terms_and_conditions.htm. Attention is drawn to the limitation of liability, indemnification and jurisdiction issues defined therein. Any holder of this Test Report is advised that information contained hereon reflects the Company's findings at the time of its intervention only and within the limits of Client's instructions, if any. The Company's sole responsibility is to its Client and this document does not exonerate parties to a transaction from exercising all their rights and obligations under the transaction documents. Any unauthorized alteration, forgery or falsification of the content or appearance of this document is unlawful and offenders may be prosecuted to the fullest extent of the law.

Radiated Spurious Emission Measurement Result (above 1GHz) (802.11g)

Operation Mode	802.11g TX CH High	Test Date	Jun. 30, 2009
Fundamental Frequency	2462MHz	Test By	Brian
Temperature	23 °C	Pol	Ver
Humidity	54 %		

Freq. (MHz)	Peak	AV	Ant./CL CF(dB)	Actual FS		Peak	AV	Margin (dB)	
	Reading (dBuV)	Reading (dBuV)		Peak (dBuV/m)	AV (dBuV/m)	Limit (dBuV/m)	Limit (dBuV/m)		
3288.0	51.39	---	-10.37	41.02	---	74.00	54.00	-12.98	Peak
4924.0	42.66	---	-5.91	36.75	---	74.00	54.00	-17.25	Peak
7386.0	----					74.00	54.00		
9848.0	----					74.00	54.00		
12310.0	----					74.00	54.00		
14772.0	----					74.00	54.00		
17234.0	----					74.00	54.00		
19696.0	----					74.00	54.00		
22158.0	----					74.00	54.00		
24620.0	----					74.00	54.00		

Remark:

- (1) Measuring frequencies scanned from 1GHz to the 10th harmonic of highest fundamental frequency.
- (2) Data of measurement within this frequency range shown “ - ” in the table above means the reading of emissions are attenuated more than 20dB below the permissible limits or the field strength is too small to be measured.
- (3) Radiated emissions measured in frequency above 1000MHz were made with an instrument using Peak detector mode and average detector mode of the emission shown in Actual FS column.
- (4) Spectrum Peak Setting : 1GHz- 26GHz, RBW= 1MHz, VBW= 3MHz, Sweep time= 200 ms.
- (5) Spectrum AV Setting : 1GHz- 26GHz, RBW= 1MHz, VBW= 10Hz, Sweep time= 200 ms.

Unless otherwise stated the results shown in this test report refer only to the sample(s) tested. This test report cannot be reproduced, except in full, without prior written permission of the Company. 除非另有說明，此報告結果僅對測試之樣品負責。本報告未經本公司書面許可，不可部份複製。
 This Test Report is issued by the Company under its General Conditions of Service which is available on request or accessible at http://www.sgs.com/terms_and_conditions.htm. Attention is drawn to the limitation of liability, indemnification and jurisdiction issues defined therein. Any holder of this Test Report is advised that information contained hereon reflects the Company's findings at the time of its intervention only and within the limits of Client's instructions, if any. The Company's sole responsibility is to its Client and this document does not exonerate parties to a transaction from exercising all their rights and obligations under the transaction documents. Any unauthorized alteration, forgery or falsification of the content or appearance of this document is unlawful and offenders may be prosecuted to the fullest extent of the law.

Radiated Spurious Emission Measurement Result (above 1GHz) (802.11g)

Operation Mode	802.11g TX CH High	Test Date	Jun. 30, 2009
Fundamental Frequency	2462MHz	Test By	Brian
Temperature	23 °C	Pol	Hor
Humidity	54 %		

Freq. (MHz)	Peak	AV	Ant./CL CF(dB)	Actual FS		Peak	AV	Margin (dB)	
	Reading (dBuV)	Reading (dBuV)		Peak (dBuV/m)	AV (dBuV/m)	Limit (dBuV/m)	Limit (dBuV/m)		
3288.0	46.46	---	-10.37	36.09	---	74.00	54.00	-17.91	Peak
4924.0	42.32	---	-5.91	36.41	---	74.00	54.00	-17.59	Peak
7386.0	----					74.00	54.00		
9848.0	----					74.00	54.00		
12310.0	----					74.00	54.00		
14772.0	----					74.00	54.00		
17234.0	----					74.00	54.00		
19696.0	----					74.00	54.00		
22158.0	----					74.00	54.00		
24620.0	----					74.00	54.00		

Remark:

- (1) Measuring frequencies scanned from 1GHz to the 10th harmonic of highest fundamental frequency.
- (2) Data of measurement within this frequency range shown “ - ” in the table above means the reading of emissions are attenuated more than 20dB below the permissible limits or the field strength is too small to be measured.
- (3) Radiated emissions measured in frequency above 1000MHz were made with an instrument using Peak detector mode and average detector mode of the emission shown in Actual FS column.
- (4) Spectrum Peak Setting : 1GHz- 26GHz, RBW= 1MHz, VBW= 3MHz, Sweep time= 200 ms.
- (5) Spectrum AV Setting : 1GHz- 26GHz, RBW= 1MHz, VBW= 10Hz, Sweep time= 200 ms.

Unless otherwise stated the results shown in this test report refer only to the sample(s) tested. This test report cannot be reproduced, except in full, without prior written permission of the Company. 除非另有說明，此報告結果僅對測試之樣品負責。本報告未經本公司書面許可，不可部份複製。
 This Test Report is issued by the Company under its General Conditions of Service which is available on request or accessible at http://www.sgs.com/terms_and_conditions.htm. Attention is drawn to the limitation of liability, indemnification and jurisdiction issues defined therein. Any holder of this Test Report is advised that information contained hereon reflects the Company's findings at the time of its intervention only and within the limits of Client's instructions, if any. The Company's sole responsibility is to its Client and this document does not exonerate parties to a transaction from exercising all their rights and obligations under the transaction documents. Any unauthorized alteration, forgery or falsification of the content or appearance of this document is unlawful and offenders may be prosecuted to the fullest extent of the law.

10. Peak Power Spectral Density

10.1. Standard Applicable

According to §15.247(e) For digitally modulated systems, the power spectral density conducted from the intentional radiator to the antenna shall not be greater than 8 dBm in any 3 kHz band during any time interval of continuous transmission. This power spectral density shall be determined in accordance with the provisions of paragraph (b) of this section. The same method of determining the conducted output power shall be used to determine the power spectral density.

10.2. Measurement Procedure

1. Place the EUT on the table and set it in transmitting mode.
2. Remove the antenna from the EUT and then connect a low loss RF cable from the antenna port to the spectrum analyzer.
3. Set the spectrum analyzer as RBW = 3KHz, VBW = 10KHz, Span = 1.5MHz, Sweep=100s
4. Record the max. reading.
5. Repeat above procedures until all frequency measured were complete.

10.3. Measurement Equipment Used:

Conducted Emission Test Site					
EQUIPMENT TYPE	MFR	MODEL NUMBER	SERIAL NUMBER	LAST CAL.	CAL DUE.
Spectrum Analyzer	Agilent	E4446A	MY43360126	04/19/2008	04/18/2010
Spectrum Analyzer	Agilent	E7405A	US41160416	07/04/2009	07/03/2010
Spectrum Analyzer	R&S	FSP 40	100034	02/22/2009	02/21/2010
Low Loss Cable	HUBER+SUHNER	SUCOFLEX 104PEA	N/A	01/05/2009	01/04/2010
Attenuator	Mini-Circuit	BW-S6W5	N/A	07/05/2009	07/04/2010

Unless otherwise stated the results shown in this test report refer only to the sample(s) tested. This test report cannot be reproduced, except in full, without prior written permission of the Company. 除非另有說明，此報告結果僅對測試之樣品負責。本報告未經本公司書面許可，不可部份複製。
 This Test Report is issued by the Company under its General Conditions of Service which is available on request or accessible at http://www.sgs.com/terms_and_conditions.htm. Attention is drawn to the limitation of liability, indemnification and jurisdiction issues defined therein. Any holder of this Test Report is advised that information contained hereon reflects the Company's findings at the time of its intervention only and within the limits of Client's instructions, if any. The Company's sole responsibility is to its Client and this document does not exonerate parties to a transaction from exercising all their rights and obligations under the transaction documents. Any unauthorized alteration, forgery or falsification of the content or appearance of this document is unlawful and offenders may be prosecuted to the fullest extent of the law.

10.4. Measurement Result

Patch 1 Internal Antenna

802.11b

CH	RF Power Density Reading (dBm)	Cable loss (dB)	RF Power Density Level (dBm)	Maximum Limit (dBm)
Low	-8.95	0.00	-8.95	6
Mid	-1.33	0.00	-1.33	6
High	-9.96	0.00	-9.96	6

802.11g

CH	RF Power Density Reading (dBm)	Cable loss (dB)	RF Power Density Level (dBm)	Maximum Limit (dBm)
Low	-13.20	0.00	-13.20	6
Mid	-5.99	0.00	-5.99	6
High	-18.13	0.00	-18.13	6

Note: offset 0.5 dB

Unless otherwise stated the results shown in this test report refer only to the sample(s) tested. This test report cannot be reproduced, except in full, without prior written permission of the Company. 除非另有說明，此報告結果僅對測試之樣品負責。本報告未經本公司書面許可，不可部份複製。

This Test Report is issued by the Company under its General Conditions of Service which is available on request or accessible at http://www.sgs.com/terms_and_conditions.htm. Attention is drawn to the limitation of liability, indemnification and jurisdiction issues defined therein. Any holder of this Test Report is advised that information contained hereon reflects the Company's findings at the time of its intervention only and within the limits of Client's instructions, if any. The Company's sole responsibility is to its Client and this document does not exonerate parties to a transaction from exercising all their rights and obligations under the transaction documents. Any unauthorized alteration, forgery or falsification of the content or appearance of this document is unlawful and offenders may be prosecuted to the fullest extent of the law.

802.11b (Patch 1 Internal Antenna)

Power Spectral Density Test Plot (CH-Low)

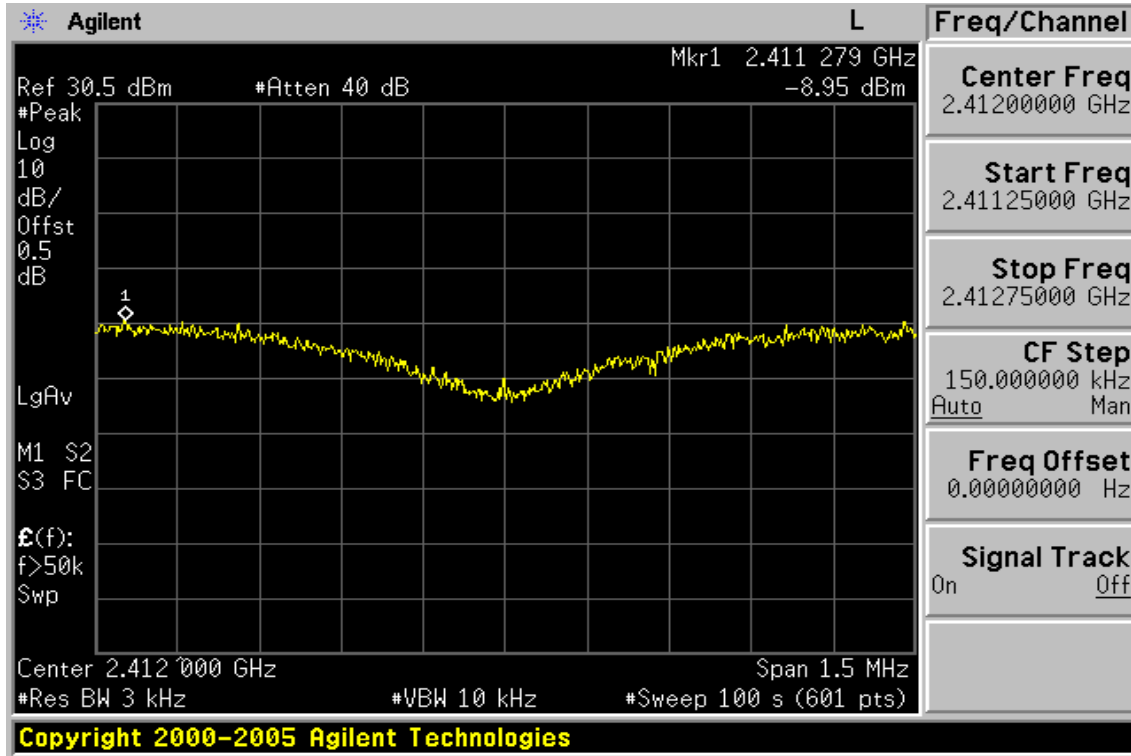

Power Spectral Density Test Plot (CH-Mid)

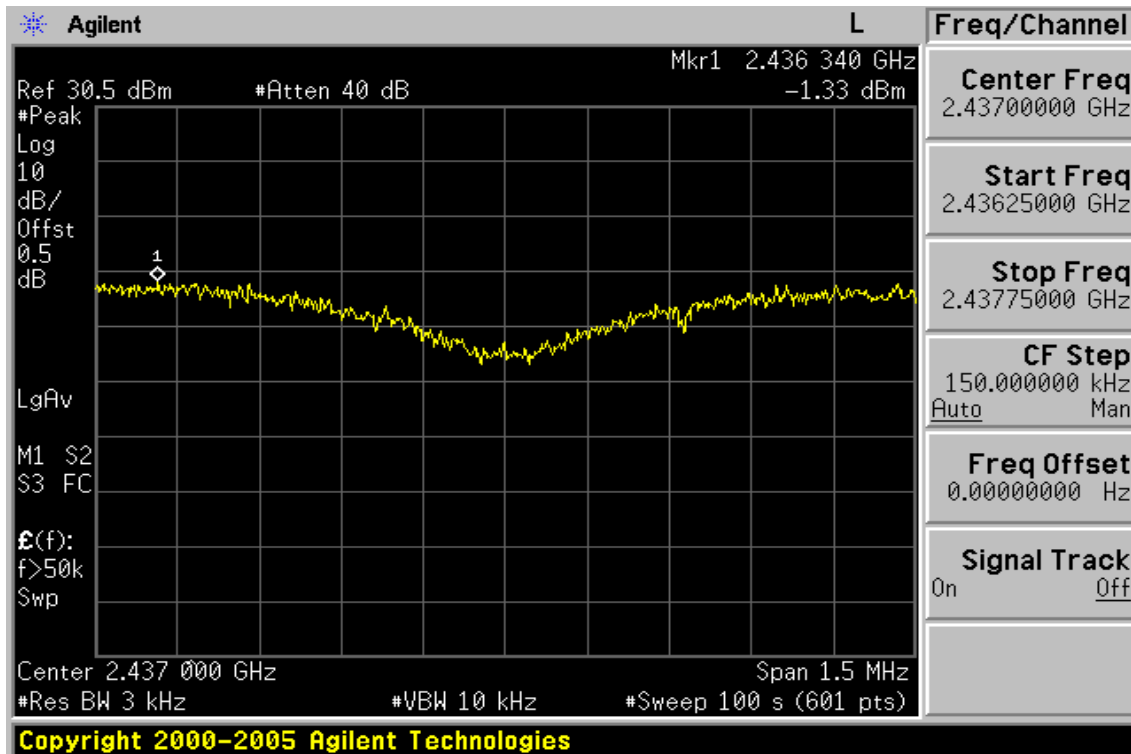

Unless otherwise stated the results shown in this test report refer only to the sample(s) tested. This test report cannot be reproduced, except in full, without prior written permission of the Company. 除非另有說明，此報告結果僅對測試之樣品負責。本報告未經本公司書面許可，不可部份複製。
 This Test Report is issued by the Company under its General Conditions of Service which is available on request or accessible at http://www.sgs.com/terms_and_conditions.htm. Attention is drawn to the limitation of liability, indemnification and jurisdiction issues defined therein. Any holder of this Test Report is advised that information contained hereon reflects the Company's findings at the time of its intervention only and within the limits of Client's instructions, if any. The Company's sole responsibility is to its Client and this document does not exonerate parties to a transaction from exercising all their rights and obligations under the transaction documents. Any unauthorized alteration, forgery or falsification of the content or appearance of this document is unlawful and offenders may be prosecuted to the fullest extent of the law.

Power Spectral Density Test Plot (CH-High)

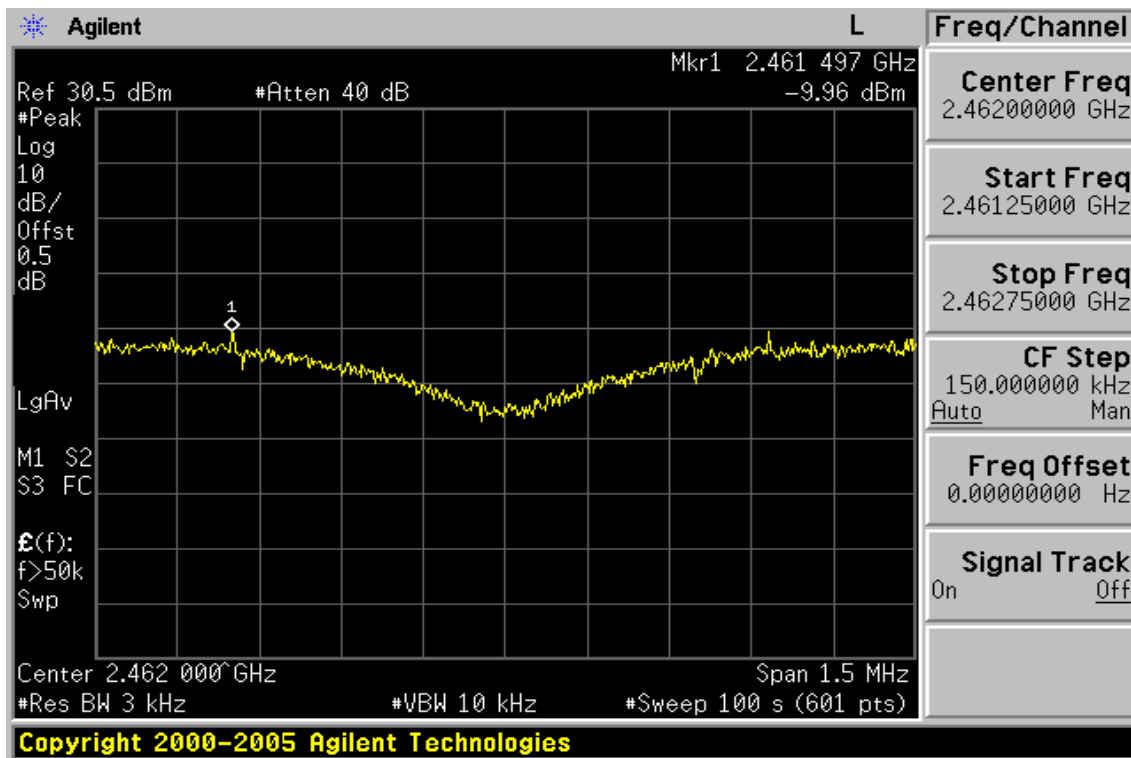

Unless otherwise stated the results shown in this test report refer only to the sample(s) tested. This test report cannot be reproduced, except in full, without prior written permission of the Company. 除非另有說明，此報告結果僅對測試之樣品負責。本報告未經本公司書面許可，不可部份複製。

This Test Report is issued by the Company under its General Conditions of Service which is available on request or accessible at http://www.sgs.com/terms_and_conditions.htm. Attention is drawn to the limitation of liability, indemnification and jurisdiction issues defined therein. Any holder of this Test Report is advised that information contained hereon reflects the Company's findings at the time of its intervention only and within the limits of Client's instructions, if any. The Company's sole responsibility is to its Client and this document does not exonerate parties to a transaction from exercising all their rights and obligations under the transaction documents. Any unauthorized alteration, forgery or falsification of the content or appearance of this document is unlawful and offenders may be prosecuted to the fullest extent of the law.

802.11g

Power Spectral Density Test Plot (CH-Low)

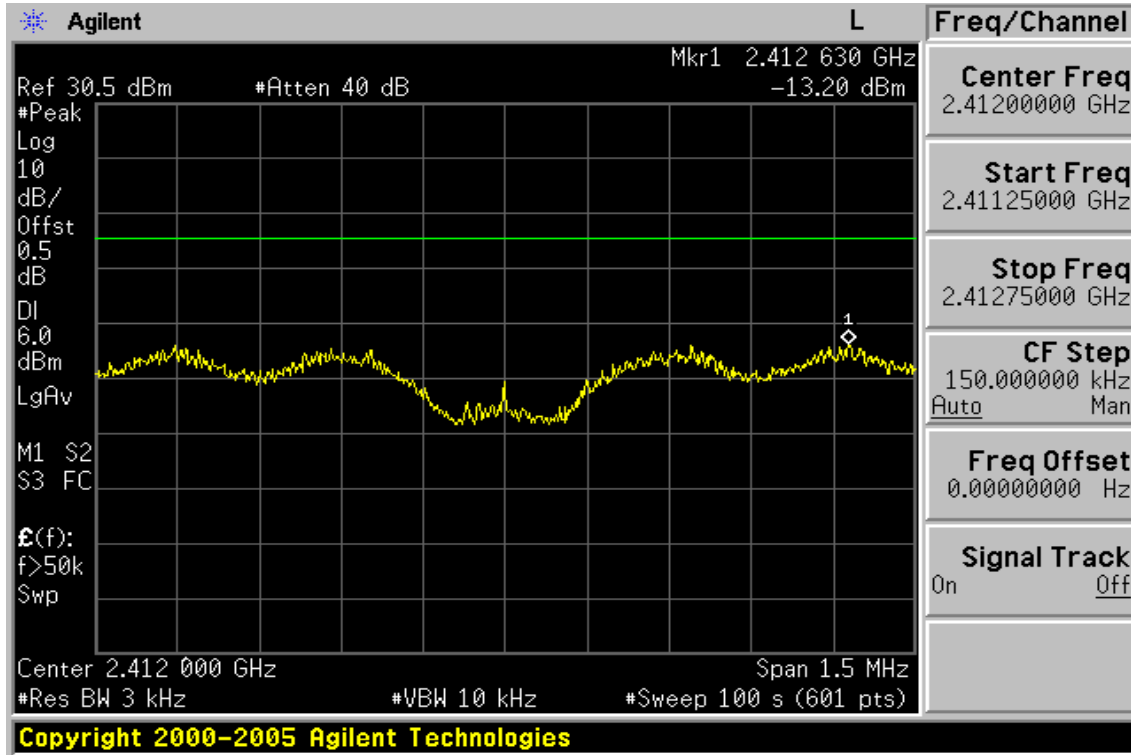

Power Spectral Density Test Plot (CH-Mid)

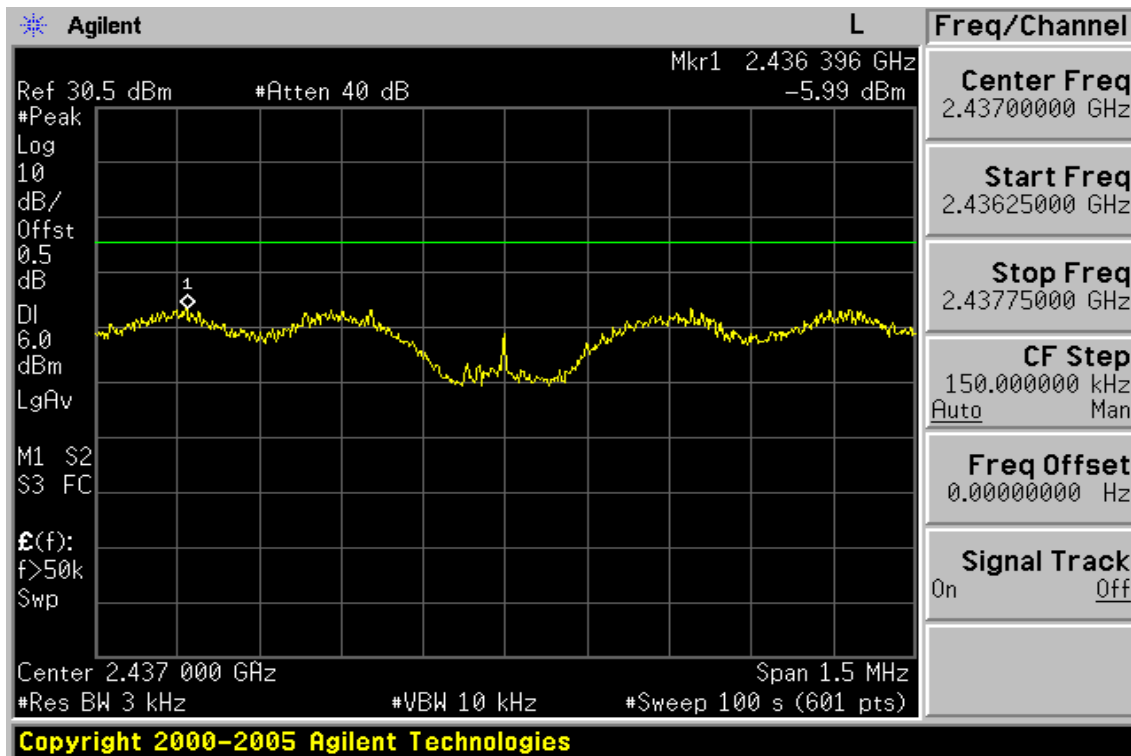

Unless otherwise stated the results shown in this test report refer only to the sample(s) tested. This test report cannot be reproduced, except in full, without prior written permission of the Company. 除非另有說明，此報告結果僅對測試之樣品負責。本報告未經本公司書面許可，不可部份複製。

This Test Report is issued by the Company under its General Conditions of Service which is available on request or accessible at http://www.sgs.com/terms_and_conditions.htm. Attention is drawn to the limitation of liability, indemnification and jurisdiction issues defined therein. Any holder of this Test Report is advised that information contained hereon reflects the Company's findings at the time of its intervention only and within the limits of Client's instructions, if any. The Company's sole responsibility is to its Client and this document does not exonerate parties to a transaction from exercising all their rights and obligations under the transaction documents. Any unauthorized alteration, forgery or falsification of the content or appearance of this document is unlawful and offenders may be prosecuted to the fullest extent of the law.

Power Spectral Density Test Plot (CH-High)

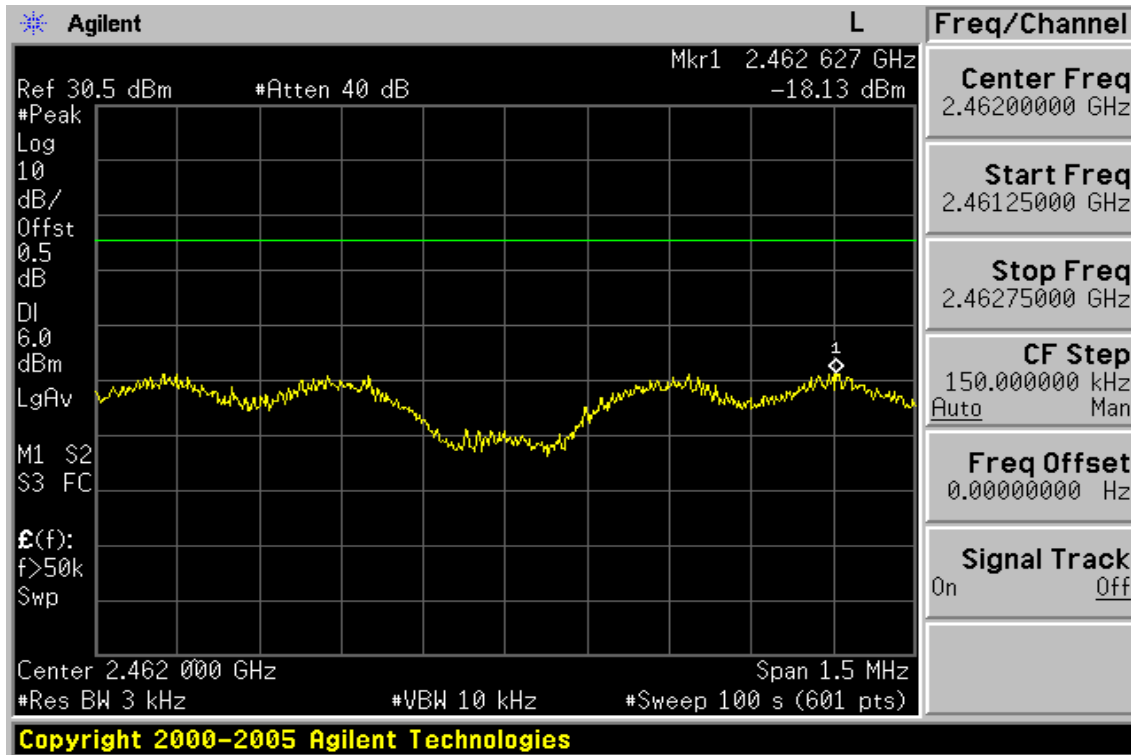

Unless otherwise stated the results shown in this test report refer only to the sample(s) tested. This test report cannot be reproduced, except in full, without prior written permission of the Company. 除非另有說明，此報告結果僅對測試之樣品負責。本報告未經本公司書面許可，不可部份複製。

This Test Report is issued by the Company under its General Conditions of Service which is available on request or accessible at http://www.sgs.com/terms_and_conditions.htm. Attention is drawn to the limitation of liability, indemnification and jurisdiction issues defined therein. Any holder of this Test Report is advised that information contained hereon reflects the Company's findings at the time of its intervention only and within the limits of Client's instructions, if any. The Company's sole responsibility is to its Client and this document does not exonerate parties to a transaction from exercising all their rights and obligations under the transaction documents. Any unauthorized alteration, forgery or falsification of the content or appearance of this document is unlawful and offenders may be prosecuted to the fullest extent of the law.

11. ANTENNA REQUIREMENT

11.1. Standard Applicable

According to §15.203, Antenna requirement.

An intentional radiator shall be designed to ensure that no antenna other than that furnished by the responsible party shall be used with the device. The use of a permanently attached antenna or of an antenna that uses a unique coupling to the intentional radiator shall be considered sufficient to comply with the provisions of this Section. The manufacturer may design the unit so that a broken antenna can be replaced by the user, but the use of a standard antenna jack or electrical connector is prohibited. This requirement does not apply to carrier current devices or to devices operated under the provisions of Sections 15.211, 15.213, 15.217, 15.219, or 15.221. Further, this requirement does not apply to intentional radiators that must be professionally installed, such as perimeter protection systems and some field disturbance sensors, or to other intentional radiators which, in accordance with Section 15.31(d), must be measured at the installation site. However, the installer shall be responsible for ensuring that the proper antenna is employed so that the limits in this Part are not exceeded.

11.2. Antenna Connected Construction

The directional gains of antenna used for transmitting 12.84dBi maximum and the antenna connector is designed with N type reverse connector and no consideration of replacement. Please see EUT photo for details.