

TEST REPORT

Report Number.: 14093500-E11V2

Applicant : SONOS INC.
614 CHAPALA ST.
SANTA BARBARA, CA, 93101, U.S.A.

Model : S41

Brand : SONOS

FCC ID : SBVRM041

IC : 5373A-RM041

EUT Description : 802.11 a/b/g/n/ac/ax 2x2 Client Device with BT and BLE

Test Standard(s) : FCC 47 CFR PART 15 SUBPART C
FCC 47 CFR PART 15 SUBPART E
ISED RSS-247 ISSUE 2
ISED RSS-GEN ISSUE 5 + A1 + A2

Date of Issue:

2022-10-24

Prepared by:

UL VERIFICATION SERVICES

47173 Benicia Street

Fremont, CA 94538 U.S.A.

TEL: (510) 319-4000

FAX: (510) 661-0888



REPORT REVISION HISTORY

Rev.	Issue Date	Revisions	Revised By
V1	2022-10-13	Initial Issue	---
V2	2022-10-24	Initial Issue	K.Kedida

REPORT REVISION HISTORY	2
1. ATTESTATION OF TEST RESULTS	4
2. TEST RESULTS SUMMARY	6
3. TEST METHODOLOGY	6
4. FACILITIES AND ACCREDITATION	6
5. DECISION RULES AND MEASUREMENT UNCERTAINTY	7
5.1. METROLOGICAL TRACEABILITY	7
5.2. DECISION RULES.....	7
5.3. MEASUREMENT UNCERTAINTY.....	7
5.4. SAMPLE CALCULATION	7
6. EQUIPMENT UNDER TEST	8
6.1. EUT DESCRIPTION	8
6.2. MAXIMUM OUTPUT POWER & DESCRIPTION OF AVAILABLE ANTENNAS	8
6.3. SOFTWARE AND FIRMWARE.....	8
6.4. SIMULTANEOUS TRANSMISSION CONFIGURATIONS.....	9
6.5. DESCRIPTION OF TEST SETUP.....	10
7. MEASUREMENT METHOD.....	12
8. TEST AND MEASUREMENT EQUIPMENT	13
9. SIMULTANEOUS TRANSMISSION TEST RESULTS.....	14
9.1. ON TIME AND DUTY CYCLE.....	14
9.2. LIMITS AND PROCEDURE.....	15
9.2.1. TEST CASE 1	17
9.2.2. TEST CASE 2.....	19
9.2.3. TEST CASE 3.....	21
9.2.1. TEST CASE 4.....	23
10. SETUP PHOTOS.....	25

1. ATTESTATION OF TEST RESULTS

COMPANY NAME: Sonos Inc.
614 Chapala St.
Santa Barbara, CA, 93101, U.S.A.

EUT DESCRIPTION: 802.11 a/b/g/n/ac/ax 2x2 Client Device with BT and BLE

MODEL: S41

BRAND: SONOS

SERIAL NUMBER: Radiated Sample: 528B4 and 6B90A
Conducted Sample: 4304F

DATE TESTED: 2022-06-16 to 2022-06-17

APPLICABLE STANDARDS	
STANDARD	TEST RESULTS
CFR 47 Part 15 Subpart C	Complies
CFR 47 Part 15 Subpart E	Complies
ISED RSS-247 Issue 2	Complies
ISED RSS-248 ISSUE 1	Complies
ISED RSS-GEN Issue 5 + A1 + A2	Complies

UL Verification Services Inc. tested the above equipment in accordance with the requirements set forth in the above standards. The test results show that the equipment tested is capable of demonstrating compliance with the requirements as documented in this report.

The results documented in this report apply only to the tested sample, under the conditions and modes of operation as described herein. It is the manufacturer's responsibility to assure that additional production units of this model are manufactured with identical electrical and mechanical components. All samples tested were in good operating condition throughout the entire test program. Measurement Uncertainties are published for informational purposes only and were not taken into account unless noted otherwise.

This document may not be altered or revised in any way unless done so by UL Verification Services Inc. and all revisions are duly noted in the revisions section. Any alteration of this document not carried out by UL Verification Services Inc. will constitute fraud and shall nullify the document. This report must not be used by the client to claim product certification, approval, or endorsement by A2LA, NIST, any agency of the Federal Government, or any agency of the U.S. government.

Approved & Released For
UL Verification Services Inc. By:

Prepared By:



Francisco de Anda
Staff Engineer
Consumer Technology Division
UL Verification Services Inc.

Glenn Escano
Senior Test Engineer
Consumer Technology Division
UL Verification Services Inc.

1st Reviewed By:

2nd Reviewed By:



Vien Tran
Senior Laboratory Engineer
Consumer Technology Division
UL Verification Services Inc.

Kiya Kedida
Senior Project Engineer
Consumer Technology Division
UL Verification Services Inc.

2. TEST RESULTS SUMMARY

This report contains data provided by the customer which can impact the validity of results. UL Verification Services Inc. is only responsible for the validity of results after the integration of the data provided by the customer.

FCC Clause	ISED Clause	Requirement	Result	Comment
See Comment		Duty Cycle	Reporting purposes only	Per ANSI C63.10, Section 12.2.
15.209, 15.205, 15.407 (b) (1-4)	RSS-GEN 8.9, 8.10, RSS-247 6.2	Radiated Emissions	Complies	For colocation testing

3. TEST METHODOLOGY

The tests documented in this report were performed in accordance with:

- FCC CFR 47 Part 2
- FCC CFR 47 Part 15
- FCC KDB 662911 D01 v02r01
- FCC KDB 905462 D02 v02/D03 v01r02/D06 v02
- KDB 558074 D01 15.247 Meas Guidance v05r02
- FCC KDB 789033 D02 v02r01
- KDB 414788 D01 Radiated Test Site v01r01
- ANSI C63.10-2013
- RSS-GEN Issue 5 + A1 + A2
- RSS-247 Issue 2
- ISED RSS-248 ISSUE 1

The scope of this report covers the co-location modes in the 2.4GHz and 5Ghz band.

4. FACILITIES AND ACCREDITATION

UL Verification Services Inc. is accredited by A2LA, Certificate Number #0751.05, for all testing performed within the scope of this report. Testing was performed at the locations noted below.

	Address	ISED CABID	ISED Company Number	FCC Registration
<input type="checkbox"/>	Building 1: 47173 Benicia Street Fremont, CA 94538, U.S.A	US0104	2324A	550739
<input type="checkbox"/>	Building 2: 47266 Benicia Street Fremont, CA 94538, U.S.A	US0104	22541	550739
<input checked="" type="checkbox"/>	Building 4: 47658 Kato Rd Fremont, CA 94538, U.S.A	US0104	2324B	550739

5. DECISION RULES AND MEASUREMENT UNCERTAINTY

5.1. METROLOGICAL TRACEABILITY

All test and measuring equipment utilized to perform the tests documented in this report are calibrated on a regular basis, with a maximum time between calibrations of one year or the manufacturers' recommendation, whichever is less, and where applicable is traceable to recognized national standards.

5.2. DECISION RULES

The Decision Rule is based on Simple Acceptance in accordance with ISO Guide 98-4:2012 Clause 8.2. (Measurement uncertainty is not taken into account when stating conformity with a specified requirement.)

5.3. MEASUREMENT UNCERTAINTY

Where relevant, the following measurement uncertainty levels have been estimated for tests performed on the apparatus:

PARAMETER	U_{Lab}
Worst Case Radiated Disturbance, 9KHz to 30 MHz	2.84 dB
Worst Case Radiated Disturbance, 30 to 1000 MHz	6.01 dB
Worst Case Radiated Disturbance, 1000 to 18000 MHz	4.73 dB
Worst Case Radiated Disturbance, 18000 to 26000 MHz	4.51 dB

Uncertainty figures are valid to a confidence level of 95%.

5.4. SAMPLE CALCULATION

RADIATED EMISSIONS

Where relevant, the following sample calculation is provided:

Field Strength (dBuV/m) = Measured Voltage (dBuV) + Antenna Factor (dB/m) + Cable Loss (dB) – Preamp Gain (dB)

$$36.5 \text{ dBuV} + 18.7 \text{ dB/m} + 0.6 \text{ dB} - 26.9 \text{ dB} = 28.9 \text{ dBuV/m}$$

MAINS CONDUCTED EMISSIONS

Where relevant, the following sample calculation is provided:

Final Voltage (dBuV) = Measured Voltage (dBuV) + Cable Loss (dB) + Limiter Factor (dB) + LISN Insertion Loss.

$$36.5 \text{ dBuV} + 0 \text{ dB} + 10.1 \text{ dB} + 0 \text{ dB} = 46.6 \text{ dBuV}$$

6. EQUIPMENT UNDER TEST

6.1. EUT DESCRIPTION

The EUT is an 802.11 a/b/g/n/ac/ax 2x2 Client Device with BT and BLE.

6.2. MAXIMUM OUTPUT POWER & DESCRIPTION OF AVAILABLE ANTENNAS

Refer to reports 14093500-E1, -E2, -E3, -E4, -E5, -E6, -E7 and -E8 for output power and antenna gain and type information.

6.3. SOFTWARE AND FIRMWARE

The EUT firmware installed during testing was 69.1-26251-dia.

The test utility software used during testing was GUI 20220422_V4.

6.4. SIMULTANEOUS TRANSMISSION CONFIGURATIONS

Simultaneous transmission of the following was investigated:

- 2.4GHz and Bluetooth
- 2.4GHz and BLE
- 5/6GHz and Bluetooth
- 5/6GHz WLAN and BLE

Per the manufacturer, no other radios transmit simultaneously. See section 9.2 for modes tested. All test case was identified based on the the highest power in the band.

6.5. DESCRIPTION OF TEST SETUP

SUPPORT TEST EQUIPMENT						
Description	Manufacturer	Model	Serial Number	FCC ID/ DoC		
Laptop	Lenovo	T460s	PC0JMBF8	Doc		
Laptop AC/DC Adapter	Lenovo	ADLX90NLC2A	11S45N0247Z1ZSHH448JEY	Doc		
USB-A to Ethernet Adapter	Plugable	USB2-E100	8CAE4CE46AFA	Doc		
USB-C to USB-A Female Adapter	Amazon Basics	L6LUC160-CS-R	N/A	Doc		
I/O CABLES (CONDUCTED TEST)						
Cable No.	Port	# of Identical Ports	Connector Type	Cable Type	Cable Length (m)	Remarks
1	AC	3	AC	Un-shielded	1.25	AC Mains to EUT/Spectrum Analyzer/AC/DC Adapter
2	DC	1	DC	Un-shielded	1	AC/DC Adapter to Laptop
3	Ethernet	1	RJ45	Un-shielded	1.5	Laptop to USB Ethernet Adapter
4	USB-A	1	USB-A	Shielded	0.05	USB EthernetAdapter to USB
5	USB-C	1	USB-C	Shielded	0.05	EUT to USB-C/USB-A Female Adapter
6	SMA Cable	1	SMA	Un-Shielded	0.1	EUT to Spectrum Analyzer
I/O CABLES (RADIATED TEST)						
Cable No.	Port	# of Identical Ports	Connector Type	Cable Type	Cable Length (m)	Remarks
1	AC	3	AC	Un-shielded	1.25	AC Mains to EUT/Spectrum Analyzer/AC/DC Adapter
2	DC	1	DC	Un-shielded	1	AC/DC Adapter to Laptop
3	Ethernet	1	RJ45	Un-shielded	10	Laptop to USB Ethernet Adapter
4	USB-A	1	USB-A	Shielded	0.05	USB EthernetAdapter to USB
5	USB-C	1	USB-C	Shielded	0.05	EUT to USB-C/USB-A Female Adapter
6	SMA Cable	1	SMA	Un-Shielded	10	EUT to Horn Antenna

TEST SETUP

The EUT is a stand-alone unit, and the radio is exercised remotely by Sonos Compliance GUI test utility software via ethernet.

SETUP DIAGRAMS

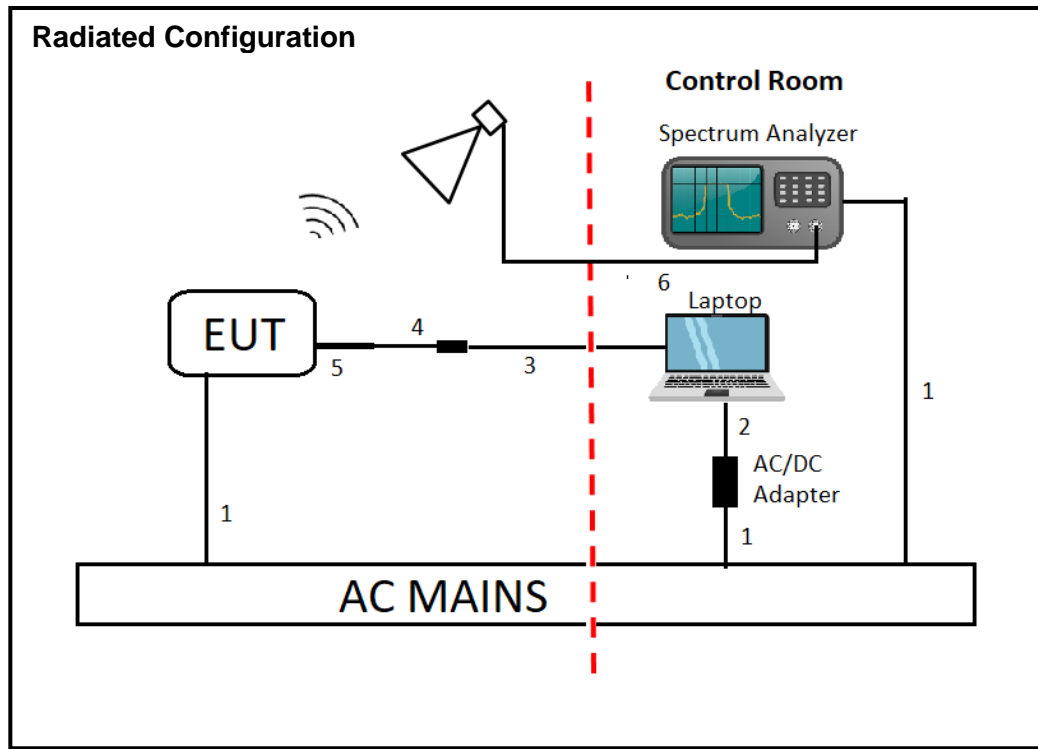

7. MEASUREMENT METHOD

Radiated emissions non-restricted frequency bands: ANSI C63.10 Subclause -11.11

Radiated emissions restricted frequency bands: ANSI C63.10 Subclause -11.12.1

8. TEST AND MEASUREMENT EQUIPMENT

The following test and measurement equipment was utilized for the tests documented in this report:

TEST EQUIPMENT LIST					
Description	Manufacturer	Model	ID Num	Cal Due	Last Cal
Amplifier, 10KHz to 1GHz, 32dB	SONOMA INSTRUMENT	310N	29654	2023-04-24	2022-04-24
Antenna, Horn 1-18GHz	ETS-Lindgren (Cedar Park, Texas)	3117	80404	2022-08-04	2021-08-04
Amplifier, 100MHz - 18GHz	AMPLICAL	AMP0.1G18-47-20	185686	2023-04-19	2022-04-19
RF Filter Box, 1-18GHz	FREMONT	SAC-L1	171013	2023-03-09	2022-03-09
EMI TEST RECEIVER,	Rohde & Schwarz	ESW44	PRE0179367	2023-02-16	2022-02-16
EMI TEST RECEIVER, with B8 option	Rohde & Schwarz	ESW44	PRE0179377	2023-02-20	2022-02-20
UL TEST SOFTWARE LIST					
Radiated Software	UL	UL EMC	Ver 2016-05-11, 2015-12-29, 2019-10-09, 2021-12-07, 2022-05-18, and 2022-07-06		

9. SIMULTANEOUS TRANSMISSION TEST RESULTS

9.1. ON TIME AND DUTY CYCLE

Refer to reports 14093500-E1, -E2, -E3, -E4, -E5, -E6, -E7 and -E8 for duty cycle data

9.2. LIMITS AND PROCEDURE

FCC §15.205 and §15.209

FCC §15.407(b)(1-4) -

RSS-GEN, Section 8.9 and 8.10

RSS 247 Issue 2 Sections

6.2.1.2 (for 5150-5250 MHz band)

6.2.2.2 (for 5250-5350 MHz band)

6.2.3.2 (for 5470-5600 MHz and 5650-5725 MHz bands)

6.2.4.2 (for 5725-5850 MHz band)

Frequency Range (MHz)	Field Strength Limit (uV/m) at 3 m	Field Strength Limit (dBuV/m) at 3 m
0.009-0.490	2400/F(kHz) @ 300 m	-
0.490-1.705	24000/F(kHz) @ 30 m	-
1.705 - 30	30 @ 30m	-
30 - 88	100	40
88 - 216	150	43.5
216 - 960	200	46
Above 960	500	54

TEST PROCEDURE

The EUT is placed on a non-conducting table 1.5 m above the ground plane for measurement above 1GHz. The antenna to EUT distance is 3 meters. The EUT is configured in accordance with ANSI C63.10. The EUT is set to transmit in a continuous mode.

For pre-scans above 1 GHz the resolution bandwidth is set to 1 MHz; the video bandwidth is set to 30 KHz for peak measurements.

For final measurements above 1 GHz the resolution bandwidth is set to 1 MHz; the video bandwidth is set to 3 MHz for peak measurements and as applicable for average measurements.

The spectrum from 1 GHz to 18 GHz is investigated with the transmitter set to the lowest, middle, and highest channels in each applicable band.

The frequency range of interest is monitored at a fixed antenna height and EUT azimuth. The EUT is rotated through 360 degrees to maximize emissions received. The antenna is scanned from 1 to 4 meters above the ground plane to further maximize the emission. Measurements are made with the antenna polarized in both the vertical and the horizontal positions.

Base on FCC 15.31 (f) (2): measurements may be performed at a distance closer than that specified in the regulations; however, an attempt should be made to avoid making measurements in the near field.

KDB 558074 D01 15.247 Meas Guidance v05r02

Use of a duty cycle correction factor (DCCF) is permitted for calculating average radiated field strength emission levels for an FHSS device in 15.247. This DCCF can be applied when the field strength limit (e.g., within a Government Restricted band) and the conditions specified in Section 15.35(c) can be satisfied. The average radiated field strength is calculated by subtracting the DCCF from the maximum radiated field strength level as determined through measurement. The maximum radiated field strength level represents the worst-case (maximum amplitude) RMS measurement of the emission(s) during continuous transmission (i.e., not including any time intervals during which the transmitter is off or is transmitting at a reduced power level). It is also acceptable to apply the DCCF to a measurement performed with a peak detector instead of the specified RMS power averaging detector. Note that Section 15.35(c) specifies that the DCCF shall represent the worst-case (greatest duty cycle) over any 100 msec transmission period.

Note - For this test program, Peak detection was used. The DCCF was then subtracted from the peak value. The DCCF was calculated based on the worst case on-time when the device transmits DH5 packets and operates on 20 channels (5/1600 s per hop = 3.125 ms per channel). In this mode, the device will have a maximum of 2 hops on a channel in 100ms or $2 \times 3.125 \text{ ms} = 6.25 \text{ ms}$ on any channel. Therefore, $\text{DCCF} = 20 \log (6.25 / 100) = -24 \text{ dB}$.

9.2.1. TEST CASE 1

BT GFSK 2441MHz + WLAN 5GHz 11ac HE80 5610MHz

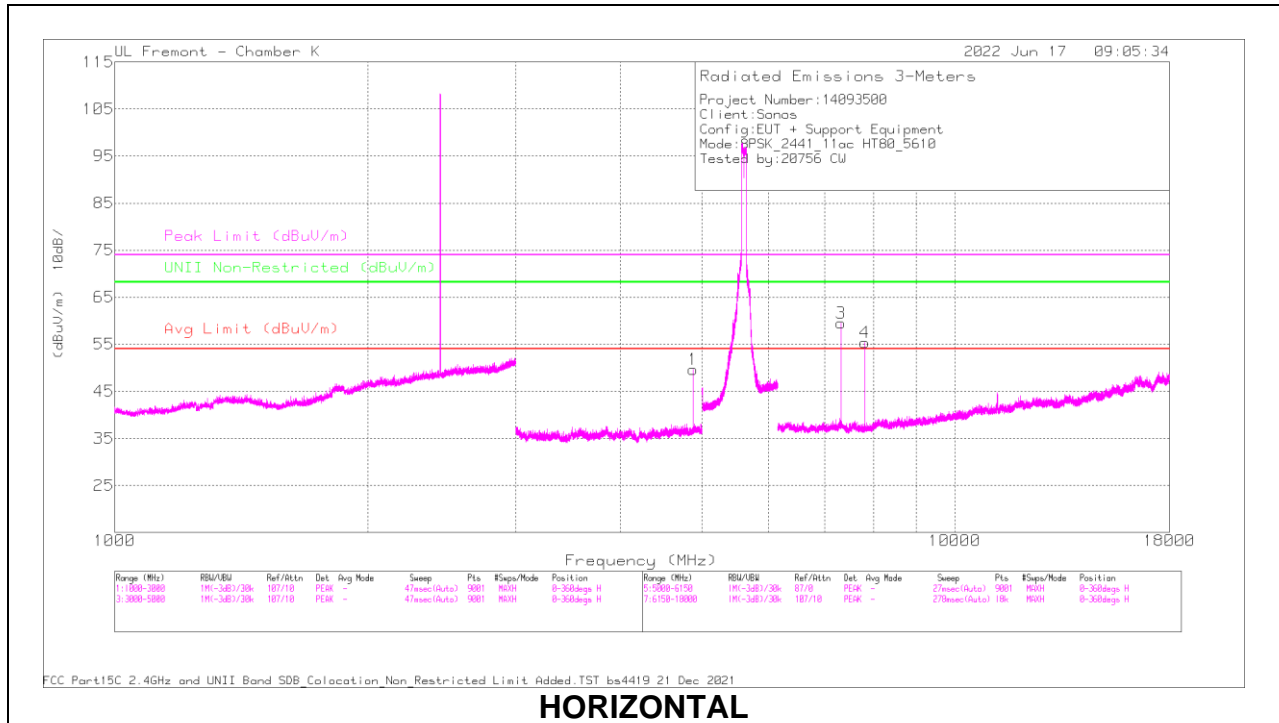

HORIZONTAL

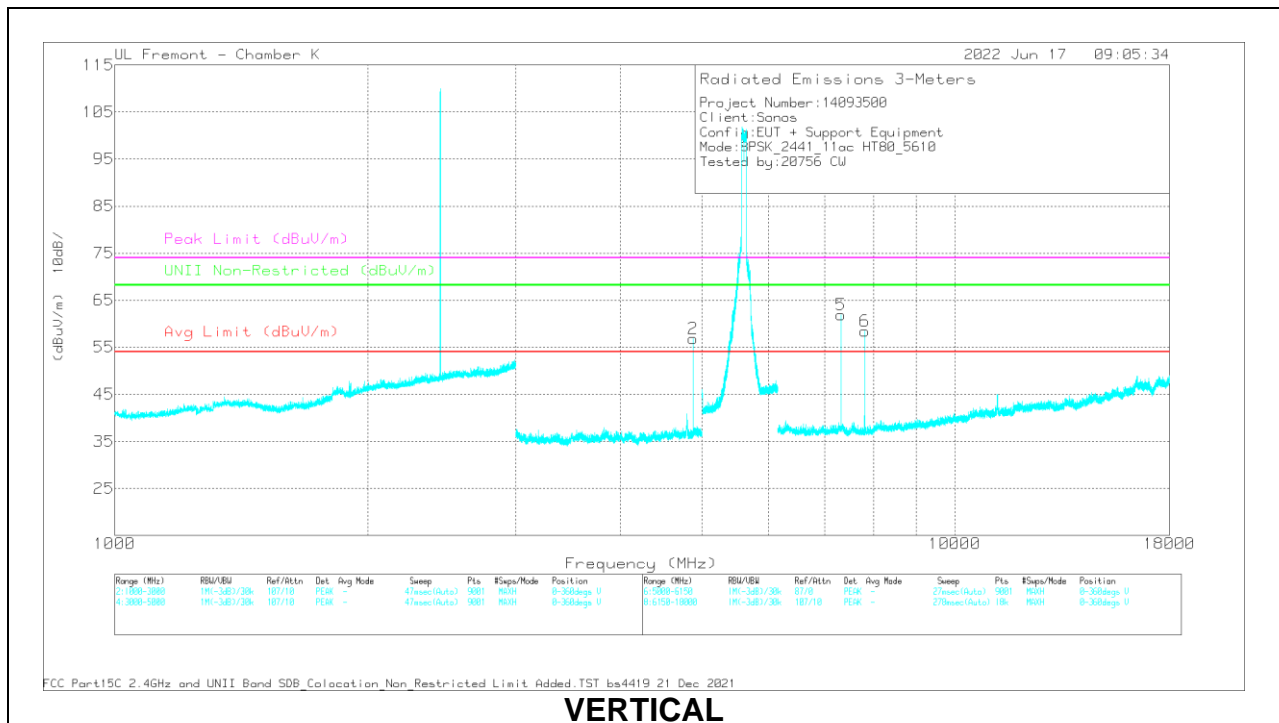

VERTICAL

Trace Markers

Marker	Frequency (MHz)	Mask Reading (dBuV)	Det	AF 5004 (dBm)	Amp/Cof/Fir (dB)	Filter (dB)	Corrected Reading (dBuV/m)	Avg Limit (dBuV/m)	Margin (dB)	Peak Limit (dBuV/m)	PK Margin (dB)	UNI Non-Restricted (dBuV/m)	PK Margin (dB)	Altitude (Degs)	Height (cm)	Polarity
1	* 4882.22	53.94	Pk	34.1	-40.3	2	49.64	-	-	74	-24.36	-	-	0-360	199	H
2	* 4882.22	61.05	Pk	34.1	-40.3	2	56.85	-	-	74	-17.15	-	-	0-360	199	V
3	* 7323.085	60.3	Pk	35.7	-37	.5	59.5	-	-	74	-14.5	-	-	0-360	100	H
4	7810.883	56.63	Pk	35.9	-37.7	.5	55.33	-	-	-	-	68.2	-12.87	0-360	200	H
5	* 7322.427	62.66	Pk	35.7	-37	.5	61.86	-	-	74	-12.14	-	-	0-360	200	V
6	7810.883	59.74	Pk	35.9	-37.7	.5	58.44	-	-	-	-	68.2	-9.76	0-360	200	V

* - indicates frequency in CFR47 Pt 15 / IC RSS-Restricted Band
 Pk - Peak detector

Radiated Emissions

Marker	Frequency (MHz)	Mask Reading (dBuV)	Det	AF 5004 (dBm)	Amp/Cof/Fir (dB)	Corrected Reading (dBuV/m)	Avg Limit (dBuV/m)	Margin (dB)	Peak Limit (dBuV/m)	PK Margin (dB)	UNI Non-Restricted (dBuV/m)	PK Margin (dB)	Altitude (Degs)	Height (cm)	Polarity
1	* 4882.46	59.38	PKFH	34.1	-40.4	53.98	-	-	74	-18.92	-	-	67	244	H
	* 4881.761	48.89	VA1T	34.1	-40.3	42.69	54	-11.31	-	-	-	-	67	244	H
2	* 4882.095	66.2	PKFH	34.1	-40.3	60	-	-	74	-12	-	-	93	188	V
	* 4882.036	56.73	VA1T	34.1	-40.3	50.53	54	-3.47	-	-	-	-	93	188	V
3	* 7323.555	64.46	PKFH	35.7	-37.1	63.06	-	-	74	-10.44	-	-	15	128	H
	* 7323.05	51.95	VA1T	35.7	-37	50.65	54	-3.35	-	-	-	-	15	128	H
4	7811.178	58.64	PKFH	35.9	-37.7	56.24	-	-	-	-	68.2	-10.86	154	187	H
	7811.128	55.6	VA1T	35.9	-37.7	54.8	-	-	-	-	-	-	154	187	H
5	* 7322.679	66.77	PKFH	35.7	-37	65.47	-	-	74	-8.03	-	-	152	187	V
	* 7322.727	54.65	VA1T	35.7	-37	53.35	54	-6.5	-	-	-	-	152	187	V
6	7811.248	62.47	PKFH	35.9	-37.7	60.67	-	-	-	-	68.2	-7.03	90	348	V
	7811.253	61.22	VA1T	35.9	-37.7	59.42	-	-	-	-	-	-	90	348	V

* - indicates frequency in CFR47 Pt 15 / IC RSS-Restricted Band
 PKFH FHSS/BT RB=100k for Frequencies<1GHz / RB=1MHz for Frequencies>1GHz, VB=3 x RB, Peak
 VA1T - FHSS: Linear Voltage Average VB=1/Ton where: Ton is transmit duration

9.2.2. TEST CASE 2

BT GFSK 2441MHz + WLAN 2.4GHz 11g 2437MHz

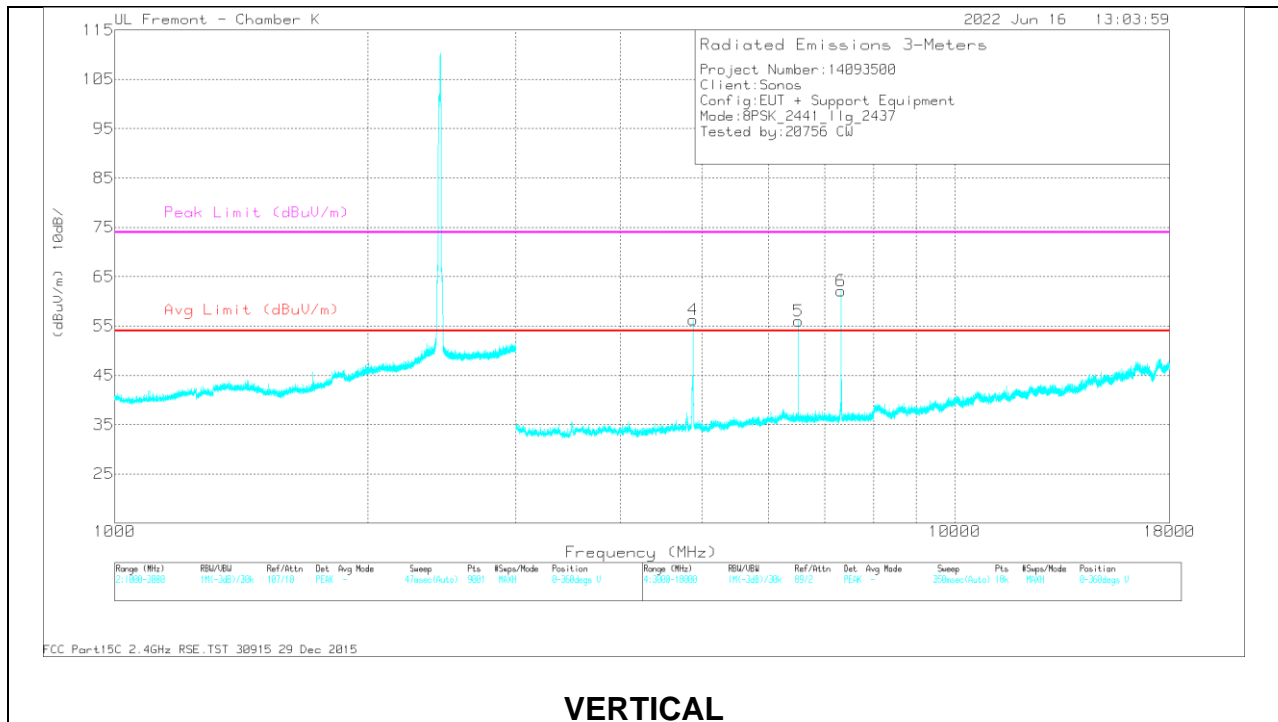
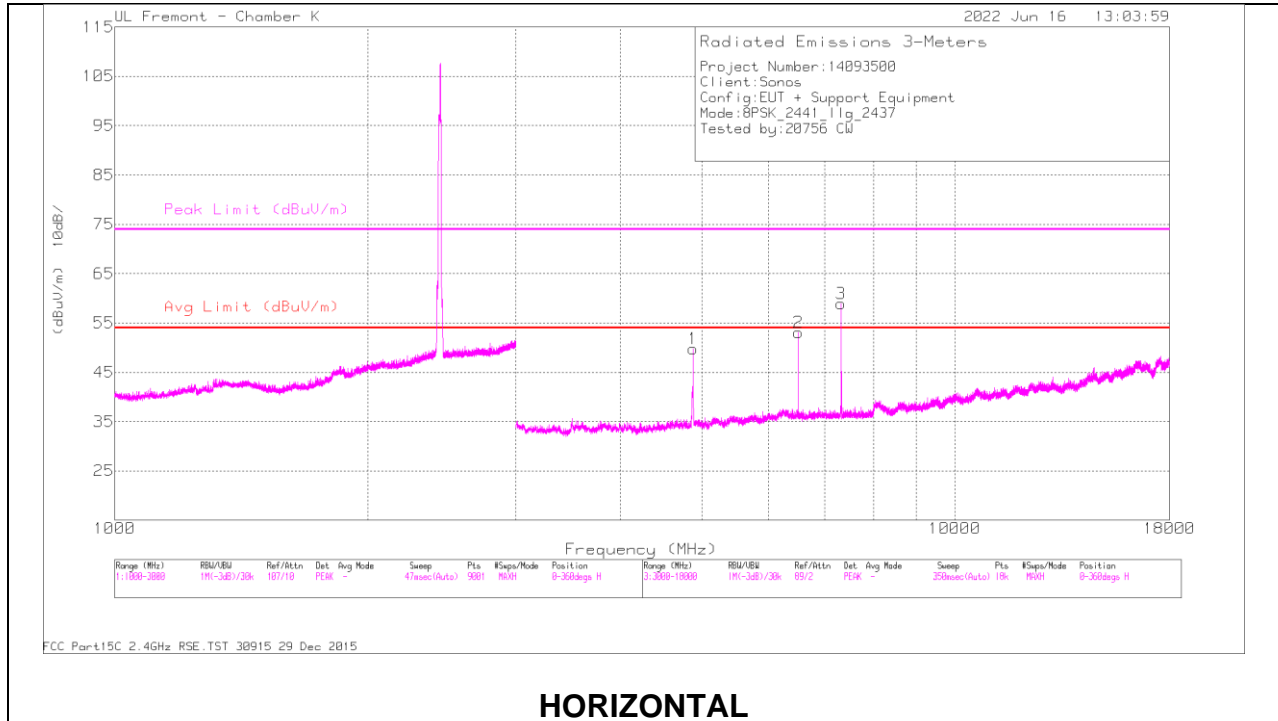

Trace Markers

Marker	Frequency (MHz)	Meter Reading (dBuV)	Det	AF 80404 (dB/m)	Amp/Cbl/Filtr (dB)	Corrected Reading (dBuV/m)	Avg Limit (dBuV/m)	Margin (dB)	Peak Limit (dBuV/m)	PK Margin (dB)	Azimuth (Degs)	Height (cm)	Polarity
1	* 4881.772	55.96	Pk	34.1	-40.3	49.76	-	-	74	-24.24	0-360	100	H
2	6509.363	56.02	Pk	35.9	-38.8	53.12	-	-	-	-	0-360	100	H
3	* 7322.742	61.16	Pk	35.7	-37.9	58.96	-	-	74	-15.04	0-360	200	H
4	* 4881.772	62.52	Pk	34.1	-40.3	56.32	-	-	74	-17.68	0-360	200	V
5	6509.363	58.95	Pk	35.9	-38.8	56.05	-	-	-	-	0-360	200	V
6	* 7322.742	64.26	Pk	35.7	-37.9	62.06	-	-	74	-11.94	0-360	200	V

* - indicates frequency in CFR47 Pt 15 / IC RSS-Restricted Band

Pk - Peak detector

Radiated Emissions

Marker	Frequency (MHz)	Meter Reading (dBuV)	Det	AF 80404 (dB/m)	Amp/Cbl/Filtr (dB)	Corrected Reading (dBuV/m)	Avg Limit (dBuV/m)	Margin (dB)	Peak Limit (dBuV/m)	PK Margin (dB)	Azimuth (Degs)	Height (cm)	Polarity
1	* 4882.142	61.75	PKFH	34.1	-40.3	55.55	-	-	74	-18.45	71	98	H
	* 4882.032	51.73	VA1T	34.1	-40.3	45.53	54	-8.47	-	-	71	98	H
2	6509.253	59.4	PKFH	35.9	-38.8	56.5	-	-	-	-	357	137	H
	6509.223	57.31	VA1T	35.9	-38.8	54.41	-	-	-	-	357	137	H
3	* 7323.346	63.39	PKFH	35.7	-37.9	61.19	-	-	74	-12.81	203	194	H
	* 7323.107	50.89	VA1T	35.7	-37.9	48.69	54	-5.31	-	-	203	194	H
4	* 4881.762	68.29	PKFH	34.1	-40.3	62.09	-	-	74	-11.91	95	217	V
	* 4881.942	59.04	VA1T	34.1	-40.3	52.84	54	-1.16	-	-	95	217	V
5	6509.313	62.5	PKFH	35.9	-38.8	59.6	-	-	-	-	103	333	V
	6509.213	61.08	VA1T	35.9	-38.8	58.18	-	-	-	-	103	333	V
6	* 7323.509	66.42	PKFH	35.7	-38	64.12	-	-	74	-9.88	167	231	V
	* 7322.868	54.38	VA1T	35.7	-37.9	52.18	54	-1.82	-	-	167	231	V

* - indicates frequency in CFR47 Pt 15 / IC RSS-Restricted Band

PKFH FHSS/BT RB=100k for Frequencies<1GHz / RB=1MHz for Frequencies>1GHz, VB=3 x RB, Peak VA1T - FHSS: Linear Voltage Average VB=1/Ton where: Ton is transmit duration

9.2.3. TEST CASE 3

BLE 2440MHz + WLAN 5GHz 11ac HE80 5610MHz

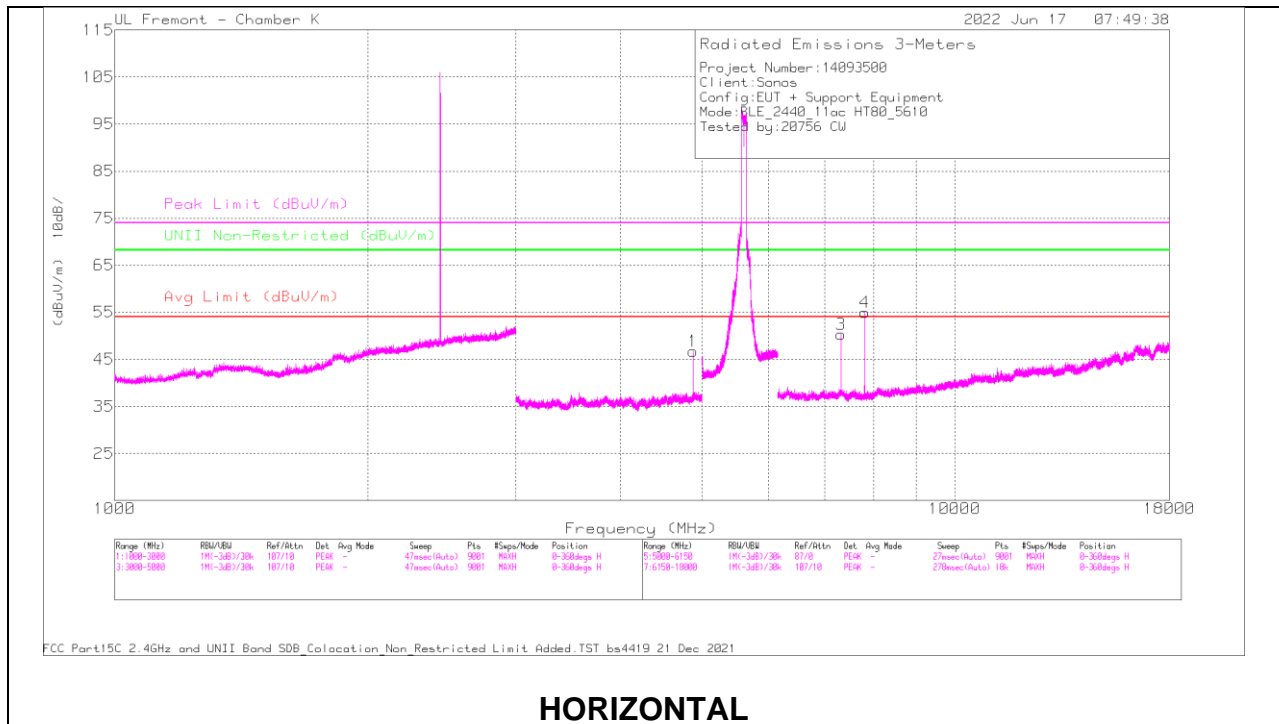

HORIZONTAL

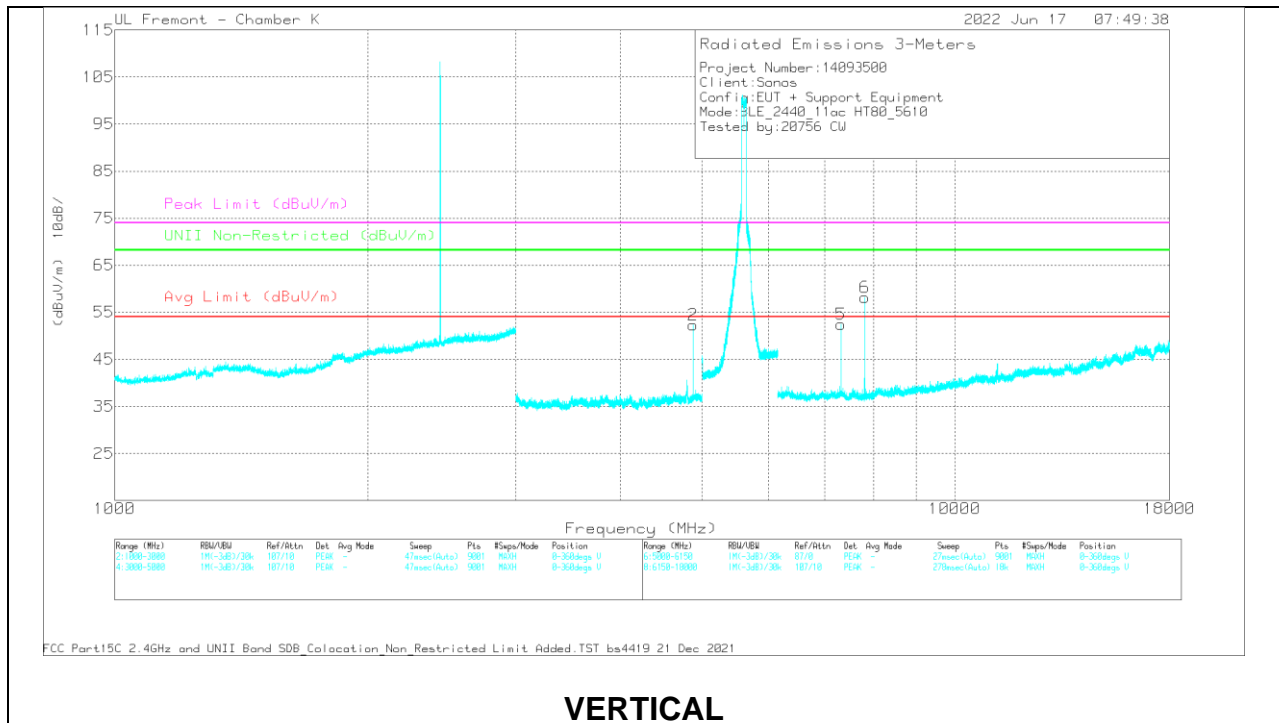

VERTICAL

Trace Markers

Marker	Frequency (MHz)	Mask Reading (dBm)	Det	AF 8042 (dBm)	Amp/CatFtr (dB)	Filter (dB)	DC Corr (dB)	Corrected Reading (dBm)	Avg Limit (dBuV/m)	Margin (dB)	Peak Limit (dBuV/m)	PK Margin (dB)	Limit Non-Restricted (dBuV/m)	PK Margin (dB)	Altitude (Degs)	Height (m)	Polarity
1	* 4879.999	51.01	Pk	34.1	-40.4	2	0	46.71	-	-	74	-27.29	-	-	0-360	100	H
2	* 4879.994	56.59	Pk	34.1	-40.4	2	0	52.29	-	-	74	-21.71	-	-	0-360	200	V
3	* 7319.452	59.96	Pk	35.8	-37	5	0	59.96	-	-	75	-23.74	-	-	0-360	100	H
4	7807.592	56.29	Pk	35.9	-37.7	5	0	54.99	-	-	-	-	68.2	-13.21	0-360	199	H
5	* 7319.452	53.21	Pk	35.8	-37	5	0	52.51	-	-	74	-21.49	-	-	0-360	100	V
6	7807.592	59.47	Pk	35.9	-37.7	5	0	58.17	-	-	-	-	68.2	-10.03	0-360	199	V

* - indicates frequency in CFR47 Pt 15 / IC RSS-Restricted Band
 Pk - Peak detector

Radiated Emissions

Marker	Frequency (MHz)	Mask Reading (dBuV)	Det	AF 8042 (dBm)	Amp/CatFtr (dB)	DC Corr (dB)	Corrected Reading (dBuV/m)	Avg Limit (dBuV/m)	Margin (dB)	Peak Limit (dBuV/m)	PK Margin (dB)	Limit Non-Restricted (dBuV/m)	PK Margin (dB)	Altitude (Degs)	Height (m)	Polarity
1	* 4880.102	56.9	PK-U	34.1	-40.4	0	50.6	-	-	74	-21.4	-	-	71	98	H
	4879.996	47.63	ADR	34.1	-40.4	3.36	44.69	54	-9.31	-	-	-	-	71	98	H
2	* 4879.999	61.5	PK-U	34.1	-40.4	0	55.2	-	-	74	-16.8	-	-	99	211	V
	4879.813	54.36	ADR	34.1	-40.4	3.36	51.42	54	-2.58	-	-	-	-	99	211	V
3	* 7319.303	57.93	PK-U	35.8	-37	0	56.73	-	-	74	-16.77	-	-	13	140	H
	7319.313	49.86	ADR	35.8	-37	3.36	52.12	54	-1.88	-	-	-	-	13	140	H
4	7807.951	59.52	PK-U	35.9	-37.7	0	57.72	-	-	-	-	68.2	-9.98	156	189	H
	7808.011	55.51	ADR	35.9	-37.7	3.36	57.07	-	-	-	-	-	-	156	189	H
5	* 7319.113	57.44	PK-U	35.8	-37	0	56.24	-	-	74	-17.26	-	-	144	106	V
	7319.289	49.54	ADR	35.8	-37	3.36	51.7	54	-2.3	-	-	-	-	144	106	V
6	7807.937	62.8	PK-U	35.9	-37.7	0	61.0	-	-	-	-	68.2	-6.7	92	362	V
	7807.937	59.86	ADR	35.9	-37.7	3.36	61.42	-	-	-	-	-	-	92	362	V

* - indicates frequency in CFR47 Pt 15 / IC RSS-Restricted Band
 PK-U - U-NII: Maximum Peak
 ADR - U-NII AD primary method, RMS average

9.2.1. TEST CASE 4

BLE 2440MHz + WLAN 2.4GHz 11g 2437MHz

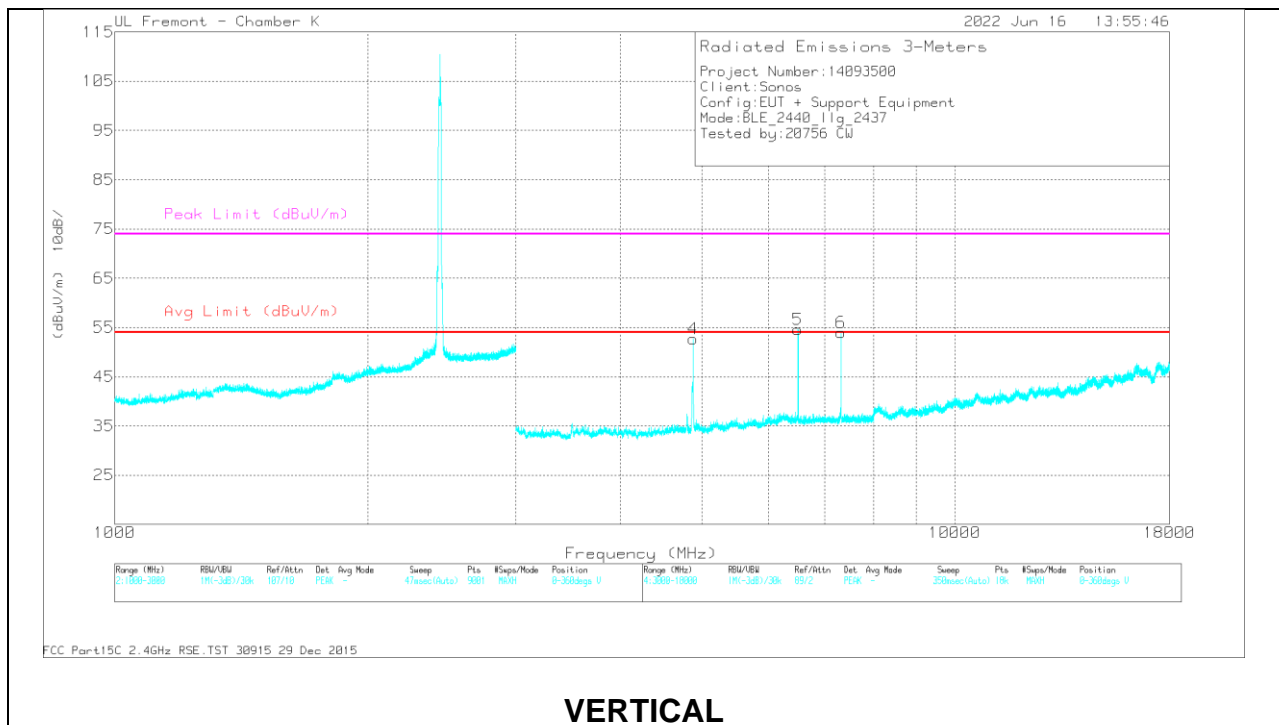
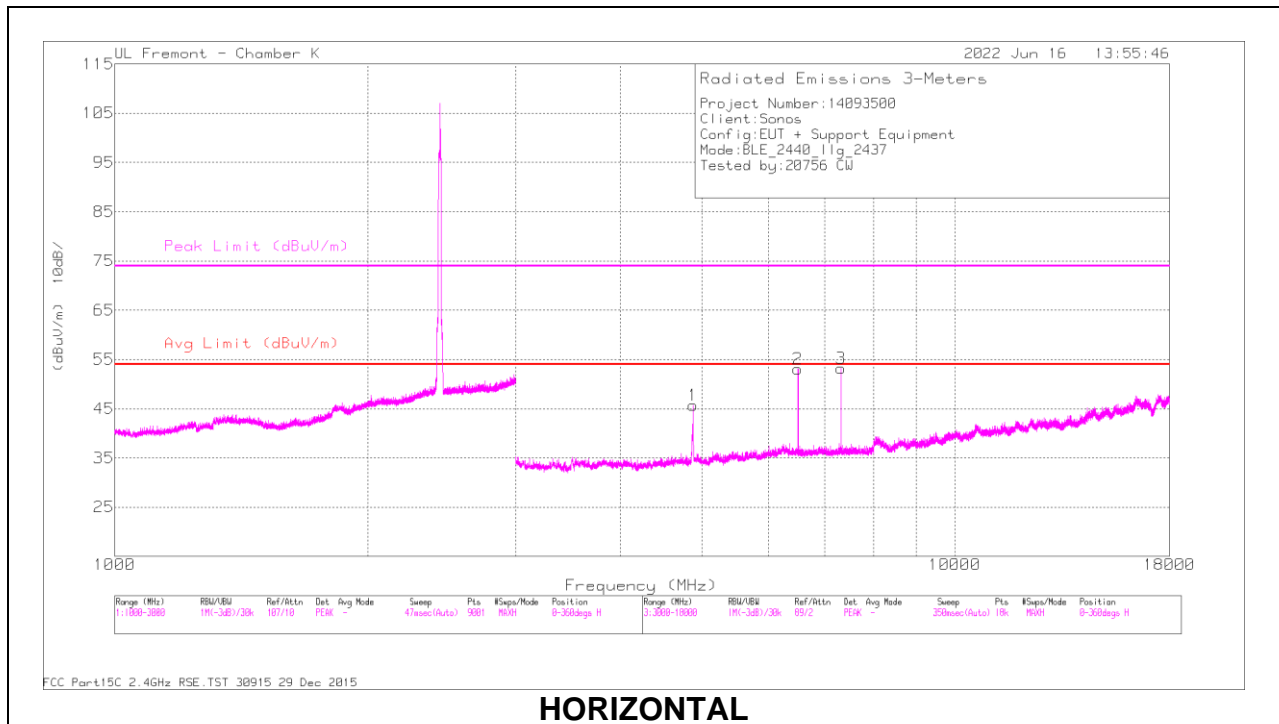

Trace Markers

Marker	Frequency (MHz)	Meter Reading (dBuV)	Det	AF 80404 (dB/m)	Amp/Cbl/Fitr (dB)	DC Corr (dB)	Corrected Reading (dBuV/m)	Avg Limit (dBuV/m)	Margin (dB)	Peak Limit (dBuV/m)	PK Margin (dB)	Azimuth (Degs)	Height (cm)	Polarity
1	* 4880.105	51.99	Pk	34.1	-40.4	0	45.69	-	-	74	-28.31	0-360	100	H
2	6506.03	56.14	Pk	35.9	-38.9	0	53.14	-	-	-	-	0-360	100	H
3	* 7320.242	55.36	Pk	35.8	-38	0	53.16	-	-	74	-20.84	0-360	100	H
4	* 4880.105	58.97	Pk	34.1	-40.4	0	52.67	-	-	74	-21.33	0-360	200	V
5	6506.03	57.56	Pk	35.9	-38.9	0	54.56	-	-	-	-	0-360	200	V
6	* 7319.409	56.16	Pk	35.8	-38	0	53.96	-	-	74	-20.04	0-360	200	V

* - indicates frequency in CFR47 Pt 15 / IC RSS-Restricted Band
 Pk - Peak detector

Radiated Emissions

Marker	Frequency (MHz)	Meter Reading (dBuV)	Det	AF 80404 (dB/m)	Amp/Cbl/Fitr (dB)	DC Corr (dB)	Corrected Reading (dBuV/m)	Avg Limit (dBuV/m)	Margin (dB)	Peak Limit (dBuV/m)	PK Margin (dB)	Azimuth (Degs)	Height (cm)	Polarity
1	* 4879.681	58.51	PK2	34.1	-40.4	0	52.21	-	-	74	-21.79	72	98	H
	* 4879.826	50.29	MAV1	34.1	-40.4	2.15	46.14	54	-7.86	-	-	72	98	H
2	6506.699	59.99	PK2	35.9	-38.8	0	57.09	-	-	-	-	357	137	H
	6506.679	55.7	MAV1	35.9	-38.8	2.15	54.95	-	-	-	-	357	137	H
3	* 7319.331	58.6	PK2	35.8	-38	0	56.4	-	-	74	-17.6	5	147	H
	* 7319.217	50.92	MAV1	35.8	-38	2.15	50.87	54	-3.13	-	-	5	147	H
4	* 4880.33	63.24	PK2	34.1	-40.4	0	56.94	-	-	74	-17.06	90	204	V
	* 4879.94	56.67	MAV1	34.1	-40.4	2.15	52.52	54	-1.48	-	-	90	204	V
5	6506.695	62.6	PK2	35.9	-38.8	0	59.7	-	-	-	-	101	332	V
	6506.665	59.22	MAV1	35.9	-38.8	2.15	58.47	-	-	-	-	101	332	V
6	* 7319.279	60.04	PK2	35.8	-38	0	57.84	-	-	74	-16.16	153	190	V
	* 7320.608	52.05	MAV1	35.8	-38	2.15	52	54	-2	-	-	153	190	V

* - indicates frequency in CFR47 Pt 15 / IC RSS-Restricted Band
 PK2 - KDB558074 Method: Maximum Peak
 MAV1 - KDB558074 Option 1 Maximum RMS Average