



TEST REPORT

Report Number.: 14093500-E6V2

Applicant : SONOS INC.
614 CHAPALA ST.
SANTA BARBARA, CA, 93101, U.S.A.

Model : S41

Brand : SONOS

FCC ID : SBVRM041

IC : 5373A-RM041

EUT Description : 802.11 a/b/g/n/ac/ax 2x2 Client Device with BT and BLE

Test Standard(s) : FCC 47 CFR PART 15 SUBPART E
ISED RSS-247 ISSUE 2
ISED RSS-GEN ISSUE 5 + A1 + A2

Date Of Issue:

2022-10-24

Prepared by:

UL Verification Services Inc.
47173 Benicia Street
Fremont, CA 94538 U.S.A.
TEL: (510) 319-4000
FAX: (510) 661-0888



REPORT REVISION HISTORY

Rev.	Issue Date	Revisions	Revised By
V1	2022-10-13	Initial Issue	---
V2	2022-10-24	Updated Section 9 and 10	K.Kedida

TABLE OF CONTENTS

REPORT REVISION HISTORY	2
TABLE OF CONTENTS	3
1. ATTESTATION OF TEST RESULTS	6
2. TEST RESULT SUMMARY	8
3. TEST METHODOLOGY	9
4. FACILITIES AND ACCREDITATION	9
5. DECISION RULES AND MEASUREMENT UNCERTAINTY	10
5.1. METROLOGICAL TRACEABILITY	10
5.2. DECISION RULES.....	10
5.3. MEASUREMENT UNCERTAINTY.....	10
6. EQUIPMENT UNDER TEST	11
6.1. EUT DESCRIPTION	11
6.2. MAXIMUM OUTPUT POWER.....	11
6.3. DESCRIPTION OF AVAILABLE ANTENNAS	14
6.4. SOFTWARE AND FIRMWARE.....	14
6.5. TEST REDUCTION CASE.....	14
6.6. WORST-CASE CONFIGURATION AND MODE.....	15
6.7. DESCRIPTION OF TEST SETUP.....	16
7. MEASUREMENT METHOD.....	18
8. TEST AND MEASUREMENT EQUIPMENT	19
9. ANTENNA PORT TEST RESULTS	20
9.1. ON TIME AND DUTY CYCLE.....	20
9.2. 26 dB BANDWIDTH.....	23
9.2.1. 802.11ax HE20 MODE 2TX IN THE 5.2GHz BAND.....	24
9.2.2. 802.11ax HE40 MODE 2TX IN THE 5.2GHz BAND.....	26
9.2.3. 802.11ax HE80 MODE 2TX IN THE 5.2GHz BAND.....	27
9.2.4. 802.11ax HE20 MODE 2TX IN THE 5.3GHz BAND.....	28
9.2.5. 802.11ax HE40 MODE 2TX IN THE 5.3GHz BAND.....	30
9.2.6. 802.11ax HE80 MODE 2TX IN THE 5.3GHz BAND.....	31
9.2.7. 802.11ax HE20 MODE 2TX IN THE 5.6GHz BAND.....	32
9.2.8. 802.11ax HE40 MODE 2TX IN THE 5.6GHz BAND.....	34
9.2.9. 802.11ax HE80 MODE 2TX IN THE 5.6GHz BAND.....	36
9.2.10. 802.11ax HE20 MODE 2TX IN THE 5.8GHz BAND.....	37
9.2.11. 802.11ax HE40 MODE 2TX IN THE 5.8GHz BAND.....	39

9.2.12. 802.11ax HE80 MODE 2TX IN THE 5.8GHz BAND.....40

9.3. 99% BANDWIDTH.....41

9.3.1. 802.11ax HE20 MODE 2TX IN THE 5.2GHz BAND.....42

9.3.2. 802.11ax HE40 MODE 2TX IN THE 5.2GHz BAND.....46

9.3.3. 802.11ax HE80 MODE 2TX IN THE 5.2GHz BAND.....48

9.3.4. 802.11ax HE20 MODE 2TX IN THE 5.3GHz BAND.....50

9.3.5. 802.11ax HE40 MODE 2TX IN THE 5.3GHz BAND.....52

9.3.6. 802.11ax HE80 MODE 2TX IN THE 5.3GHz BAND.....54

9.3.7. 802.11ax HE20 MODE 2TX IN THE 5.6GHz BAND.....55

9.3.8. 802.11ax HE40 MODE 2TX IN THE 5.6GHz BAND.....57

9.3.9. 802.11ax HE80 MODE 2TX IN THE 5.6GHz BAND.....59

9.3.10. 802.11ax HE20 MODE 2TX IN THE 5.8GHz BAND.....60

9.3.11. 802.11ax HE40 MODE 2TX IN THE 5.8GHz BAND.....62

9.3.12. 802.11ax HE80 MODE 2TX IN THE 5.8GHz BAND.....63

9.4. 6 dB BANDWIDTH.....64

9.4.1. 802.11ax HE20 MODE 2TX IN THE 5.8GHz BAND.....65

9.4.2. 802.11ax HE40 MODE 2TX IN THE 5.8GHz BAND.....68

9.4.3. 802.11ax HE80 MODE 2TX IN THE 5.8GHz BAND.....70

9.5. OUTPUT POWER AND PSD.....72

9.5.1. 802.11ax HE20 MODE 2TX IN THE 5.2GHz BAND (FCC).....76

9.5.2. 802.11ax HE40 MODE 2TX IN THE 5.2GHz BAND (FCC).....82

9.5.3. 802.11ax HE80 MODE 2TX IN THE 5.2GHz BAND (FCC).....87

9.5.4. 802.11ax HE20 MODE 2TX IN THE 5.2GHz BAND (IC).....92

9.5.5. 802.11ax HE40 MODE 2TX IN THE 5.2GHz BAND (IC).....101

9.5.6. 802.11ax HE80 MODE 2TX IN THE 5.2GHz BAND (IC).....108

9.5.7. 802.11ax HE20 MODE 2TX IN THE 5.3GHz BAND (FCC+IC).....114

9.5.8. 802.11ax HE40 MODE 2TX IN THE 5.3GHz BAND (FCC+IC).....123

9.5.9. 802.11ax HE80 MODE 2TX IN THE 5.3GHz BAND (FCC+IC).....130

9.5.10. 802.11ax HE20 MODE 2TX IN THE 5.6GHz BAND (FCC+IC).....139

9.5.11. 802.11ax HE40 MODE 2TX IN THE 5.6GHz BAND (FCC+IC).....148

9.5.12. 802.11ax HE80 MODE 2TX IN THE 5.6GHz BAND (FCC+IC).....157

9.5.13. 802.11ax HE20 MODE 2TX IN THE 5.8GHz BAND (FCC+IC).....164

9.5.14. 802.11ax HE40 MODE 2TX IN THE 5.8GHz BAND (FCC+IC).....170

9.5.15. 802.11ax HE80 MODE 2TX IN THE 5.8GHz BAND (FCC+IC).....175

10. RADIATED TEST RESULTS.....180

10.1. TRANSMITTER ABOVE 1 GHz.....182

10.1.1. TX ABOVE 1 GHz 802.11ax HE20 MODE IN THE 5.2GHz BAND.....182

10.1.2. TX ABOVE 1 GHz 802.11ax HE40 MODE IN THE 5.2GHz BAND.....198

10.1.3. TX ABOVE 1 GHz 802.11ax HE80 MODE IN THE 5.2GHz BAND.....210

10.1.4. TX ABOVE 1 GHz 802.11ax HE20 MODE IN THE 5.3GHz BAND.....218

10.1.5. TX ABOVE 1 GHz 802.11ax HE40 MODE IN THE 5.3GHz BAND.....234

10.1.6. TX ABOVE 1 GHz 802.11ax HE80 MODE IN THE 5.3GHz BAND.....246

10.1.7. TX ABOVE 1 GHz 802.11ax HE20 MODE IN THE 5.6GHz BAND.....254

10.1.8. TX ABOVE 1 GHz 802.11ax HE40 MODE IN THE 5.6GHz BAND.....274

10.1.9. TX ABOVE 1 GHz 802.11ax HE80 MODE IN THE 5.6GHz BAND.....294

10.1.10. TX ABOVE 1 GHz 802.11ax HE20 MODE IN THE 5.8GHz BAND.....310

10.1.11. TX ABOVE 1 GHz 802.11ax HE40 MODE IN THE 5.8GHz BAND.....330

10.1.12. TX ABOVE 1 GHz 802.11ax HE80 MODE IN THE 5.8GHz BAND.....346

10.2. WORST CASE BELOW 30MHz358

10.3.	WORST CASE BELOW 1 GHz	359
10.4.	WORST CASE 18-26 GHz	361
10.5.	WORST CASE 26-40 GHz	363
11.	AC POWERLINE CONDUCTED EMISSIONS	365
12.	SETUP PHOTOS:.....	368

1. ATTESTATION OF TEST RESULTS

COMPANY NAME: SONOS INC.
614 Chapala St.
Santa Barbara, CA, 93101, U.S.A.

EUT DESCRIPTION: 802.11 a/b/g/n/ac/ax 2x2 Client Device with BT and BLE

MODEL: S41

BRAND: SONOS

SERIAL NUMBER: Radiated Sample: 528B4 and 6B90A
Conducted Sample: 4304F

SAMPLE RECEIPT DATE: 2022-04-11

DATE TESTED: 2022-04-19 to 2022-05-24

APPLICABLE STANDARDS	
STANDARD	TEST RESULTS
CFR 47 Part 15 Subpart E	Complies
ISED RSS-247 Issue 2	Complies
ISED RSS-GEN Issue 5 + A1 + A2	Complies

UL Verification Services Inc. tested the above equipment in accordance with the requirements set forth in the above standards. The test results show that the equipment tested is capable of demonstrating compliance with the requirements as documented in this report.

The results documented in this report apply only to the tested sample, under the conditions and modes of operation as described herein. It is the manufacturer's responsibility to assure that additional production units of this model are manufactured with identical electrical and mechanical components. All samples tested were in good operating condition throughout the entire test program. Measurement Uncertainties are published for informational purposes only and were not taken into account unless noted otherwise.

This document may not be altered or revised in any way unless done so by UL Verification Services Inc. and all revisions are duly noted in the revisions section. Any alteration of this document not carried out by UL Verification Services Inc. will constitute fraud and shall nullify the document. This report must not be used by the client to claim product certification, approval, or endorsement by A2LA, NIST, any agency of the Federal Government, or any agency of the U.S. government.

Approved & Released For
UL Verification Services Inc. By:

Prepared By:



Francisco de Anda
Staff Engineer
Consumer Technology Division
UL Verification Services Inc.

Glenn Escano
Senior Test Engineer
Consumer Technology Division
UL Verification Services Inc.

1st Reviewed By:

2nd Reviewed By:



Vien Tran
Senior Laboratory Engineer
Consumer Technology Division
UL Verification Services Inc.

Kiya Kedida
Senior Project Engineer
Consumer Technology Division
UL Verification Services Inc.

2. TEST RESULT SUMMARY

This report contains data provided by the customer which can impact the validity of results. UL Verification Services Inc. is only responsible for the validity of results after the integration of the data provided by the customer.

Below is a list of the data provided by the customer:

1. Antenna gain and type (see section 6.3)

FCC Clause	ISED Clause	Requirement	Result	Comment
See Comment		Duty Cycle	Reporting purposes only	Per ANSI C63.10, Section 12.2.
See Comment	RSS-GEN 6.7	26dB BW/99% OBW	Reporting purposes only	Per ANSI C63.10 Sections 6.9.2 and 6.9.3
15.407 (e)	RSS-247 6.2.4.1	6 dB BW	Compliant	None.
15.407 (a) (1-4), (h) (1)	RSS-247 6.2	Output Power	Compliant	None.
15.407 (a) (1-3, 5)	RSS-247 6.2	PSD	Compliant	None.
15.209, 15.205, 15.407 (b)	RSS-GEN 8.9, 8.10, RSS-247 6.2	Radiated Emissions	Compliant	None.
15.207	RSS-Gen 8.8	AC Mains Conducted Emissions	Compliant	None.

3. TEST METHODOLOGY

The tests documented in this report were performed in accordance with:

- FCC CFR 47 Part 2
- FCC CFR 47 Part 15
- FCC KDB 662911 D01 v02r01
- FCC KDB 905462 D02 v02/D03 v01r02/D06 v02
- FCC KDB 789033 D02 v02r01
- KDB 414788 D01 Radiated Test Site v01r01
- ANSI C63.10-2013
- RSS-GEN Issue 5 + A1 + A2
- RSS-247 Issue 2

4. FACILITIES AND ACCREDITATION

UL Verification Services Inc. is accredited by A2LA, Certificate Number #0751.05, for all testing performed within the scope of this report. Testing was performed at the locations noted below.

	Address	ISED CABID	ISED Company Number	FCC Registration
<input checked="" type="checkbox"/>	Building 1: 47173 Benicia Street Fremont, CA 94538, U.S.A	US0104	2324A	208313
<input type="checkbox"/>	Building 2: 47266 Benicia Street Fremont, CA 94538, U.S.A	US0104	22541	208313
<input checked="" type="checkbox"/>	Building 4: 47658 Kato Rd Fremont, CA 94538, U.S.A	US0104	2324B	208313

5. DECISION RULES AND MEASUREMENT UNCERTAINTY

5.1. METROLOGICAL TRACEABILITY

All test and measuring equipment utilized to perform the tests documented in this report are calibrated on a regular basis, with a maximum time between calibrations of one year or the manufacturers' recommendation, whichever is less, and where applicable is traceable to recognized national standards.

5.2. DECISION RULES

The Decision Rule is based on Simple Acceptance in accordance with ISO Guide 98-4:2012 Clause 8.2. (Measurement uncertainty is not taken into account when stating conformity with a specified requirement.)

5.3. MEASUREMENT UNCERTAINTY

Where relevant, the following measurement uncertainty levels have been estimated for tests performed on the apparatus:

PARAMETER	U _{Lab}
Worst Case Conducted Disturbance, 9KHz to 0.15 MHz	3.78 db
Worst Case Conducted Disturbance, 0.15 to 30 MHz	3.40 db
Worst Case Radiated Disturbance, 9KHz to 30 MHz	2.87 db
Worst Case Radiated Disturbance, 30 to 1000 MHz	6.01 db
Worst Case Radiated Disturbance, 1000 to 18000 MHz	4.73 db
Worst Case Radiated Disturbance, 18000 to 26000 MHz	4.51 db
Worst Case Radiated Disturbance, 26000 to 40000 MHz	5.29 db

Uncertainty figures are valid to a confidence level of 95%.

RADIATED EMISSIONS

Where relevant, the following sample calculation is provided:

Field Strength (dBuV/m) = Measured Voltage (dBuV) + Antenna Factor (dB/m) + Cable Loss (dB) – Preamp Gain (dB)

$$36.5 \text{ dBuV} + 18.7 \text{ dB/m} + 0.6 \text{ dB} - 26.9 \text{ dB} = 28.9 \text{ dBuV/m}$$

MAINS CONDUCTED EMISSIONS

Where relevant, the following sample calculation is provided:

Final Voltage (dBuV) = Measured Voltage (dBuV) + Cable Loss (dB) + Limiter Factor (dB) + LISN Insertion Loss.

$$36.5 \text{ dBuV} + 0 \text{ dB} + 10.1 \text{ dB} + 0 \text{ dB} = 46.6 \text{ dBuV}$$

6. EQUIPMENT UNDER TEST

6.1. EUT DESCRIPTION

The EUT is an 802.11 a/b/g/n/ac/ax 2x2 Client Device with BT and BLE.

This report covers ax 5GHz Wifi radio.

6.2. MAXIMUM OUTPUT POWER

The transmitter has a maximum conducted output power as follows:

5.2GHz BAND 802.11 ax MODE 2TX (FCC)

Frequency Range (MHz)	Mode	Output Power (dBm)	Output Power (mW)
5.2 GHz band, 2TX CDD			
5180-5240	802.11ax HE20 SU	18.81	76.03
	802.11ax HE20 OFDMA, 242-Tones	18.83	76.38
	802.11ax HE20 OFDMA, 26-Tones	12.18	16.52
5190-5230	802.11ax HE40 SU	18.24	66.68
	802.11ax HE40 OFDMA, 484-Tones	18.01	63.24
	802.11ax HE40 OFDMA, 26-Tones	13.37	21.73
5210	802.11ax HE80 SU	17.48	55.98
	802.11ax HE80 OFDMA, 996-Tones	17.59	57.41
	802.11ax HE80 OFDMA, 26-Tones	12.58	18.11

5.2GHz BAND 802.11 ax MODE 2TX (IC)

Frequency Range (MHz)	Mode	Output Power (dBm)	Output Power (mW)
5.2 GHz band, 2TX CDD			
5180-5240	802.11ax HE20 SU	16.25	42.17
	802.11ax HE20 OFDMA, 242-Tones	18.25	66.83
	802.11ax HE20 OFDMA, 26-Tones	11.48	14.06
5190-5230	802.11ax HE40 SU	17.97	62.66
	802.11ax HE40 OFDMA, 484-Tones	18.59	72.28
	802.11ax HE40 OFDMA, 26-Tones	10.82	12.08
5210	802.11ax HE80 SU	16.54	45.08
	802.11ax HE80 OFDMA, 996-Tones	18.24	66.68
	802.11ax HE80 OFDMA, 26-Tones	11.77	15.03

5.3GHz BAND 802.11 ax MODE 2TX

Frequency Range (MHz)	Mode	Output Power (dBm)	Output Power (mW)
5.3 GHz band, 2TX CDD			
5260-5320	802.11ax HE20 SU	18.77	75.34
	802.11ax HE20 OFDMA, 242-Tones	18.88	77.27
	802.11ax HE20 OFDMA, 26-Tones	11.26	13.37
5270-5310	802.11ax HE40 SU	17.14	51.76
	802.11ax HE40 OFDMA, 484-Tones	17.17	52.12
	802.11ax HE40 OFDMA, 26-Tones	12.16	16.44
5290	802.11ax HE80 SU	17.50	56.23
	802.11ax HE80 OFDMA, 996-Tones	17.50	56.23
	802.11ax HE80 OFDMA, 26-Tones	11.76	15.00

5.6GHz BAND 802.11 ax MODE 2TX

Frequency Range (MHz)	Mode	Output Power (dBm)	Output Power (mW)
5.6 GHz band, 2TX CDD			
5500-5700	802.11ax HE20 SU	19.17	82.60
	802.11ax HE20 OFDMA, 242-Tones	19.18	82.79
	802.11ax HE20 OFDMA, 26-Tones	11.26	13.37
5510-5670	802.11ax HE40 SU	19.09	81.10
	802.11ax HE40 OFDMA, 484-Tones	19.12	81.66
	802.11ax HE40 OFDMA, 26-Tones	12.50	17.78
5530-5610	802.11ax HE80 SU	18.68	73.79
	802.11ax HE80 OFDMA, 996-Tones	18.99	79.25
	802.11ax HE80 OFDMA, 26-Tones	11.51	14.16

5.8GHz BAND 802.11 ax MODE 2TX

Frequency Range (MHz)	Mode	Output Power (dBm)	Output Power (mW)
5.8 GHz band, 2TX CDD			
5745-5825	802.11ax HE20 SU	20.46	111.17
	802.11ax HE20 OFDMA, 242-Tones	20.68	116.95
	802.11ax HE20 OFDMA, 26-Tones	15.34	34.20
5755-5795	802.11ax HE40 SU	19.29	84.92
	802.11ax HE40 OFDMA, 484-Tones	19.22	83.56
	802.11ax HE40 OFDMA, 26-Tones	16.47	44.36
5775	802.11ax HE80 SU	19.62	91.62
	802.11ax HE80 OFDMA, 996-Tones	19.68	92.90
	802.11ax HE80 OFDMA, 26-Tones	17.04	50.58

6.3. DESCRIPTION OF AVAILABLE ANTENNAS

The antenna gains and type, as provided by the manufacturer are as follows:

The radio utilizes a PCB antenna, with maximum gains as follows:

Frequency Range (MHz)	Peak Antenna Gain (dBi)			
	CHAIN 0		CHAIN 1	
	ANT1 (FR) (Monopole) (dBi)	ANT2 (RL) (Loop) (dBi)	ANT3 (RR) (Loop) (dBi)	ANT4 (FL) (Loop) (dBi)
5150 – 5250	4.1	4.3	4.8	4.9
5250 – 5350	3.5	4.9	4.7	5.6
5500 – 5700	4.4	4.7	5.1	6.2
5725 - 5850	4.8	4.6	4.4	5.7

6.4. SOFTWARE AND FIRMWARE

The EUT firmware installed during testing was 69.1-26251-diaq.

The test utility software used during testing was GUI 20220422_V4.

6.5. TEST REDUCTION CASE

After investigation, the output powers of single user (SU) were lower than full tone and lowest tone. Therefore, the SU was omitted from the testing. See Maximum Output Power section.

6.6. WORST-CASE CONFIGURATION AND MODE

Radiated emissions below 1GHz, above 18GHz, and power line conducted emission were performed with the EUT set to transmit at the channel with highest output power as worst-case scenario.

Band edge and radiated emissions between 1GHz and 18GHz were performed with the EUT set to transmit at the highest power on low, middle, and high channels.

The EUT can only be setup in desktop orientation; therefore, all radiated testing was performed with the EUT in desktop orientation.

The fundamental of the EUT was investigated in the antenna combinations, it was determined that:

_ANT2 and ANT4 was the worst case in the 5.2GHz, 5.3GHz, & 5.6GHz bands.

_ANT1 and ANT4 was the worst case in the 5.8GHz band.

Therefore, all final testing was performed with ANT2 and ANT4 and ANT1 and ANT4 as stated above.

Worst-case data rates as provided by the manufacturer were:

802.11ax HE20mode: MCS0

802.11ax HE40mode: MCS0

802.11ax HE80mode: MCS0

Preliminary Investigation were performed for 802.11ax modes were determined by the following:

- Testing was performed on 802.11ax HE20 26T (Lowest Tones) and 242T (Full Tone) to cover HE20 52T and 106T.
- Testing was performed 802.11ax HE40 26T (Lowest Tones) and 484T (Full Tone) to cover HE40 52T, 106T and 242T.
- Testing was performed 802.11ax HE80 26T (Lowest Tones) and 996T (Full Tone) to cover HE80 52T, 106T, 242T and 484T.

According to Preliminary Investigation, conducted PSD was performed to compare Full RU Tone modes and SU (Single User) Tone modes. It was determined that Full RU Tone modes were worst case over Single User modes in every instance. Therefore, for PSD, only full tone modes were tested, and they represent SU modes as the worst-case scenario

6.7. DESCRIPTION OF TEST SETUP

SUPPORT TEST EQUIPMENT						
Description	Manufacturer	Model	Serial Number	FCC ID/ DoC		
Laptop	Lenovo	T460s	PC0JMBF8	Doc		
Laptop AC/DC Adapter	Lenovo	ADLX90NLC2A	11S45N0247Z1ZSHH448JEY	Doc		
USB-A to Ethernet Adapter	Plugable	USB2-E100	8CAE4CE46AFA	Doc		
USB-C to USB-A Female Adapter	Amazon Basics	L6LUC160-CS-R	N/A	Doc		
I/O CABLES (CONDUCTED TEST)						
Cable No.	Port	# of Identical Ports	Connector Type	Cable Type	Cable Length (m)	Remarks
1	AC	3	AC	Un-shielded	1.25	AC Mains to EUT/Spectrum Analyzer/AC/DC Adapter
2	DC	1	DC	Un-shielded	1	AC/DC Adapter to Laptop
3	Ethernet	1	RJ45	Un-shielded	1.5	Laptop to USB Ethernet Adapter
4	USB-A	1	USB-A	Shielded	0.05	USB EthernetAdapter to USB
5	USB-C	1	USB-C	Shielded	0.05	EUT to USB-C/USB-A Female Adapter
6	SMA Cable	1	SMA	Un-Shielded	0.1	EUT to Spectrum Analyzer
I/O CABLES (RADIATED TEST)						
Cable No.	Port	# of Identical Ports	Connector Type	Cable Type	Cable Length (m)	Remarks
1	AC	3	AC	Un-shielded	1.25	AC Mains to EUT/Spectrum Analyzer/AC/DC Adapter
2	DC	1	DC	Un-shielded	1	AC/DC Adapter to Laptop
3	Ethernet	1	RJ45	Un-shielded	10	Laptop to USB Ethernet Adapter
4	USB-A	1	USB-A	Shielded	0.05	USB EthernetAdapter to USB
5	USB-C	1	USB-C	Shielded	0.05	EUT to USB-C/USB-A Female Adapter
6	SMA Cable	1	SMA	Un-Shielded	10	EUT to Horn Antenna

TEST SETUP

The EUT is a stand-alone unit, and the radio is exercised remotely by Sonos Compliance GUI test utility software via ethernet.

SETUP DIAGRAM

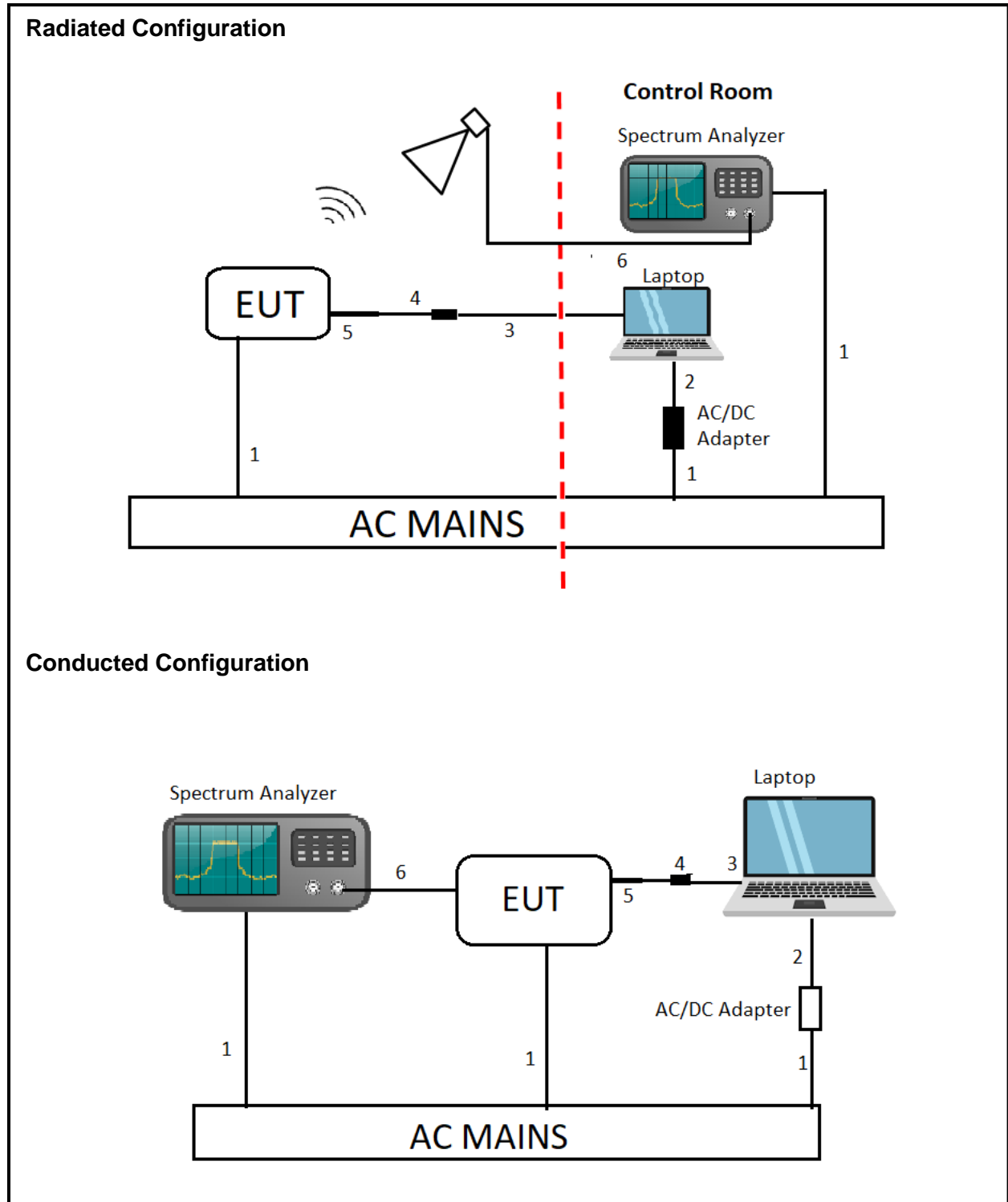

7. MEASUREMENT METHOD

On Time and Duty Cycle: KDB 789033 D02 v02r01, Section B.

6 dB Emission BW: KDB 789033 D02 v02r01, Section C.2

26 dB Emission BW: KDB 789033 D02 v02r01, Section C.1

99% Occupied BW: KDB 789033 D02 v02r01, Section D.

Conducted Output Power: KDB 789033 D02 v02r01, Section E.3.b (Method PM-G) and KDB 789033 D02 v02r01, Section E.2.b (Method SA-1)

Power Spectral Density: KDB 789033 D02 v02r01, Section F

Unwanted emissions in restricted bands: KDB 789033 D02 v02r01, Sections G.3, G.4, G.5, and G.6.

Unwanted emissions in non-restricted bands: KDB 789033 D02 v02r01, Sections G.3, G.4, and G.5.

AC Power Line Conducted Emissions: ANSI C63.10-2013, Section 6.2.

Radiated Spurious Emissions Below 30MHz: ANSI C63.10-2013 Section 6.4

8. TEST AND MEASUREMENT EQUIPMENT

The following test and measurement equipment was utilized for the tests documented in this report:

TEST EQUIPMENT LIST					
Description	Manufacturer	Model	ID Num	Cal Due	Last Cal
Antenna, Broadband Hybrid, 30MHz to 3GHz	Sunol Sciences Corp.	JB3	171862	2022-09-28	2021-09-28
Amplifier, 10KHz to 1GHz, 32dB	SONOMA INSTRUMENT	310N	29654	2023-04-24	2022-04-24
Antenna, Horn 1-18GHz	ETS-Lindgren (Cedar Park, Texas)	3117	80404	2022-08-04*	2021-08-04
Antenna, Horn 1-18GHz	ETS-Lindgren (Cedar Park, Texas)	3117	T119	2022-05-07	2021-05-07
Amplifier, 100MHz - 18GHz	AMPLICAL	AMP0.1G18-47-20	185686	2022-04-09	2021-04-09
RF Filter Box, 1-18GHz	FREMONT	SAC-L1	171013	2023-03-09	2022-03-09
EMI TEST RECEIVER,	Rohde & Schwarz	ESW44	PRE0179367	2023-02-16	2022-02-16
EMI TEST RECEIVER, with B8 option	Rohde & Schwarz	ESW44	PRE0179377	2023-02-20	2022-02-20
EMI TEST RECEIVER	Rohde & Schwarz	ESW44	201499	2023-02-17	2022-02-17
Antenna, Horn 18 to 26.5GHz	ARA	MWH-1826/B	172363	2022-12-07	2021-12-07
Antenna, Horn 26 to 40GHz	ARA	MWH-2640/B	172366	2022-12-07	2021-12-07
Amplifier 18-26.5GHz, +5Vdc, -54dBm P1dB	AMPLICAL	AMP18G26.5-60	171583	2023-01-27	2022-01-27
Amplifier 26-40GHz +5Vdc, -62dBm P1dB	AMPLICAL	AMP26G40-65	172346	2023-02-01	2022-02-01
Antenna, Passive Loop 30Hz - 1MHz	ELECTRO METRICS	EM-6871	SC-8015	2022-05-24	2021-05-24
Antenna, Passive Loop 100KHz - 30MHz	ELECTRO METRICS	EM-6872	SC-8014	2022-05-24	2021-05-24
Spectrum Analyzer, PXA, 3Hz to 44GHz	Agilent Technologies	N9030A	80396	2023-01-02	2021-01-02
Power Meter, P-series single channel	Keysight Technologies Inc	N1911A	90719	2023-01-24	2022-01-24
Power Sensor, P - series, 50MHz to 18GHz, Wideband	Keysight Technologies Inc	N1921A	T1223	2023-03-02	2022-03-02
Power Meter, P-series single channel	Keysight Technologies Inc	N1911A	T1268	2023-02-03	2022-02-03
Power Sensor, P - series, 50MHz to 18GHz, Wideband	Keysight Technologies Inc	N1921A	90419	2023-03-02	2022-03-02
AC Line Conducted					
LISN	Fischer Custom Communications, Inc	FCC-LISN-50/250-25-2-01-480V	175765	2023-01-26	2022-01-26
EMI TEST RECEIVER	Rohde & Schwarz	ESR	93091	2023-02-21	2022-02-21
Transient Limiter	TE	TBFL1	207996	2022-06-01	2021-06-01
UL TEST SOFTWARE LIST					
Radiated Software	UL	UL EMC	Ver 2016-05-11, 2015-12-29, 2019-10-09, 2021-12-07, 2022-05-18, and 2022-07-06		
Antenna Port Software	UL	UL RF	Ver 2022.8.16		
AC Line Conducted Software	UL	UL EMC	Rev 9.5, 2022-02-17		

*Test performed before calibration expired.

9. ANTENNA PORT TEST RESULTS

9.1. ON TIME AND DUTY CYCLE

LIMITS

None; for reporting purposes only.

PROCEDURE

KDB 558074 D01 Zero-Span Spectrum Analyzer Method.

Test Engineer:	AF19419 & ZS 16080
Test Date:	4/19/, 4/26, & 4/29/2022

ON TIME AND DUTY CYCLE RESULTS

Mode	ON Time B (msec)	Period (msec)	Duty Cycle x (linear)	Duty Cycle (%)	Duty Cycle Correction Factor (dB)	1/B Minimum VBW (kHz)
802.11ax HE20 OFDMA, SU	1.072	1.470	0.729	72.93	1.37	0.933
802.11ax HE20 OFDMA, RU size 242T	0.377	0.737	0.512	51.17	2.91	2.653
802.11ax HE20 OFDMA, RU size 26T	0.578	0.921	0.628	62.82	2.02	1.729
802.11ax HE40 OFDMA, SU	0.567	0.942	0.601	60.14	2.21	1.765
802.11ax HE40 OFDMA, RU size 484T	0.369	0.726	0.508	50.83	2.94	2.710
802.11ax HE40 OFDMA, RU size 26T	0.582	0.924	0.630	63.03	2.00	1.717
802.11ax HE80 OFDMA, SU	0.307	0.674	0.455	45.47	3.42	3.263
802.11ax HE80 OFDMA, RU size 996T	0.345	0.729	0.473	47.33	3.25	2.899
802.11ax HE80 OFDMA, RU size 26T	0.579	0.912	0.635	63.49	1.97	1.727

DUTY CYCLE PLOTS



802.11ax HE20 OFDMA, OFDMA MODE: SU



802.11ax HE20 OFDMA, RU size 242T MODE



802.11ax HE20 OFDMA, RU size 26T MODE



802.11ax HE40 OFDMA, OFDMA MODE: SU

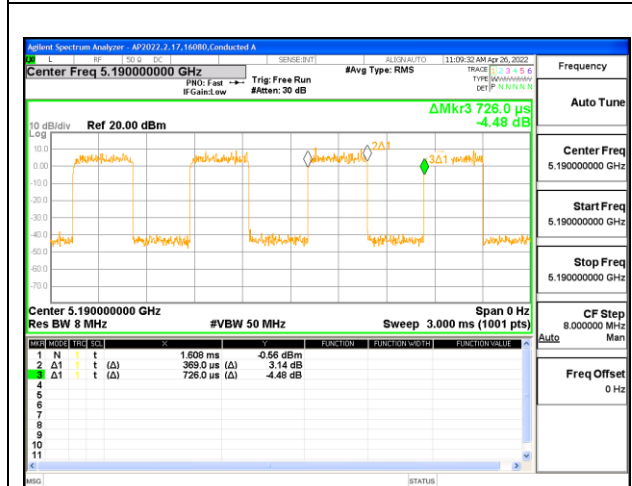

802.11ax HE40 OFDMA, RU size 484T MODE

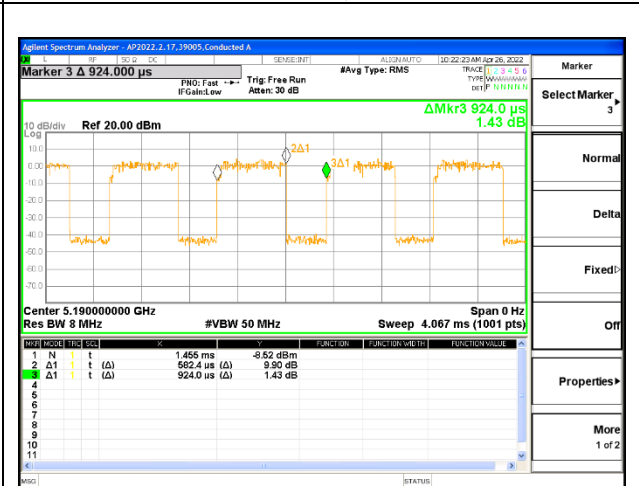

802.11ax HE40 OFDMA, RU size 26T MODE

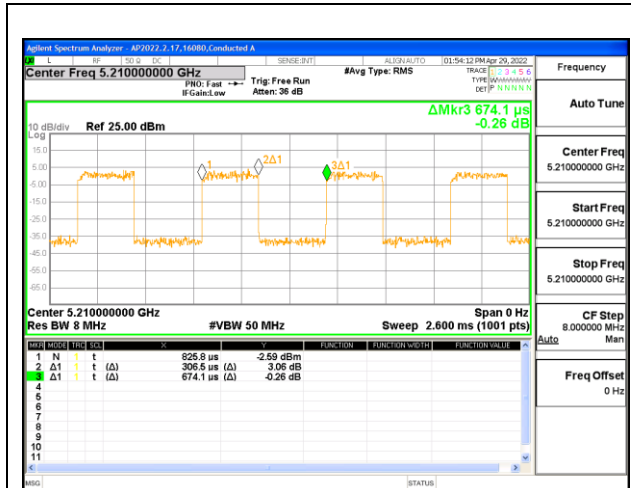

802.11ax HE80 OFDMA, OFDMA MODE: SU



802.11ax HE80 OFDMA, RU size 996T MODE



802.11ax HE80 OFDMA, RU size 26T MODE

Intentionally Left Blank

9.2. 26 dB BANDWIDTH

LIMITS

None; for reporting purposes only.

RESULTS

9.2.1. 802.11ax HE20 MODE 2TX IN THE 5.2GHz BAND

2TX Antenna 2 + Antenna 4 CDD OFDMA MODE: 242-Tones, RU Index 61

Channel	Frequency (MHz)	26 dB Bandwidth Antenna 2 (MHz)	26 dB Bandwidth Antenna 4 (MHz)
Low	5180	23.04	23.00
Mid	5200	22.92	22.76
High	5240	23.04	23.04

LOW CHANNEL

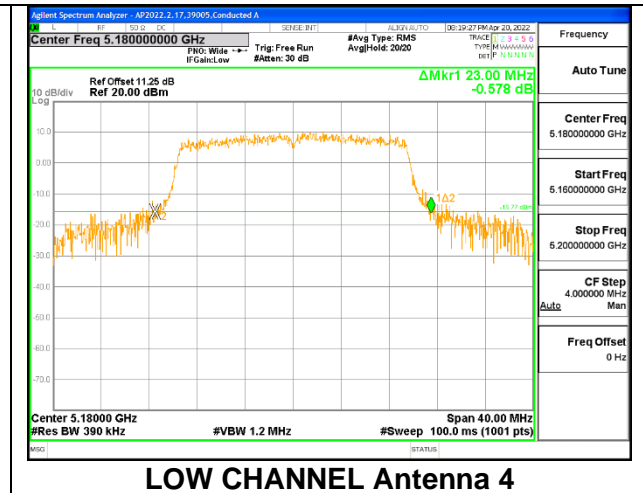
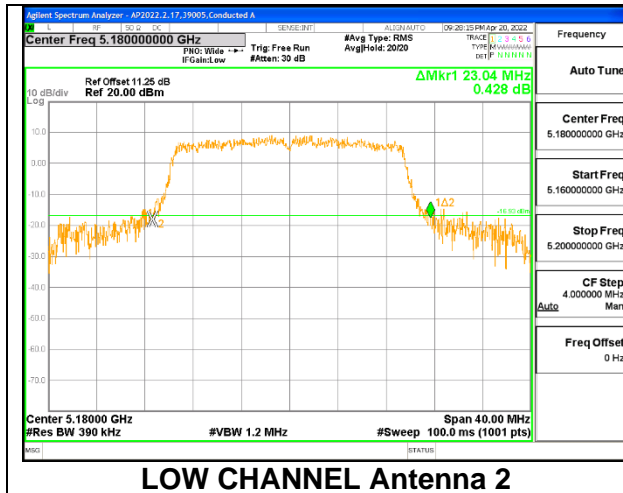

MID CHANNEL

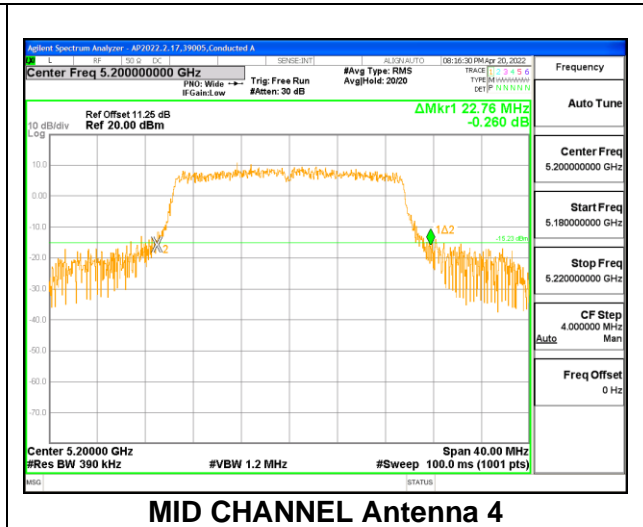
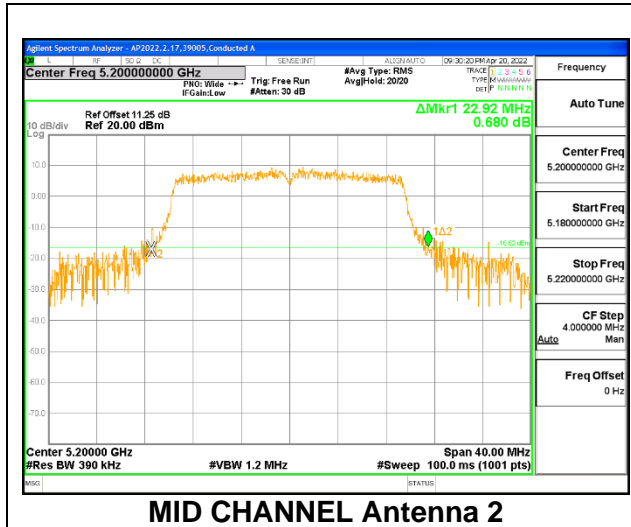

HIGH CHANNEL

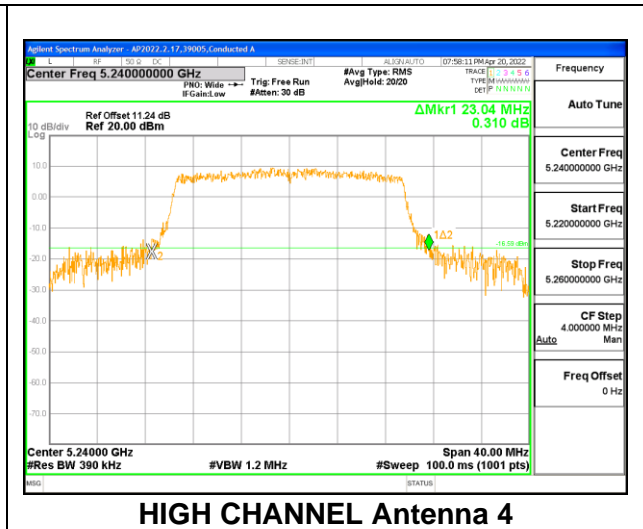
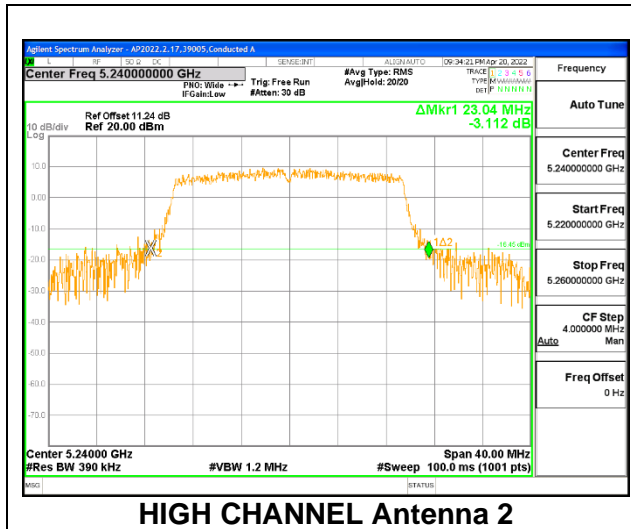

9.2.2. 802.11ax HE40 MODE 2TX IN THE 5.2GHZ BAND

2TX Antenna 2 + Antenna 4 CDD OFDMA MODE: 484-Tones, RU Index 65

Channel	Frequency (MHz)	26 dB Bandwidth Antenna 2 (MHz)	26 dB Bandwidth Antenna 4 (MHz)
Low	5190	40.16	40.08
High	5230	40.08	40.08

LOW CHANNEL

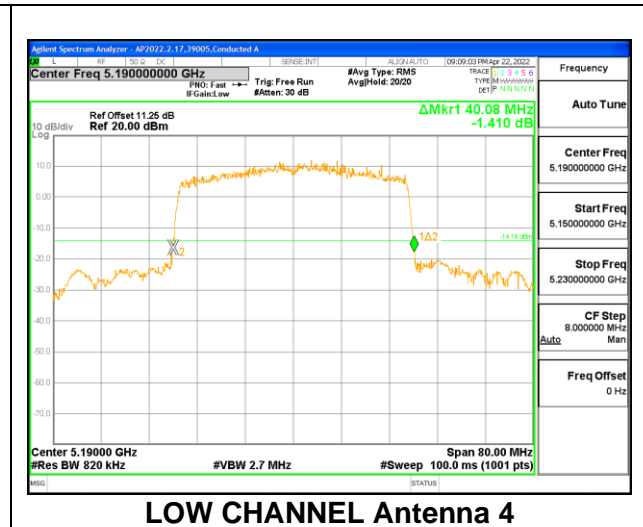
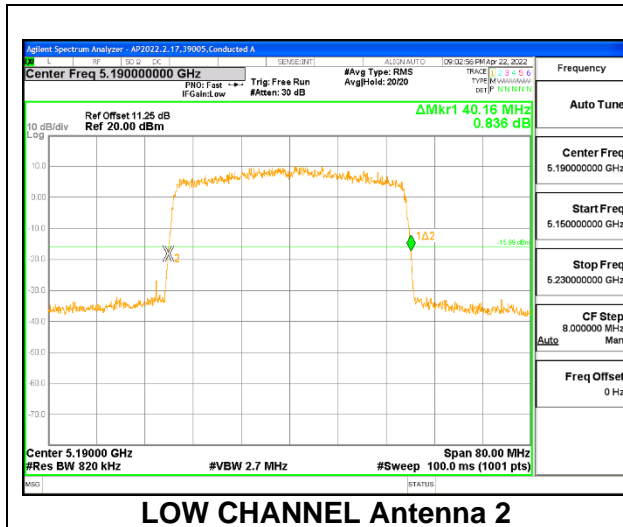

HIGH CHANNEL

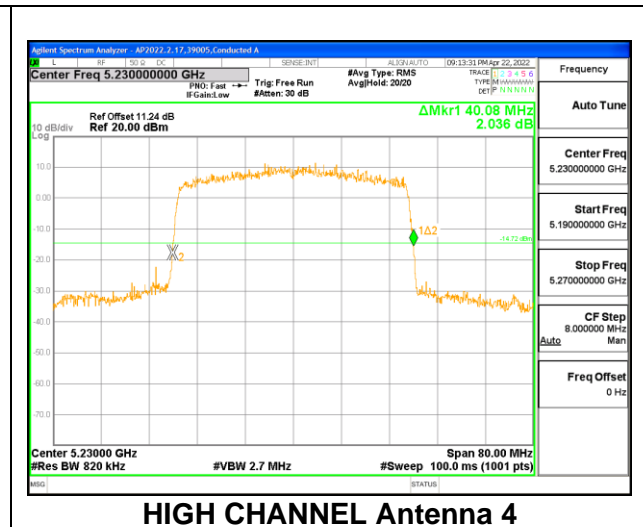
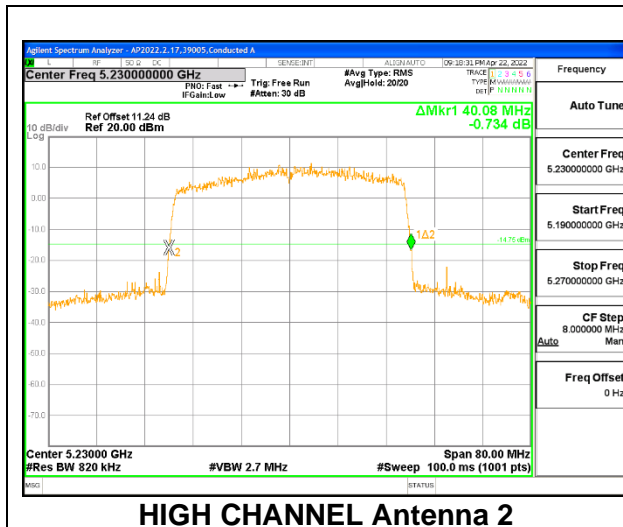

9.2.3. 802.11ax HE80 MODE 2TX IN THE 5.2GHz BAND

2TX Antenna 2 + Antenna 4 CDD OFDMA MODE: 996-Tones, RU Index 67

Channel	Frequency (MHz)	26 dB Bandwidth Antenna 2 (MHz)	26 dB Bandwidth Antenna 4 (MHz)
Mid	5210	81.60	81.28

MID CHANNEL

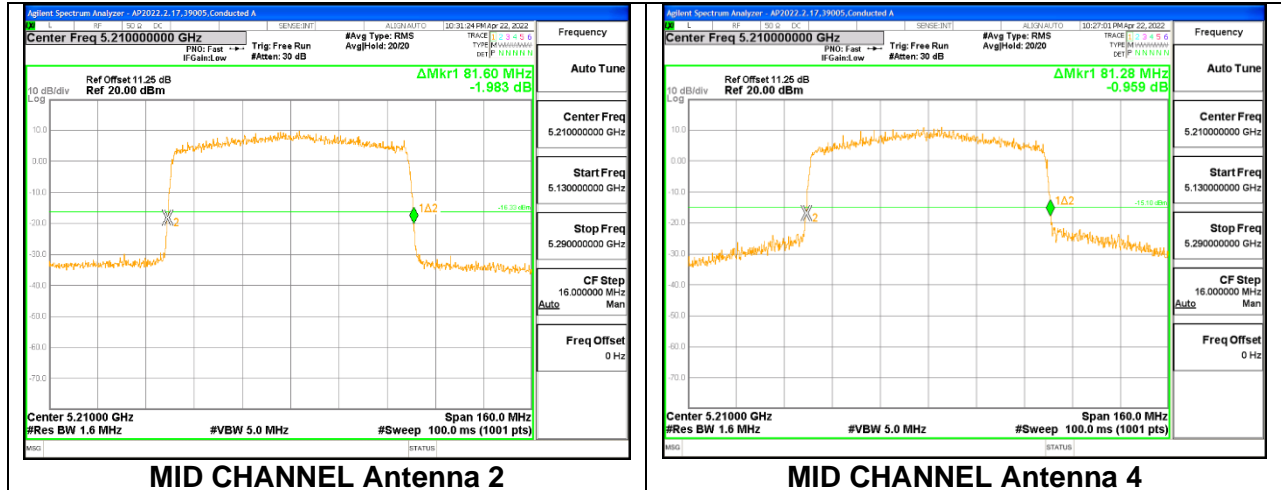

9.2.4. 802.11ax HE20 MODE 2TX IN THE 5.3GHz BAND

2TX Antenna 2 + Antenna 4 CDD OFDMA MODE: 242-Tones, RU Index 61

Channel	Frequency (MHz)	26 dB Bandwidth Antenna 2 (MHz)	26 dB Bandwidth Antenna 4 (MHz)
Low	5260	23.08	22.72
Mid	5300	22.52	22.78
High	5320	22.96	23.04

LOW CHANNEL

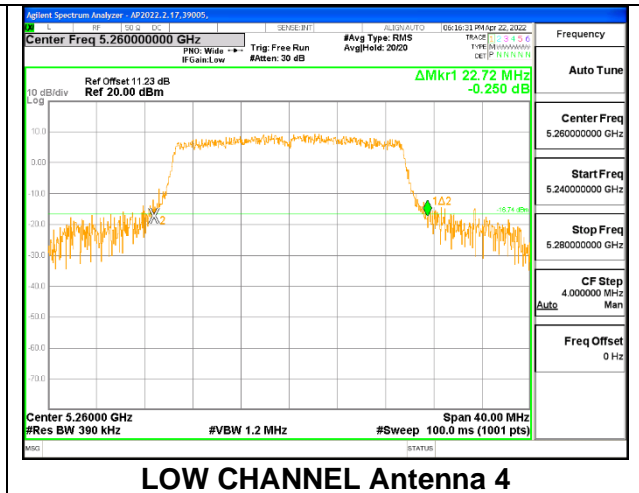
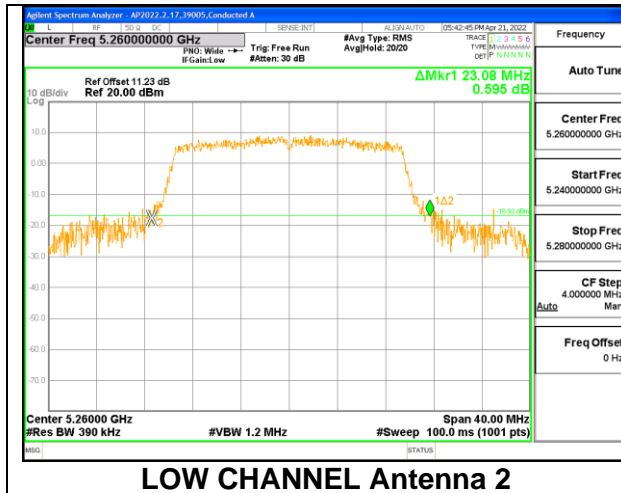

MID CHANNEL

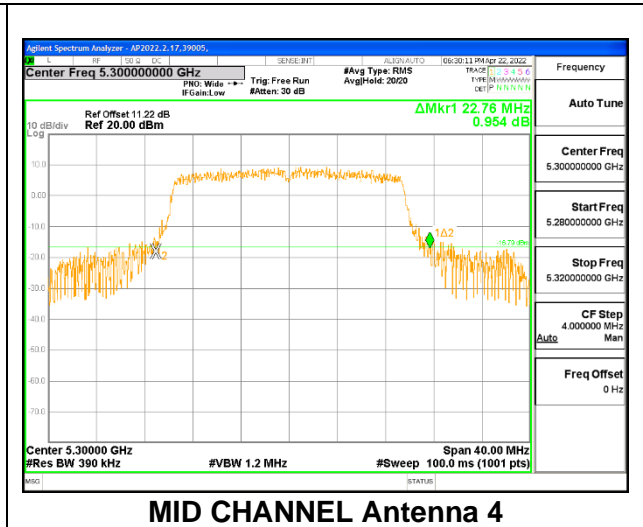
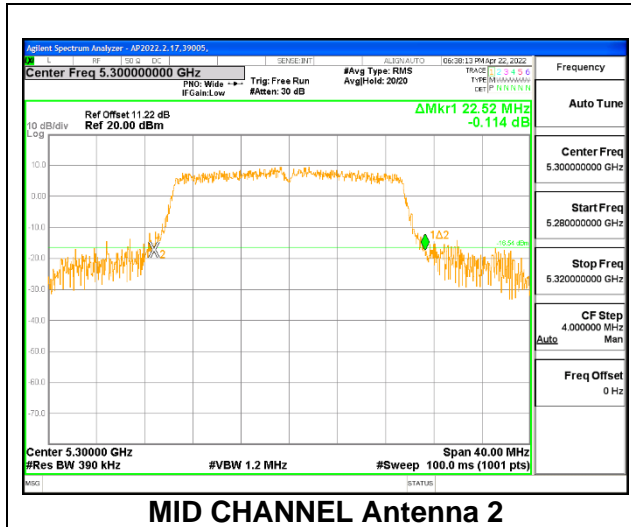

HIGH CHANNEL

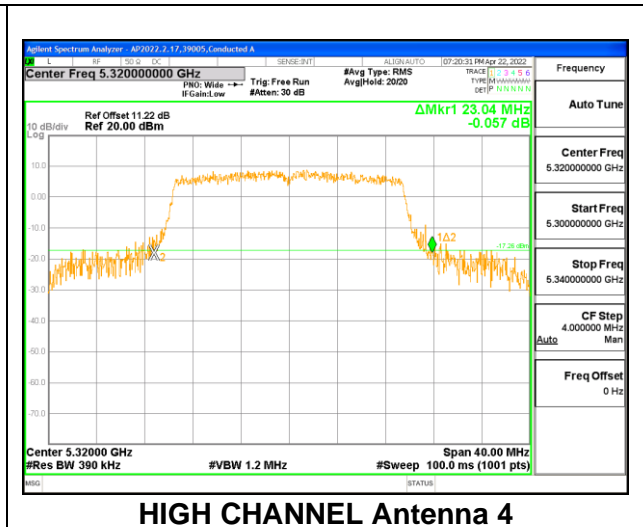
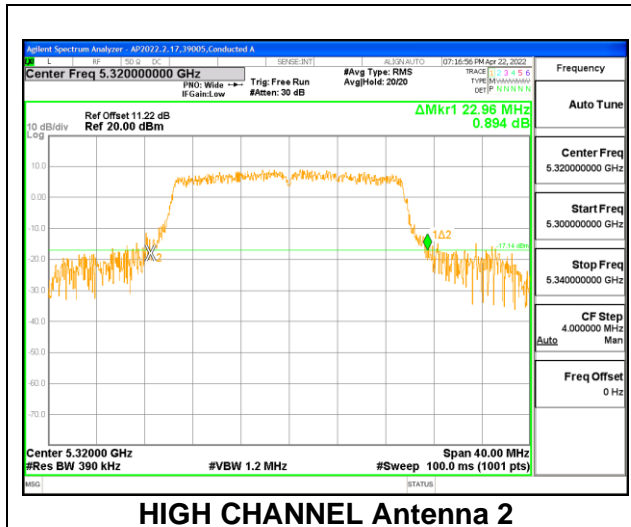

9.2.5. 802.11ax HE40 MODE 2TX IN THE 5.3GHZ BAND

2TX Antenna 2 + Antenna 4 CDD OFDMA MODE: 484-Tones, RU Index 65

Channel	Frequency (MHz)	26 dB Bandwidth Antenna 2 (MHz)	26 dB Bandwidth Antenna 4 (MHz)
Low	5270	40.16	40.00
High	5310	39.92	40.00

LOW CHANNEL

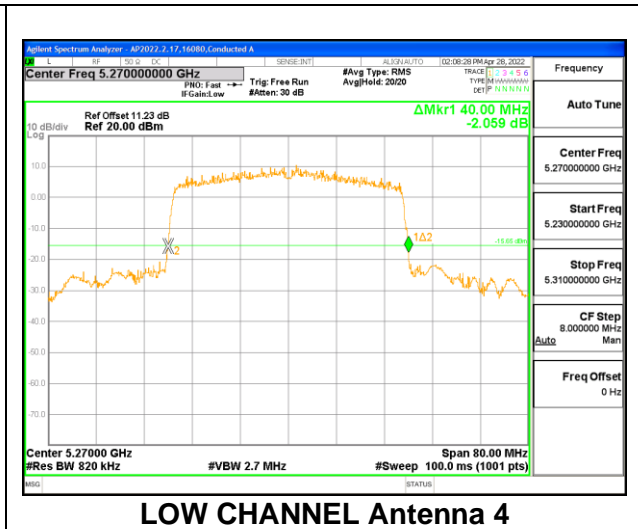
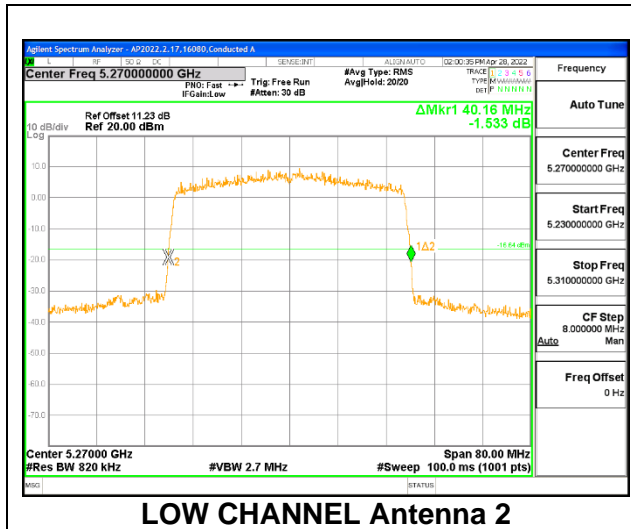

HIGH CHANNEL

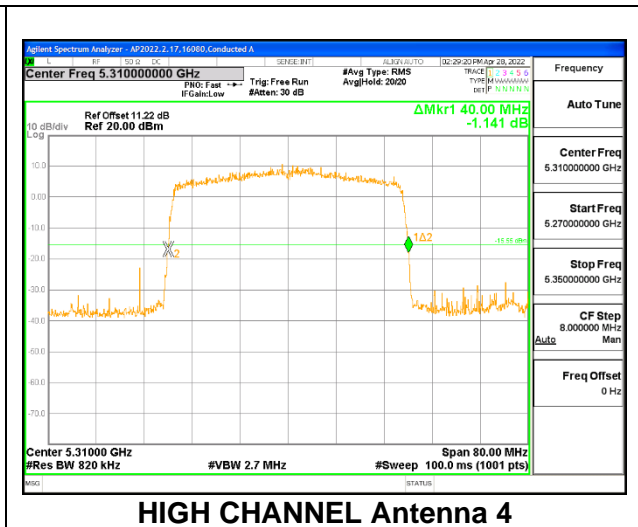
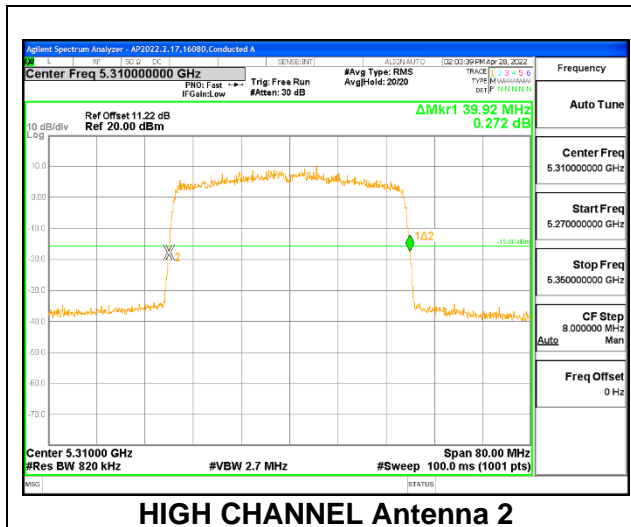

9.2.6. 802.11ax HE80 MODE 2TX IN THE 5.3GHz BAND

2TX Antenna 2 + Antenna 4 CDD OFDMA MODE: 996-Tones, RU Index 67

Channel	Frequency (MHz)	26 dB Bandwidth Antenna 2 (MHz)	26 dB Bandwidth Antenna 4 (MHz)
Mid	5290	81.44	81.60

MID CHANNEL

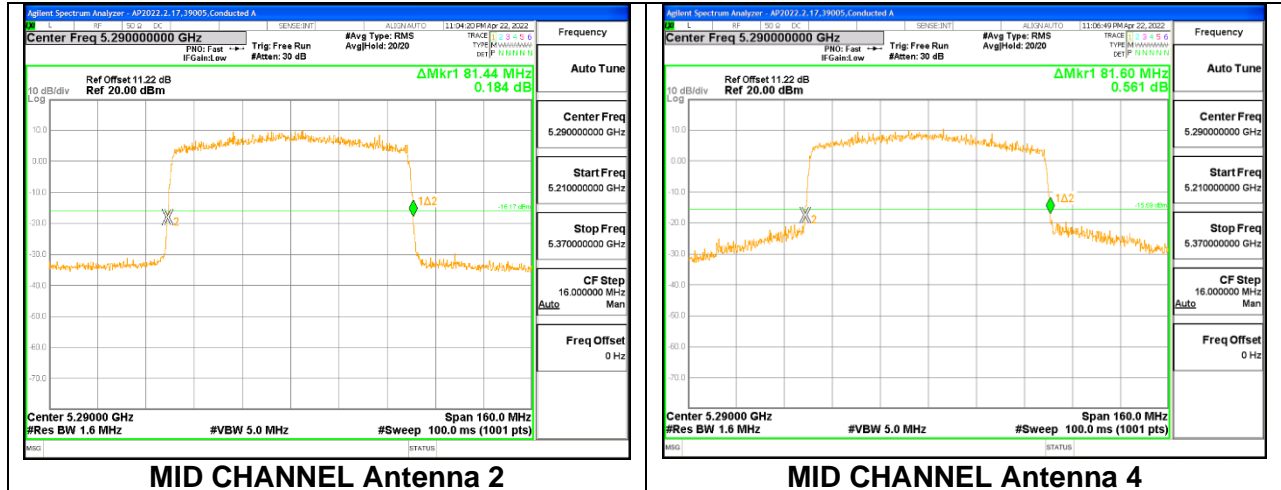

9.2.7. 802.11ax HE20 MODE 2TX IN THE 5.6GHz BAND

2TX Antenna 2 + Antenna 4 CDD OFDMA MODE: 242-Tones, RU Index 61

Channel	Frequency (MHz)	26 dB Bandwidth Antenna 2 (MHz)	26 dB Bandwidth Antenna 4 (MHz)
Low	5500	23.04	23.08
Mid	5580	22.80	22.88
High	5700	22.80	22.92

LOW CHANNEL

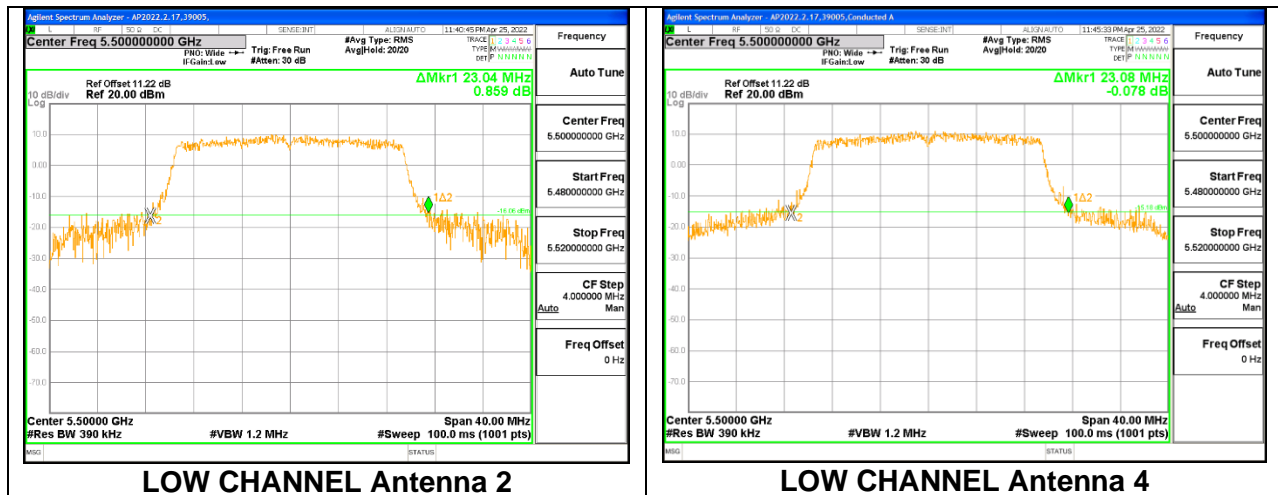

MID CHANNEL

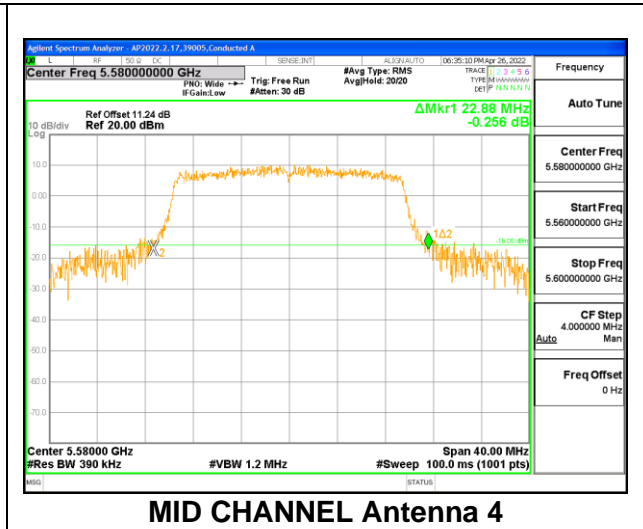
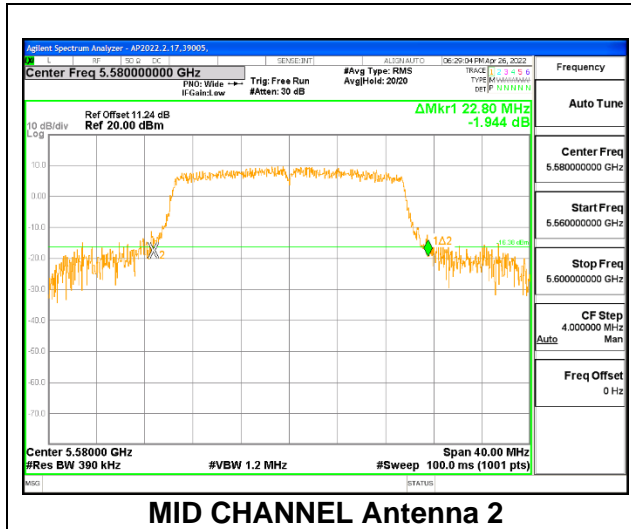

HIGH CHANNEL

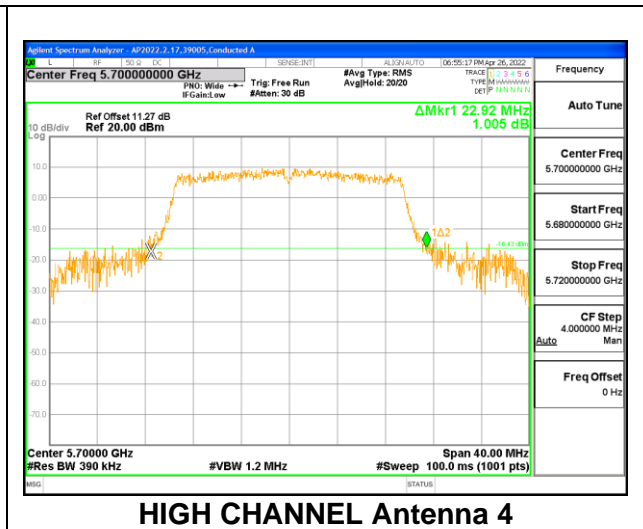
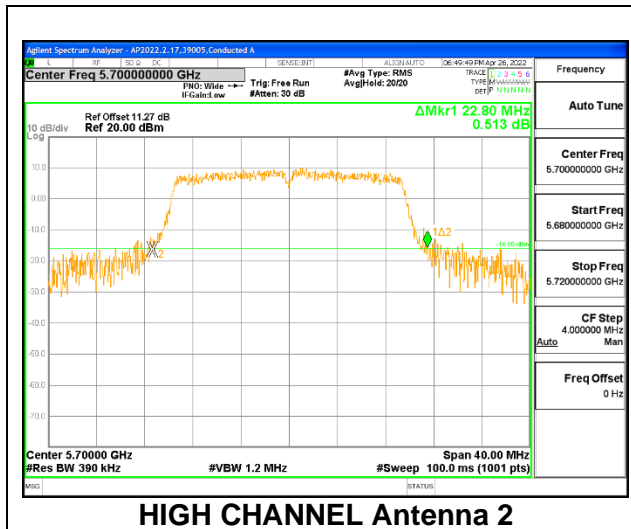

9.2.8. 802.11ax HE40 MODE 2TX IN THE 5.6GHz BAND

2TX Antenna 2 + Antenna 4 CDD OFDMA MODE: 484-Tones, RU Index 65

Channel	Frequency (MHz)	26 dB Bandwidth Antenna 2 (MHz)	26 dB Bandwidth Antenna 4 (MHz)
Low	5510	40.08	40.16
Mid	5550	40.08	40.16
High	5670	40.16	40.56

LOW CHANNEL

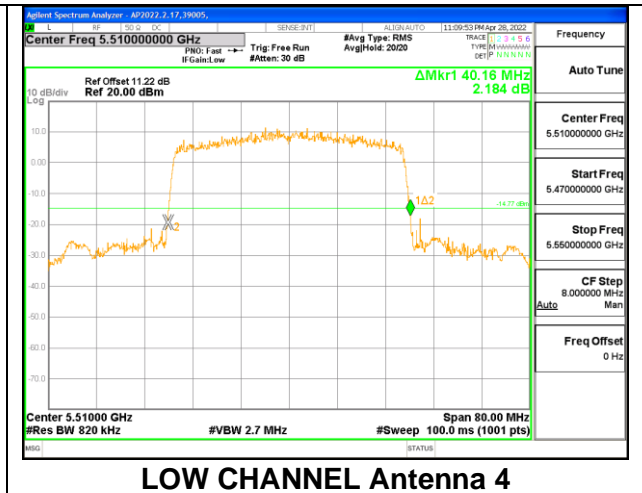
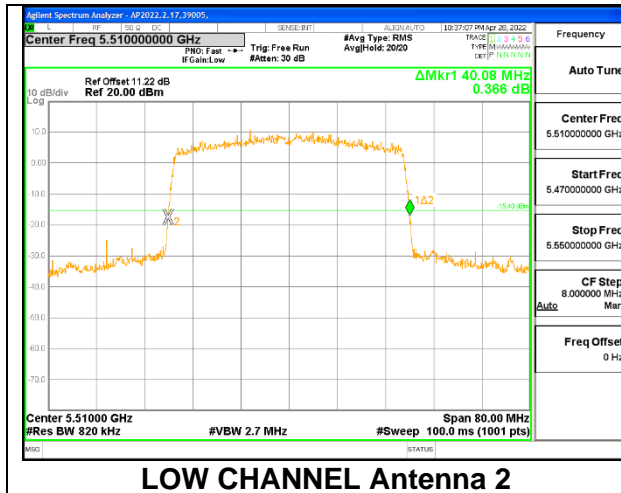

MID CHANNEL

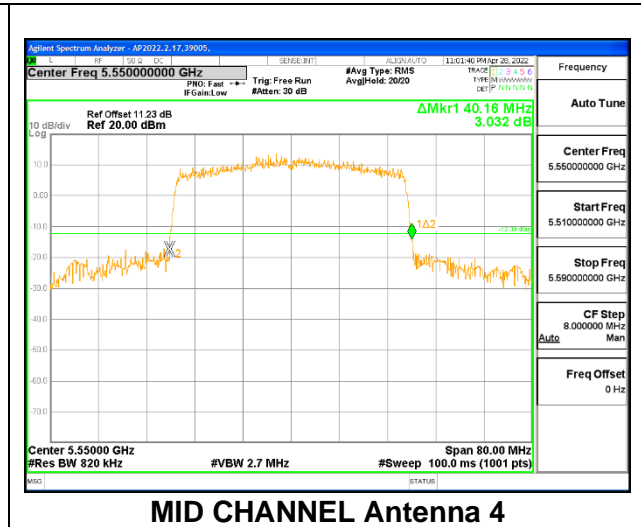
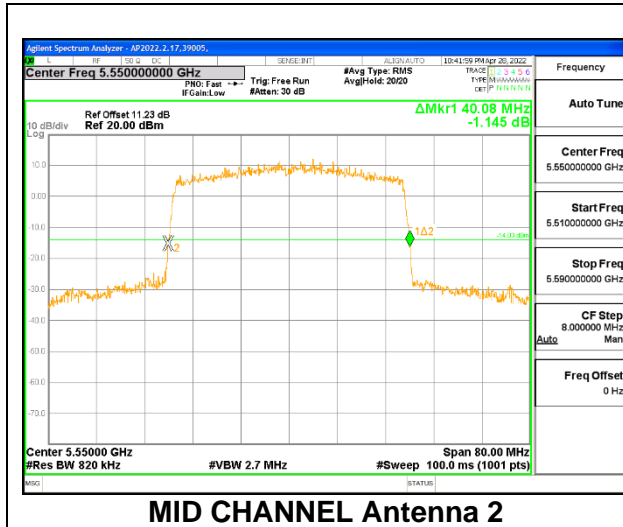

HIGH CHANNEL

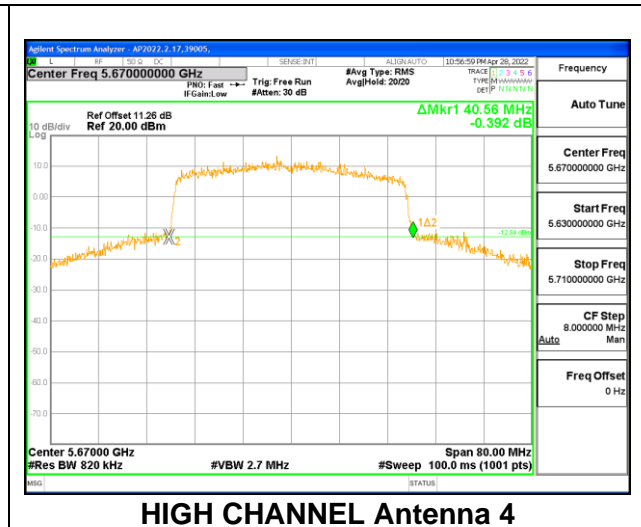
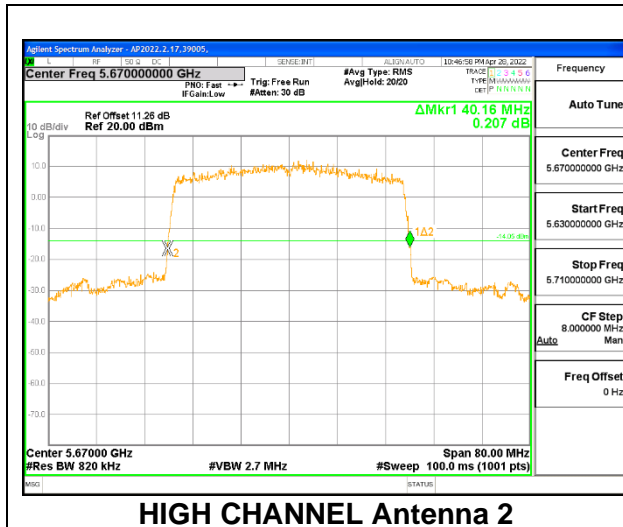

9.2.9. 802.11ax HE80 MODE 2TX IN THE 5.6GHZ BAND

2TX Antenna 2 + Antenna 4 CDD OFDMA MODE: 996-Tones, RU Index 67

Channel	Frequency (MHz)	26 dB Bandwidth Antenna 2 (MHz)	26 dB Bandwidth Antenna 4 (MHz)
Low	5530	81.44	81.60
High	5610	81.60	81.44

LOW CHANNEL

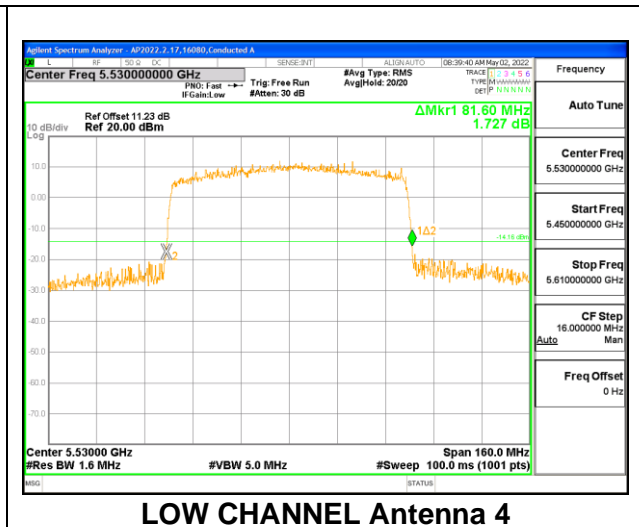
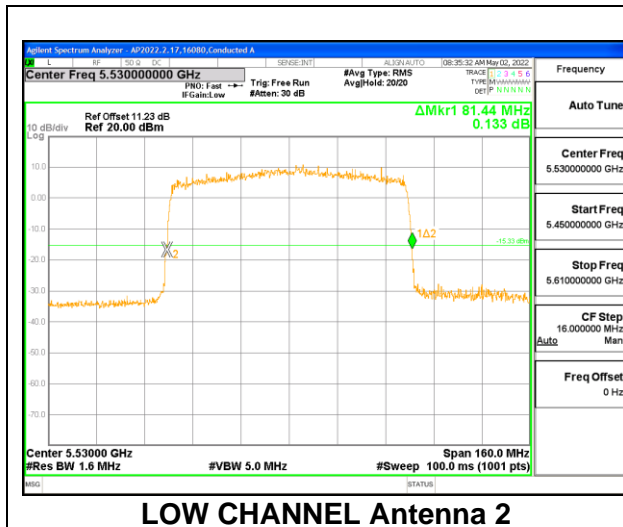

HIGH CHANNEL

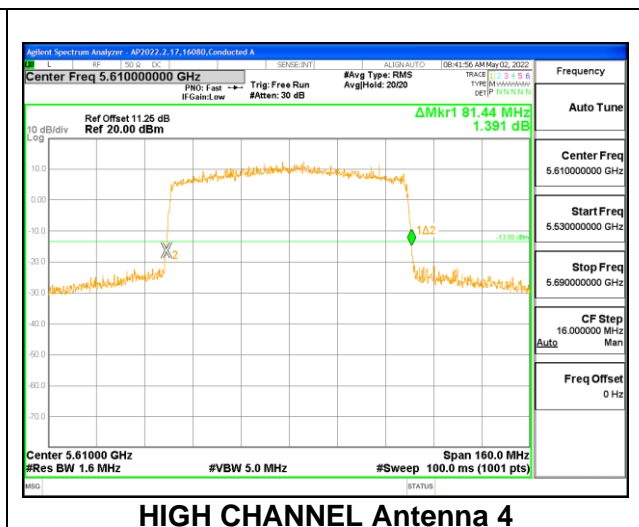
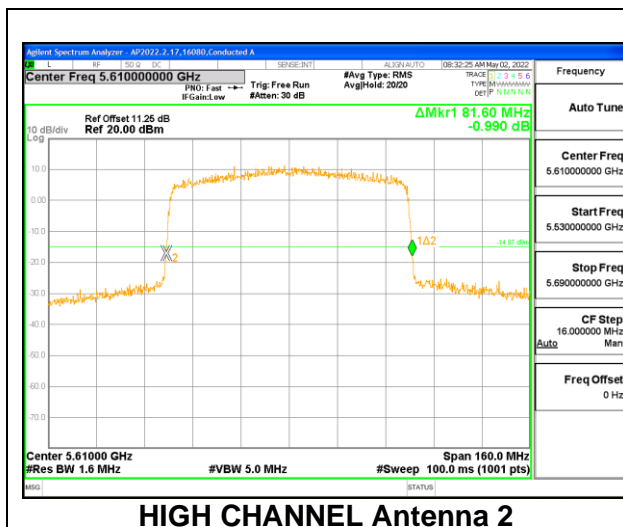

9.2.10. 802.11ax HE20 MODE 2TX IN THE 5.8GHz BAND

2TX Antenna 1 + Antenna 4 CDD OFDMA MODE: 242-Tones, RU Index 61

Channel	Frequency (MHz)	26 dB Bandwidth Antenna 1 (MHz)	26 dB Bandwidth Antenna 4 (MHz)
Low	5745	23.28	22.36
Mid	5785	22.60	22.20
High	5825	21.96	22.20

LOW CHANNEL

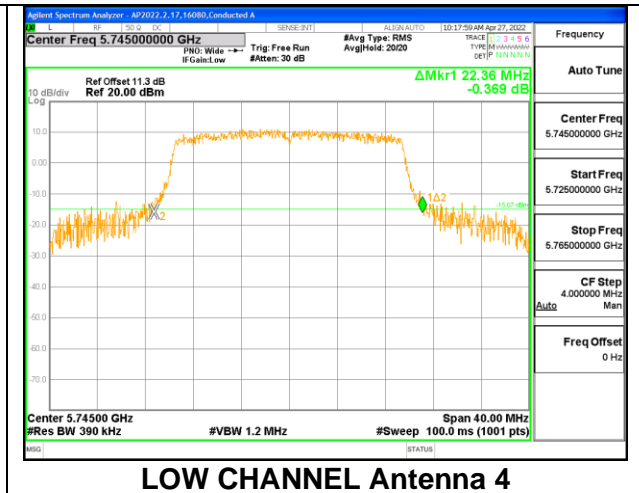
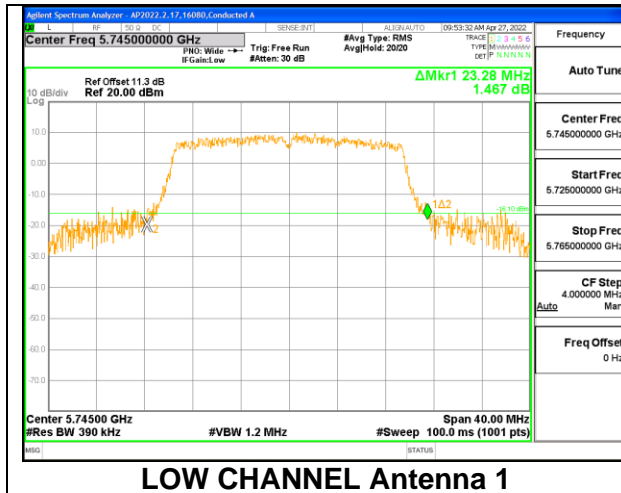

MID CHANNEL

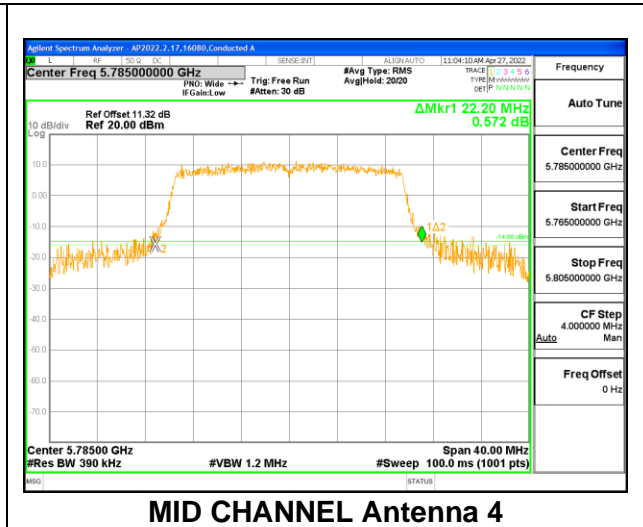
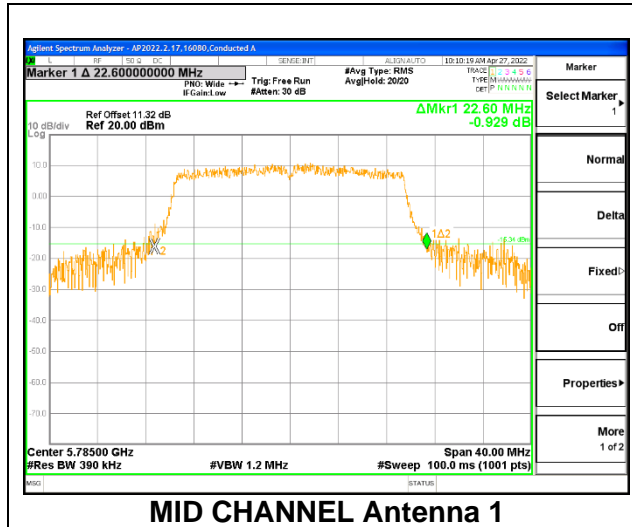

HIGH CHANNEL

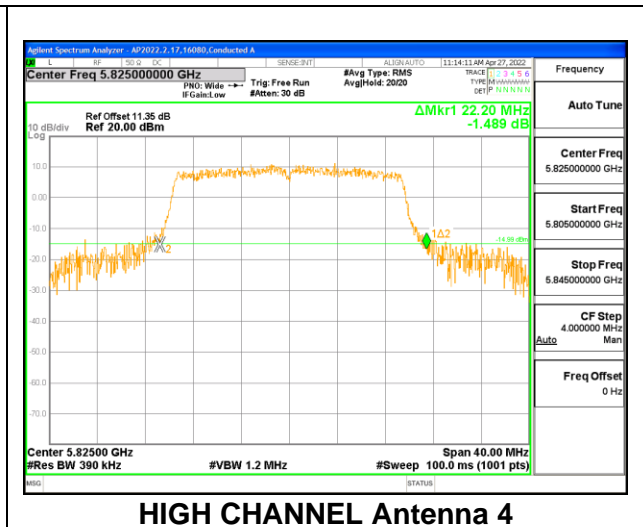
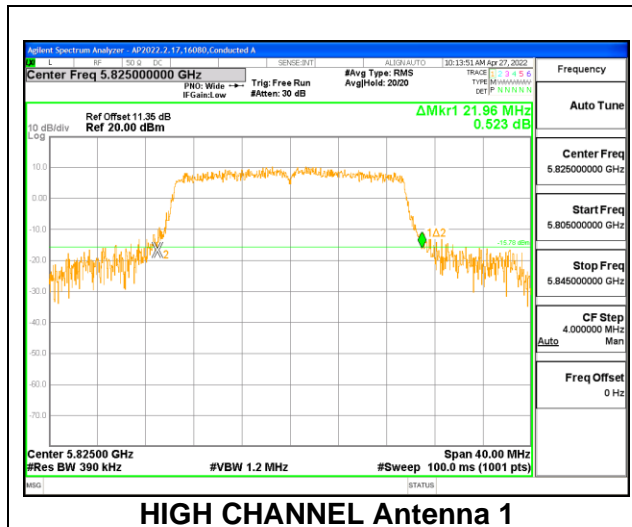

9.2.11. 802.11ax HE40 MODE 2TX IN THE 5.8GHz BAND

2TX Antenna 1 + Antenna 4 CDD OFDMA MODE: 484-Tones, RU Index 65

Channel	Frequency (MHz)	26 dB Bandwidth Antenna 1 (MHz)	26 dB Bandwidth Antenna 4 (MHz)
Low	5755	40.08	40.08
High	5795	40.08	40.08

LOW CHANNEL

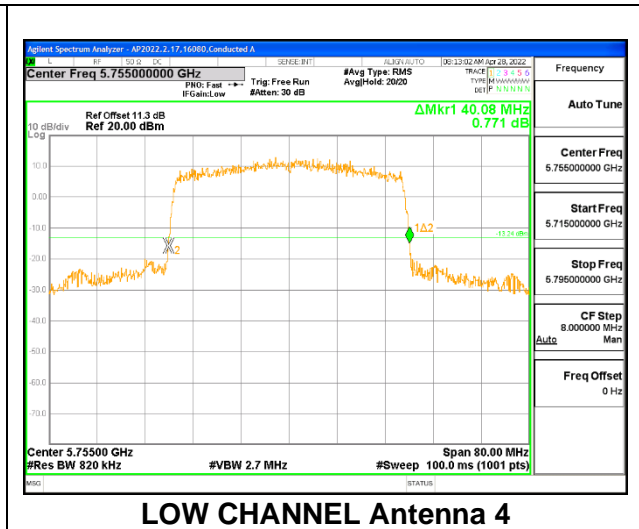
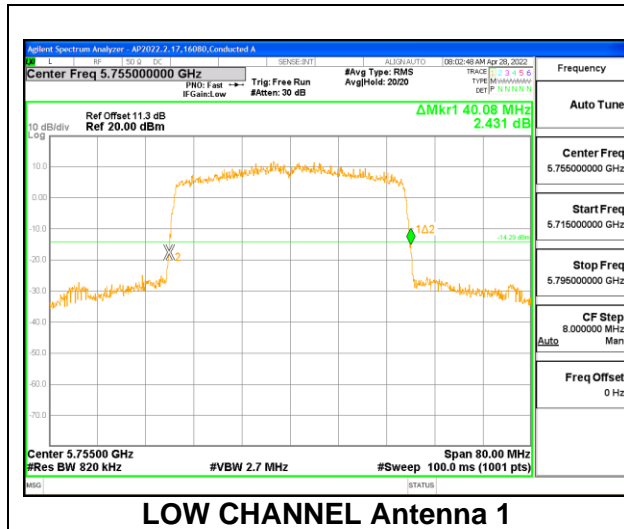

HIGH CHANNEL

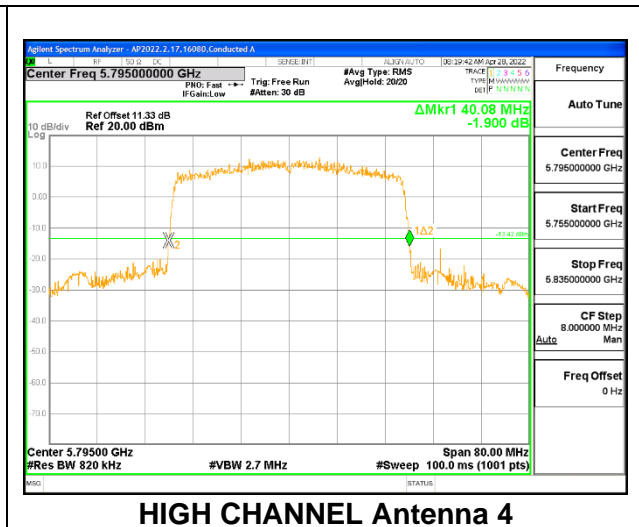
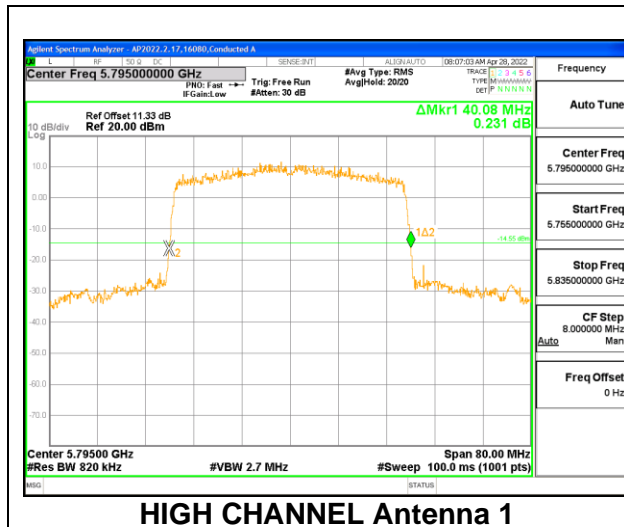

9.2.12. 802.11ax HE80 MODE 2TX IN THE 5.8GHz BAND

2TX Antenna 1 + Antenna 4 CDD OFDMA MODE: 996-Tones, RU Index 67

Channel	Frequency (MHz)	26 dB Bandwidth Antenna 1 (MHz)	26 dB Bandwidth Antenna 4 (MHz)
High	5795	80.16	80.00

MID CHANNEL

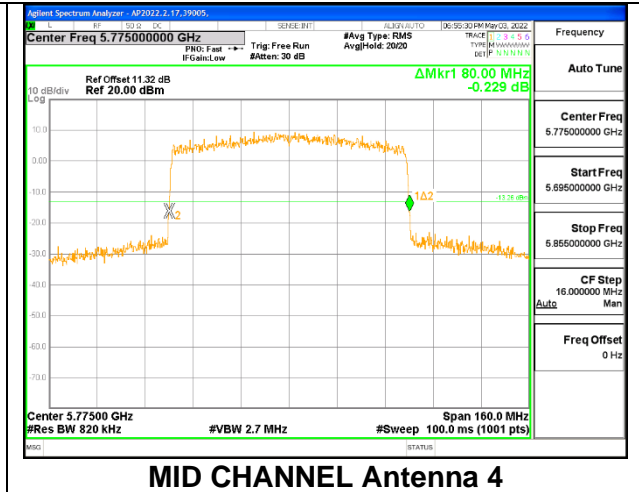
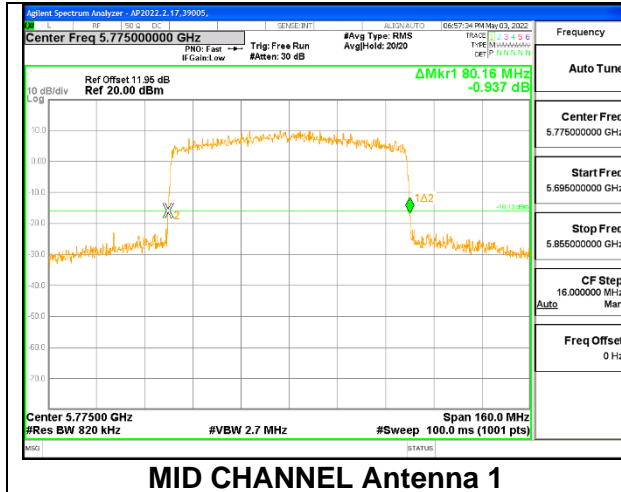

9.3. 99% BANDWIDTH

LIMITS

None; for reporting purposes only.

RESULTS

9.3.1. 802.11ax HE20 MODE 2TX IN THE 5.2GHz BAND

2TX Antenna 2 + Antenna 4 CDD OFDMA MODE: 242-Tones, RU Index 61

Channel	Frequency (MHz)	99% Bandwidth Antenna 2 (MHz)	99% Bandwidth Antenna 4 (MHz)
Low	5180	18.899	18.908
Mid	5200	18.893	19.010
High	5240	18.956	18.930

LOW CHANNEL

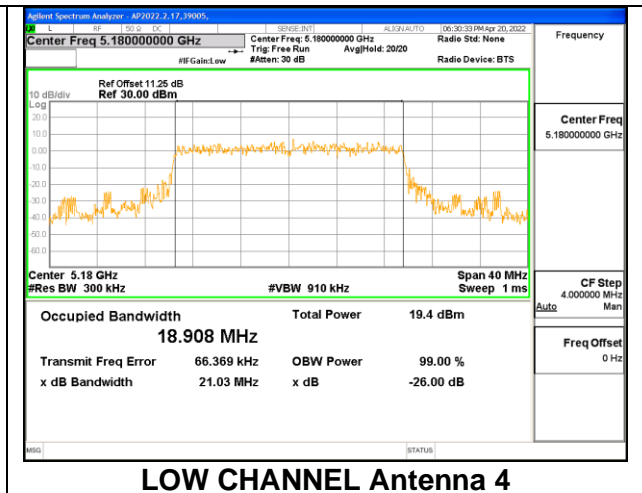
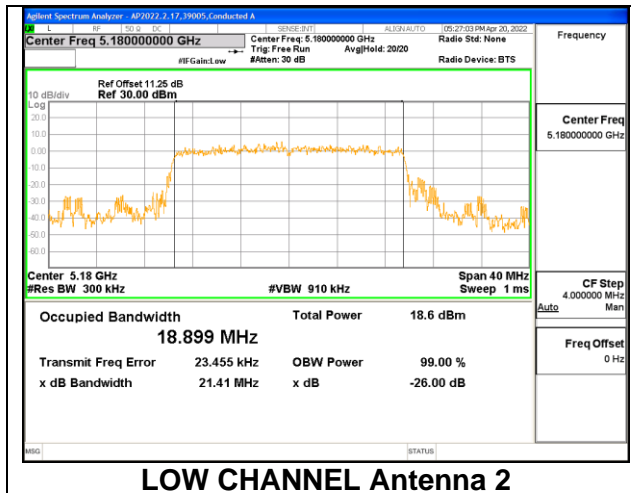

MID CHANNEL

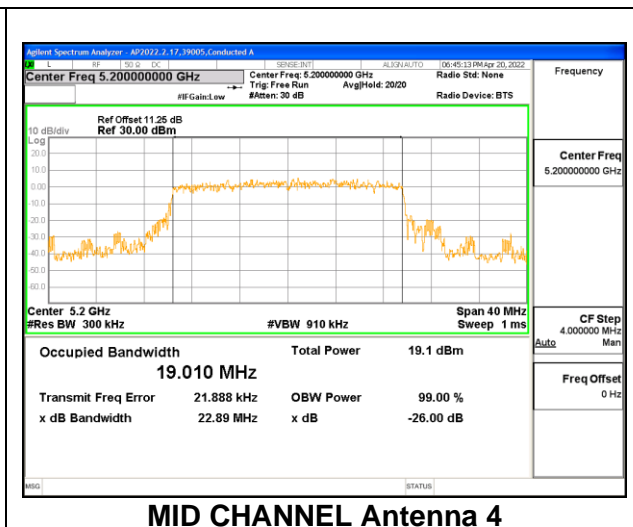
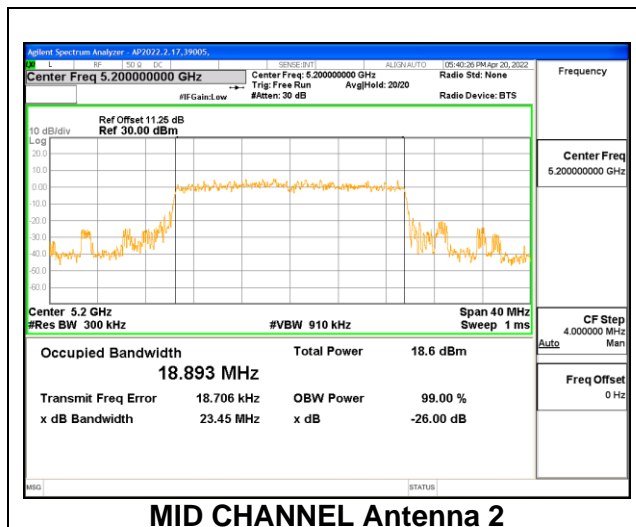

HIGH CHANNEL

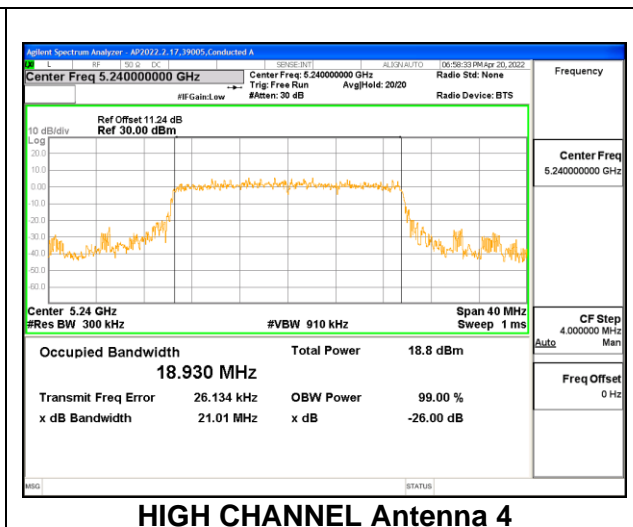
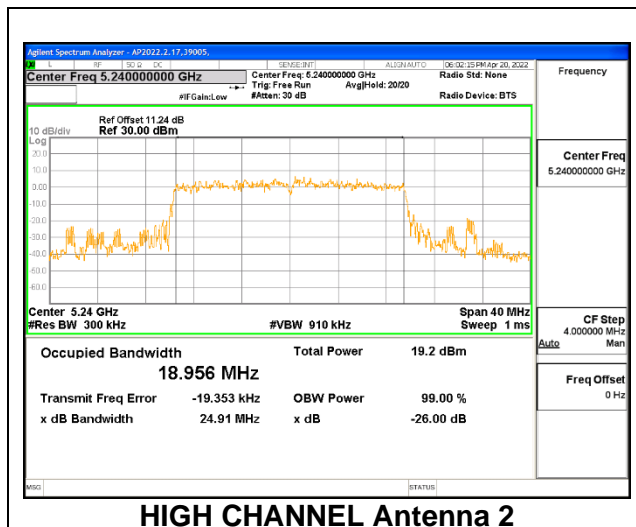

2TX Antenna 2 + Antenna 4 CDD MODE: SU (Single User)

Channel	Frequency (MHz)	99% Bandwidth Antenna 2 (MHz)	99% Bandwidth Antenna 4 (MHz)
Low	5180	18.946	19.070
Mid	5200	18.393	18.930
High	5240	18.941	18.947

LOW CHANNEL

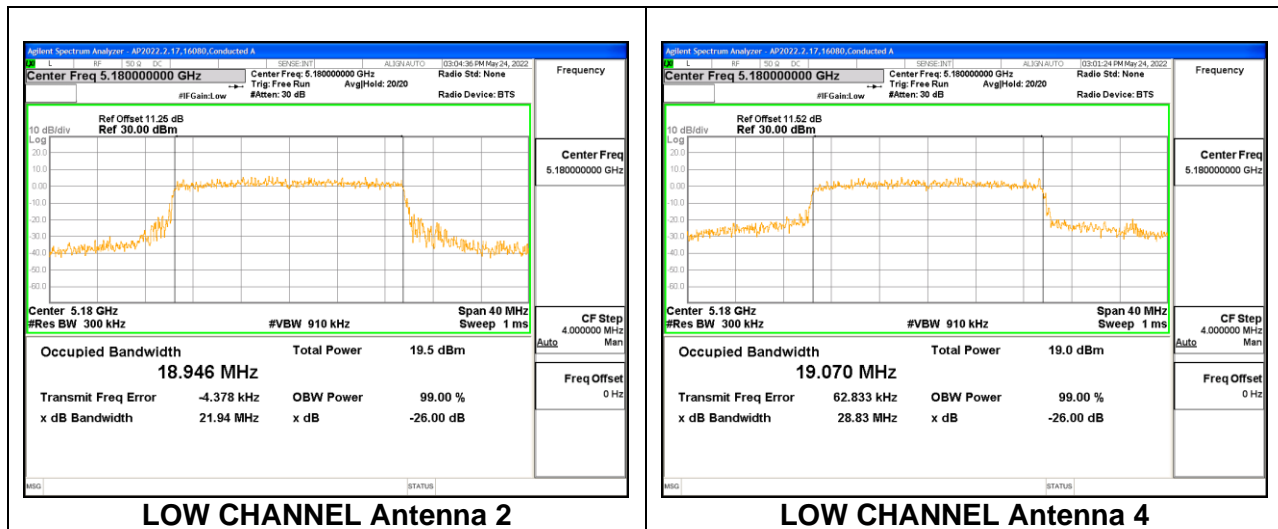

MID CHANNEL

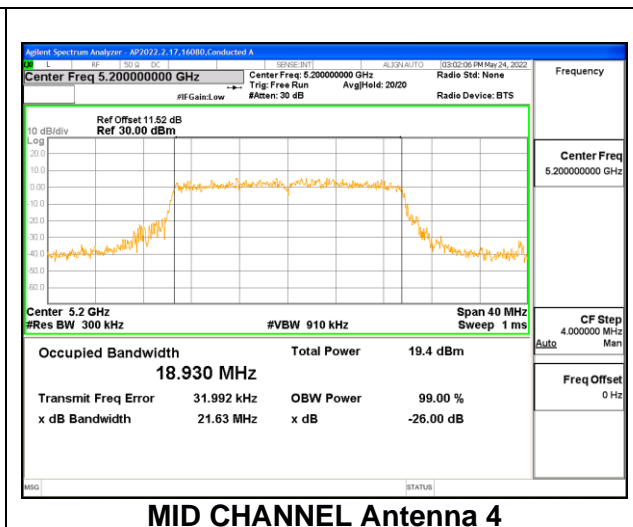
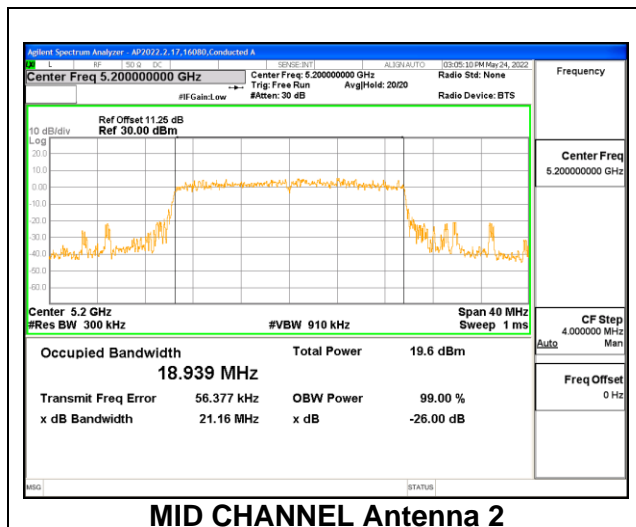

HIGH CHANNEL

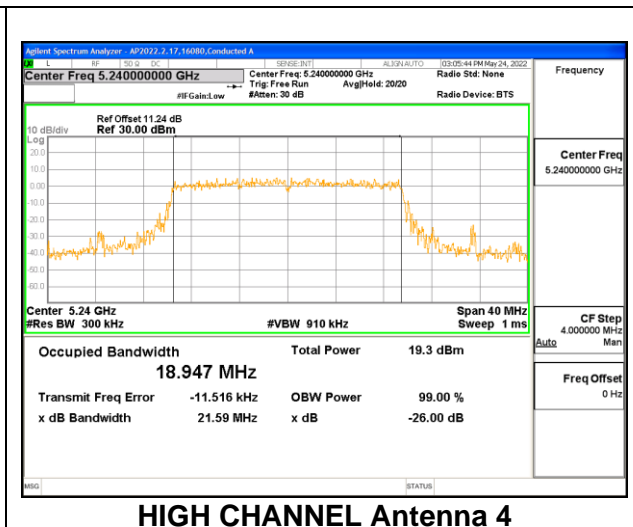
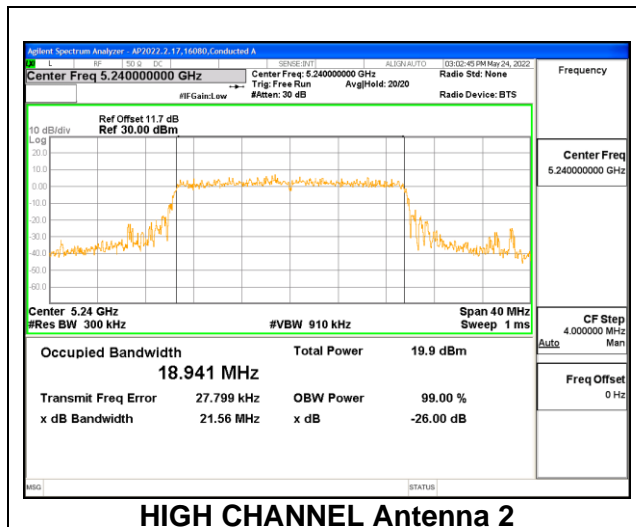

9.3.2. 802.11ax HE40 MODE 2TX IN THE 5.2GHZ BAND

2TX Antenna 2 + Antenna 4 CDD OFDMA MODE: 484-Tones, RU Index 65

Channel	Frequency (MHz)	99% Bandwidth Antenna 2 (MHz)	99% Bandwidth Antenna 4 (MHz)
Low	5190	37.475	37.420
High	5230	37.508	37.256

LOW CHANNEL

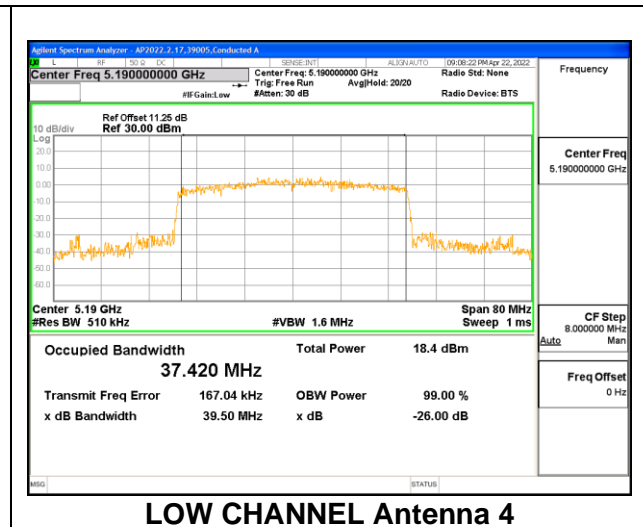
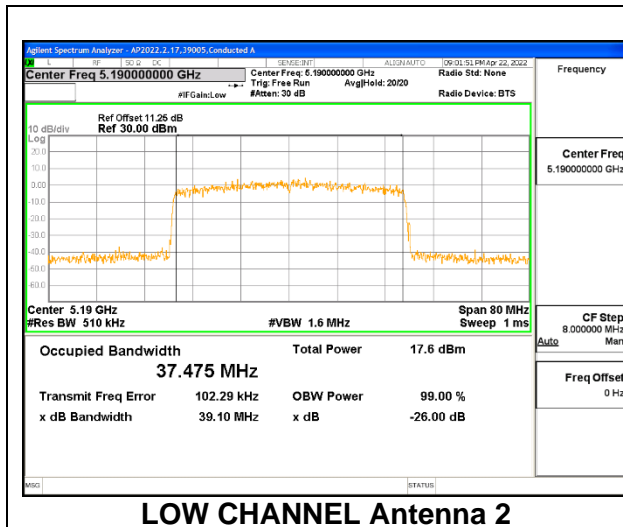

HIGH CHANNEL

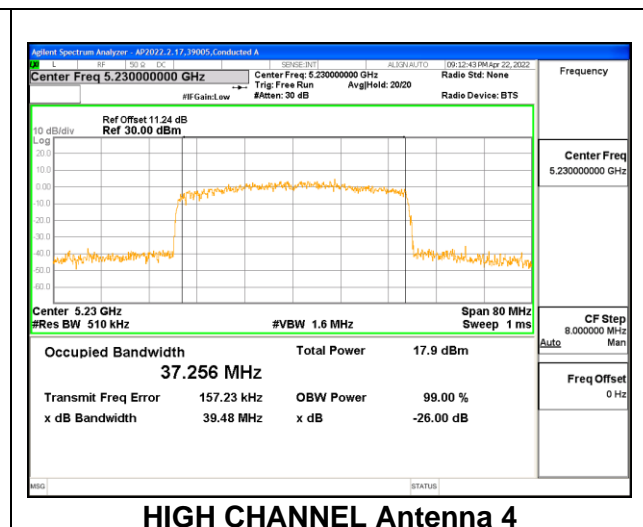
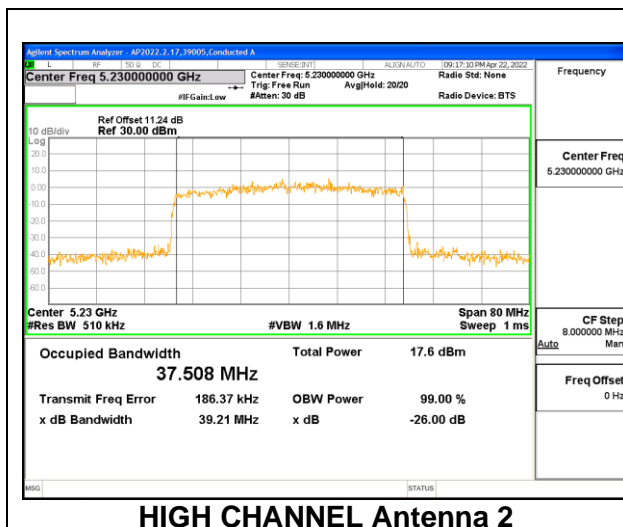

2TX Antenna 2 + Antenna 4 CDD MODE: SU (Single User)

Channel	Frequency (MHz)	99% Bandwidth Antenna 2 (MHz)	99% Bandwidth Antenna 4 (MHz)
Low	5190	37.436	37.619
High	5230	37.587	37.463

LOW CHANNEL

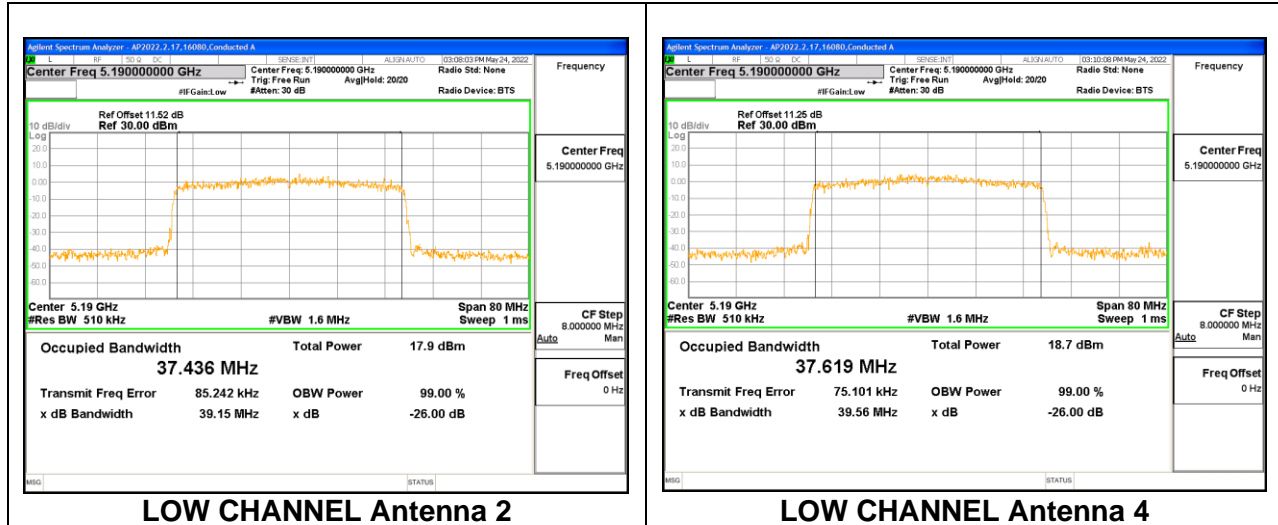

HIGH CHANNEL

