

TEST REPORT

Report Number.: 14093500-E5V2

Applicant : SONOS INC.
614 CHAPALA ST.
SANTA BARBARA, CA, 93101, U.S.A.

Model : S41

Brand : SONOS

FCC ID : SBVRM041

IC : 5373A-RM041

EUT Description : 802.11 a/b/g/n/ac/ax 2x2 Client Device with BT and BLE

Test Standard(s) : FCC 47 CFR PART 15 SUBPART E
ISED RSS-247 ISSUE 2
ISED RSS-GEN ISSUE 5 + A1 + A2

Date Of Issue:

2022-10-24

Prepared by:

UL VERIFICATION SERVICES

47173 Benicia Street

Fremont, CA 94538 U.S.A.

TEL: (510) 319-4000

FAX: (510) 661-0888



REPORT REVISION HISTORY

Rev.	Issue Date	Revisions	Revised By
V1	2022-10-13	Initial Issue	---
V2	2022-10-24	Updated Section 9	K.Kedida

TABLE OF CONTENTS

REPORT REVISION HISTORY	2
TABLE OF CONTENTS	3
1. ATTESTATION OF TEST RESULTS	6
2. TEST RESULT SUMMARY	8
3. TEST METHODOLOGY	9
4. FACILITIES AND ACCREDITATION	9
5. DECISION RULES AND MEASUREMENT UNCERTAINTY	10
5.1. METROLOGICAL TRACEABILITY	10
5.2. DECISION RULES.....	10
5.3. MEASUREMENT UNCERTAINTY.....	10
5.4. SAMPLE CALCULATION	10
6. EQUIPMENT UNDER TEST	11
6.1. EUT DESCRIPTION	11
6.2. MAXIMUM OUTPUT POWER.....	11
6.3. DESCRIPTION OF AVAILABLE ANTENNAS	13
6.4. SOFTWARE AND FIRMWARE.....	13
6.5. WORST-CASE CONFIGURATION AND MODE.....	13
6.6. DESCRIPTION OF TEST SETUP.....	14
7. MEASUREMENT METHOD.....	16
8. TEST AND MEASUREMENT EQUIPMENT	17
9. ANTENNA PORT TEST RESULTS	18
9.1. ON TIME AND DUTY CYCLE.....	18
9.2. 26 dB BANDWIDTH.....	20
9.2.1. 802.11a MODE IN THE 5.2 GHz BAND.....	21
9.2.2. 802.11n HT20 MODE IN THE 5.2 GHz BAND	23
9.2.3. 802.11n HT40 MODE IN THE 5.2 GHz BAND	25
9.2.4. 802.11ac VHT80 MODE IN THE 5.2 GHz BAND	26
9.2.5. 802.11a MODE IN THE 5.3 GHz BAND.....	27
9.2.6. 802.11n HT20 MODE IN THE 5.3 GHz BAND	29
9.2.7. 802.11n HT40 MODE IN THE 5.3 GHz BAND	31
9.2.8. 802.11ac VHT80 MODE IN THE 5.3 GHz BAND	32
9.2.9. 802.11a MODE IN THE 5.6 GHz BAND.....	33

9.2.10.	802.11n HT20 MODE IN THE 5.6 GHz BAND	35
9.2.11.	802.11n HT40 MODE IN THE 5.6 GHz BAND	37
9.2.12.	802.11ac VHT80 MODE IN THE 5.6 GHz BAND	39
9.2.13.	802.11a MODE IN THE 5.8 GHz BAND	40
9.2.14.	802.11n HT20 MODE IN THE 5.8 GHz BAND	42
9.2.15.	802.11n HT40 MODE IN THE 5.8 GHz BAND	44
9.2.16.	802.11ac VHT80 MODE IN THE 5.8 GHz BAND	45
9.3.	<i>99% BANDWIDTH</i>	46
9.3.1.	802.11a MODE IN THE 5.2 GHz BAND	47
9.3.2.	802.11n HT20 MODE IN THE 5.2 GHz BAND	49
9.3.3.	802.11n HT40 MODE IN THE 5.2 GHz BAND	51
9.3.4.	802.11ac VHT80 MODE IN THE 5.2 GHz BAND	52
9.3.5.	802.11a MODE IN THE 5.3 GHz BAND	53
9.3.6.	802.11n HT20 MODE IN THE 5.3 GHz BAND	55
9.3.7.	802.11n HT40 MODE IN THE 5.3 GHz BAND	57
9.3.8.	802.11ac VHT80 MODE IN THE 5.3 GHz BAND	58
9.3.9.	802.11a MODE IN THE 5.6 GHz BAND	59
9.3.10.	802.11n HT20 MODE IN THE 5.6 GHz BAND	61
9.3.11.	802.11n HT40 MODE IN THE 5.6 GHz BAND	63
9.3.12.	802.11ac VHT80 MODE IN THE 5.6 GHz BAND	65
9.3.13.	802.11a MODE IN THE 5.8 GHz BAND	66
9.3.14.	802.11n HT20 MODE IN THE 5.8 GHz BAND	68
9.3.15.	802.11n HT40 MODE IN THE 5.8 GHz BAND	70
9.3.16.	802.11ac VHT80 MODE IN THE 5.8 GHz BAND	71
9.4.	<i>6 dB BANDWIDTH</i>	72
9.4.1.	802.11a MODE IN THE 5.8 GHz BAND	73
9.4.2.	802.11n HT20 MODE IN THE 5.8 GHz BAND	75
9.4.3.	802.11n HT40 MODE IN THE 5.8 GHz BAND	77
9.4.4.	802.11ac VHT80 MODE IN THE 5.8 GHz BAND	78
9.5.	<i>OUTPUT POWER AND PSD</i>	79
9.5.1.	802.11a MODE IN THE 5.2 GHz BAND	83
9.5.2.	802.11n HT20 MODE IN THE 5.2 GHz BAND	87
9.5.3.	802.11n HT40 MODE IN THE 5.2 GHz BAND	91
9.5.4.	802.11ac VHT80 MODE IN THE 5.2 GHz BAND	95
9.5.5.	802.11a MODE IN THE 5.3 GHz BAND	98
9.5.6.	802.11n HT20 MODE IN THE 5.3 GHz BAND	100
9.5.7.	802.11n HT40 MODE IN THE 5.3 GHz BAND	102
9.5.8.	802.11ac VHT80 MODE IN THE 5.3 GHz BAND	104
9.5.9.	802.11a MODE IN THE 5.6 GHz BAND	106
9.5.10.	802.11n HT20 MODE IN THE 5.6 GHz BAND	108
9.5.11.	802.11n HT40 MODE IN THE 5.6 GHz BAND	110
9.5.12.	802.11ac VHT80 MODE IN THE 5.6 GHz BAND	112
9.5.13.	802.11a MODE IN THE 5.8 GHz BAND	114
9.5.14.	802.11n HT20 MODE IN THE 5.8 GHz BAND	116
9.5.15.	802.11n HT40 MODE IN THE 5.8 GHz BAND	118
9.5.16.	802.11ac VHT80 MODE IN THE 5.8 GHz BAND	120
10.	RADIATED TEST RESULTS	122
10.1.	<i>TRANSMITTER ABOVE 1 GHz</i>	124
10.1.1.	TX ABOVE 1 GHz 802.11a MODE IN THE 5.2 GHz BAND	124

10.1.2.	TX ABOVE 1 GHz 802.11n HT20 MODE IN THE 5.2 GHz BAND.....	132
10.1.3.	TX ABOVE 1 GHz 802.11n HT40 MODE IN THE 5.2 GHz BAND.....	140
10.1.4.	TX ABOVE 1 GHz 802.11ac VHT80 MODE IN THE 5.2 GHz BAND	146
10.1.5.	TX ABOVE 1 GHz 802.11a MODE IN THE 5.3 GHz BAND	150
10.1.6.	TX ABOVE 1 GHz 802.11n HT20 MODE IN THE 5.3 GHz BAND.....	158
10.1.7.	TX ABOVE 1 GHz 802.11n HT40 MODE IN THE 5.3 GHz BAND.....	166
10.1.8.	TX ABOVE 1 GHz 802.11ac VHT80 MODE IN THE 5.3 GHz BAND	172
10.1.9.	TX ABOVE 1 GHz 802.11a MODE IN THE 5.6 GHz BAND	176
10.1.10.	TX ABOVE 1 GHz 802.11n HT20 MODE IN THE 5.6 GHz BAND.....	186
10.1.11.	TX ABOVE 1 GHz 802.11n HT40 MODE IN THE 5.6 GHz BAND.....	196
10.1.12.	TX ABOVE 1 GHz 802.11ac VHT80 MODE IN THE 5.6 GHz BAND	206
10.1.13.	TX ABOVE 1 GHz 802.11a MODE IN THE 5.8 GHz BAND	214
10.1.14.	TX ABOVE 1 GHz 802.11n HT20 MODE IN THE 5.8 GHz BAND.....	224
10.1.15.	TX ABOVE 1 GHz 802.11n HT40 MODE IN THE 5.8 GHz BAND.....	234
10.1.16.	TX ABOVE 1 GHz 802.11ac VHT80 MODE IN THE 5.8 GHz BAND	242
10.2.	<i>WORST CASE BELOW 30MHz</i>	<i>248</i>
10.3.	<i>WORST CASE BELOW 1 GHz</i>	<i>249</i>
10.4.	<i>WORST CASE 18-26 GHz</i>	<i>251</i>
10.5.	<i>WORST CASE 26-40 GHz</i>	<i>253</i>
11.	AC POWER LINE CONDUCTED EMISSIONS	255
12.	SETUP PHOTOS.....	258

1. ATTESTATION OF TEST RESULTS

COMPANY NAME: SONOS INC.
614 Chapala St.
Santa Barbara, CA, 93101, U.S.A.

EUT DESCRIPTION: 802.11 a/b/g/n/ac/ax 2x2 Client Device with BT and BLE

MODEL: S41

BRAND: SONOS

SERIAL NUMBER: Radiated Sample: 528B4 and 6B90A
Conducted Sample: 4304F

SAMPLE RECEIPT DATE: 2022-04-11

DATE TESTED: 2022-04-11 to 2022-05-06

APPLICABLE STANDARDS	
STANDARD	TEST RESULTS
CFR 47 Part 15 Subpart E	Complies
ISED RSS-247 Issue 2	Complies
ISED RSS-GEN Issue 5 + A1 + A2	Complies

UL Verification Services Inc. tested the above equipment in accordance with the requirements set forth in the above standards. The test results show that the equipment tested is capable of demonstrating compliance with the requirements as documented in this report.

The results documented in this report apply only to the tested sample, under the conditions and modes of operation as described herein. It is the manufacturer's responsibility to assure that additional production units of this model are manufactured with identical electrical and mechanical components. All samples tested were in good operating condition throughout the entire test program. Measurement Uncertainties are published for informational purposes only and were not taken into account unless noted otherwise.

This document may not be altered or revised in any way unless done so by UL Verification Services Inc. and all revisions are duly noted in the revisions section. Any alteration of this document not carried out by UL Verification Services Inc. will constitute fraud and shall nullify the document. This report must not be used by the client to claim product certification, approval, or endorsement by A2LA, NIST, any agency of the Federal Government, or any agency of the U.S. government.

Approved & Released For
UL Verification Services Inc. By:

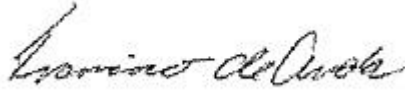

Francisco de Anda
Staff Engineer
Consumer Technology Division
UL Verification Services Inc.

Prepared By:



Glenn Escano
Senior Test Engineer
Consumer Technology Division
UL Verification Services Inc.

1st Reviewed By:



Vien Tran
Senior Laboratory Engineer
Consumer Technology Division
UL Verification Services Inc.

2nd Reviewed By:



Kiya Kedida
Senior Project Engineer
Consumer Technology Division
UL Verification Services Inc.

2. TEST RESULT SUMMARY

This report contains data provided by the customer which can impact the validity of results. UL Verification Services Inc. is only responsible for the validity of results after the integration of the data provided by the customer.

Below is a list of the data provided by the customer:

1. Antenna gain and type (see section 6.3)

FCC Clause	ISED Clause	Requirement	Result	Comment
See Comment		Duty Cycle	Reporting purposes only	Per ANSI C63.10, Section 12.2.
See Comment	RSS-GEN 6.7	26dB BW/99% OBW	Reporting purposes only	Per ANSI C63.10 Sections 6.9.2 and 6.9.3
15.407 (e)	RSS-247 6.2.4.1	6 dB BW	Compliant	None.
15.407 (a) (1-4), (h) (1)	RSS-247 6.2	Output Power	Compliant	None.
15.407 (a) (1-3, 5)	RSS-247 6.2	PSD	Compliant	None.
15.209, 15.205, 15.407 (b)	RSS-GEN 8.9, 8.10, RSS-247 6.2	Radiated Emissions	Compliant	None.
15.207	RSS-Gen 8.8	AC Mains Conducted Emissions	Compliant	None.

3. TEST METHODOLOGY

The tests documented in this report were performed in accordance with:

- FCC CFR 47 Part 2
- FCC CFR 47 Part 15,
- FCC KDB 662911 D01 v02r01,
- FCC KDB 905462 D02 v02/D03 v01r02/D06 v02
- FCC KDB 789033 D02 v02r01,
- KDB 414788 D01 Radiated Test Site v01r01
- ANSI C63.10-2013,
- RSS-GEN Issue 5 + A1 + A2
- RSS-247 Issue 2

4. FACILITIES AND ACCREDITATION

UL Verification Services Inc. is accredited by A2LA, Certificate Number #0751.05, for all testing performed within the scope of this report. Testing was performed at the locations noted below.

	Address	ISED CABID	ISED Company Number	FCC Registration
<input checked="" type="checkbox"/>	Building 1: 47173 Benicia Street Fremont, CA 94538, U.S.A	US0104	2324A	208313
<input type="checkbox"/>	Building 2: 47266 Benicia Street Fremont, CA 94538, U.S.A	US0104	22541	208313
<input checked="" type="checkbox"/>	Building 4: 47658 Kato Rd Fremont, CA 94538, U.S.A	US0104	2324B	208313

5. DECISION RULES AND MEASUREMENT UNCERTAINTY

5.1. METROLOGICAL TRACEABILITY

All test and measuring equipment utilized to perform the tests documented in this report are calibrated on a regular basis, with a maximum time between calibrations of one year or the manufacturers' recommendation, whichever is less, and where applicable is traceable to recognized national standards.

5.2. DECISION RULES

The Decision Rule is based on Simple Acceptance in accordance with ISO Guide 98-4:2012 Clause 8.2. (Measurement uncertainty is not taken into account when stating conformity with a specified requirement.)

5.3. MEASUREMENT UNCERTAINTY

Where relevant, the following measurement uncertainty levels have been estimated for tests performed on the apparatus:

PARAMETER	U _{Lab}
Worst Case Conducted Disturbance, 9KHz to 0.15 MHz	3.78 db
Worst Case Conducted Disturbance, 0.15 to 30 MHz	3.40 db
Worst Case Radiated Disturbance, 9KHz to 30 MHz	2.87 db
Worst Case Radiated Disturbance, 30 to 1000 MHz	6.01 db
Worst Case Radiated Disturbance, 1000 to 18000 MHz	4.73 db
Worst Case Radiated Disturbance, 18000 to 26000 MHz	4.51 db
Worst Case Radiated Disturbance, 26000 to 40000 MHz	5.29 db

Uncertainty figures are valid to a confidence level of 95%.

5.4. SAMPLE CALCULATION

RADIATED EMISSIONS

Where relevant, the following sample calculation is provided:

$$\text{Field Strength (dBuV/m)} = \text{Measured Voltage (dBuV)} + \text{Antenna Factor (dB/m)} + \text{Cable Loss (dB)} - \text{Preamp Gain (dB)}$$

$$36.5 \text{ dBuV} + 18.7 \text{ dB/m} + 0.6 \text{ dB} - 26.9 \text{ dB} = 28.9 \text{ dBuV/m}$$

MAINS CONDUCTED EMISSIONS

Where relevant, the following sample calculation is provided:

$$\text{Final Voltage (dBuV)} = \text{Measured Voltage (dBuV)} + \text{Cable Loss (dB)} + \text{Limiter Factor (dB)} + \text{LISN Insertion Loss}$$

$$36.5 \text{ dBuV} + 0 \text{ dB} + 10.1 \text{ dB} + 0 \text{ dB} = 46.6 \text{ dBuV}$$

6. EQUIPMENT UNDER TEST

6.1. EUT DESCRIPTION

The EUT is an 802.11 a/b/g/n/ac/ax 2x2 Client Device with BT and BLE.

This report covers non-ax 5GHz Wifi radio.

6.2. MAXIMUM OUTPUT POWER

The transmitter has a maximum conducted output power as follows:

(FCC)

Frequency Range (MHz)	Mode	Output Power (dBm)	Output Power (mW)
5.2 GHz band, 2TX			
5180-5240	802.11a	18.70	74.13
5180-5240	802.11n HT20	19.53	89.74
5190-5230	802.11n HT40	18.86	76.91
5210	802.11ac VHT80	17.75	59.57
5.3 GHz band, 2TX			
5260-5320	802.11a	19.32	85.51
5260-5320	802.11n HT20	19.29	84.92
5270-5310	802.11n HT40	17.60	57.54
5290	802.11ac VHT80	14.64	29.11
5.6 GHz band, 2TX			
5500 - 5700	802.11a	18.93	78.16
5500 - 5700	802.11n HT20	18.93	78.16
5510 - 5670	802.11n HT40	18.62	72.78
5530 - 5610	802.11ac VHT80	21.30	134.90
5.8 GHz band, 2TX			
5745 - 5825	802.11a	20.96	124.74
5745 - 5825	802.11n HT20	20.77	119.40
5755 - 5795	802.11n HT40	19.82	95.94
5775	802.11ac VHT80	19.75	94.41

(IC)

The transmitter has a maximum e.i.r.p as follows:

Frequency Range (MHz)	Mode	EIRP (dBm)	EIRP (mW)
5.2 GHz band, 2TX			
5180-5240	802.11a	17.76	59.70
5180-5240	802.11n HT20	18.36	68.55
5190-5230	802.11n HT40	19.88	97.27
5210	802.11ac VHT80	18.80	75.86

6.3. DESCRIPTION OF AVAILABLE ANTENNAS

The antenna gains and type, as provided by the manufacturer are as follows:

The radio utilizes a PCB, with maximum gains as follows:

Frequency Range (MHz)	Peak Antenna Gain (dBi)			
	CHAIN 0		CHAIN 1	
	ANT1 (FR) (Monopole) (dBi)	ANT2 (RL) (Loop) (dBi)	ANT3 (RR) (Loop) (dBi)	ANT4 (FL) (Loop) (dBi)
5150 – 5250	4.1	4.3	4.8	4.9
5250 – 5350	3.5	4.9	4.7	5.6
5500 – 5700	4.4	4.7	5.1	6.2
5725 - 5850	4.8	4.6	4.4	5.7

6.4. SOFTWARE AND FIRMWARE

The EUT firmware installed during testing was 69.1-26251-diag.

The test utility software used during testing was GUI 20220422_V4.

6.5. WORST-CASE CONFIGURATION AND MODE

Radiated emissions below 1GHz, above 18GHz, and power line conducted emission were performed with the EUT set to transmit at the channel with highest output power as worst-case scenario.

Band edge and radiated emissions between 1GHz and 18GHz were performed with the EUT set to transmit at the highest power on low, middle, and high channels.

The EUT can only be setup in desktop orientation; therefore, all radiated testing was performed with the EUT in desktop orientation.

The fundamental of the EUT was investigated in the antenna combinations, it was determined that:

_ANT2 and ANT4 was the worst case in the 5.2GHz, 5.3GHz, & 5.6GHz bands.

_ANT1 and ANT4 was the worst case in the 5.8GHz band.

Therefore, all final testing was performed with ANT2 and ANT4 and ANT1 and ANT4 as stated above.

Worst-case data rates as provided by the manufacturer were:

802.11a mode: 6 Mbps

802.11n HT20mode: MCS0

802.11n HT40mode: MCS0

802.11ac VHT80 mode: MCS0

Note: 802.11ac VHT20 and VHT40 has the same 802.11n HT20 and 802.11n HT40 so 802.11n HT20 and 802.11n HT40 were test as worst case.

6.6. DESCRIPTION OF TEST SETUP

SUPPORT TEST EQUIPMENT						
Description	Manufacturer	Model	Serial Number	FCC ID/ DoC		
Laptop	Lenovo	T460s	PC0JMBF8	Doc		
Laptop AC/DC Adapter	Lenovo	ADLX90NLC2A	11S45N0247Z1ZSHH448JEY	Doc		
USB-A to Ethernet Adapter	Plugable	USB2-E100	8CAE4CE46AFA	Doc		
USB-C to USB-A Female Adapter	Amazon Basics	L6LUC160-CS-R	N/A	Doc		
I/O CABLES (CONDUCTED TEST)						
Cable No.	Port	# of Identical Ports	Connector Type	Cable Type	Cable Length (m)	Remarks
1	AC	3	AC	Un-shielded	1.25	AC Mains to EUT/Spectrum Analyzer/AC/DC Adapter
2	DC	1	DC	Un-shielded	1	AC/DC Adapter to Laptop
3	Ethernet	1	RJ45	Un-shielded	1.5	Laptop to USB Ethernet Adapter
4	USB-A	1	USB-A	Shielded	0.05	USB Ethernet Adapter to USB
5	USB-C	1	USB-C	Shielded	0.05	EUT to USB-C/USB-A Female Adapter
6	SMA Cable	1	SMA	Un-Shielded	0.1	EUT to Spectrum Analyzer
I/O CABLES (RADIATED TEST)						
Cable No.	Port	# of Identical Ports	Connector Type	Cable Type	Cable Length (m)	Remarks
1	AC	3	AC	Un-shielded	1.25	AC Mains to EUT/Spectrum Analyzer/AC/DC Adapter
2	DC	1	DC	Un-shielded	1	AC/DC Adapter to Laptop
3	Ethernet	1	RJ45	Un-shielded	10	Laptop to USB Ethernet Adapter
4	USB-A	1	USB-A	Shielded	0.05	USB Ethernet Adapter to USB
5	USB-C	1	USB-C	Shielded	0.05	EUT to USB-C/USB-A Female Adapter
6	SMA Cable	1	SMA	Un-Shielded	10	EUT to Horn Antenna

TEST SETUP

The EUT is a stand-alone unit, and the radio is exercised remotely by Sonos Compliance GUI test utility software via ethernet.

SETUP DIAGRAM

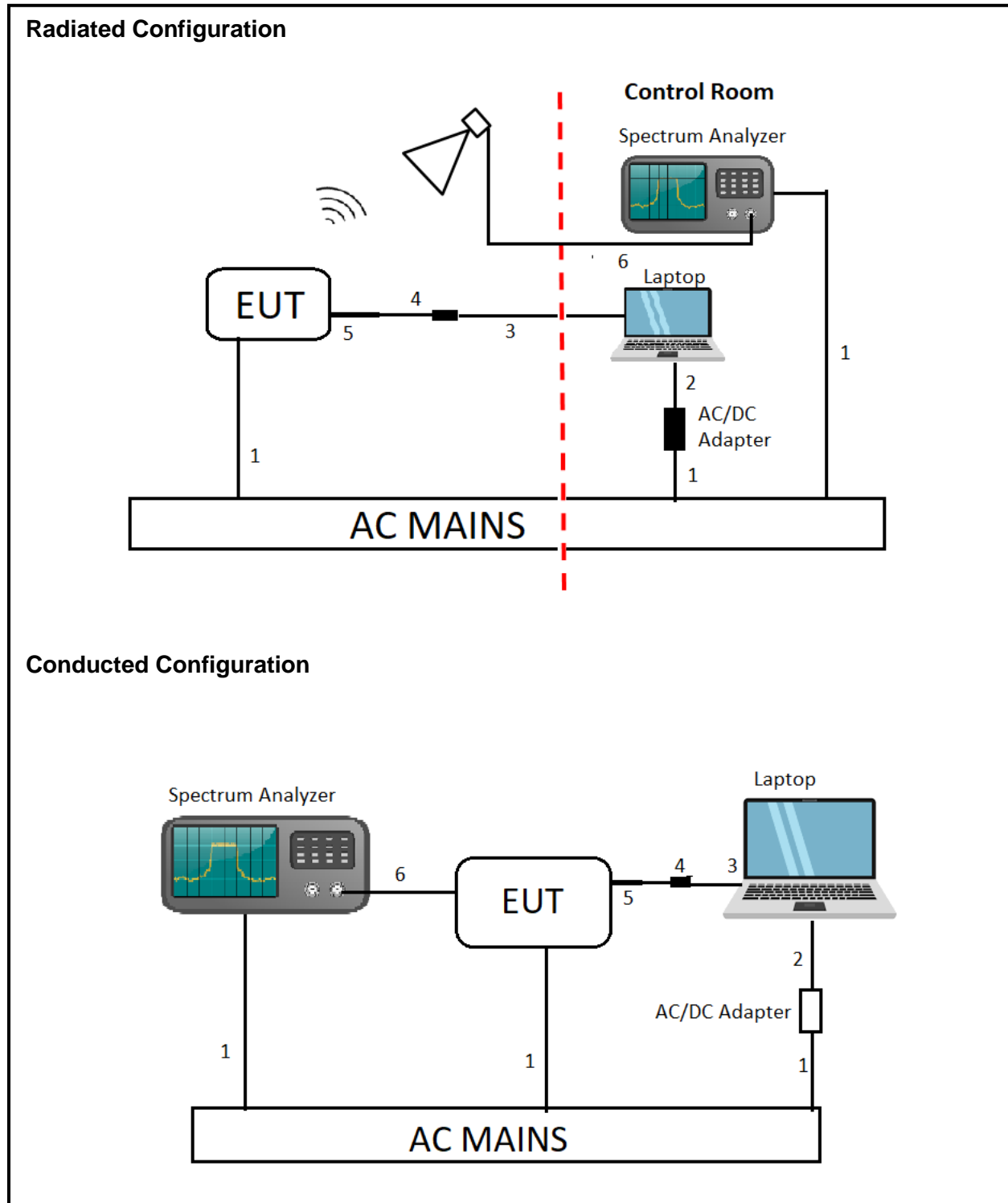

7. MEASUREMENT METHOD

On Time and Duty Cycle: KDB 789033 D02 v02r01, Section B.

6 dB Emission BW: KDB 789033 D02 v02r01, Section C.2

26 dB Emission BW: KDB 789033 D02 v02r01, Section C.1

99% Occupied BW: KDB 789033 D02 v02r01, Section D.

Conducted Output Power: KDB 789033 D02 v02r01, Section E.3.b (Method PM-G) and KDB 789033 D02 v02r01, Section E.2.b (Method SA-1)

Power Spectral Density: KDB 789033 D02 v02r01, Section F

Unwanted emissions in restricted bands: KDB 789033 D02 v02r01, Sections G.3, G.4, G.5, and G.6.

Unwanted emissions in non-restricted bands: KDB 789033 D02 v02r01, Sections G.3, G.4, and G.5.

AC Power Line Conducted Emissions: ANSI C63.10-2013, Section 6.2.

Radiated Spurious Emissions Below 30MHz: ANSI C63.10-2013 Section 6.4

8. TEST AND MEASUREMENT EQUIPMENT

The following test and measurement equipment was utilized for the tests documented in this report:

TEST EQUIPMENT LIST					
Description	Manufacturer	Model	ID Num	Cal Due	Last Cal
Antenna, Broadband Hybrid, 30MHz to 3GHz	Sunol Sciences Corp.	JB3	171862	2022-09-28	2021-09-28
Amplifier, 10KHz to 1GHz, 32dB	SONOMA INSTRUMENT	310N	29654	2023-04-24	2022-04-24
Antenna, Horn 1-18GHz	ETS-Lindgren (Cedar Park, Texas)	3117	80404	2022-08-04	2021-08-04
Antenna, Horn 1-18GHz	ETS-Lindgren (Cedar Park, Texas)	3117	T119	2022-05-07*	2021-05-07
Amplifier, 100MHz - 18GHz	AMPLICAL	AMP0.1G18-47-20	185686	2022-04-09	2021-04-09
RF Filter Box, 1-18GHz	FREMONT	SAC-L1	171013	2023-03-09	2022-03-09
EMI TEST RECEIVER,	Rohde & Schwarz	ESW44	PRE0179367	2023-02-16	2022-02-16
EMI TEST RECEIVER, with B8 option	Rohde & Schwarz	ESW44	PRE0179377	2023-02-20	2022-02-20
EMI TEST RECEIVER	Rohde & Schwarz	ESW44	201499	2023-02-17	2022-02-17
Antenna, Horn 18 to 26.5GHz	ARA	MWH-1826/B	172363	2022-12-07	2021-12-07
Antenna, Horn 26 to 40GHz	ARA	MWH-2640/B	172366	2022-12-07	2021-12-07
Amplifier 18-26.5GHz, +5Vdc, -54dBm P1dB	AMPLICAL	AMP18G26.5-60	171583	2023-01-27	2022-01-27
Amplifier 26-40GHz +5Vdc, -62dBm P1dB	AMPLICAL	AMP26G40-65	172346	2023-02-01	2022-02-01
Antenna, Passive Loop 30Hz - 1MHz	ELECTRO METRICS	EM-6871	SC-8015	2022-05-24*	2021-05-24
Antenna, Passive Loop 100KHz - 30MHz	ELECTRO METRICS	EM-6872	SC-8014	2022-05-24*	2021-05-24
Spectrum Analyzer, PXA, 3Hz to 44GHz	Agilent Technologies	N9030A	80396	2023-01-02	2021-01-02
Power Meter, P-series single channel	Keysight Technologies Inc	N1911A	90719	2023-01-24	2022-01-24
Power Sensor, P - series, 50MHz to 18GHz, Wideband	Keysight Technologies Inc	N1921A	T1223	2023-03-02	2022-03-02
Power Meter, P-series single channel	Keysight Technologies Inc	N1911A	T1268	2023-02-03	2022-02-03
Power Sensor, P - series, 50MHz to 18GHz, Wideband	Keysight Technologies Inc	N1921A	90419	2023-03-02	2022-03-02
AC Line Conducted					
LISN	Fischer Custom Communications, Inc	FCC-LISN-50/250-25-2-01-480V	175765	2023-01-26	2022-01-26
EMI TEST RECEIVER	Rohde & Schwarz	ESR	93091	2023-02-21	2022-02-21
Transient Limiter	TE	TBFL1	207996	2022-06-01	2021-06-01
UL TEST SOFTWARE LIST					
Radiated Software	UL	UL EMC	Ver 2016-05-11, 2015-12-29, 2019-10-09, 2021-12-07, 2022-05-18, and 2022-07-06		
Antenna Port Software	UL	UL RF	Ver 2022.8.16		
AC Line Conducted Software	UL	UL EMC	Rev 9.5, 2022-02-17		

*Test performed before calibration expired.

9. ANTENNA PORT TEST RESULTS

9.1. ON TIME AND DUTY CYCLE

LIMITS

None; for reporting purposes only.

PROCEDURE

KDB 558074 Zero-Span Spectrum Analyzer Method.

ON TIME AND DUTY CYCLE RESULTS

Test Engineer:	AF19419
Test Date:	4/11/2022

Mode	ON Time B (msec)	Period (msec)	Duty Cycle x (linear)	Duty Cycle (%)	Duty Cycle Correction Factor (dB)	1/B Minimum VBW (kHz)
802.11a	1.39	1.77	0.79	78.73	1.04	0.72
802.11n HT20	1.30	1.68	0.77	77.48	1.11	0.77
802.11n HT40	0.65	1.04	0.63	62.55	2.04	1.54
802.11ac VHT80	0.32	0.70	0.46	46.11	3.36	3.09

DUTY CYCLE PLOTS

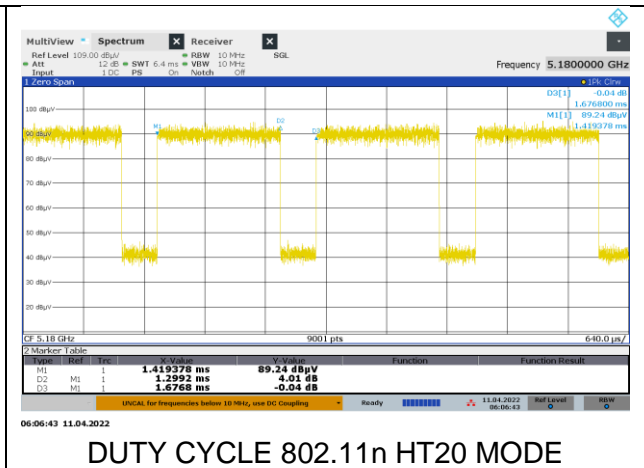
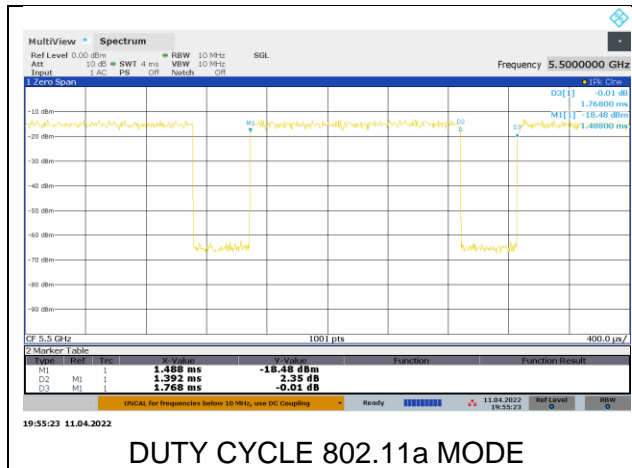

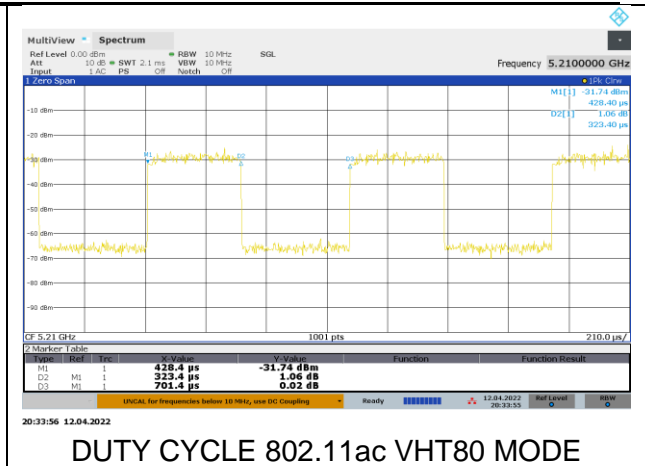
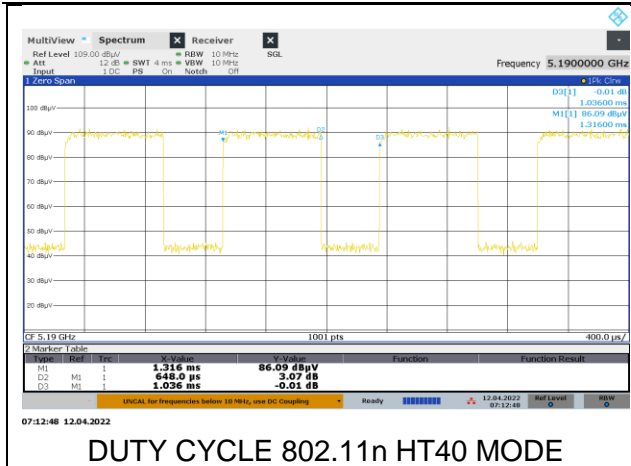

9.2. 26 dB BANDWIDTH

LIMITS

None; for reporting purposes only.

RESULTS

9.2.1. 802.11a MODE IN THE 5.2 GHz BAND

2TX Antenna 2 + Antenna 4 CDD MODE

Channel	Frequency (MHz)	26 dB Bandwidth Antenna 2 (MHz)	26 dB Bandwidth Antenna 4 (MHz)
Low	5180	25.28	25.16
Mid	5200	25.36	25.32
High	5240	25.12	25.12

LOW CHANNEL

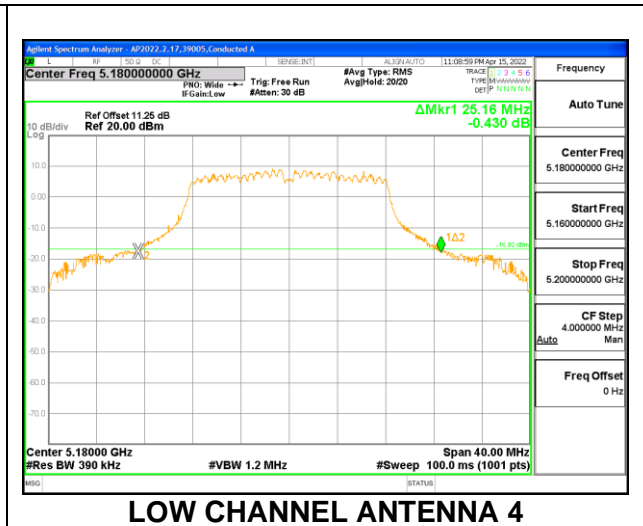
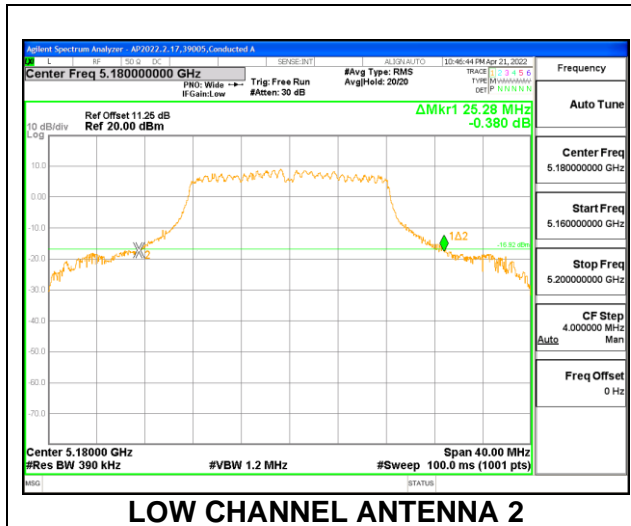

MID CHANNEL

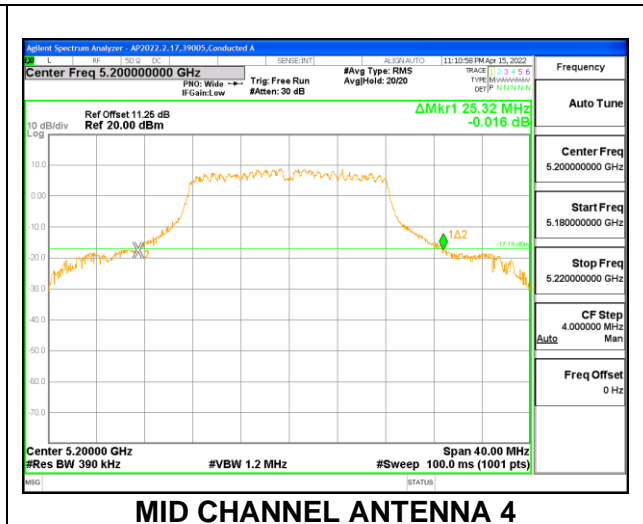
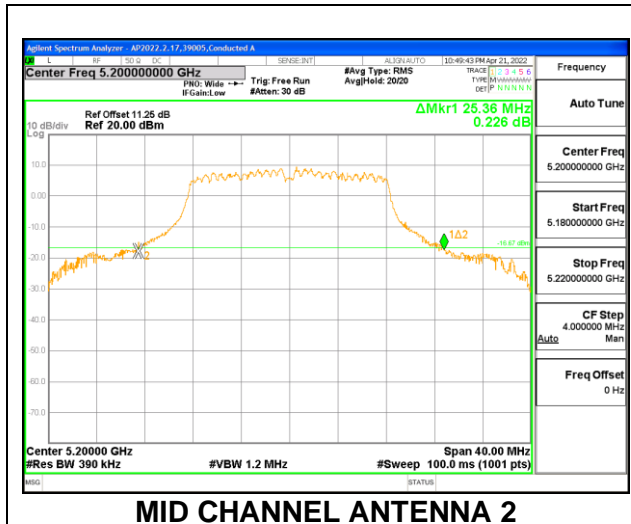

HIGH CHANNEL

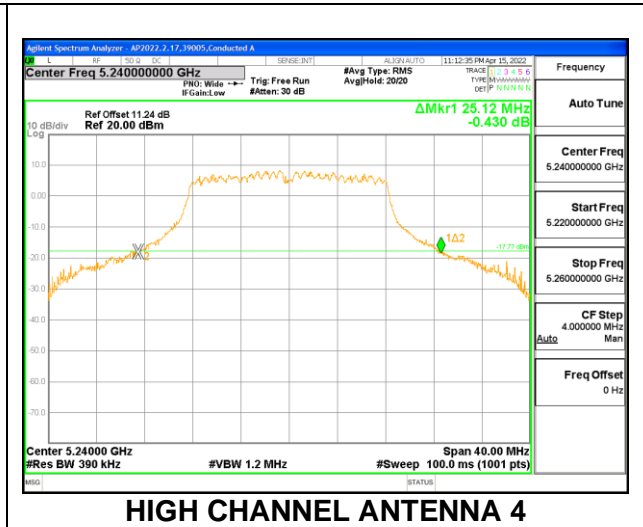
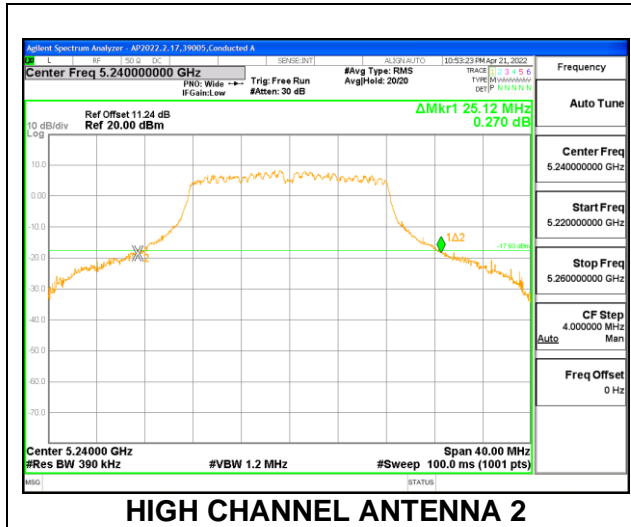

9.2.2. 802.11n HT20 MODE IN THE 5.2 GHz BAND

2TX Antenna 2 + Antenna 4 CDD MODE

Channel	Frequency (MHz)	26 dB Bandwidth Antenna 2 (MHz)	26 dB Bandwidth Antenna 4 (MHz)
Low	5180	24.68	24.52
Mid	5200	24.68	24.48
High	5240	24.72	24.72

LOW CHANNEL

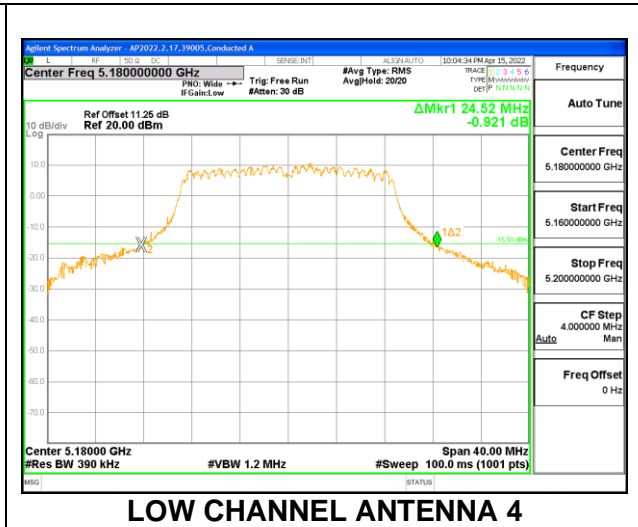
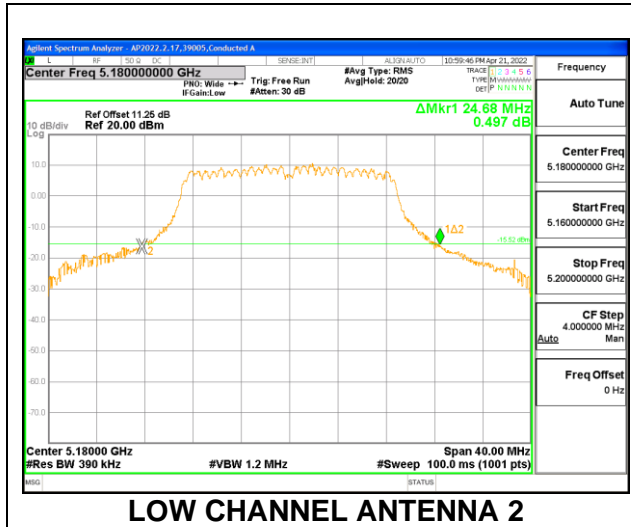

MID CHANNEL

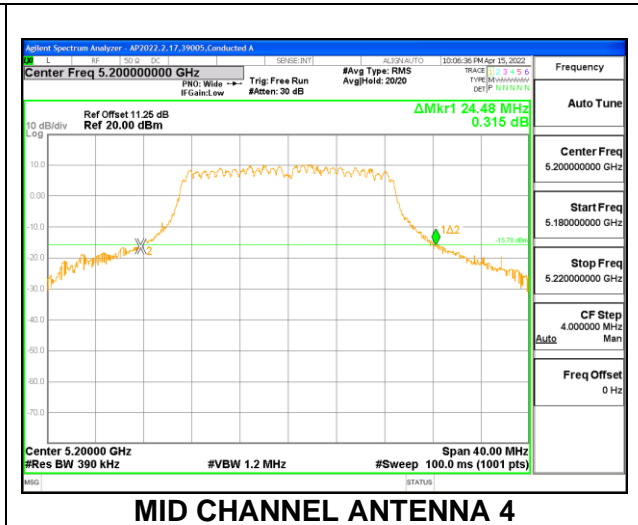
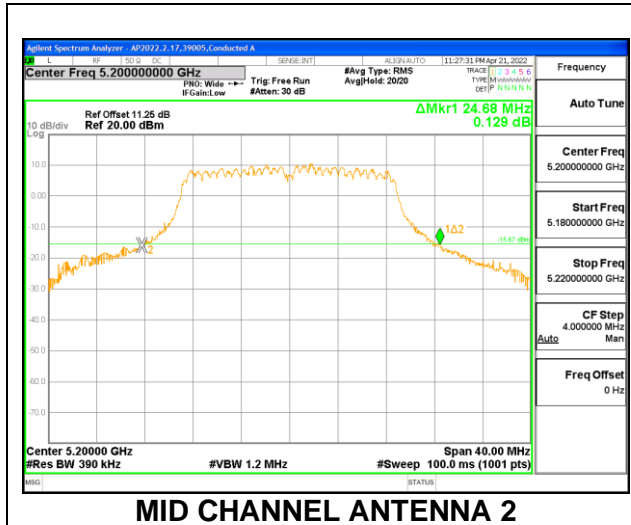

HIGH CHANNEL

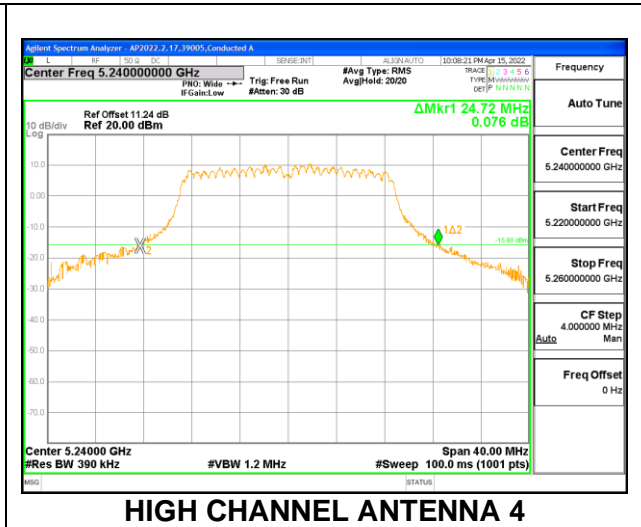
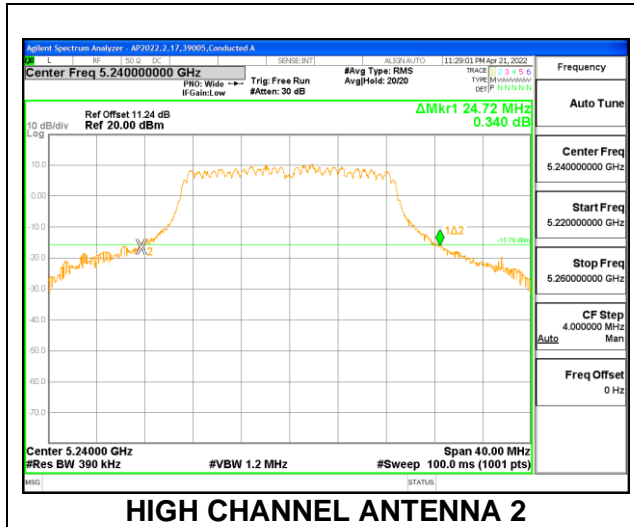

9.2.3. 802.11n HT40 MODE IN THE 5.2 GHz BAND

2TX Antenna 2 + Antenna 4 CDD MODE

Channel	Frequency (MHz)	26 dB Bandwidth Antenna 2 (MHz)	26 dB Bandwidth Antenna 4 (MHz)
Low	5190	40.96	40.64
High	5230	40.88	40.64

LOW CHANNEL

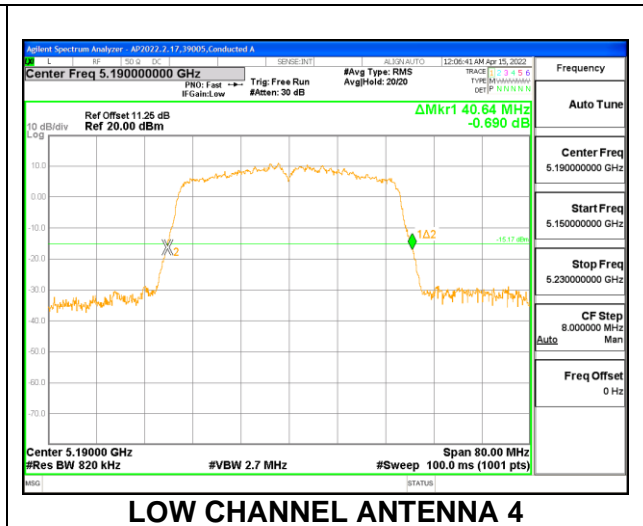
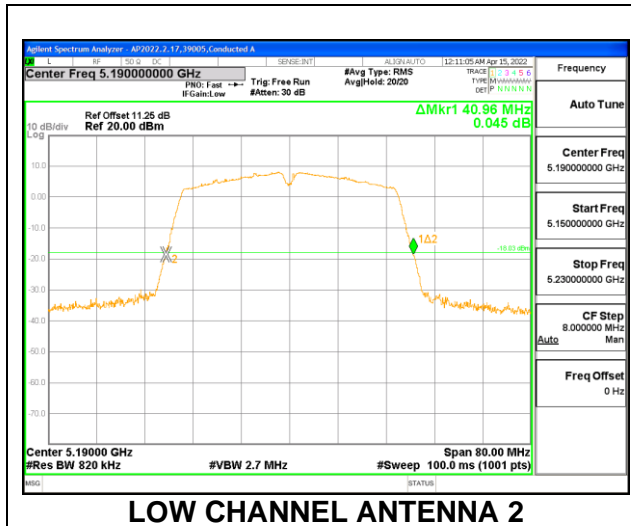

HIGH CHANNEL

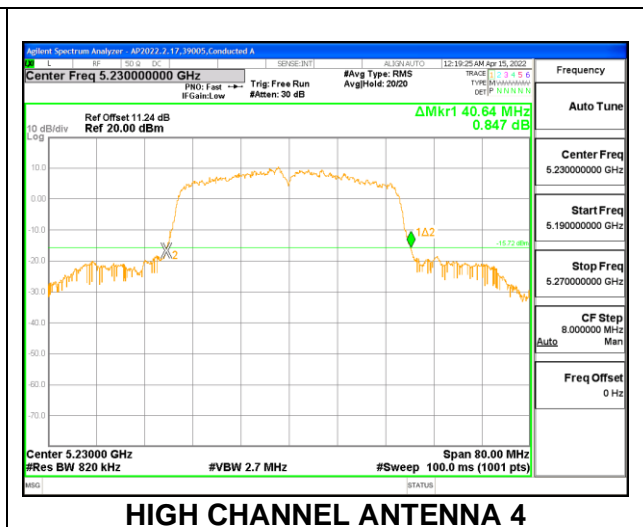
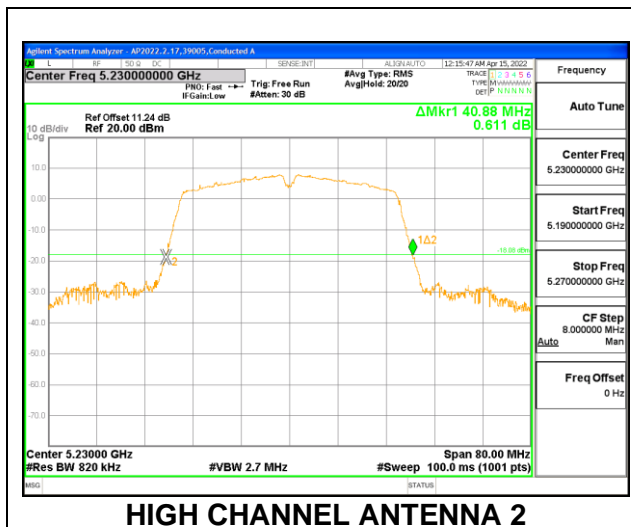

9.2.4. 802.11ac VHT80 MODE IN THE 5.2 GHz BAND

2TX Antenna 2 + Antenna 4 CDD MODE

Channel	Frequency (MHz)	26 dB Bandwidth Antenna 2 (MHz)	26 dB Bandwidth Antenna 4 (MHz)
Mid	5210	81.12	80.32

MID CHANNEL

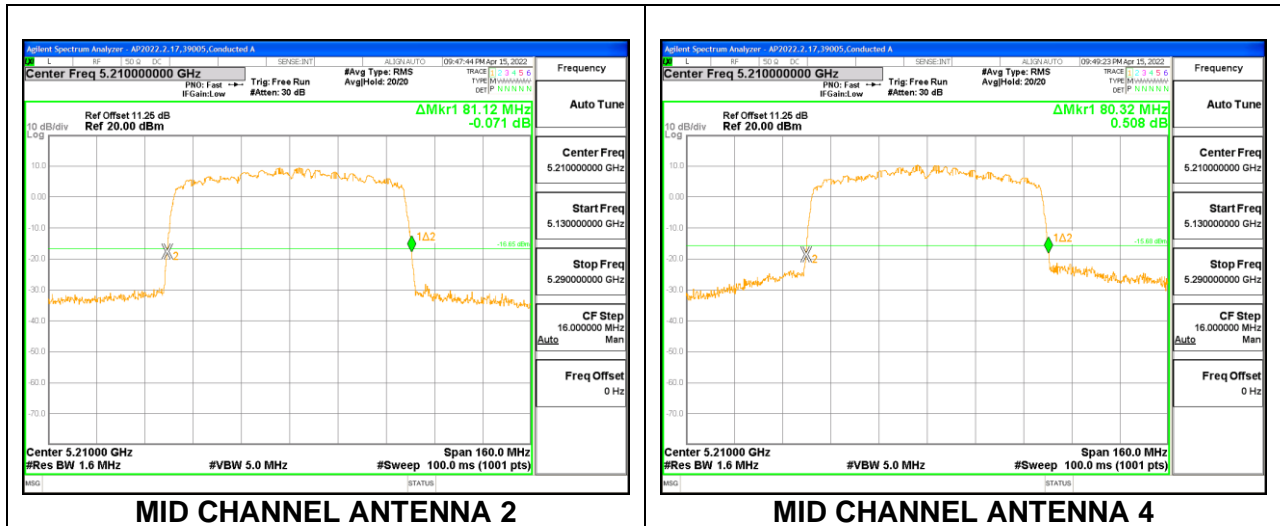

9.2.5. 802.11a MODE IN THE 5.3 GHz BAND

2TX Antenna 2 + Antenna 4 CDD MODE

Channel	Frequency (MHz)	26 dB Bandwidth Antenna 2 (MHz)	26 dB Bandwidth Antenna 4 (MHz)
Low	5260	25.24	25.32
Mid	5300	25.48	25.84
High	5320	25.72	25.64

LOW CHANNEL

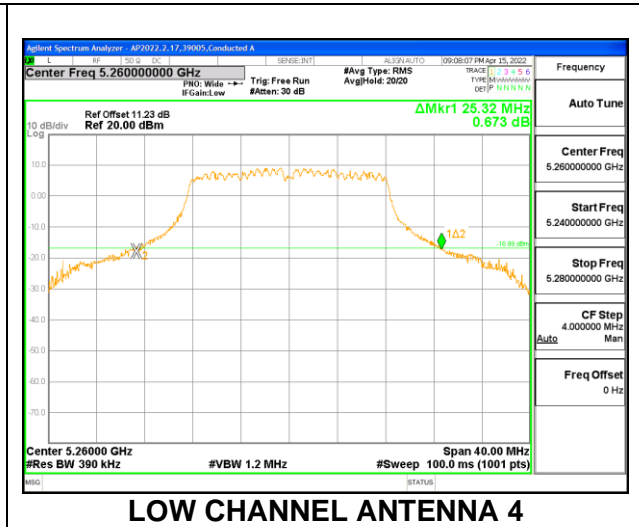
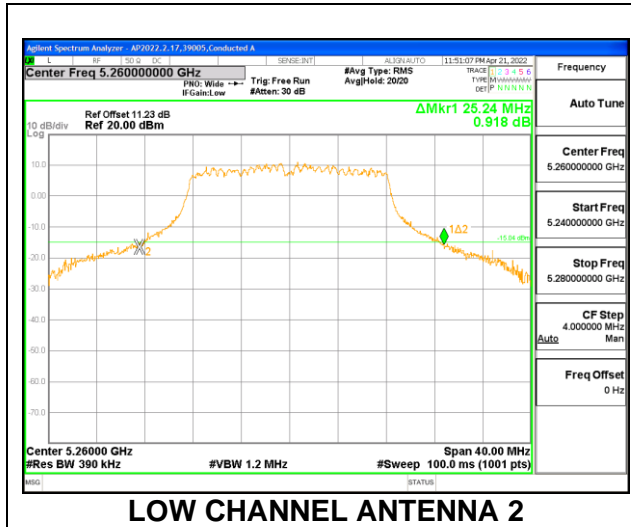

MID CHANNEL

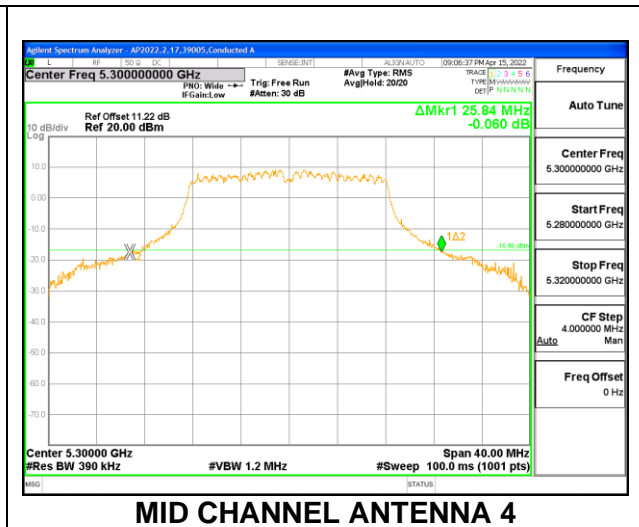
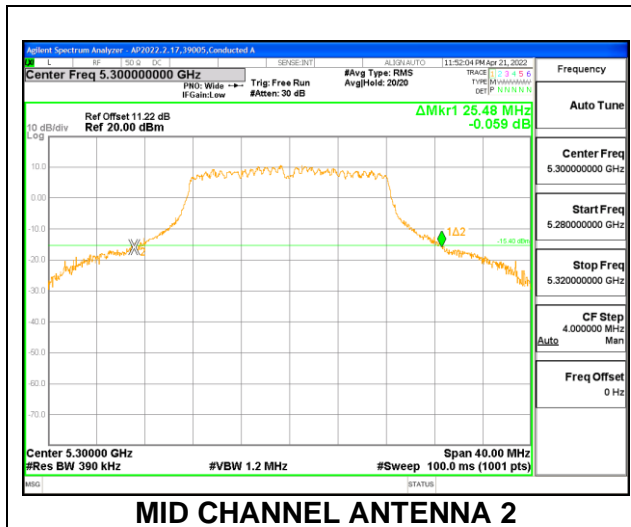

HIGH CHANNEL

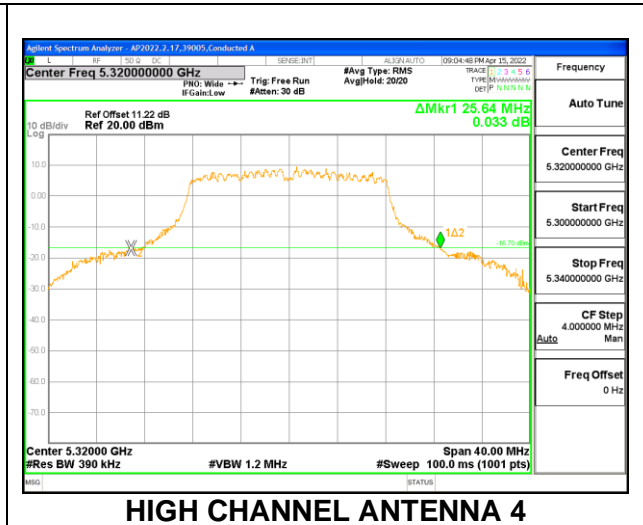
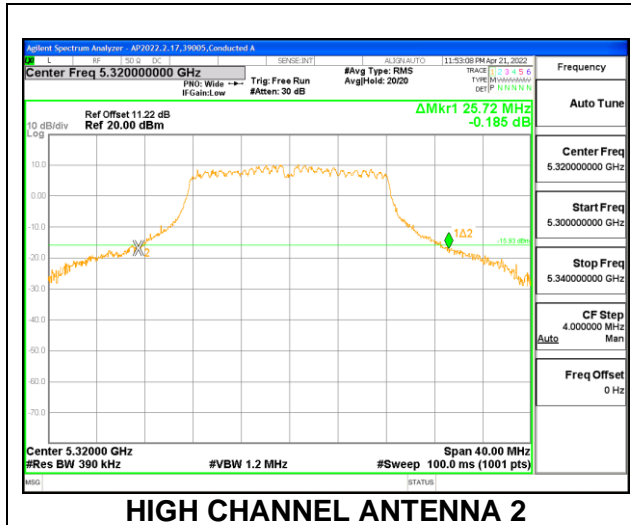

9.2.6. 802.11n HT20 MODE IN THE 5.3 GHz BAND

2TX Antenna 2 + Antenna 4 CDD MODE

Channel	Frequency (MHz)	26 dB Bandwidth Antenna 2 (MHz)	26 dB Bandwidth Antenna 4 (MHz)
Low	5260	25.20	24.88
Mid	5300	24.64	24.76
High	5320	24.80	24.72

LOW CHANNEL

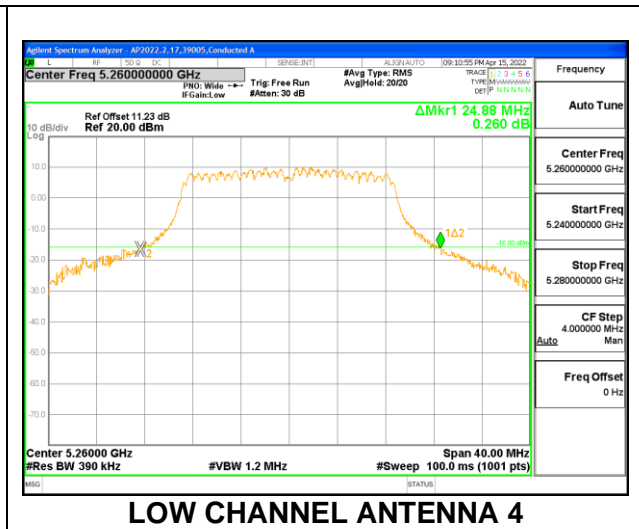
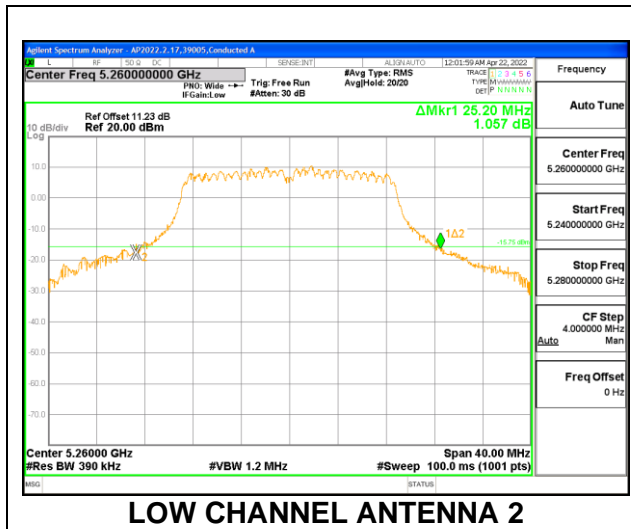

MID CHANNEL

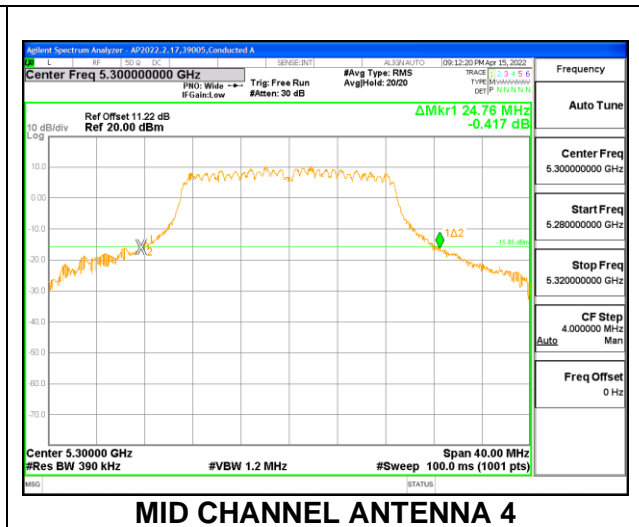
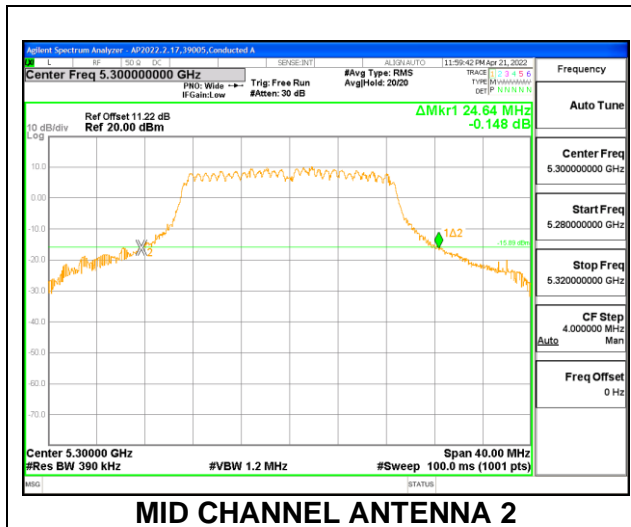

HIGH CHANNEL

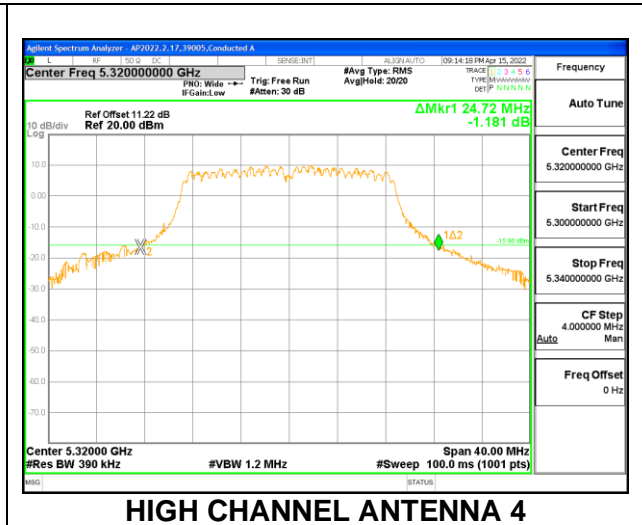
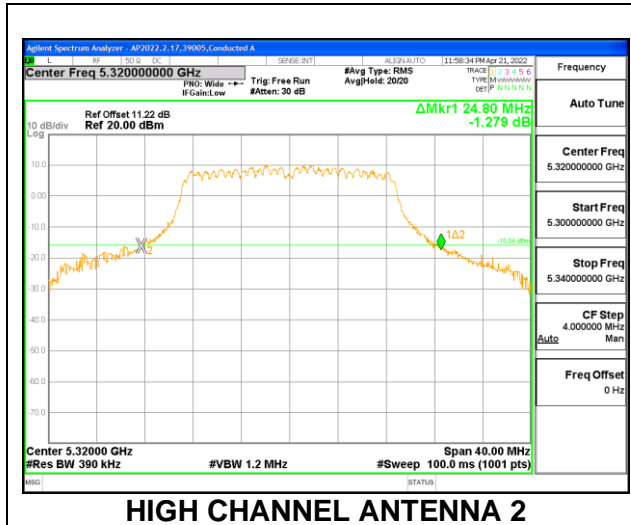

9.2.7. 802.11n HT40 MODE IN THE 5.3 GHz BAND

2TX Antenna 2 + Antenna 4 CDD MODE

Channel	Frequency (MHz)	26 dB Bandwidth Antenna 2 (MHz)	26 dB Bandwidth Antenna 4 (MHz)
Low	5270	40.96	40.72
High	5310	40.88	40.80

LOW CHANNEL

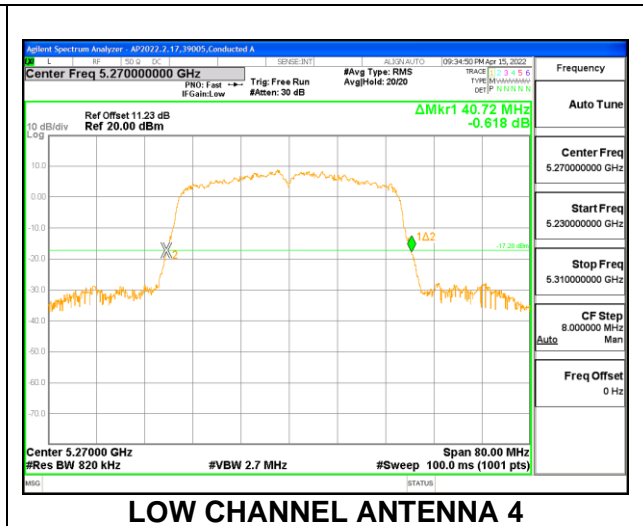
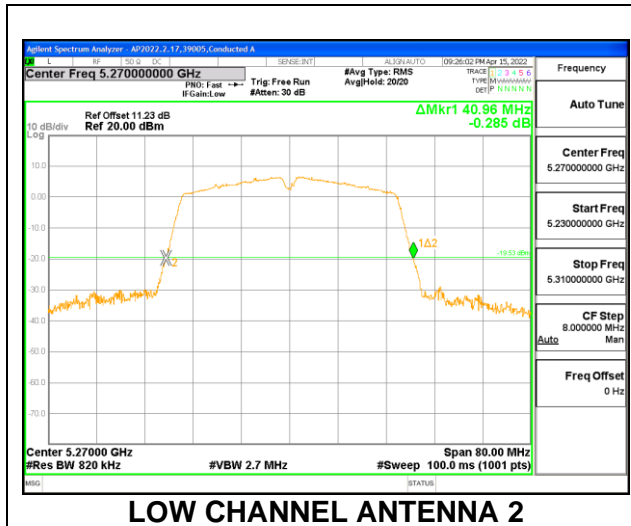

HIGH CHANNEL

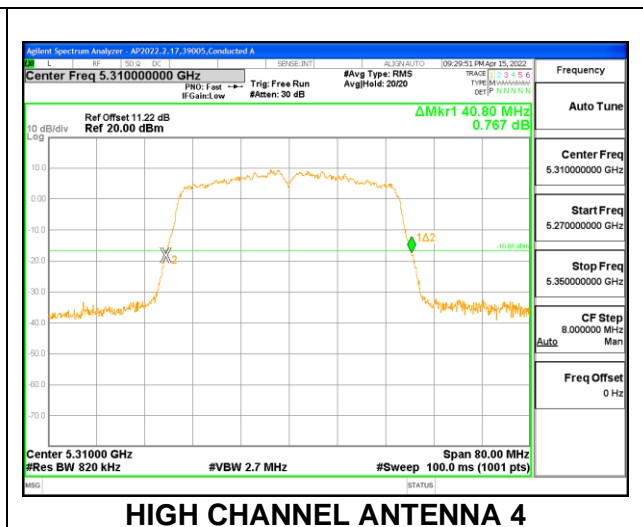
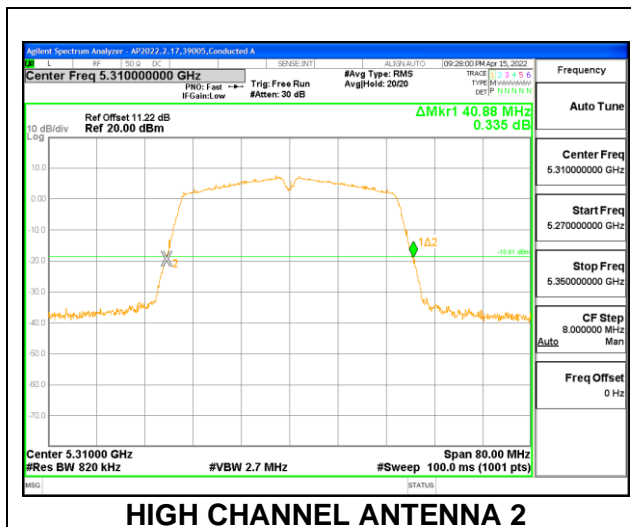

9.2.8. 802.11ac VHT80 MODE IN THE 5.3 GHz BAND

2TX Antenna 2 + Antenna 4 CDD MODE

Channel	Frequency (MHz)	26 dB Bandwidth Antenna 2 (MHz)	26 dB Bandwidth Antenna 4 (MHz)
Mid	5290	80.96	80.32

MID CHANNEL

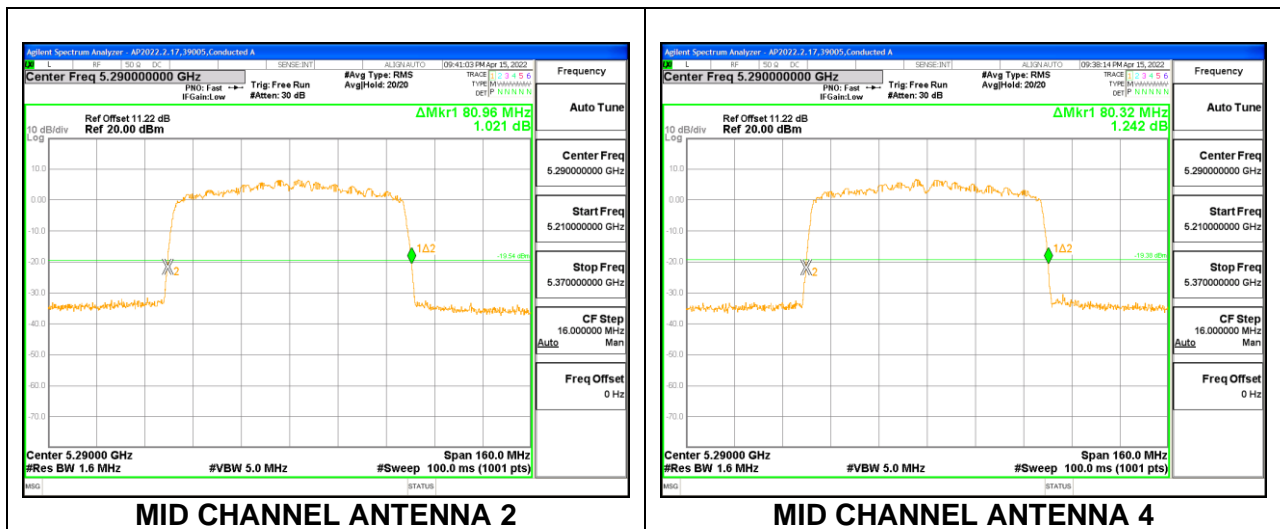

9.2.9. 802.11a MODE IN THE 5.6 GHz BAND

2TX Antenna 2 + Antenna 4 CDD MODE

Channel	Frequency (MHz)	26 dB Bandwidth Antenna 2 (MHz)	26 dB Bandwidth Antenna 4 (MHz)
Low	5500	25.72	25.48
Mid	5580	25.64	25.56
High	5700	25.56	25.12

LOW CHANNEL

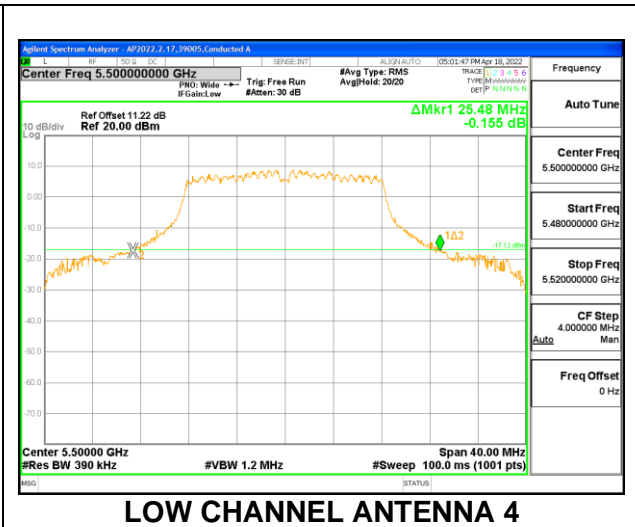
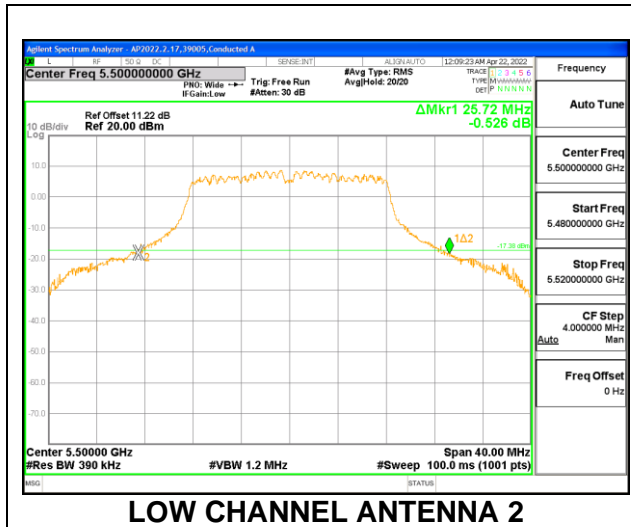

MID CHANNEL

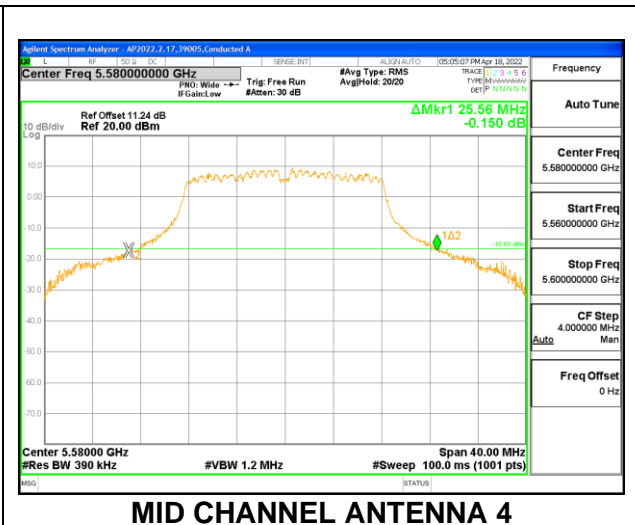
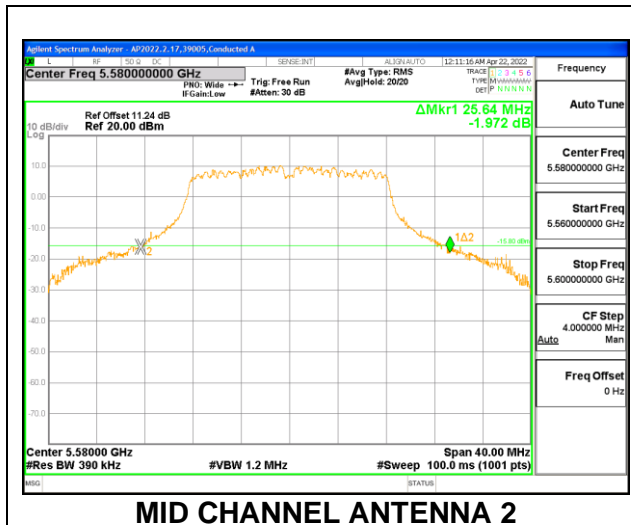

HIGH CHANNEL

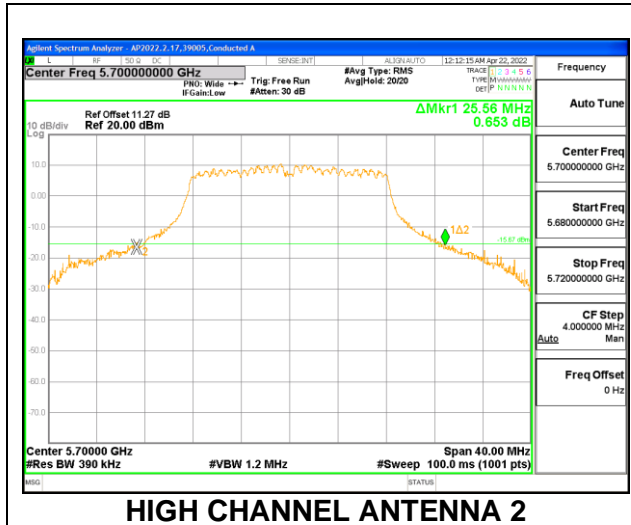

HIGH CHANNEL ANTENNA 2

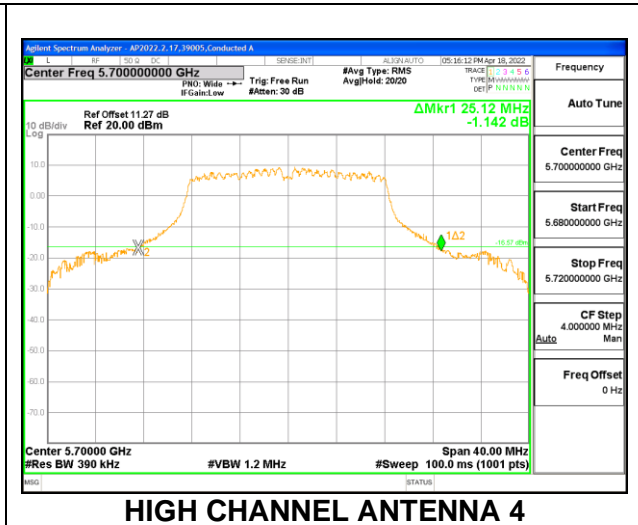

HIGH CHANNEL ANTENNA 4

9.2.10. 802.11n HT20 MODE IN THE 5.6 GHz BAND

2TX Antenna 2 + Antenna 4 CDD MODE

Channel	Frequency (MHz)	26 dB Bandwidth Antenna 2 (MHz)	26 dB Bandwidth Antenna 4 (MHz)
Low	5500	25.28	25.16
Mid	5580	25.20	25.12
High	5700	24.96	24.80

LOW CHANNEL

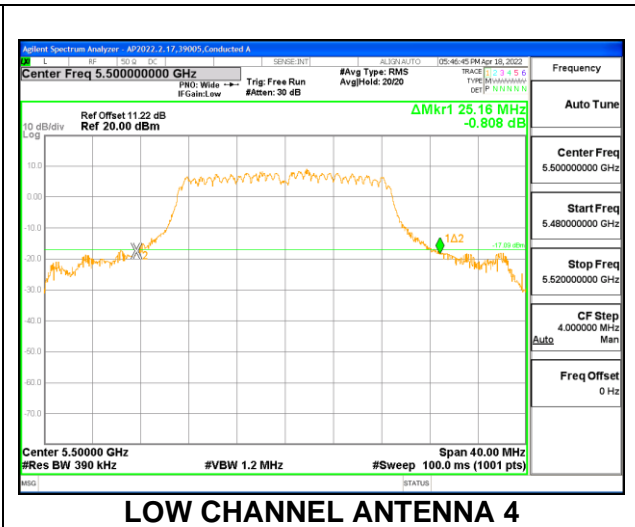
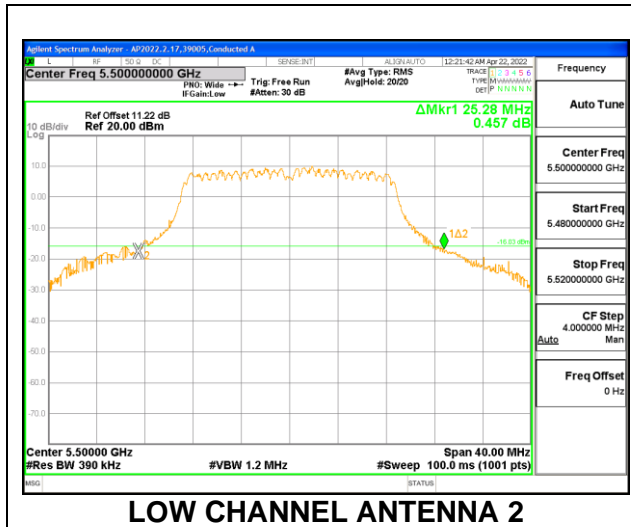

MID CHANNEL

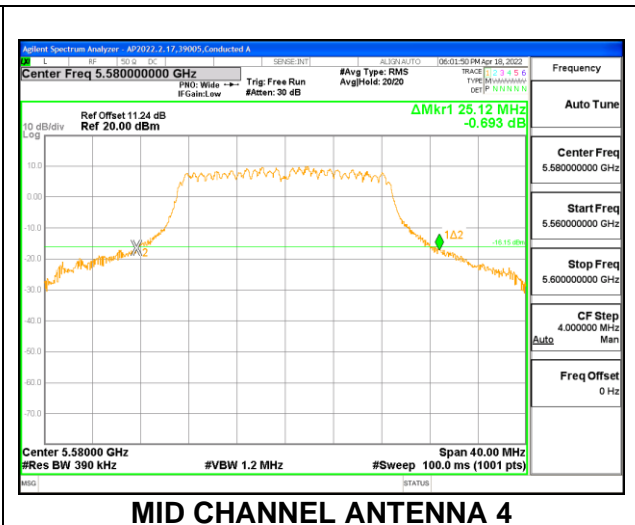
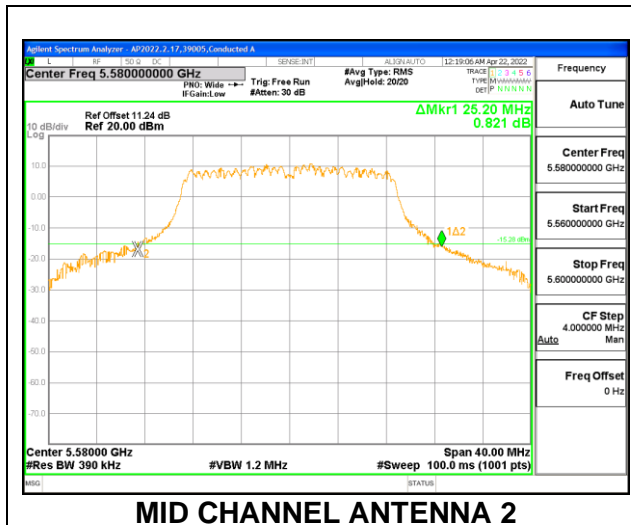

HIGH CHANNEL

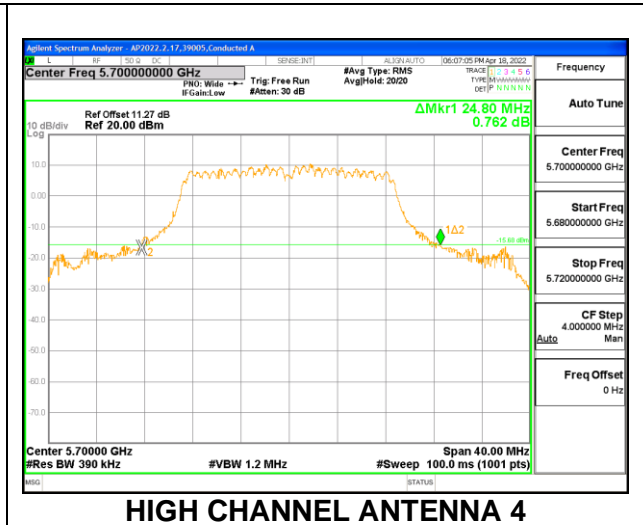
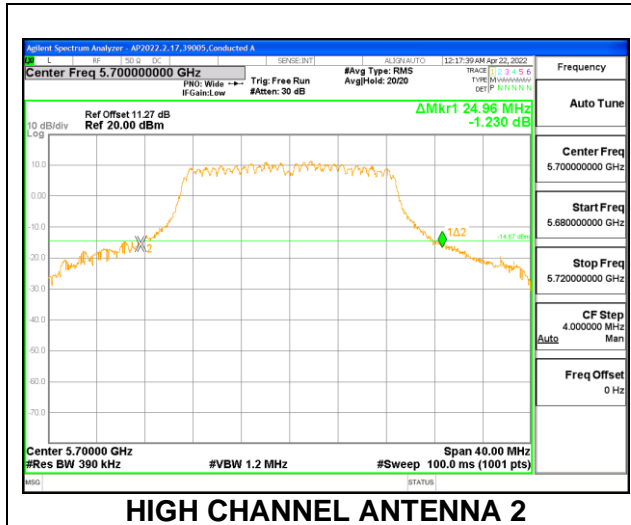

9.2.11. 802.11n HT40 MODE IN THE 5.6 GHz BAND

2TX Antenna 2 + Antenna 4 CDD MODE

Channel	Frequency (MHz)	26 dB Bandwidth Antenna 2 (MHz)	26 dB Bandwidth Antenna 4 (MHz)
Low	5510	40.96	40.48
Mid	5550	40.96	40.64
High	5670	41.12	40.48

LOW CHANNEL

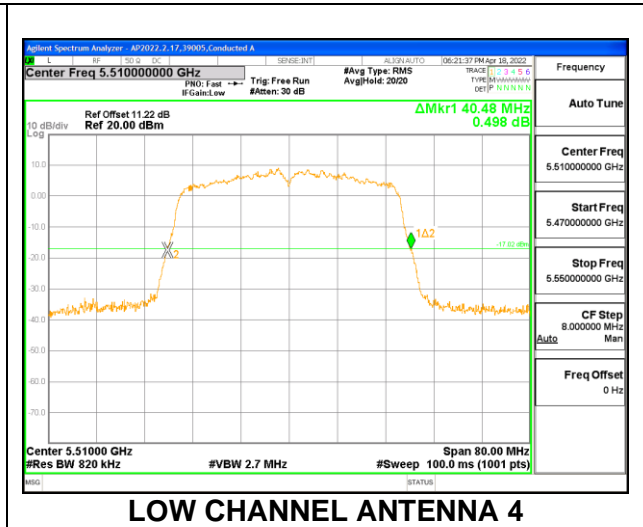
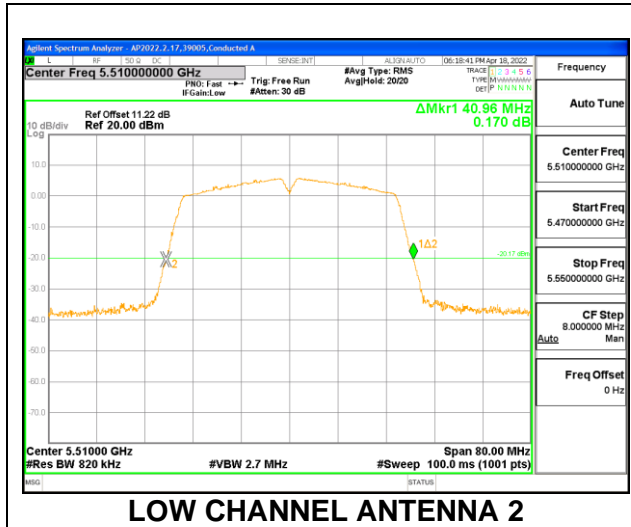

MID CHANNEL

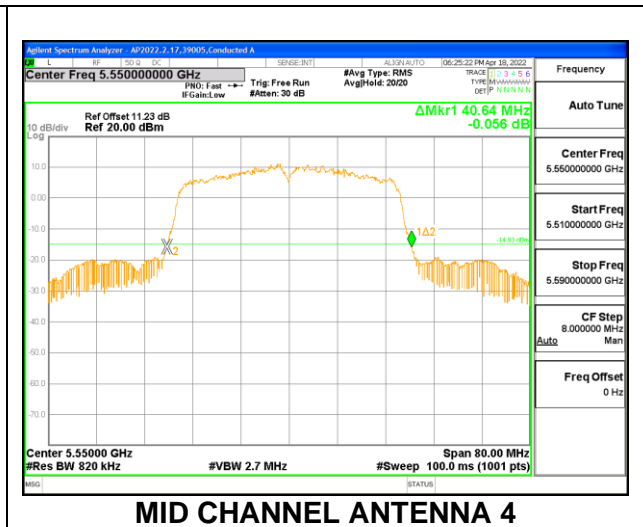
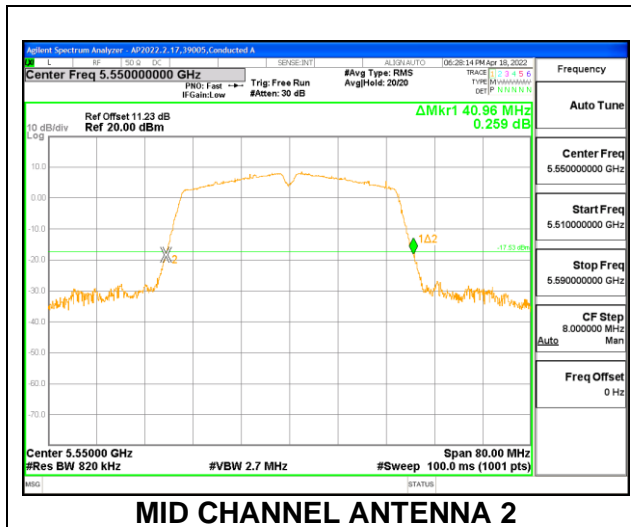

HIGH CHANNEL

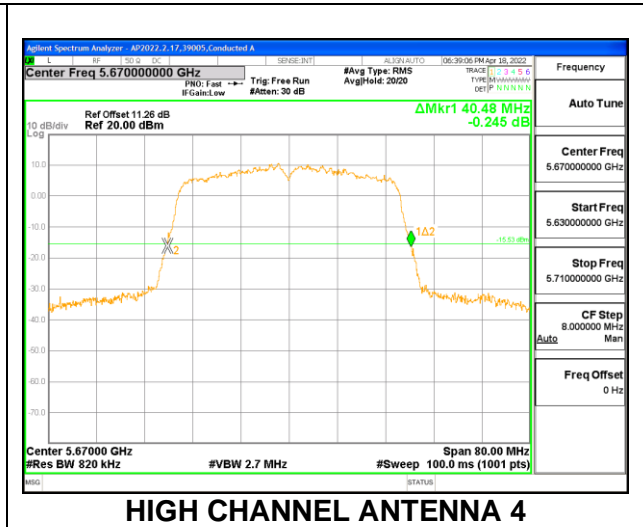
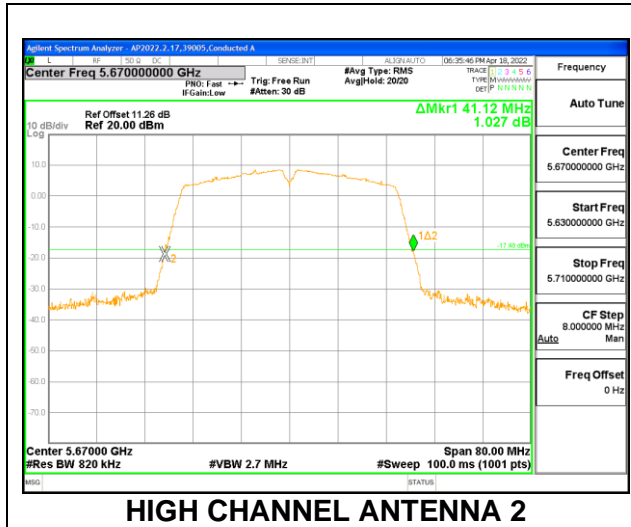

9.2.12. 802.11ac VHT80 MODE IN THE 5.6 GHz BAND

2TX Antenna 2 + Antenna 4 CDD MODE

Channel	Frequency (MHz)	26 dB Bandwidth Antenna 2 (MHz)	26 dB Bandwidth Antenna 4 (MHz)
Low	5530	81.12	80.32
High	5610	81.12	80.32

LOW CHANNEL

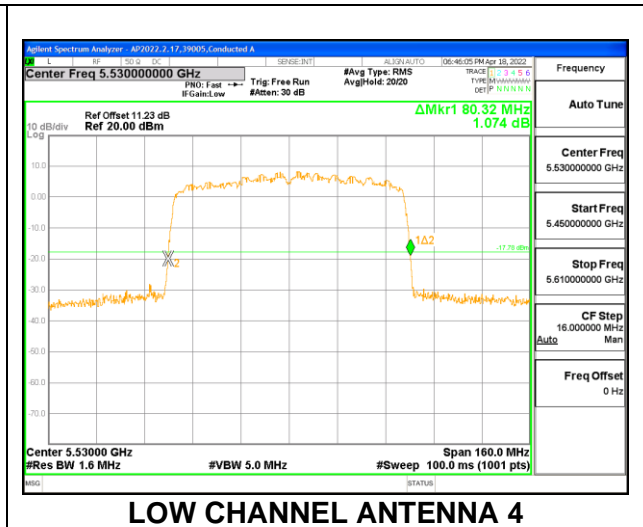
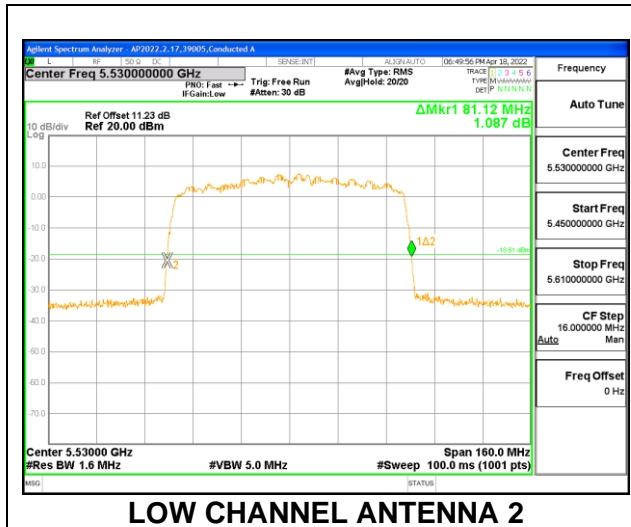

HIGH CHANNEL

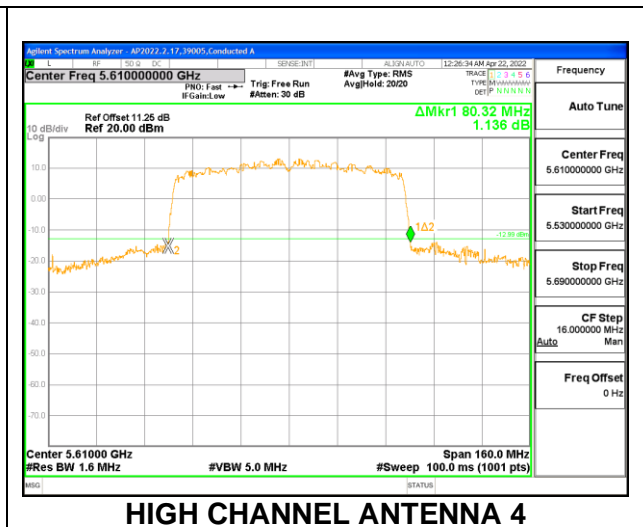
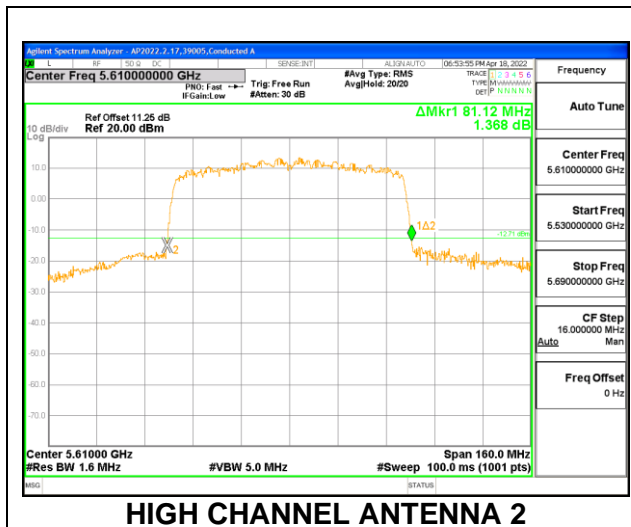

9.2.13. 802.11a MODE IN THE 5.8 GHz BAND

2TX Antenna 1 + Antenna 4 CDD MODE

Channel	Frequency (MHz)	26 dB Bandwidth Antenna 1 (MHz)	26 dB Bandwidth Antenna 4 (MHz)
Low	5745	25.68	25.24
Mid	5785	25.24	26.16
High	5825	25.64	25.20

LOW CHANNEL

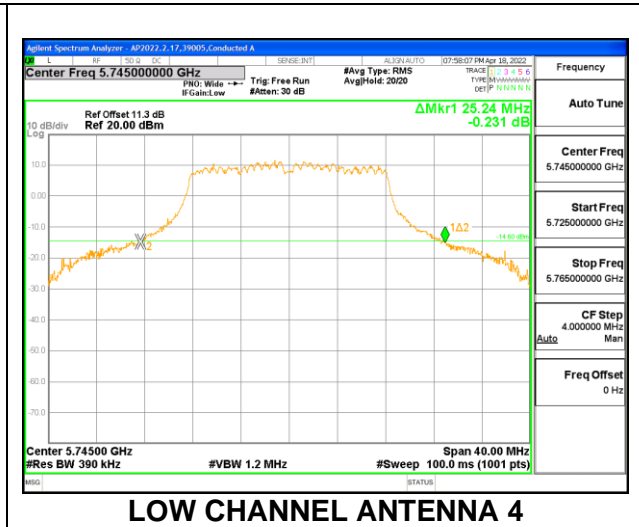
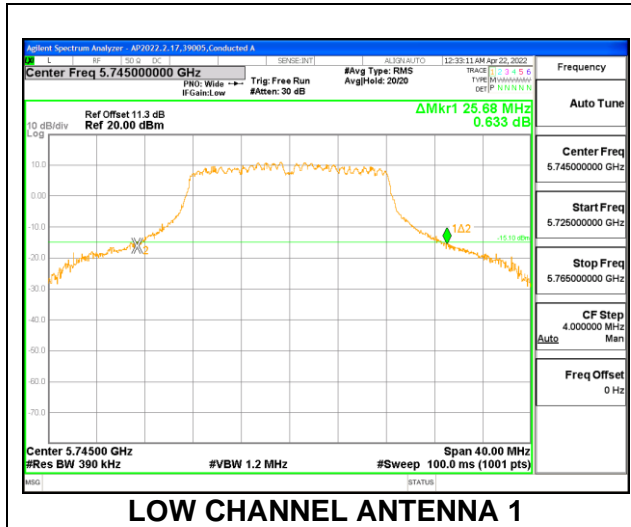

MID CHANNEL

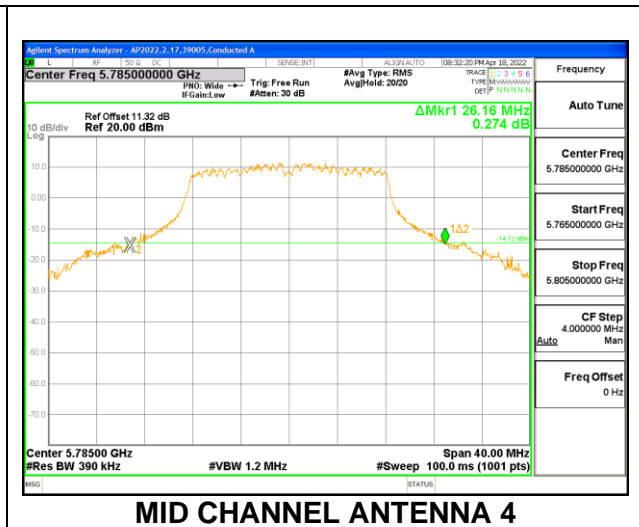
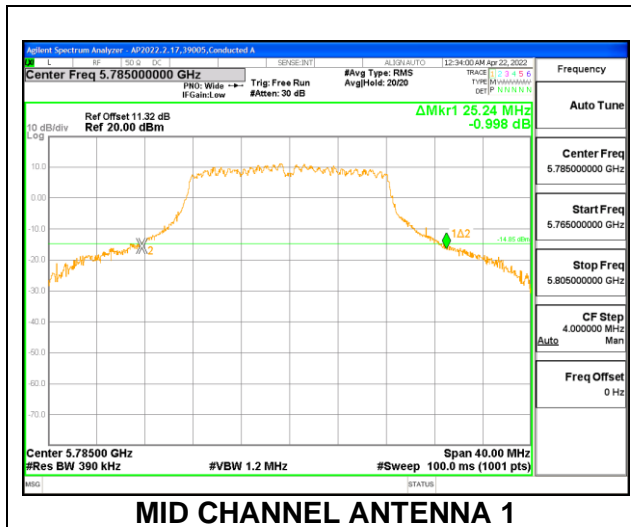

HIGH CHANNEL

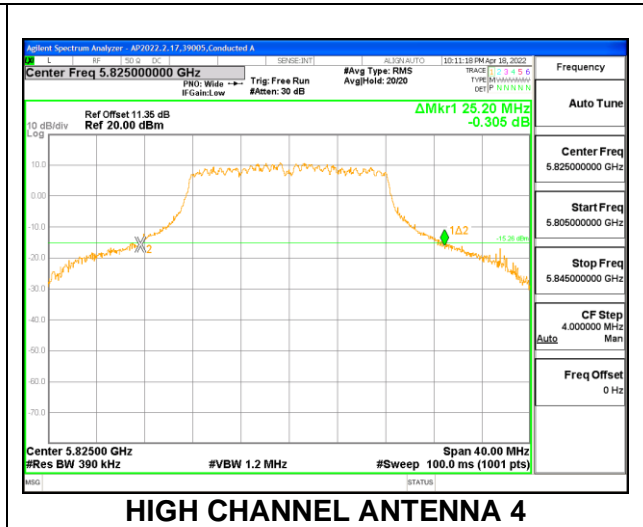
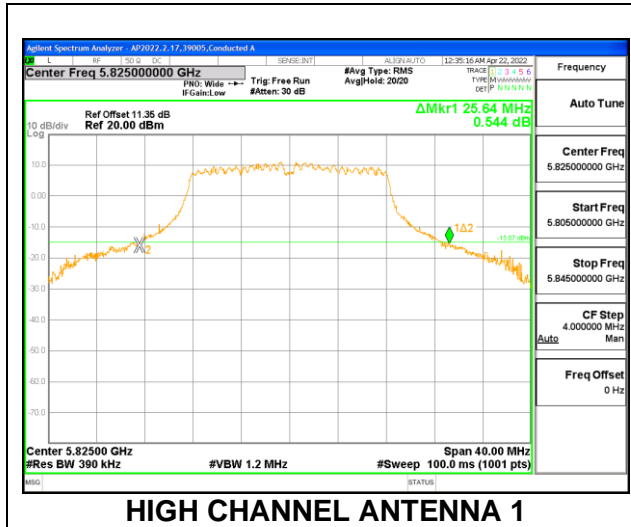

9.2.14. 802.11n HT20 MODE IN THE 5.8 GHz BAND

2TX Antenna 1 + Antenna 4 CDD MODE

Channel	Frequency (MHz)	26 dB Bandwidth Antenna 1 (MHz)	26 dB Bandwidth Antenna 4 (MHz)
Low	5745	26.32	26.20
Mid	5785	26.24	26.32
High	5825	26.20	26.08

LOW CHANNEL

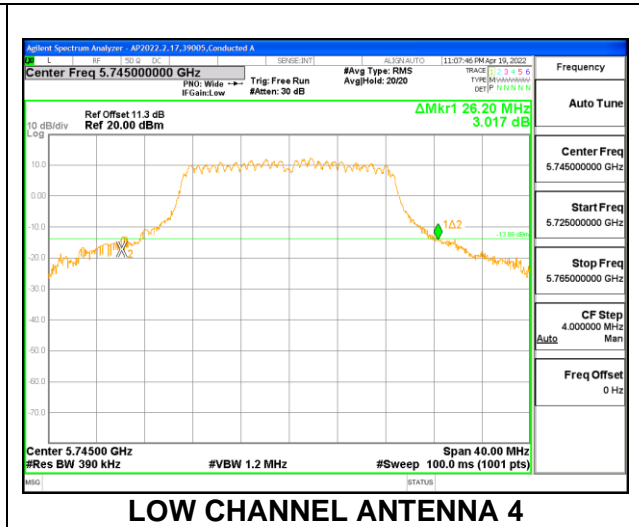
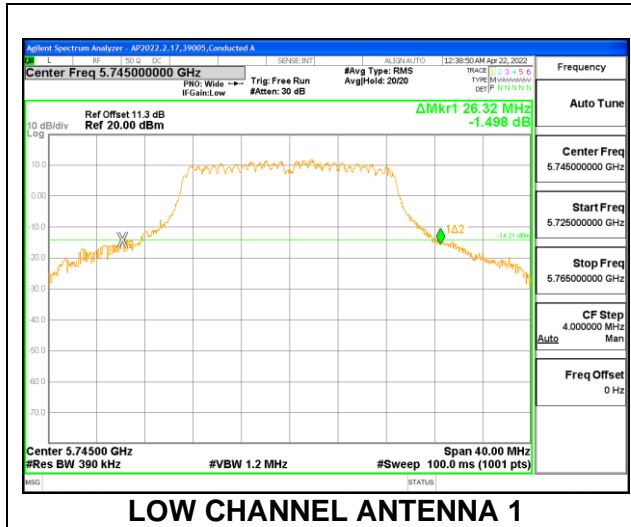

MID CHANNEL

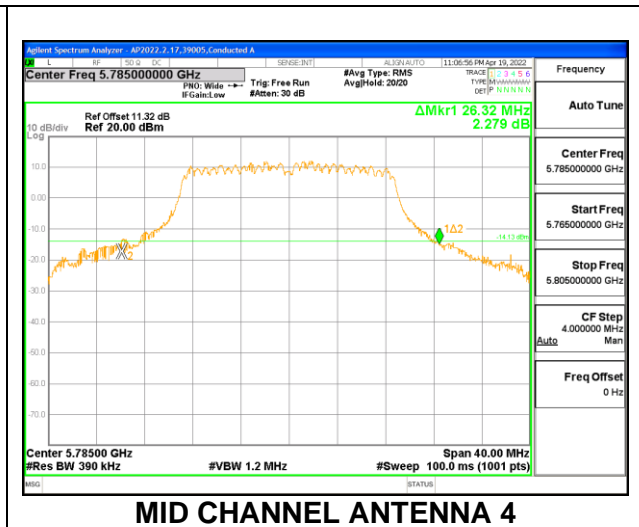
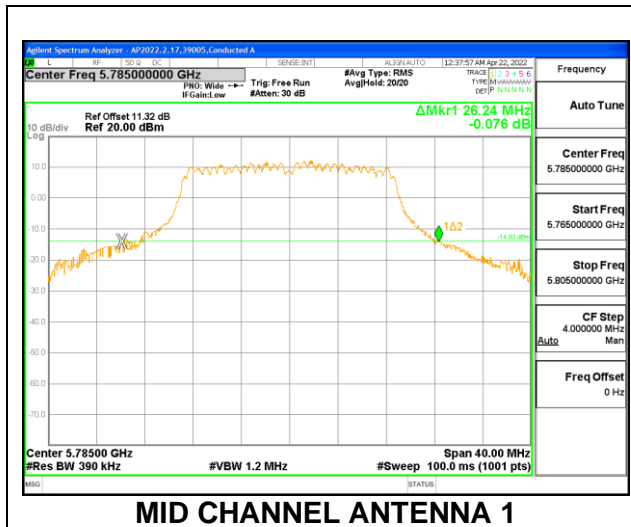

HIGH CHANNEL

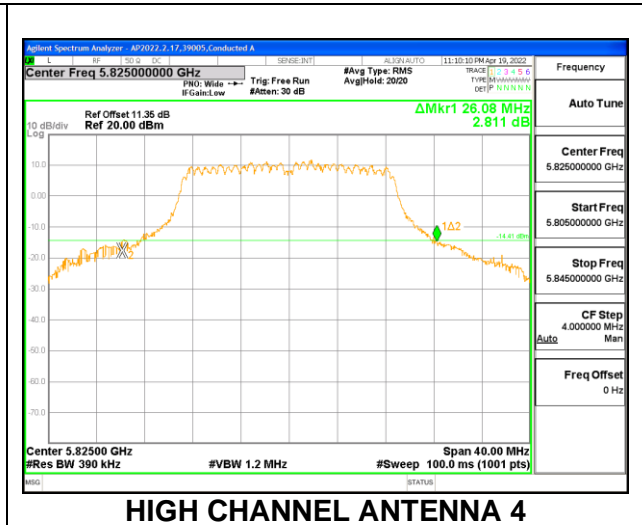
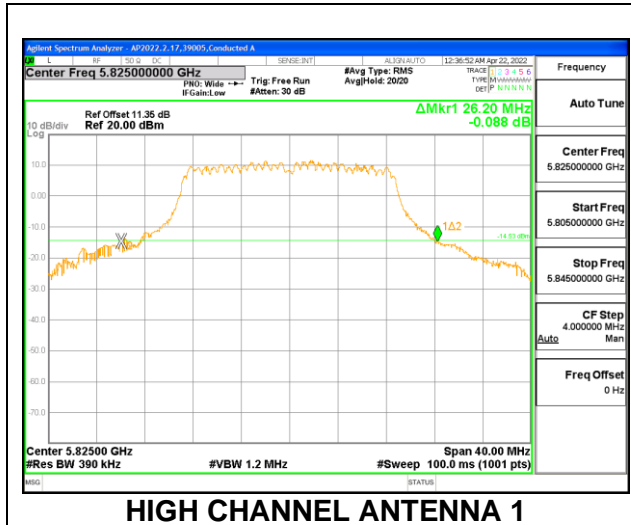

9.2.15. 802.11n HT40 MODE IN THE 5.8 GHz BAND

2TX Antenna 1 + Antenna 4 CDD MODE

Channel	Frequency (MHz)	26 dB Bandwidth Antenna 1 (MHz)	26 dB Bandwidth Antenna 4 (MHz)
Low	5755	40.96	40.72
High	5795	40.72	40.72

LOW CHANNEL

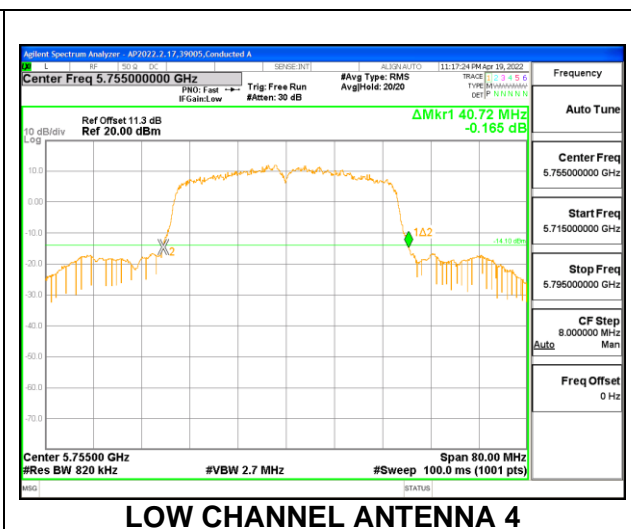
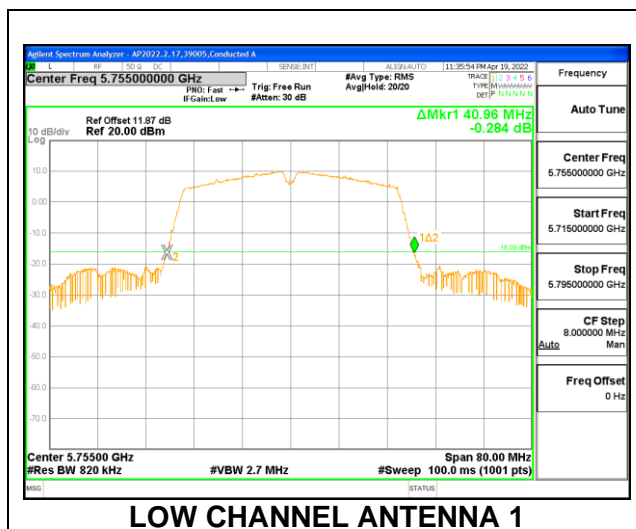

HIGH CHANNEL

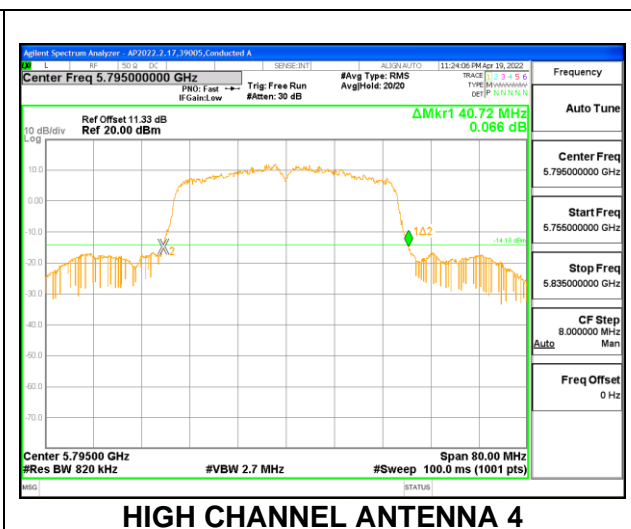
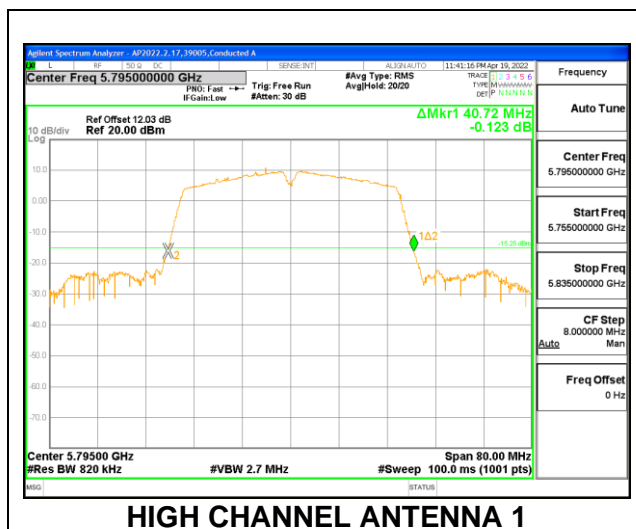

9.2.16. 802.11ac VHT80 MODE IN THE 5.8 GHz BAND

2TX Antenna 1 + Antenna 4 CDD MODE

Channel	Frequency (MHz)	26 dB Bandwidth Antenna 1 (MHz)	26 dB Bandwidth Antenna 4 (MHz)
Mid	5775	81.28	80.48

MID CHANNEL

