



**DFS PORTION of FCC 47 CFR PART 15 SUBPART E  
DFS PORTION of INDUSTRY CANADA RSS-247 ISSUE 2**

**CERTIFICATION TEST REPORT**

**FOR**

**HOME THEATER SPEAKER**

**MODEL NUMBER: S14**

**FCC ID: SBVRM014**

**IC: 5373A-RM014**

**REPORT NUMBER: 11886412-E4V3**

**ISSUE DATE: MARCH 14, 2018**

*Prepared for*

**SONOS INC.**

**614 CHAPALA STREET  
SANTA BARBARA, CA 93101, U.S.A.**

*Prepared by*

**UL VERIFICATION SERVICES INC.**

**47173 BENICIA STREET  
FREMONT, CA 94538, U.S.A.**

**TEL: (510) 771-1000**

**FAX: (510) 661-0888**



**NVLAP LAB CODE 200065-0**

Revision History

<u>Rev.</u>	<u>Issue Date</u>	<u>Revisions</u>	<u>Revised By</u>
V1	12/5/17	Initial Issue	Conan Cheung
V2	3/12/18	Updated EUT description from Wireless Smart Speaker to Home Theater Speaker	Conan Cheung
V3	3/14/18	Expanded description at section 6.1.6	Henry Lau

## TABLE OF CONTENTS

<b>1. ATTESTATION OF TEST RESULTS .....</b>	<b>4</b>
<b>2. TEST METHODOLOGY .....</b>	<b>5</b>
<b>3. REFERENCE DOCUMENTS .....</b>	<b>5</b>
<b>4. FACILITIES AND ACCREDITATION .....</b>	<b>5</b>
<b>5. CALIBRATION AND UNCERTAINTY .....</b>	<b>5</b>
5.1. <i>MEASURING INSTRUMENT CALIBRATION .....</i>	<i>5</i>
5.2. <i>MEASUREMENT UNCERTAINTY .....</i>	<i>5</i>
<b>6. DYNAMIC FREQUENCY SELECTION.....</b>	<b>6</b>
6.1. <i>OVERVIEW .....</i>	<i>6</i>
6.1.1. <i>LIMITS .....</i>	<i>6</i>
6.1.2. <i>TEST AND MEASUREMENT SYSTEM .....</i>	<i>10</i>
6.1.3. <i>TEST AND MEASUREMENT SOFTWARE .....</i>	<i>12</i>
6.1.4. <i>TEST ROOM ENVIRONMENT .....</i>	<i>12</i>
6.1.5. <i>SETUP OF EUT.....</i>	<i>13</i>
6.1.6. <i>DESCRIPTION OF EUT .....</i>	<i>14</i>
6.2. <i>RESULTS FOR 20 MHz BANDWIDTH .....</i>	<i>16</i>
6.2.1. <i>TEST CHANNEL .....</i>	<i>16</i>
6.2.2. <i>RADAR WAVEFORMS AND TRAFFIC.....</i>	<i>16</i>
6.2.3. <i>CHANNEL AVAILABILITY CHECK TIME.....</i>	<i>25</i>
6.2.4. <i>OVERLAPPING CHANNEL TESTS.....</i>	<i>30</i>
6.2.5. <i>MOVE AND CLOSING TIME .....</i>	<i>30</i>
6.2.6. <i>NON-OCCUPANCY PERIOD .....</i>	<i>35</i>
6.2.7. <i>DETECTION BANDWIDTH.....</i>	<i>36</i>
6.2.8. <i>IN-SERVICE MONITORING .....</i>	<i>38</i>
6.3. <i>BRIDGE MODE RESULTS .....</i>	<i>45</i>
<b>7. SETUP PHOTOS.....</b>	<b>46</b>

# 1. ATTESTATION OF TEST RESULTS

**COMPANY NAME:** SONOS INC.  
614 CHAPALA STREET  
SANTA BARARA, CA 93101, U.S.A.

**EUT DESCRIPTION:** HOME THEATER SPEAKER

**MODEL:** S14

**SERIAL NUMBER:** 94-9F-3E-C0-07-20:4

**DATE TESTED:** OCTOBER 09, 2017

APPLICABLE STANDARDS	
STANDARD	TEST RESULTS
DFS Portion of CFR 47 Part 15 Subpart E	Complies
INDUSTRY CANADA RSS-247 Issue 2	Complies

UL Verification Services Inc. tested the above equipment in accordance with the requirements set forth in the above standards. All indications of Pass/Fail in this report are opinions expressed by UL Verification Services Inc. based on interpretations and/or observations of test results. Measurement Uncertainties were not taken into account and are published for informational purposes only. The test results show that the equipment tested is capable of demonstrating compliance with the requirements as documented in this report.

**Note:** The results documented in this report apply only to the tested sample, under the conditions and modes of operation as described herein. This document may not be altered or revised in any way unless done so by UL Verification Services Inc. and all revisions are duly noted in the revisions section. Any alteration of this document not carried out by UL Verification Services Inc. will constitute fraud and shall nullify the document. This report must not be used by the client to claim product certification, approval, or endorsement by NVLAP, NIST, any agency of the Federal Government, or any agency of any government.

Approved & Released For  
UL Verification Services Inc. By:



CONAN CHEUNG  
OPERATIONS LEADER  
UL Verification Services Inc.

Tested By:



DOUGLAS ANDERSON  
LABORATORY ENGINEER  
UL Verification Services Inc.

## 2. TEST METHODOLOGY

The tests documented in this report were performed in accordance with the DFS portion of FCC CFR 47 Part 2, FCC CFR 47 Part 15, FCC 06-96, FCC KDB 789033, KDB 905462 D02 and D03 and RSS-247 Issue 2.

## 3. REFERENCE DOCUMENTS

Measurements of transmitter parameters as referenced in this report are documented in UL Report number 11886412-E3V1 FCC IC UNII WLAN Report.

## 4. FACILITIES AND ACCREDITATION

The test sites and measurement facilities used to collect data are located at 47173 Benicia Street, Fremont, California, USA.

UL Verification Services, Inc. is accredited by NVLAP, Laboratory Code 200065-0. The full scope of accreditation can be viewed at <http://ts.nist.gov/standards/scopes/2000650.htm>.

IC RSS-247 Issue 2 is outside the scope of the laboratory's accreditation.

## 5. CALIBRATION AND UNCERTAINTY

### 5.1. MEASURING INSTRUMENT CALIBRATION

The measuring equipment utilized to perform the tests documented in this report has been calibrated in accordance with the manufacturer's recommendations, and is traceable to recognized national standards.

### 5.2. MEASUREMENT UNCERTAINTY

Where relevant, the following measurement uncertainty level has been estimated for tests performed on the apparatus:

PARAMETER	UNCERTAINTY
Time	$\pm 0.02$ %

The Uncertainty figure is valid to a confidence level of 95%.

## 6. DYNAMIC FREQUENCY SELECTION

### 6.1. OVERVIEW

#### 6.1.1. LIMITS

##### INDUSTRY CANADA

IC RSS-247 is closely harmonized with FCC Part 15 DFS rules. The deviations are as follows:

RSS-247 Issue 2

**Note:** For the band 5600–5650 MHz, no operation is permitted.

Until further notice, devices subject to this annex shall not be capable of transmitting in the band 5600–5650 MHz. This restriction is for the protection of Environment Canada weather radars operating in this band.

##### FCC

§15.407 (h), FCC KDB 905462 D02 “COMPLIANCE MEASUREMENT PROCEDURES FOR UNLICENSED-NATIONAL INFORMATION INFRASTRUCTURE DEVICES OPERATING IN THE 5250-5350 MHz AND 5470-5725 MHz BANDS INCORPORATING DYNAMIC FREQUENCY SELECTION” and KDB 905462 D03 “U-NII CLIENT DEVICES WITHOUT RADAR DETECTION CAPABILITY”.

**Table 1: Applicability of DFS requirements prior to use of a channel**

Requirement	Operational Mode		
	Master	Client (without radar detection)	Client (with radar detection)
Non-Occupancy Period	Yes	Not required	Yes
DFS Detection Threshold	Yes	Not required	Yes
Channel Availability Check Time	Yes	Not required	Not required
U-NII Detection Bandwidth	Yes	Not required	Yes

**Table 2: Applicability of DFS requirements during normal operation**

Requirement	Operational Mode		
	Master	Client (without DFS)	Client (with DFS)
DFS Detection Threshold	Yes	Not required	Yes
Channel Closing Transmission Time	Yes	Yes	Yes
Channel Move Time	Yes	Yes	Yes
U-NII Detection Bandwidth	Yes	Not required	Yes

Additional requirements for devices with multiple bandwidth modes	Master Device or Client with Radar DFS	Client (without DFS)
<i>U-NII Detection Bandwidth and Statistical Performance Check</i>	All BW modes must be tested	Not required
<i>Channel Move Time and Channel Closing Transmission Time</i>	Test using widest BW mode available	Test using the widest BW mode available for the link
<i>All other tests</i>	Any single BW mode	Not required
<b>Note:</b> Frequencies selected for statistical performance check (Section 7.8.4) should include several frequencies within the radar detection bandwidth and frequencies near the edge of the radar detection bandwidth. For 802.11 devices it is suggested to select frequencies in all 20 MHz channel blocks and a null frequency between the bonded 20 MHz channel blocks.		

**Table 3: Interference Threshold values, Master or Client incorporating In-Service Monitoring**

Maximum Transmit Power	Value (see notes)
E.I.R.P. $\geq$ 200 mill watt	-64 dBm
E.I.R.P. < 200 mill watt and power spectral density < 10 dBm/MHz	-62 dBm
E.I.R.P. < 200 mill watt that do not meet power spectral density requirement	-64 dBm
<p><b>Note 1:</b> This is the level at the input of the receiver assuming a 0 dBi receive antenna  <b>Note 2:</b> Throughout these test procedures an additional 1 dB has been added to the amplitude of the test transmission waveforms to account for variations in measurement equipment. This will ensure that the test signal is at or above the detection threshold level to trigger a DFS response.  <b>Note 3:</b> E.I.R.P. is based on the highest antenna gain. For MIMO devices refer to KDB publication 662911 D01.</p>	

**Table 4: DFS Response requirement values**

Parameter	Value
<i>Non-occupancy period</i>	30 minutes
<i>Channel Availability Check Time</i>	60 seconds
<i>Channel Move Time</i>	10 seconds (See Note 1)
<i>Channel Closing Transmission Time</i>	200 milliseconds + approx. 60 milliseconds over remaining 10 second period. (See Notes 1 and 2)
<i>U-NII Detection Bandwidth</i>	Minimum 100% of the U-NII 99% transmission power bandwidth. (See Note 3)
<p><b>Note 1:</b> <i>Channel Move Time</i> and the <i>Channel Closing Transmission Time</i> should be performed with Radar Type 0. The measurement timing begins at the end of the Radar Type 0 burst.  <b>Note 2:</b> The <i>Channel Closing Transmission Time</i> is comprised of 200 milliseconds starting at the beginning of the <i>Channel Move Time</i> plus any additional intermittent control signals required to facilitate a <i>Channel</i> move (an aggregate of 60 milliseconds) during the remainder of the 10 second period. The aggregate duration of control signals will not count quiet periods in between transmissions.  <b>Note 3:</b> During the <i>U-NII Detection Bandwidth</i> detection test, radar type 0 should be used. For each frequency step the minimum percentage of detection is 90 percent. Measurements are performed with no data traffic.</p>	



**Table 5 – Short Pulse Radar Test Waveforms**

Radar Type	Pulse Width (usec)	PRI (usec)	Pulses	Minimum Percentage of Successful Detection	Minimum Trials
0	1	1428	18	See Note 1	See Note 1
1	1	Test A: 15 unique PRI values randomly selected from the list of 23 PRI values in table 5a	Roundup: $\{(1/360) \times (19 \times 10^6 \text{ PRI}_{\text{usec}})\}$	60%	30
		Test B: 15 unique PRI values randomly selected within the range of 518-3066 usec. With a minimum increment of 1 usec, excluding PRI values selected in Test A			
2	1-5	150-230	23-29	60%	30
3	6-10	200-500	16-18	60%	30
4	11-20	200-500	12-16	60%	30
Aggregate (Radar Types 1-4)				80%	120
<b>Note 1:</b> Short Pulse Radar Type 0 should be used for the <i>Detection Bandwidth</i> test, <i>Channel Move Time</i> , and <i>Channel Closing Time</i> tests.					

*Table 6 – Long Pulse Radar Test Signal*

Radar Waveform Type	Pulse Width (μsec)	Chirp Width (MHz)	PRI (μsec)	Pulses per Burst	Number of Bursts	Minimum Percentage of Successful Detection	Minimum Trials
5	50-100	5-20	1000-2000	1-3	8-20	80%	30

**Table 7 – Frequency Hopping Radar Test Signal**

Radar Waveform Type	Pulse Width (μsec)	PRI (μsec)	Pulses per Hop	Hopping Rate (kHz)	Hopping Sequence Length (msec)	Minimum Percentage of Successful Detection	Minimum Trials
6	1	333	9	0.333	300	70%	30

### 6.1.2. TEST AND MEASUREMENT SYSTEM

#### RADIATED METHOD SYSTEM BLOCK DIAGRAM

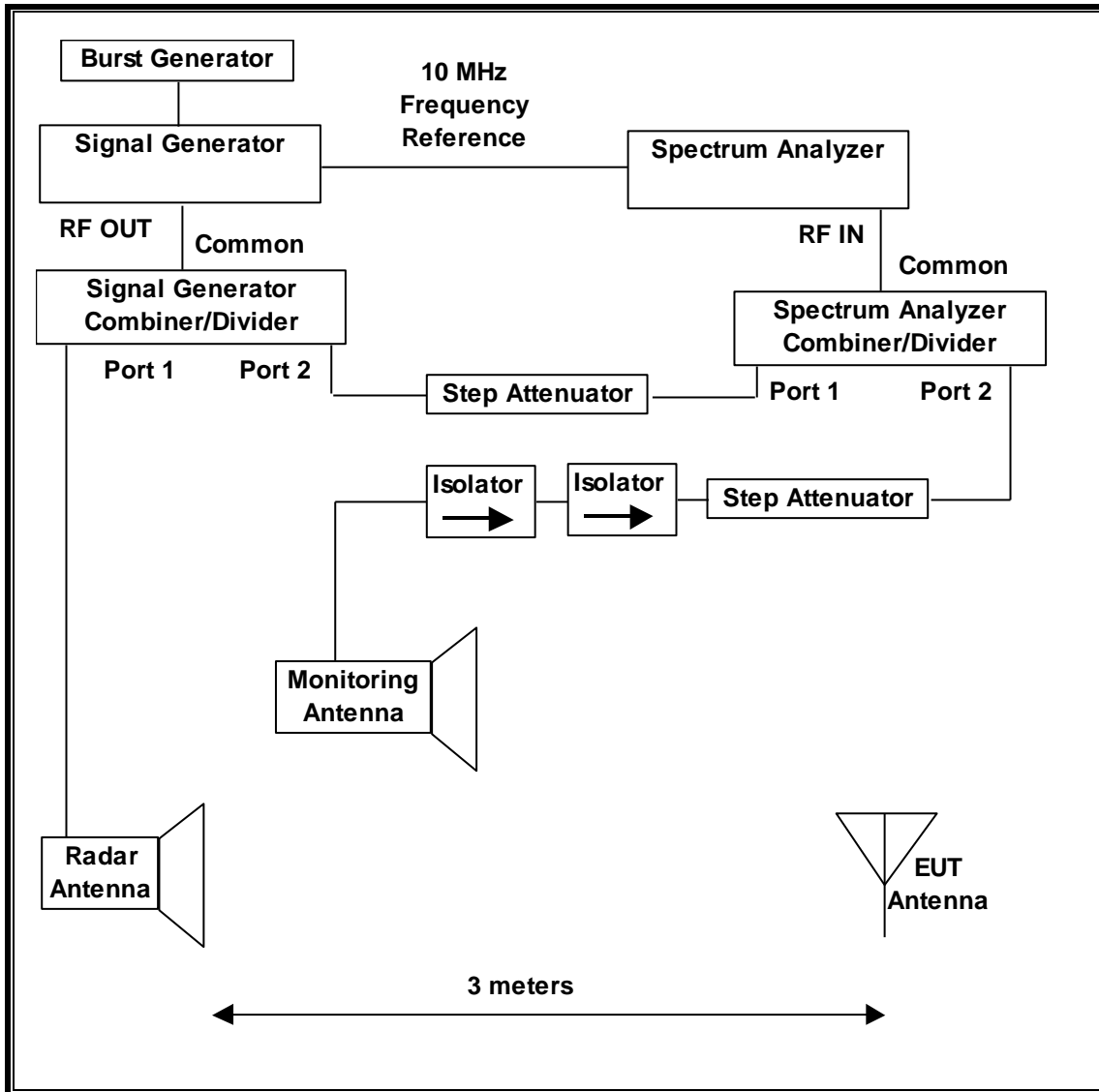

## **SYSTEM OVERVIEW**

The short pulse and long pulse signal generating system utilizes the NTIA software. The Vector Signal Generator has been validated by the NTIA. The hopping signal generating system utilizes the CCS simulated hopping method and system, which has been validated by the DoD, FCC and NTIA. The software selects waveform parameters from within the bounds of the signal type on a random basis using uniform distribution.

The short pulse types 1, 2, 3 and 4, and the long pulse type 5 parameters are randomized at run-time.

The hopping type 6 pulse parameters are fixed while the hopping sequence is based on the August 2005 NTIA Hopping Frequency List. The initial starting point randomized at run-time and each subsequent starting point is incremented by 475. Each frequency in the 100-length segment is compared to the boundaries of the EUT Detection Bandwidth and the software creates a hopping burst pattern in accordance with Section 7.4.1.3 Method #2 Simulated Frequency Hopping Radar Waveform Generating Subsystem of KDB 905462 D02. The frequency of the signal generator is incremented in 1 MHz steps from  $F_L$  to  $F_H$  for each successive trial. This incremental sequence is repeated as required to generate a minimum of 30 total trials and to maintain a uniform frequency distribution over the entire Detection Bandwidth.

The signal monitoring equipment consists of a spectrum analyzer. The aggregate ON time is calculated by multiplying the number of bins above a threshold during a particular observation period by the dwell time per bin, with the analyzer set to peak detection and max hold.

## **SYSTEM CALIBRATION**

A 50-ohm load is connected in place of the spectrum analyzer, and the spectrum analyzer is connected to a horn antenna via a coaxial cable, with the reference level offset set to (horn antenna gain – coaxial cable loss). The signal generator is set to CW mode. The amplitude of the signal generator is adjusted to yield a level of –64 dBm as measured on the spectrum analyzer.

Without changing any of the instrument settings, the spectrum analyzer is reconnected to the Common port of the Spectrum Analyzer Combiner/Divider. The Reference Level Offset of the spectrum analyzer is adjusted so that the displayed amplitude of the signal is –64 dBm.

The spectrum analyzer displays the level of the signal generator as received at the antenna ports of the Master Device. The interference detection threshold may be varied from the calibrated value of –64 dBm and the spectrum analyzer will still indicate the level as received by the Master Device.

**ADJUSTMENT OF DISPLAYED TRAFFIC LEVEL**

A link is established between the Master and Slave and the distance between the units is adjusted as needed to provide a suitable received level at the Master and Slave devices. The video test file is streamed to generate WLAN traffic. The monitoring antenna is adjusted so that the WLAN traffic level, as displayed on the spectrum analyzer, is at lower amplitude than the radar detection threshold.

**TEST AND MEASUREMENT EQUIPMENT**

The following test and measurement equipment was utilized for the DFS tests documented in this report:

TEST EQUIPMENT LIST				
Description	Manufacturer	Model	Serial Number	Cal Due
Spectrum Analyzer, PXA, 3Hz to 44GHz	Keysight	N9030A	US51350187	06/22/18
Signal Generator, MXG X-Series RF Vector	Agilent	N5182B	MY51350337	04/21/18
Arbitrary Waveform Generator	Agilent / HP	33220A	MY44037572	04/06/18

**6.1.3. TEST AND MEASUREMENT SOFTWARE**

The following test and measurement software was utilized for the tests documented in this report:

TEST SOFTWARE LIST		
Name	Version	Test / Function
Aggregate Time-PXA	3.0	Channel Loading and Aggregate Closing Time
FCC 2014 Detection Bandwidth-PXA	3.0	Detection Bandwidth in 5 MHz Steps
In Service Monitoring-PXA	3.0	In-Service Monitoring (Probability of Detection)
PXA Read	3.0.0.9	Signal Generator Screen Capture
SGXProject.exe	1.7	Radar Waveform Generation and Download

**6.1.4. TEST ROOM ENVIRONMENT**

The test room temperature and humidity shall be maintained within normal temperature of 15~35 °C and normal humidity 20~75% (relative humidity).

**ENVIRONMENT CONDITION**

Parameter	Value
Temperature	23.8 °C
Humidity	31 %

### 6.1.5. SETUP OF EUT

#### RADIATED METHOD EUT TEST SETUP

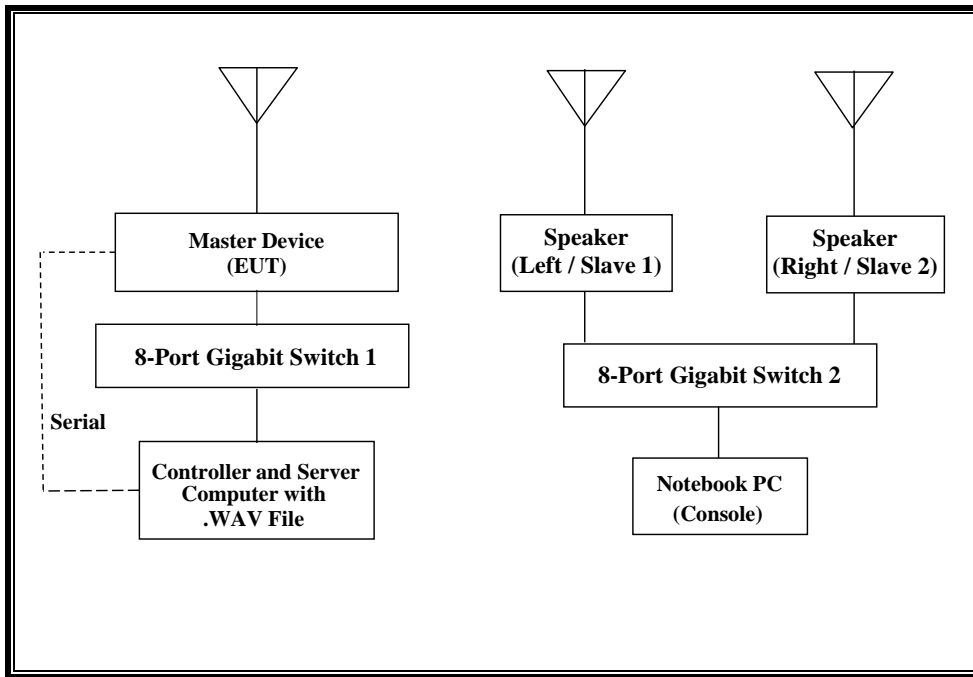

#### SUPPORT EQUIPMENT

The following support equipment was utilized for the DFS tests documented in this report:

PERIPHERAL SUPPORT EQUIPMENT LIST				
Description	Manufacturer	Model	Serial Number	FCC ID
Notebook PC (Controller/Server)	Lenovo	Type 4319-64U	R0-CHV8E 11/03	DoC
AC Adapter (Controller/Server PC)	Lenovo	45N0055	11S45N0054Z1ZG8P0570J J	DoC
8-Port Gigabit Switch (EUT)	Netgear	GS108	21620B3N0314F	DoC
AC Adapter (Switch)	Netgear	T012LF1209	31103914P10166201W	DoC
Speaker (Slave 1 / Left)	Sonos	Play:1	5C-AA-FD-4D-F7-F6:7	SBVRM007
Speaker (Slave 2 / Right)	Sonos	Play:1	B8-E9-37-57-00-1E:2	SBVRM007
Notebook PC (Slave Console)	Dell	P05G	CN-04HKYP-12961	DoC
AC Adapter (Console PC)	Dell	DA65NM111-00	CN-0N6M8J-48661-1AQ- DQ6L-A02	DoC
8-Port Gigabit Switch (Slave)	Netgear	GS308	38A145WK00FFE	DoC
AC Adapter (Switch)	Netgear	WA-24E12FU	Y720113301000049900	DoC

### 6.1.6. DESCRIPTION OF EUT

For FCC the EUT operates over the 5250-5350 MHz and 5470-5725 MHz ranges.

For IC the EUT operates over the 5250-5350 MHz and 5470-5725 MHz ranges, excluding the 5600-5650 MHz range.

The EUT is a 802.11 a/b/g/n (HT20) master device. The model S14 is a high-performance all-in-one home theater smart speaker and part of Sonos' home sound system.

The highest power level within these bands is 23.45 dBm EIRP in the 5250-5350 MHz band and 22.94 dBm EIRP in the 5470-5725 MHz band.

The only antenna assembly utilized with the EUT is constructed using four antennas with respective gains of 3.57 dBi, 3.40 dBi, 3.49 dBi and 2.92 dBi in the 5470-5725 MHz band.

Four antennas are utilized to meet the diversity and MIMO operational requirements.

The rated output power of the Master unit is > 23dBm (EIRP). Therefore the required interference threshold level is -64 dBm. After correction for procedural adjustments, the required radiated threshold at the antenna port is  $-64 + 1 = -63$  dBm.

The calibrated radiated DFS Detection Threshold level is set to -64 dBm. The tested level is lower than the required level hence it provides a margin to the limit.

The EUT uses four transmitter/receiver chains, each connected to an antenna to perform radiated tests.

The Slave device associated with the EUT during these tests does not have radar detection capability.

WLAN traffic that meets or exceeds the minimum required channel loading was generated by streaming the audio file "5\_GHz\_Audio\_Test\_file.WAV" from the Master to the Slave using Sonos Home Controller version 8.2 software while concurrently sending a data stream from the Master to the Slave using the proprietary traffic generator software "Cont Tx".

TPC is not required since the maximum EIRP is less than 500 mW (27 dBm).

The EUT utilizes the 802.11a/n architecture. One nominal channel bandwidth, 20 MHz, is implemented.

The software installed in the EUT is version 8.2 (build 39145260mcs9\_dev).

### **UNIFORM CHANNEL SPREADING**

This function is not required per KDB 905462.

### **OVERVIEW OF MASTER DEVICE WITH RESPECT TO §15.407 (h) REQUIREMENTS**

The Master Device is a Sonos HOME THEATER SPEAKER, FCC ID: SBVRM014. The EUT is constructed using four antennas with respective gains of 3.57 dBi, 3.40 dBi, 3.49 dBi and 2.92 dBi in the 5470-5725 MHz band.

The rated output power of the Master unit is > 23dBm (EIRP). Therefore the required interference threshold level is -64 dBm. After correction for procedural adjustments, the required radiated threshold at the antenna port is  $-64 + 1 = -63$  dBm.

The calibrated radiated DFS Detection Threshold level is set to -64 dBm. The tested level is lower than the required level hence it provides a margin to the limit.

## 6.2. RESULTS FOR 20 MHz BANDWIDTH

### 6.2.1. TEST CHANNEL

All tests were performed at a channel center frequency of 5500 MHz.

### 6.2.2. RADAR WAVEFORMS AND TRAFFIC

#### RADAR WAVEFORMS

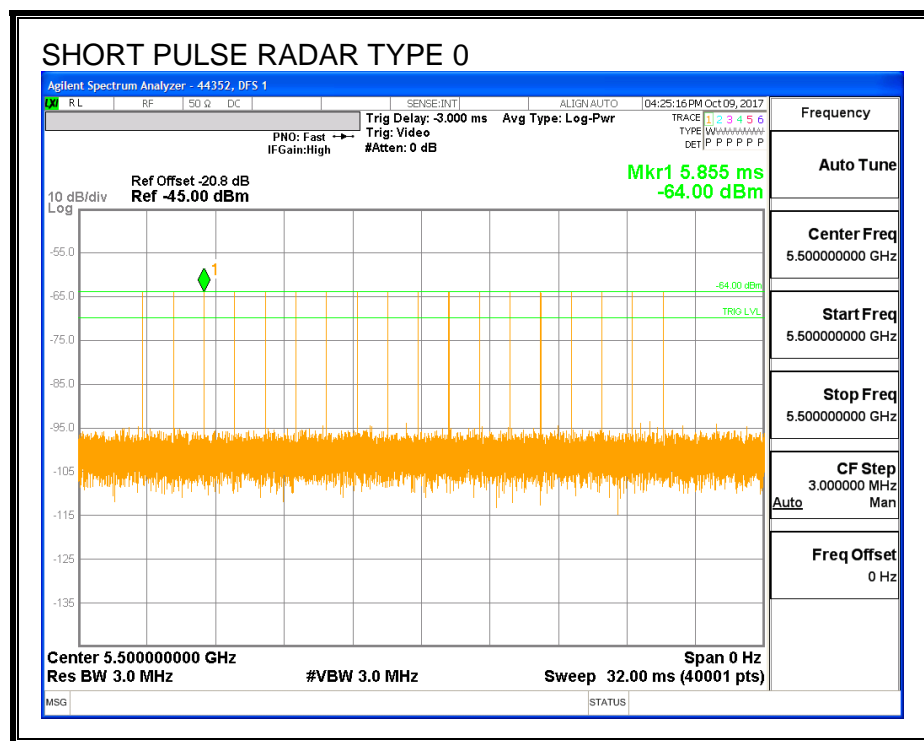



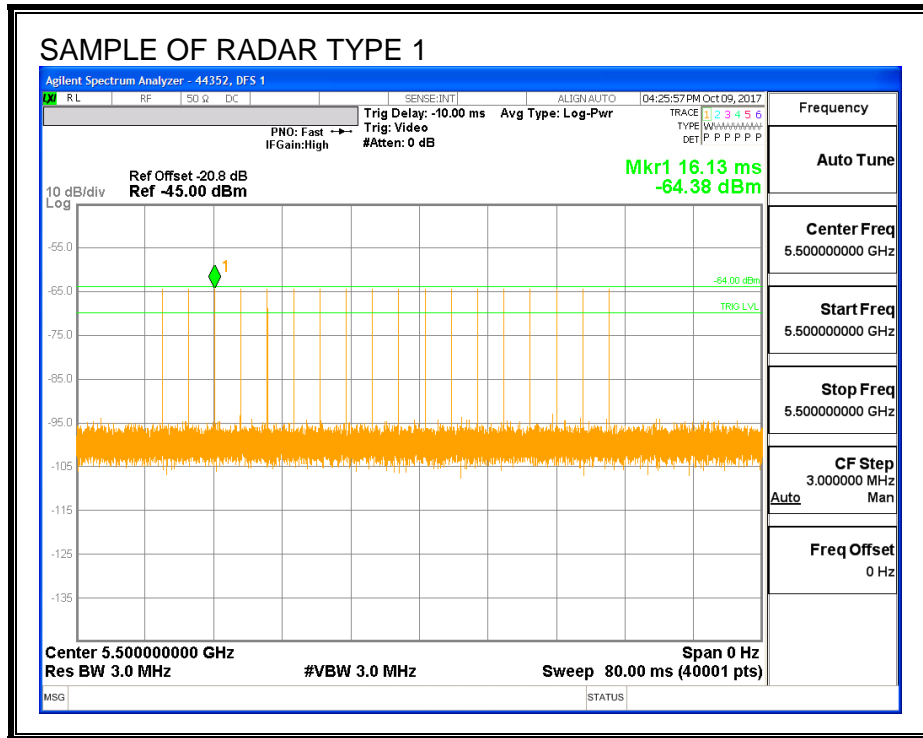

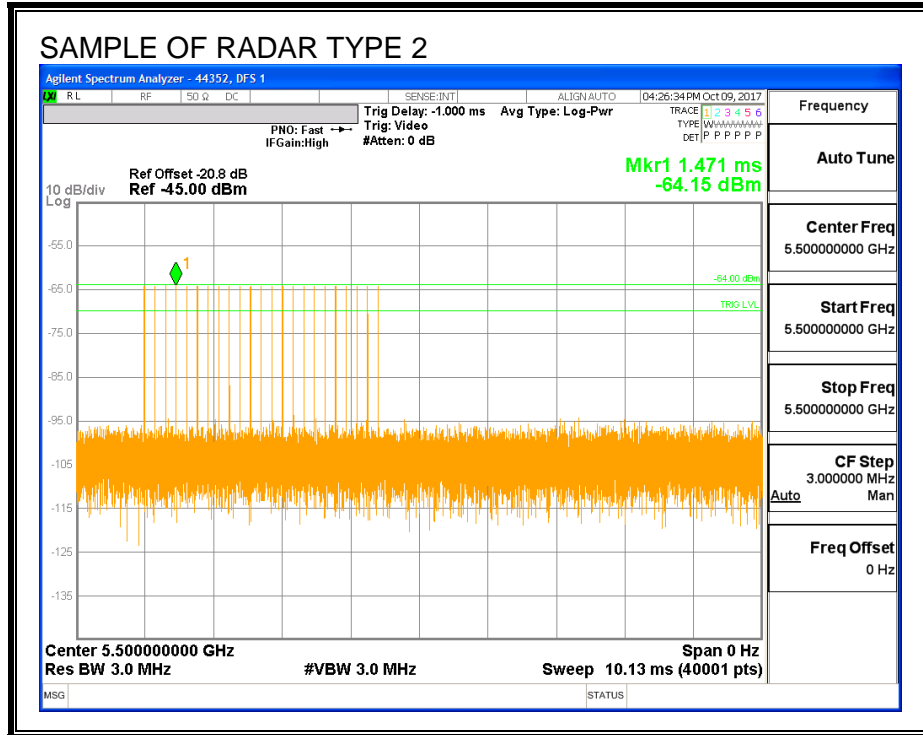

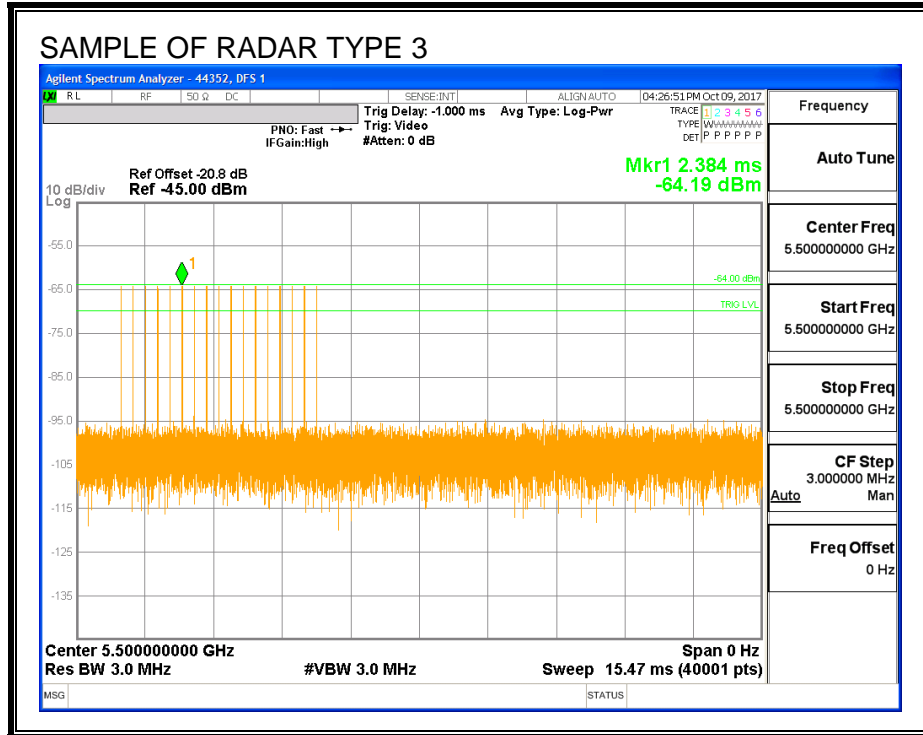

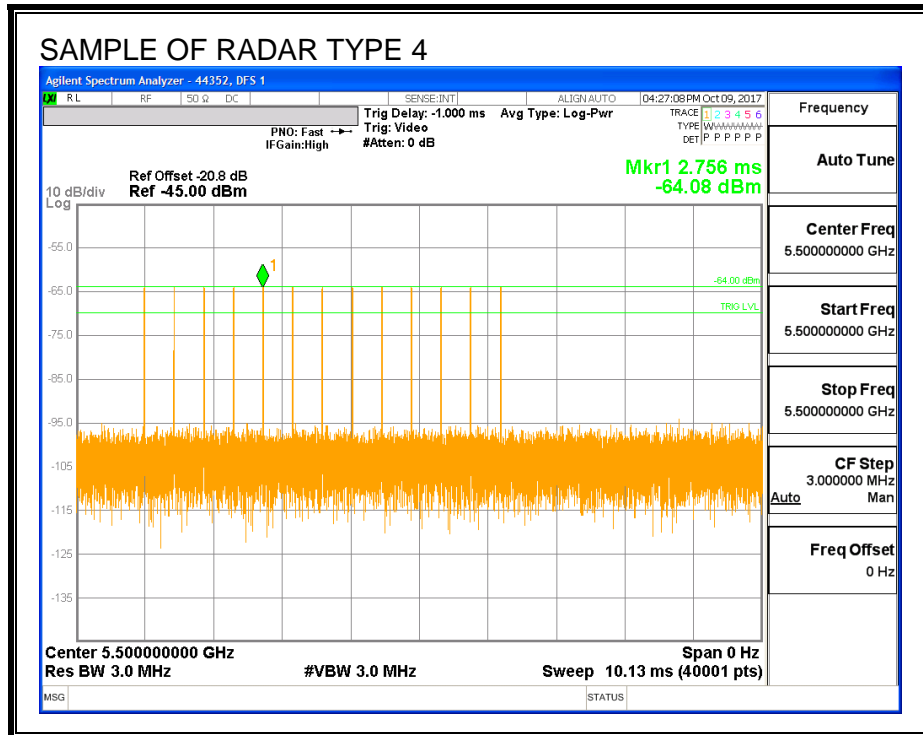

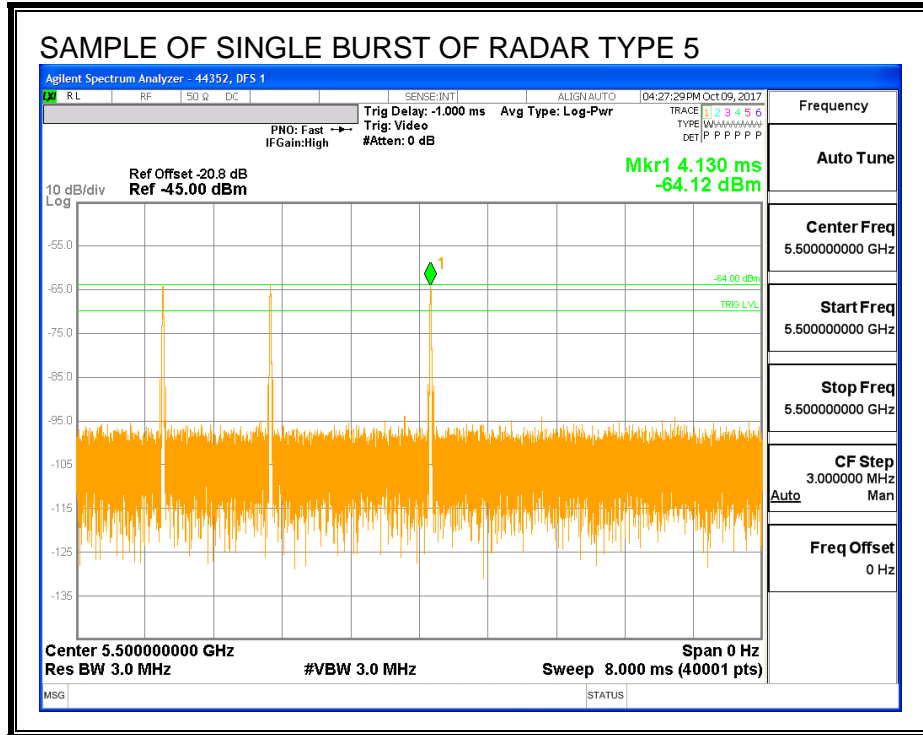

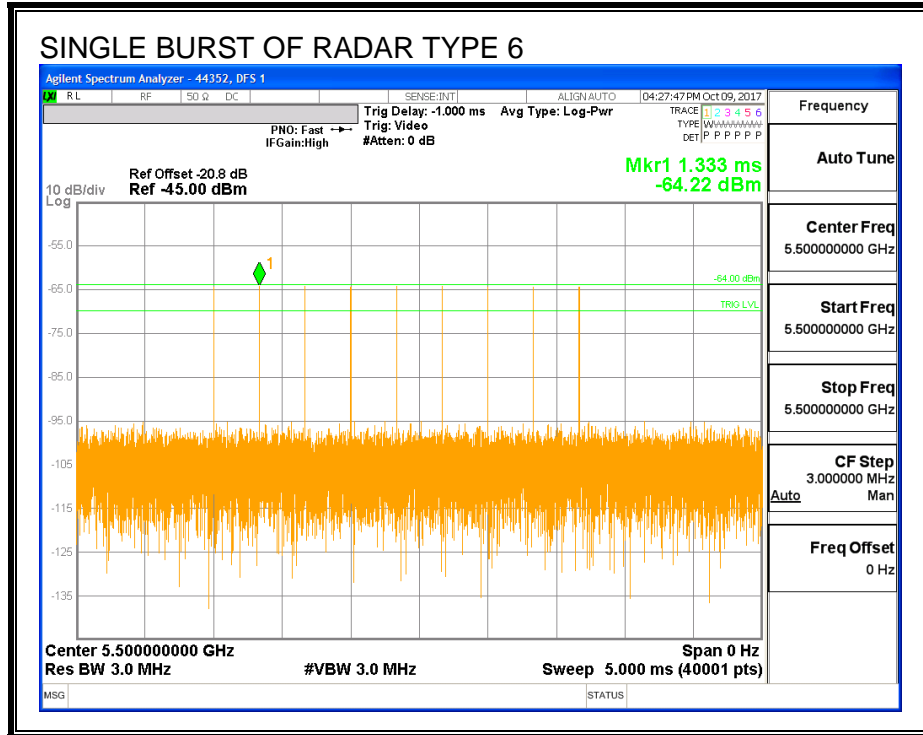

**TRAFFIC**

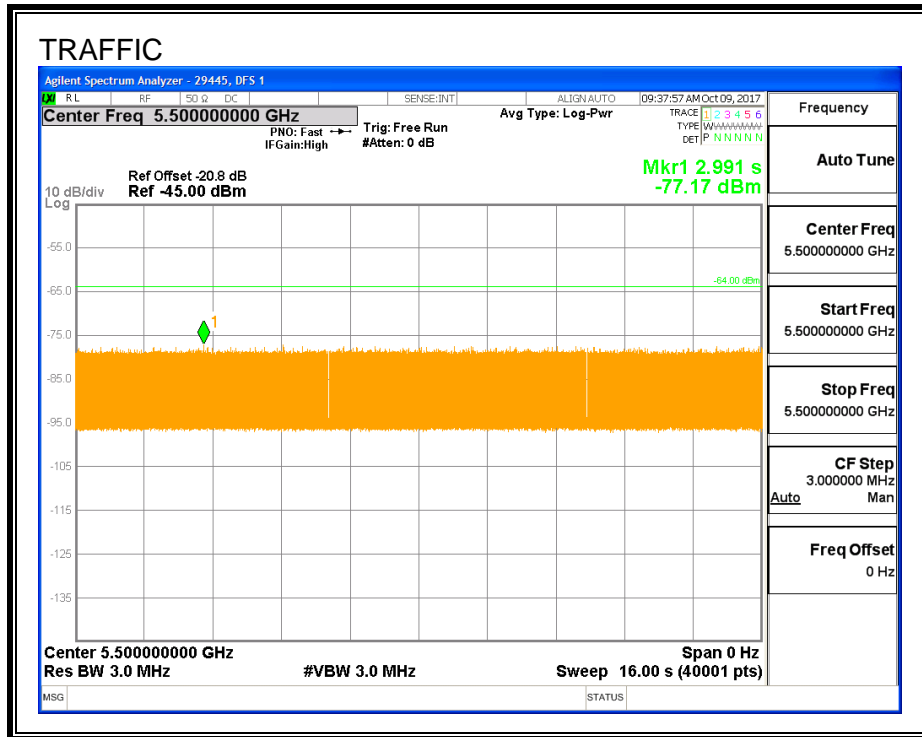

**CHANNEL LOADING**

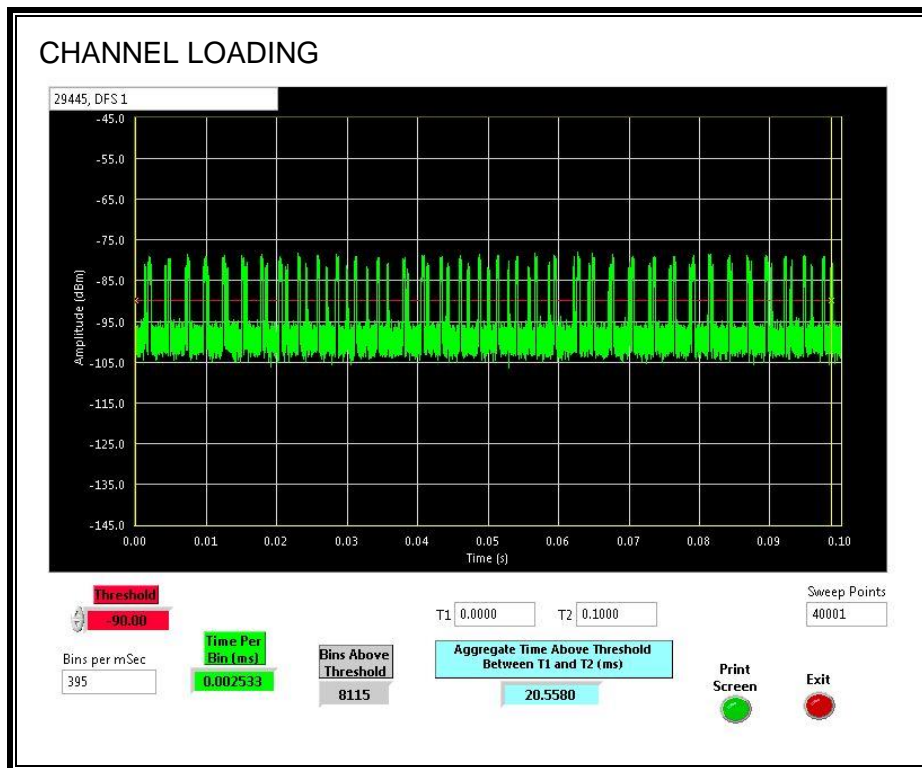

The level of traffic loading on the channel by the EUT is 20.55%



### **6.2.3. CHANNEL AVAILABILITY CHECK TIME**

#### **PROCEDURE TO DETERMINE CAC PERIOD TIME**

A link was established on a non-DFS channel then a software command was issued to the EUT to change to the test channel. The time from the software command to the re-initialization of traffic was measured as the time required for the EUT to complete the CAC period.

#### **PROCEDURE FOR TIMING OF RADAR BURST**

A link was established on a non-DFS channel then a software command was issued to the EUT to change to the test channel. A radar signal was triggered within 0 to 6 seconds after the beginning of the CAC period. Transmissions on the channel were monitored on the spectrum analyzer and a plot was captured

The Non-Occupancy list was cleared. A link was established on a non-DFS channel then a software command was issued to the EUT to change to the test channel. A radar signal was triggered within 54 to 60 seconds after the beginning of the CAC period. Transmissions on the channel were monitored on the spectrum analyzer and a plot was captured

.

**QUANTITATIVE RESULTS**

**No Radar Triggered**

Timing of Software Command (sec)	Timing of Start of Traffic (sec)	Total CAC Period (sec)
0	60.46	60.5

**Radar Near Beginning of CAC**

Timing of Software Command (sec)	Timing of Radar Burst (sec)	Radar Relative to Beginning of CAC (sec)
0	1.988	1.988

**Radar Near End of CAC**

Timing of Software Command (sec)	Timing of Radar Burst (sec)	Radar Relative to Beginning of CAC (sec)
0	59.35	59.35

**QUALITATIVE RESULTS**

Timing of Radar Burst	Display on Control Computer	Spectrum Analyzer Display
No Radar Triggered	EUT marks Channel as active	Transmissions begin on channel after completion of the initial power-up cycle and the CAC
Within 0 to 6 second window	EUT indicates radar detected	No transmissions on channel
Within 54 to 60 second window	EUT indicates radar detected	No transmissions on channel

**TIMING WITHOUT RADAR DURING CAC**

Software Command Issued  
 Start of CAC Period

End of CAC Period

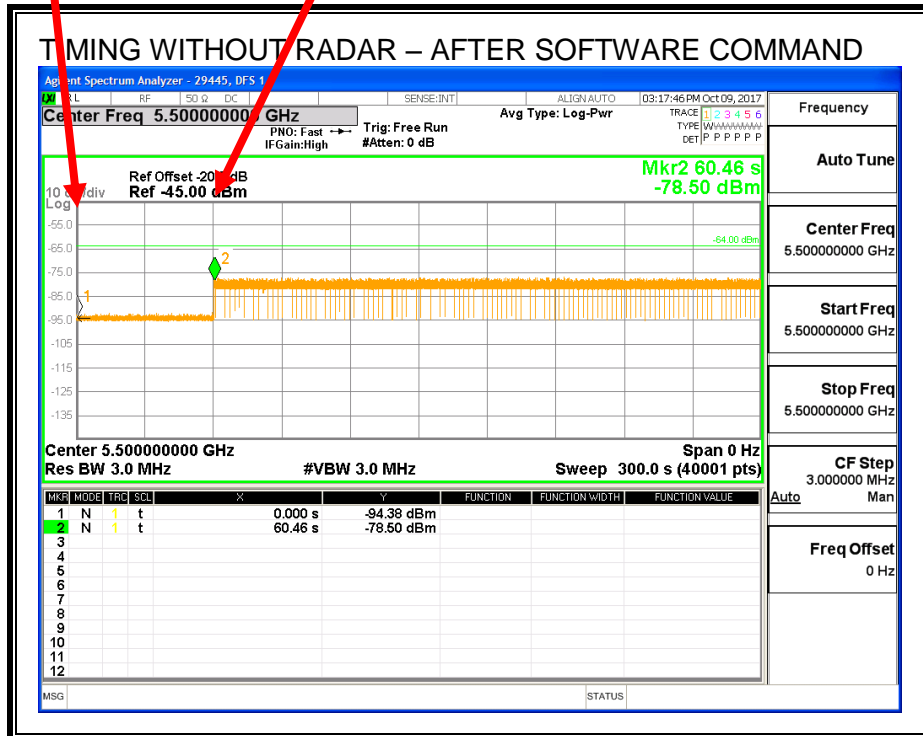

Transmissions begin on channel after completion of the initial power-up cycle and the CAC.

**TIMING WITH RADAR NEAR BEGINNING OF CAC**

Software Command Issued  
 Start of CAC Period

Radar Signal Applied

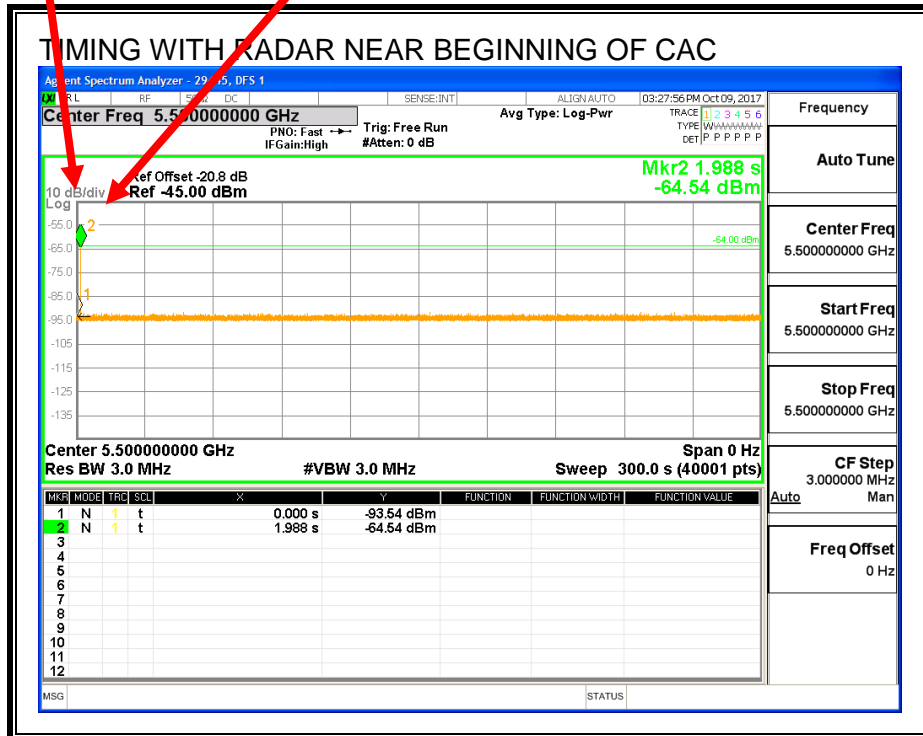

No EUT transmissions were observed after the radar signal.

**TIMING WITH RADAR NEAR END OF CAC**

Software Command Issued  
 Start of CAC Period

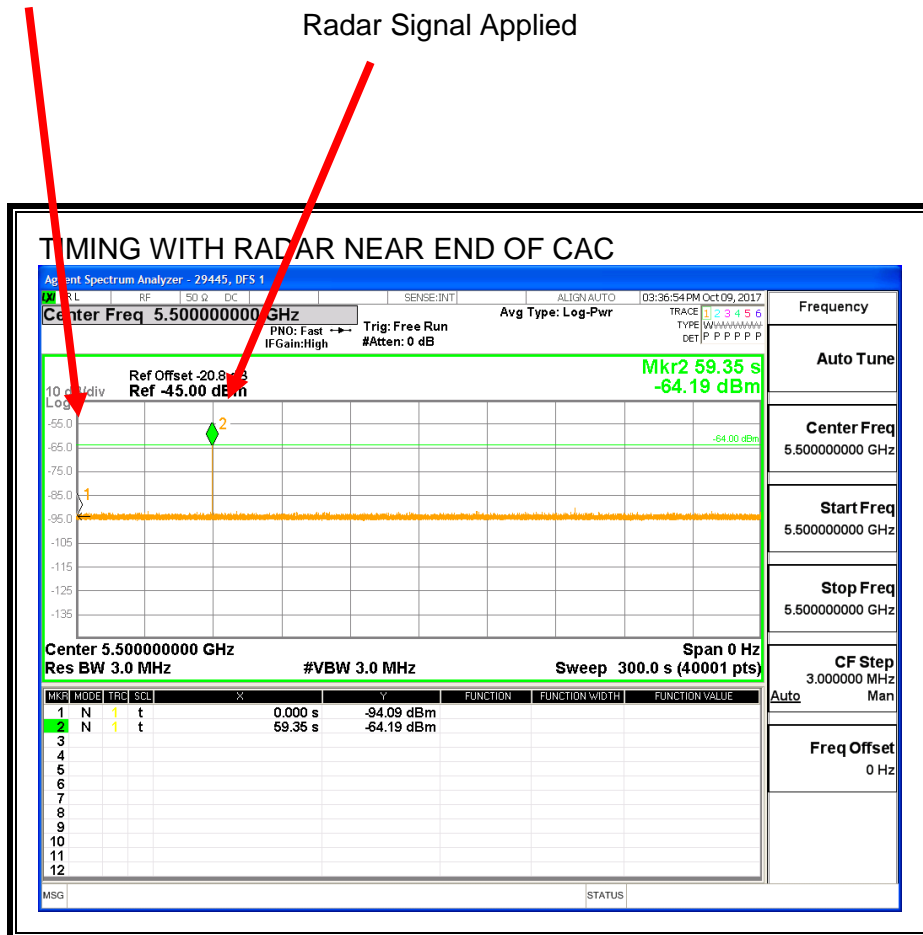

No EUT transmissions were observed after the radar signal.

### 6.2.4. OVERLAPPING CHANNEL TESTS

#### RESULTS

The channel spacing is not less than the channel bandwidth therefore the EUT does not have an overlapping channel plan.

### 6.2.5. MOVE AND CLOSING TIME

#### REPORTING NOTES

The reference marker is set at the end of last radar pulse.

The delta marker is set at the end of the last WLAN transmission following the radar pulse. This delta is the channel move time.

The aggregate channel closing transmission time is calculated as follows:

Aggregate Transmission Time =  
(Number of analyzer bins showing transmission) \* (dwell time per bin)

The observation period over which the aggregate time is calculated begins at (Reference Marker + 200 msec) and ends no earlier than (Reference Marker + 10 sec).

#### RESULTS

Channel Move Time (sec)	Limit (sec)
0.0836	10

Aggregate Channel Closing Transmission Time (msec)	Limit (msec)
0.0	60

**MOVE TIME**

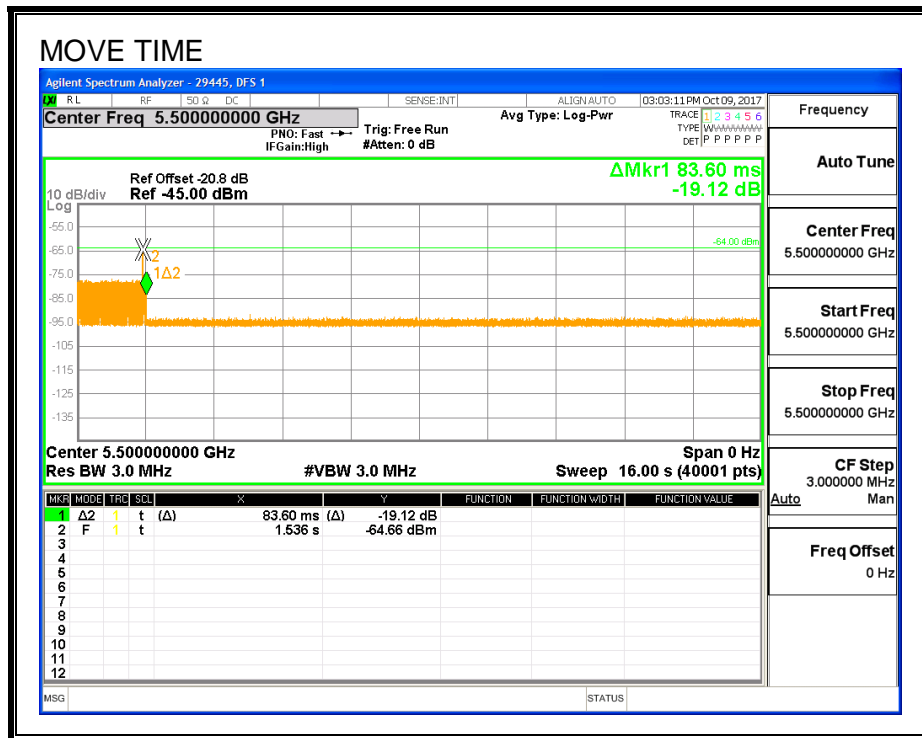

**CHANNEL CLOSING TIME**

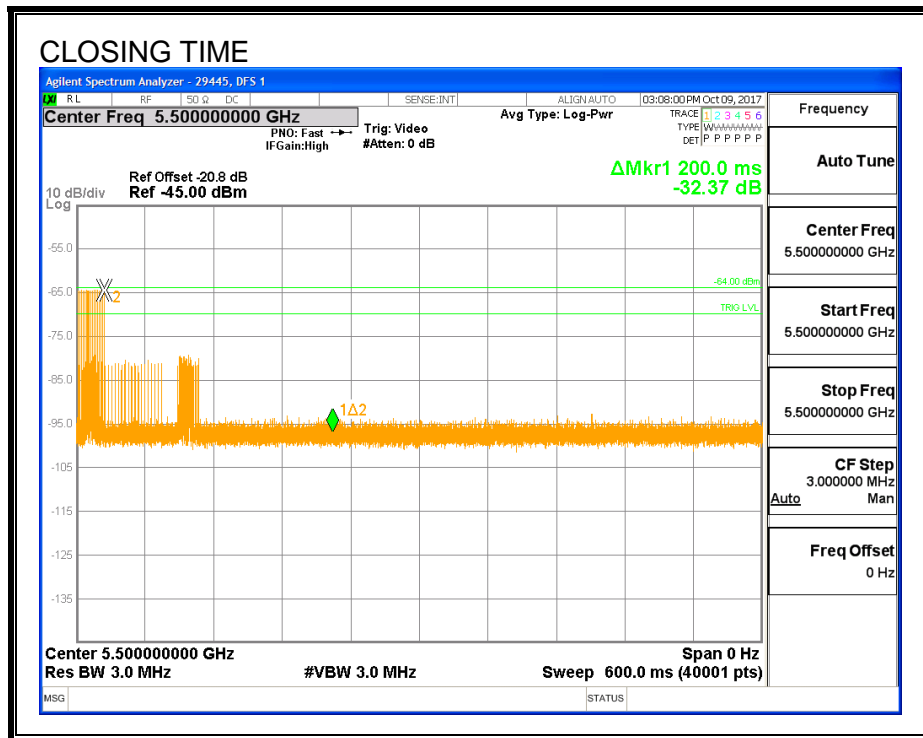



**AGGREGATE CHANNEL CLOSING TRANSMISSION TIME**

No transmissions are observed during the aggregate monitoring period.

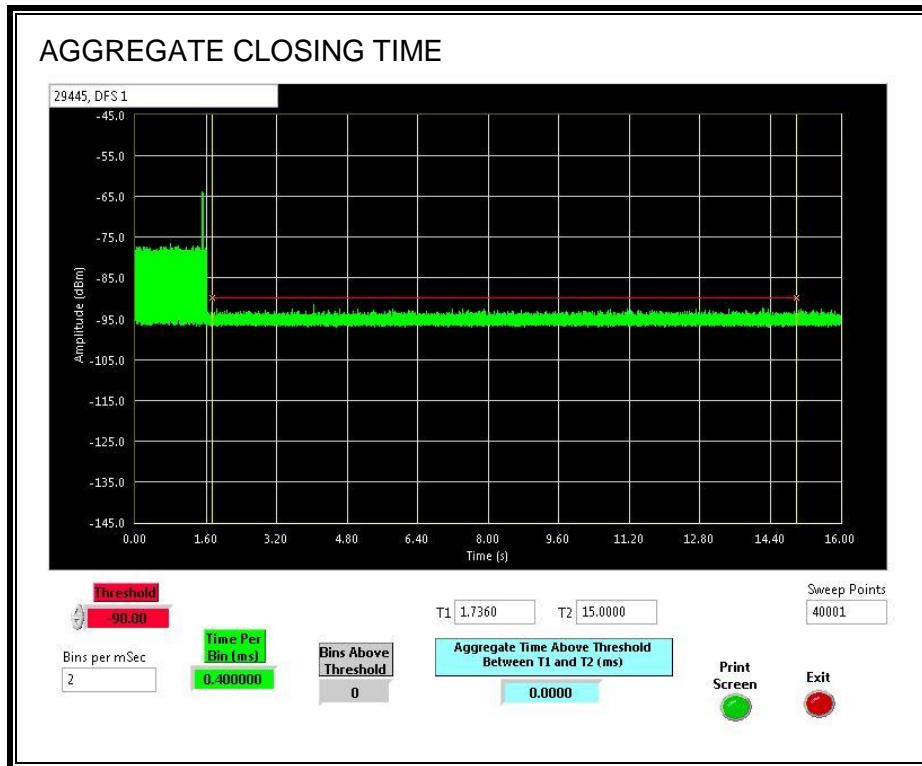

**LONG PULSE CHANNEL MOVE TIME**

The traffic ceases prior to 10 seconds after the end of the radar waveform.

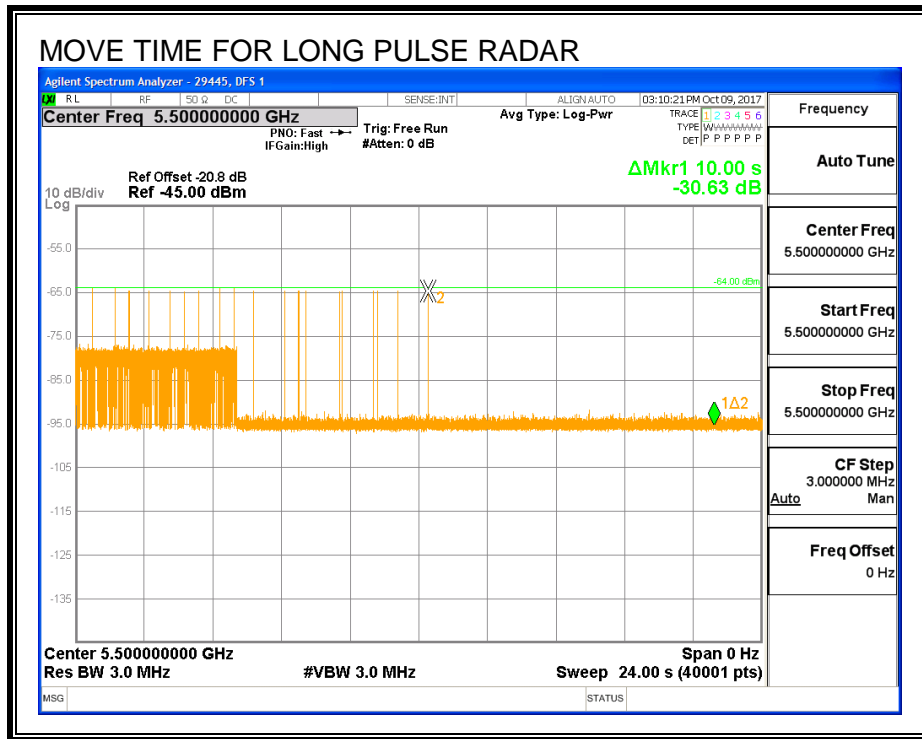

### 6.2.6. NON-OCCUPANCY PERIOD

#### RESULTS

No EUT transmissions were observed on the test channel during the 30-minute observation time.

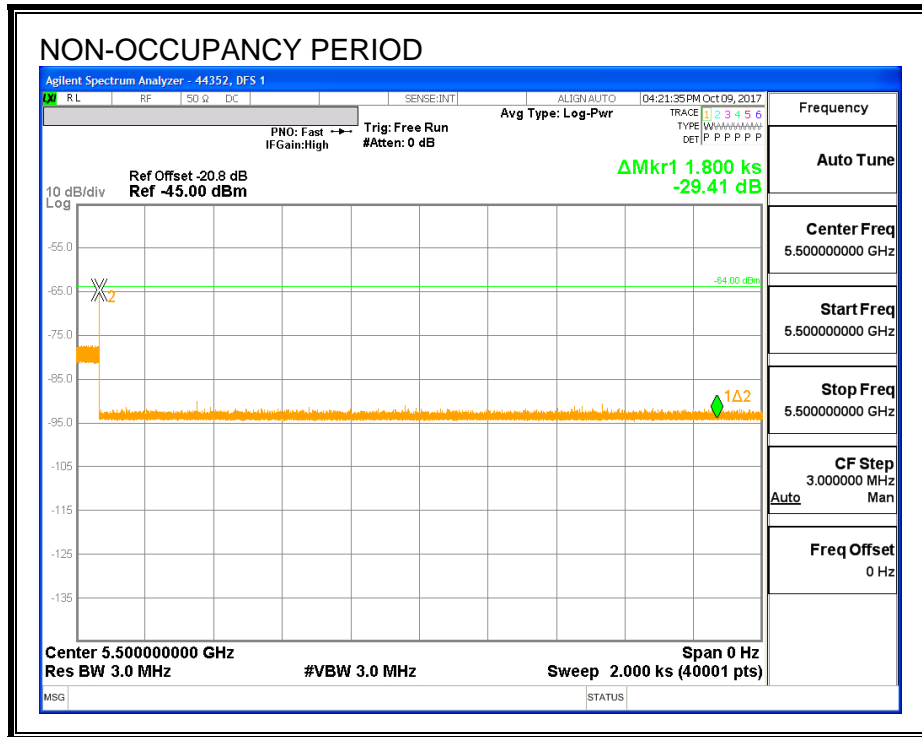

### 6.2.7. DETECTION BANDWIDTH

#### REFERENCE PLOT OF 99% POWER BANDWIDTH

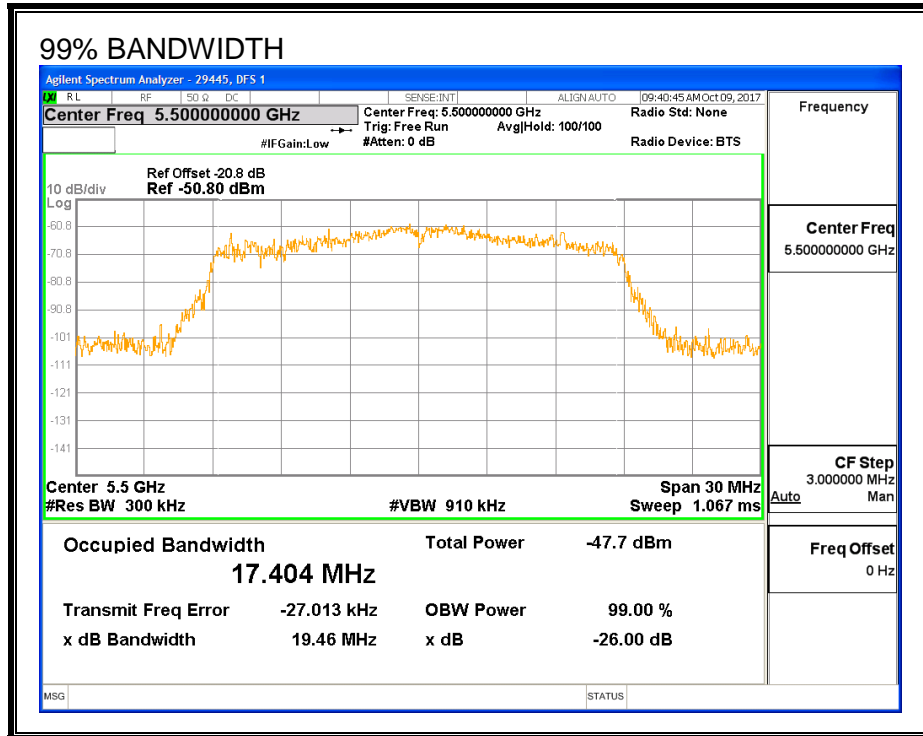

#### RESULTS

FL	FH	Detection Bandwidth	99% Power Bandwidth	Ratio of Detection BW to 99% Power BW	Minimum Limit
(MHz)	(MHz)	(MHz)	(MHz)	(%)	(%)
5491	5509	18	17.404	103.4	100

**DETECTION BANDWIDTH PROBABILITY**

<b>DETECTION BANDWIDTH PROBABILITY RESULTS</b>				
<b>Detection Bandwidth Test Results</b>		<b>29445</b>	<b>DFS 1</b>	
<b>FCC Type 0 Waveform: 1 us Pulse Width, 1428 us PRI, 18 Pulses per Burst</b>				
<b>Frequency (MHz)</b>	<b>Number of Trials</b>	<b>Number Detected</b>	<b>Detection (%)</b>	<b>Mark</b>
5491	10	10	100	FL
5492	10	10	100	
5493	10	10	100	
5494	10	10	100	
5495	10	10	100	
5500	10	9	90	
5505	10	10	100	
5506	10	10	100	
5507	10	10	100	
5508	10	9	90	
5509	10	10	100	FH

### 6.2.8. IN-SERVICE MONITORING

#### RESULTS

FCC Radar Test Summary										
Signal Type	Number of Trials	Detection (%)	Limit (%)	Pass/Fail	Detection Bandwidth		OBW	Test Location	Employee Number	In-Service Monitoring Version
					FL	FH				
FCC Short Pulse Type 1	30	93.33	60	Pass	5491	5509	17.4	DFS 1	29445	Version 3.0
FCC Short Pulse Type 2	30	100.00	60	Pass	5491	5509	17.4	DFS 1	29445	Version 3.0
FCC Short Pulse Type 3	30	93.33	60	Pass	5491	5509	17.4	DFS 1	29445	Version 3.0
FCC Short Pulse Type 4	30	90.00	60	Pass	5491	5509	17.4	DFS 1	29445	Version 3.0
Aggregate		94.17	80	Pass						
FCC Long Pulse Type 5	30	100.00	80	Pass	5491	5509	17.4	DFS 1	29445	Version 3.0
FCC Hopping Type 6	38	94.74	70	Pass	5491	5509		DFS 1	29445	Version 3.0

**TYPE 1 DETECTION PROBABILITY**

Data Sheet for FCC Short Pulse Radar Type 1						
Waveform	Pulse Width (us)	PRI (us)	Pulses Per Burst	Test (A/B)	Frequency (MHz)	Successful Detection (Yes/No)
1001	1	3066	18	A	5499	Yes
1002	1	678	78	A	5504	Yes
1003	1	698	76	A	5497	Yes
1004	1	518	102	A	5493	Yes
1005	1	758	70	A	5501	Yes
1006	1	598	89	A	5491	No
1007	1	858	62	A	5493	Yes
1008	1	738	72	A	5509	Yes
1009	1	578	92	A	5504	Yes
1010	1	718	74	A	5498	Yes
1011	1	818	65	A	5509	Yes
1012	1	638	83	A	5493	Yes
1013	1	618	86	A	5498	Yes
1014	1	538	99	A	5497	Yes
1015	1	938	57	A	5492	Yes
1016	1	2032	26	B	5495	Yes
1017	1	2052	26	B	5504	Yes
1018	1	1202	44	B	5495	Yes
1019	1	2705	20	B	5498	Yes
1020	1	790	67	B	5508	Yes
1021	1	2423	22	B	5499	Yes
1022	1	637	83	B	5502	Yes
1023	1	2399	22	B	5499	Yes
1024	1	2096	26	B	5492	Yes
1025	1	2794	19	B	5492	Yes
1026	1	1267	42	B	5506	No
1027	1	899	59	B	5509	Yes
1028	1	855	62	B	5492	Yes
1029	1	616	86	B	5499	Yes
1030	1	701	76	B	5496	Yes

**TYPE 2 DETECTION PROBABILITY**

Data Sheet for FCC Short Pulse Radar Type 2					
Waveform	Pulse Width (us)	PRI (us)	Pulses Per Burst	Frequency (MHz)	Successful Detection (Yes/No)
2001	2.9	157	23	5495	Yes
2002	2.2	178	27	5505	Yes
2003	1.9	193	28	5502	Yes
2004	1.4	181	25	5502	Yes
2005	3.6	200	26	5506	Yes
2006	3.3	192	23	5491	Yes
2007	3.7	177	25	5495	Yes
2008	1.4	173	27	5501	Yes
2009	2.1	163	29	5504	Yes
2010	4.4	163	27	5502	Yes
2011	1.2	199	27	5493	Yes
2012	1.7	165	29	5497	Yes
2013	2.8	206	25	5508	Yes
2014	3.6	177	24	5507	Yes
2015	3	184	28	5498	Yes
2016	3.9	201	27	5505	Yes
2017	3.5	169	24	5494	Yes
2018	2.8	152	28	5504	Yes
2019	2.6	206	29	5492	Yes
2020	2	193	26	5501	Yes
2021	4.2	213	27	5506	Yes
2022	2	166	25	5505	Yes
2023	4.4	190	23	5506	Yes
2024	2.3	229	24	5500	Yes
2025	4.9	218	23	5494	Yes
2026	3.1	180	25	5496	Yes
2027	4	174	24	5505	Yes
2028	4.5	221	23	5505	Yes
2029	1.5	181	23	5500	Yes
2030	2.3	194	29	5499	Yes



**TYPE 3 DETECTION PROBABILITY**

<b>Data Sheet for FCC Short Pulse Radar Type 3</b>					
<b>Waveform</b>	<b>Pulse Width (us)</b>	<b>PRI (us)</b>	<b>Pulses Per Burst</b>	<b>Frequency (MHz)</b>	<b>Successful Detection (Yes/No)</b>
3001	6.7	276	17	5494	Yes
3002	7.6	329	17	5503	Yes
3003	7.2	481	17	5496	Yes
3004	6.5	430	17	5492	Yes
3005	6.3	344	17	5508	Yes
3006	9.8	305	16	5493	Yes
3007	7.9	499	17	5509	Yes
3008	9.8	473	17	5495	Yes
3009	8.1	295	18	5493	Yes
3010	6	415	18	5501	Yes
3011	8.6	383	18	5502	Yes
3012	6.8	265	16	5494	No
3013	9.8	496	18	5505	No
3014	8.2	391	18	5497	Yes
3015	9.3	267	18	5504	Yes
3016	6	308	17	5498	Yes
3017	9.5	447	16	5499	Yes
3018	6.3	250	16	5495	Yes
3019	10	402	16	5504	Yes
3020	9.3	351	16	5491	Yes
3021	7.1	398	16	5498	Yes
3022	6.6	477	18	5499	Yes
3023	6.6	419	16	5497	Yes
3024	8.5	394	16	5501	Yes
3025	6.8	466	17	5499	Yes
3026	8.8	336	17	5492	Yes
3027	7.3	303	17	5507	Yes
3028	7.7	436	18	5508	Yes
3029	8.5	417	17	5509	Yes
3030	6.9	312	17	5492	Yes

**TYPE 4 DETECTION PROBABILITY**

Data Sheet for FCC Short Pulse Radar Type 4					
Waveform	Pulse Width (us)	PRI (us)	Pulses Per Burst	Frequency (MHz)	Successful Detection (Yes/No)
4001	11.3	438	13	5505	Yes
4002	17.3	479	13	5494	Yes
4003	15.9	368	15	5492	Yes
4004	18	421	13	5508	Yes
4005	12.8	323	16	5496	Yes
4006	15.5	271	13	5508	Yes
4007	19.8	318	16	5508	Yes
4008	18.7	280	14	5494	Yes
4009	14.4	340	15	5504	Yes
4010	13.7	314	16	5508	Yes
4011	19	269	12	5494	Yes
4012	14.5	256	13	5494	Yes
4013	15.9	475	12	5499	Yes
4014	11.9	357	14	5500	No
4015	13.8	338	13	5496	Yes
4016	19.4	366	12	5491	Yes
4017	17.5	359	12	5507	Yes
4018	14.4	400	16	5504	Yes
4019	13	288	14	5505	Yes
4020	20	342	16	5503	Yes
4021	19	376	14	5502	Yes
4022	12.6	443	12	5498	No
4023	16.9	490	15	5506	Yes
4024	15.8	451	13	5496	No
4025	11.5	260	16	5505	Yes
4026	19.9	486	14	5505	Yes
4027	16.1	441	16	5500	Yes
4028	11.6	428	12	5498	Yes
4029	13.1	396	16	5504	Yes
4030	18.1	278	12	5496	Yes

**TYPE 5 DETECTION PROBABILITY**

<b>Data Sheet for FCC Long Pulse Radar Type 5</b>		
<b>Trial</b>	<b>Frequency (MHz)</b>	<b>Successful Detection (Yes/No)</b>
1	5500	Yes
2	5500	Yes
3	5500	Yes
4	5500	Yes
5	5500	Yes
6	5500	Yes
7	5500	Yes
8	5500	Yes
9	5500	Yes
10	5500	Yes
11	5497	Yes
12	5498	Yes
13	5495	Yes
14	5494	Yes
15	5497	Yes
16	5494	Yes
17	5498	Yes
18	5495	Yes
19	5498	Yes
20	5496	Yes
21	5505	Yes
22	5505	Yes
23	5504	Yes
24	5503	Yes
25	5506	Yes
26	5502	Yes
27	5503	Yes
28	5504	Yes
29	5502	Yes
30	5505	Yes

Note: The Type 5 randomized parameters tested are shown in a separate document.

**TYPE 6 DETECTION PROBABILITY**

<b>Data Sheet for FCC Hopping Radar Type 6</b>				
<b>1 us Pulse Width, 333 us PRI, 9 Pulses per Burst, 1 Burst per Hop</b>				
<b>NTIA August 2005 Hopping Sequence</b>				
<b>Trial</b>	<b>Starting Index Within Sequence</b>	<b>Signal Generator Frequency (MHz)</b>	<b>Hops within Detection BW</b>	<b>Successful Detection (Yes/No)</b>
1	187	5491	4	Yes
2	662	5492	4	Yes
3	1137	5493	1	Yes
4	1612	5494	2	Yes
5	2562	5495	2	Yes
6	3037	5496	3	Yes
7	3512	5497	3	Yes
8	3987	5498	4	Yes
9	4462	5499	4	Yes
10	4937	5500	5	Yes
11	5412	5501	4	Yes
12	5887	5502	5	Yes
13	6362	5503	4	Yes
14	6837	5504	4	Yes
15	7312	5505	5	Yes
16	7787	5506	6	Yes
17	8262	5507	5	Yes
18	8737	5508	4	Yes
19	9212	5509	5	Yes
20	9687	5491	2	Yes
21	10162	5492	2	Yes
22	10637	5493	5	Yes
23	11112	5494	4	Yes
24	11587	5495	5	Yes
25	12062	5496	1	No
26	12537	5497	5	Yes
27	13012	5498	4	Yes
28	13487	5499	4	Yes
29	13962	5500	4	Yes
30	14437	5501	1	Yes
31	14912	5502	3	Yes
32	15387	5503	3	Yes
33	15862	5504	3	Yes
34	16337	5505	3	Yes
35	16812	5506	4	Yes
36	17287	5507	3	No
37	17762	5508	5	Yes
38	18237	5509	6	Yes

### **6.3. BRIDGE MODE RESULTS**

Per KDB 905462, Section 5.1 (footnote 1):

Networks Access Points with Bridge and/or MESH modes of operation are permitted to operate in the DFS bands but must employ a DFS function. The functionality of the Bridge mode as specified in §15.403(a) must be validated in the DFS test report. Devices operating as relays must also employ DFS function. The method used to validate the functionality must be documented and validation data must be documented. Bridge mode can be validated by performing a test statistical performance check (Section 7.8.4) on any one of the radar types. This is an abbreviated test to verify DFS functionality. MESH mode operational methodology must be submitted in the application for certification for evaluation by the FCC.

This device does not support Bridge Mode therefore this test was not performed.