



**DFS PORTION of FCC 47 CFR PART 15 SUBPART E  
DFS PORTION of INDUSTRY CANADA RSS-247 ISSUE 1**

**CERTIFICATION TEST REPORT**

**FOR**

**802.11a/b/g/n 2x2 CLIENT DEVICE**

**MODEL NUMBER: PLAY 1: (TYPE 1)**

**FCC ID: SBVRM007**

**IC: 5373A-RM007**

**REPORT NUMBER: 11360406-E3V1**

**ISSUE DATE: AUGUST 23, 2016**

*Prepared for*

**SONOS INC.**

**614 CHAPALA STREET  
SANTA BARBARA, CA 93101, U.S.A.**

*Prepared by*

**UL VERIFICATION SERVICES INC.**

**47173 BENICIA STREET  
FREMONT, CA 94538, U.S.A.**

**TEL: (510) 771-1000**

**FAX: (510) 661-0888**



**NVLAP LAB CODE 200065-0**

Revision History

<u>Rev.</u>	<u>Issue Date</u>	<u>Revisions</u>	<u>Revised By</u>
V1	08/23/16	Initial Issue	Conan Cheung

## TABLE OF CONTENTS

<b>1. ATTESTATION OF TEST RESULTS .....</b>	<b>4</b>
<b>2. TEST METHODOLOGY .....</b>	<b>5</b>
<b>3. FACILITIES AND ACCREDITATION .....</b>	<b>5</b>
<b>4. CALIBRATION AND UNCERTAINTY .....</b>	<b>5</b>
4.1. <i>MEASURING INSTRUMENT CALIBRATION .....</i>	<i>5</i>
4.2. <i>SAMPLE CALCULATION .....</i>	<i>5</i>
4.3. <i>MEASUREMENT UNCERTAINTY .....</i>	<i>5</i>
<b>5. DYNAMIC FREQUENCY SELECTION.....</b>	<b>6</b>
5.1. <i>OVERVIEW .....</i>	<i>6</i>
5.1.1. <i>LIMITS .....</i>	<i>6</i>
5.1.2. <i>TEST AND MEASUREMENT SYSTEM .....</i>	<i>10</i>
5.1.3. <i>TEST AND MEASUREMENT SOFTWARE .....</i>	<i>12</i>
5.1.4. <i>SETUP OF EUT .....</i>	<i>13</i>
5.1.5. <i>DESCRIPTION OF EUT .....</i>	<i>14</i>
5.2. <i>RESULTS FOR 20 MHz BANDWIDTH .....</i>	<i>16</i>
5.2.1. <i>TEST CHANNEL .....</i>	<i>16</i>
5.2.2. <i>RADAR WAVEFORM AND TRAFFIC .....</i>	<i>16</i>
5.2.3. <i>OVERLAPPING CHANNEL TESTS .....</i>	<i>19</i>
5.2.4. <i>MOVE AND CLOSING TIME .....</i>	<i>19</i>
5.2.5. <i>10-MINUTE BEACON MONITORING PERIOD .....</i>	<i>23</i>
<b>6. SETUP PHOTOS.....</b>	<b>24</b>

# 1. ATTESTATION OF TEST RESULTS

**COMPANY NAME:** SONOS, INC.  
614 CHAPALA STREET  
SANTA BARBARA, CA 93101, U.S.A.

**EUT DESCRIPTION:** 802.11 a/b/g/n 2x2 CLIENT DEVICE

**MODEL:** PLAY: 1 (TYPE 1)

**SERIAL NUMBER:** 94-9F-3E-00-03-74:B

**DATE TESTED:** AUGUST 10, 2016

APPLICABLE STANDARDS	
STANDARD	TEST RESULTS
DFS Portion of CFR 47 Part 15 Subpart E	Pass
INDUSTRY CANADA RSS-247 Issue 1	Pass

UL Verification Services Inc. tested the above equipment in accordance with the requirements set forth in the above standards. All indications of Pass/Fail in this report are opinions expressed by UL Verification Services Inc. based on interpretations and/or observations of test results. Measurement Uncertainties were not taken into account and are published for informational purposes only. The test results show that the equipment tested is capable of demonstrating compliance with the requirements as documented in this report.

**Note:** The results documented in this report apply only to the tested sample, under the conditions and modes of operation as described herein. This document may not be altered or revised in any way unless done so by UL Verification Services Inc. and all revisions are duly noted in the revisions section. Any alteration of this document not carried out by UL Verification Services Inc. will constitute fraud and shall nullify the document. This report must not be used by the client to claim product certification, approval, or endorsement by NVLAP, NIST, any agency of the Federal Government, or any agency of any government.

Approved & Released For  
UL Verification Services Inc. By:

Tested By:



CONAN CHEUNG  
PROJECT LEAD  
UL Verification Services Inc.

HENRY LAU  
EMC ENGINEER  
UL Verification Services Inc.

## 2. TEST METHODOLOGY

The tests documented in this report were performed in accordance with the DFS portion of FCC CFR 47 Part 2, FCC CFR 47 Part 15, FCC 06-96, FCC KDB 789033, KDB 905462 D02 and D03, ANSI C63.10-2013, RSS-247 Issue 1.

## 3. FACILITIES AND ACCREDITATION

The test sites and measurement facilities used to collect data are located at 47173 Benicia Street, Fremont, California, USA.

UL Verification Services, Inc. is accredited by NVLAP, Laboratory Code 200065-0. The full scope of accreditation can be viewed at <http://ts.nist.gov/standards/scopes/2000650.htm>.

## 4. CALIBRATION AND UNCERTAINTY

### 4.1. MEASURING INSTRUMENT CALIBRATION

The measuring equipment utilized to perform the tests documented in this report has been calibrated in accordance with the manufacturer's recommendations, and is traceable to recognized national standards.

### 4.2. SAMPLE CALCULATION

Where relevant, the following sample calculation is provided:

$$\begin{aligned} \text{Field Strength (dBuV/m)} &= \text{Measured Voltage (dBuV)} + \text{Antenna Factor (dB/m)} + \\ &\text{Cable Loss (dB)} - \text{Preamp Gain (dB)} \\ 36.5 \text{ dBuV} + 18.7 \text{ dB/m} + 0.6 \text{ dB} - 26.9 \text{ dB} &= 28.9 \text{ dBuV/m} \end{aligned}$$

### 4.3. MEASUREMENT UNCERTAINTY

Where relevant, the following measurement uncertainty levels have been estimated for tests performed on the apparatus:

PARAMETER	UNCERTAINTY
Conducted Disturbance, 0.15 to 30 MHz	± 3.52 dB
Radiated Disturbance, 30 to 1000 MHz	± 4.94 dB
Radiated Disturbance, 1 to 6 GHz	± 3.86 dB
Radiated Disturbance, 6 to 18 GHz	± 4.23 dB
Radiated Disturbance, 18 to 26 GHz	± 5.30 dB
Radiated Disturbance, 26 to 40 GHz	± 5.23 dB

Uncertainty figures are valid to a confidence level of 95%.

## 5. DYNAMIC FREQUENCY SELECTION

### 5.1. OVERVIEW

#### 5.1.1. LIMITS

#### INDUSTRY CANADA

IC RSS-247 is closely harmonized with FCC Part 15 DFS rules. The deviations are as follows:

RSS-247 Issue 1

**Note:** For the band 5600–5650 MHz, no operation is permitted.

Until further notice, devices subject to this annex shall not be capable of transmitting in the band 5600–5650 MHz. This restriction is for the protection of Environment Canada weather radars operating in this band.

#### FCC

§15.407 (h), FCC KDB 905462 D02 “COMPLIANCE MEASUREMENT PROCEDURES FOR UNLICENSED-NATIONAL INFORMATION INFRASTRUCTURE DEVICES OPERATING IN THE 5250-5350 MHz AND 5470-5725 MHz BANDS INCORPORATING DYNAMIC FREQUENCY SELECTION” and KDB 905462 D03 “U-NII CLIENT DEVICES WITHOUT RADAR DETECTION CAPABILITY”.

**Table 1: Applicability of DFS requirements prior to use of a channel**

Requirement	Operational Mode		
	Master	Client (without radar detection)	Client (with radar detection)
Non-Occupancy Period	Yes	Not required	Yes
DFS Detection Threshold	Yes	Not required	Yes
Channel Availability Check Time	Yes	Not required	Not required
U-NII Detection Bandwidth	Yes	Not required	Yes

**Table 2: Applicability of DFS requirements during normal operation**

Requirement	Operational Mode		
	Master	Client (without DFS)	Client (with DFS)
DFS Detection Threshold	Yes	Not required	Yes
Channel Closing Transmission Time	Yes	Yes	Yes
Channel Move Time	Yes	Yes	Yes
U-NII Detection Bandwidth	Yes	Not required	Yes

Additional requirements for devices with multiple bandwidth modes	Master Device or Client with Radar DFS	Client (without DFS)
<i>U-NII Detection Bandwidth and Statistical Performance Check</i>	All BW modes must be tested	Not required
<i>Channel Move Time and Channel Closing Transmission Time</i>	Test using widest BW mode available	Test using the widest BW mode available for the link
<i>All other tests</i>	Any single BW mode	Not required
<b>Note:</b> Frequencies selected for statistical performance check (Section 7.8.4) should include several frequencies within the radar detection bandwidth and frequencies near the edge of the radar detection bandwidth. For 802.11 devices it is suggested to select frequencies in all 20 MHz channel blocks and a null frequency between the bonded 20 MHz channel blocks.		

**Table 3: Interference Threshold values, Master or Client incorporating In-Service Monitoring**

Maximum Transmit Power	Value (see notes)
E.I.R.P. $\geq$ 200 mill watt	-64 dBm
E.I.R.P. < 200 mill watt and power spectral density < 10 dBm/MHz	-62 dBm
E.I.R.P. < 200 mill watt that do not meet power spectral density requirement	-64 dBm
<p><b>Note 1:</b> This is the level at the input of the receiver assuming a 0 dBi receive antenna  <b>Note 2:</b> Throughout these test procedures an additional 1 dB has been added to the amplitude of the test transmission waveforms to account for variations in measurement equipment. This will ensure that the test signal is at or above the detection threshold level to trigger a DFS response.  <b>Note 3:</b> E.I.R.P. is based on the highest antenna gain. For MIMO devices refer to KDB publication 662911 D01.</p>	

**Table 4: DFS Response requirement values**

Parameter	Value
<i>Non-occupancy period</i>	30 minutes
<i>Channel Availability Check Time</i>	60 seconds
<i>Channel Move Time</i>	10 seconds (See Note 1)
<i>Channel Closing Transmission Time</i>	200 milliseconds + approx. 60 milliseconds over remaining 10 second period. (See Notes 1 and 2)
<i>U-NII Detection Bandwidth</i>	Minimum 100% of the U-NII 99% transmission power bandwidth. (See Note 3)
<p><b>Note 1:</b> <i>Channel Move Time</i> and the <i>Channel Closing Transmission Time</i> should be performed with Radar Type 0. The measurement timing begins at the end of the Radar Type 0 burst.  <b>Note 2:</b> The <i>Channel Closing Transmission Time</i> is comprised of 200 milliseconds starting at the beginning of the <i>Channel Move Time</i> plus any additional intermittent control signals required to facilitate a <i>Channel</i> move (an aggregate of 60 milliseconds) during the remainder of the 10 second period. The aggregate duration of control signals will not count quiet periods in between transmissions.  <b>Note 3:</b> During the <i>U-NII Detection Bandwidth</i> detection test, radar type 0 should be used. For each frequency step the minimum percentage of detection is 90 percent. Measurements are performed with no data traffic.</p>	



**Table 5 – Short Pulse Radar Test Waveforms**

Radar Type	Pulse Width (usec)	PRI (usec)	Pulses	Minimum Percentage of Successful Detection	Minimum Trials
0	1	1428	18	See Note 1	See Note 1
1	1	Test A: 15 unique PRI values randomly selected from the list of 23 PRI values in table 5a	Roundup: $\{(1/360) \times (19 \times 10^6 \text{ PRI}_{\text{usec}})\}$	60%	30
		Test B: 15 unique PRI values randomly selected within the range of 518-3066 usec. With a minimum increment of 1 usec, excluding PRI values selected in Test A			
2	1-5	150-230	23-29	60%	30
3	6-10	200-500	16-18	60%	30
4	11-20	200-500	12-16	60%	30
Aggregate (Radar Types 1-4)				80%	120
<b>Note 1:</b> Short Pulse Radar Type 0 should be used for the <i>Detection Bandwidth</i> test, <i>Channel Move Time</i> , and <i>Channel Closing Time</i> tests.					

*Table 6 – Long Pulse Radar Test Signal*

Radar Waveform Type	Pulse Width (μsec)	Chirp Width (MHz)	PRI (μsec)	Pulses per Burst	Number of Bursts	Minimum Percentage of Successful Detection	Minimum Trials
5	50-100	5-20	1000-2000	1-3	8-20	80%	30

**Table 7 – Frequency Hopping Radar Test Signal**

Radar Waveform Type	Pulse Width (μsec)	PRI (μsec)	Pulses per Hop	Hopping Rate (kHz)	Hopping Sequence Length (msec)	Minimum Percentage of Successful Detection	Minimum Trials
6	1	333	9	0.333	300	70%	30

### 5.1.2. TEST AND MEASUREMENT SYSTEM

#### RADIATED METHOD SYSTEM BLOCK DIAGRAM

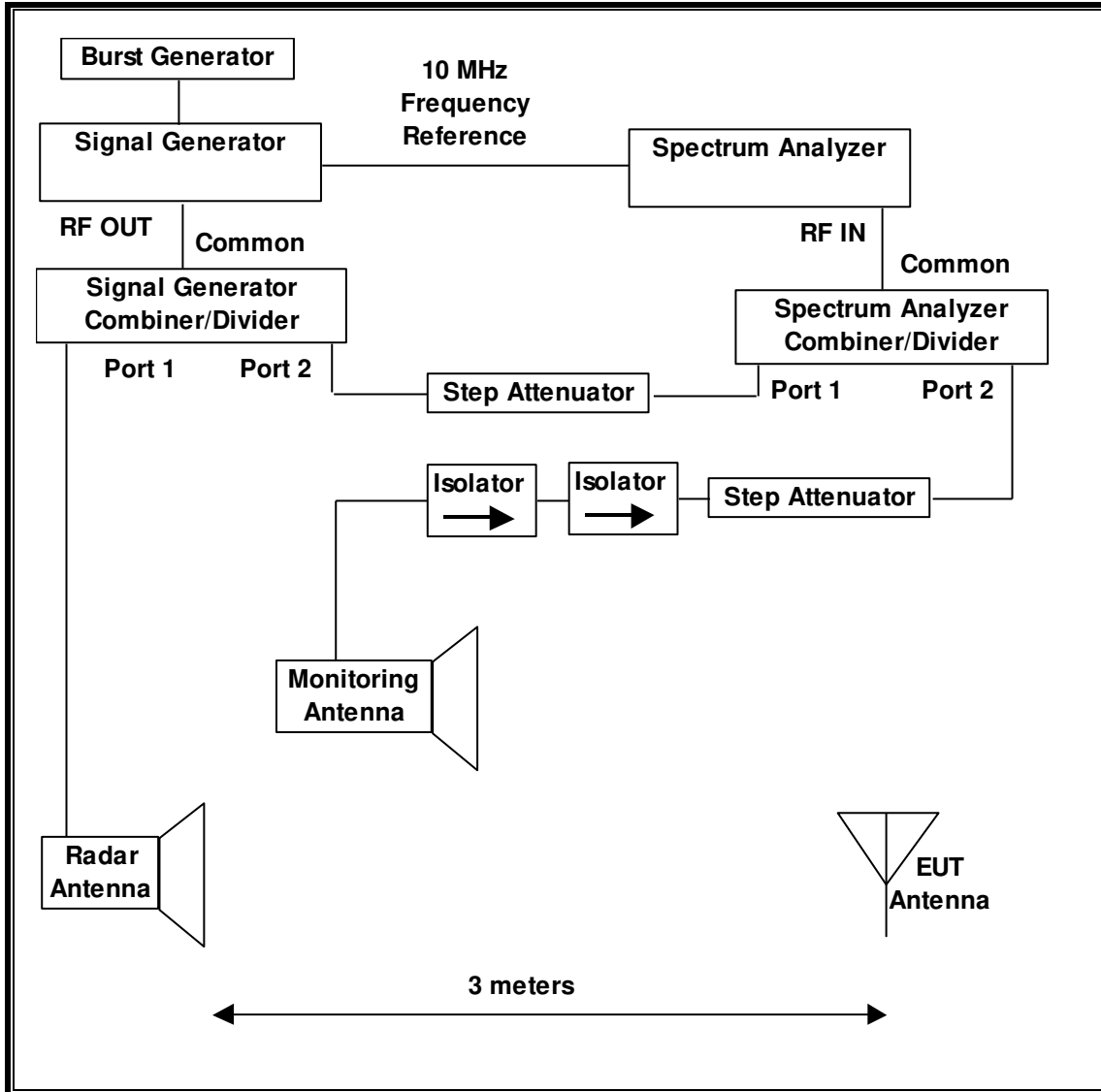

## **SYSTEM OVERVIEW**

The short pulse and long pulse signal generating system utilizes the NTIA software. The Vector Signal Generator has been validated by the NTIA. The hopping signal generating system utilizes the CCS simulated hopping method and system, which has been validated by the DoD, FCC and NTIA. The software selects waveform parameters from within the bounds of the signal type on a random basis using uniform distribution.

The short pulse types 1, 2, 3 and 4, and the long pulse type 5 parameters are randomized at run-time.

The hopping type 6 pulse parameters are fixed while the hopping sequence is based on the August 2005 NTIA Hopping Frequency List. The initial starting point randomized at run-time and each subsequent starting point is incremented by 475. Each frequency in the 100-length segment is compared to the boundaries of the EUT Detection Bandwidth and the software creates a hopping burst pattern in accordance with Section 7.4.1.3 Method #2 Simulated Frequency Hopping Radar Waveform Generating Subsystem of KDB 905462 D02. The frequency of the signal generator is incremented in 1 MHz steps from  $F_L$  to  $F_H$  for each successive trial. This incremental sequence is repeated as required to generate a minimum of 30 total trials and to maintain a uniform frequency distribution over the entire Detection Bandwidth.

The signal monitoring equipment consists of a spectrum analyzer. The aggregate ON time is calculated by multiplying the number of bins above a threshold during a particular observation period by the dwell time per bin, with the analyzer set to peak detection and max hold.

## **SYSTEM CALIBRATION**

A 50-ohm load is connected in place of the spectrum analyzer, and the spectrum analyzer is connected to a horn antenna via a coaxial cable, with the reference level offset set to (horn antenna gain – coaxial cable loss). The signal generator is set to CW mode. The amplitude of the signal generator is adjusted to yield a level of –64 dBm as measured on the spectrum analyzer.

Without changing any of the instrument settings, the spectrum analyzer is reconnected to the Common port of the Spectrum Analyzer Combiner/Divider. The Reference Level Offset of the spectrum analyzer is adjusted so that the displayed amplitude of the signal is –64 dBm.

The spectrum analyzer displays the level of the signal generator as received at the antenna ports of the Master Device. The interference detection threshold may be varied from the calibrated value of –64 dBm and the spectrum analyzer will still indicate the level as received by the Master Device.

**ADJUSTMENT OF DISPLAYED TRAFFIC LEVEL**

A link is established between the Master and Slave and the distance between the units is adjusted as needed to provide a suitable received level at the Master and Slave devices. The video test file is streamed to generate WLAN traffic. The monitoring antenna is adjusted so that the WLAN traffic level, as displayed on the spectrum analyzer, is at lower amplitude than the radar detection threshold.

**TEST AND MEASUREMENT EQUIPMENT**

The following test and measurement equipment was utilized for the DFS tests documented in this report:

TEST EQUIPMENT LIST				
Description	Manufacturer	Model	Serial Number	Cal Due
Spectrum Analyzer, PXA, 3Hz to 44GHz	Keysight	N9030A	US51350187	06/13/17
Signal Generator, MXG X-Series RF Vector	Agilent	N5182B	MY51350337	03/11/17

**5.1.3. TEST AND MEASUREMENT SOFTWARE**

The following test and measurement software was utilized for the tests documented in this report:

TEST SOFTWARE LIST		
Name	Version	Test / Function
Aggregate Time-PXA	3.0	Channel Loading and Aggregate Closing Time
PXA Read	3.0.0.9	Signal Generator Screen Capture
SGXProject.exe	2	Radar Waveform Generation and Download

### 5.1.4. SETUP OF EUT

#### RADIATED METHOD EUT TEST SETUP

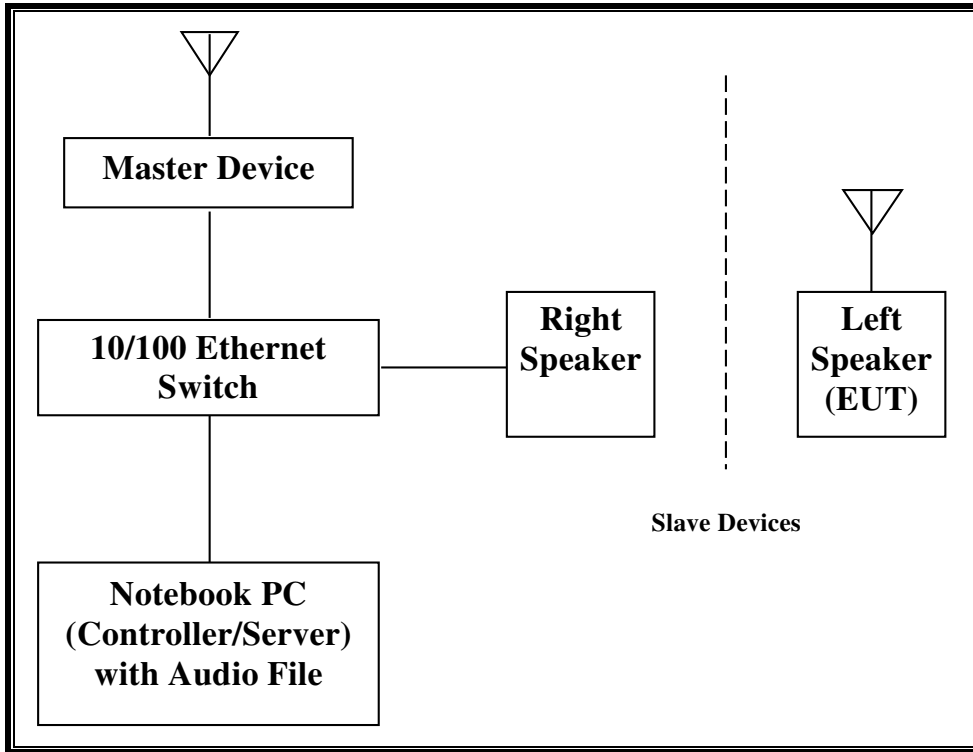

#### SUPPORT EQUIPMENT

The following support equipment was utilized for the DFS tests documented in this report:

PERIPHERAL SUPPORT EQUIPMENT LIST				
Description	Manufacturer	Model	Serial Number	FCC ID
Wireless Sound Bar (Master Device)	Sonos, Inc.	Playbar	5C-AA-FD-1E-15-E2:3	SBVRM006
Notebook PC (Console/Server)	Lenovo	Type 3249-EPU	R9-A8CWY 10/12	DoC
AC Adapter (Console/Server PC)	Lenovo	ADLX90NLT2A	11S45N0307Z1ZLZ438E 1PJ	DoC
8-Port Gigabit Switch	Netgear	GS108	2162343501F7F	DoC
AC Adapter (Router)	Netgear	P030WF120B	3113332131020017AL	DoC
Speaker (Right / Hardwired)	Sonos, Inc.	Play: 1	94-9F3E-00-03-9C:0	SBVRM009

### 5.1.5. DESCRIPTION OF EUT

For FCC and IC the EUT operates over the 5250-5350 MHz and 5470-5725 MHz ranges, excluding the 5600-5650 MHz range.

The EUT is a Slave Device without Radar Detection.

The highest power level within these bands is 24.99 dBm EIRP in the 5250-5350 MHz band and 24.90 dBm EIRP in the 5470-5725 MHz band. (Information is taken from reference report 13U14836-2B)

The only antenna assembly consists of 2 antennas with individual gains of 3.59 dBi and 3.29 dBi. (Information is taken from reference report 13U14836-2B)

Two antennas are utilized to meet the diversity and MIMO operational requirements.

The rated output power of the Master unit is < 23dBm (EIRP). Therefore the required interference threshold level is -62 dBm. After correction for procedural adjustments, the required radiated threshold at the antenna port is  $-62 + 1 = -61$  dBm.

The calibrated radiated DFS Detection Threshold level is set to -64 dBm. The tested level is lower than the required level hence it provides a margin to the limit.

The EUT uses two transmitter/receiver chains, each connected to an antenna to perform radiated tests.

WLAN traffic was generated by streaming the audio file "5\_GHz\_Audio\_Test\_file.WAV" from the Master to the Slave using Sonos Controller for PC version 6.34 software.

The EUT is a wireless audio device transmitting traffic at the highest duty cycle it is capable of producing.

TPC is not required since the maximum EIRP is less than 500 mW (27 dBm).

The EUT utilizes the 802.11a/n architecture. One nominal channel bandwidth, 20 MHz, is implemented.

The software installed in the EUT is revision 6.3.2 (Build 321130162e).

The software installed in the Master Device is revision 6.3.4.

### **UNIFORM CHANNEL SPREADING**

This is requirement not applicable to Slave Devices.

### **OVERVIEW OF MASTER DEVICE WITH RESPECT TO §15.407 (h) REQUIREMENTS**

The Master Device is a Sonos Playbar, FCC ID: SBVRM006. The minimum antenna gain for the Master Device is 4.1 dBi.

The rated output power of the Master unit is < 23dBm (EIRP). Therefore the required interference threshold level is -62 dBm. After correction for procedural adjustments, the required radiated threshold at the antenna port is  $-62 + 1 = -61$  dBm.

The calibrated radiated DFS Detection Threshold level is set to -64 dBm. The tested level is lower than the required level hence it provides a margin to the limit.

## 5.2. RESULTS FOR 20 MHz BANDWIDTH

### 5.2.1. TEST CHANNEL

All tests were performed at a channel center frequency of 5500 MHz.

### 5.2.2. RADAR WAVEFORM AND TRAFFIC

#### RADAR WAVEFORM

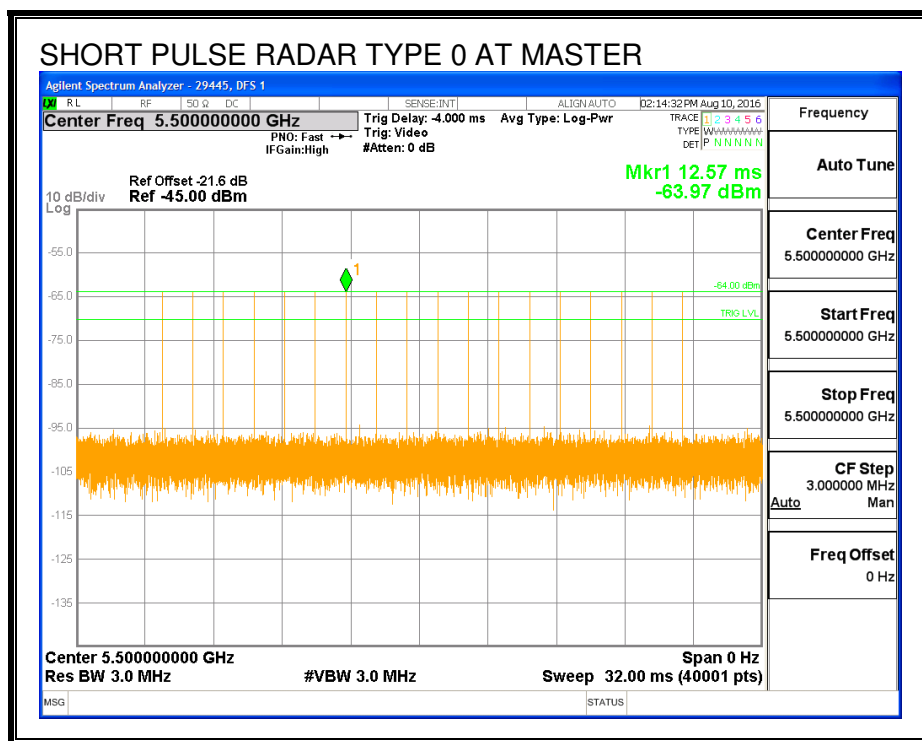



**TRAFFIC**

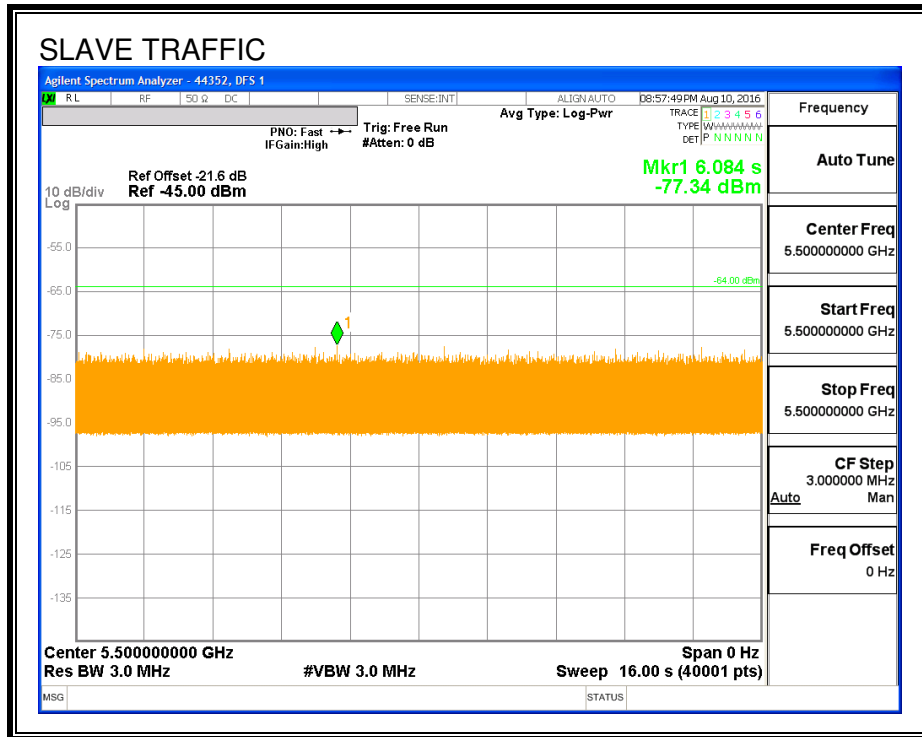

**CHANNEL LOADING**

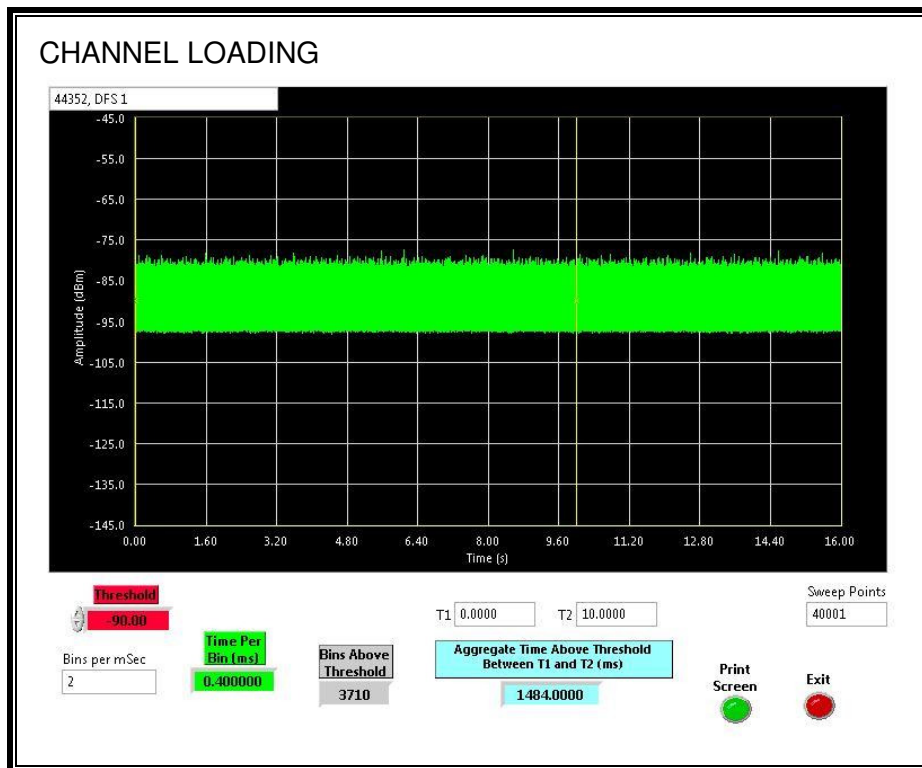

The level of traffic loading on the channel by the EUT is 14.84%

This is the maximum traffic attainable utilizing the standard FCC 5 GHz test file.

OVERLAPPING CHANNEL TESTS

**RESULTS**

These tests are not applicable.

**5.2.3. MOVE AND CLOSING TIME**

**REPORTING NOTES**

The reference marker is set at the end of last radar pulse.

The delta marker is set at the end of the last WLAN transmission following the radar pulse. This delta is the channel move time.

The aggregate channel closing transmission time is calculated as follows:

Aggregate Transmission Time =  
(Number of analyzer bins showing transmission) \* (dwell time per bin)

The observation period over which the aggregate time is calculated begins at (Reference Marker + 200 msec) and ends no earlier than (Reference Marker + 10 sec).

**RESULTS**

<b>Channel Move Time (sec)</b>	<b>Limit (sec)</b>
<b>0.000</b>	<b>10</b>

<b>Aggregate Channel Closing Transmission Time (msec)</b>	<b>Limit (msec)</b>
<b>0.0</b>	<b>60</b>



**CHANNEL CLOSING TIME**

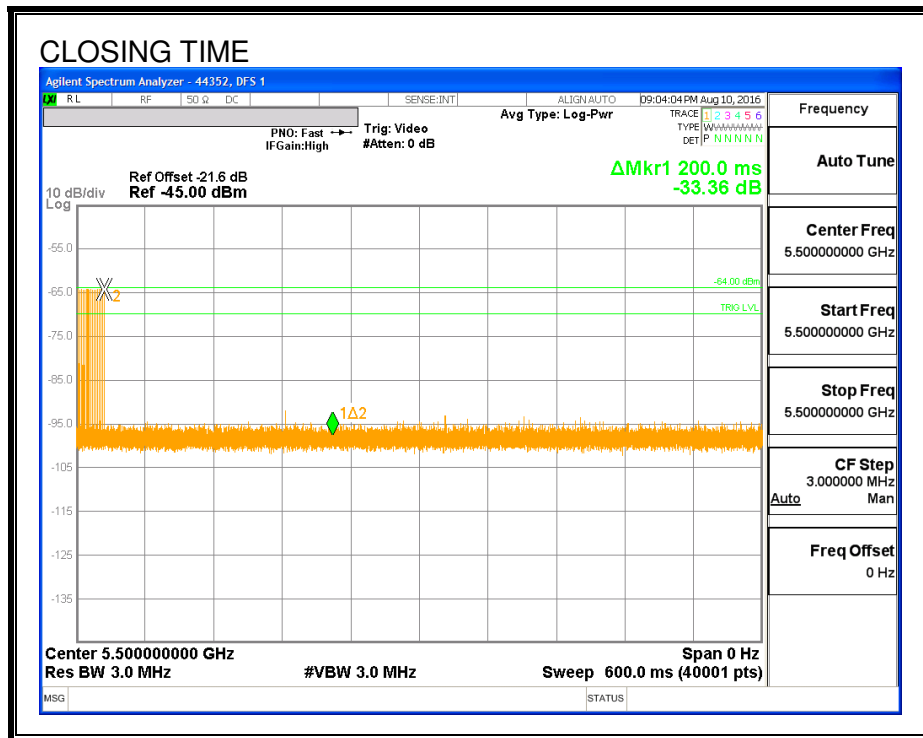

**AGGREGATE CHANNEL CLOSING TRANSMISSION TIME**

No transmissions are observed during the aggregate monitoring period.

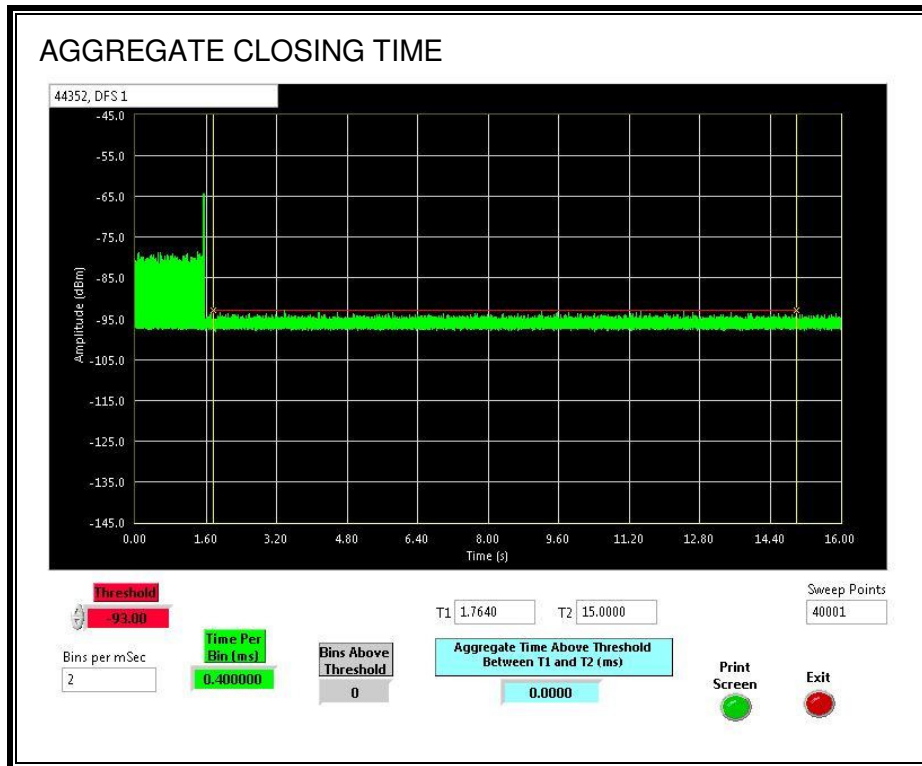

### 5.2.4. 10-MINUTE BEACON MONITORING PERIOD

#### RESULTS

No EUT transmissions were observed on the test channel during the 10-minute observation time.

