



**FCC CFR47 PART 15 SUBPART E
INDUSTRY CANADA RSS-210 ISSUE 8**

CERTIFICATION TEST REPORT

FOR

802.11a/b/g/n 2x2 Client Device

MODEL NUMBER: PLAY:1

FCC ID: SBVRM007

IC: 5373A-RM007

REPORT NUMBER: 13U14836-2, Revision B

ISSUE DATE: AUGUST 15, 2013

Prepared for

Sonos, Inc.

**223 E. De La Guerra Street
Santa Barbara, CA, 93101, U.S.A.**

Prepared by

UL VERIFICATION SERVICES INC.

**47173 BENICIA STREET
FREMONT, CA 94538, U.S.A.**

TEL: (510) 771-1000

FAX: (510) 661-0888



NVLAP LAB CODE 200065-0

Revision History

<u>Rev.</u>	<u>Issue Date</u>	<u>Revisions</u>	<u>Revised By</u>
--	05/22/13	Initial Issue	F. Ibrahim
A	08/06/13	Revised section 5.5	F. Ibrahim
B	08/15/13	Revised Test and Measurement Equipment, Pg 108	T. Lee

TABLE OF CONTENTS

1. ATTESTATION OF TEST RESULTS	5
2. TEST METHODOLOGY	6
3. FACILITIES AND ACCREDITATION	6
4. CALIBRATION AND UNCERTAINTY	6
4.1. <i>MEASURING INSTRUMENT CALIBRATION</i>	<i>6</i>
4.2. <i>SAMPLE CALCULATION</i>	<i>6</i>
4.3. <i>MEASUREMENT UNCERTAINTY.....</i>	<i>6</i>
5. EQUIPMENT UNDER TEST	7
5.1. <i>DESCRIPTION OF EUT</i>	<i>7</i>
5.2. <i>MAXIMUM OUTPUT POWER.....</i>	<i>7</i>
5.3. <i>DESCRIPTION OF AVAILABLE ANTENNAS</i>	<i>7</i>
5.4. <i>SOFTWARE AND FIRMWARE.....</i>	<i>7</i>
5.5. <i>WORST-CASE CONFIGURATION AND MODE.....</i>	<i>8</i>
5.6. <i>DESCRIPTION OF TEST SETUP.....</i>	<i>9</i>
6. TEST AND MEASUREMENT EQUIPMENT	11
7. ON TIME, DUTY CYCLE AND MEASUREMENT METHODS	12
7.1. <i>ON TIME AND DUTY CYCLE RESULTS.....</i>	<i>12</i>
7.2. <i>MEASUREMENT METHOD FOR POWER AND PPSD.....</i>	<i>12</i>
7.3. <i>MEASUREMENT METHOD FOR AVG SPURIOUS EMISSION ABOVE 1 GHz.....</i>	<i>12</i>
7.4. <i>DUTY CYCLE PLOTS</i>	<i>13</i>
8. ANTENNA PORT TEST RESULTS	14
8.1. <i>802.11n HT20 MODE IN THE 5.2 GHz BAND</i>	<i>14</i>
8.1.1. <i>26 dB BANDWIDTH.....</i>	<i>14</i>
8.1.2. <i>99% BANDWIDTH.....</i>	<i>18</i>
8.1.3. <i>AVERAGE POWER.....</i>	<i>22</i>
8.1.4. <i>OUTPUT POWER AND PPSD</i>	<i>23</i>
8.1.5. <i>PEAK EXCURSION.....</i>	<i>28</i>
8.2. <i>802.11n HT20 MODE IN THE 5.3 GHz BAND</i>	<i>30</i>
8.2.1. <i>26 dB BANDWIDTH.....</i>	<i>30</i>
8.2.2. <i>99% BANDWIDTH.....</i>	<i>34</i>
8.2.3. <i>AVERAGE POWER</i>	<i>38</i>
8.2.4. <i>OUTPUT POWER AND PPSD</i>	<i>39</i>
8.2.5. <i>PEAK EXCURSION.....</i>	<i>44</i>
8.3. <i>802.11n HT20 MODE IN THE 5.6 GHz BAND</i>	<i>45</i>
8.3.1. <i>26 dB BANDWIDTH.....</i>	<i>45</i>
8.3.2. <i>99% BANDWIDTH.....</i>	<i>49</i>

8.3.3. AVERAGE POWER53
8.3.4. OUTPUT POWER AND PPSD54
8.3.5. PEAK EXCURSION59

9. RADIATED TEST RESULTS.....60

9.1. LIMITS AND PROCEDURE 60

9.2. TRANSMITTER ABOVE 1 GHz 61

9.2.1. TX ABOVE 1 GHz 802.11n HT20 MODE IN THE 5.2 GHz BAND.....61

9.2.2. TX ABOVE 1 GHz 802.11n HT20 MODE IN THE 5.3 GHz BAND.....72

9.2.3. TX ABOVE 1 GHz 802.11n HT20 MODE IN THE 5.6 GHz BAND.....83

9.3. WORST-CASE BELOW 1 GHz.....96

10. AC POWER LINE CONDUCTED EMISSIONS99

11. DYNAMIC FREQUENCY SELECTION103

11.1. OVERVIEW..... 103

11.1.1. LIMITS 103

11.1.2. TEST AND MEASUREMENT SYSTEM 106

11.1.3. SETUP OF EUT 109

11.1.4. DESCRIPTION OF EUT..... 110

11.2. RESULTS FOR 20 MHz BANDWIDTH..... 112

11.2.1. TEST CHANNEL..... 112

11.2.2. RADAR WAVEFORM AND TRAFFIC 112

11.2.3. OVERLAPPING CHANNEL TESTS 114

11.2.4. MOVE AND CLOSING TIME..... 114

11.2.5. NON-OCCUPANCY PERIOD..... 119

12. SETUP PHOTOS120

1. ATTESTATION OF TEST RESULTS

COMPANY NAME: Sonos, Inc.
223 E. De La Guerra Street
Santa Barbara, CA, 93101, U.S.A.

EUT DESCRIPTION: 802.11a/b/g/n 2x2 Client Device

MODEL: PLAY:1

SERIAL NUMBER: 00-0E-58-C0-00-CA-6, 00-0E-58-C0-00-E2-D.

DATE TESTED: March 26 – May 21, 2013

APPLICABLE STANDARDS	
STANDARD	TEST RESULTS
CFR 47 Part 15 Subpart E	Pass
INDUSTRY CANADA RSS-210 Issue 8 Annex 9	Pass
INDUSTRY CANADA RSS-GEN Issue 3	Pass

UL Verification Services Inc. tested the above equipment in accordance with the requirements set forth in the above standards. All indications of Pass/Fail in this report are opinions expressed by UL Verification Services Inc. based on interpretations and/or observations of test results. Measurement Uncertainties were not taken into account and are published for informational purposes only. The test results show that the equipment tested is capable of demonstrating compliance with the requirements as documented in this report.

Note: The results documented in this report apply only to the tested sample, under the conditions and modes of operation as described herein. This document may not be altered or revised in any way unless done so by UL Verification Services Inc. and all revisions are duly noted in the revisions section. Any alteration of this document not carried out by UL Verification Services Inc. will constitute fraud and shall nullify the document. This report must not be used by the client to claim product certification, approval, or endorsement by NVLAP, NIST, any agency of the Federal Government, or any agency of any government.

Approved & Released For
UL Verification Services Inc. By:



FRANK IBRAHIM
WiSE PROGRAM MANAGER
UL Verification Services Inc

Tested By:



TONY WAGONER
EMC ENGINEER
UL Verification Services Inc

2. TEST METHODOLOGY

The tests documented in this report were performed in accordance with FCC CFR 47 Part 2, FCC CFR 47 Part 15, FCC 06-96, FCC KDB 789033, ANSI C63.10-2009, RSS-GEN Issue 3, and RSS-210 Issue 8.

3. FACILITIES AND ACCREDITATION

The test sites and measurement facilities used to collect data are located at 47173 Benicia Street, Fremont, California, USA.

UL Verification Services Inc. is accredited by NVLAP, Laboratory Code 200065-0. The full scope of accreditation can be viewed at <http://www.ccsemc.com>.

4. CALIBRATION AND UNCERTAINTY

4.1. MEASURING INSTRUMENT CALIBRATION

The measuring equipment utilized to perform the tests documented in this report has been calibrated in accordance with the manufacturer's recommendations, and is traceable to recognized national standards.

4.2. SAMPLE CALCULATION

Where relevant, the following sample calculation is provided:

$$\begin{aligned} \text{Field Strength (dBuV/m)} &= \text{Measured Voltage (dBuV)} + \text{Antenna Factor (dB/m)} + \\ &\text{Cable Loss (dB)} - \text{Preamp Gain (dB)} \\ 36.5 \text{ dBuV} + 18.7 \text{ dB/m} + 0.6 \text{ dB} - 26.9 \text{ dB} &= 28.9 \text{ dBuV/m} \end{aligned}$$

4.3. MEASUREMENT UNCERTAINTY

Where relevant, the following measurement uncertainty levels have been estimated for tests performed on the apparatus:

PARAMETER	UNCERTAINTY
Conducted Disturbance, 0.15 to 30 MHz	3.52 dB
Radiated Disturbance, 30 to 1000 MHz	4.94 dB

Uncertainty figures are valid to a confidence level of 95%.

5. EQUIPMENT UNDER TEST

5.1. DESCRIPTION OF EUT

EUT is an 802.11a/b/g/n (2x2, 20 MHz channel bandwidth only) DFS client device.

5.2. MAXIMUM OUTPUT POWER

The transmitter has a maximum conducted output power as follows:

Frequency Range (MHz)	Mode	Output Power (dBm)	Output Power (mW)
5180 - 5240	802.11n HT20	15.195	33.075
5260 - 5320	802.11n HT20	21.552	142.955
5500 - 5700	802.11n HT20	21.466	140.152

5.3. DESCRIPTION OF AVAILABLE ANTENNAS

The radio utilizes the following antennas:

Dipole, PCB antenna, with the following gains:

2.4 GHz band:

Right Antenna (Red) = 2.85 dBi

Left Antenna (Yellow) = 3.09 dBi

5 GHz bands:

Right Antenna (Red) = 3.59 dBi

Left Antenna (Yellow) = 3.29 dBi

5.4. SOFTWARE AND FIRMWARE

The firmware installed in the EUT during testing was V4.2

The EUT driver software installed in the support laptop during testing was Busy box, rev. V1.14.1.

The test utility software used during testing was Note Pad script.

5.5. WORST-CASE CONFIGURATION AND MODE

Radiated emission and power line conducted emission were performed with the EUT set to transmit at the channel with highest output power as worst-case scenario.

The EUT is for desktop applications; all radiated testing was performed with EUT laid out in desktop configuration.

Per the manufacturer, only the following data rates are used for the EUT, and these are the data rates used for the testing:

802.11n HT20 mode in the 5 GHz bands: 26 Mbps (QPSK, MCS9)

5.6. DESCRIPTION OF TEST SETUP

SUPPORT EQUIPMENT

Support Equipment List				
Description	Manufacturer	Model	Serial Number	FCC ID
Router	LINKSYS	BEFSR81 ver. 3	C2220E202195	n/a
Laptop	DELL	LATITUDE E4310	CN0928G47243807F16F1A00	n/a

I/O CABLES

Cable No	Port	# of identical ports	Connector Type	Cable Type	Cable Length (m)	Remarks
1	ac	none	ac	Unshielded	1	n/a
2	ac	none	ac	Unshielded	1.5	n/a
3	ac	none	ac adapter	Unshielded	1.5	n/a
4	ethernet	none	RJ45	Unshielded	1	n/a
5	ethernet	none	RJ45	Unshielded	2	n/a

TEST SETUP

The EUT and the support laptop were connected to the Access Point during the tests. A command prompt was used to select channels and power settings from a list of commands to exercise the radio card.

SETUP DIAGRAM FOR TESTS

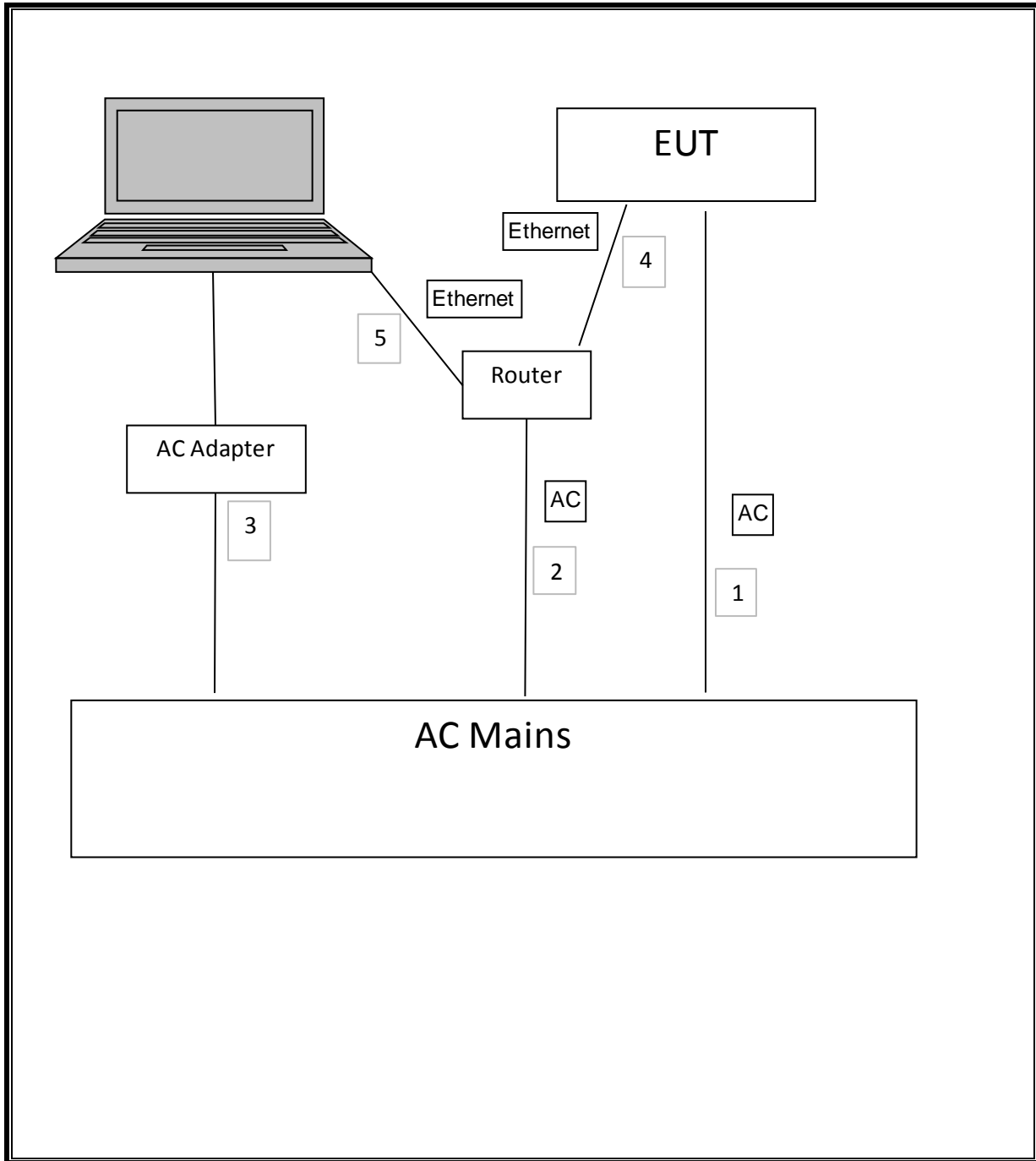

6. TEST AND MEASUREMENT EQUIPMENT

The following test and measurement equipment was utilized for the tests documented in this report:

Test Equipment List					
Description	Manufacturer	Model	Asset	Cal Date	Cal Due
Spectrum Analyzer, 44 GHz	Agilent / HP	E4446A	C00986	04/01/13	04/01/14
Spectrum Analyzer, 44 GHz	Agilent / HP	E4446A	C01069	12/20/12	12/20/13
Peak Power Meter	Agilent / HP	E4416A	C00963	12/13/12	12/13/13
Peak / Average Power Sensor	Agilent / HP	E9327A	C00964	12/13/12	12/13/13
Antenna, Horn, 40GHz	ARA	MWH-2640/B	C00981	06/14/13	06/14/13
Antenna, Horn, 18 GHz	ETS	3117	C01022	02/21/13	02/21/14
Antenna, Bilog, 30MHz-1 GHz	Sunol Sciences	JB1	C01171	02/13/13	02/13/14
Preamplifier, 40 GHz	Miteq	NSP4000-SP2	C00990	08/02/11	08/02/13
Preamplifier, 26.5 GHz	Agilent / HP	8449B	C01052	10/22/12	10/22/13
Preamplifier, 1300 MHz	Agilent / HP	8447D	C00885	01/16/13	01/16/14
Reject Filter, 5.15-5.35 GHz	Micro-Tronics	BRC13190	N02679	CNR	CNR
Band Reject Filter, 5150-5350MHz	Micro-Tronics	BRC13190	N/A	03/23/13	03/23/14
Reject Filter, 5.725-5.825 GHz	Micro-Tronics	BRC13192	N02677	CNR	CNR
LISN, 30 MHz	FCC	50/250-25-2	C00626	01/14/13	01/14/14
EMI Test Receiver, 30 MHz	R & S	ESHS 20	N02396	08/08/12	08/08/13

7. ON TIME, DUTY CYCLE AND MEASUREMENT METHODS

LIMITS

None; for reporting purposes only.

PROCEDURE

KDB 789033 Zero-Span Spectrum Analyzer Method.

7.1. ON TIME AND DUTY CYCLE RESULTS

Mode	ON Time B (msec)	Period (msec)	Duty Cycle x (linear)	Duty Cycle (%)	Duty Cycle Correction Factor (dB)	1/T Minimum VBW (kHz)
802.11n HT20	1.30	1.47	0.884	88.4%	0.53	0.769

7.2. MEASUREMENT METHOD FOR POWER AND PPSD

The Duty Cycle is less than 98% and consistent therefore KDB 789033 Method SA-2 is used.

7.3. MEASUREMENT METHOD FOR AVG SPURIOUS EMISSION ABOVE 1 GHz

The Duty Cycle is less than 98% and consistent, KDB 789033 Method VB with Power RMS Averaging is used.

7.4. DUTY CYCLE PLOTS

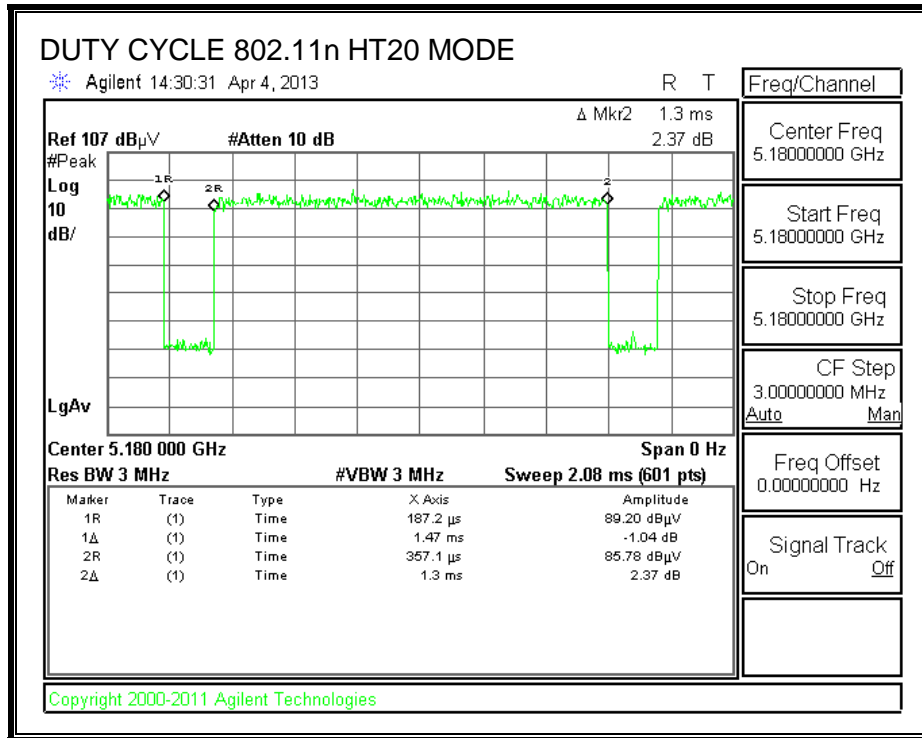

8. ANTENNA PORT TEST RESULTS

8.1. 802.11n HT20 MODE IN THE 5.2 GHz BAND

8.1.1. 26 dB BANDWIDTH

LIMITS

None; for reporting purposes only.

RESULTS

Channel	Frequency (MHz)	26 dB BW Chain 0 (MHz)	26 dB BW Chain 1 (MHz)
Low	5180	26.72	27.77
Mid	5200	26.48	30.24
High	5240	26.83	28.25

26 dB BANDWIDTH

Chain 0

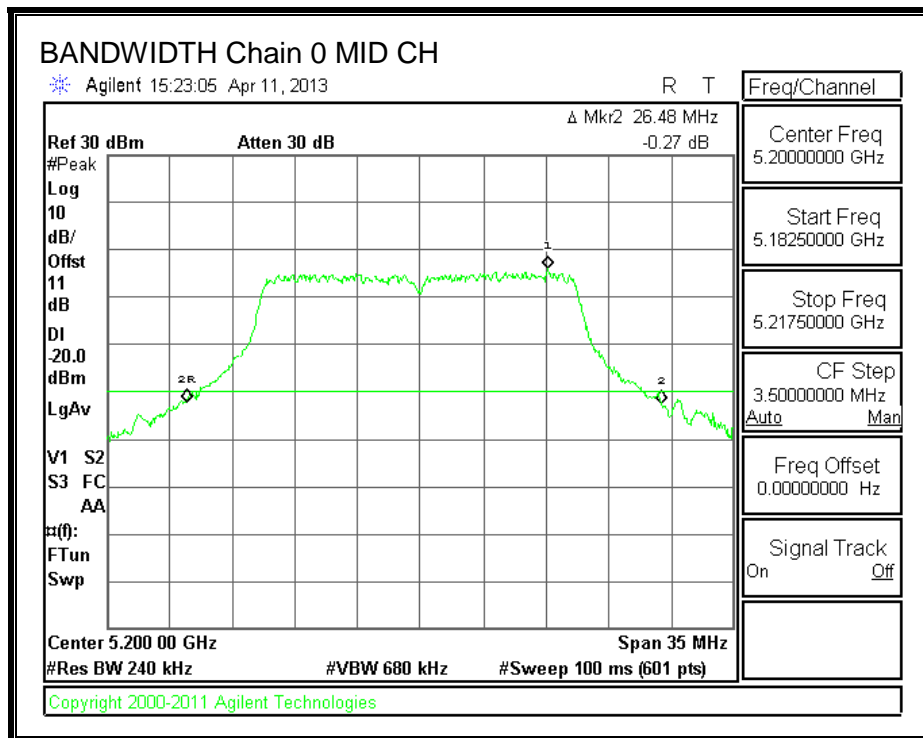
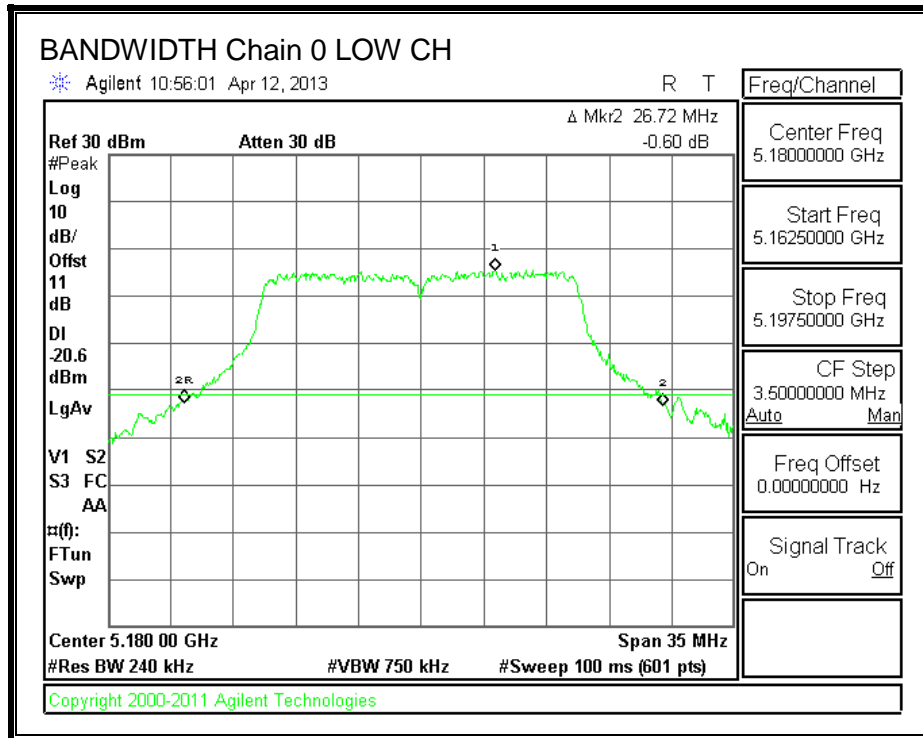

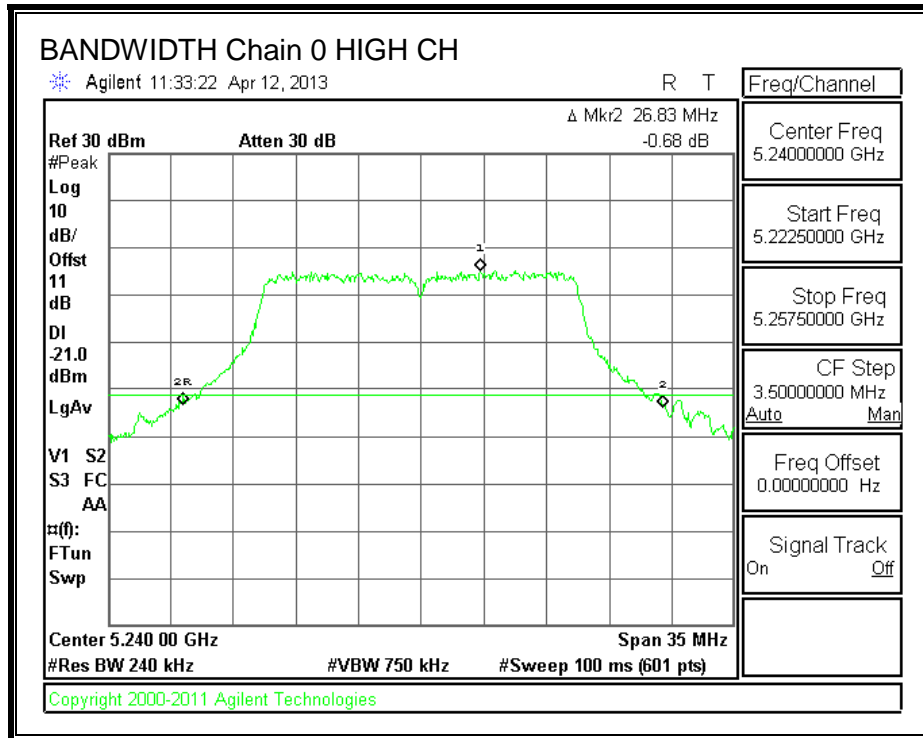

Chain 1

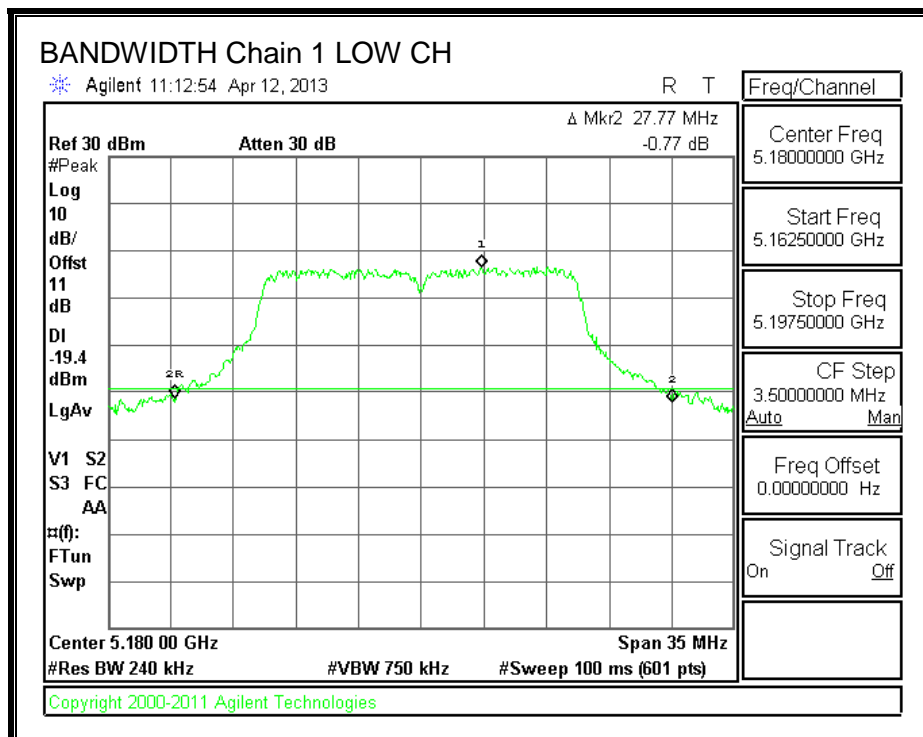

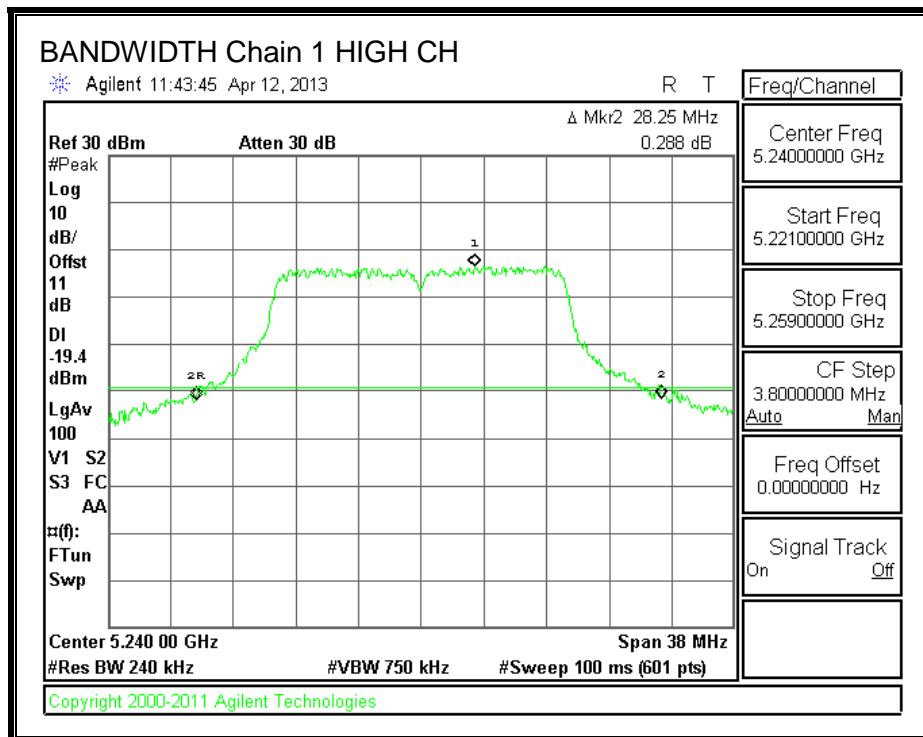
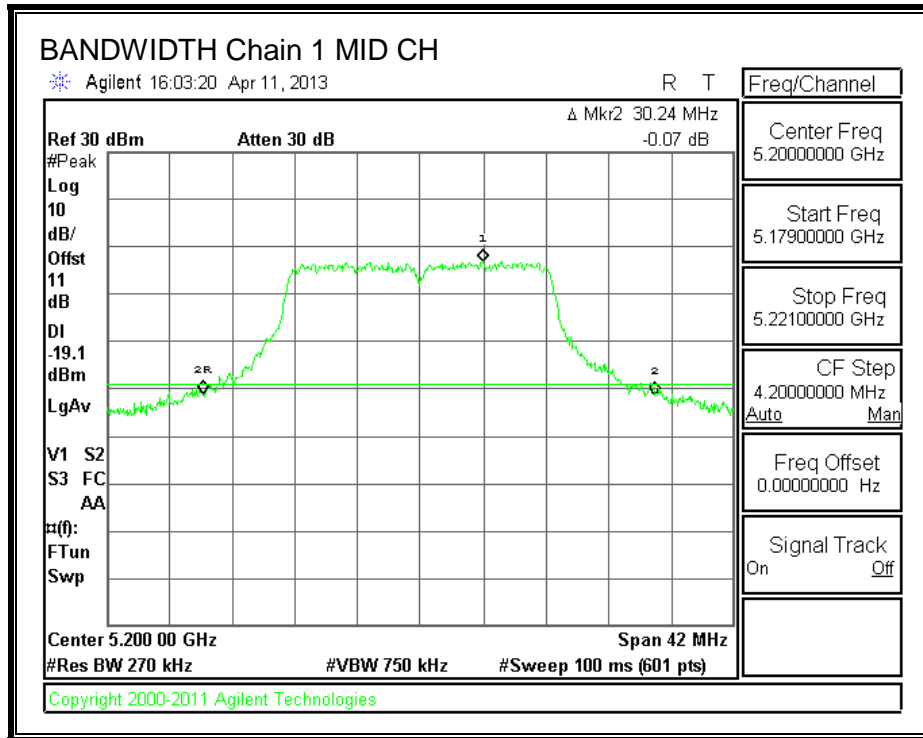

8.1.2. 99% BANDWIDTH

LIMITS

None; for reporting purposes only.

RESULTS

Channel	Frequency (MHz)	99% BW Chain 0 (MHz)	99% BW Chain 1 (MHz)
Low	5180	17.9100	17.8932
Mid	5200	19.8435	17.8604
High	5240	17.8361	17.8724

99% BANDWIDTH

Chain 0

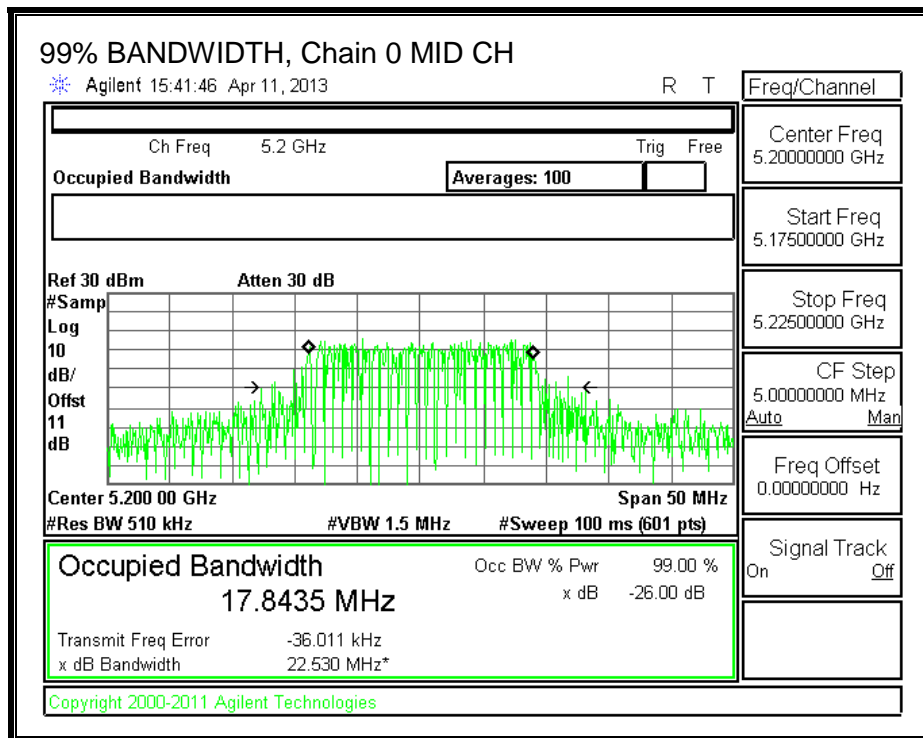
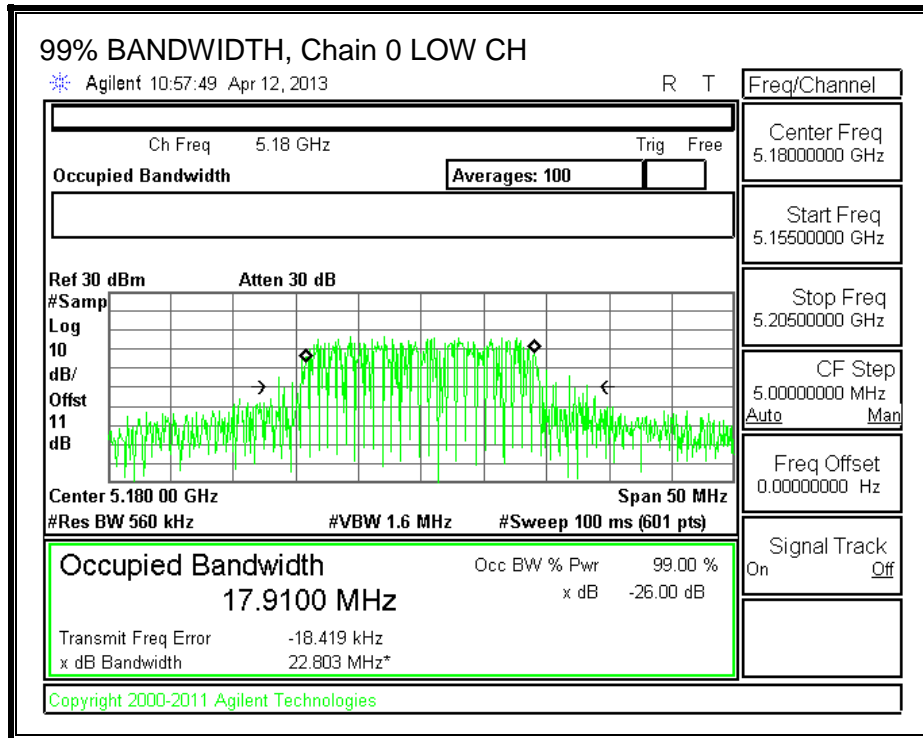

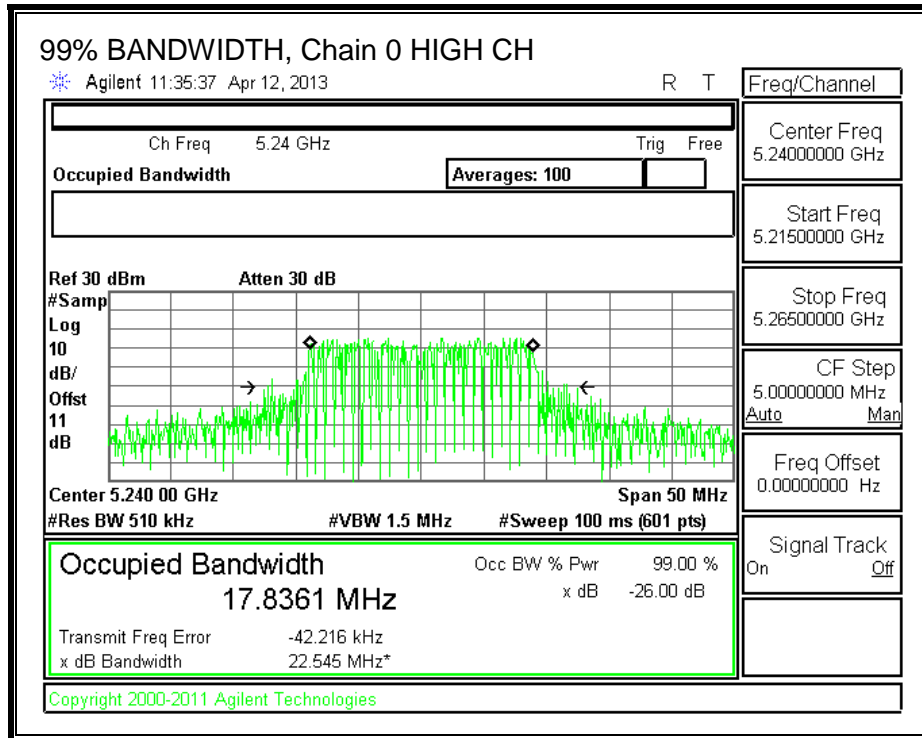

99% BANDWIDTH, Chain 1

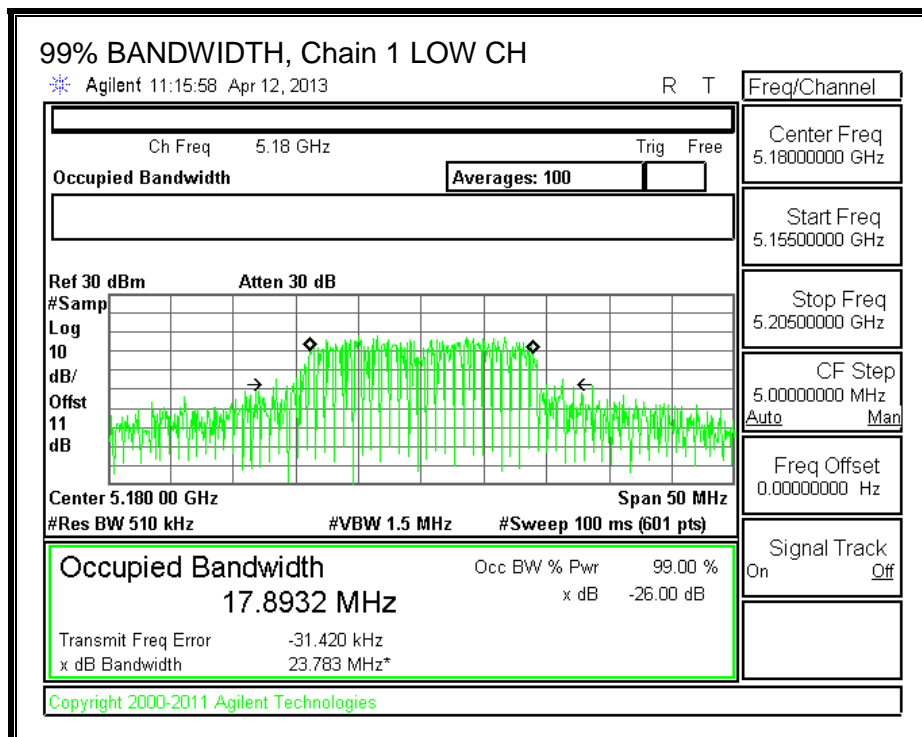

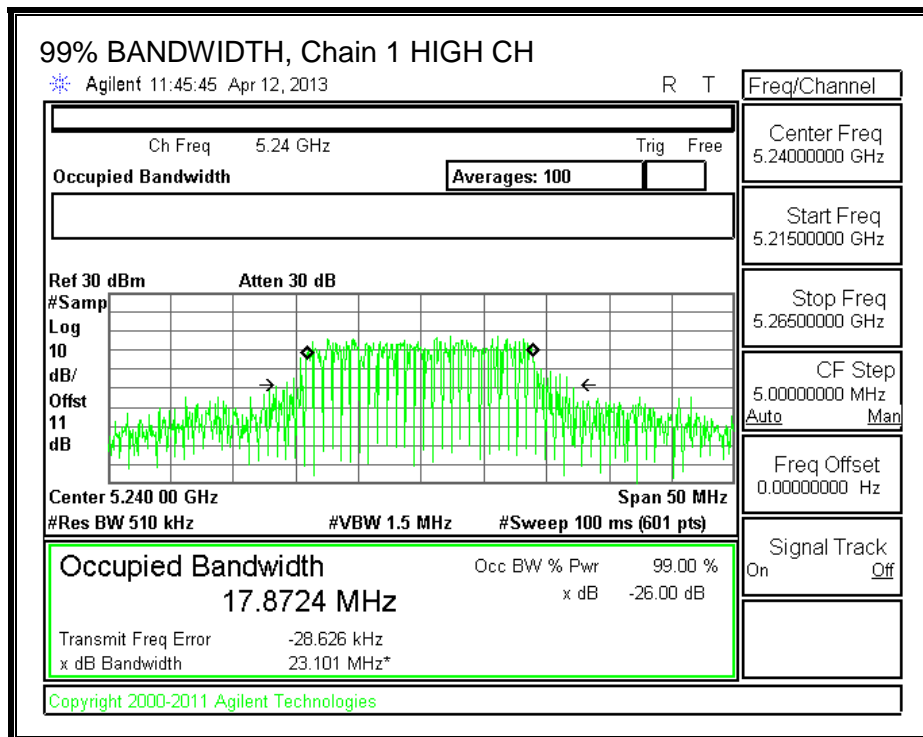
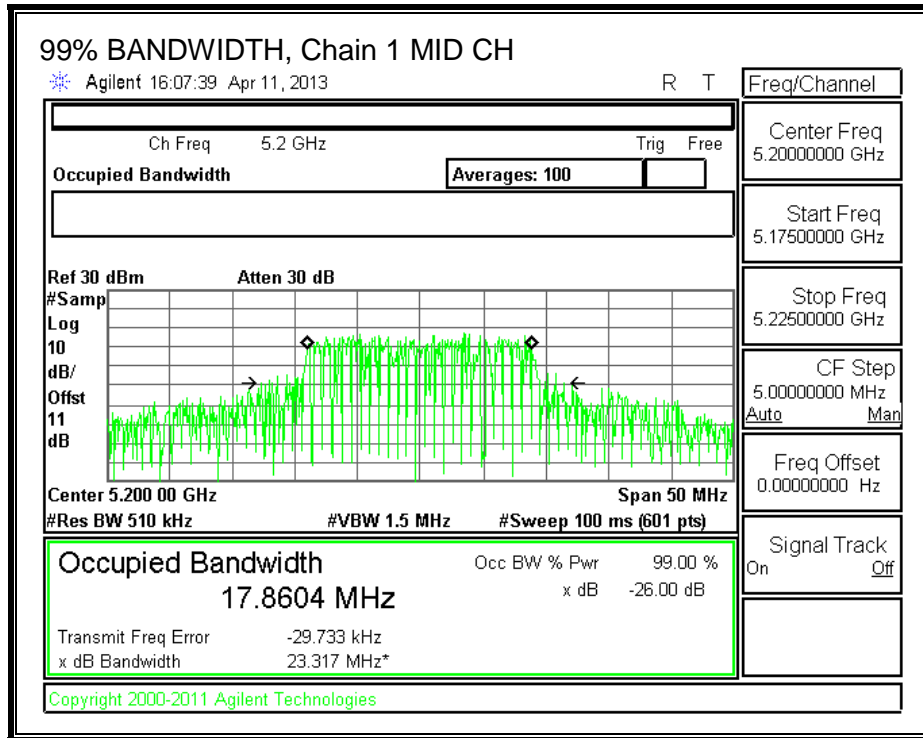

8.1.3. AVERAGE POWER

LIMITS

None; for reporting purposes only.

TEST PROCEDURE

The transmitter output is connected to a power meter.

The cable assembly insertion loss of 11 dB (including 10 dB pad and 1.0 dB cable) was entered as an offset in the power meter to allow for direct reading of power.

RESULTS

Average Power Results

Channel	Frequency (MHz)	Chain 0 Power (dBm)	Chain 1 Power (dBm)	Total Power (dBm)
Low	5180	10.80	11.54	14.20
Mid	5200	10.88	11.38	14.15
High	5240	10.44	11.09	13.79

8.1.4. OUTPUT POWER AND PPSD

LIMITS

FCC §15.407 (a) (1)

For the band 5.15–5.25 GHz, the maximum conducted output power over the frequency band of operation shall not exceed the lesser of 50 mW or 4 dBm + 10 log B, where B is the 26–dB emission bandwidth in MHz. In addition, the peak power spectral density shall not exceed 4 dBm in any 1–MHz band. If transmitting antennas of directional gain greater than 6 dBi are used, both the maximum conducted output power and the peak power spectral density shall be reduced by the amount in dB that the directional gain of the antenna exceeds 6 dBi.

IC RSS-210 A9.2 (1)

The maximum e.i.r.p. shall not exceed 200 mW or 10 + 10 log₁₀ B, dBm, whichever power is less. B is the 99% emission bandwidth in MHz. The e.i.r.p. spectral density shall not exceed 10 dBm in any 1.0 MHz band.

DIRECTIONAL ANTENNA GAIN

The TX chains are uncorrelated and the antenna gain is unequal among the chains. The directional gain is:

Chain 0 Antenna Gain (dBi)	Chain 1 Antenna Gain (dBi)	Uncorrelated Chains Directional Gain (dBi)
3.59	3.29	3.44

RESULTS

Bandwidth and Antenna Gain

Channel	Frequency (MHz)	Min 26 dB BW (MHz)	Min 99% BW (MHz)	Directional Gain (dBi)
Low	5180	26.72	17.8932	3.44
Mid	5200	26.48	17.8435	3.44
High	5240	26.83	17.8361	3.44

Limits

Channel	Frequency (MHz)	FCC Power Limit (dBm)	IC EIRP Limit (dBm)	Max IC Power (dBm)	Power Limit (dBm)	FCC PPSD Limit (dBm)	IC eirp PSD Limit (dBm)	PPSD Limit (dBm)
Low	5180	17.00	22.53	19.09	17.00	4.00	10.00	4.00
Mid	5200	17.00	22.51	19.07	17.00	4.00	10.00	4.00
High	5240	17.00	22.51	19.07	17.00	4.00	10.00	4.00

Duty Cycle CF (dB)	0.53	Included in Calculations of Corr'd Power & PPSD
---------------------------	------	--

Output Power Results

Channel	Frequency (MHz)	Chain 0 Meas Power (dBm)	Chain 1 Meas Power (dBm)	Total Corr'd Power (dBm)	Power Limit (dBm)	Power Margin (dB)
Low	5180	11.361	11.930	15.195	17.00	-1.805
Mid	5200	11.495	11.760	15.170	17.00	-1.830
High	5240	11.021	12.055	15.109	17.00	-1.891

PPSD Results

Channel	Frequency (MHz)	Chain 0 Meas PPSD (dBm)	Chain 1 Meas PPSD (dBm)	Total Corr'd PPSD (dBm)	PPSD Limit (dBm)	PPSD Margin (dB)
Low	5180	0.29	0.39	3.88	4.00	-0.12
Mid	5200	0.10	0.41	3.80	4.00	-0.20
High	5240	-0.16	0.68	3.82	4.00	-0.18

OUTPUT POWER AND PPSD, Chain 0

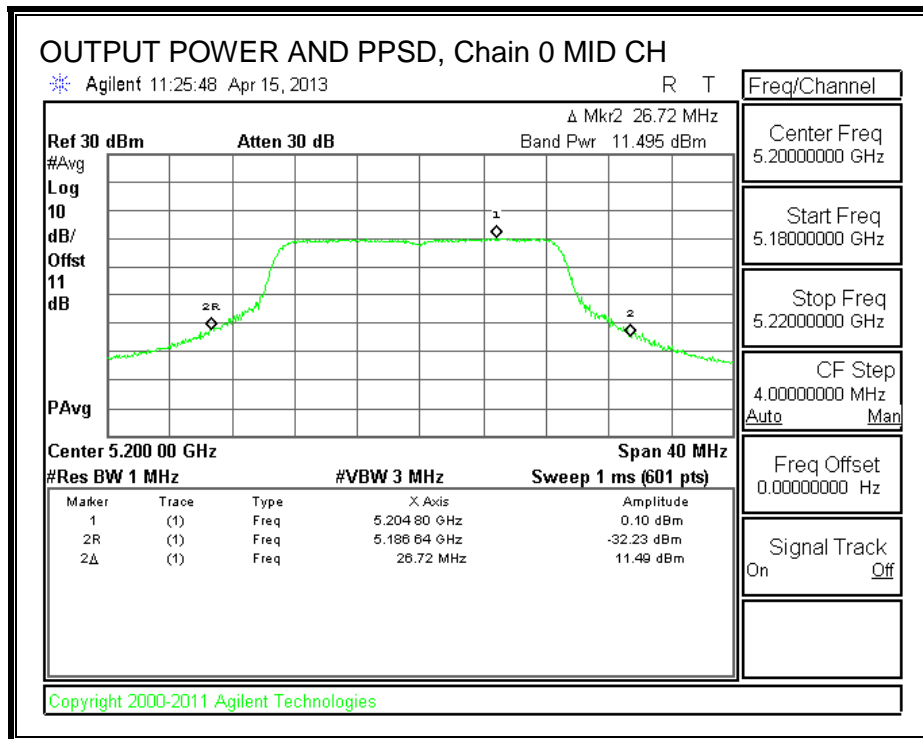
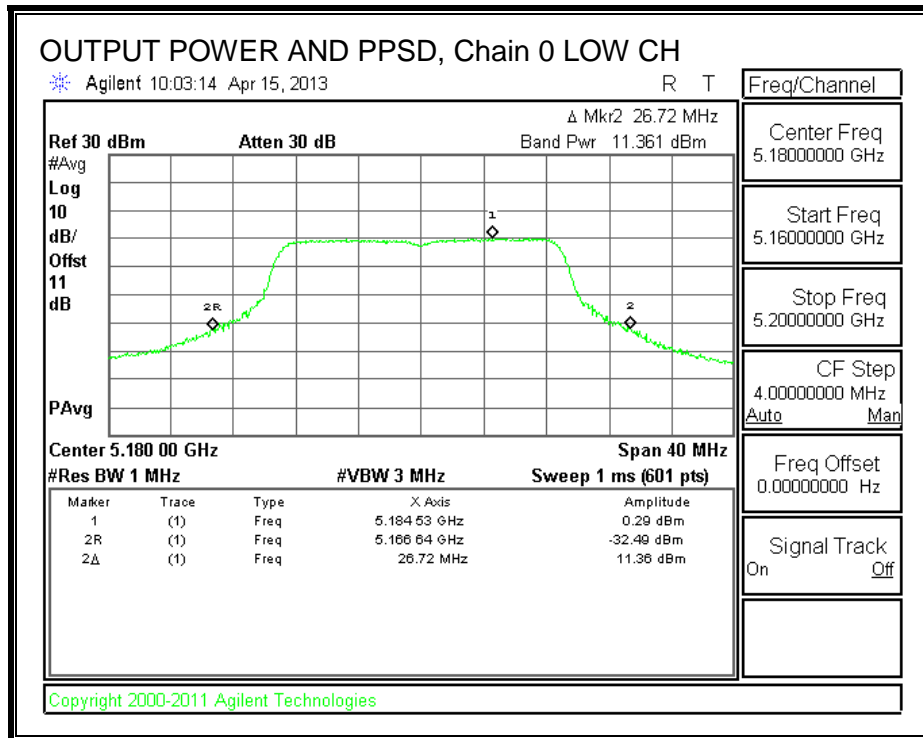

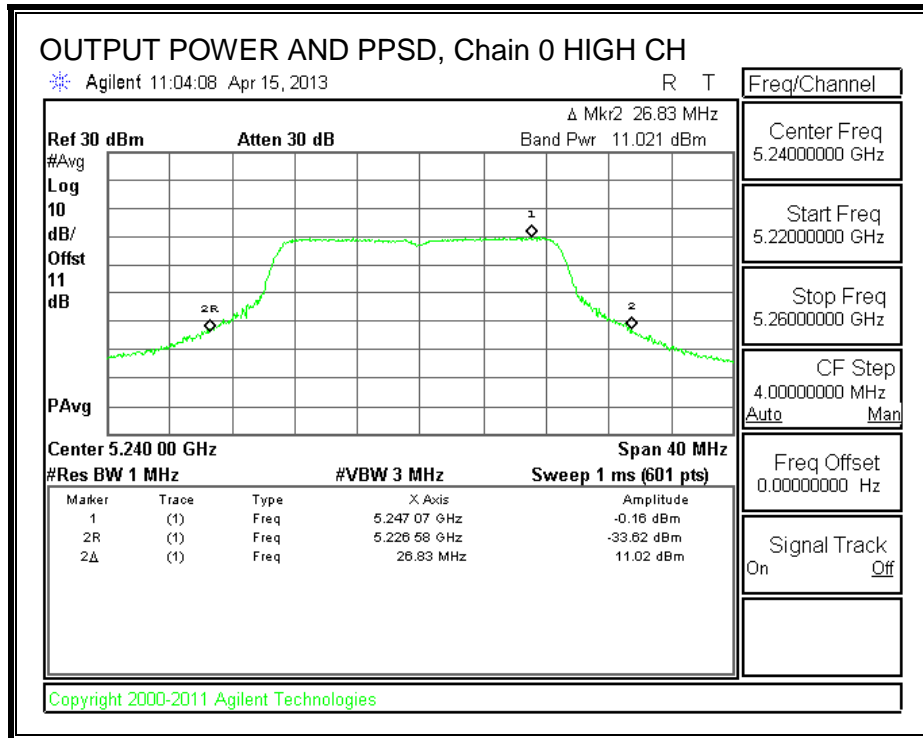

OUTPUT POWER AND PPSD, Chain 1

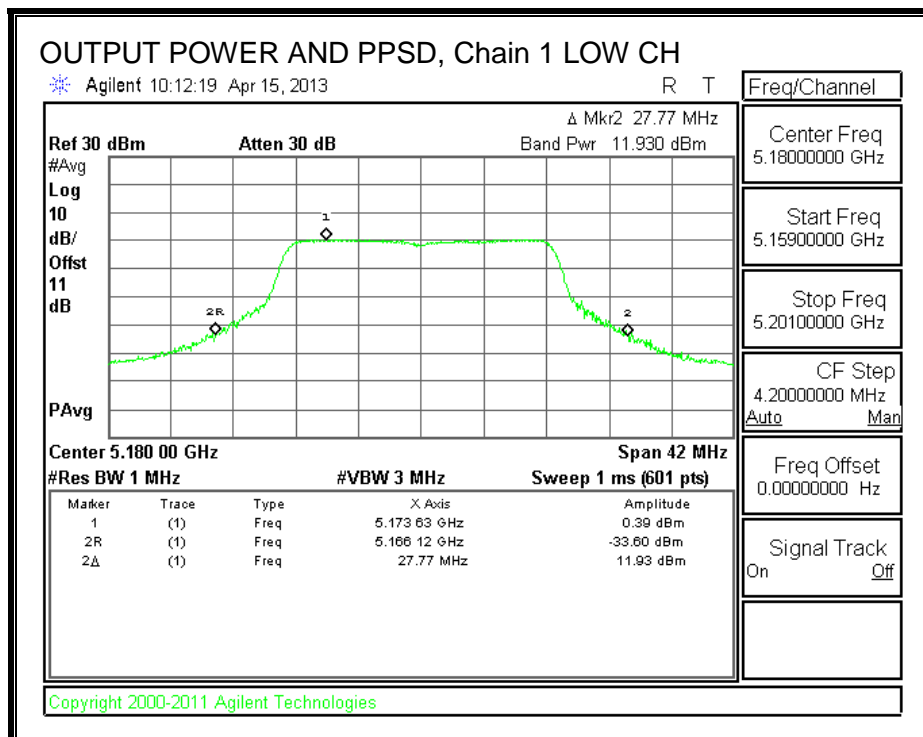

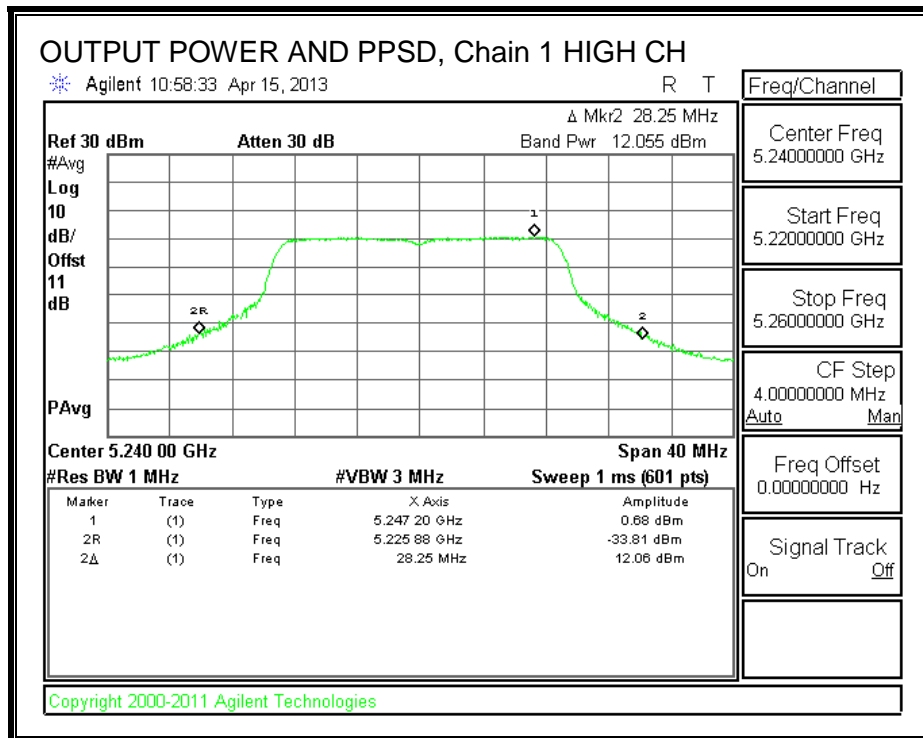
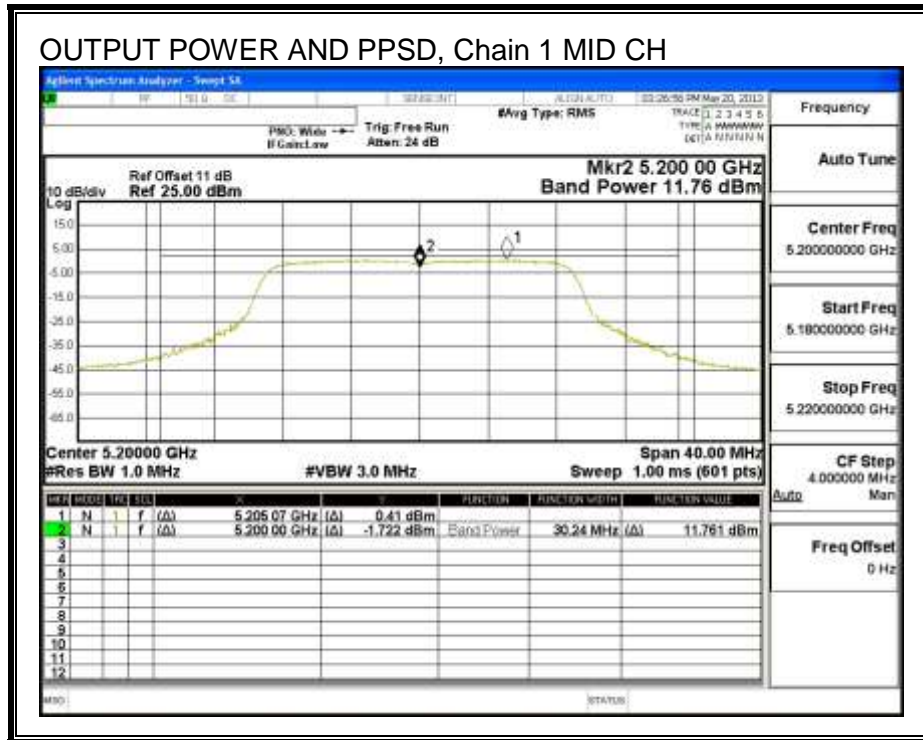

8.1.5. PEAK EXCURSION

LIMITS

FCC §15.407 (a) (6)

The ratio of the peak excursion of the modulation envelope (measured using a peak hold function) to the peak transmit power (measured as specified above) shall not exceed 13 dB across any 1 MHz bandwidth or the emission bandwidth whichever is less.

RESULTS

Chain 0

Channel	Frequency (MHz)	PK Level (dBm)	PSD (dBm)	DCCF (dB)	Peak Excursion (dB)	Limit (dB)	Margin (dB)
Mid	5200	8.29	0.10	0.53	7.66	13	-5.34

Chain 1

Channel	Frequency (MHz)	PK Level (dBm)	PSD (dBm)	DCCF (dB)	Peak Excursion (dB)	Limit (dB)	Margin (dB)
Mid	5200	8.95	0.54	0.53	7.88	13	-5.12

PEAK EXCURSION, Chain 0

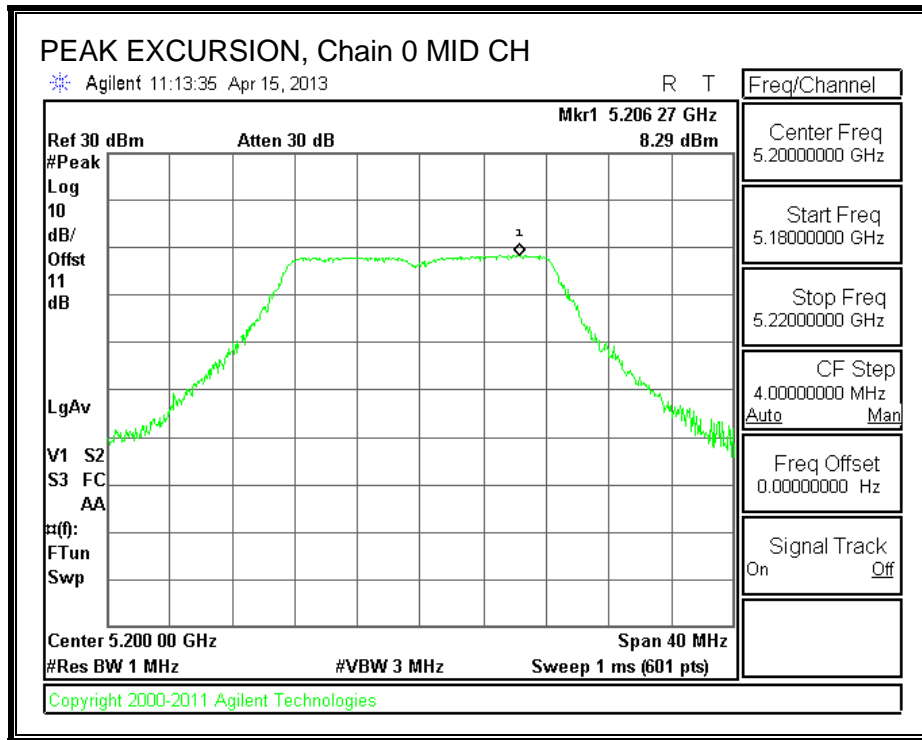

PEAK EXCURSION, Chain 1

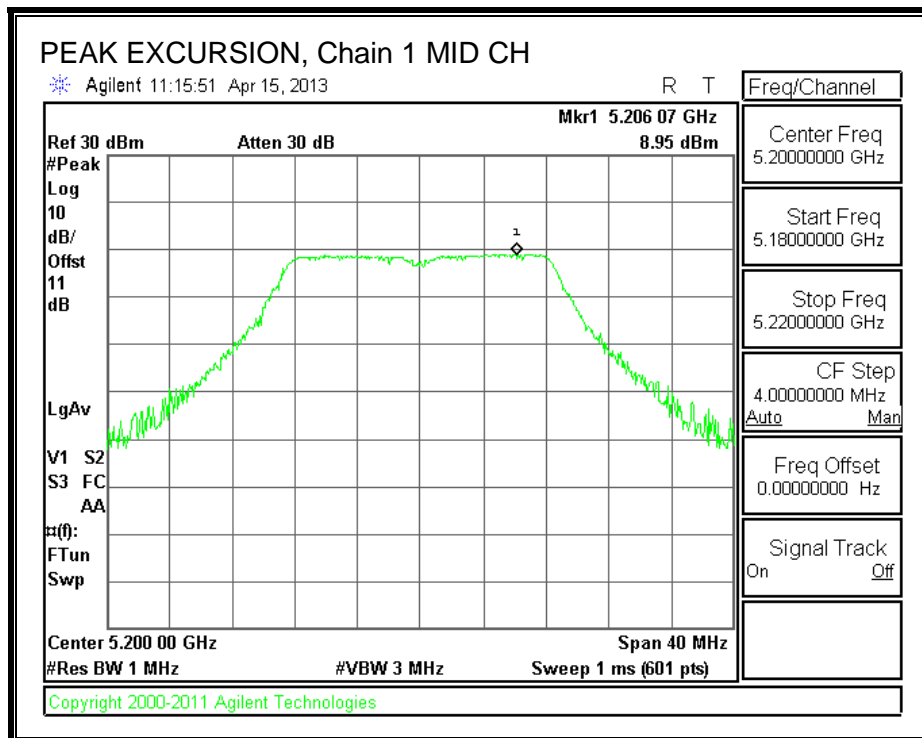

8.2. 802.11n HT20 MODE IN THE 5.3 GHz BAND

8.2.1. 26 dB BANDWIDTH

LIMITS

None; for reporting purposes only.

RESULTS

Channel	Frequency (MHz)	26 dB BW Chain 0 (MHz)	26 dB BW Chain 1 (MHz)
Low	5260	26.55	28.60
Mid	5300	35.02	44.64
High	5320	27.00	27.53

26 dB BANDWIDTH, Chain 0

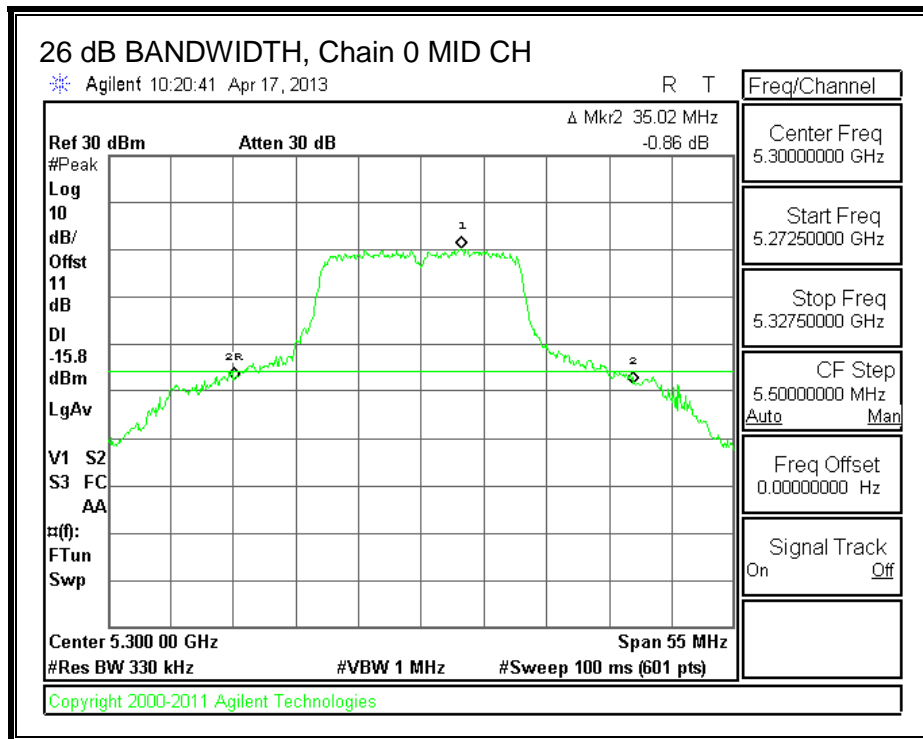
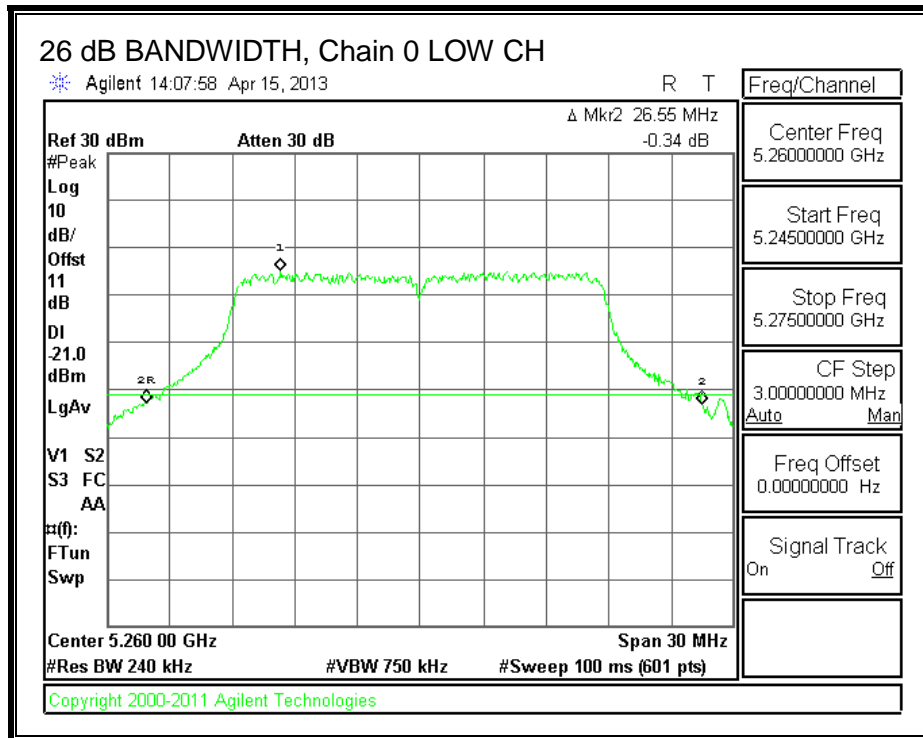

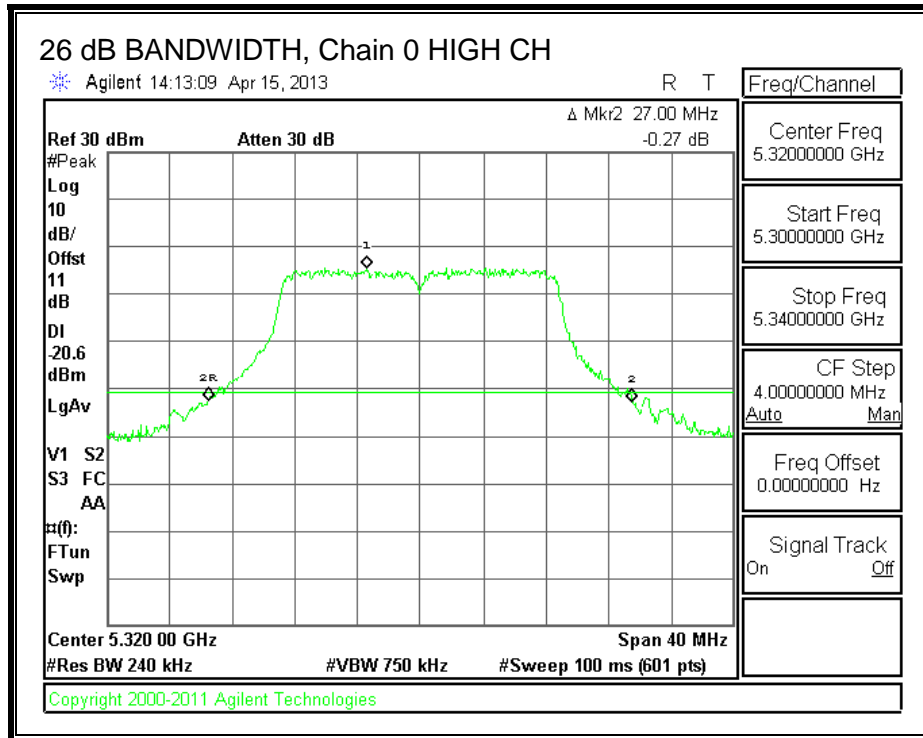

26 dB BANDWIDTH, Chain 1

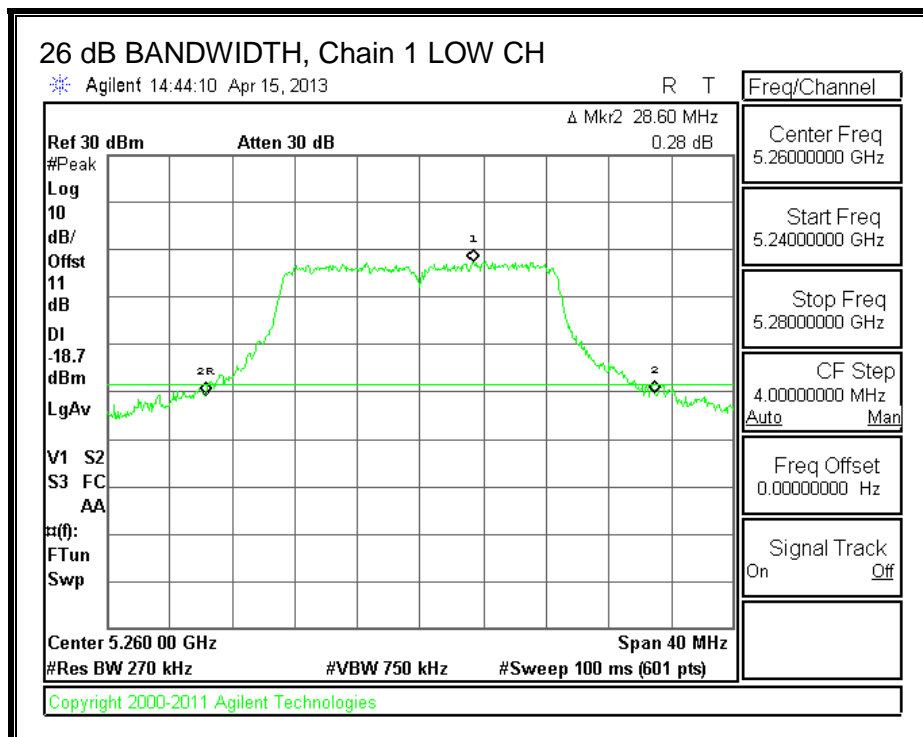

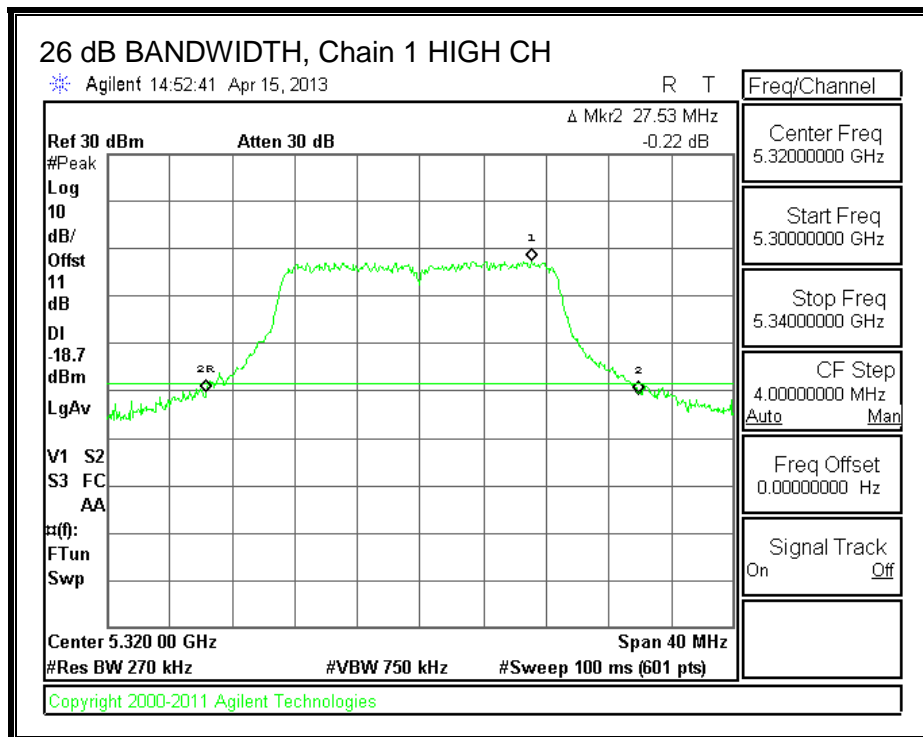
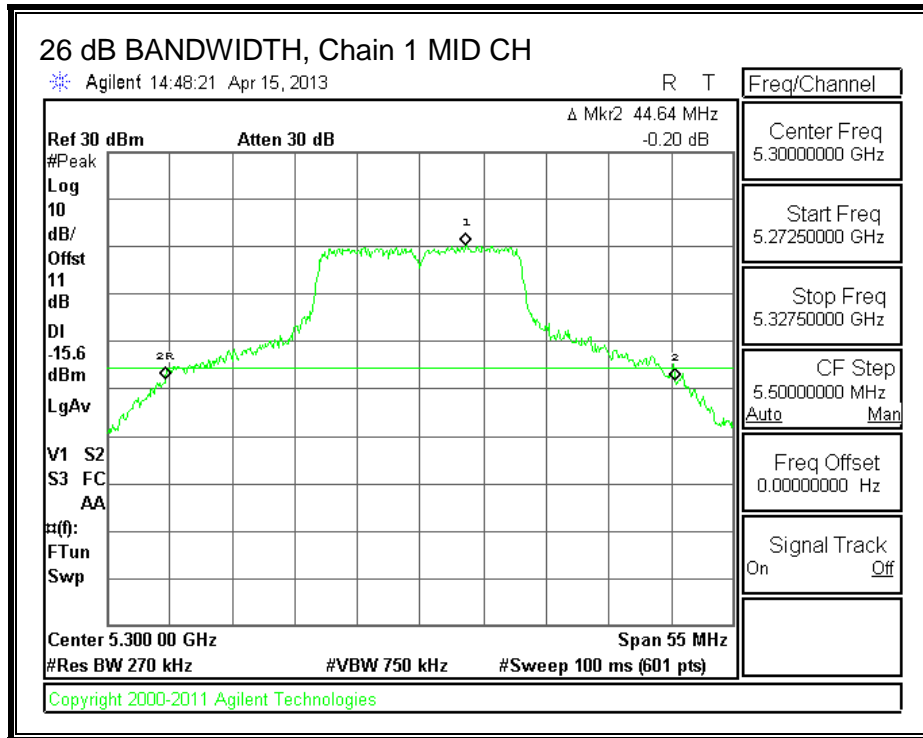

8.2.2. 99% BANDWIDTH

LIMITS

None; for reporting purposes only.

RESULTS

Channel	Frequency (MHz)	99% BW Chain 0 (MHz)	99% BW Chain 1 (MHz)
Low	5260	17.8376	17.8784
Mid	5300	17.7791	17.9207
High	5320	17.8625	17.8734

99% BANDWIDTH, Chain 0

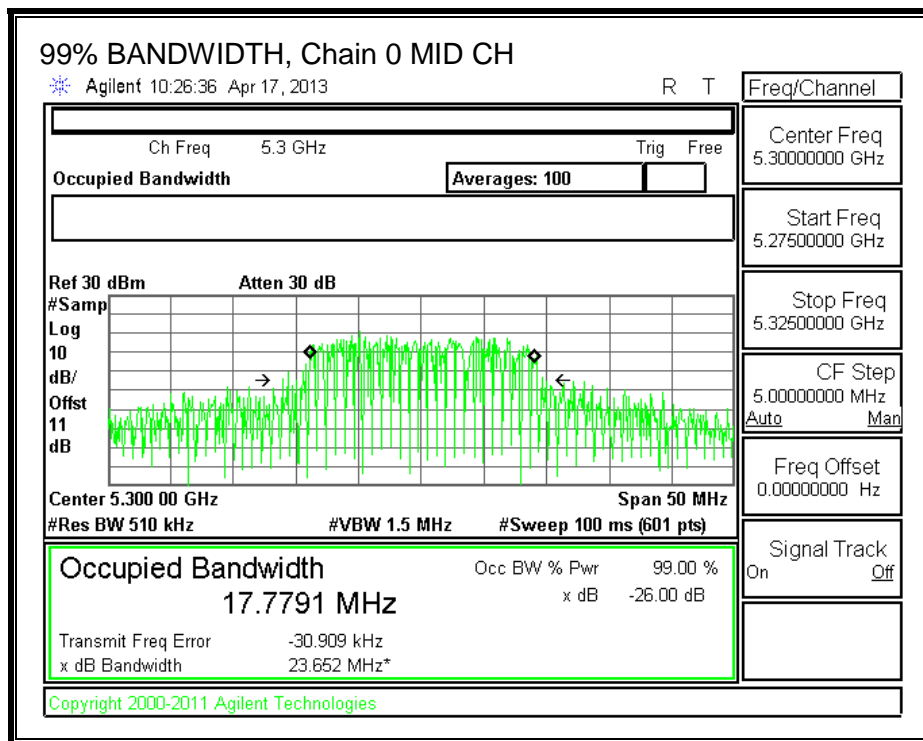
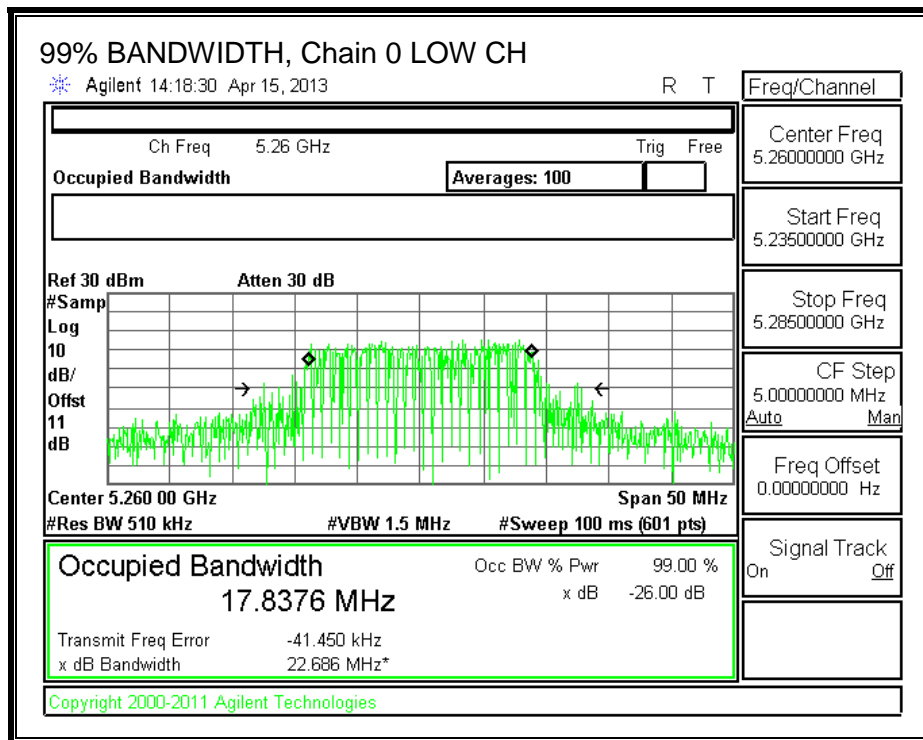

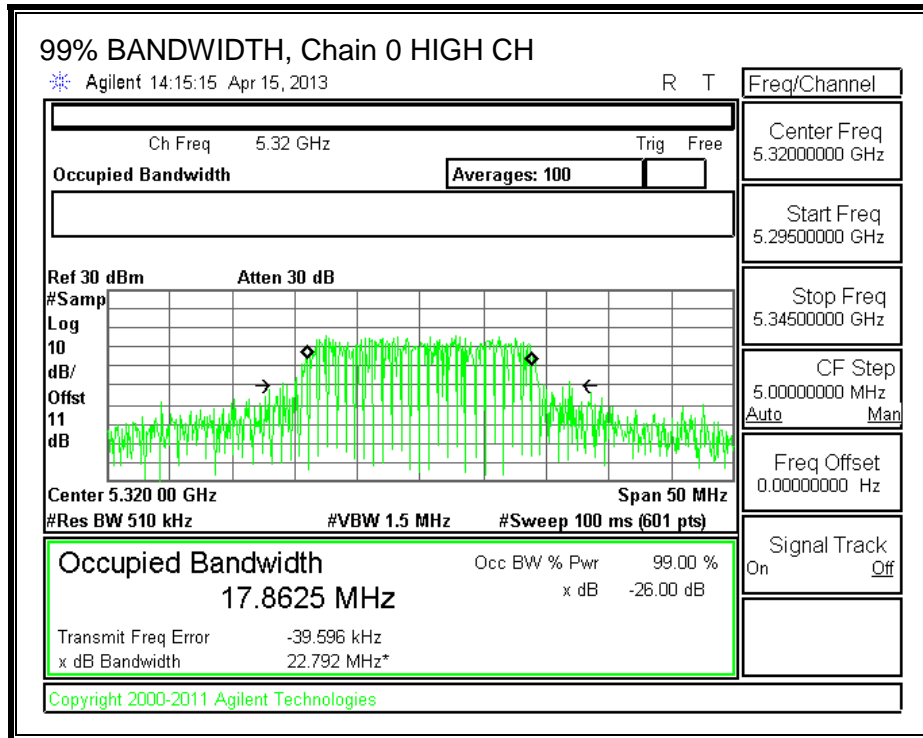

99% BANDWIDTH, Chain 1

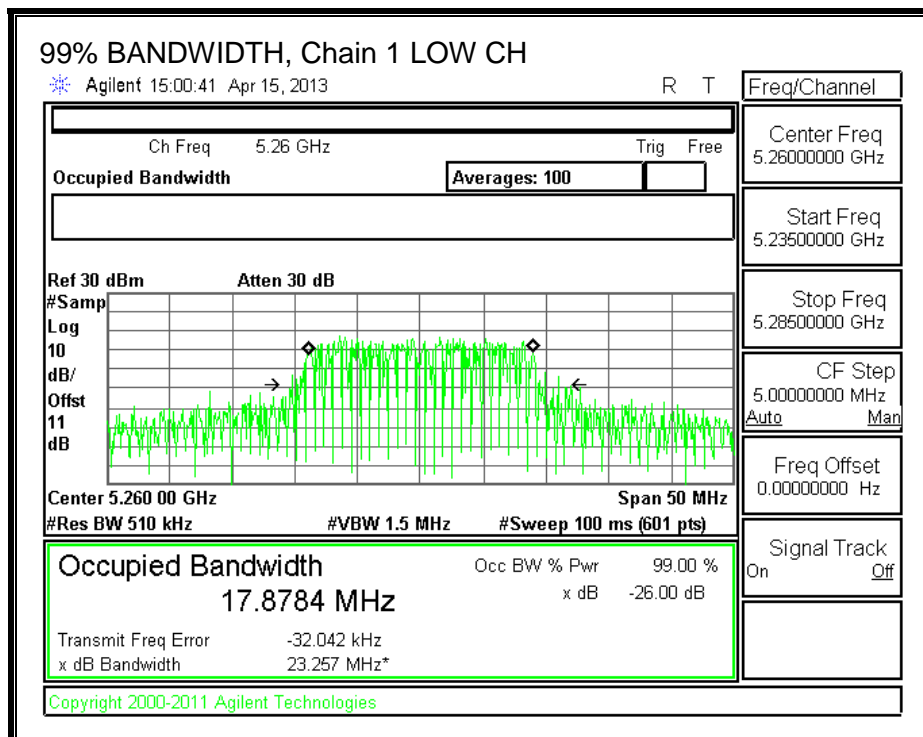

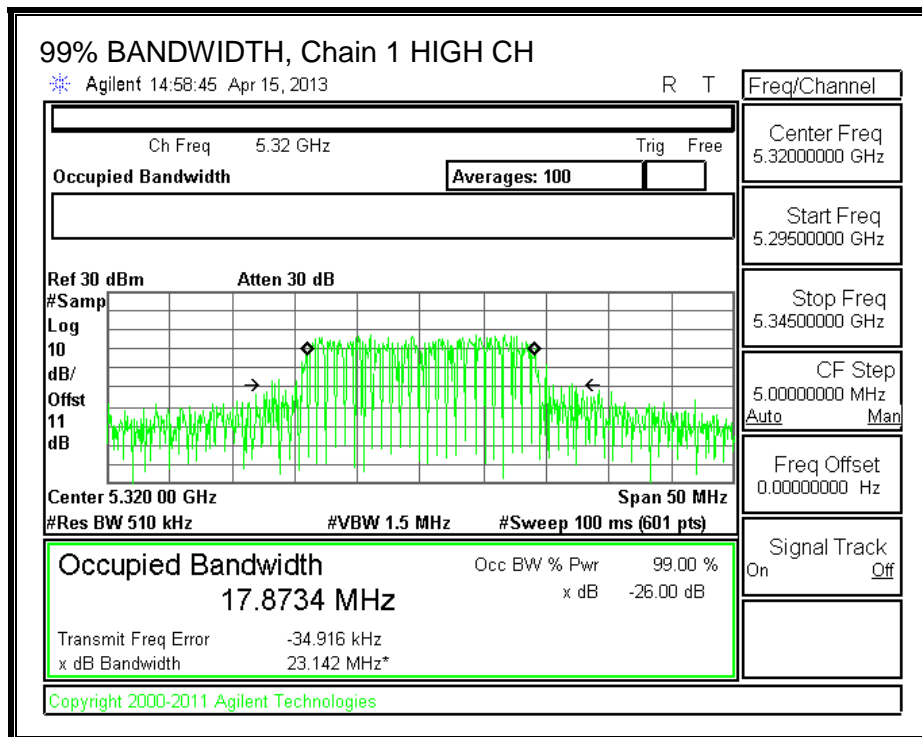
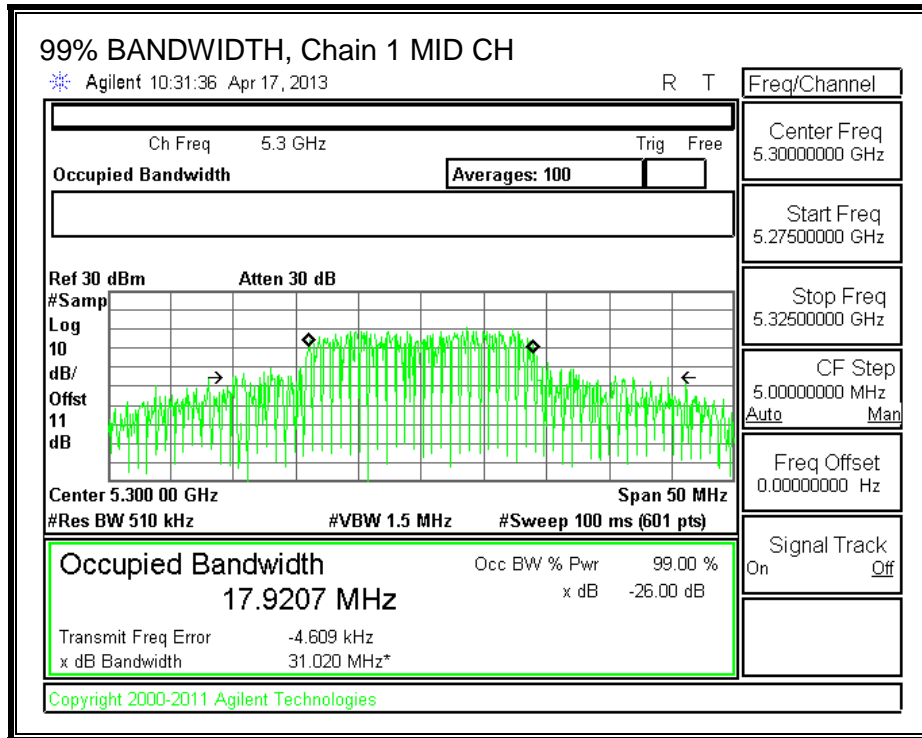

8.2.3. AVERAGE POWER

LIMITS

None; for reporting purposes only.

TEST PROCEDURE

The transmitter output is connected to a power meter.

The cable assembly insertion loss of 11 dB (including 11 dB pad and 1.0 dB cable) was entered as an offset in the power meter to allow for direct reading of power.

RESULTS

Average Power Results

Channel	Frequency (MHz)	Chain 0 Power (dBm)	Chain 1 Power (dBm)	Total Power (dBm)
Low	5260	13.70	15.36	17.62
Mid	5300	17.44	18.32	20.91
High	5320	14.28	15.73	18.08

8.2.4. OUTPUT POWER AND PPSD

LIMITS

FCC §15.407 (a) (1)

For the band 5.25–5.35 GHz, the maximum conducted output power over the frequency band of operation shall not exceed the lesser of 250 mW or $11 \text{ dBm} + 10 \log B$, where B is the 26-dB emission bandwidth in MHz. In addition, the peak power spectral density shall not exceed 11 dBm in any 1-MHz band. If transmitting antennas of directional gain greater than 6 dBi are used, both the maximum conducted output power and the peak power spectral density shall be reduced by the amount in dB that the directional gain of the antenna exceeds 6 dBi.

IC RSS-210 A9.2 (1)

The maximum e.i.r.p. shall not exceed 200 mW or $10 + 10 \log_{10} B$, dBm, whichever power is less. B is the 99% emission bandwidth in MHz. The e.i.r.p. spectral density shall not exceed 10 dBm in any 1.0 MHz band.

DIRECTIONAL ANTENNA GAIN

The TX chains are uncorrelated and the antenna gain is unequal among the chains. The directional gain is:

Chain 0 Antenna Gain (dBi)	Chain 1 Antenna Gain (dBi)	Uncorrelated Chains Directional Gain (dBi)
3.59	3.29	3.44

RESULTS

Bandwidth and Antenna Gain

Channel	Frequency (MHz)	Min 26 dB BW (MHz)	Min 99% BW (MHz)	Directional Gain (dBi)
Low	5260	26.55	17.8376	3.44
Mid	5300	35.02	17.7791	3.44
High	5320	27.00	17.8625	3.44

Limits

Channel	Frequency (MHz)	FCC Power Limit (dBm)	IC Power Limit (dBm)	IC EIRP Limit (dBm)	Power Limit (dBm)	FCC PPSD Limit (dBm)	IC PSD Limit (dBm)	PPSD Limit (dBm)
Low	5260	24.00	23.51	29.51	23.51	11.00	11.00	11.00
Mid	5300	24.00	23.50	29.50	23.50	11.00	11.00	11.00
High	5320	24.00	23.52	29.52	23.52	11.00	11.00	11.00

Duty Cycle CF (dB)	0.53	Included in Calculations of Corr'd Power & PSD
---------------------------	------	---

Output Power Results

Channel	Frequency (MHz)	Chain 0 Meas Power (dBm)	Chain 1 Meas Power (dBm)	Total Corr'd Power (dBm)	Power Limit (dBm)	Power Margin (dB)
Low	5260	14.604	16.332	19.094	23.51	-4.420
Mid	5300	17.890	18.130	21.552	23.50	-1.947
High	5320	14.737	16.227	19.086	23.52	-4.434

PPSD Results

Channel	Frequency (MHz)	Chain 0 Meas PPSD (dBm)	Chain 1 Meas PPSD (dBm)	Total Corr'd PPSD (dBm)	PPSD Limit (dBm)	PPSD Margin (dB)
Low	5260	3.17	4.89	7.66	11.00	-3.34
Mid	5300	6.45	6.75	10.14	11.00	-0.86
High	5320	3.40	4.64	7.60	11.00	-3.40

OUTPUT POWER AND PPSD, Chain 0

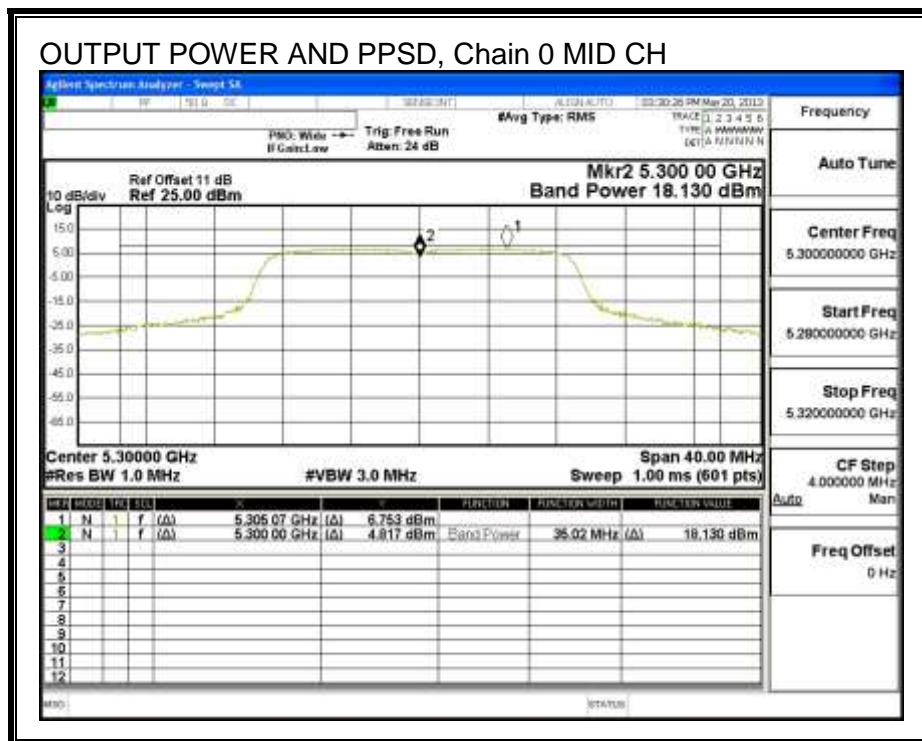
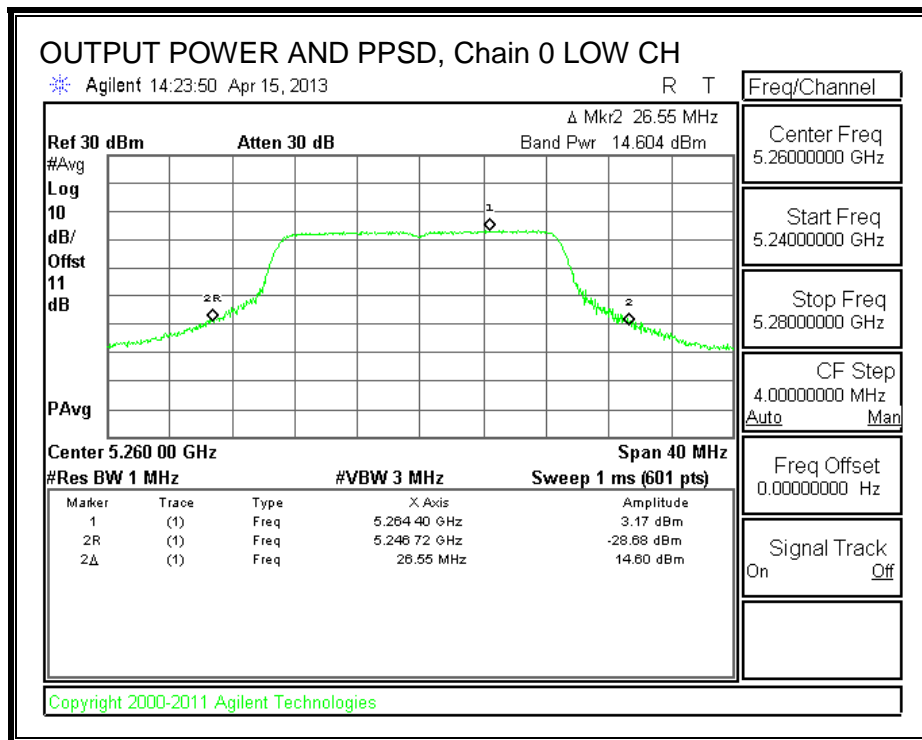

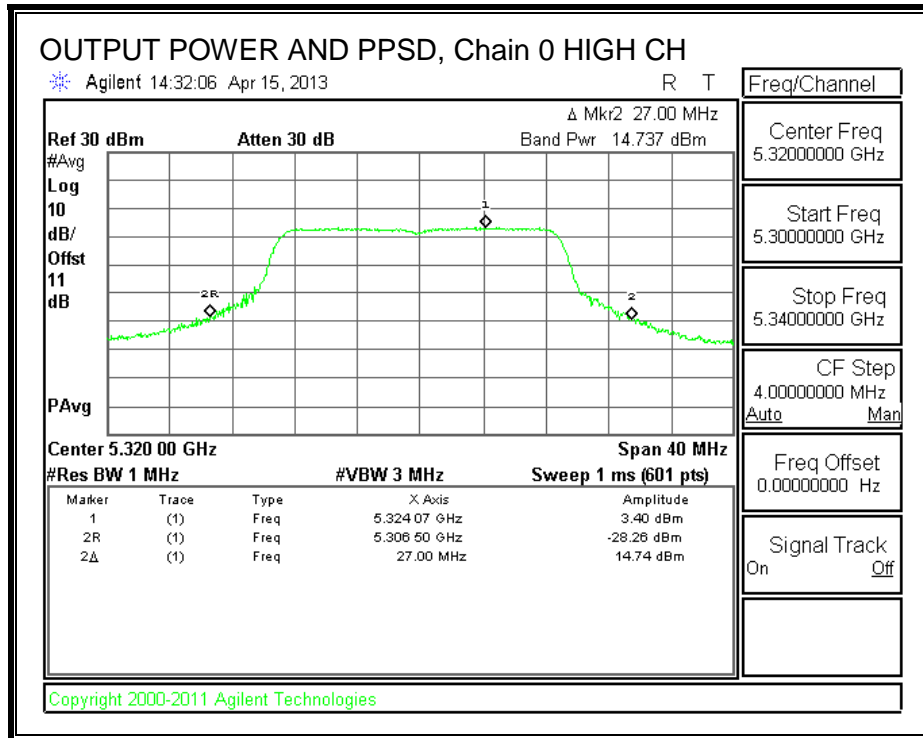

OUTPUT POWER AND PPSD, Chain 1

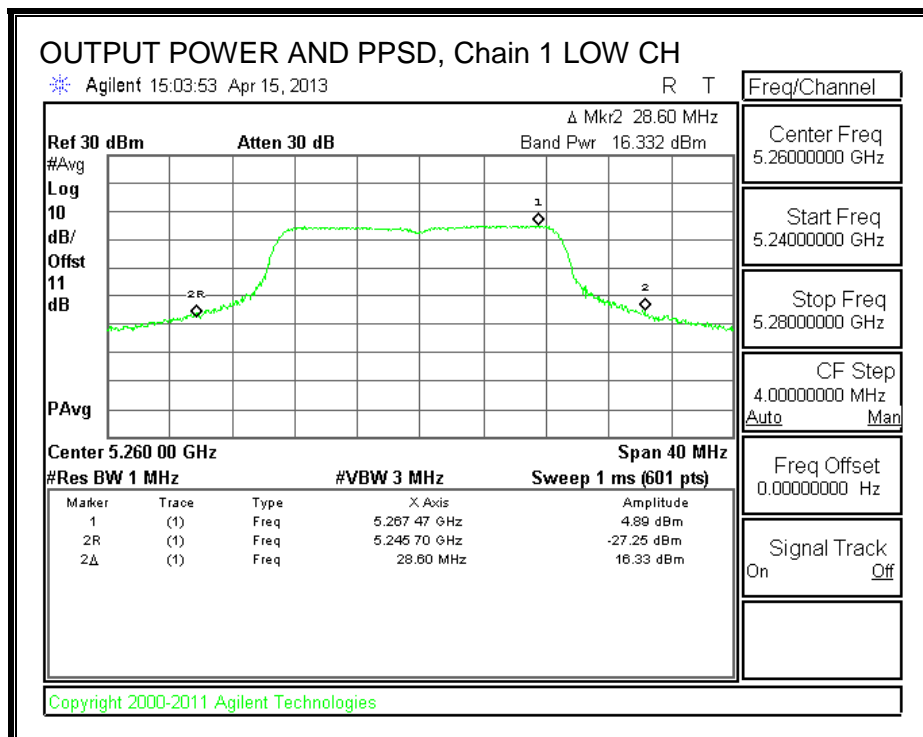

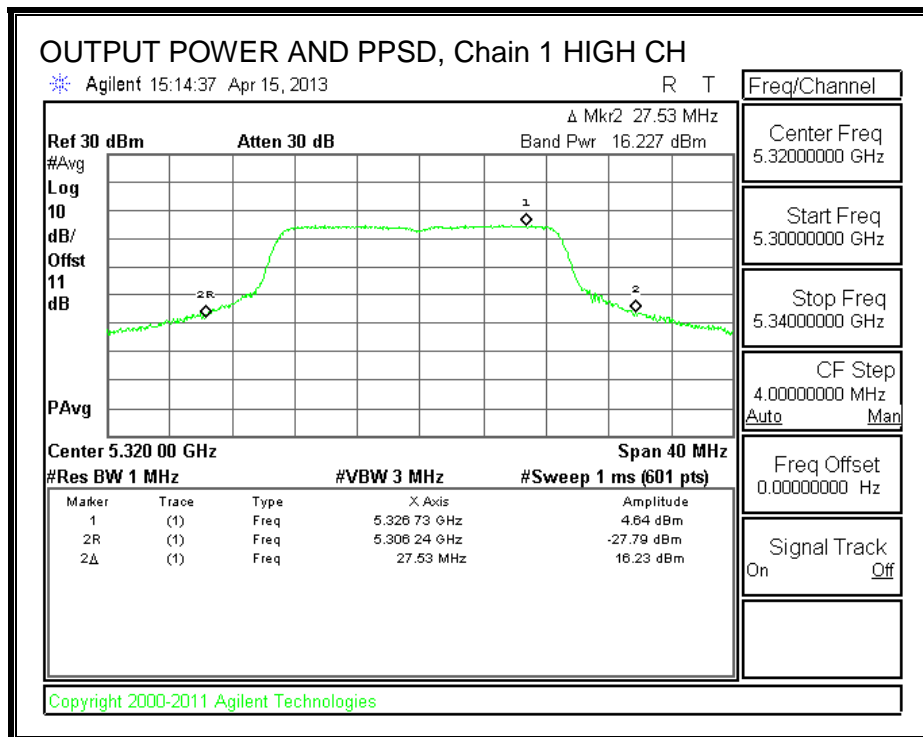
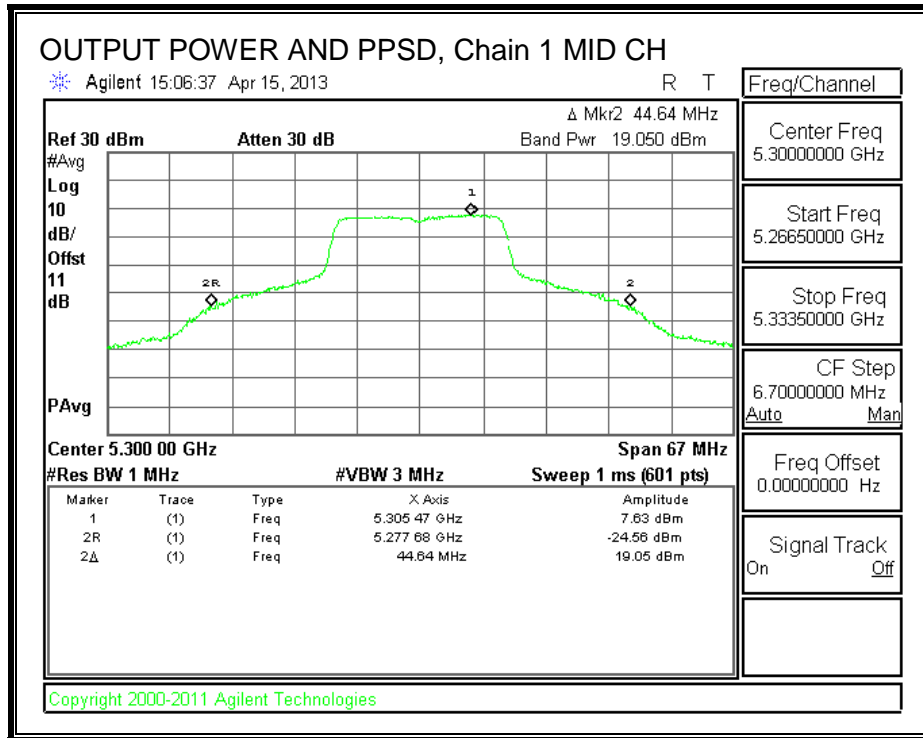

8.2.5. PEAK EXCURSION

LIMITS

FCC §15.407 (a) (6)

The ratio of the peak excursion of the modulation envelope (measured using a peak hold function) to the peak transmit power (measured as specified above) shall not exceed 13 dB across any 1 MHz bandwidth or the emission bandwidth whichever is less.

RESULTS

Refer to the results of 802.11n HT20 mode in the 5.2 GHz band.

8.3. 802.11n HT20 MODE IN THE 5.6 GHz BAND

8.3.1. 26 dB BANDWIDTH

LIMITS

None; for reporting purposes only.

RESULTS

Channel	Frequency (MHz)	26 dB BW Chain 0 (MHz)	26 dB BW Chain 1 (MHz)
Low	5500	24.47	28.14
Mid	5580	26.53	47.37
High	5700	26.13	28.14

26 dB BANDWIDTH, Chain 0

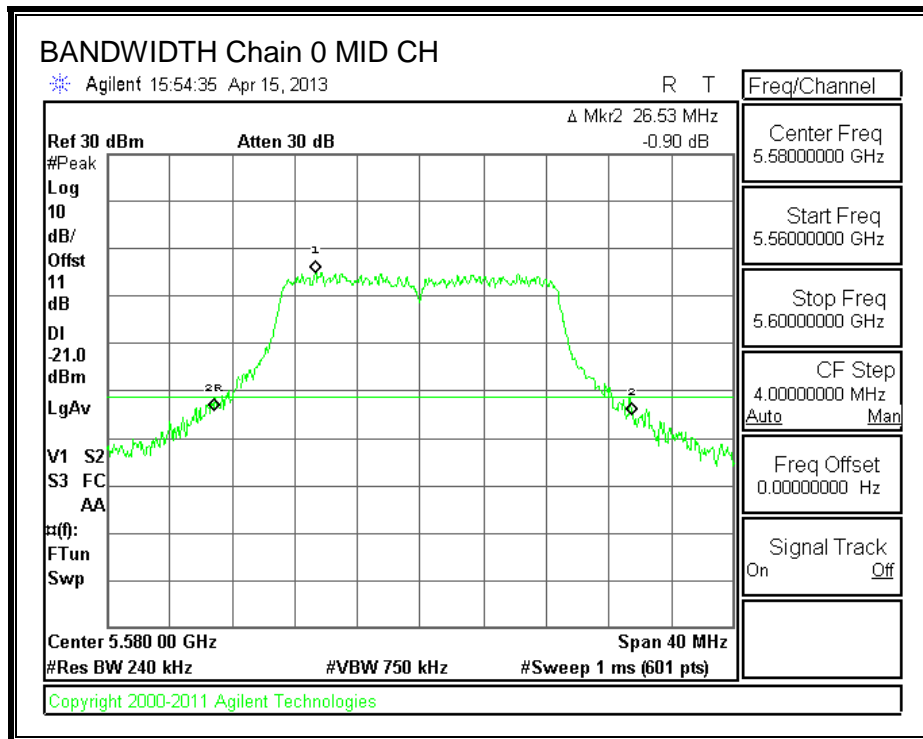
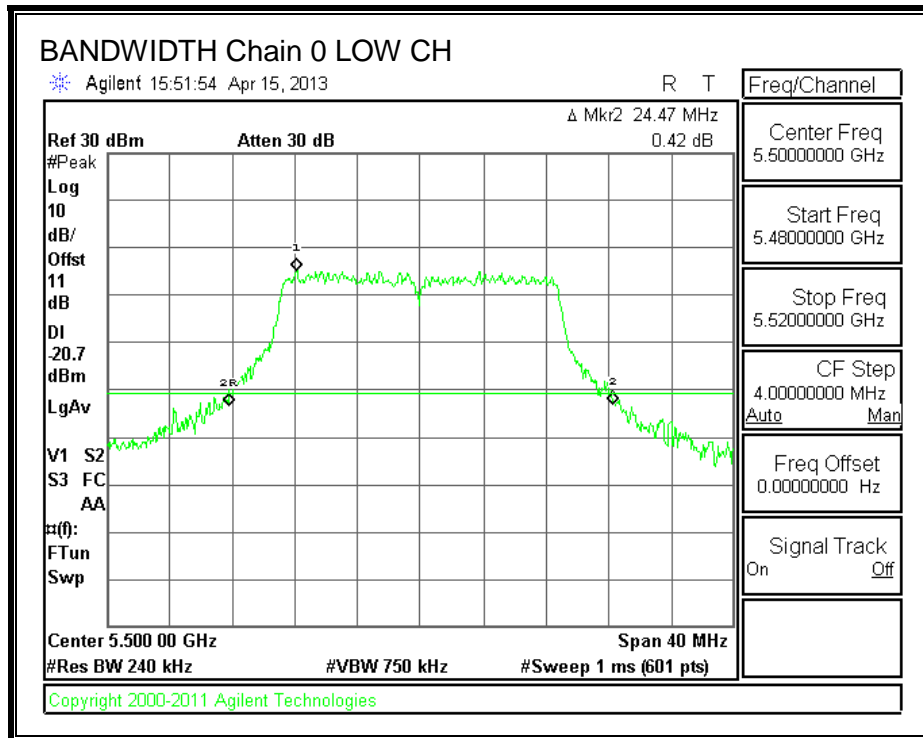

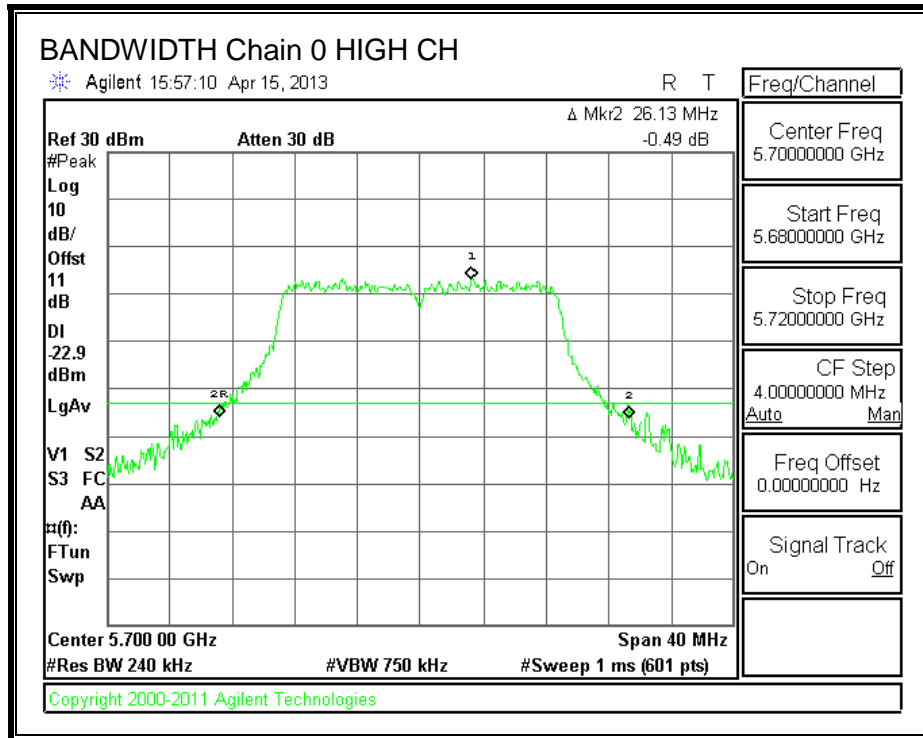

26 dB BANDWIDTH, Chain 1

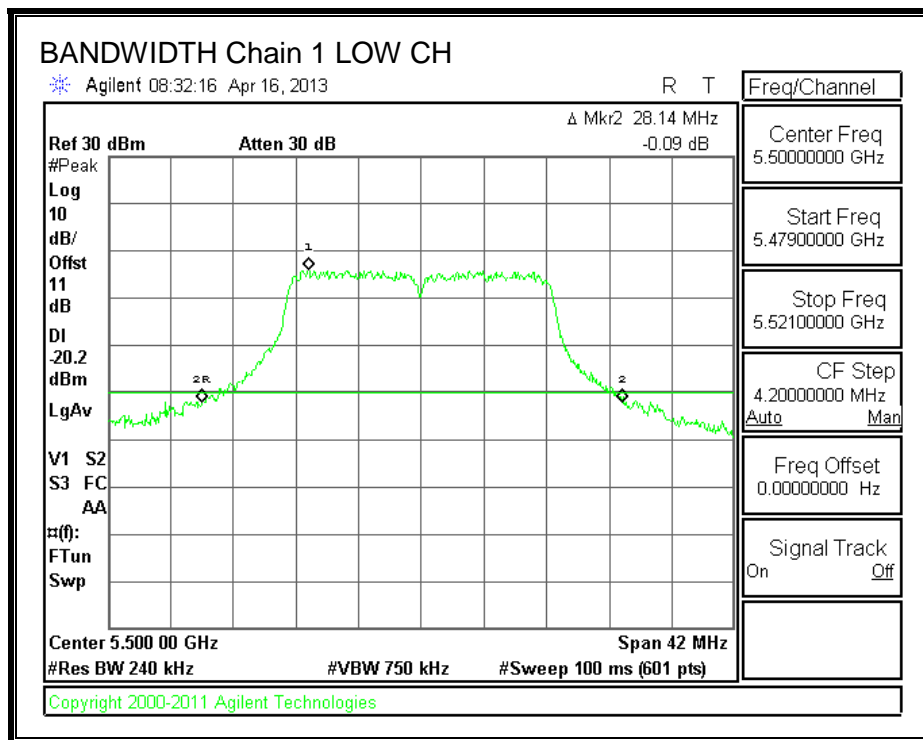

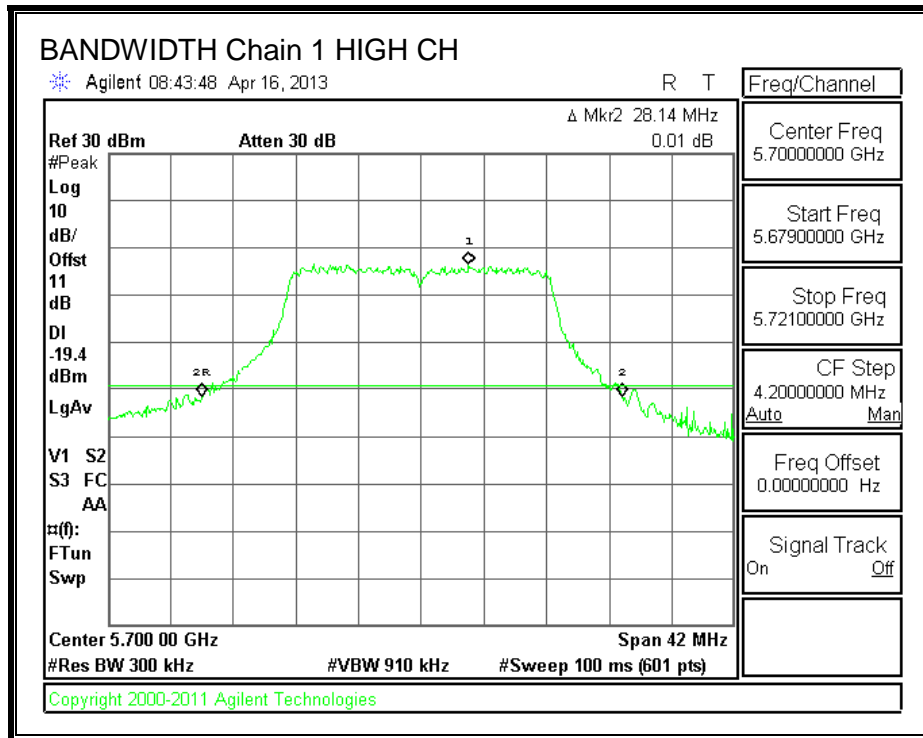
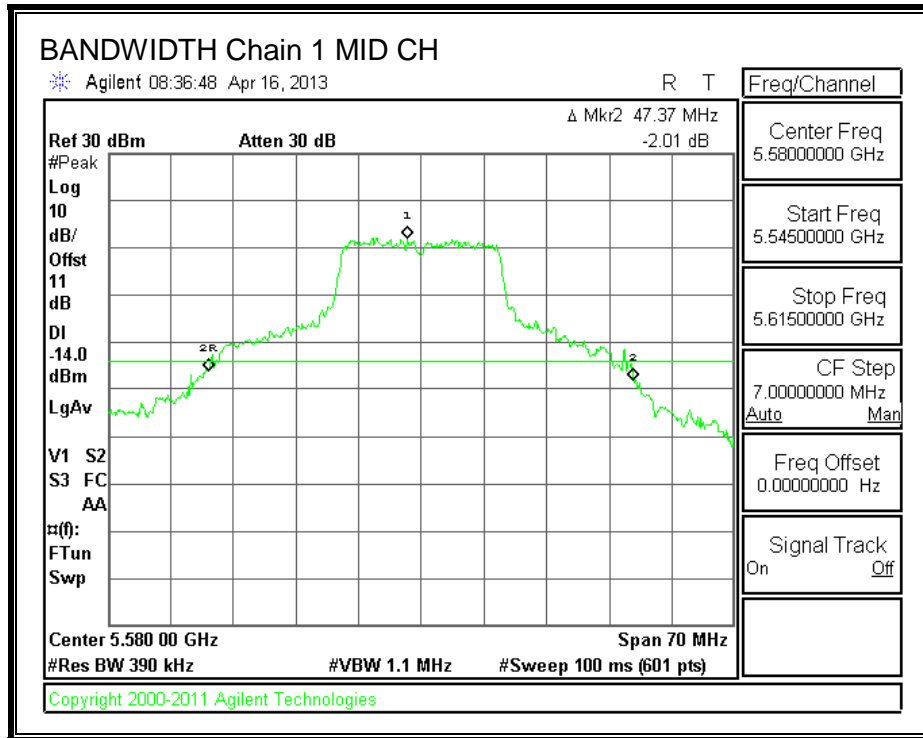

8.3.2. 99% BANDWIDTH

LIMITS

None; for reporting purposes only.

RESULTS

Channel	Frequency (MHz)	99% BW	
		Chain 0 (MHz)	Chain 1 (MHz)
Low	5500	17.8693	17.8715
Mid	5580	17.8766	18.4901
High	5700	17.8608	17.8890

99% BANDWIDTH, Chain 0

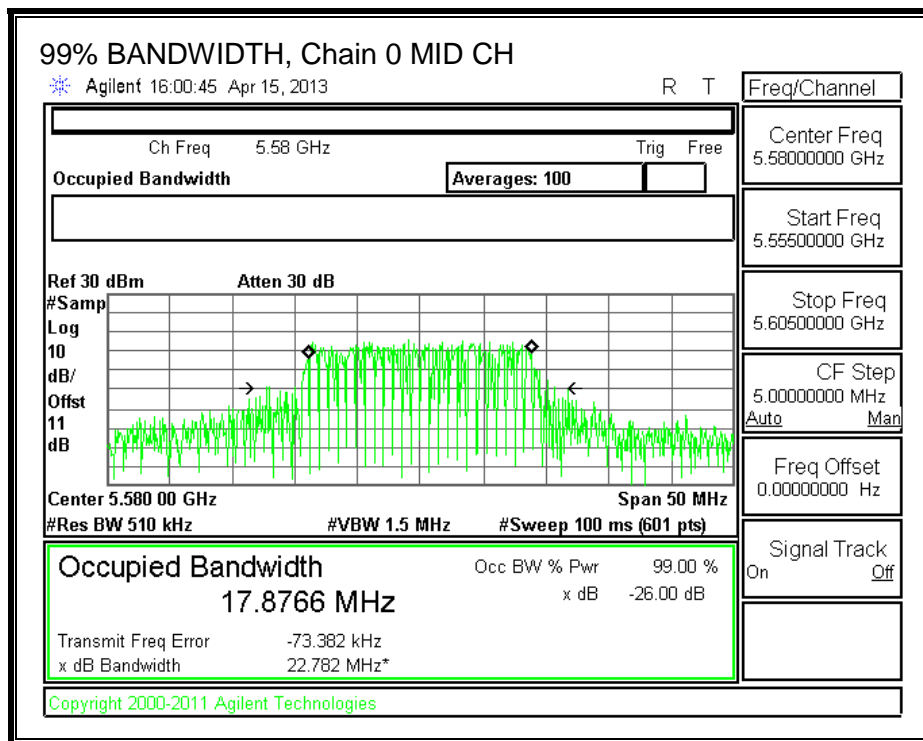
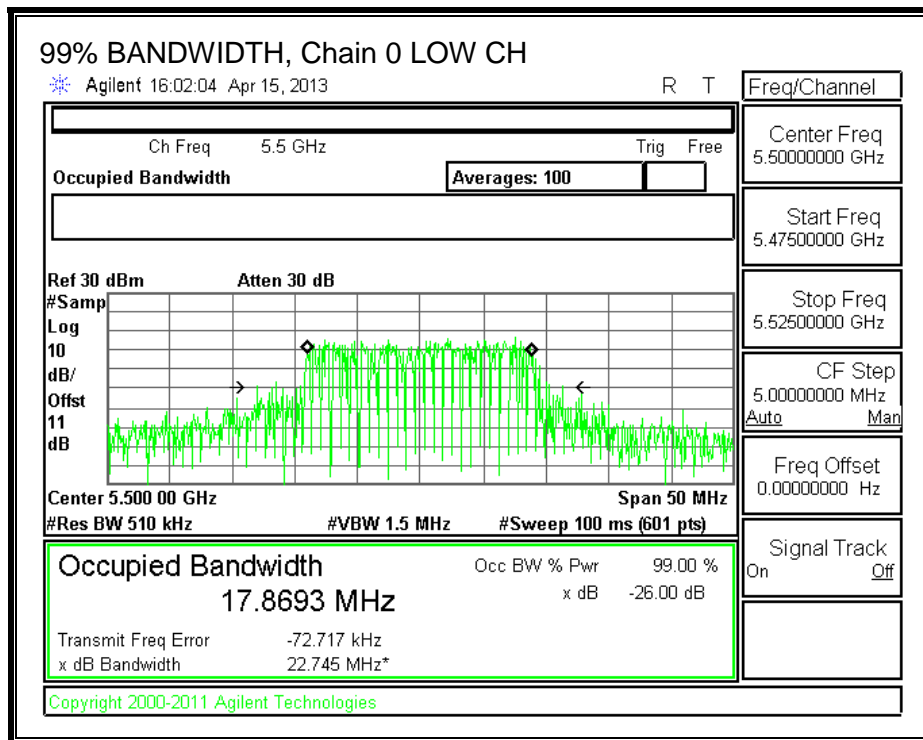

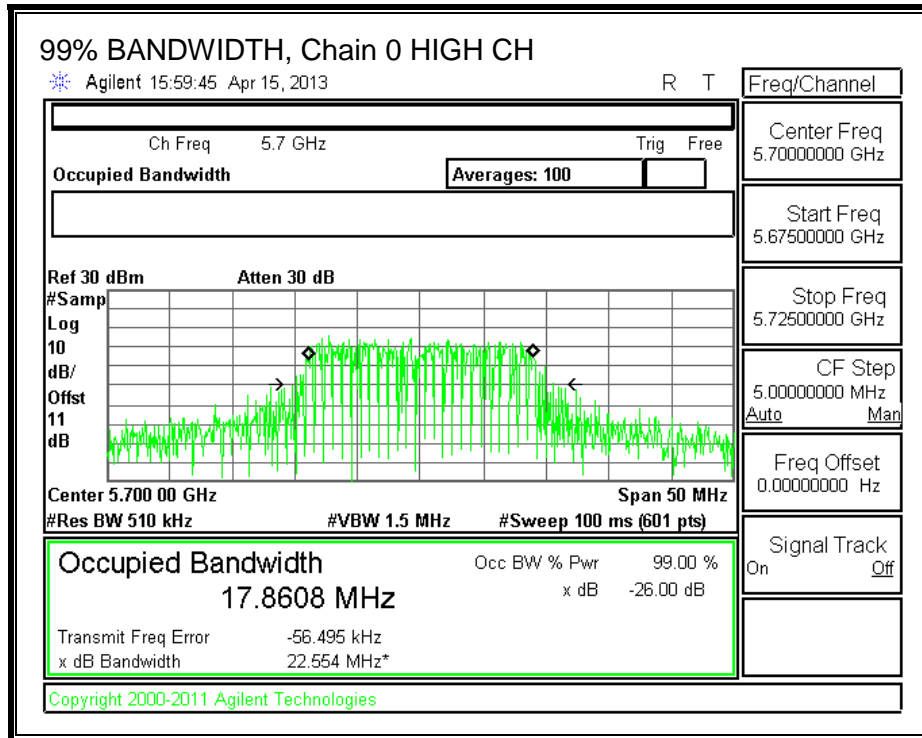

99% BANDWIDTH, Chain 1

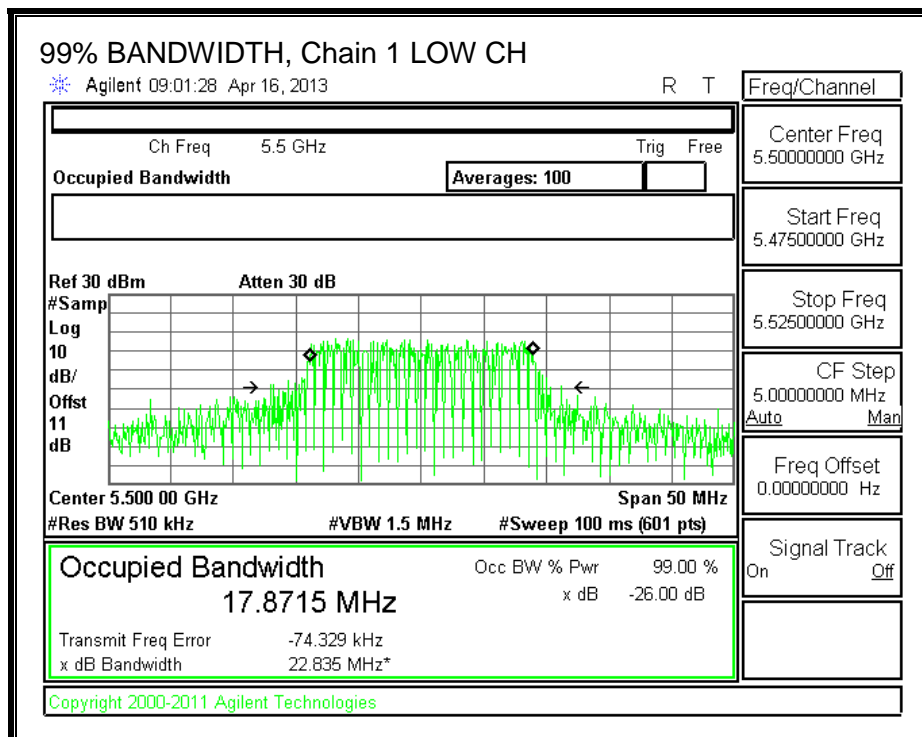

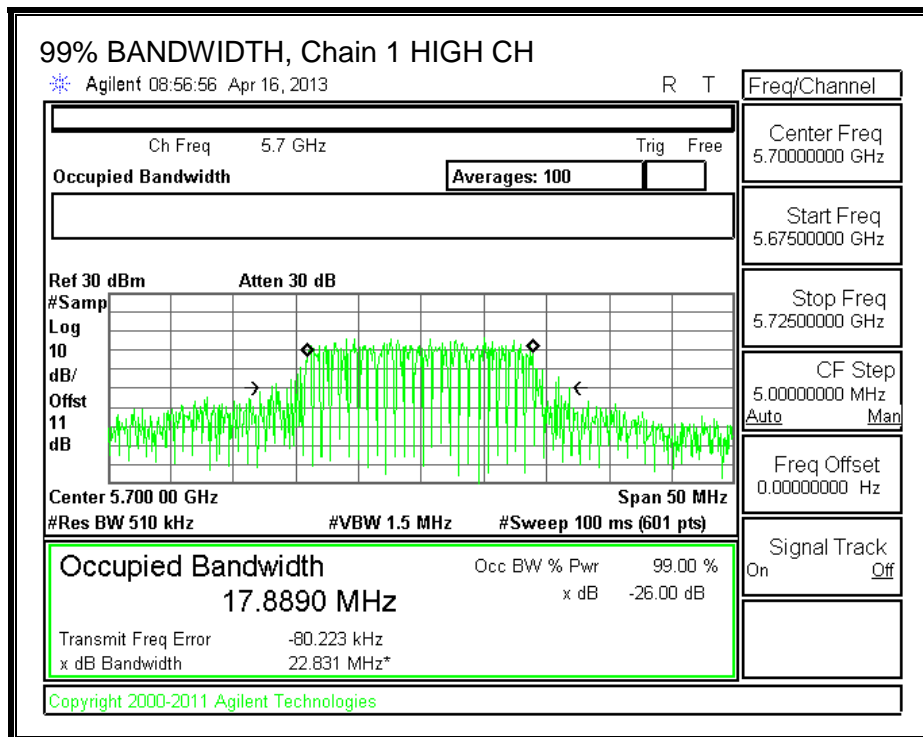
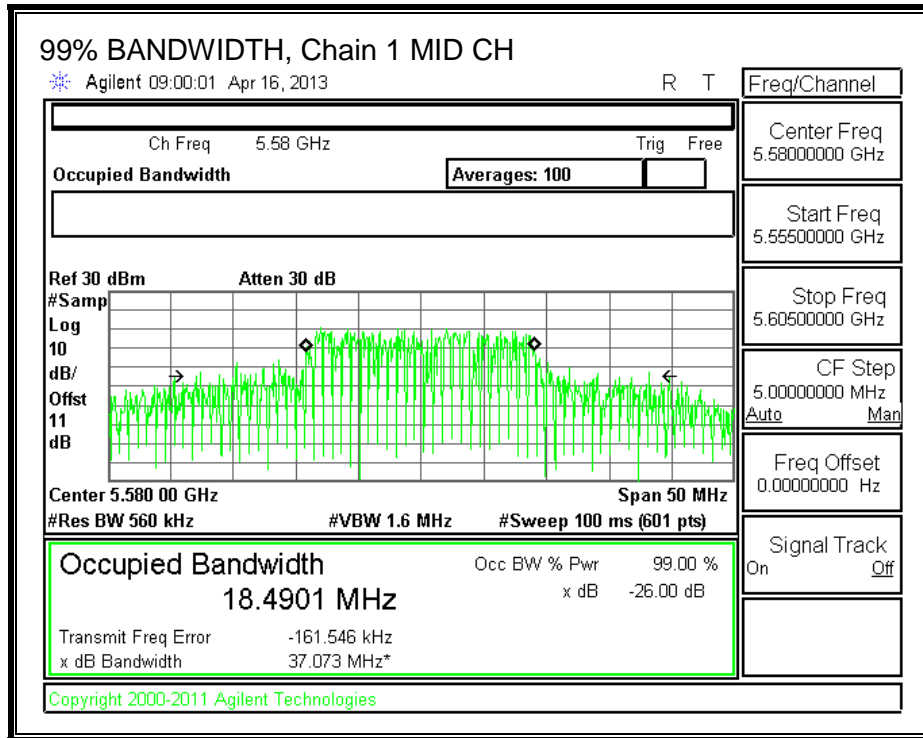

8.3.3. AVERAGE POWER

LIMITS

None; for reporting purposes only.

TEST PROCEDURE

The transmitter output is connected to a power meter.

The cable assembly insertion loss of 11 dB (including 10 dB pad and 1.0 dB cable) was entered as an offset in the power meter to allow for direct reading of power.

RESULTS

Average Power Results

Channel	Frequency (MHz)	Chain 0 Power (dBm)	Chain 1 Power (dBm)	Total Power (dBm)
Low	5500	13.63	15.02	17.39
Mid	5580	18.61	18.54	21.59
High	5700	11.94	14.45	16.38

8.3.4. OUTPUT POWER AND PPSD

LIMITS

FCC §15.407 (a) (1)

For the band 5.5–5.7 GHz, the maximum conducted output power over the frequency band of operation shall not exceed the lesser of 250 mW or 11 dBm + 10 log B, where B is the 26–dB emission bandwidth in MHz. In addition, the peak power spectral density shall not exceed 11 dBm in any 1–MHz band. If transmitting antennas of directional gain greater than 6 dBi are used, both the maximum conducted output power and the peak power spectral density shall be reduced by the amount in dB that the directional gain of the antenna exceeds 6 dBi.

IC RSS-210 A9.2 (1)

The maximum e.i.r.p. shall not exceed 200 mW or 10 + 10 log₁₀ B, dBm, whichever power is less. B is the 99% emission bandwidth in MHz. The e.i.r.p. spectral density shall not exceed 10 dBm in any 1.0 MHz band.

DIRECTIONAL ANTENNA GAIN

The TX chains are uncorrelated and the antenna gain is unequal among the chains. The directional gain is:

Chain 0 Antenna Gain (dBi)	Chain 1 Antenna Gain (dBi)	Uncorrelated Chains Directional Gain (dBi)
3.59	3.29	3.44

RESULTS

Bandwidth and Antenna Gain

Channel	Frequency (MHz)	Min 26 dB BW (MHz)	Min 99% BW (MHz)	Directional Gain (dBi)
Low	5500	24.47	17.8693	3.44
Mid	5580	26.53	17.8766	3.44
High	5700	26.13	17.8608	3.44

Limits

Channel	Frequency (MHz)	FCC Power Limit (dBm)	IC Power Limit (dBm)	IC EIRP Limit (dBm)	Power Limit (dBm)	FCC PPSD Limit (dBm)	IC PSD Limit (dBm)	PPSD Limit (dBm)
Low	5500	24.00	23.52	29.52	23.52	11.00	11.00	11.00
Mid	5580	24.00	23.52	29.52	23.52	11.00	11.00	11.00
High	5700	24.00	23.52	29.52	23.52	11.00	11.00	11.00

Duty Cycle CF (dB)	0.53	Included in Calculations of Corr'd Power & PSD
---------------------------	------	---

Output Power Results

Channel	Frequency (MHz)	Chain 0 Meas Power (dBm)	Chain 1 Meas Power (dBm)	Total Corr'd Power (dBm)	Power Limit (dBm)	Power Margin (dB)
Low	5500	14.217	15.272	18.317	23.52	-5.204
Mid	5580	17.131	18.598	21.466	23.52	-2.056
High	5700	12.284	14.370	16.991	23.52	-6.528

PPSD Results

Channel	Frequency (MHz)	Chain 0 Meas PPSD (dBm)	Chain 1 Meas PPSD (dBm)	Total Corr'd PPSD (dBm)	PPSD Limit (dBm)	PPSD Margin (dB)
Low	5500	2.74	3.93	6.92	11.00	-4.08
Mid	5580	5.75	7.29	10.13	11.00	-0.87
High	5700	0.65	2.72	5.34	11.00	-5.66

OUTPUT POWER AND PPSD, Chain 0

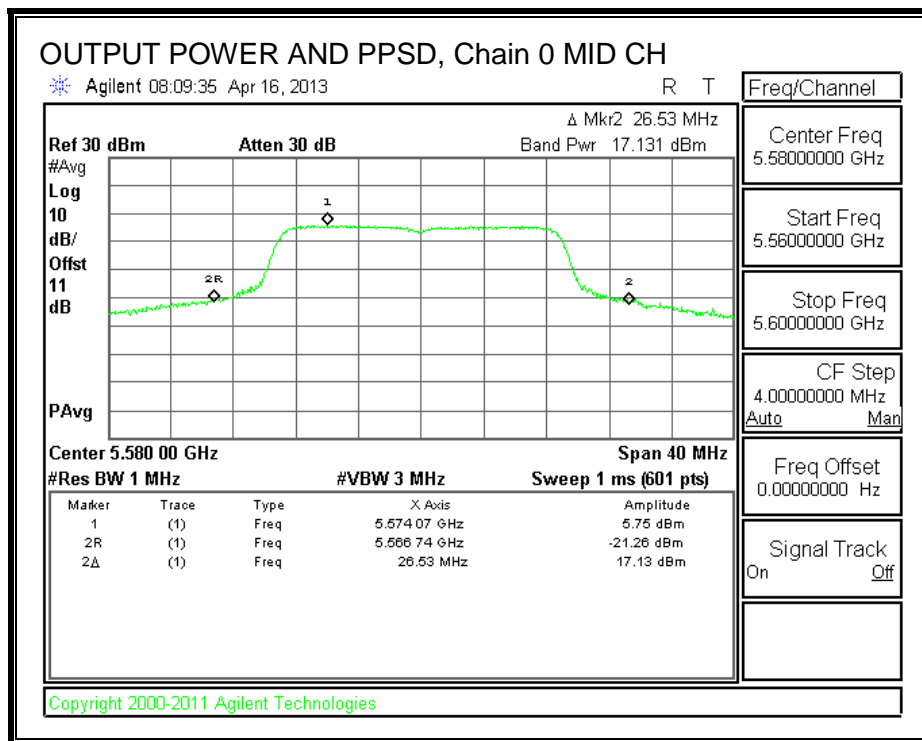
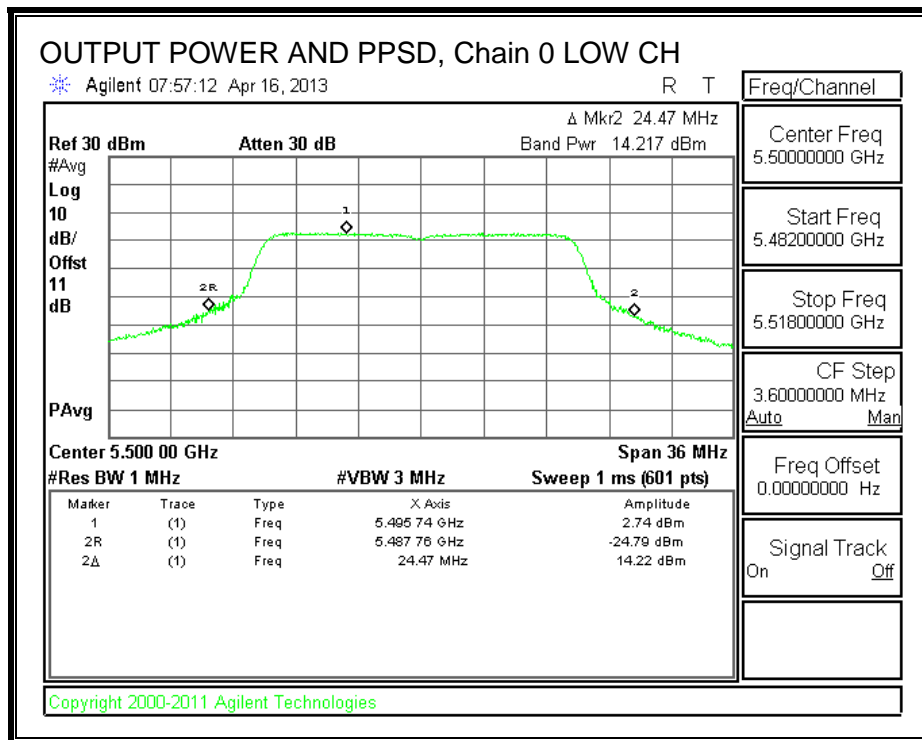

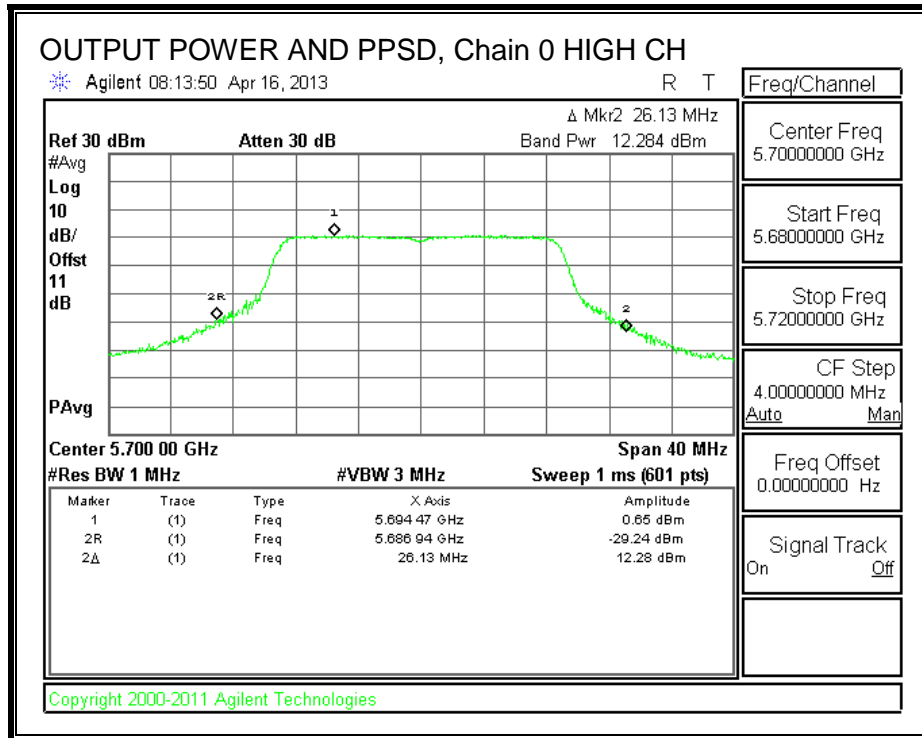

OUTPUT POWER AND PPSD, Chain 1

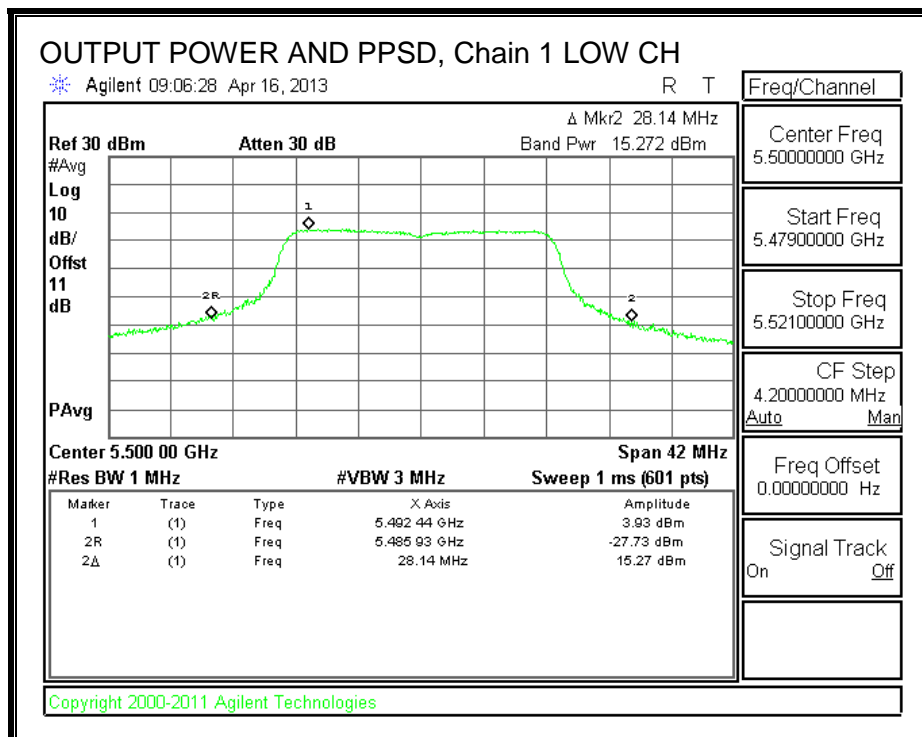

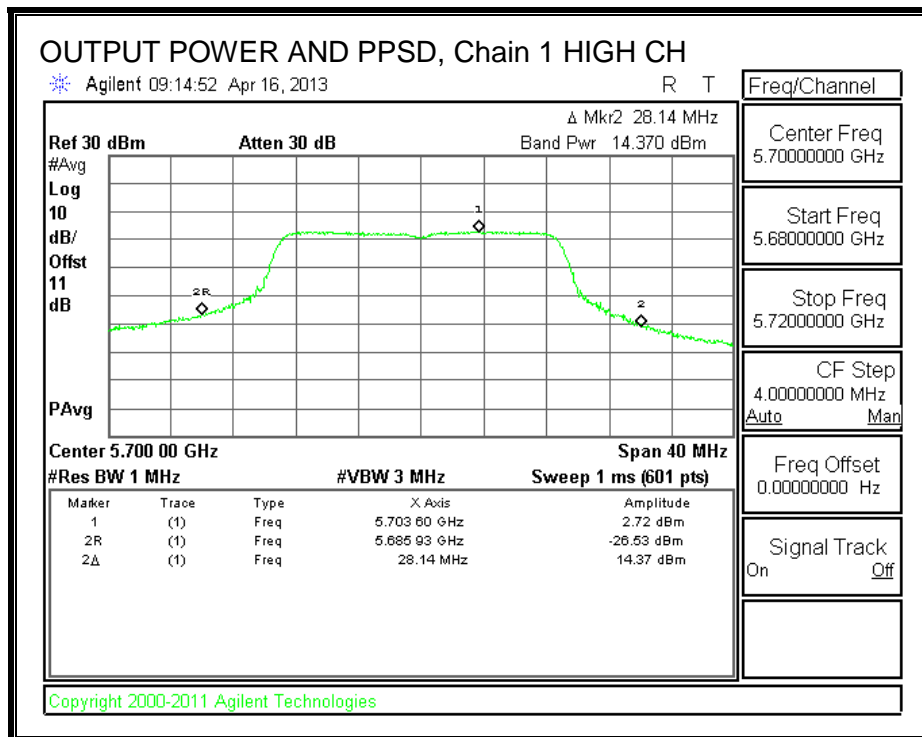
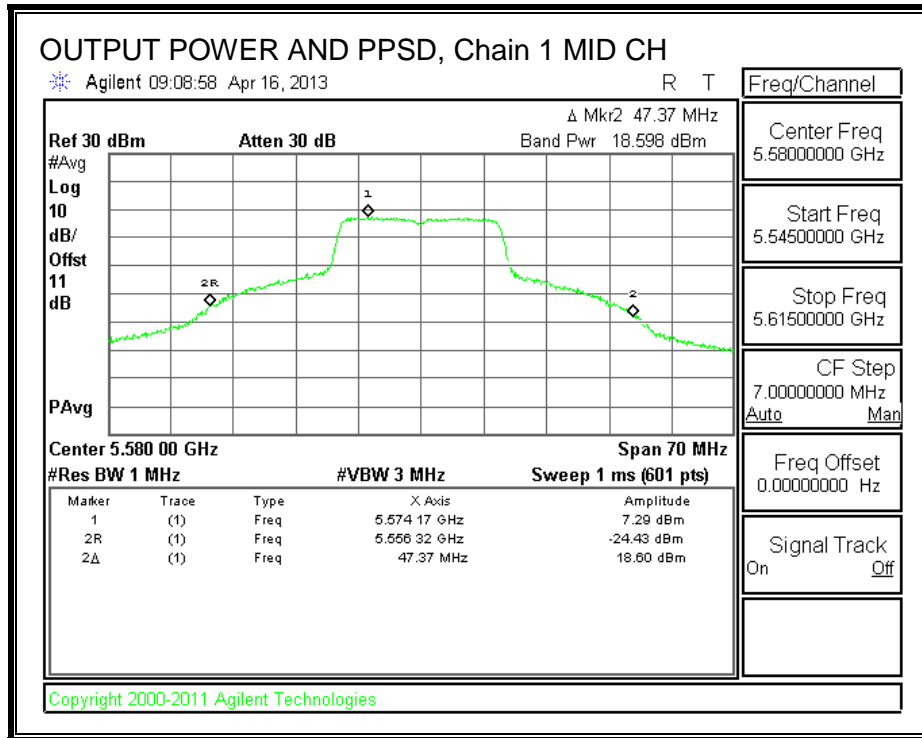

8.3.5. PEAK EXCURSION

LIMITS

FCC §15.407 (a) (6)

The ratio of the peak excursion of the modulation envelope (measured using a peak hold function) to the peak transmit power (measured as specified above) shall not exceed 13 dB across any 1 MHz bandwidth or the emission bandwidth whichever is less.

RESULTS

Refer to the results of 802.11n HT20 mode in the 5.2 GHz band.

9. RADIATED TEST RESULTS

9.1. LIMITS AND PROCEDURE

LIMITS

FCC §15.205 and §15.209

IC RSS-210 Clause 2.6 (Transmitter)

IC RSS-GEN Clause 6 (Receiver)

Frequency Range (MHz)	Field Strength Limit (uV/m) at 3 m	Field Strength Limit (dBuV/m) at 3 m
30 - 88	100	40
88 - 216	150	43.5
216 - 960	200	46
Above 960	500	54

TEST PROCEDURE

The EUT is placed on a non-conducting table 80 cm above the ground plane. The antenna to EUT distance is 3 meters.

For measurements below 1 GHz the resolution bandwidth is set to 100 kHz for peak detection measurements or 120 kHz for quasi-peak detection measurements. Peak detection is used unless otherwise noted as quasi-peak.

For measurements above 1 GHz the resolution bandwidth is set to 1 MHz; the video bandwidth is set to 1 MHz for peak measurements and as applicable for average measurements.

The spectrum from 30 MHz to 40 GHz is investigated with the transmitter set to the lowest, middle, and highest channels in each applicable band.

The frequency range of interest is monitored at a fixed antenna height and EUT azimuth. The EUT is rotated through 360 degrees to maximize emissions received. The antenna is scanned from 1 to 4 meters above the ground plane to further maximize the emission. Measurements are made with the antenna polarized in both the vertical and the horizontal positions.

9.2. TRANSMITTER ABOVE 1 GHz

9.2.1. TX ABOVE 1 GHz 802.11n HT20 MODE IN THE 5.2 GHz BAND

RESTRICTED BANDEDGE (LOW CHANNEL)

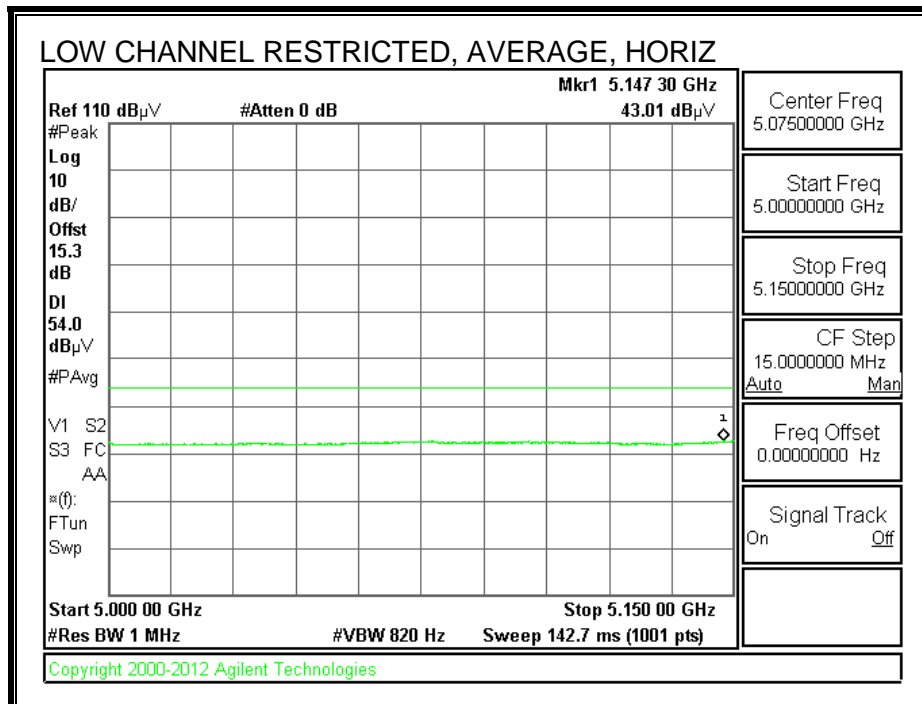
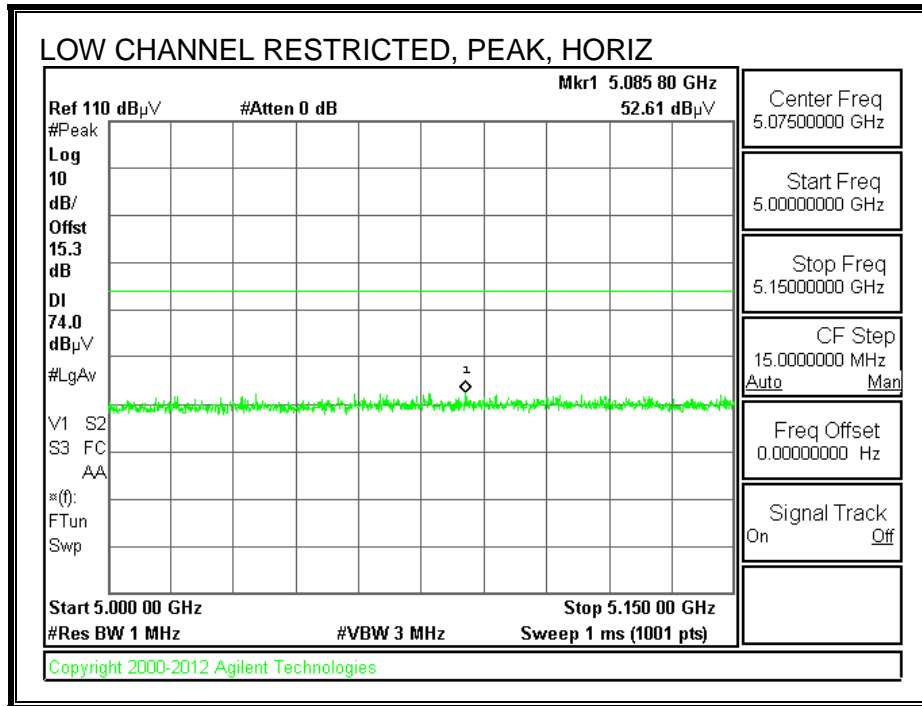

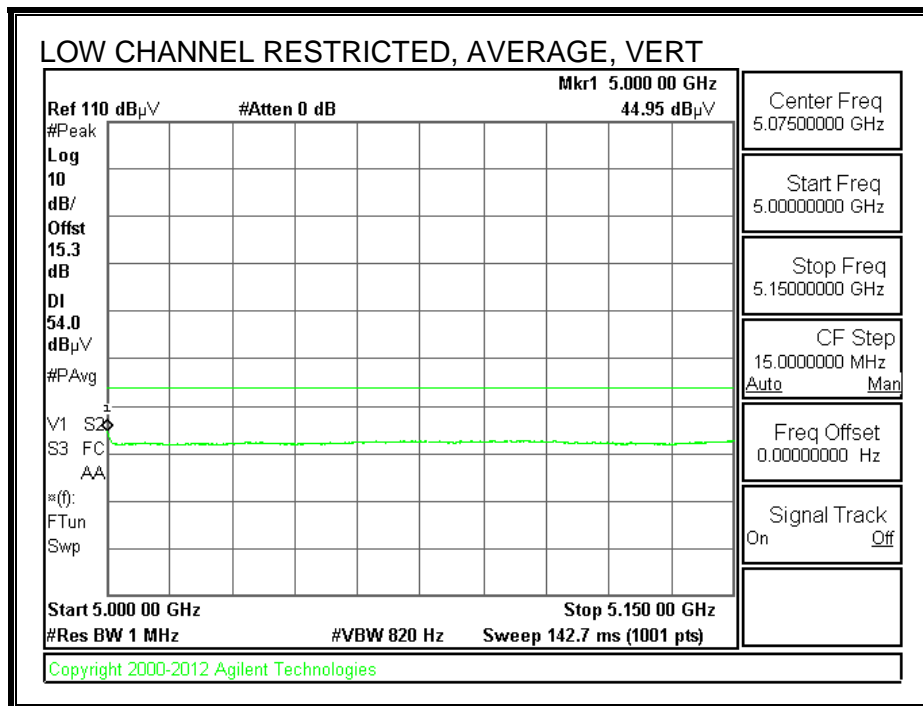
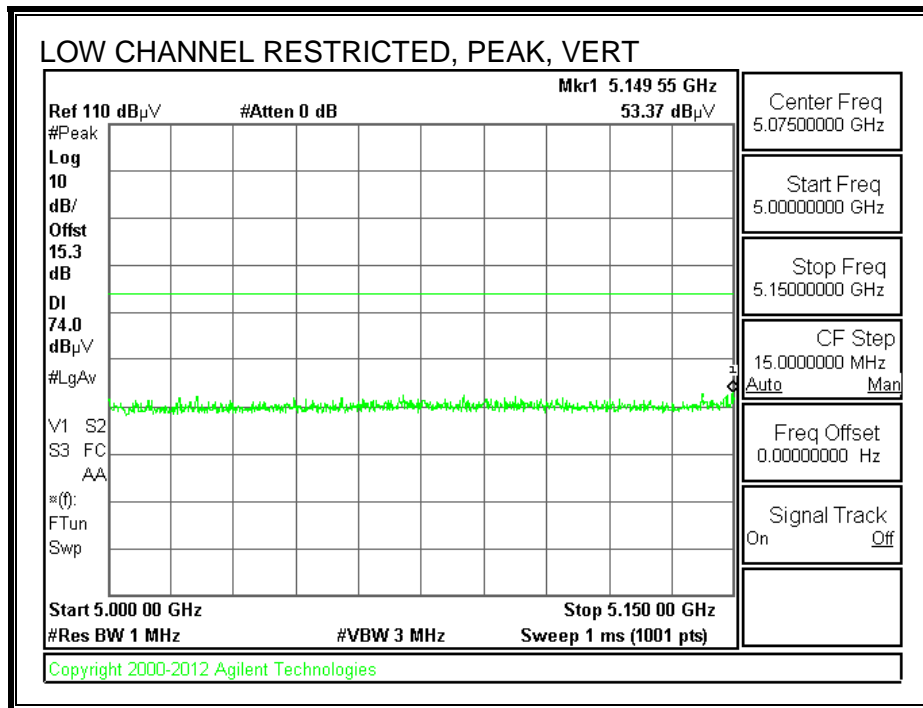

HARMONICS AND SPURIOUS EMISSIONS

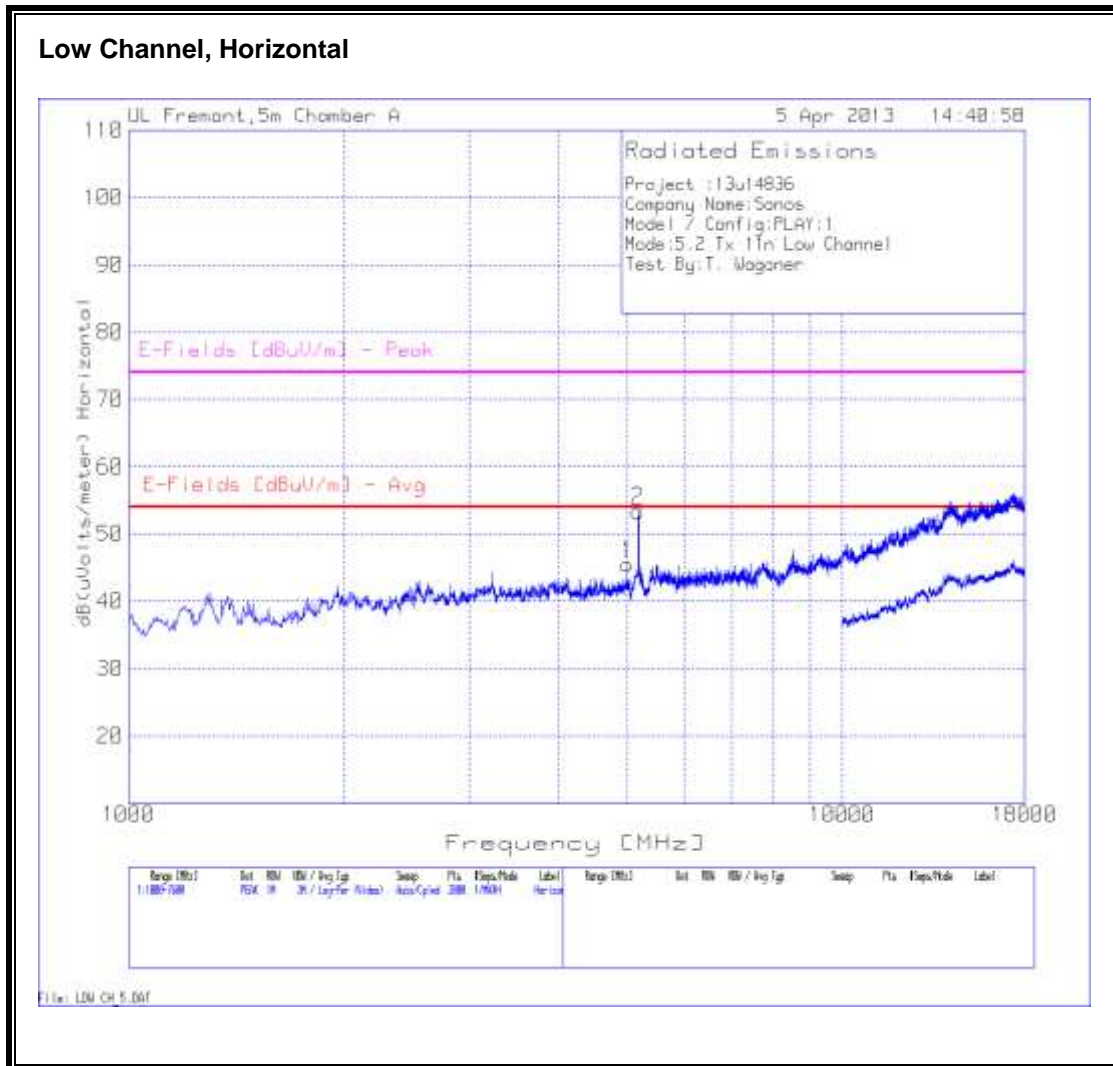

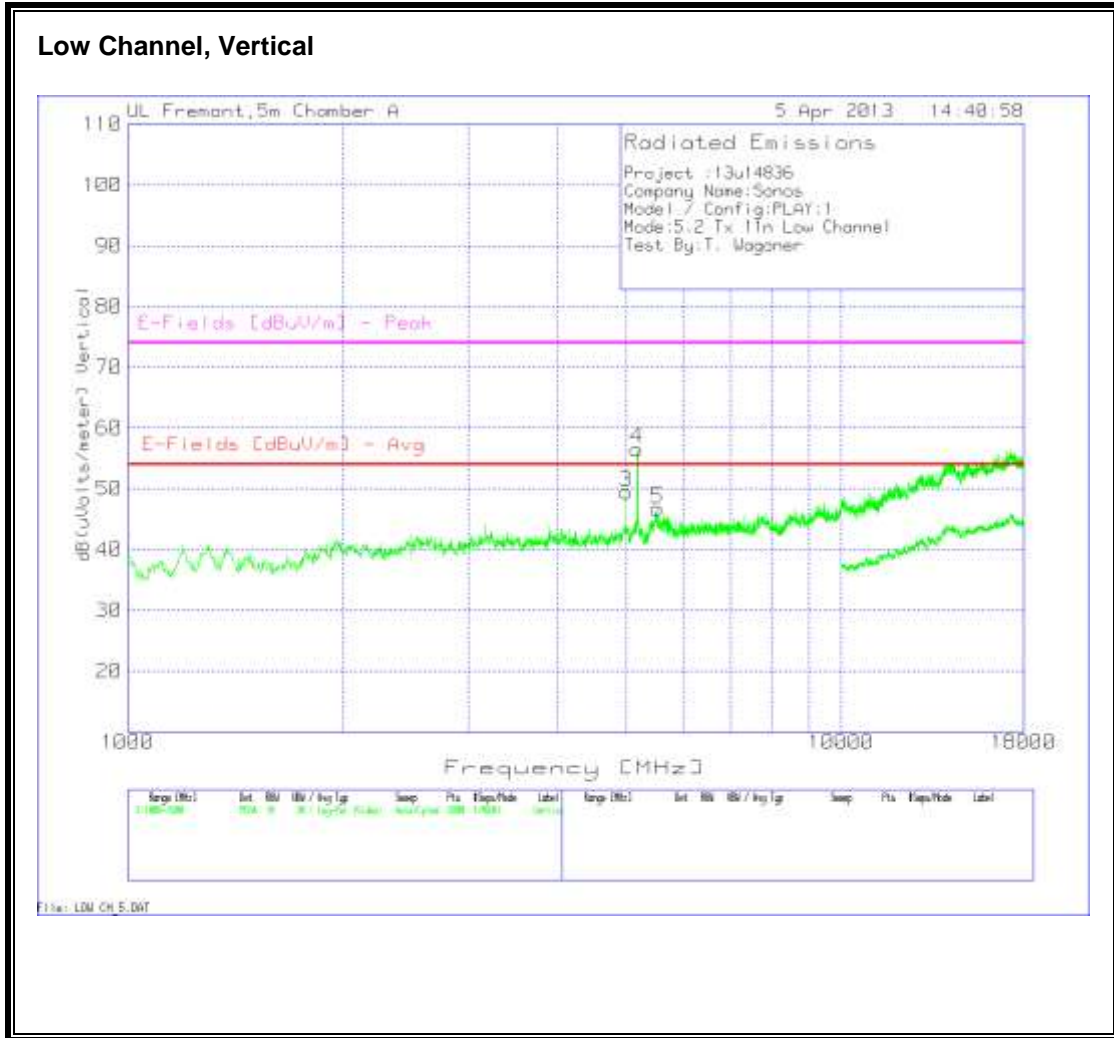

Low Channel, Data

Project :	13u14836														
Company Name:	Sonos														
Model / Config:	PLAY:1														
Mode:	5.2 Tx 11n Low Channel														
Test By:	T. Wagoner														

Marker No.	Test Frequency	Meter Reading	Detector	T136 Ant Factor [dB/m]	T144 Preamp Gain [dB]	Cable Factor [dB]	T159 BRf [dB]	dB(uVolts /meter)	E-Fields [dBuV/m] - Avg	Margin (dB)	E-Fields [dBuV/m] - Peak	Margin (dB)	Height [cm]	Polarity
1	5000.9	39.59	PK	33.9	-35.6	6.9	0.7	45.49	53.97	-8.48	74	-28.51	200	Horz
2*	5175.712	46.83	PK	34.2	-35.5	7	0.9	53.43	53.97	-0.54	74	-20.57	200	Horz
3	5000.9	43.52	PK	33.9	-35.6	6.9	0.7	49.42	53.97	-4.55	74	-24.58	100	Vert
4*	5179.01	49.91	PK	34.2	-35.5	7	0.9	56.51	53.97	2.54	74	-17.49	200	Vert
5	5528.636	39.91	PK	34.4	-35.5	7.3	0.6	46.71	53.97	-7.26	74	-27.29	200	Vert

*= Fundamental Frequency

PK - Peak detector

Av - Average detector

Note: points #2 and #4 are the fundamental frequency and exempted from this test.

Mid Channel, Horizontal

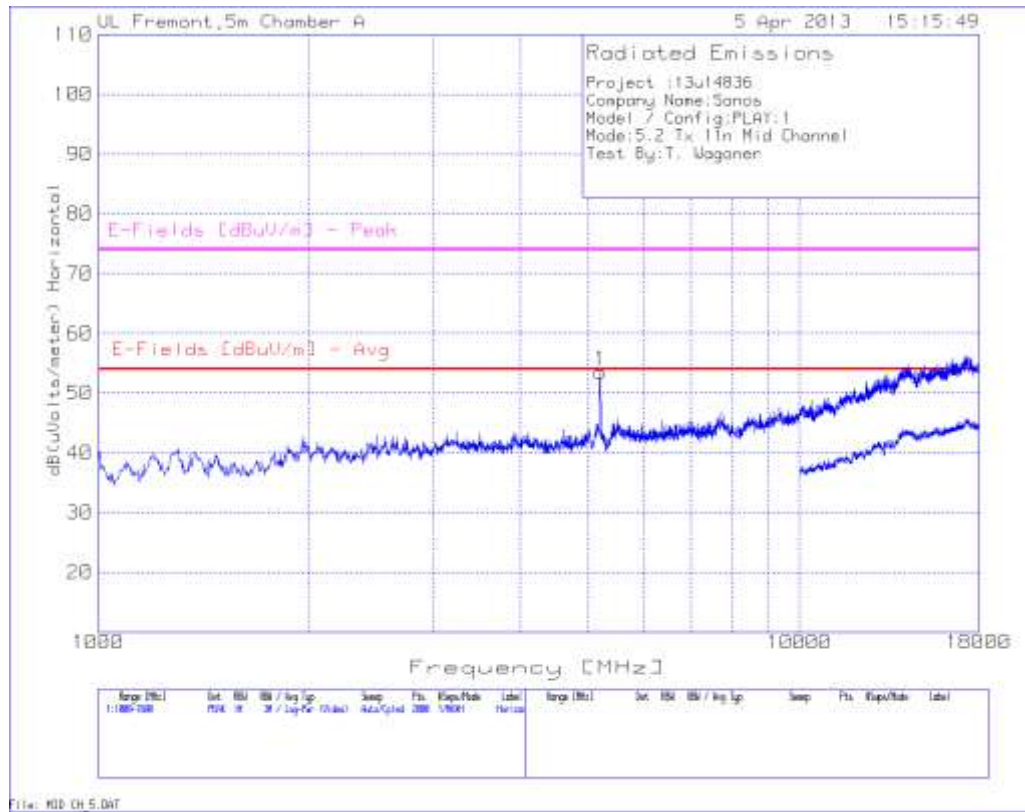

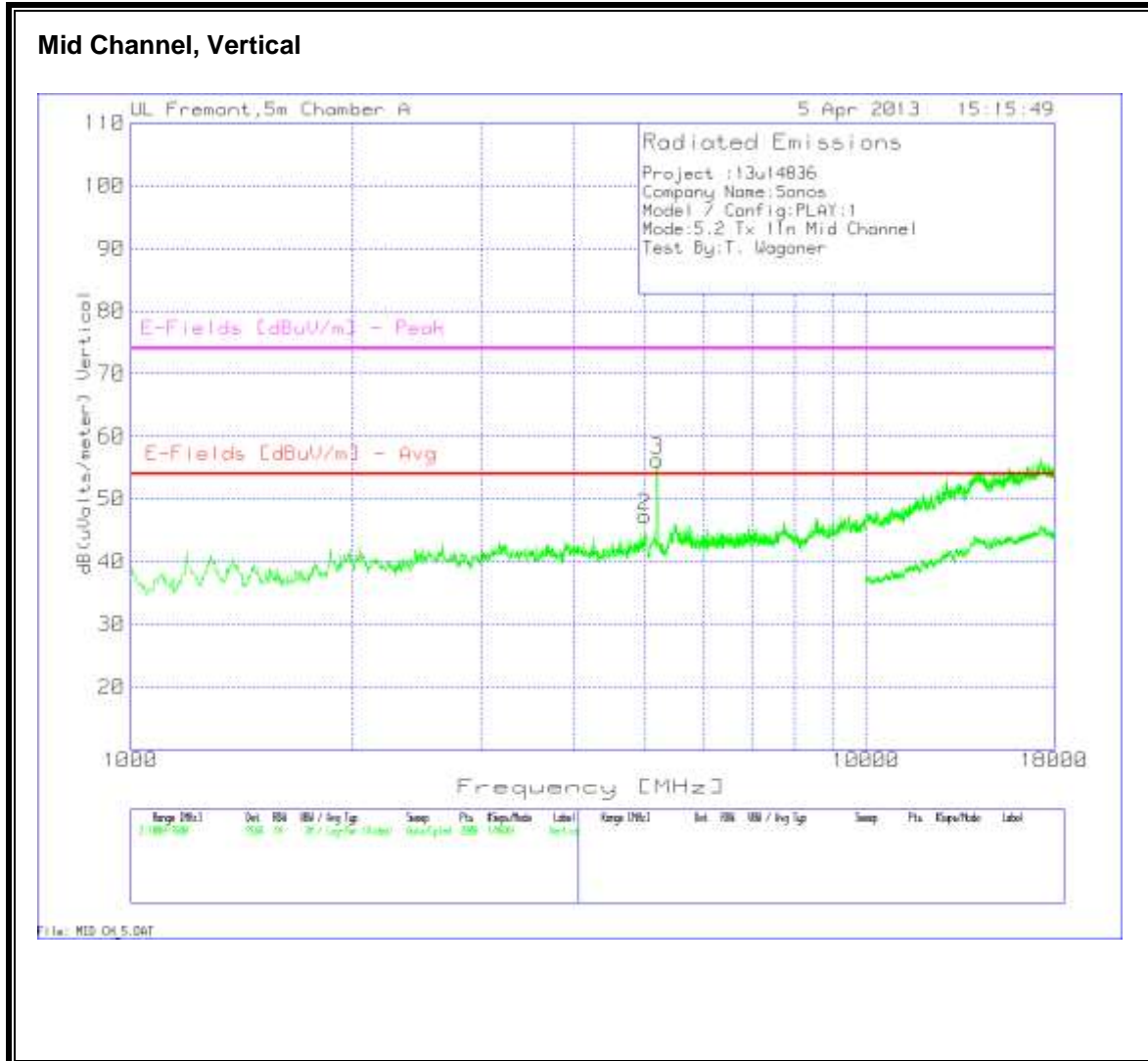

Mid Channel, Data

Project :	13u14836													
Company Name:	Sonos													
Model / Config:	PLAY:1													
Mode:	5.2 Tx 11n Mid Channel													
Test By:	T. Wagoner													

Marker No.	Test Frequency	Meter Reading	Detector	T136 Ant Factor [dB/m]	T144 Preamp Gain [dB]	Cable Factor [dB]	T159 BRF [dB]	dB(uVolts /meter)	E-Fields [dBuV/m] - Avg	Margin (dB)	E-Fields [dBuV/m] - Peak	Margin (dB)	Height [cm]	Polarity
1*	5205.397	46.81	PK	34.2	-35.5	7.1	0.9	53.51	53.97	-0.46	74	-20.49	200	Horz
2	5000.9	41.47	PK	33.9	-35.6	6.9	0.7	47.37	53.97	-6.6	74	-26.63	100	Vert
3*	5195.502	49.63	PK	34.2	-35.5	7	0.9	56.23	53.97	2.26	74	-17.77	200	Vert

*= Fundamental Frequency

PK - Peak detector

Av - Average detector

Note: points #1 and #3 are the fundamental frequency and exempted from this test.

High Channel, Horizontal

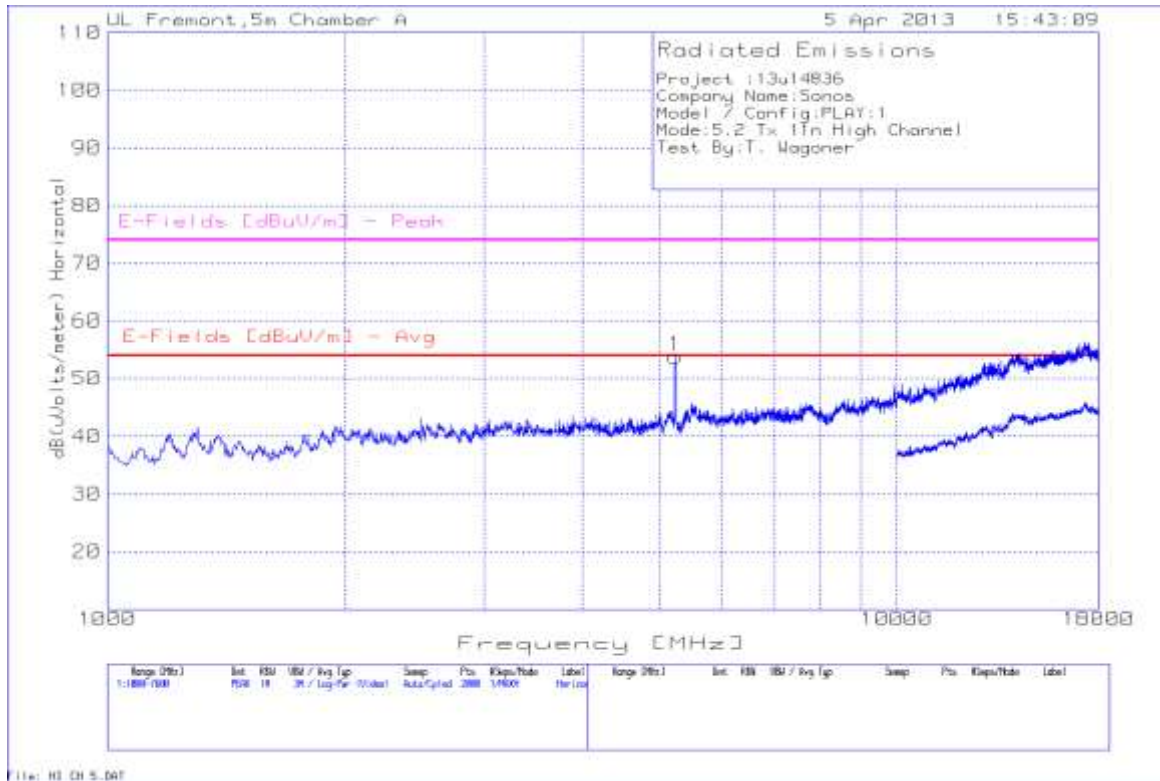

High Channel, Vertical

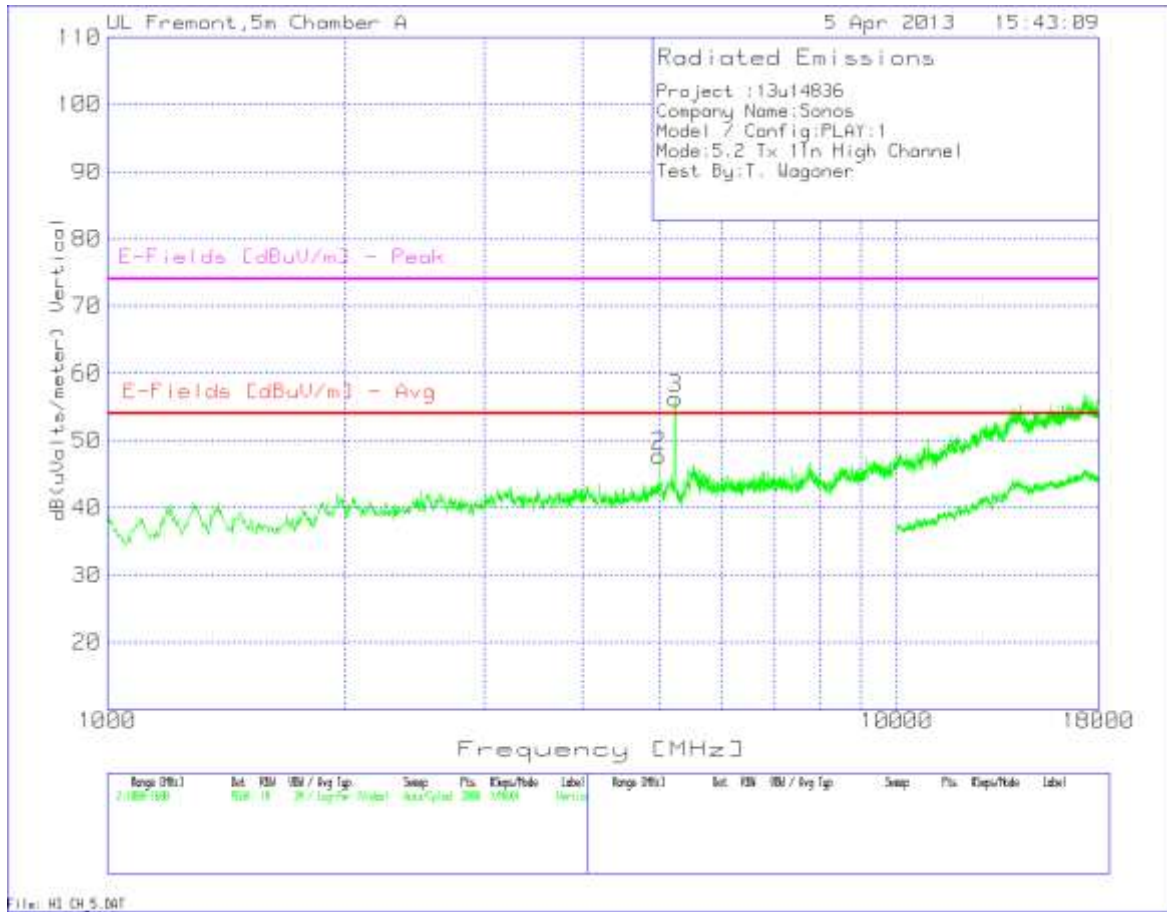

High Channel, Data														
Project :	13u14836													
Company Name:	Sonos													
Model / Config:	PLAY:1													
Mode:	5.2 Tx 11n High Channel													
Test By:	T. Wagoner													
Marker No.	Test Frequency	Meter Reading	Detector	T136 Ant Factor [dB/m]	T144 Preamp Gain [dB]	Cable Factor [dB]	T159 BRF [dB]	dB(uVolts /meter)	E-Fields [dBuV/m] - Avg	Margin (dB)	E-Fields [dBuV/m] - Peak	Margin (dB)	Height [cm]	Polarity
1*	5238.381	47.07	PK	34.2	-35.5	7.1	0.9	53.77	53.97	-0.2	74	-20.23	200	Horz
2	5000.9	41.81	PK	33.9	-35.6	6.9	0.7	47.71	53.97	-6.26	74	-26.29	100	Vert
3*	5244.978	49.56	PK	34.2	-35.5	7.1	0.9	56.26	53.97	2.29	74	-17.74	200	Vert
*= Fundamental Frequency														
PK - Peak detector														
Av - Average detector														
Note: points #1 and #3 are the fundamental frequency and exempted from this test.														

9.2.2. TX ABOVE 1 GHz 802.11n HT20 MODE IN THE 5.3 GHz BAND

RESTRICTED BANDEDGE (HIGH CHANNEL)

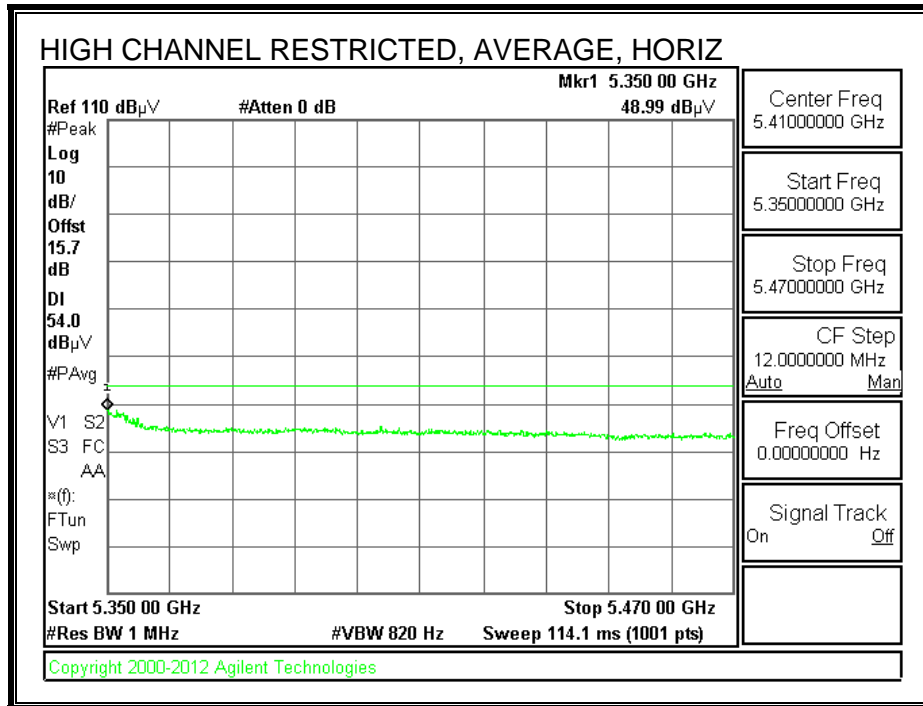
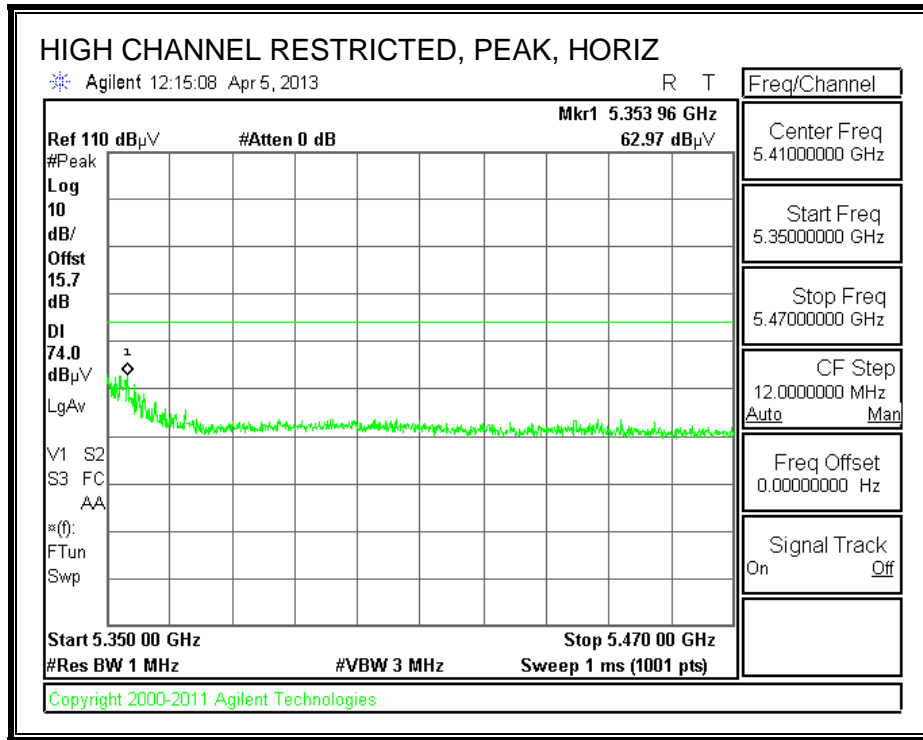

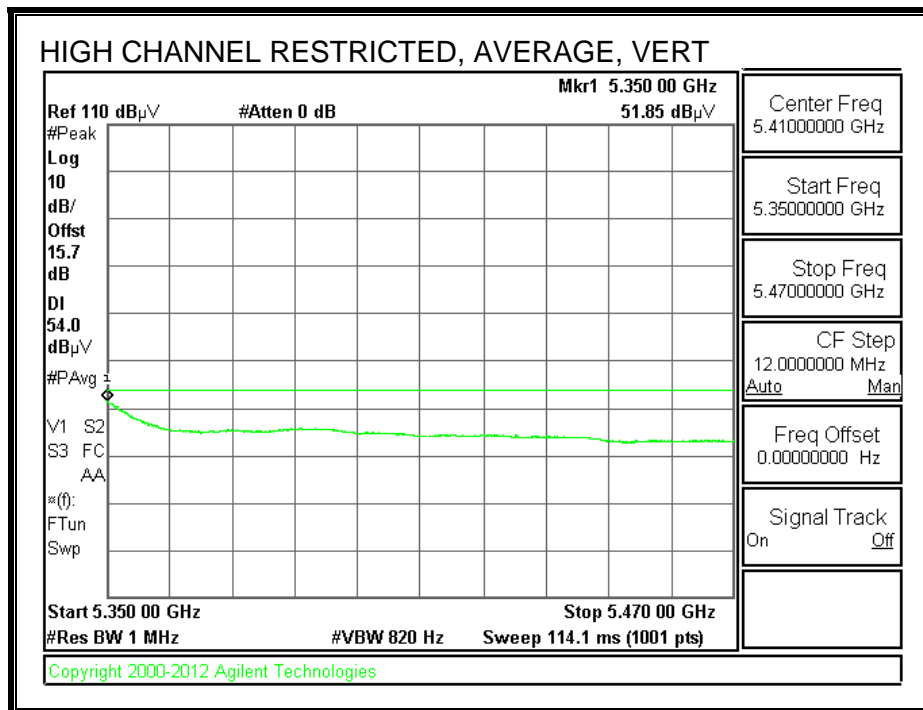
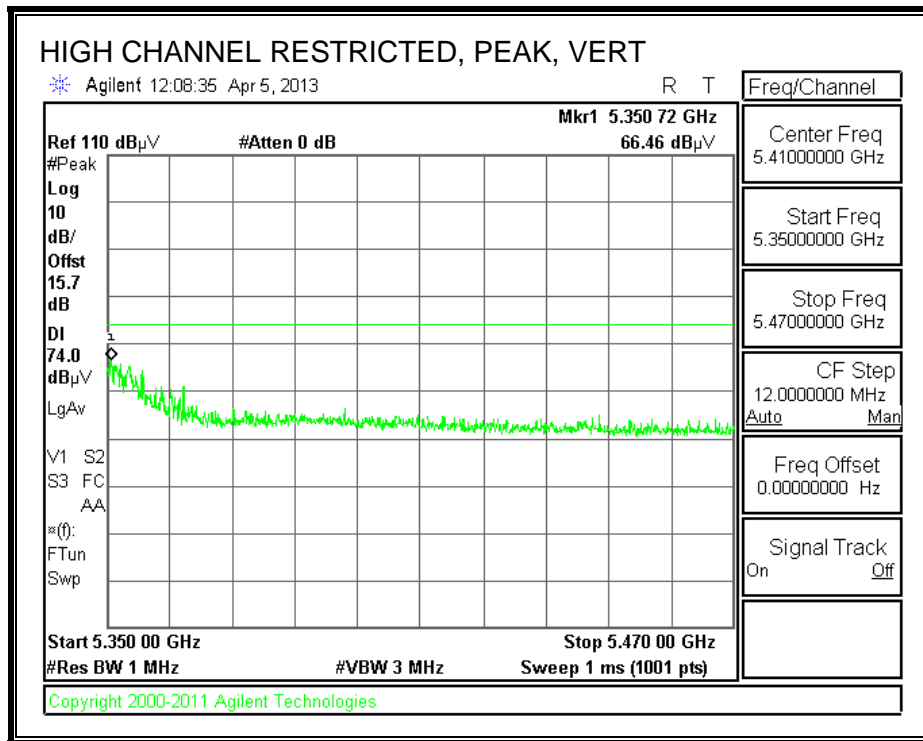

HARMONICS AND SPURIOUS EMISSIONS

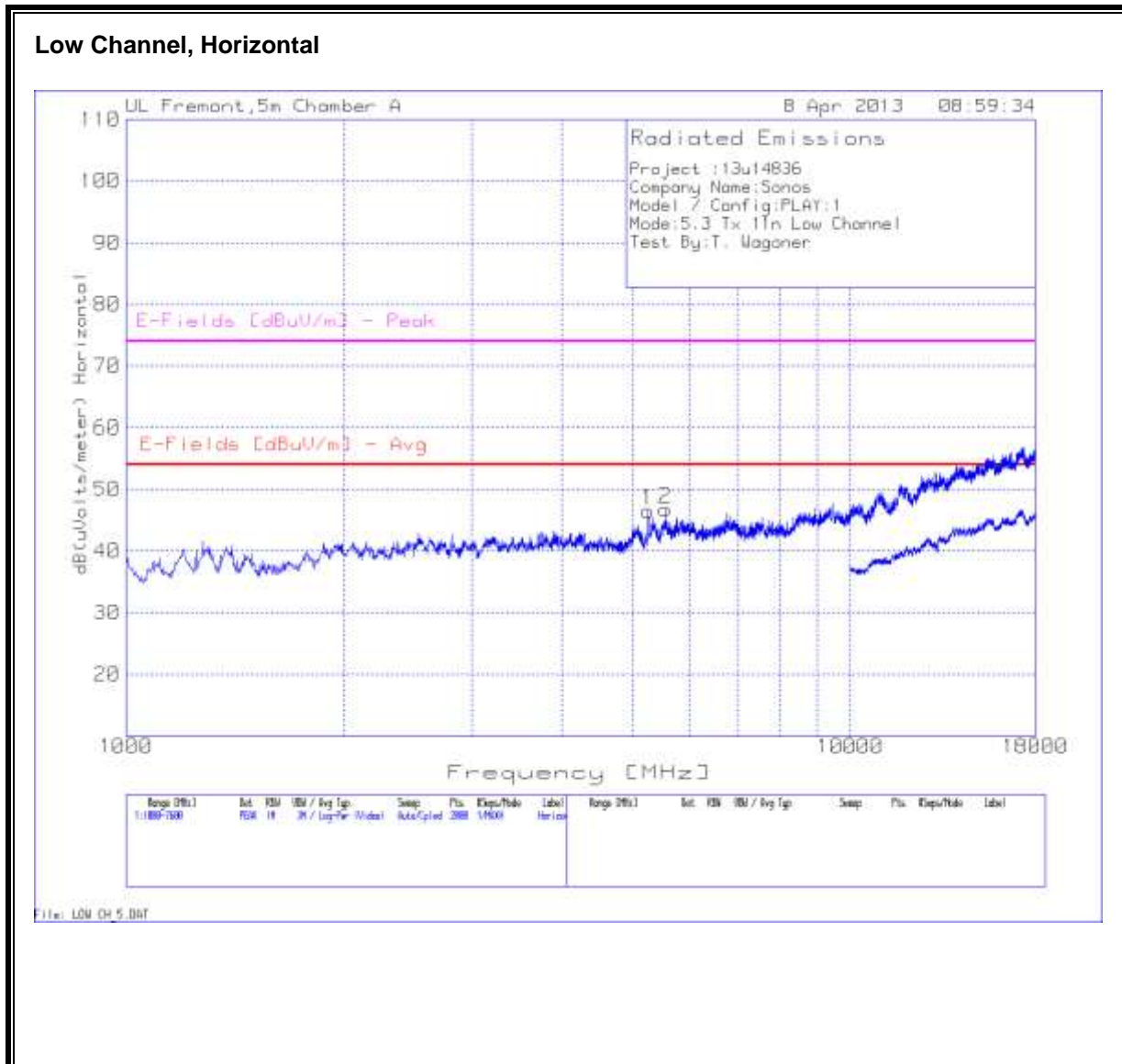

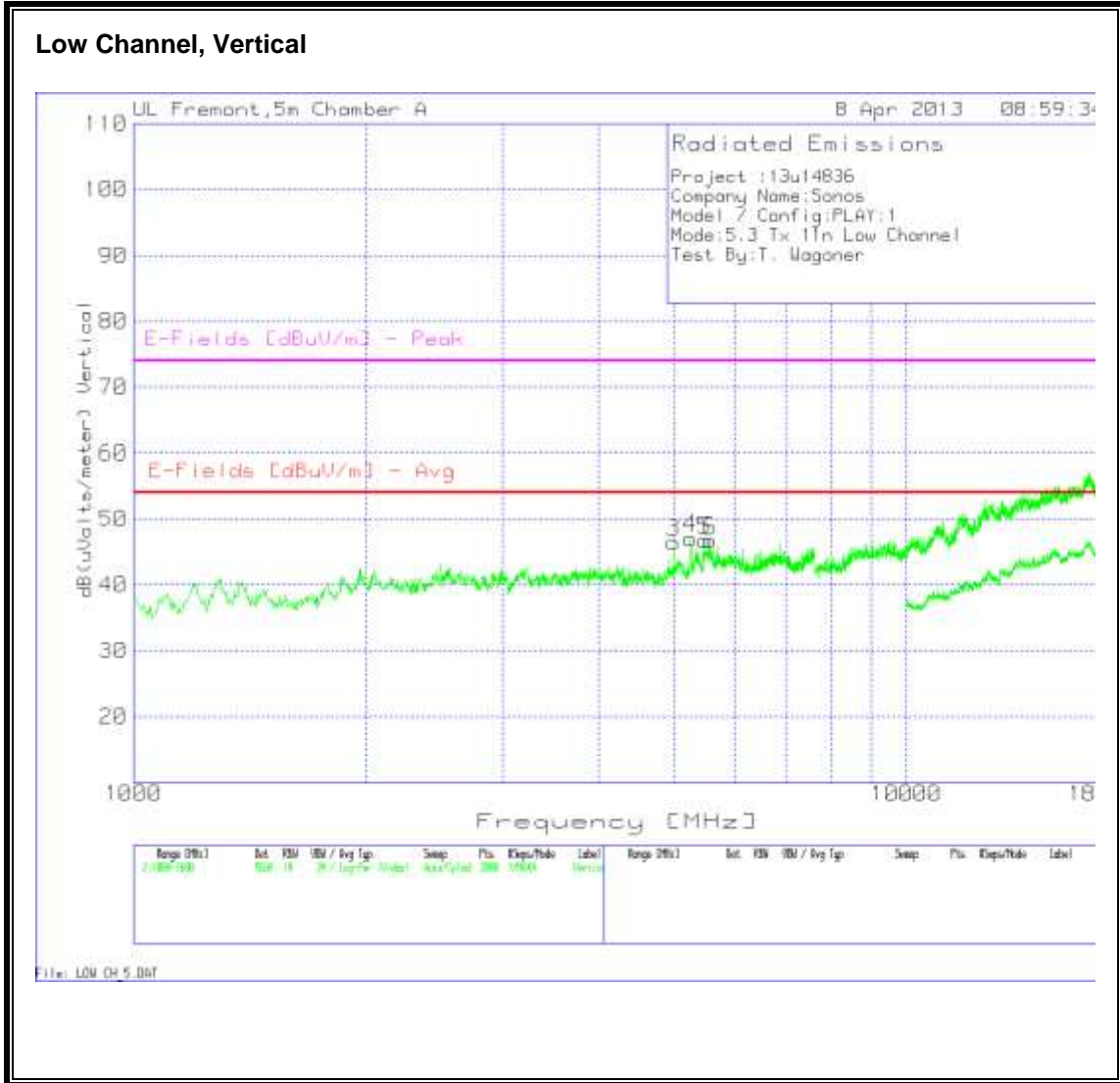

Low Channel, Data

Project :	13u14836													
Company Name:	Sonos													
Model / Config:	PLAY:1													
Mode:	5.3 Tx 11n Low Channel													
Test By:	T. Wagoner													

Marker No.	Test Frequency	Meter Reading	Detector	T136 Ant Factor [dB/m]	T144 Preamp Gain [dB]	Cable Factor [dB]	T159 BRF [dB]	dB(uVolts /meter)	E-Fields [dBuV/m] - Avg	Margin (dB)	E-Fields [dBuV/m] - Peak	Margin (dB)	Height [cm]	Polarity
1	5261.469	39.72	PK	34.3	-35.5	7.1	0.9	46.52	53.97	-7.45	74	-27.48	200	Horz
2	5561.619	40.28	PK	34.4	-35.5	7.3	0.3	46.78	53.97	-7.19	74	-27.22	100	Horz
3	5000.9	40.63	PK	33.9	-35.6	6.9	0.7	46.53	53.97	-7.44	74	-27.47	100	Vert
4	5254.873	40.25	PK	34.3	-35.5	7.1	0.9	47.05	53.97	-6.92	74	-26.95	200	Vert
5	5479.16	39.68	PK	34.4	-35.5	7.3	0.9	46.78	53.97	-7.19	74	-27.22	100	Vert
6	5574.813	40.11	PK	34.4	-35.5	7.4	0.3	46.71	53.97	-7.26	74	-27.29	100	Vert

PK - Peak detector

Av - Average detector

Mid Channel, Horizontal

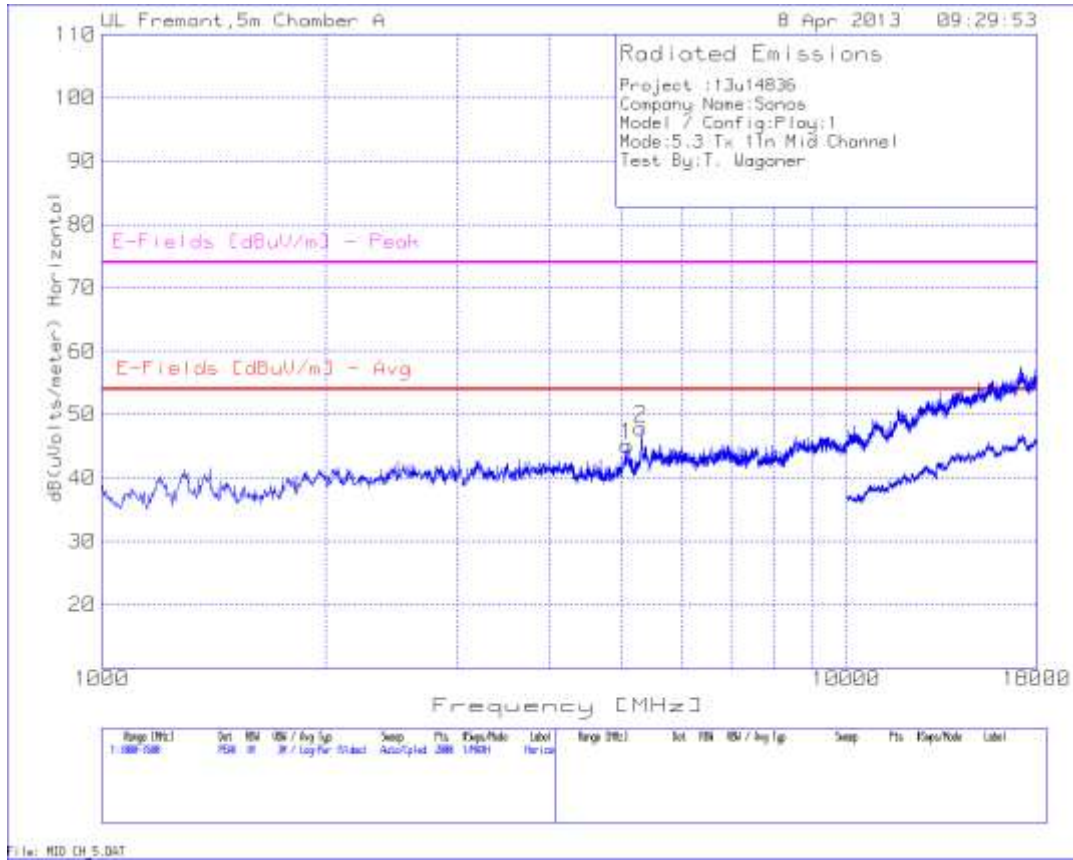

Mid Channel, Vertical

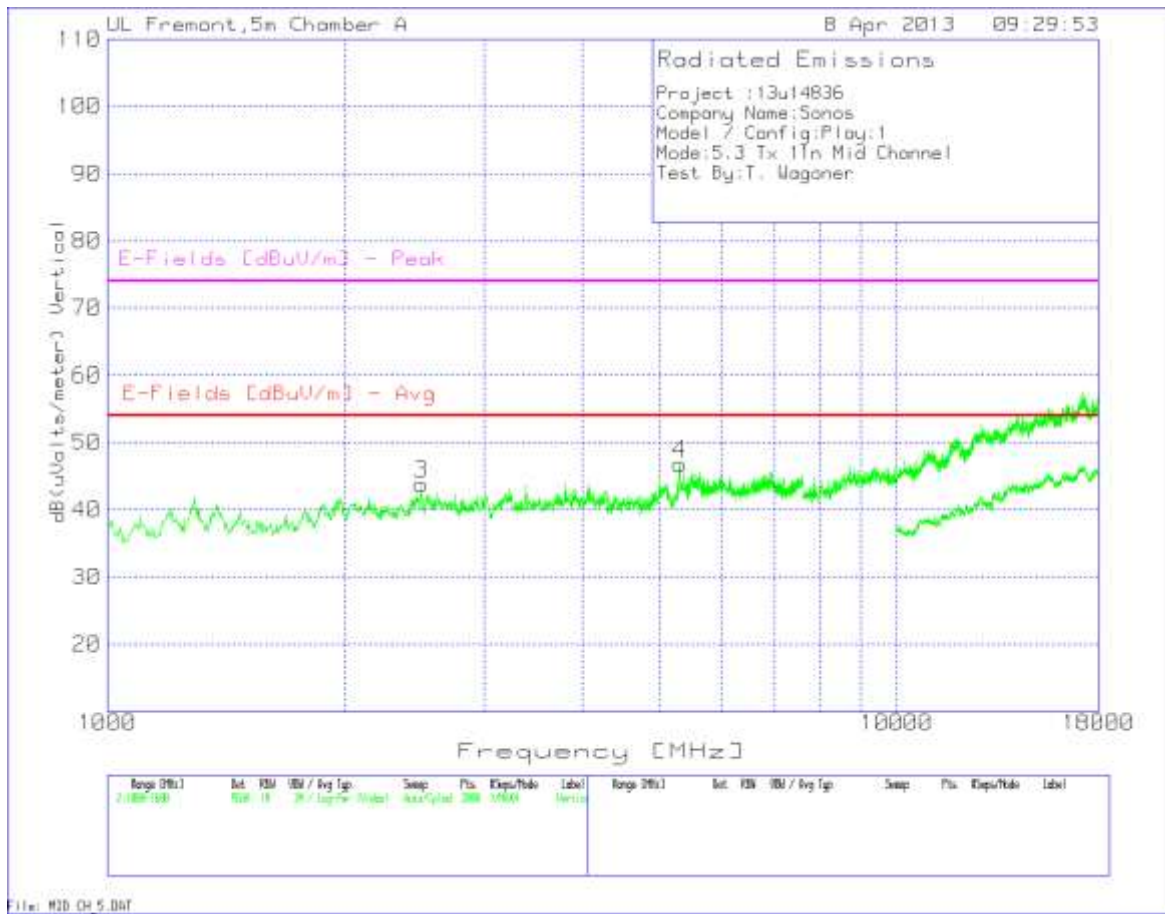

Mid Channel, Data

Project :	13u14836														
Company Name:	Sonos														
Model / Config:	Play:1														
Mode:	5.3 Tx 11n Mid Channel														
Test By:	T. Wagoner														

Marker No.	Test Frequency	Meter Reading	Detector	T136 Ant Factor [dB/m]	T144 Preamp Gain [dB]	Cable Factor [dB]	T159 BRF [dB]	dB(uVolts /meter)	E-Fields [dBuV/m] - Avg	Margin (dB)	E-Fields [dBuV/m] - Peak	Margin (dB)	Height [cm]	Polarity
1	5073.463	38.92	PK	34	-35.6	6.9	0.9	45.12	53.97	-8.85	74	-28.88	100	Horz
2	5304.348	41.06	PK	34.3	-35.5	7.1	0.9	47.86	53.97	-6.11	74	-26.14	200	Horz
3	2500.75	43.51	PK	32.6	-36.8	4.5	0	43.81	53.97	-10.16	74	-30.19	100	Vert
4	5307.646	39.99	PK	34.3	-35.5	7.1	0.9	46.79	53.97	-7.18	74	-27.21	200	Vert

PK - Peak detector

Av - Average detector

High Channel, Horizontal

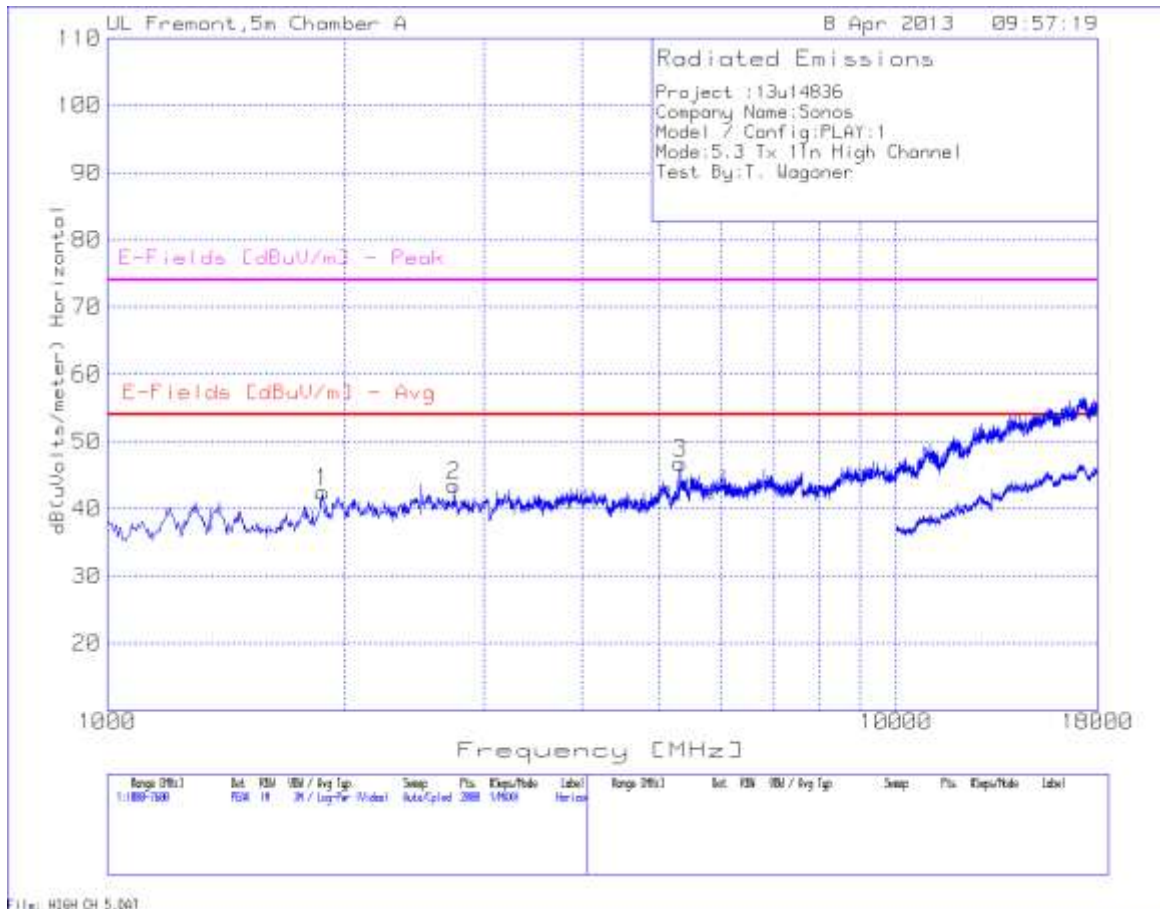

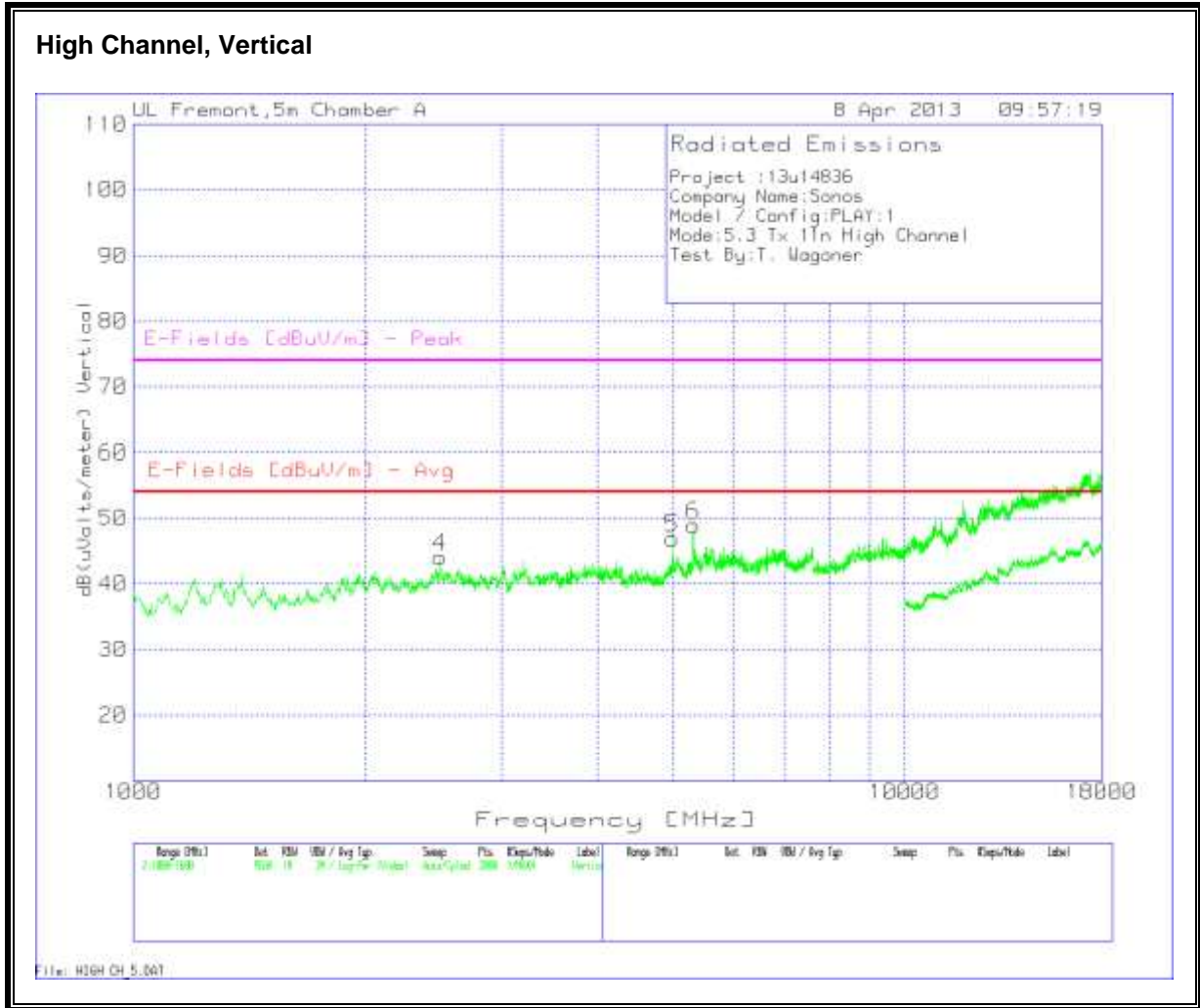

High Channel, Data

Project :	13u14836														
Company Name:	Sonos														
Model / Config:	PLAY:1														
Mode:	5.3 Tx 11n High Channel														
Test By:	T. Wagoner														

Marker No.	Test Frequency	Meter Reading	Detector	T136 Ant Factor [dB/m]	T144 Preamp Gain [dB]	Cable Factor [dB]	T159 BR [dB]	dB(uVolts /meter)	E-Fields [dBuV/m] - Avg	Margin (dB)	E-Fields [dBuV/m] - Peak	Margin (dB)	Height [cm]	Polarity
1	1877.361	44.41	PK	31.4	-37.2	3.9	0	42.51	53.97	-11.46	74	-31.49	100	Horz
2	2754.723	42.86	PK	32.6	-36.8	4.8	0	43.46	53.97	-10.51	74	-30.54	100	Horz
3*	5327.436	39.83	PK	34.3	-35.5	7.2	0.9	46.73	53.97	-7.24	74	-27.27	200	Horz
4	2497.451	43.71	PK	32.6	-36.8	4.5	0.1	44.11	53.97	-9.86	74	-29.89	100	Vert
5	5000.9	40.97	PK	33.9	-35.6	6.9	0.7	46.87	53.97	-7.1	74	-27.13	100	Vert
6*	5324.138	42.06	PK	34.3	-35.5	7.2	0.9	48.96	53.97	-5.01	74	-25.04	200	Vert

*= Fundamental Frequency
 PK - Peak detector
 Av - Average detector

Note: point #6 is the fundamental frequency and exempted from this test.

9.2.3. TX ABOVE 1 GHz 802.11n HT20 MODE IN THE 5.6 GHz BAND

RESTRICTED & AUTHORIZED BANDEDGE (LOW CHANNEL)

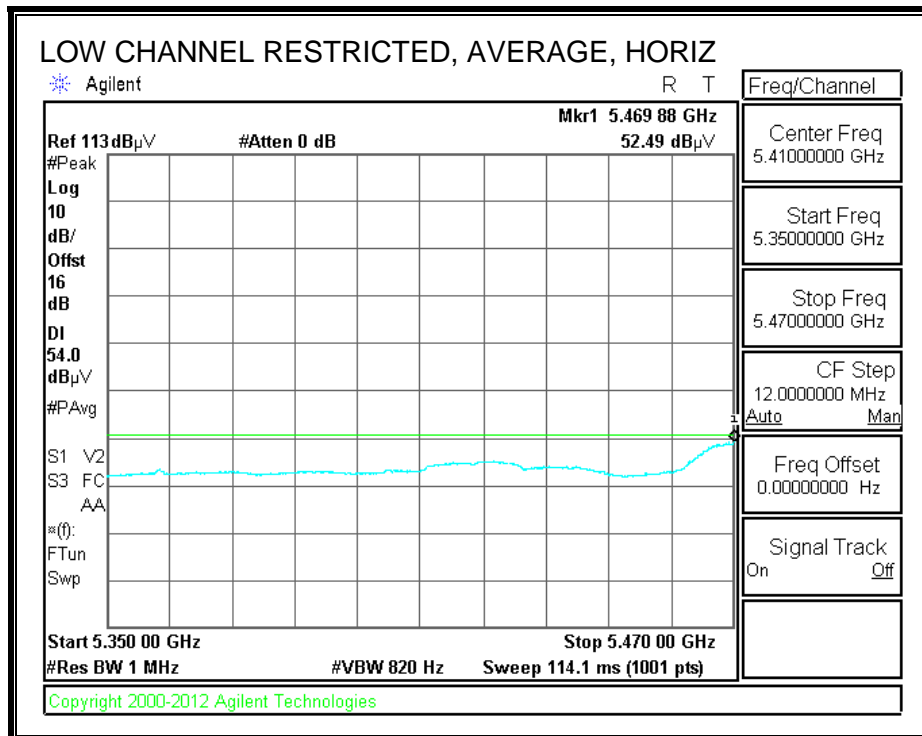
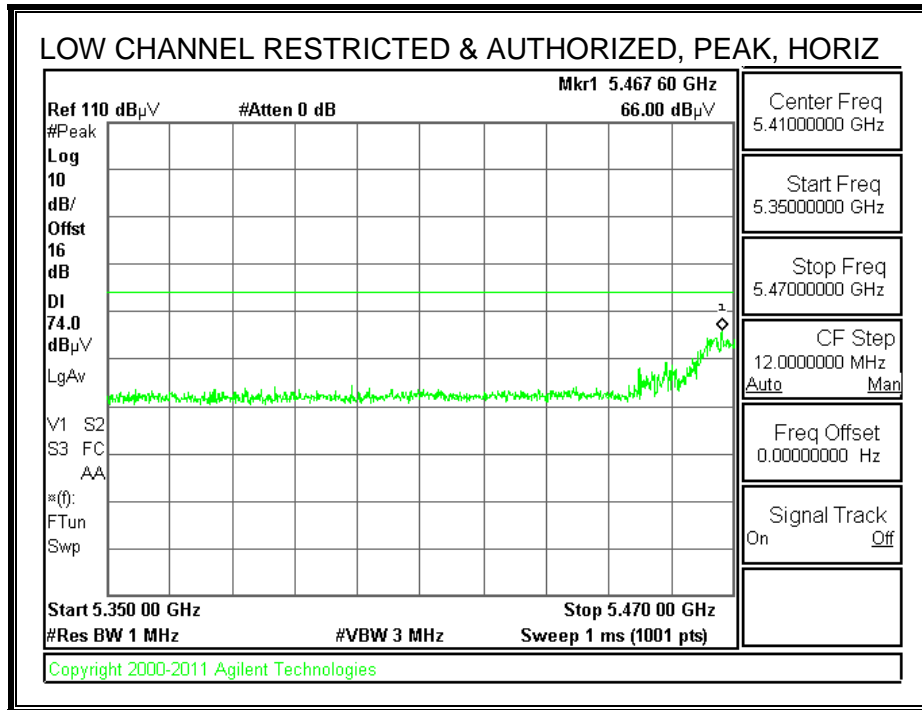

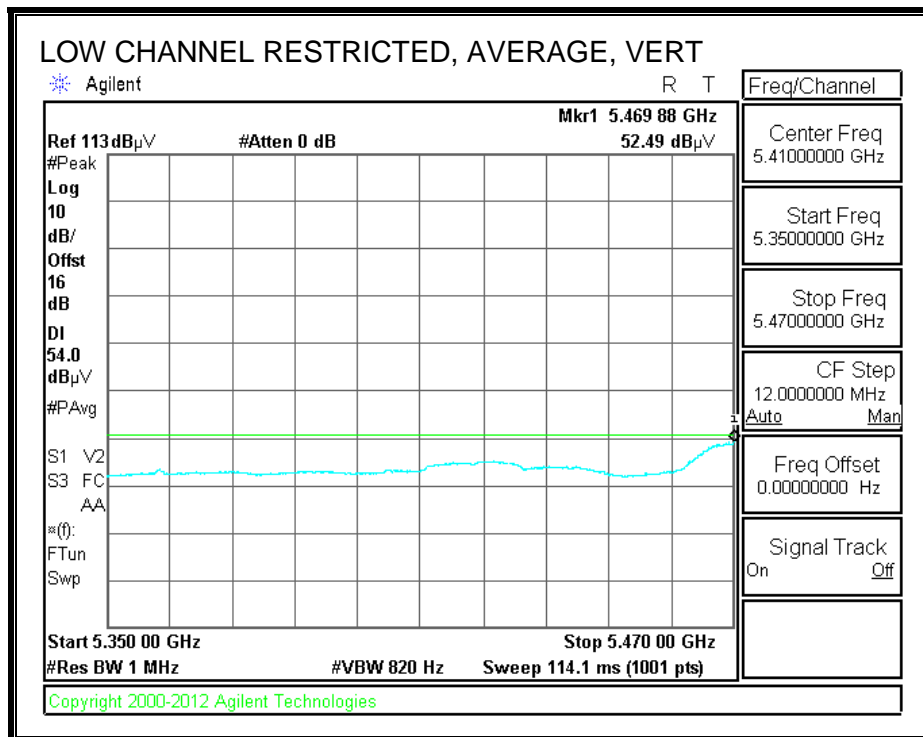
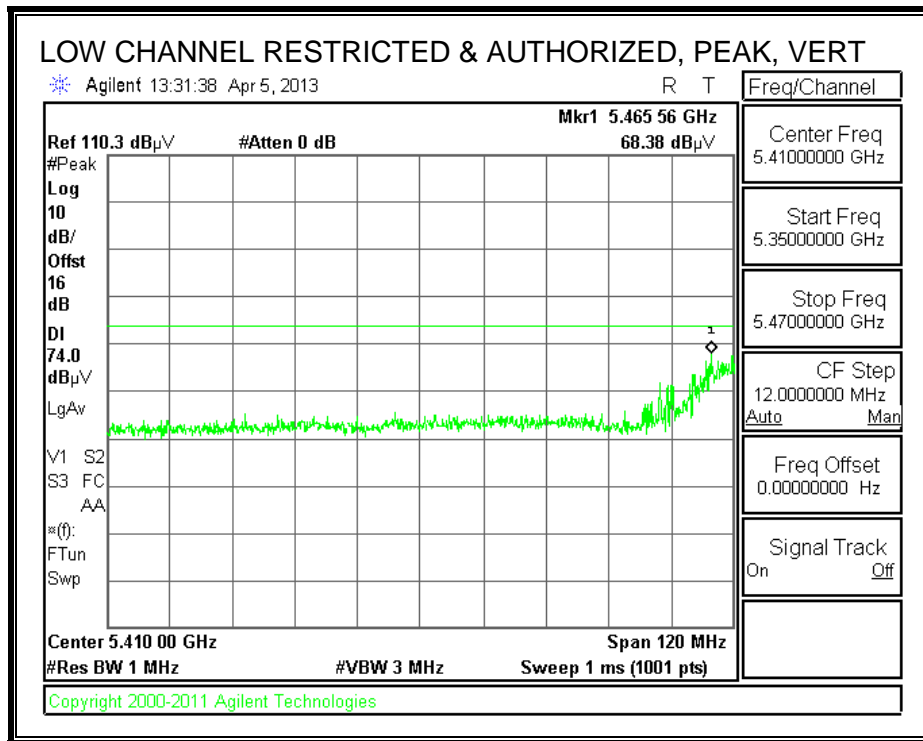

AUTHORIZED BANDEDGE (HIGH CHANNEL)

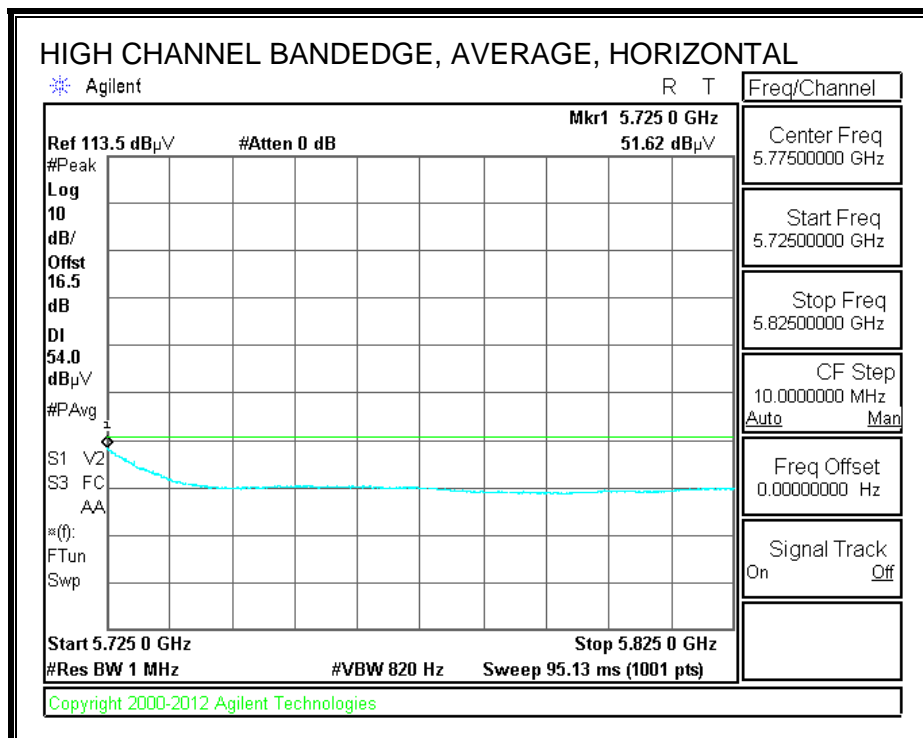
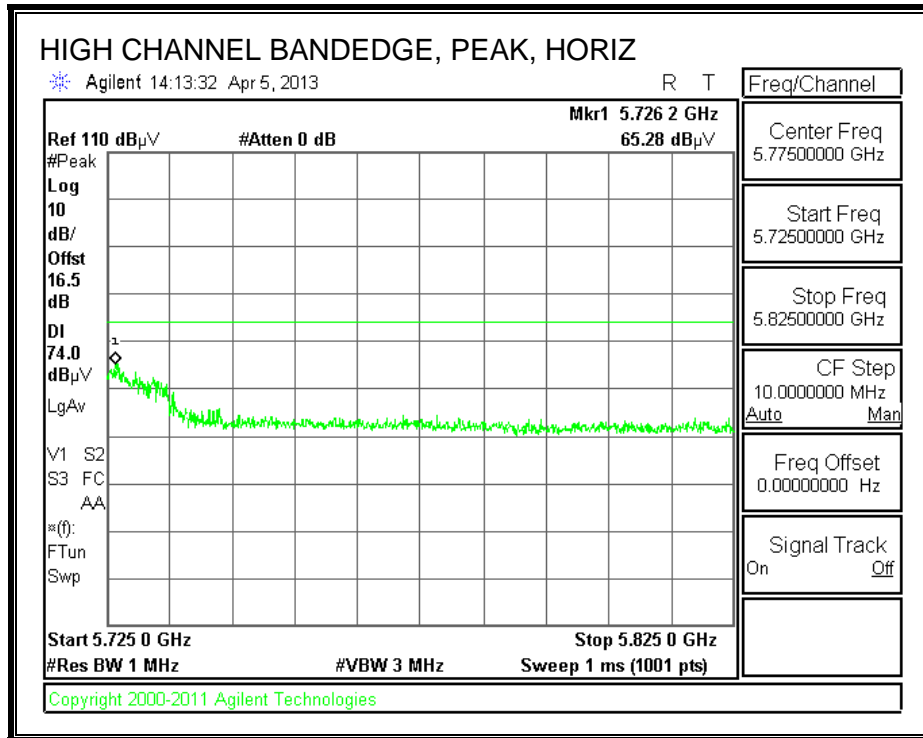

AUTHORIZED BANDEDGE (HIGH CHANNEL)

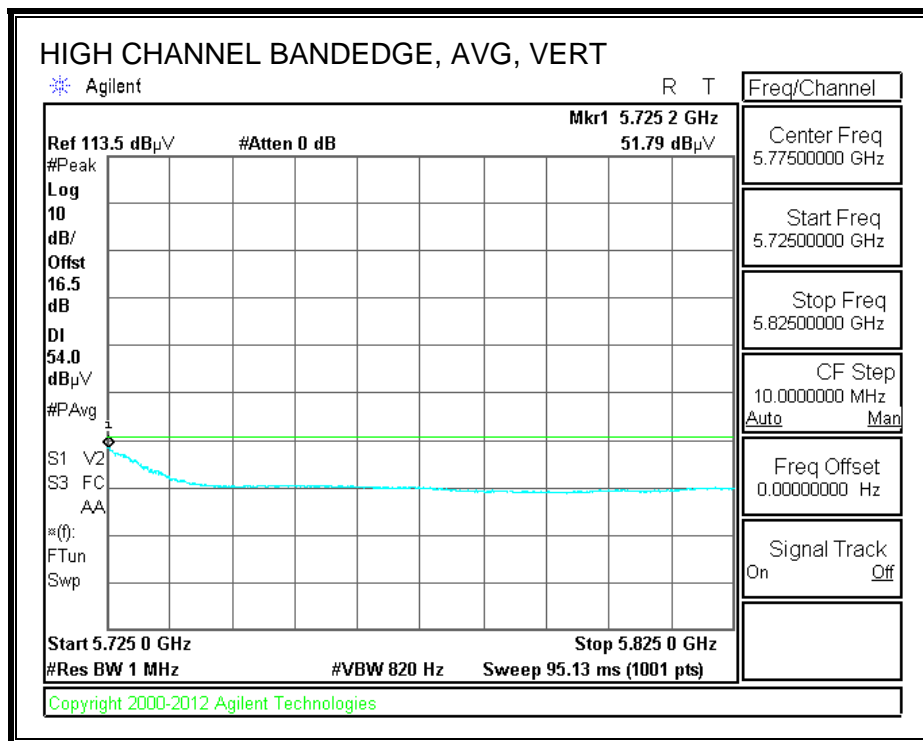
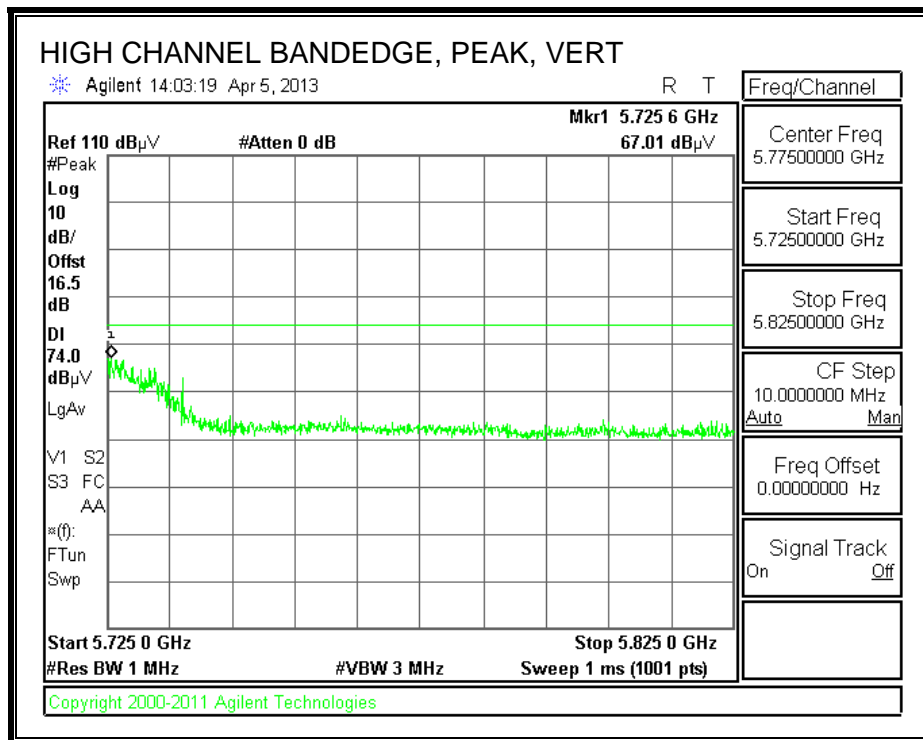

HARMONICS AND SPURIOUS EMISSIONS

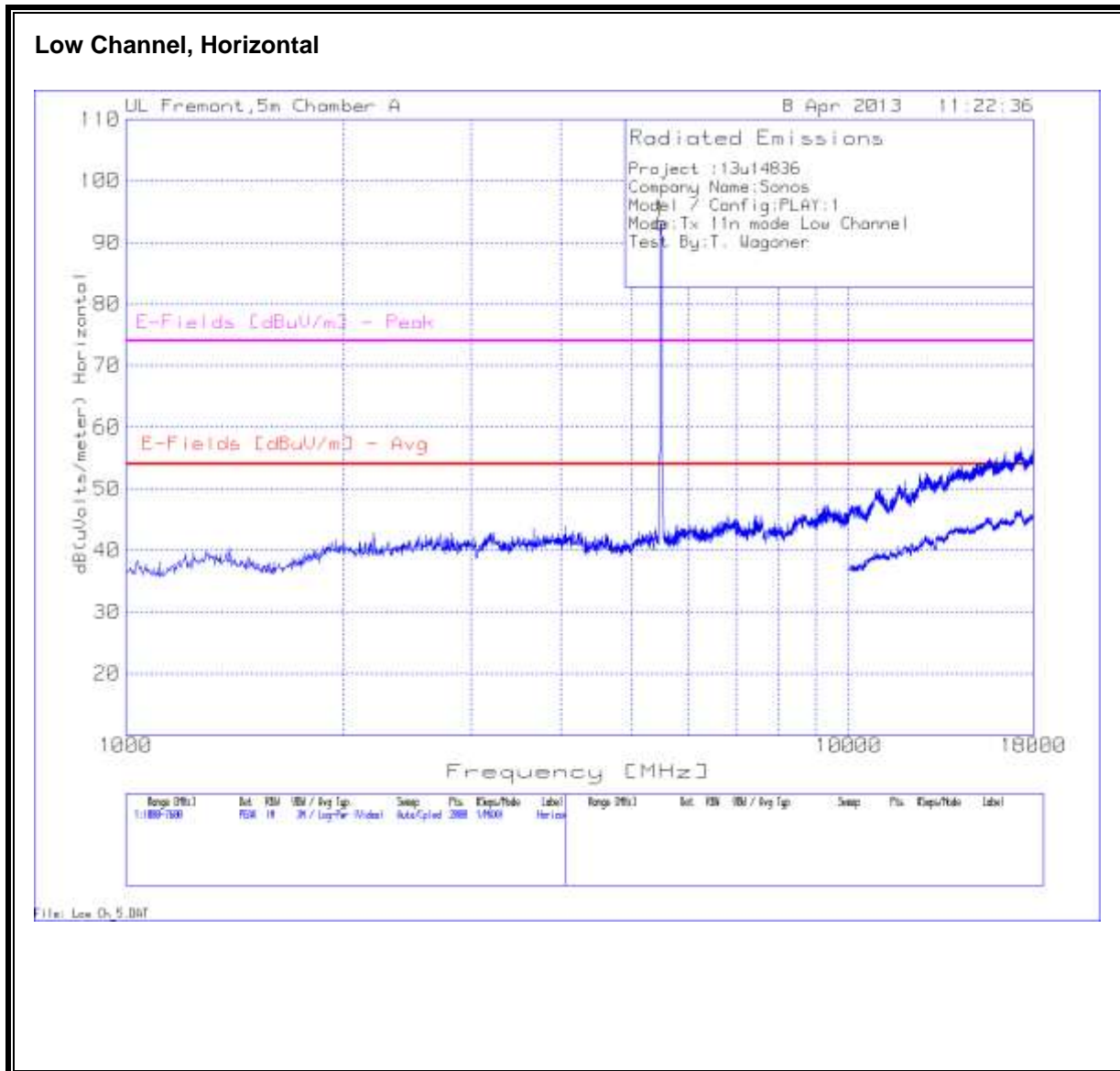

Low Channel, Vertical

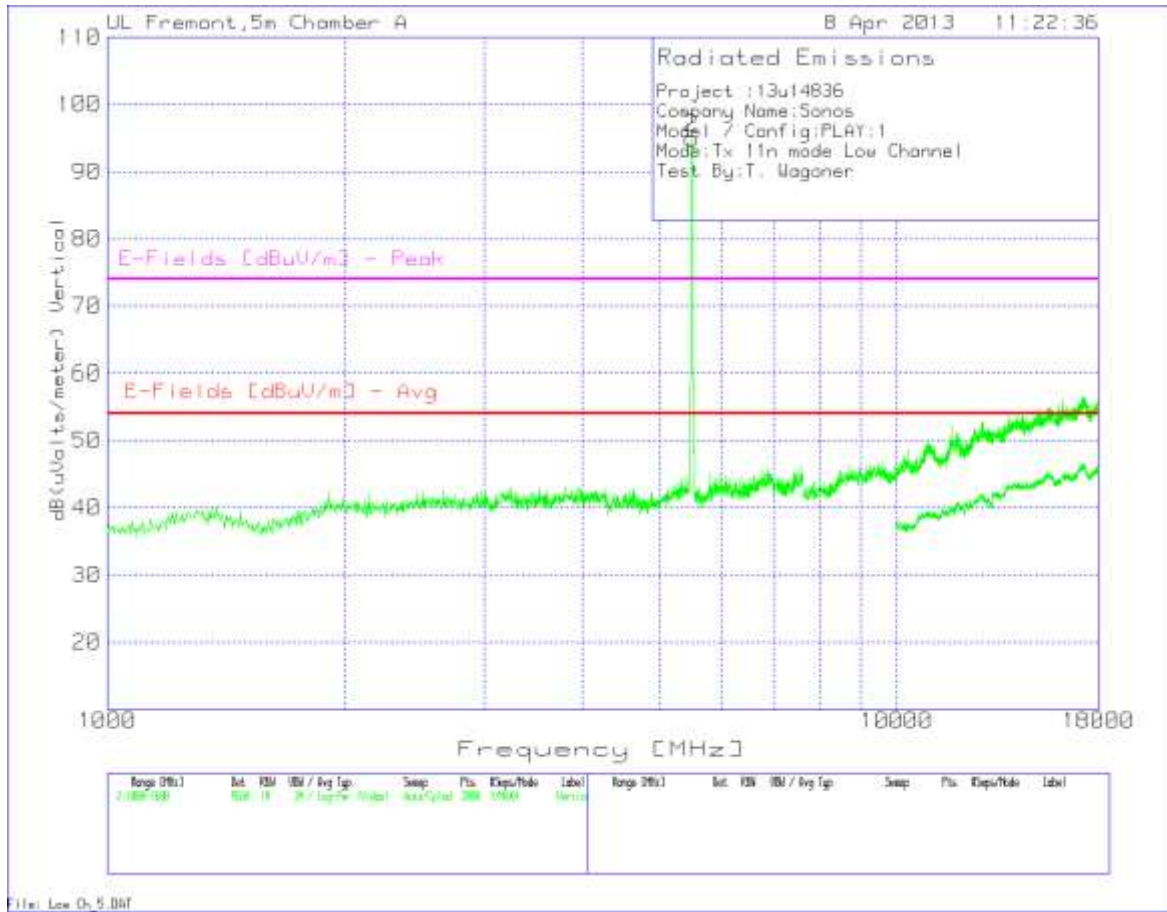

Low Channel, Data															
Project :	13u14836														
Company Name:	Sonos														
Model / Config:	PLAY:1														
Mode:	Tx 11n mode Low Channel														
Test By:	T. Wagoner														
Marker No.	Test Frequency	Meter Reading	Detector	T136 Ant Factor [dB/m]	T144 HP8449B	3ft 5mA 228077002	8ft 5mA 22807600 2 1-18GHz	20ft 5mA 220875002 1-18GHz	dB(uVolts /meter)	E-Fields [dBuV/m] - Avg	Margin (dB)	E-Fields [dBuV/m] - Peak	Margin (dB)	Height [cm]	Polarity
1*	5498.951	86.95	PK	34.4	-35.5	0.7	1.8	4.9	93.25	53.97	39.28	74	19.25	100	Horz
2*	5505.547	88.65	PK	34.4	-35.5	0.7	1.8	4.9	94.95	53.97	40.98	74	20.95	100	Vert
* = Fundamental Frequency															
PK - Peak detector															
Av - Average detector															

Note: points #1 and #2 are the fundamental frequency and exempted from this test

Mid Channel, Horizontal

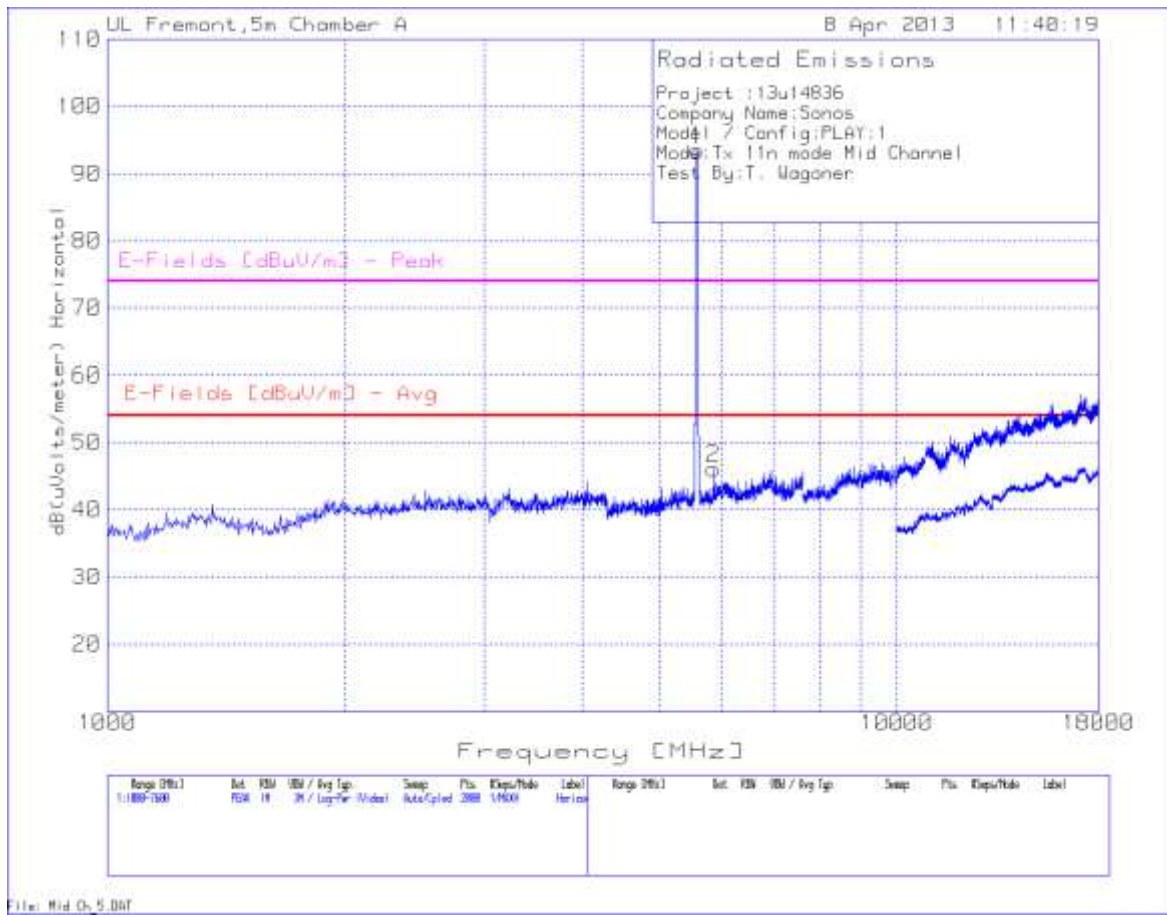

Mid Channel, Vertical

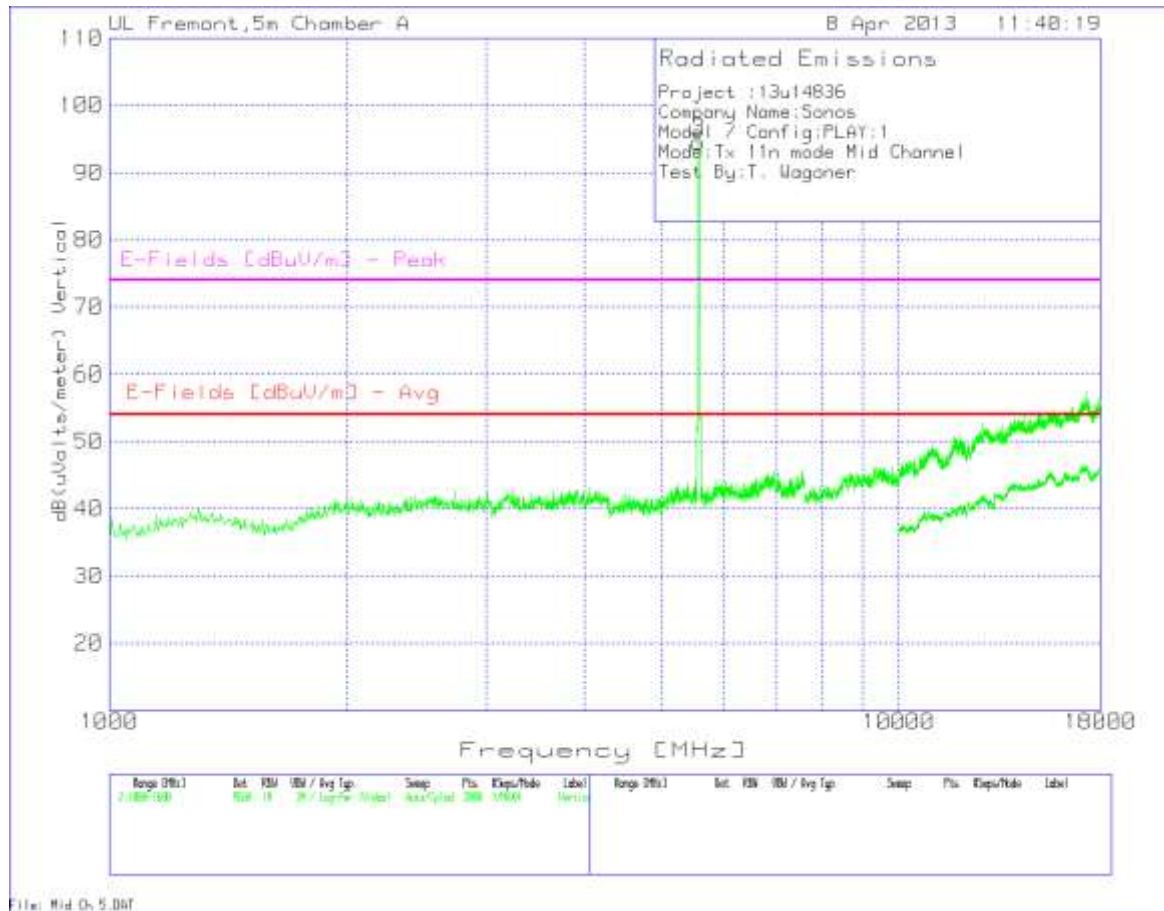

Mid Channel, Data

Project :	13u14836														
Company Name:	Sonos														
Model / Config:	PLAY:1														
Mode:	Tx 11n mode Mid Channel														
Test By:	T. Wagoner														
Marker No.	Test Frequency	Meter Reading	Detector	T136 Ant Factor [dB/m]	T144 HP8449B	3ft 5mA 228077002	8ft 5mA 228076002 1-18GHz	20ft 5mA 220875002 1-18GHz	dB(uVolts /meter)	E-Fields [dBuV/m] - Avg	Margin (dB)	E-Fields [dBuV/m] - Peak	Margin (dB)	Height [cm]	Polarity
1*	5584.708	87.04	PK	34.4	-35.5	0.7	1.8	5	93.44	53.97	39.47	74	19.44	100	Horz
2	5861.769	39	PK	35	-35.5	0.7	1.8	5.1	46.1	53.97	-7.87	74	-27.9	100	Horz
3*	5578.111	88.13	PK	34.4	-35.5	0.7	1.8	5	94.53	53.97	40.56	74	20.53	100	Vert
*= Fundamental Frequency															
PK - Peak detector															
Av - Average detector															

Note: points #1 and #3 are the fundamental frequency and exempted from this test

High Channel, Horizontal

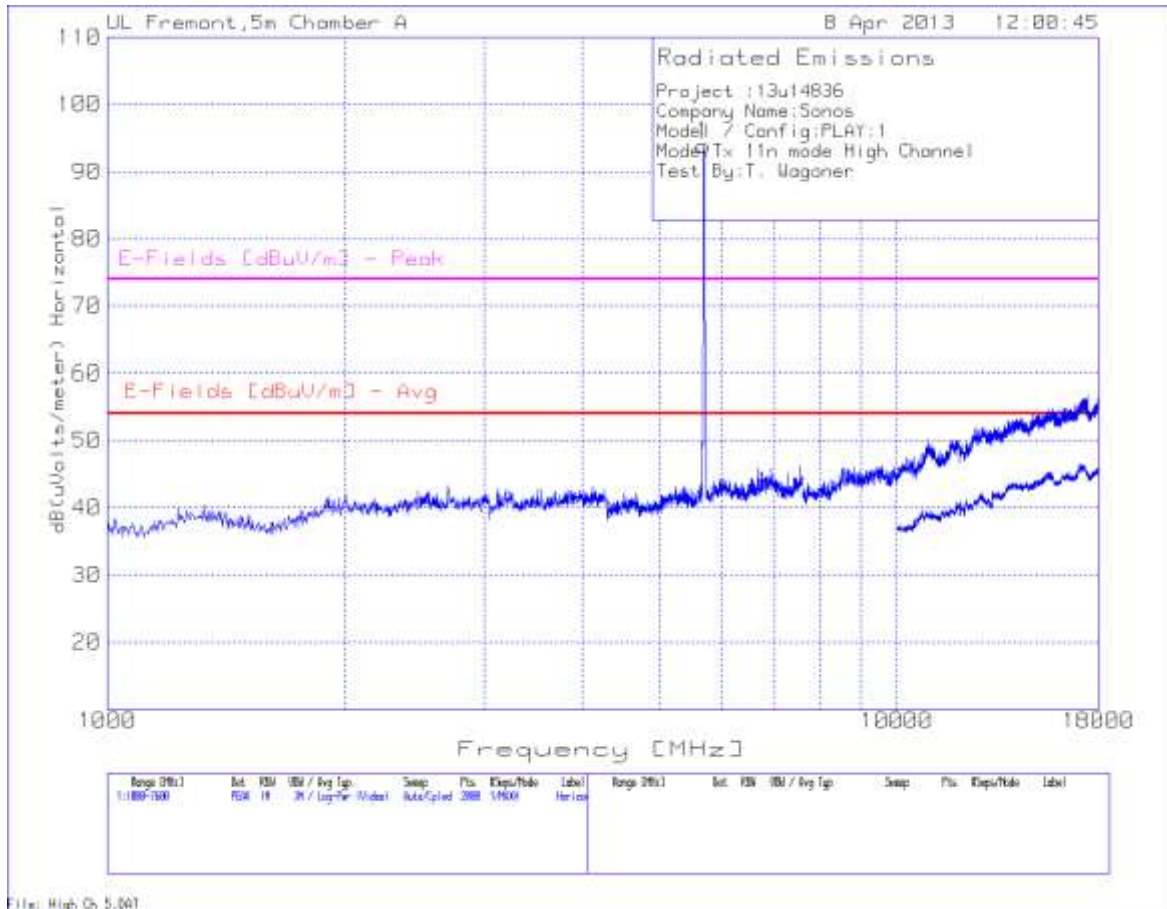

High Channel, Vertical

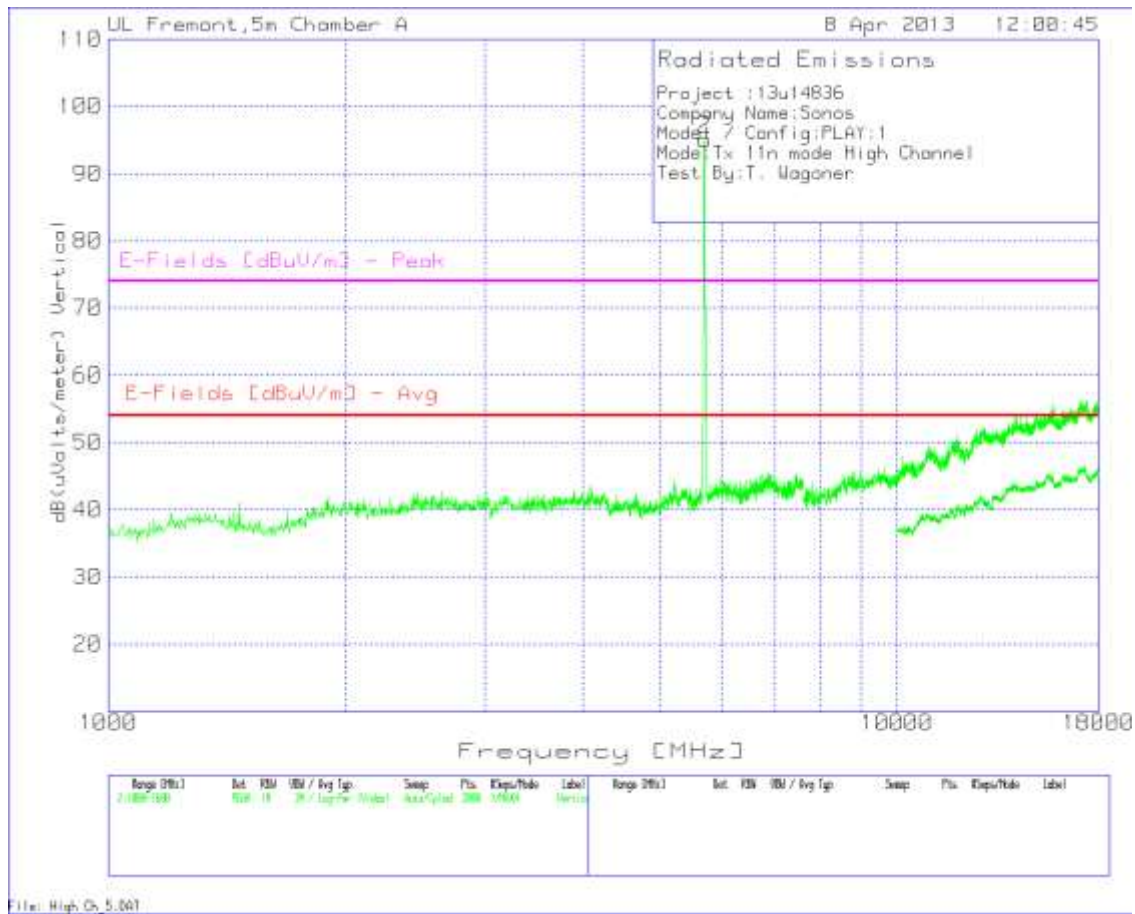

High Channel, Data

Project :	13u14836															
Company Name:	Sonos															
Model / Config:	PLAY:1															
Mode:	Tx 11n mode High Channel															
Test By:	T. Wagoner															

Marker No.	Test Frequency	Meter Reading	Detector	T136 Ant Factor [dB/m]	T144 HP8449B	3ft 5mA 228077002	8ft 5mA 228076002 1-18GHz	20ft 5mA 220875002 1-18GHz	dB(uVolts /meter)	E-Fields [dBuV/m] - Avg	Margin (dB)	E-Fields [dBuV/m] - Peak	Margin (dB)	Height [cm]	Polarity
1*	5700.15	87.23	PK	34.6	-35.5	0.7	1.8	5	93.83	53.97	39.86	74	19.83	100	Horz
2*	5706.747	88.47	PK	34.6	-35.5	0.7	1.8	5	95.07	53.97	41.1	74	21.07	100	Vert

*= Fundamental Frequency

PK - Peak detector

Av - Average detector

Note: points #1 and #2 are the fundamental frequency and exempted from this test

9.3. WORST-CASE BELOW 1 GHz

SPURIOUS EMISSIONS 30 TO 1000 MHz (WORST-CASE CONFIGURATION, HORIZONTAL)

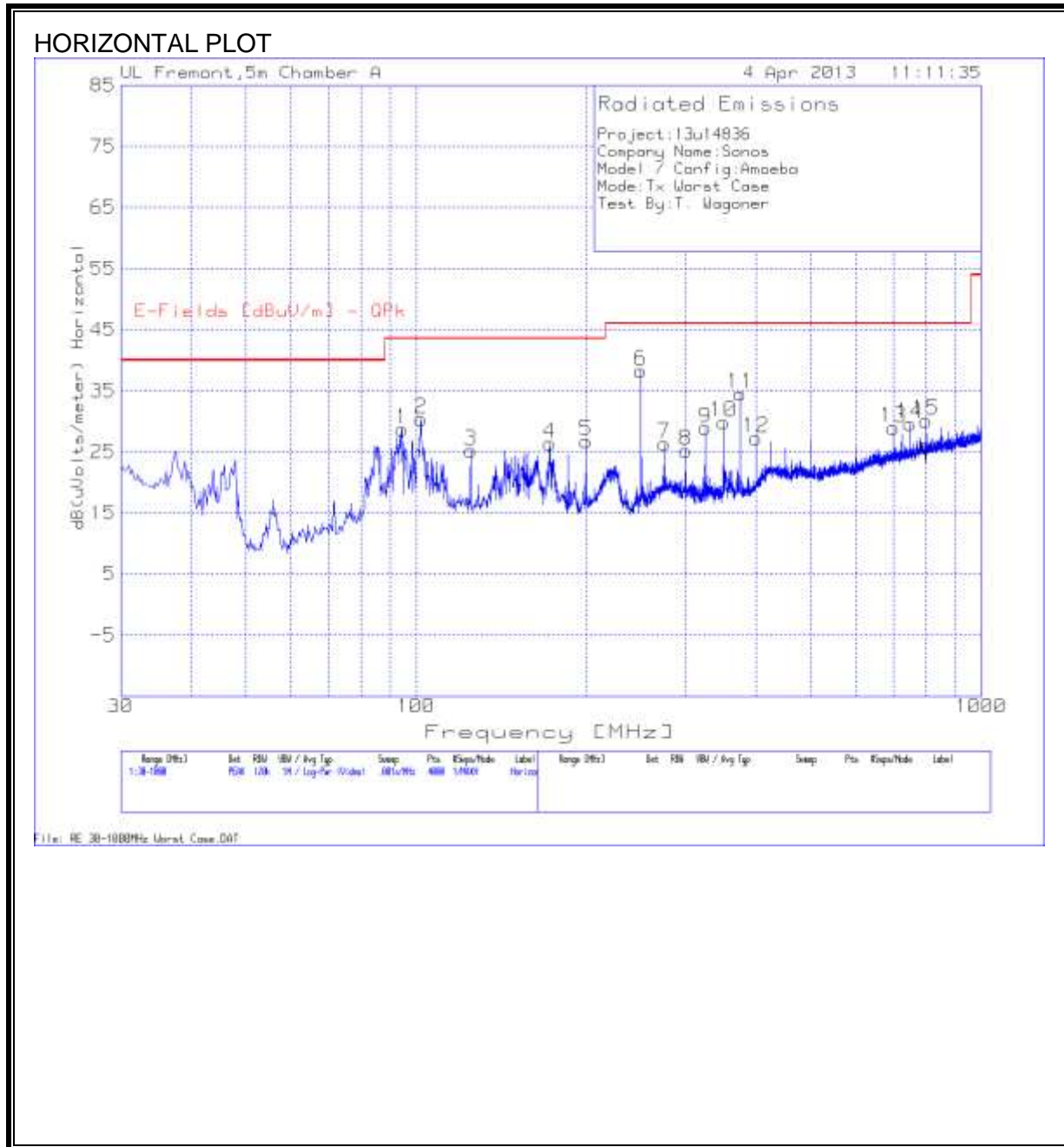

SPURIOUS EMISSIONS 30 TO 1000 MHz (WORST-CASE CONFIGURATION, VERTICAL)

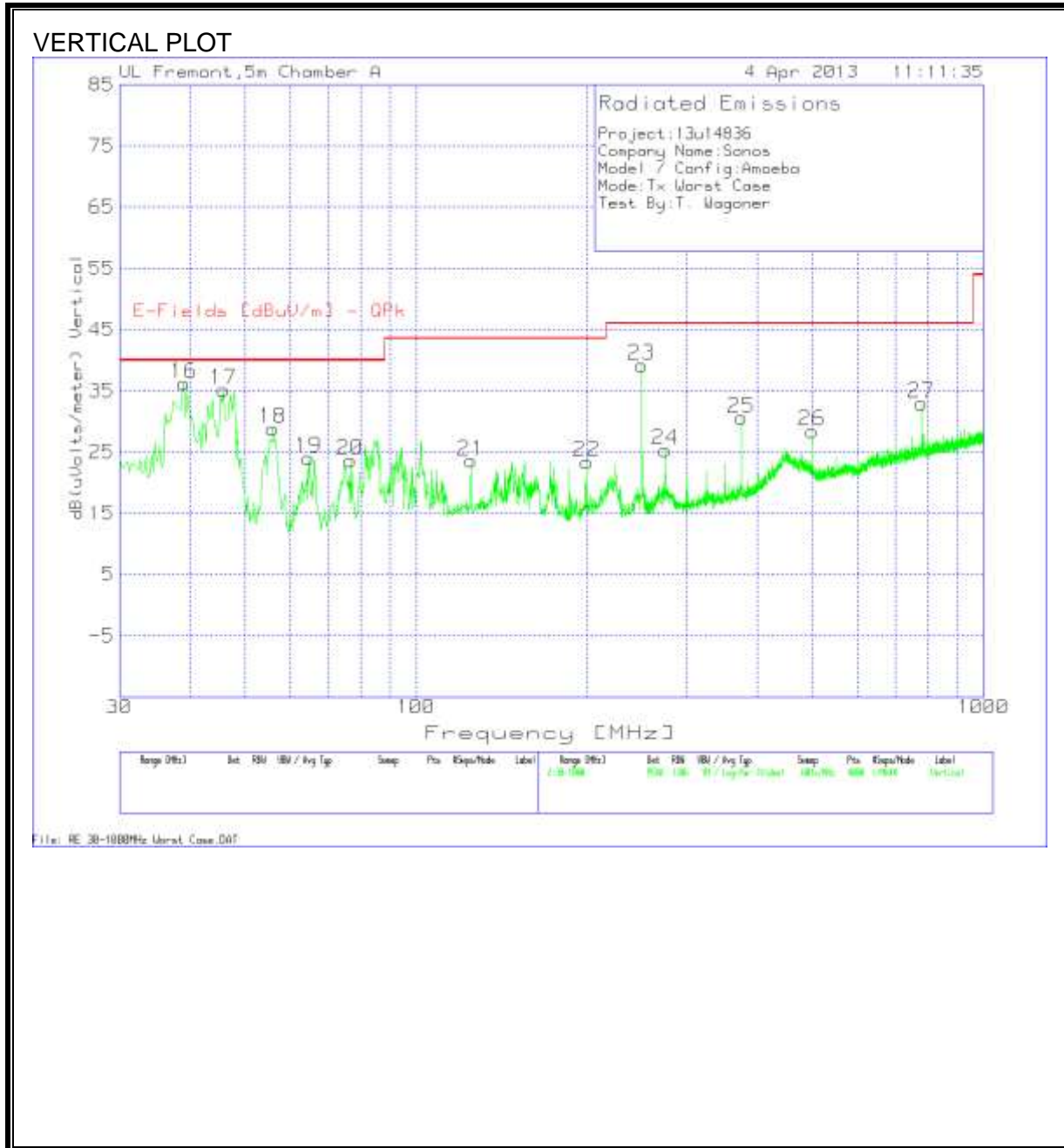

DATA

Project:	13u14836
Company Name:	Sonos
Model / Config:	Amoeba
Mode:	Tx Worst Case
Test By:	T. Wagoner

Marker No.	Test Frequency	Meter Reading	Detector	T185 Antenna Factor dB/m	T64 preamp/cable loss [dB]	dB(uVolts /meter)	E-Fields [dBuV/m] - QPk	Margin (dB)	Height [cm]	Polarity
1	94.4567	47.13	PK	8.6	-27	28.73	43.52	-14.79	300	Horz
2	101.9685	46.67	PK	10.6	-26.9	30.37	43.52	-13.15	300	Horz
3	124.9888	37.88	PK	14.2	-26.9	25.18	43.52	-18.34	200	Horz
4	172.7255	41.62	PK	11.3	-26.5	26.42	43.52	-17.1	200	Horz
5	199.8651	40.69	PK	12.3	-26.2	26.79	43.52	-16.73	200	Horz
6	249.7827	52.88	PK	11.5	-26.1	38.28	46.02	-7.74	100	Horz
7	274.9838	39.19	PK	13.3	-26.1	26.39	46.02	-19.63	100	Horz
8	299.9425	37.73	PK	13.3	-25.8	25.23	46.02	-20.79	100	Horz
9	324.9013	40.59	PK	13.9	-25.6	28.89	46.02	-17.13	100	Horz
10	350.1024	40.96	PK	14.3	-25.4	29.86	46.02	-16.16	100	Horz
11	375.0612	44.86	PK	15	-25.3	34.56	46.02	-11.46	100	Horz
12	400.02	37.08	PK	15.5	-25.3	27.28	46.02	-18.74	100	Horz
13	700.01	31.84	PK	20.1	-23	28.94	46.02	-17.08	100	Horz
14	749.9276	31.9	PK	20.6	-22.9	29.6	46.02	-16.42	200	Horz
15	800.0874	32.11	PK	21	-23	30.11	46.02	-15.91	100	Horz
16	38.9658	49.45	PK	14.3	-27.5	36.25	40	-3.75	200	Vert
17	45.7507	52.99	PK	9.7	-27.5	35.19	40	-4.81	200	Vert
18	55.9281	49.32	PK	6.9	-27.4	28.82	40	-11.18	200	Vert
19	64.6515	43.64	PK	7.7	-27.3	24.04	40	-15.96	200	Vert
20	76.5251	43.1	PK	7.9	-27.3	23.7	40	-16.3	200	Vert
21	124.9888	36.28	PK	14.2	-26.9	23.58	43.52	-19.94	200	Vert
22	199.8651	37.27	PK	12.3	-26.2	23.37	43.52	-20.15	200	Vert
23	249.7827	53.74	PK	11.5	-26.1	39.14	46.02	-6.88	200	Vert
24	274.9838	38.14	PK	13.3	-26.1	25.34	46.02	-20.68	200	Vert
25	375.0612	40.87	PK	15	-25.3	30.57	46.02	-15.45	200	Vert
26	499.8551	34.9	PK	17.9	-24.4	28.4	46.02	-17.62	300	Vert
27	779.4904	34.42	PK	21.2	-22.6	33.02	46.02	-13	400	Vert

PK - Peak detector

QP - Quasi-Peak detector

Av - Average detector

10. AC POWER LINE CONDUCTED EMISSIONS

LIMITS

FCC §15.207 (a)

RSS-Gen 7.2.2

Frequency of Emission (MHz)	Conducted Limit (dBuV)	
	Quasi-peak	Average
0.15-0.5	66 to 56*	56 to 46*
0.5-5	56	46
5-30	60	50

*Decreases with the logarithm of the frequency.

TEST PROCEDURE

The EUT is placed on a non-conducting table 40 cm from the vertical ground plane and 80 cm above the horizontal ground plane. The EUT is configured in accordance with ANSI C63.4.

The receiver is set to a resolution bandwidth of 9 kHz. Peak detection is used unless otherwise noted as quasi-peak or average.

Line conducted data is recorded for both NEUTRAL and HOT lines.

RESULTS

LINE 1 RESULTS

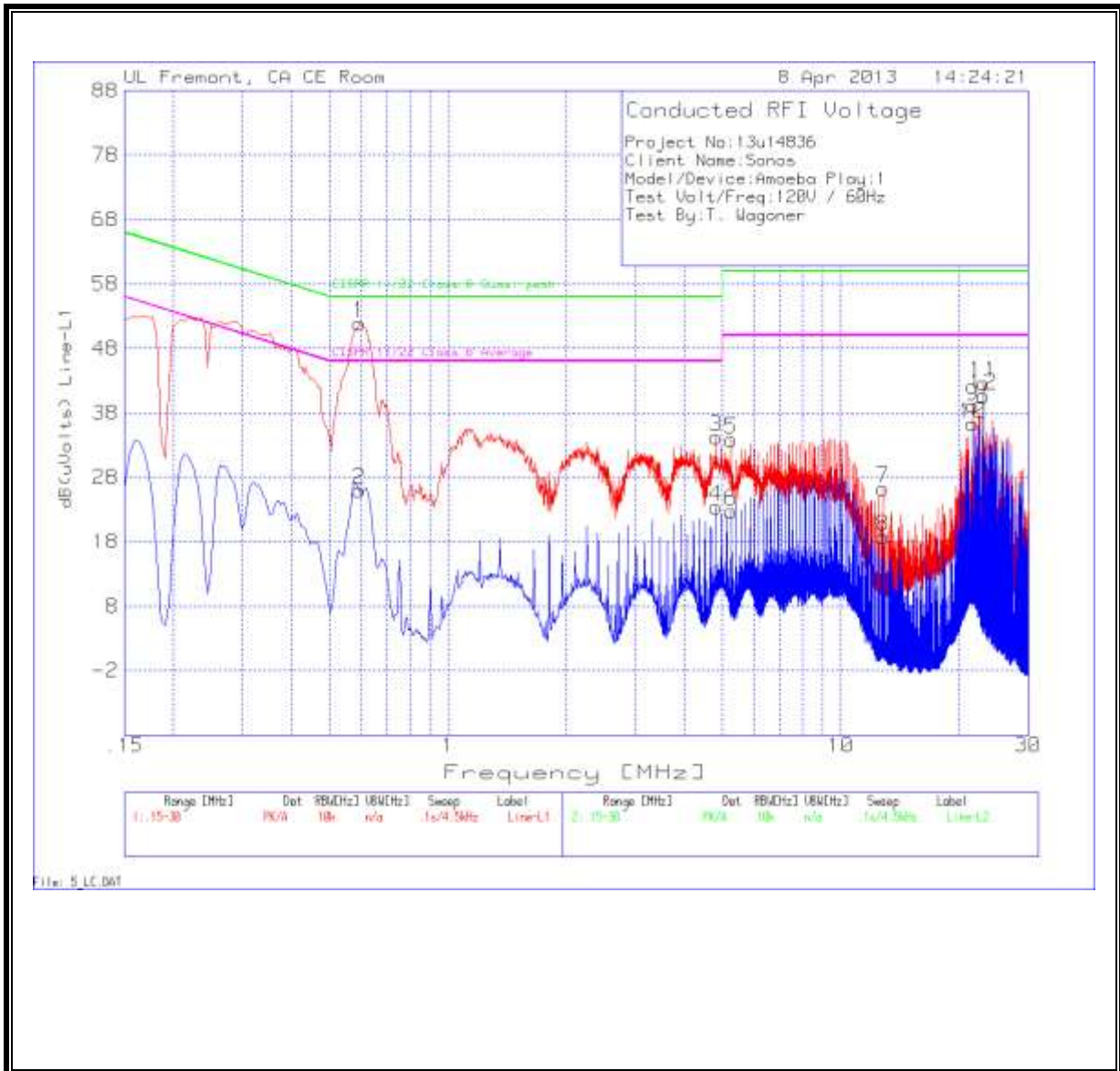

LINE 2 RESULTS

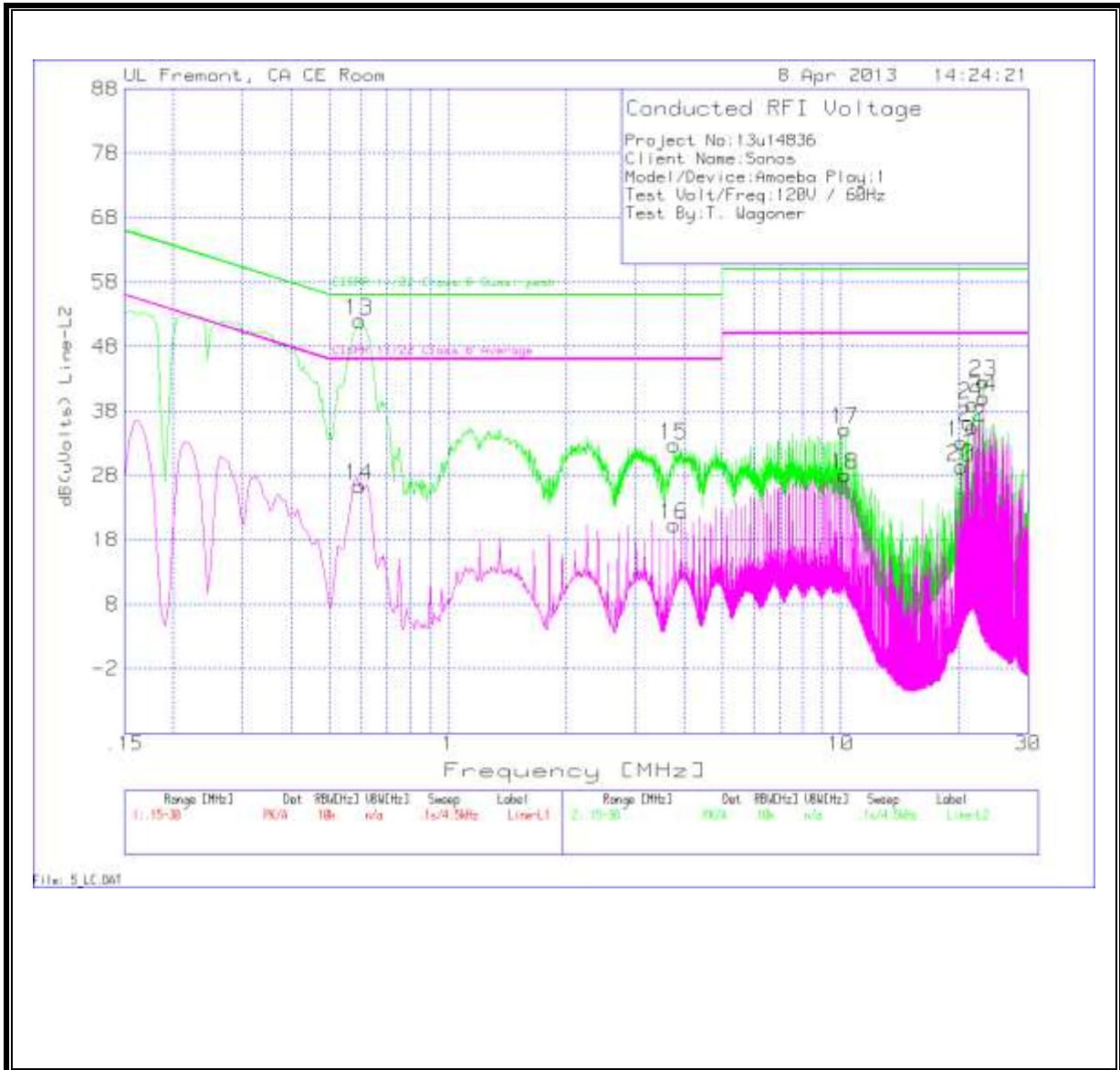

DATA

Project No:		13u14836							
Client Name:		Sonos							
Model/Device:		Amoeba Play:1							
Test Volt/Freq:		120V / 60Hz							
Test By:		T. Wagoner							
Line-L1 .15 - 30MHz									
Test Frequency	Meter Reading	Detector	T24 IL L1.TXT (dB)	LC Cables 1&3.TXT (dB)	dB(uVolts)	CISPR 11/22 Class B Quasi-peak	Margin	CISPR 11/22 Class B Average	Margin
0.5955	51.81	PK	0.1	0	51.91	56	-4.09	-	-
0.5955	25.92	Av	0.1	0	26.02	-	-	46	-19.98
4.821	34.07	PK	0.1	0.1	34.27	56	-21.73	-	-
4.821	23.17	Av	0.1	0.1	23.37	-	-	46	-22.63
5.271	33.67	PK	0.1	0.1	33.87	60	-26.13	-	-
5.271	22.59	Av	0.1	0.1	22.79	-	-	50	-27.21
12.8085	25.87	PK	0.2	0.2	26.27	60	-33.73	-	-
12.8085	18.35	Av	0.2	0.2	18.75	-	-	50	-31.25
21.6645	38.57	PK	0.3	0.2	39.07	60	-20.93	-	-
21.6645	35.74	Av	0.3	0.2	36.24	-	-	50	-13.76
23.1315	42.06	PK	0.4	0.2	42.66	60	-17.34	-	-
23.1315	40.04	Av	0.4	0.2	40.64	-	-	50	-9.36
Line-L2 .15 - 30MHz									
0.5955	51.91	PK	0.1	0	52.01	56	-3.99	-	-
0.5955	26.27	Av	0.1	0	26.37	-	-	46	-19.63
3.768	32.44	PK	0.1	0.1	32.64	56	-23.36	-	-
3.768	20.06	Av	0.1	0.1	20.26	-	-	46	-25.74
10.2435	34.79	PK	0.1	0.2	35.09	60	-24.91	-	-
10.2435	27.76	Av	0.1	0.2	28.06	-	-	50	-21.94
20.2605	32.56	PK	0.3	0.2	33.06	60	-26.94	-	-
20.2605	28.8	Av	0.3	0.2	29.3	-	-	50	-20.7
21.6645	38.46	PK	0.3	0.2	38.96	60	-21.04	-	-
21.6645	34.97	Av	0.3	0.2	35.47	-	-	50	-14.53
23.1315	41.85	PK	0.4	0.2	42.45	60	-17.55	-	-
23.1315	39.4	Av	0.4	0.2	40	-	-	50	-10
PK - Peak detector									
Av - Average detector									

11. DYNAMIC FREQUENCY SELECTION

11.1. OVERVIEW

11.1.1. LIMITS

INDUSTRY CANADA

IC RSS-210 is closely harmonized with FCC Part 15 DFS rules. The deviations are as follows:

RSS-210 Issue 7 A9.4 (b) (ii) **Channel Availability Check Time:** ...

Additional requirements for the band 5600-5650 MHz: Until further notice, devices subject to this Section shall not be capable of transmitting in the band 5600-5650 MHz, so that Environment Canada weather radars operating in this band are protected.

RSS-210 Issue 7 A9.4 (b) (iv) **Channel closing time:** the maximum channel closing time is 260 ms.

FCC

§15.407 (h) and FCC 06-96 APPENDIX "COMPLIANCE MEASUREMENT PROCEDURES FOR UNLICENSED-NATIONAL INFORMATION INFRASTRUCTURE DEVCIES OPERATING IN THE 5250-5350 MHz AND 5470-5725 MHz BANDS INCORPORATING DYNAMIC FREQUENCY SELECTION".

Table 1: Applicability of DFS requirements prior to use of a channel

Requirement	Operational Mode		
	Master	Client (without radar detection)	Client (with radar detection)
Non-Occupancy Period	Yes	Not required	Yes
DFS Detection Threshold	Yes	Not required	Yes
Channel Availability Check Time	Yes	Not required	Not required
Uniform Spreading	Yes	Not required	Not required

Table 2: Applicability of DFS requirements during normal operation

Requirement	Operational Mode		
	Master	Client (without DFS)	Client (with DFS)
DFS Detection Threshold	Yes	Not required	Yes
Channel Closing Transmission Time	Yes	Yes	Yes
Channel Move Time	Yes	Yes	Yes

Table 3: Interference Threshold values, Master or Client incorporating In-Service Monitoring

Maximum Transmit Power	Value (see note)
≥ 200 milliwatt	-64 dBm
< 200 milliwatt	-62 dBm

Note 1: This is the level at the input of the receiver assuming a 0 dBi receive antenna
 Note 2: Throughout these test procedures an additional 1 dB has been added to the amplitude of the test transmission waveforms to account for variations in measurement equipment. This will ensure that the test signal is at or above the detection threshold level to trigger a DFS response.

Table 4: DFS Response requirement values

Parameter	Value
<i>Non-occupancy period</i>	30 minutes
<i>Channel Availability Check Time</i>	60 seconds
<i>Channel Move Time</i>	10 seconds
<i>Channel Closing Transmission Time</i>	200 milliseconds + approx. 60 milliseconds over remaining 10 second period

The instant that the *Channel Move Time* and the *Channel Closing Transmission Time* begins is as follows:
 For the Short pulse radar Test Signals this instant is the end of the *Burst*.
 For the Frequency Hopping radar Test Signal, this instant is the end of the last radar burst generated.
 For the Long Pulse radar Test Signal this instant is the end of the 12 second period defining the radar transmission.
 The Channel Closing Transmission Time is comprised of 200 milliseconds starting at the beginning of the Channel Move Time plus any additional intermittent control signals required to facilitate channel changes (an aggregate of approximately 60 milliseconds) during the remainder of the 10 second period. The aggregate duration of control signals will not count quiet periods in between transmissions.

Table 5 – Short Pulse Radar Test Waveforms

Radar Type	Pulse Width (Microseconds)	PRI (Microseconds)	Pulses	Minimum Percentage of Successful Detection	Minimum Trials
1	1	1428	18	60%	30
2	1-5	150-230	23-29	60%	30
3	6-10	200-500	16-18	60%	30
4	11-20	200-500	12-16	60%	30
Aggregate (Radar Types 1-4)				80%	120

Table 6 – Long Pulse Radar Test Signal

Radar Waveform	Bursts	Pulses per Burst	Pulse Width (µsec)	Chirp Width (MHz)	PRI (µsec)	Minimum Percentage of Successful Detection	Minimum Trials
5	8-20	1-3	50-100	5-20	1000-2000	80%	30

Table 7 – Frequency Hopping Radar Test Signal

Radar Waveform	Pulse Width (µsec)	PRI (µsec)	Burst Length (ms)	Pulses per Hop	Hopping Rate (kHz)	Minimum Percentage of Successful Detection	Minimum Trials
6	1	333	300	9	.333	70%	30

11.1.2. TEST AND MEASUREMENT SYSTEM

RADIATED METHOD SYSTEM BLOCK DIAGRAM

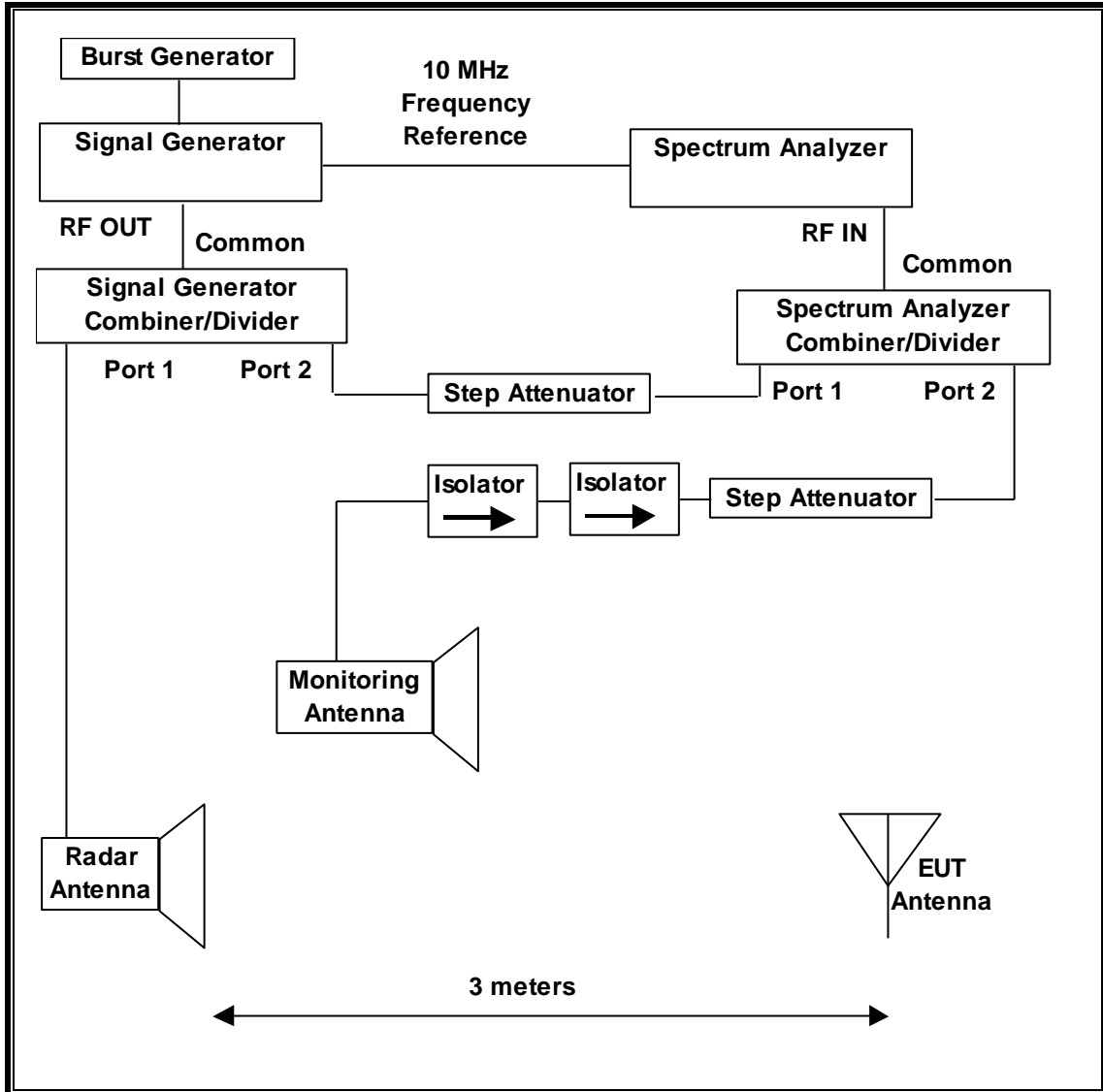

SYSTEM OVERVIEW

The short pulse and long pulse signal generating system utilizes the NTIA software. The Vector Signal Generator has been validated by the NTIA. The hopping signal generating system utilizes the CCS simulated hopping method and system, which has been validated by the DoD, FCC and NTIA. The software selects waveform parameters from within the bounds of the signal type on a random basis using uniform distribution.

The short pulse types 2, 3 and 4, and the long pulse type 5 parameters are randomized at run-time.

The hopping type 6 pulse parameters are fixed while the hopping sequence is based on the August 2005 NTIA Hopping Frequency List. The initial starting point randomized at run-time and each subsequent starting point is incremented by 475. Each frequency in the 100-length segment is compared to the boundaries of the EUT Detection Bandwidth and the software creates a hopping burst pattern in accordance with Section 7.4.1.3 Method #2 Simulated Frequency Hopping Radar Waveform Generating Subsystem of FCC 06-96 APPENDIX. The frequency of the signal generator is incremented in 1 MHz steps from F_L to F_H for each successive trial. This incremental sequence is repeated as required to generate a minimum of 30 total trials and to maintain a uniform frequency distribution over the entire Detection Bandwidth.

The signal monitoring equipment consists of a spectrum analyzer. The aggregate ON time is calculated by multiplying the number of bins above a threshold during a particular observation period by the dwell time per bin, with the analyzer set to peak detection and max hold.

SYSTEM CALIBRATION

A 50-ohm load is connected in place of the spectrum analyzer, and the spectrum analyzer is connected to a horn antenna via a coaxial cable, with the reference level offset set to (horn antenna gain – coaxial cable loss). The signal generator is set to CW mode. The amplitude of the signal generator is adjusted to yield a level of –64 dBm as measured on the spectrum analyzer.

Without changing any of the instrument settings, the spectrum analyzer is reconnected to the Common port of the Spectrum Analyzer Combiner/Divider. The Reference Level Offset of the spectrum analyzer is adjusted so that the displayed amplitude of the signal is –64 dBm.

The spectrum analyzer displays the level of the signal generator as received at the antenna ports of the Master Device. The interference detection threshold may be varied from the calibrated value of –64 dBm and the spectrum analyzer will still indicate the level as received by the Master Device.

ADJUSTMENT OF DISPLAYED TRAFFIC LEVEL

A link is established between the Master and Slave and the distance between the units is adjusted as needed to provide a suitable received level at the Master and Slave devices. The video test file is streamed to generate WLAN traffic. The monitoring antenna is adjusted so that the WLAN traffic level, as displayed on the spectrum analyzer, is at lower amplitude than the radar detection threshold.

TEST AND MEASUREMENT EQUIPMENT

The following test and measurement equipment was utilized for the DFS tests documented in this report:

TEST EQUIPMENT LIST				
Description	Manufacturer	Model	Asset Number	Cal Due
Spectrum Analyzer, 26.5 GHz	Agilent / HP	E4440A	C01178	8/18/2013
Vector Signal Generator, 20GHz	Agilent / HP	E8267C	C01066	11/20/2013

11.1.3. SETUP OF EUT

RADIATED METHOD EUT TEST SETUP

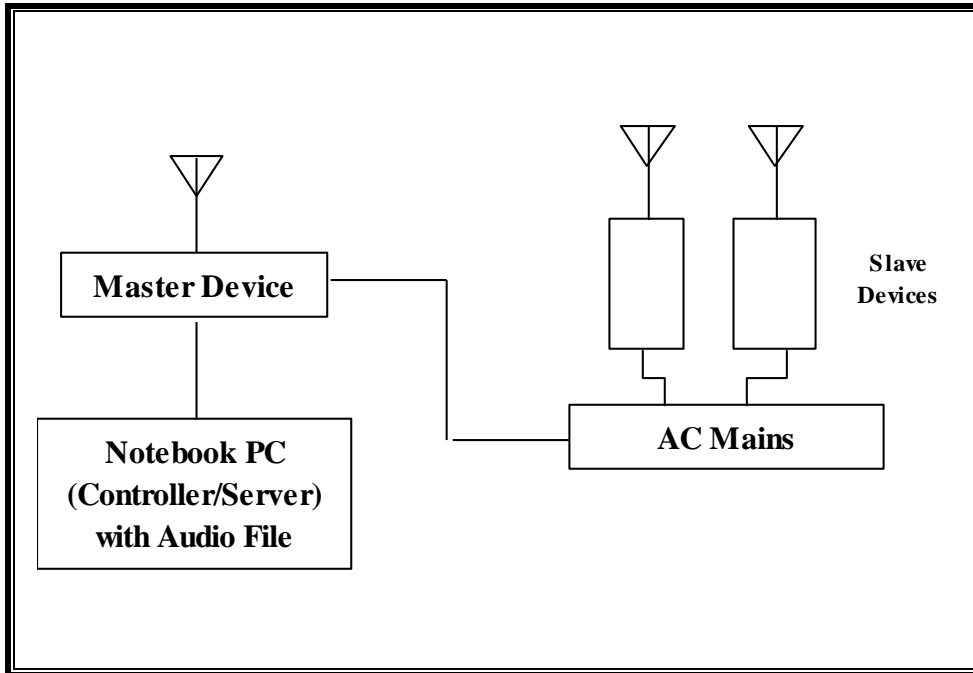

SUPPORT EQUIPMENT

The following support equipment was utilized for the DFS tests documented in this report:

PERIPHERAL SUPPORT EQUIPMENT LIST				
Description	Manufacturer	Model	Serial Number	FCC ID
Wireless Sound Bar (Master Device)	Sonos, Inc.	Playbar	1301 00-0E58-B0-82-6C-9	SBVRM006
Notebook PC (Controller/Server)	Dell	P05G	9NGRWN1	DoC
AC Adapter (Controller/Server PC)	Lite On Technology	PA-1650-02DD	CN-0928G4-72538-07F-16F1-A00	DoC
Cable/DSL Router with 8-Port Switch	Linksys	BEFSR31 ver. 3	C2220E202195	DoC
AC Adapter (Router)	Linksys	AM-1201000D41	CYD05032	DoC

11.1.4. DESCRIPTION OF EUT

The EUT operates over the 5250-5350 MHz and 5470-5725 MHz ranges.

The EUT is a pair of Slave Device without Radar Detection.

The highest power level within these bands is 24.99 dBm EIRP in the 5250-5350 MHz band and 24.90 dBm EIRP in the 5470-5725 MHz band.

The only antenna assembly consists of 2 antennas with individual gains of 3.59 dBi and 3.29 dBi in the 5000 MHz band.

Two antennas are utilized to meet the diversity and MIMO operational requirements.

The rated output power of the Master unit is > 23dBm (EIRP). Therefore the required interference threshold level is -64 dBm. After correction for procedural adjustments, the required radiated threshold at the antenna port is $-64 + 1 = -63$ dBm.

The calibrated radiated DFS Detection Threshold level is set to -64 dBm. The tested level is lower than the required level hence it provides margin to the limit.

The EUT uses two transmitter/receiver chains, each connected to an antenna to perform radiated tests.

WLAN traffic was generated by streaming the NTIA audio test file from the Master to the Slave using Sonos Desktop Controller version 4.2 media player.

TPC is not required since the maximum EIRP is less than 500 mW (27 dBm).

The EUT utilizes the 802.11a/n architecture. One nominal channel bandwidth, 20 MHz, is implemented.

The software installed in the access point is revision 4.2.

UNIFORM CHANNEL SPREADING

This requirement is not applicable to Slave radio devices.

OVERVIEW OF MASTER DEVICE WITH RESPECT TO §15.407 (h) REQUIREMENTS

The Master Device is a Sonos Playbar, FCC ID: SBVRM006. The minimum antenna gain for the Master Device is 4.1 dBi.

The rated output power of the Master unit is $> 23\text{dBm}$ (EIRP). Therefore the required interference threshold level is -64 dBm . After correction for procedural adjustments, the required radiated threshold at the antenna port is $-64 + 1 = -63\text{ dBm}$.

The calibrated radiated DFS Detection Threshold level is set to -64 dBm . The tested level is lower than the required level hence it provides margin to the limit.

11.2. RESULTS FOR 20 MHz BANDWIDTH

11.2.1. TEST CHANNEL

All tests were performed at a channel center frequency of 5540 MHz.

11.2.2. RADAR WAVEFORM AND TRAFFIC

RADAR WAVEFORM

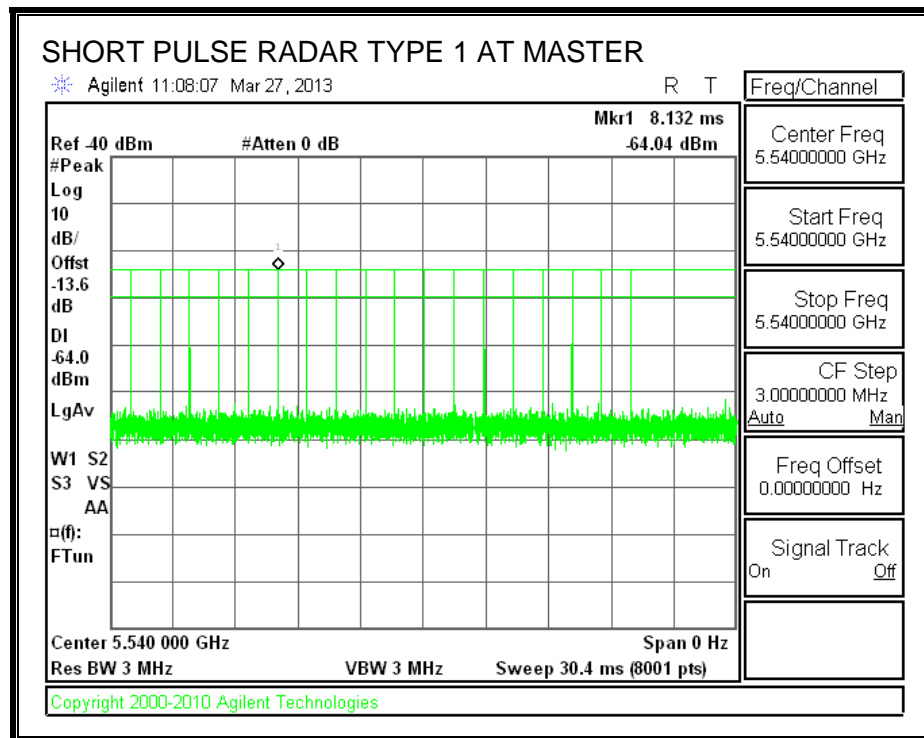

TRAFFIC

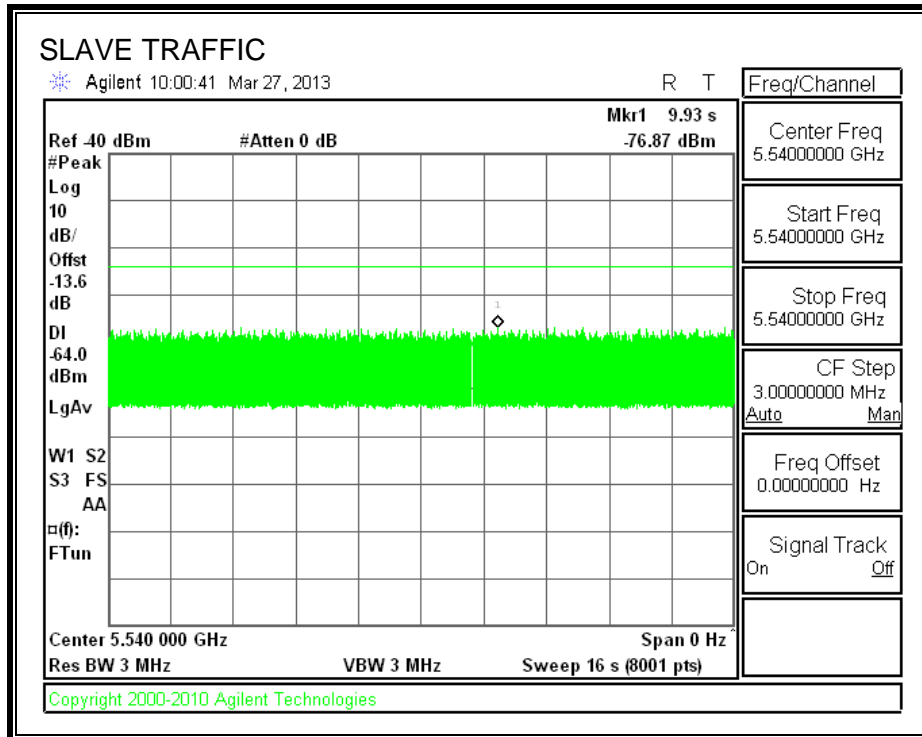

11.2.3. OVERLAPPING CHANNEL TESTS

RESULTS

These tests are not applicable.

11.2.4. MOVE AND CLOSING TIME

REPORTING NOTES

The reference marker is set at the end of last radar pulse.

The delta marker is set at the end of the last WLAN transmission following the radar pulse. This delta is the channel move time.

The aggregate channel closing transmission time is calculated as follows:

Aggregate Transmission Time =
 (Number of analyzer bins showing transmission) * (dwell time per bin)

The observation period over which the FCC aggregate time is calculated begins at (Reference Marker + 200 msec) and ends no earlier than (Reference Marker + 10 sec).

The observation period over which the IC aggregate time is calculated begins at (Reference Marker) and ends no earlier than (Reference Marker + 10 sec).

RESULTS

Agency	Channel Move Time (sec)	Limit (sec)
FCC / IC	0.000	10

Agency	Aggregate Channel Closing Transmission Time (msec)	Limit (msec)
FCC	0.0	60
IC	0.0	260

MOVE TIME

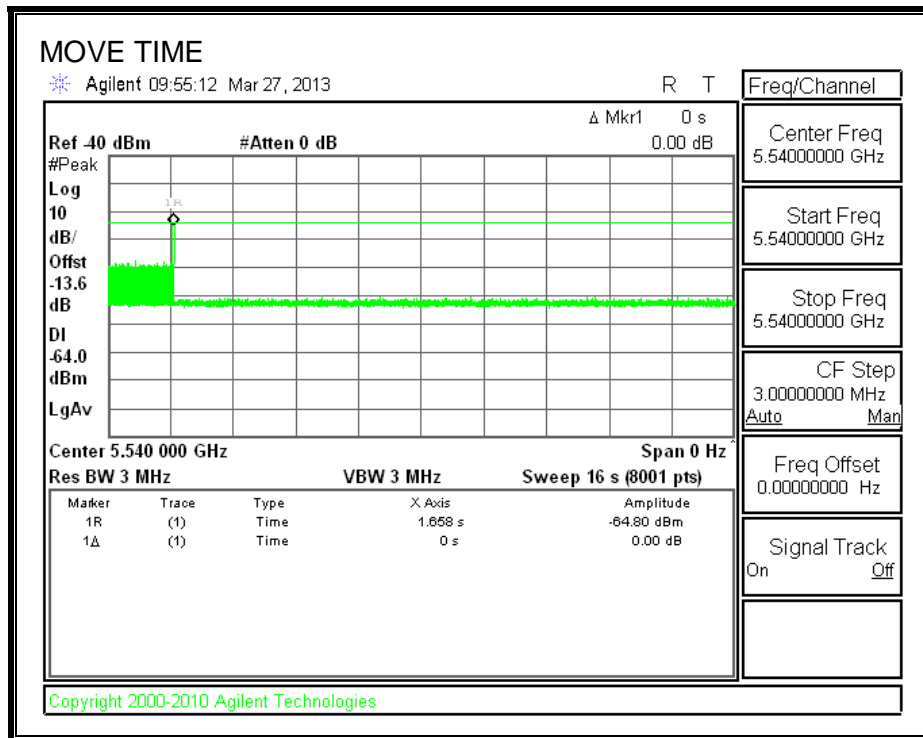

CHANNEL CLOSING TIME

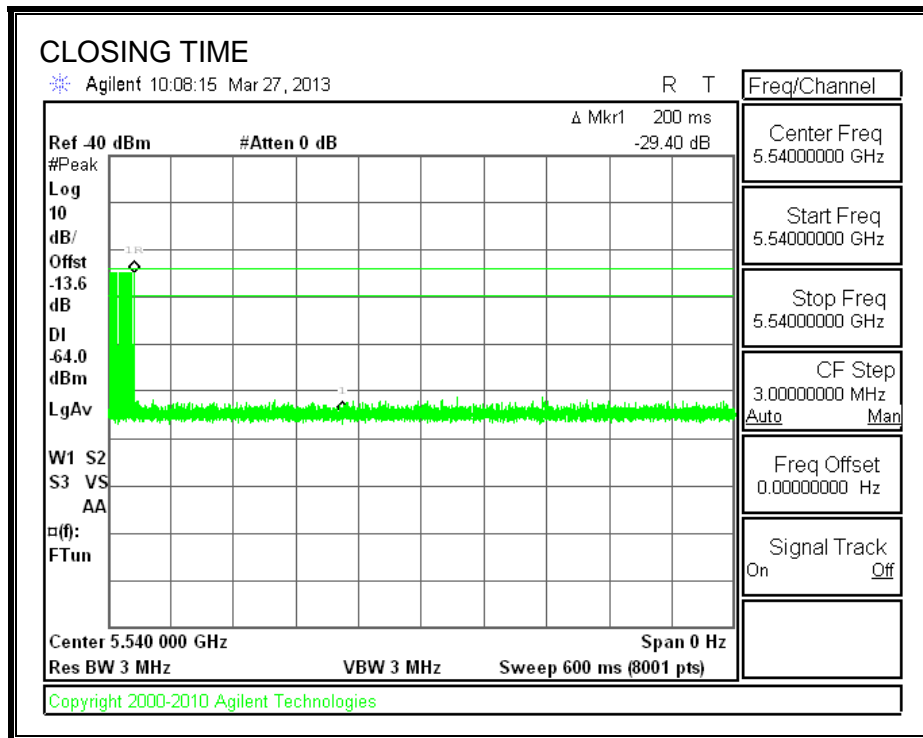

AGGREGATE CHANNEL CLOSING TRANSMISSION TIME

No transmissions are observed during the FCC aggregate monitoring period.

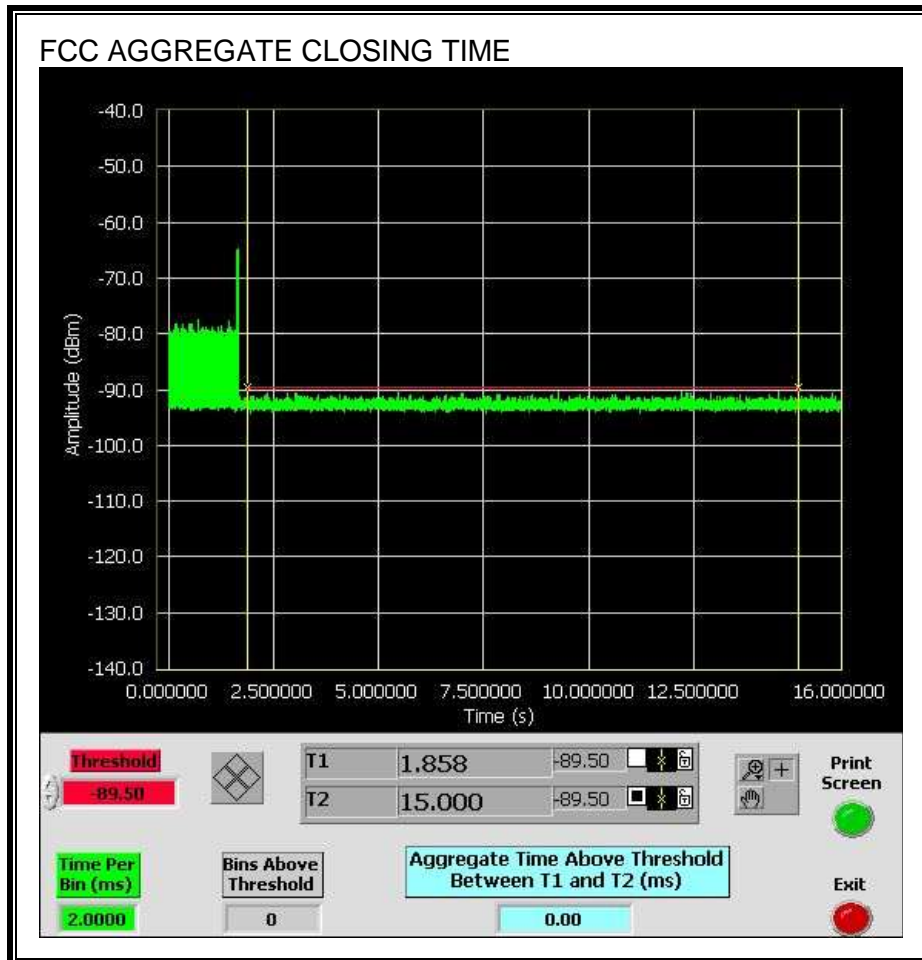

No transmissions are observed during the IC aggregate monitoring period.

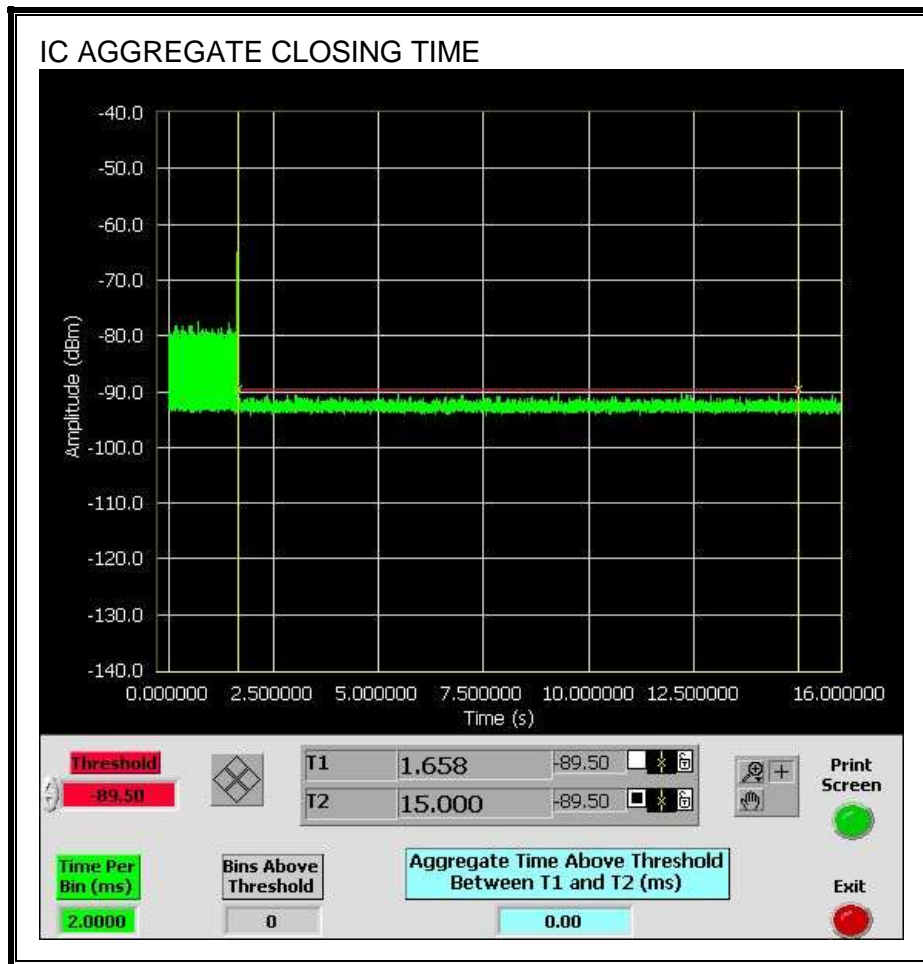

11.2.5. NON-OCCUPANCY PERIOD

RESULTS

No EUT transmissions were observed on the test channel during the 30 minute observation time.

