

TEST REPORT FOR WLAN TESTING

Report No.: SRTC2022-9004(F)-22052801(G)

Product Name: BT/Wi-Fi Module

Product Model: MWH516B

Applicant: Qingdao Hisense Communication Co., Ltd

Manufacturer: Qingdao Hisense Communication Co., Ltd

Specification: FCC Part 15 Subpart E (2021)

ANSI C63.10 (2013)

FCC ID: SARMWH516B

The State Radio_monitoring_center Testing Center (SRTC)

15th Building, No.30 Shixing Street, Shijingshan District, Beijing, P.R.China

Tel: 86-10-57996183 Fax: 86-10-5799638

CONTENTS

1. GENERAL INFORMATION	2
1.1 Notes of the test report.....	2
1.2 Information about the testing laboratory	2
1.3 Applicant’s details.....	2
1.4 Manufacturer’s details.....	2
1.5 Test Environment	2
2. DESCRIPTION OF THE DEVICE UNDER TEST	3
2.1 Final Equipment Build Status.....	3
2.2 Wireless Technology and Frequency Range.....	4
2.3 Support Equipment	4
2.4 Note	5
3 REFERENCE SPECIFICATION	6
4 KEY TO NOTES AND RESULT CODES	6
5. RESULT SUMMARY	7
6 TEST RESULT.....	8
6.1 26dB Bandwidth.....	8
6.2 6dB Bandwidth(Only for 5.725 – 5.850GHz band).....	9
6.3 Maximum Conducted Output Power.....	10
6.4 Maximum Power Spectral Density.....	11
6.5 Frequency Stability.....	12
6.6 Unwanted Radiated Emission Measurement.....	13
6.7 AC Power line Conducted Emission.....	17
6.8 Dynamic Frequency Selection.....	17
7 MEASUREMENT UNCERTAINTIES	24
8 TEST EQUIPMENTS	25
APPENDIX A – TEST DATA OF CONDUCTED EMISSION	25
APPENDIX B – TEST DATA OF RADIATED EMISSION	25

1. GENERAL INFORMATION

1.1 Notes of the test report

The test report may only be reproduced or published in full. Reproduction or publication of extracts from the report requires the prior written permission of The State Radio_monitoring_center Testing Center (SRTC). The test results relate only to individual items of the samples which have been tested. The certification and accreditation identifiers used in this report shall not be applicable to the tested or calibrated samples thereof. The manufacturer shall not mark the tested samples or items (or a separate part of the item) with the identifiers of certification and accreditation to mislead relevant parties about the tested samples or items.

1.2 Information about the testing laboratory

Company:	The State Radio_monitoring_center Testing Center (SRTC)
Address:	15th Building, No.30 Shixing Street, Shijingshan District, P.R.China
City:	Beijing
Country or Region:	P.R.China
Contacted person:	Liu Jia
Tel:	+86 10 57996183
Fax:	+86 10 57996388
Email:	liujiaf@srtc.org.cn
Designation Number:	CN1267
Registration number:	239125

1.3 Applicant's details

Company:	Qingdao Hisense Communication Co., Ltd
Address:	No.218, Qianwangang Road, Economic and Technological Development Zone, Qingdao, Shandong Province,China

1.4 Manufacturer's details

Company:	Qingdao Hisense Communication Co., Ltd
Address:	218 Qianwangang Road, Qingdao Economic& Technological Development Zone, Qingdao, China

1.5 Test Environment

Date of Receipt of test sample at SRTC:	2022-05-28
Testing Start Date:	2022-05-29
Testing End Date:	2022-06-16

Environmental Data:	Temperature (°C)	Humidity (%)
Ambient:	25	40
Maximum Extreme:	70	---
Minimum Extreme:	-10	---

Normal Supply Voltage (V d.c.):	5.00
Maximum Extreme Supply Voltage (V d.c.):	5.25
Minimum Extreme Supply Voltage (V d.c.):	4.75

2. DESCRIPTION OF THE DEVICE UNDER TEST

2.1 Final Equipment Build Status

Frequency Band(s):	U-NII-1:5150MHz-5250MHz U-NII-2A:5250MHz-5350MHz U-NII-2C:5470MHz-5725MHz U-NII-3:5725MHz-5850MHz	
The DFS related operating mode(s) of the equipment:	<input type="checkbox"/>	Master
	<input type="checkbox"/>	Slave with radar detection
	<input checked="" type="checkbox"/>	Slave without radar detection
Modulation Type:	802.11a 802.11n (HT20/HT40) 802.11ac (VHT20/VHT40/VHT80)	
Beamforming Directional Gain:	N/A	
Power Supply	DC supply	
Software Revision:	NA	
Hardware Revision:	V3.00	
SN:	#1	

2.2 Wireless Technology and Frequency Range

Wireless Technology		Bandwidth	Channel	Frequency(MHz)
Wi-Fi	U-NII-1	20MHz	36	5180
			40	5200
			44	5220
			48	5240
		40MHz	38	5190
			46	5230
	80MHz	42	5210	
	U-NII-2A	20MHz	52	5260
			56	5280
			60	5300
			64	5320
		40MHz	54	5270
			62	5310
	80MHz	58	5290	
	U-NII-2C	20MHz	100	5500
			104	5520
			108	5540
			112	5560
			116	5580
			120	5600
			124	5620
			128	5640
			132	5660
			136	5680
			140	5700
			144	5720
		40MHz	102	5510
			110	5550
			118	5590
			126	5630
			134	5670
			142	5710
		80MHz	106	5530
			122	5610
			138	5690
			149	5745
153			5765	
157			5785	
U-NII-3	20MHz	161	5805	
		165	5825	
		151	5755	
		159	5795	
	40MHz	155	5775	

2.3 Support Equipment

The following support equipment was used to exercise the DUT during testing:N/A

2.4 Note

Automatically Discontinue Transmission

Description	The device shall automatically discontinue transmission in case of either absence of information to transmit or operational failure. These provisions are not intended to preclude the transmission of control or signaling information or the use of repetitive codes used by certain digital technologies to complete frame or burst intervals. Applicants shall include in their application for equipment authorization to describe how this requirement is met.
Result	While the EUT is not transmitting any information, the EUT can automatically discontinue transmission and become standby mode for power saving. The EUT can detect the controlling signal of ACK message transmitting from remote device and verify whether it shall resend or discontinue transmission.

Antenna requirement (FCC part 15.203)

An intentional radiator antenna shall be designed to ensure that no antenna other than that furnished by the responsible party can be used with the device. The use of a permanently attached antenna or of an antenna that uses a unique coupling to the intentional radiator shall be considered sufficient to comply with the provisions of this section.

- The antenna(s) of the EUT are permanently attached.
- There are no provisions for connection to an external antenna.

Note: The antenna provides to the EUT, please refer to the following table:

Brand	Model	Antenna gain	Frequency Bands (GHz)	Antenna type	Connector Type
N/A	N/A	0.5dBi(max)	5150MHz-5250MHz 5250MHz-5350MHz 5470MHz-5725MHz 5725MHz-5850MHz	PCB Antenna	N/A

Manufacturers ensure that their designs will not be modified by the user or third party's arbitrary antenna parameters and performance. The EUT complies with the requirement of §15.203.

3 REFERENCE SPECIFICATION

Specification	Version	Title
FCC part 15 Subpart E	2021	Unlicensed national information infrastructure devices
ANSI C63.10	2013	Standard of Procedures for Compliance Testing of Unlicensed Wireless Devices
KDB 644545 D03	August 14, 2014	Guidance for IEEE std 802.11actm devices emission testing
KDB 905462 D03	August 22, 2016	U-NII client devices without radar detection capability
KDB 905462 D02	April 8, 2016	Compliance measurement procedures for unlicensed-national information infrastructure devices operating in the 5250-5350 MHz and 5470-5725 MHz bands incorporating dynamic frequency selection
KDB 662911 D01	October 31, 2013	Emissions testing of transmitters with multiple outputs in the same band
KDB 789033 D02	December 14, 2017	Guidelines for compliance testing of unlicensed national information infrastructure (U-NII) devices part 15, subpart e



4 KEY TO NOTES AND RESULT CODES

The following are the definition of the test result.

Code	Meaning
PASS	Test result shows that the requirements of the relevant specification have been met.
FAIL	Test result shows that the requirements of the relevant specification have not been met.
NT	Normal Temperature
NV	Nominal voltage
HV	High voltage
LV	Low voltage

5. RESULT SUMMARY

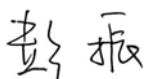
No.	Test case	FCC reference	Verdict
1.	26dB Bandwidth	N/A	Pass
2.	Maximum Conducted Output Power	15.407 (a.1.iv),(a.2), (a.3)	Pass
3.	Maximum Power Spectral Density	15.407 (a.1.iv),(a.2), (a.3)	Pass
4.	Frequency Stability	15.407(g)	Pass
5.	Unwanted Radiated Emission Measurement	15.205 15.209 15.35(b)	Pass
6.	AC Power line Conducted Emission	15.207	Pass
7.	DFS	15.407(h)	Pass
8.	Automatically Discontinue Transmission	15.407(c)	Pass (See 2.4Note)
9.	Antenna Requirements	15.407(a) &15.203	Pass (See 2.4Note)

This Test Report Is Issued by: Mr. Peng Zhen 	Checked by: Mr. Li Bin 
Tested by: Mr. Liu Ce 	Issued date: 20220617

6 TEST RESULT

6.1 26dB Bandwidth

6.1.1 Test limit

The bandwidth at 26dB down from the highest in-band spectral density is measured with a spectrum analyzer connected to the antenna terminal while the EUT is operating at its maximum duty cycle, at its maximum power control level, as defined in ANSI C63.10-2013 and KDB 789033 D02 v02r01, and at the appropriate frequencies. The spectrum analyzer's bandwidth measurement function is configured to measure the 26dB bandwidth.

The 26dB bandwidth is used to determine the conducted power limits.

6.1.2 Test Procedure Used

ANSI C63.10-2013 – Section 12.4

KDB 789033 D02 v02r01 – Section C

6.1.3 Test Settings

1. The signal analyzers' automatic bandwidth measurement capability was used to perform the 26dB bandwidth measurement. The "X" dB bandwidth parameter was set to $X = 26$. The automatic bandwidth measurement function also has the capability of simultaneously measuring the 99% occupied bandwidth. The bandwidth measurement was not influenced by any intermediate power nulls in the fundamental emission.

2. RBW = approximately 1% of the emission bandwidth

3. VBW > 3 x RBW

4. Detector = Peak

5. Trace mode = max hold

6.1.4 Test Setup

The EUT and measurement equipment were set up as shown in the diagram below.

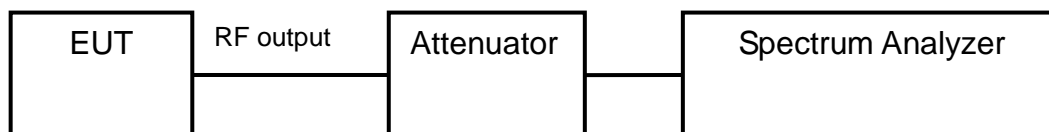

6.1.5 Test result

The test results are shown in Appendix A.

6.2 6dB Bandwidth(Only for 5.725 – 5.850GHz band)

6.2.1 Test limit

In the 5.725 – 5.850GHz band, the 6dB bandwidth must be ≥ 500 kHz.

6.2.2 Test Procedure Used

ANSI C63.10-2013 – Section 6.9.2

KDB 789033 D02 v02r01 – Section C

6.2.3 Test Settings

1. The signal analyzers' automatic bandwidth measurement capability was used to perform the 6dB bandwidth measurement. The "X" dB bandwidth parameter was set to $X = 6$. The automatic bandwidth measurement function also has the capability of simultaneously measuring the 99% occupied bandwidth. The bandwidth measurement was not influenced by any intermediate power nulls in the fundamental emission.

2. RBW = 100 kHz

3. VBW > 3 x RBW

4. Detector = Peak

5. Trace mode = max hold

6. Sweep = auto couple

6.2.4 Test Setup

The EUT and measurement equipment were set up as shown in the diagram below.

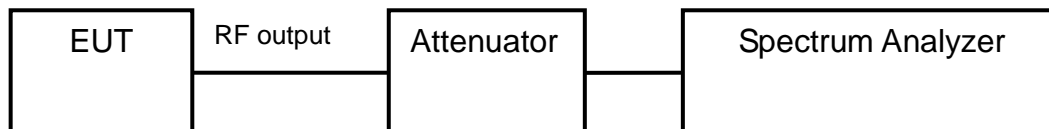

6.2.5 Test result

The test results are shown in Appendix A.

6.3 Maximum Conducted Output Power

6.3.1 Test limit

In the 5.15 – 5.25GHz band, the maximum permissible conducted output power is 250mW (23.98dBm). The maximum e.i.r.p. shall not exceed the lesser of 200 mW or $10 + 10 \log_{10} B$, dBm.

In the 5.25 – 5.35GHz band, the maximum permissible conducted output power is the lesser of 250mW (23.98dBm) and $11 \text{ dBm} + 10 \log_{10} B$ (26dB BW). The maximum e.i.r.p. shall not exceed the lesser of 1.0 W or $17 + 10 \log_{10} B$, dBm.

In the 5.47 – 5.725GHz band, the maximum permissible conducted output power is the lesser of 250mW (23.98dBm) and $11 \text{ dBm} + 10 \log_{10} B$ (26dB BW). The maximum e.i.r.p. shall not exceed the lesser of 1.0 W or $17 + 10 \log_{10} B$, dBm.

In the 5.725 – 5.850GHz band, the maximum permissible conducted output power is 1W (30dBm). The maximum e.i.r.p. is 36 dBm.

6.3.2 Test Procedure Used

ANSI C63.10-2013 – Section 12.3.3.2 Method PM-G

KDB 789033 D02 v02r01 – Section E)3)b) Method PM-G

ANSI C63.10-2013 – Section 14.2 Measure-and-Sum Technique

KDB 662911 v02r01 – Section E)1) Measure-and-Sum Technique

6.3.3 Test Settings

Average power measurements were performed only when the EUT was transmitting at its maximum power control level using a broadband power meter with a pulse sensor. The power meter implemented triggering and gating capabilities which were set up such that power measurements were recorded only during the ON time of the transmitter. The trace was averaged over 100 traces to obtain the final measured average power.

6.3.4 Test Setup

The EUT and measurement equipment were set up as shown in the diagram below.

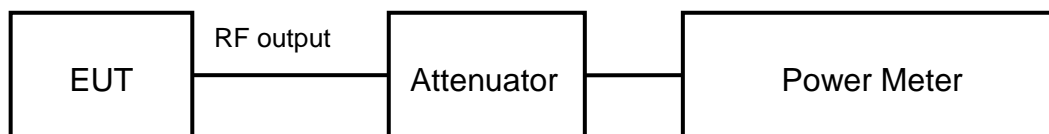

6.3.5 Test result

The test results are shown in Appendix A.

6.4 Maximum Power Spectral Density

6.4.1 Test limit

In the 5.15 – 5.25GHz, 5.25 – 5.35GHz, 5.47 – 5.725GHz bands, the maximum permissible power spectral density is 11dBm/MHz

In the 5.725 – 5.850GHz band, the maximum permissible power spectral density is 30dBm/500kHz.

6.4.2 Test Procedure Used

ANSI C63.10-2013 – Section 12.3.2.2

KDB 789033 D02 v02r01 – Section F

ANSI C63.10-2013 – Section 14.3.2.2 Measure-and-Sum Technique

KDB 662911 v02r01 – Section E)2) Measure-and-Sum Technique.

6.4.3 Test Settings

1. Analyzer was set to the center frequency of the UNII channel under investigation
2. Span was set to encompass the entire emission bandwidth of the signal
3. Set RBW = 500 kHz, VBW =1.5MHz for the band 5.725-5.85 GHz
4. Set RBW = 1 MHz, VBW =3MHz for the band 5.150-5.250 GHz, 5.250-5.350 GHz and 5.470-5.725 GHz
5. Number of sweep points > 2 x (span/RBW)
6. Sweep time = auto
7. Detector = power averaging (RMS)
8. Trigger was set to free run for all modes
9. Trace was averaged over 100 sweeps
10. The peak search function of the spectrum analyzer was used to find the peak of the spectrum.

6.4.4 Test Setup

The EUT and measurement equipment were set up as shown in the diagram below.

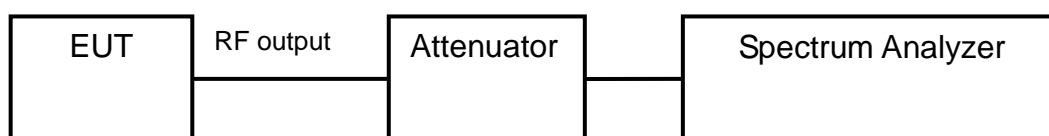

6.4.5 Test result

The test results are shown in Appendix A.

6.5 Frequency Stability

6.5.1 Test limit

Manufacturers of U-NII devices are responsible for ensuring frequency stability such that an emission is maintained within the band of operation under all conditions of normal operation as specified in the user's manual.

6.5.2 Test Procedure Used

1. To ensure emission at the band edge is maintained within the authorized band, those values shall be measured by radiation emissions at upper and lower frequency points, and finally compensated by frequency deviation as procedures below.
2. The EUT was operated at the maximum output power, and connected to the spectrum analyzer, which is set to maximum hold function and peak detector. The peak value of the power envelope was measured and noted. The upper and lower frequency points were respectively measured relatively 10dB lower than the measured peak value.
3. The frequency deviation was calculated by adding the upper frequency point and the lower frequency point divided by two.

6.5.3 Test result

The test results are shown in Appendix A.

6.6 Unwanted Radiated Emission Measurement

6.6.1 Test Description

All out of band radiated spurious emissions are measured with a spectrum analyzer connected to a receive antenna while the EUT is operating at maximum power and at the appropriate frequencies. Only the radiated emissions of the configuration that produced the worst case emissions are reported in this section.

6.6.2 Test limit

FCC Part15.205, 15.209,;

In addition, radiated emissions which fall in the restricted bands, as defined in Section 15.205(a), must also comply with the radiated emission limits specified in Section 15.209(a) (see Section 15.205(c)). All out of band emissions appearing in a restricted band as specified in Section 15.205 of the Title 47 CFR must not exceed the limits shown in below Table per Section 15.209. The spectrum shall be investigated from the lowest radio frequency signal generated in the device

Frequency [MHz]	Field strength [$\mu\text{V/m}$]	Measured Distance [meters]
0.009~0.490	2400/F(kHz)	300
0.490~1.705	24000/F(kHz)	30
1.705~30.0	30	30
30~88	100	3
88~216	150	3
216~960	200	3
Above 960	500	3

Radiated Limits

FCC Part15.35(b):

There is also a limit on the radio frequency emissions, as measured using instrumentation with a peak detector function, corresponding to 20 dB above the maximum permitted average limit

Used conversion factor: Limit (dB $\mu\text{V/m}$) = 20 log (Limit ($\mu\text{V/m}$)/1 $\mu\text{V/m}$)

Frequency [MHz]	Detector	Unit (dB $\mu\text{V/m}$)
30~88	Quasi-peak	40.0
88~216	Quasi-peak	43.5
216~960	Quasi-peak	46.0
960~1000	Quasi-peak	54.0
1000~5th harmonic of the highest frequency or 40GHz, whichever is lower	Average	54.0
	Peak	74.0

Conversion Radiated limits

6.6.3 Test Procedure Used

KDB 789033 D02 v02r01, Sections G.3, G.4, G.5, and G.6.

For Radiated emission below 30MHz

- a. The EUT was placed on the top of a rotating table 0.8 meters above the ground at chamber room. The table was rotated 360 degrees to determine the position of the highest radiation.
- b. The EUT was set 3 meters away from the interference-receiving antenna, which was mounted on the top of a variable-height antenna tower.
- c. Both X and Y axes of the antenna are set to make the measurement.
- d. For each suspected emission, the EUT was arranged to its worst case and the rotatable table was turned from 0 degrees to 360 degrees to find the maximum reading.
- e. The test-receiver system was set to Quasi-Peak Detect Function and recorded the reading with Maximum Hold Mode.

NOTE:

1. The resolution bandwidth and video bandwidth of test receiver/spectrum analyzer complied the following setting:

Frequency	RBW
9-150kHz	200-300Hz
0.15-30MHz	9-10kHz

For Radiated emission above 30MHz

- a. The EUT was placed on the top of a rotating table 0.8 meters (for 30MHz ~ 1GHz) / 1.5 meters (for above 1GHz) above the ground in chamber room for test. The table was rotated 360 degrees to determine the position of the highest radiation.
- b. The EUT was set 3 meters away from the interference-receiving antenna, which was mounted on the top of a variable-height antenna tower.
- c. The height of antenna is varied from one meter to four meters above the ground to determine the maximum value of the field strength. Both horizontal and vertical polarizations of the antenna are set to make the measurement.
- d. For each suspected emission, the EUT was arranged to its worst case and then the antenna was tuned to heights from 1 meter to 4 meters and the rotatable table was turned from 0 degrees to 360 degrees to find the maximum reading.
- e. The test-receiver system was set to quasi-peak detect function and recorded the reading with Maximum Hold Mode when the test frequency is below 1 GHz.
- f. The test-receiver system was set to peak and average detector and recorded the reading with Maximum Hold Mode when the test frequency is above 1 GHz. If the peak reading value also meets average limit, measurement with the average detector is unnecessary.

For the radiated emission test above 1GHz:

Place the measurement antenna away from each area of the EUT determined to be a source of emissions at the specified measurement distance, while keeping the measurement antenna aimed at the source of emissions at each frequency of significant emissions, with polarization oriented for maximum response. The measurement antenna may have to be higher or lower than the EUT, depending on the radiation pattern of the emission and staying aimed at the emission source for receiving the maximum signal. The final measurement

antenna elevation shall be that which maximizes the emissions. The measurement antenna elevation for maximum emissions shall be restricted to a range of heights of from 1 m to 4 m above the ground or reference ground plane.

NOTE:

1. The resolution bandwidth and video bandwidth of test receiver/spectrum analyzer is 120kHz for Quasi-peak detection (QP) at frequency below 1GHz.
2. The resolution bandwidth of test receiver/spectrum analyzer is 1 MHz and the video bandwidth is 3 MHz for Peak detection (PK) at frequency above 1GHz.
3. The resolution bandwidth of test receiver/spectrum analyzer is 1 MHz and the video bandwidth is 3 MHz for Average detection (AV) at frequency above 1GHz. If duty cycle of test signal is < 98%, the duty factor need added to measured value.
4. All modes of operation were investigated and the worst-case emissions are reported.

6.6.4 Test Settings

Frequency	Detector
< 1000MHz	Quasi-peak
> 1000MHz	Peak and average

Frequency	RBW
9-150kHz	200-300Hz
0.15-30MHz	9-10kHz
30-1000MHz	100-120kHz
> 1000MHz	1MHz

6.6.5 Radiated emission below 30MHz

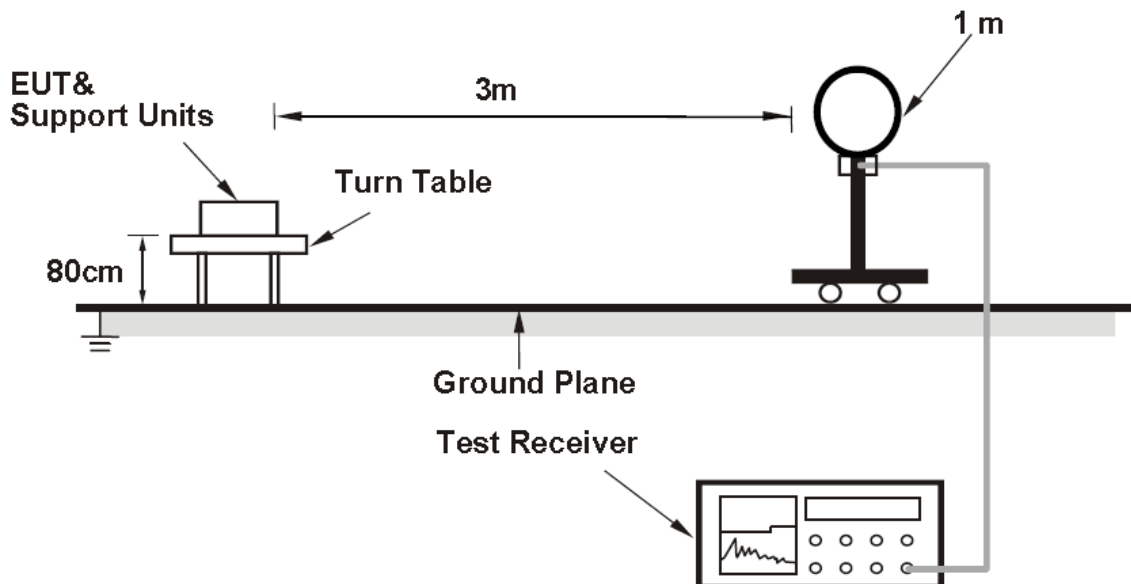

For Radiated emission 30MHz to 1GHz

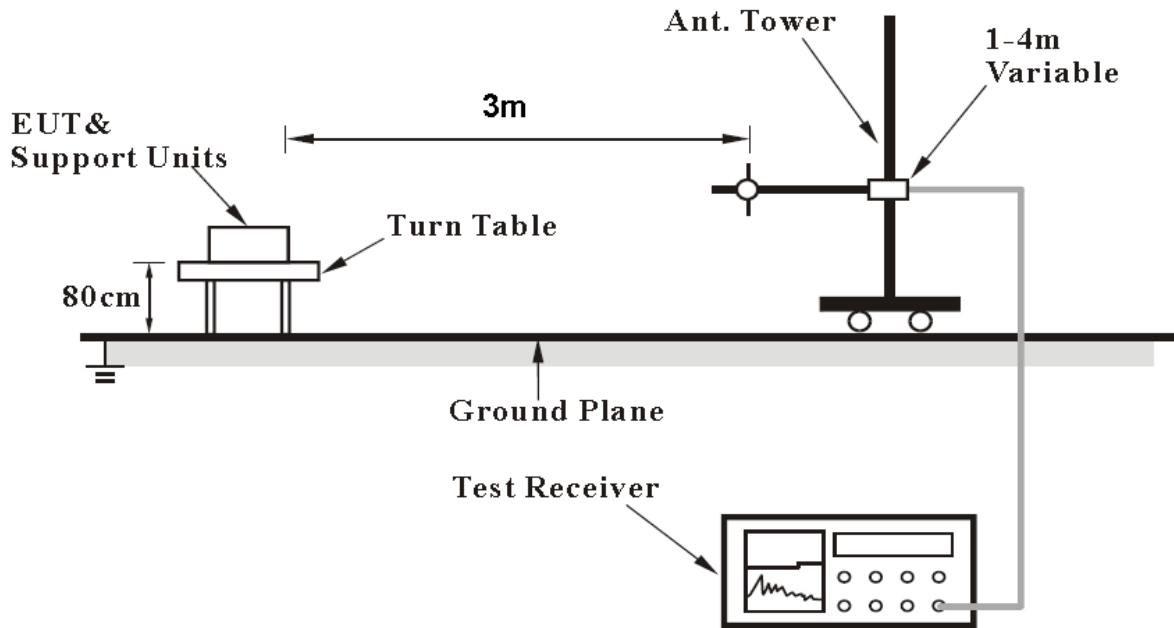

For Radiated emission above 1GHz

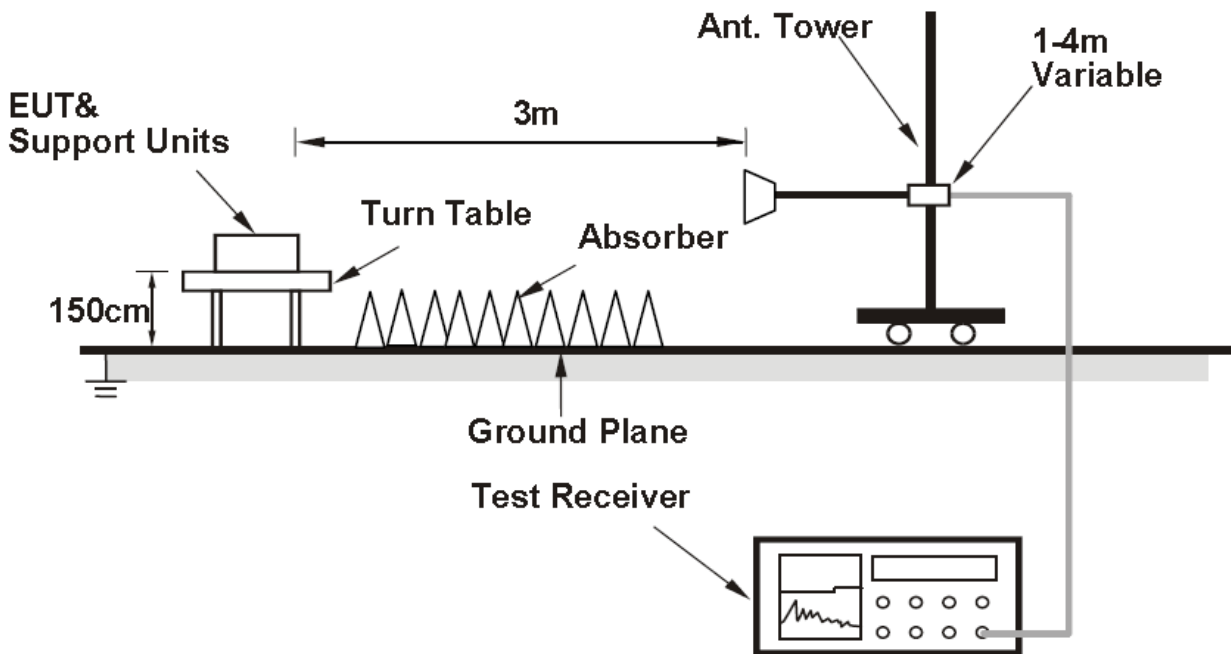

6.6.6 Test result

The test results are shown in Appendix B.

6.7 AC Power line Conducted Emission

6.7.1 Test limit

FCC Part 15.207(a) ,

Frequency of Emission (MHz)	Conducted Limit (dBuV)	
	Quasi-peak	Average
0.15-0.5	66 to 56 *	56 to 46 *
0.5-5	56	46
5-30	60	50

* Decreases with the logarithm of the frequency.

The measurement is made according to ANSI C63.10-2013

6.7.2 Test result

The test results are shown in Appendix B.

6.8 Dynamic Frequency Selection

6.8.1 Test limit

FCC Part 15.407(h) and FCC 06-96 APPENDIX "COMPLIANCE MEASUREMENT PROCEDURES FOR UNLICENSED-NATIONAL INFORMATION INFRASTRUCTURE DEVCIES OPERATING IN THE 5250-5350 MHz AND 5470-5725 MHz BANDS INCORPORATING DYNAMIC FREQUENCY SELECTION".

6.8.2 DFS Overview

Table 1: Applicability of DFS Requirements Prior to Use of a Channel

Requirement	Operational Mode		
	Master	Client Without Radar Detection	Client With Radar Detection
<i>Non-Occupancy Period</i>	Yes	Not required	Yes
<i>DFS Detection Threshold</i>	Yes	Not required	Yes
<i>Channel Availability Check Time</i>	Yes	Not required	Not required
<i>U-NII Detection Bandwidth</i>	Yes	Not required	Yes

Table 2: Applicability of DFS requirements during normal operation

Requirement	Operational Mode	
	Master Device or Client with Radar Detection	Client Without Radar Detection
<i>DFS Detection Threshold</i>	Yes	Not required
<i>Channel Closing Transmission Time</i>	Yes	Yes
<i>Channel Move Time</i>	Yes	Yes
<i>U-NII Detection Bandwidth</i>	Yes	Not required
Additional requirements for devices with multiple bandwidth modes	Master Device or Client with Radar Detection	Client Without Radar Detection
<i>U-NII Detection Bandwidth and Statistical Performance Check</i>	All BW modes must be tested	Not required
<i>Channel Move Time and Channel Closing Transmission Time</i>	Test using widest BW mode available	Test using the widest BW mode available for the link
<i>All other tests</i>	Any single BW mode	Not required
Note: Frequencies selected for statistical performance check (Section 7.8.4) should include several frequencies within the radar detection bandwidth and frequencies near the edge of the radar detection bandwidth. For 802.11 devices it is suggested to select frequencies in each of the bonded 20 MHz channels and the channel center frequency.		

Table 3: DFS Detection Thresholds for Master Devices and Client Devices with Radar Detection

Maximum Transmit Power	Value (See Notes 1, 2, and 3)
EIRP \geq 200 milliwatt	-64 dBm
EIRP $<$ 200 milliwatt and power spectral density $<$ 10 dBm/MHz	-62 dBm
EIRP $<$ 200 milliwatt that do not meet the power spectral density requirement	-64 dBm
<p>Note 1: This is the level at the input of the receiver assuming a 0 dBi receive antenna.</p> <p>Note 2: Throughout these test procedures an additional 1 dB has been added to the amplitude of the test transmission waveforms to account for variations in measurement equipment. This will ensure that the test signal is at or above the detection threshold level to trigger a DFS response.</p> <p>Note3: EIRP is based on the highest antenna gain. For MIMO devices refer to KDB Publication 662911 D01.</p>	

Table 4: DFS Response Requirement Values

Parameter	Value
<i>Non-occupancy period</i>	Minimum 30 minutes
<i>Channel Availability Check Time</i>	60 seconds
<i>Channel Move Time</i>	10 seconds See Note 1.
<i>Channel Closing Transmission Time</i>	200 milliseconds + an aggregate of 60 milliseconds over remaining 10 second period. See Notes 1 and 2.
<i>U-NII Detection Bandwidth</i>	Minimum 100% of the U-NII 99% transmission power bandwidth. See Note 3.
<p>Note 1: <i>Channel Move Time</i> and the <i>Channel Closing Transmission Time</i> should be performed with Radar Type 0. The measurement timing begins at the end of the Radar Type 0 burst.</p> <p>Note 2: The <i>Channel Closing Transmission Time</i> is comprised of 200 milliseconds starting at the beginning of the <i>Channel Move Time</i> plus any additional intermittent control signals required to facilitate a <i>Channel</i> move (an aggregate of 60 milliseconds) during the remainder of the 10 second period. The aggregate duration of control signals will not count quiet periods in between transmissions.</p> <p>Note 3: During the <i>U-NII Detection Bandwidth</i> detection test, radar type 0 should be used. For each frequency step the minimum percentage of detection is 90 percent. Measurements are performed with no data traffic.</p>	

Table 5 – Short Pulse Radar Test Waveforms

Radar Type	Pulse Width (μsec)	PRI (μsec)	Number of Pulses	Minimum Percentage of Successful Detection	Minimum Number of Trials
0	1	1428	18	See Note 1	See Note 1
1	1	Test A: 15 unique PRI values randomly selected from the list of 23 PRI values in Table 5a	Roundup $\left\{ \begin{array}{l} \left(\frac{1}{360} \right) \cdot \\ \left(\frac{19 \cdot 10^6}{\text{PRI}_{\mu\text{sec}}} \right) \end{array} \right\}$	60%	30
		Test B: 15 unique PRI values randomly selected within the range of 518-3066 μsec, with a minimum increment of 1 μsec, excluding PRI values selected in Test A			
2	1-5	150-230	23-29	60%	30
3	6-10	200-500	16-18	60%	30
4	11-20	200-500	12-16	60%	30
Aggregate (Radar Types 1-4)				80%	120
Note 1: Short Pulse Radar Type 0 should be used for the detection bandwidth test, channel move time, and channel closing time tests.					

Table 6 – Long Pulse Radar Test Waveform

Radar Type	Pulse Width (μsec)	Chirp Width (MHz)	PRI (μsec)	Number of Pulses per Burst	Number of Bursts	Minimum Percentage of Successful Detection	Minimum Number of Trials
5	50-100	5-20	1000-2000	1-3	8-20	80%	30

Table 7 – Frequency Hopping Radar Test Waveform

Radar Type	Pulse Width (μsec)	PRI (μsec)	Pulses per Hop	Hopping Rate (kHz)	Hopping Sequence Length (msec)	Minimum Percentage of Successful Detection	Minimum Number of Trials
6	1	333	9	0.333	300	70%	30

6.8.3 TEST AND MEASUREMENT SYSTEM

Principle

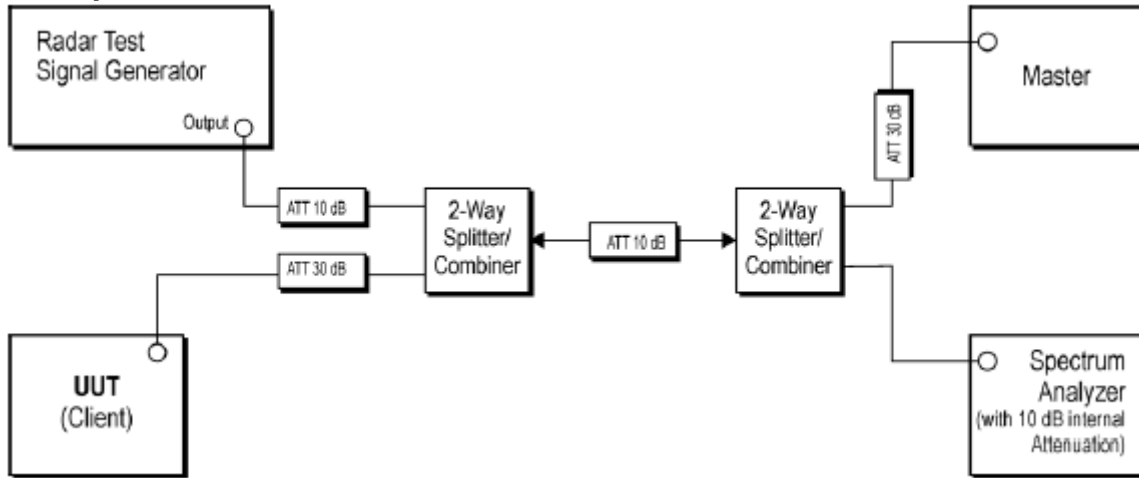

Setup for Client with injection at the Master

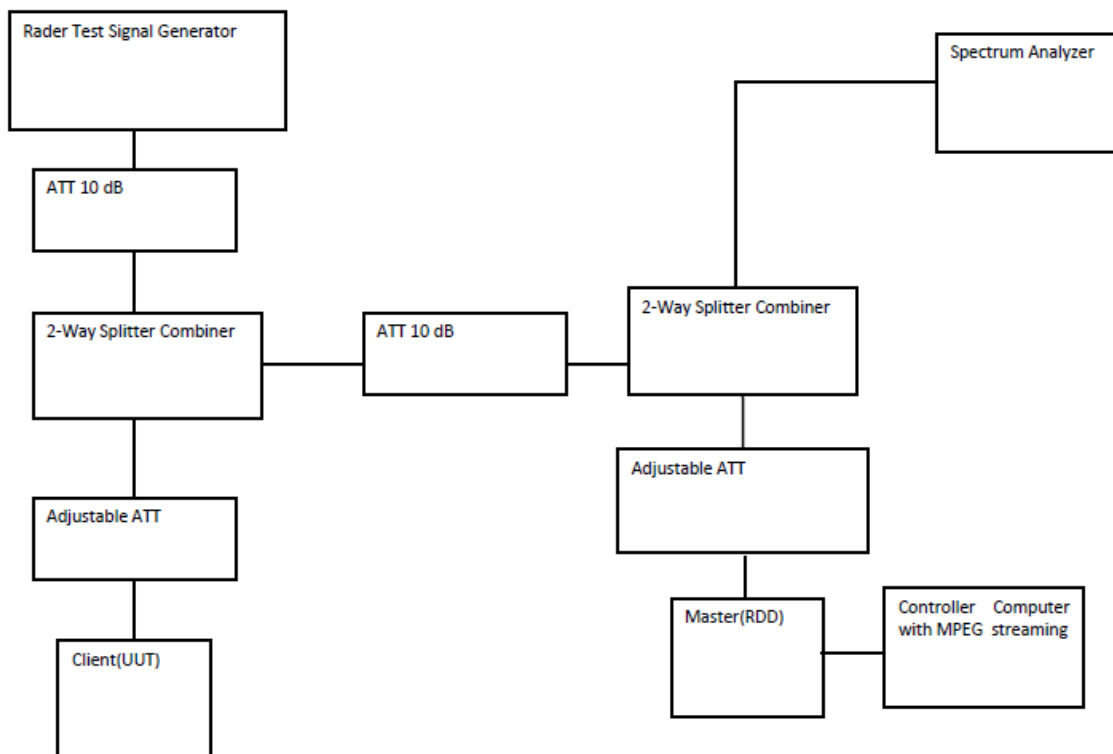

Client Devices

- a) A Client Device will not transmit before having received appropriate control signals from a Master Device.
- b) A Client Device will stop all its transmissions whenever instructed by a Master Device to which it is associated and will meet the Channel Move Time and Channel Closing Transmission Time requirements. The Client Device will not resume any transmissions until it has again received control signals from a Master Device.
- c) If a Client Device is performing In-Service Monitoring and detects a Radar Waveform above the DFS Detection Threshold, it will inform the Master Device. This is equivalent to the Master Device detecting the Radar Waveform and d) through f) of section 5.1.1 apply.
- d) Irrespective of Client Device or Master Device detection the Channel Move Time and Channel Closing Transmission Time requirements remain the same.
- e) The client test frequency must be monitored to ensure no transmission of any type has occurred for 30 minutes. Note: If the client moves with the master, the device is considered compliant if nothing appears in the client non-occupancy period test. For devices that shut down (rather than moving channels), no beacons should appear.

Test Setup Operation

System testing was performed with the designated MPEG-4 (1080P,WEBRip,DD5.1.x264-btbt) test file that streams full motion video from the Access Point to the Client in full motion video mode using the media player with the V2.61 Codec package.

This file is used by IP and Frame based systems for loading the test channel during the In-service compliance testing of the device.

The waveform parameters from within the bounds of the signal type are selected randomly using uniform distribution.

A spectrum analyzer is used as a monitor to verify that the EUT has vacated the Channel within the (Channel Closing Transmission Time and Channel Move Time, and does not transmit on a Channel during the Non-Occupancy Period after the detection and Channel move. It is also used to monitor EUT transmissions during the Channel Availability Check Time.

6.8.4 Test Procedure Used

(i) Operational Modes. The DFS requirement applies to the following operational modes:

(A) The requirement for channel availability check time applies in the master operational mode.

(B) The requirement for channel move time applies in both the master and slave operational modes.

(ii) Channel Availability Check Time. A U-NII device shall check if there is a radar system already operating on the channel before it can initiate a transmission on a channel and when it has to move to a new channel. The U-NII device may start using the channel if no radar signal with a power level greater than the interference threshold values listed in paragraph (h)(2) of this section, is detected within 60 seconds.

(iii) Channel Move Time. After a radar's presence is detected, all transmissions shall cease on the operating channel within 10 seconds. Transmissions during this period shall consist of normal traffic for a maximum of 200 ms after detection of the radar signal. In addition, intermittent management and control signals can be sent during the remaining time to facilitate vacating the operating channel.

(iv) Non-occupancy Period. A channel that has been flagged as containing a radar system, either by a channel availability check or in-service monitoring, is subject to a non-occupancy period of at least 30 minutes. The non-occupancy period starts at the time when the radar system is detected.

6.8.5 Test result

The test results are shown in Appendix A.

7 MEASUREMENT UNCERTAINTIES

Items	Uncertainty	
6dB Bandwidth	3kHz	
Peak power output	0.67dB	
Transmitter Power Spectral Density	0.75dB	
Band edge compliance	1.20dB	
Conducted Out of band emission measurement	30MHz~1GHz	2.83dB
	1GHz~12.75GHz	2.50dB
	12.75GHz~25GHz	2.75dB
Spurious Radiated Emissions	30MHz~200MHz	4.88dB
	200MHz~1GHz	4.87dB
	1GHz~18GHz	4.58dB
	18GHz~40GHz	4.35dB
AC Power line Conducted Emission	3.92dB	

8 TEST EQUIPMENTS

No.	Name/ Model	Manufacturer	S/N	Cal date	Cal Due date
1.	Spectrum Analyzer / FSV	ROHDE & SCHWARZ	101065	2021.06.21	2022.06.20
2.	Signal Analyzer / N9020A	Agilent	MY48010771	2022.05.18	2023.05.17
3.	Bluetooth Test Set / MT8852B	Anritsu	1329003	2021.06.21	2022.06.20
4.	Power Divider / 11667A	HP	19632	2021.06.21	2022.06.20
5.	Power Meter E4416A	Agilent	MY52370013	2022.04.13	2023.04.12
6.	Power Sensor E9323A	Agilent	MY52150008	2022.04.13	2023.04.12
7.	Signal Generator / SMBV100A	R&S	260910	2021.06.21	2022.06.20
8.	Temperature chamber / SH241	ESPEC	92013758	2021.06.21	2022.06.20
9.	Fully-Anechoic Chamber / 12.65mx8.03mx7.50m	FRANKONIA	----	----	----
10.	Semi-Anechoic/Chamber / 23.18mx16.88mx9.60m	FRANKONIA	---	----	----
11.	Turn table Diameter:1m	FRANKONIA	----	----	----
12.	Turn table Diameter:5m	FRANKONIA	----	----	----
13.	Antenna master FAC(MA4.0)	MATURO	----	----	----
14.	Antenna master SAC(MA4.0)	MATURO	----	----	----
15.	Shielding room / 9.080mx5.255mx3.525m	FRANKONIA	----	----	----
16.	Double-Ridged Waveguide Horn Antenna / HF 907	R&S	100512	2021.06.21	2022.06.20
17.	Double-Ridged Waveguide Horn Antenna / HF 907	R&S	100513	2021.06.21	2022.06.20
18.	Ultra log antenna / HL562	R&S	100016	2021.06.21	2022.06.20
19.	Receive antenna /3160-09	SCHWARZ-BECK	002058-002	2021.06.21	2022.06.20
20.	EMI test receiver / ESI 40	R&S	100015	2021.06.21	2022.06.20
21.	EMI test receiver / ESCS30	R&S	100029	2021.06.21	2022.06.20
22.	Receive antenna / HL562	R&S	100167	2021.06.21	2022.06.20
23.	AMN / ENV216	R&S	3560.6550.12	2021.06.21	2022.06.20
24.	WLAN AP WIA3300-20	SKSpruce	8152017060700339	---	---
25.	Notebook E470c	Lenovo	PF10UZW7	---	---

APPENDIX A – TEST DATA OF CONDUCTED EMISSION

Please refer to the attachment.

APPENDIX B – TEST DATA OF RADIATED EMISSION

Please refer to the attachment.