



(2004)量认(国)字(H2402)号

No.L1659

## ShenZhen Electronic Product Quality Testing Center

### CONFORMANCE TEST REPORT FOR HUMAN EXPOSURE TO ELECTROMAGNETIC FIELDS

SAR07-007

HISENSE COMMUNICATION CO.,LTD.

CDMA 800MHz

Type Name: C677

FCC ID: SARC677

Hardware Version: V 2.00  
Software Version: CD5.5.00.15.IN

Date of Issue: 2007-1-29





## GENERAL SUMMARY

Product Name	CDMA 800MHz	Development Stage	MP
Standard(s)	<p><b>47CFR § 2.1093:</b> Radiofrequency Radiation Exposure Evaluation: Portable Devices</p> <p><b>FCC OET Bulletin 65 (Edition 97-01), Supplement C (Edition 01-01):</b> Evaluating Compliance with FCC Guidelines for Human Exposure to Radiofrequency Electromagnetic Fields</p> <p><b>ANSI C95.1-1999:</b> IEEE Standard for Safety Levels with Respect to Human Exposure to Radio Frequency Electromagnetic Fields, 3 kHz to 300 GHz.</p> <p><b>IEEE 1528-2003:</b> Recommended Practice for Determining the Peak Spatial-Average Specific Absorption Rate (SAR) in the Human Body Due to Wireless Communications Devices: Experimental Techniques.</p>		
Conclusion	<p>Localized Specific Absorption Rate (SAR) of this portable wireless equipment has been measured in all cases requested by the relevant standards cited in Clause 5.2 of this test report. Maximum localized SAR is below exposure limits specified in the relevant standards cited in Clause 5.1 of this test report.</p> <p>General Judgment: <b>Pass</b></p> <p style="text-align: right;">Date of issue: Jan 29th, 2007</p>		
Comment	<p>TX Freq. Band: 824.70-848.31MHz</p> <p>RX Freq. Band: 869.70-893.31MHz</p> <p>Antenna Character : build outside</p> <p>The test result only responds to the measured sample.</p>		

Tested by: Zhang Can Jan. 29, 2007  
Zhang Can

Checked by: Smart Li Jan 29, 2007  
Smart Li

Approved by: Wang Keqin Date: Jan. 30, 2007  
Wang Keqin





## **Contents**

- 1. GENERAL CONDITIONS**
- 2. ADMINISTRATIVE DATA**
  - 2.1. Identification of the Responsible Testing Laboratory
  - 2.2. Identification of the Responsible Testing Location(s)
  - 2.3. Organization Item
  - 2.4. Identification of Applicant
  - 2.5. Identification of Manufacture
- 3. EQUIPMENT UNDER TEST (EUT)**
  - 3.1. Identification of the Equipment under Test
  - 3.2. Identification of all used Test Sample of the Equipment under Test
- 4. OPERATIONAL CONDITIONS DURING TEST**
  - 4.1. Schematic Test Configuration
  - 4.2. SAR Measurement System
- 5. CHARACTERISTICS OF THE TEST**
  - 5.1. Applicable Limit Regulations
  - 5.2. Applicable Measurement Standards
- 6. LABORATORY ENVIRONMENT**
- 7. 3G MEASUREMEAMENT PROCEDURE**
- 8. TEST RESULTS**
  - 7.1. Dielectric Performance
  - 7.2. Summary of Measurement Results
  - 7.3. Conclusion
- 9. MEASUREMENT UNCERTAINTY**
- 10. MAIN TEST INSTRUMENTS**

**This Test Report consists of the following Annexes:**

<p><b>Annex A: Accreditation Certificate</b></p> <p><b>Annex B: Test Layout</b></p> <p><b>Annex C: Sample Photographs</b></p> <p><b>Annex D: Graph Test Results</b></p> <p><b>Annex E: System Performance Check Data</b></p>
--



---

## **1 . GENERAL CONDITIONS**

**1.1 This report only refers to the item that has undergone the test.**

**1.2 This report standalone dose not constitute or imply by its own an approval of the product by the certification Bodies or competent Authorities.**

**1.3 This document is only valid if complete; no partial reproduction can be made without written approval of Shenzhen Electronic Product Quality Testing Center.**

**1.4 This report cannot be used partially or in full for publicity and/or promotional purposes without previous written approval of Shenzhen Electronic Product Quality Testing Center and the Accreditation Bodies, if it applies.**



## 2. Administrative Date

### 2.1. Identification of the Responsible Testing Laboratory

**Company Name:** ShenZhen Electronic Product Quality Testing Center  
**Department:** Testing Department  
**Address:** Electronic Testing Building, ShaHe Road, NanShan District,  
ShenZhen, P. R. China  
**Telephone:** +86-755-26628676  
**Fax:** +86-755-26627238  
**Responsible Test Lab  
Managers:** Mr. Wu Li'an

### 2.2. Identification of the Responsible Testing Location(s)

**Company Name:** ShenZhen Electronic Product Quality Testing Center  
**Address:** Electronic Testing Building, ShaHe Road, NanShan District,  
ShenZhen, P. R. China

### 2.3. Organization Item

**S.E.T Report No.:** SAR07-007  
**S.E.T Project Leader:** Mr. Li Sixiong  
**S.E.T Responsible for  
accreditation scope:** Mr. Wu Li'an  
**Start of Testing:** 2007-1-23  
**End of Testing:** 2007-1-29

### 2.4. Identification of Applicant

**Company Name:** Hisense Communication Co.,Ltd.  
**Address:** 218, Qianwangang Road, Economics and Technology Development  
Area, Qingdao, China  
Hisense Information Property Park  
**Contact person:** Ren Xiaolin  
**Telephone:** +86-0532-80878945  
**Fax:** +86-0532-83891771

### 2.5. Identification of Manufacture

**Company Name:** Hisense Communication Co.,Ltd.  
**Address:** 218, Qianwangang Road, Economics and Technology Development  
Area, Qingdao, China  
**Contact person:** Ren Xiaolin  
**Telephone:** +86-0532-80878945  
**Fax:** +86-0532-83891771

**Notes:** This data is based on the information by the applicant.



### 3. Equipment Under Test (EUT)

#### 3.1. Identification of the Equipment under Test

<b>Brand Name:</b>	Hisense		
<b>Type Name:</b>	C677		
<b>Marking Name:</b>	C677		
	Test frequency	CDMA 800MHz	
	Development Stage	Identical Prototype	
	Accessories	Charger	
	Battery type	L13788IsA	
<b>General description:</b>	Battery specification	880mAh 3.7V	
	Antenna type	Build inside	
	Operation mode	Call established	
	Modulation mode	CDMA	
	Max. Power(ERP)	23.58dBm for CDMA 800MHz Band	

#### NOTE:

1. The EUT is a model of CDMA Mobile Station (“MS” for short in this report) operating in Cellular 800MHz band.
2. Please refer to Appendix C for the photographs of the EUT. For a more detailed features description about the EUT, please refer to User’s Manual.

#### 3.2. Identification of all used Test Sample of the Equipment under Test

EUT Code	ESN	Hardware Version	Software Version
SH07010006M01	4F465B63	V 2.00	CD5.5.00.15.IN

## 4 OPERATIONAL CONDITIONS DURING TEST

### 4.1 Schematic Test Configuration

During SAR test, EUT is in Traffic Mode (Channel Allocated) at Normal Voltage Condition. A communication link is set up with a System Simulator (SS) by air link, and a call is established.

The TCH is allocated to 9, 384 and 758 respectively in the case of CDMA 800 MHz. The EUT is commanded to operate at maximum transmitting power.

The EUT shall use its internal transmitter. The antenna(s), battery and accessories shall be those specified by the manufacturer. The EUT battery must be fully charged and checked periodically during the test to ascertain uniform power output. If a wireless link is used, the antenna connected to the output of the base station simulator shall be placed at least 50 cm away from the handset.

The signal transmitted by the simulator to the antenna feeding point shall be lower than the output power level of the handset by at least 35 dB.

### 4.2 SAR Measurement System

The SAR measurement system being used is the IndexSAR SARA2 system, which consists of a

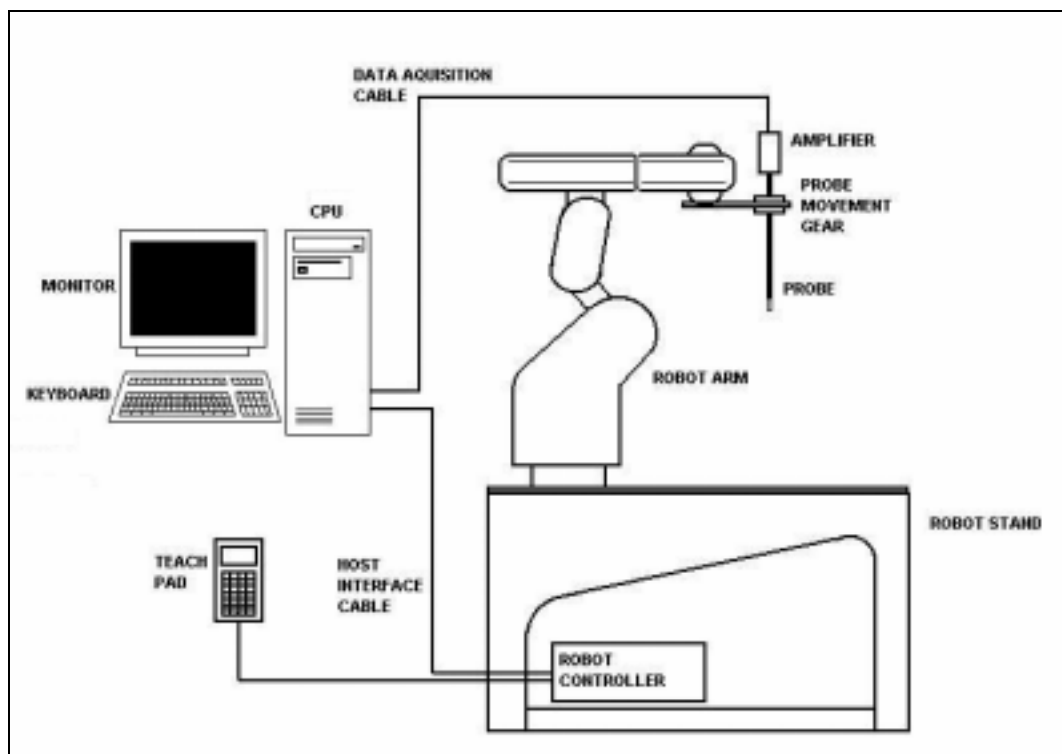

Figure1. SAR Lab Test Measurement Set-up

Mitsubishi RV-E2 6-axis robot arm and controller, IndexSAR probe and amplifier and SAM phantom

Head Shape. The system is controlled remotely from a PC, which contains the software to control the robot and data acquisition equipment. The software also displays the data obtained from test scans.

In operation, the system first does an area (2D) scan at a fixed depth within the liquid from the inside wall of the phantom. When the maximum SAR point has been found, the system will then carry out a 3D scan centred at that point to determine volume averaged SAR level.

### 4.2.1 Robot system specification

The robot is used to articulate the probe to programmed positions inside the phantom head to obtain the SAR readings from the DUT.



#### Robot and Stand

<b>Type</b>	Mitsubishi Movemaster RV-2A / 6 axis vertical articulated robot
<b>Dimensions (robot)</b>	Height: 790mm (in home position)
<b>Dimensions (robot stand)</b>	1010L x 450W x 820H mm
<b>Weight</b>	Approx. 36 kg
<b>Position repeatability</b>	+/- 0.04mm
<b>Drive Method</b>	AC servomotor
<b>Expandability</b>	Extra axis expansion capability for probe calibration applications E-Field probe



#### Robot Controller Unit

<b>Type</b>	CR1 - 571
<b>Dimensions</b>	212W x 290D x 151H mm
<b>Weight</b>	8 kg
<b>Power source</b>	single-phase 100 - 240 VAC

### 4.2.2 Probe and amplifier specification

#### IXP-050 Indexsar isotropic immersible SAR probe

The probes are constructed using three orthogonal dipole sensors arranged on an interlocking, triangular prism core. The probes have built-in shielding against static charges and are contained within a PEEK



cylindrical enclosure material at the tip (showed in figure 2). The system uses diode compression potential (DCP) to determine SAR values for different types of modulation. Crest factor is not used for determining SAR values. The DCP for different types of modulation is determined during the probe calibration procedure.

<b>E-filed Probe</b>	
	<p><b>Type</b> Three orthogonal dipole sensors arranged on triangular, interlocking substrates</p> <p><b>Dimensions</b>  <b>Overall length:</b> 350mm  <b>Tip length:</b> 10mm  <b>Body diameter:</b> 12mm  <b>Tip diameter:</b> 5mm  <b>Distance from probe tip to dipole centers:</b> 2.5mm</p> <p><b>Interfacing</b> Lemo 6 pole latching connector for interfacing to high impedance amplifier</p> <p><b>Isotropy</b>            +/- 0.5dB in brain liquids (rotation about probe axis)            typically +/- 0.15dB            +/- 0.5dB in brain liquids (rotation normal to probe axis)</p> <p><b>Calibration</b> Indexsar calibration in brain tissue simulating liquids at frequency of 900MHz, 1800MHz and 1900MHz</p> <p><b>Dynamic Range</b> 0.001W/kg to 100W/kg in liquid. Linearity +/- 0.2W/kg</p>

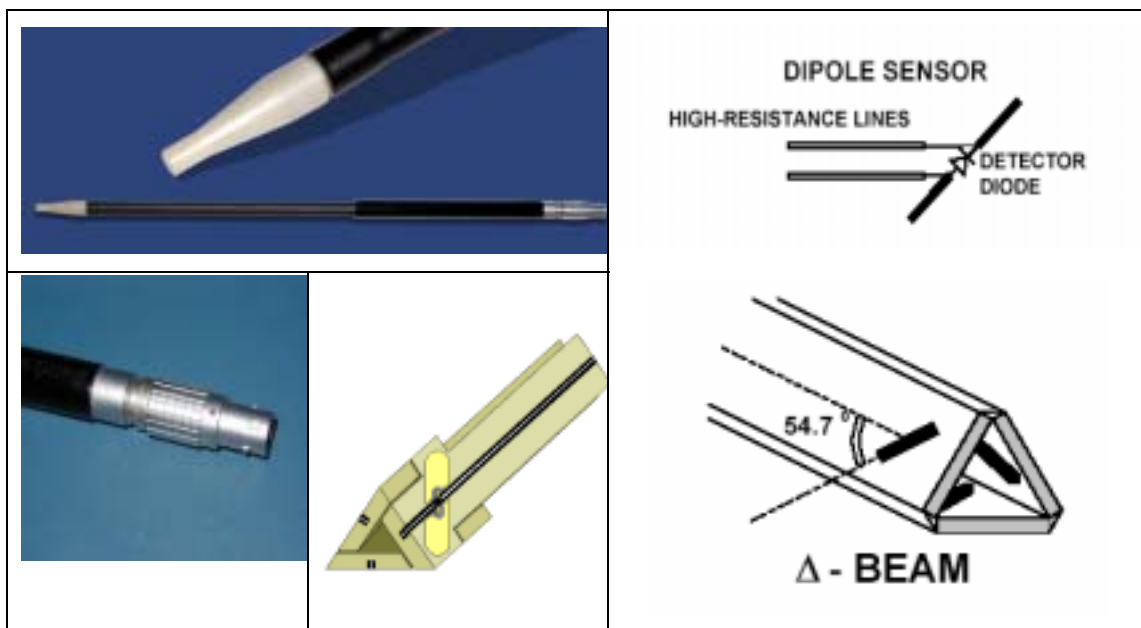

**Figure2.** Specification and characterisation parameters of indexsar probe

## IFA-010 Amplifier

The amplifier unit has a multi-pole connector to connect to the probe and a multiplexer selects between the 3-channel single-ended inputs. A 16-bit AtoD converter with programmable gain is used along with an on-board micro-controller with non-volatile firmware. Battery life is around 150 hours and data are transferred to the PC via 3m of duplex optical fibre and a self-powered RS232 to optical converter.

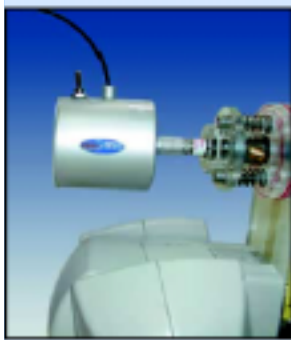

### Probe Amplifier and PC Interface

<b>Type</b>	High impedance inputs with 3 independent x,y,z sensor channels giving simultaneous measurement data every 2ms. Reads true average of modulated signals without the need for duty cycle corrections
<b>Ranges</b>	Software selectable of x1 to 63
<b>Cable</b>	Optical cable with self-powered 9 way RS232 converter. 3m cable length supplied as standard. Other lengths to order.
<b>Power Requirements</b>	2 x AAA batteries giving approximately 100 hours usage.

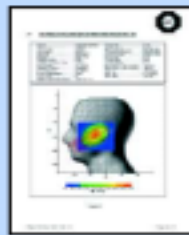

#### 'Word' report format

The results of each frequency scan are presented in a Microsoft 'Word' document with all the necessary measurement parameters automatically tabulated. Users can customise the layout and in some cases language changes are possible.

## 4.2.3 Phantoms and simulant liquid

### 4.2.3.1 SAR head phantom (SAM)

The Indexsar SAM Upright Phantom is fabricated to the shape defined in these CAD files by Antennessa.



### Head Phantom

<b>Type 2</b>	Upright SAM phantom
<b>Dimensions</b>	Height: 320mm Baseplate diameter: 275mm
<b>Weight</b>	empty: 1.2 kg filled: 7.2 kg
<b>Wall thickness</b>	2.0 mm $\pm$ 0.2
<b>Construction</b>	Low loss resin / Strengthened saggital seam

It is mounted on the base table, which holds the robotic positioner. Both mechanical and laser-based

registration systems are utilised to register the phantom position in relationship to the robot co-ordinate system. In the SARA2 implementation, the SAM phantom is mounted on a supporting table made of low dielectric loss material, which includes mounting brackets for DUT positioners, dipole holders and (optionally) a shelf for supporting larger devices like laptop computers.

#### 4.2.3.2 Box phantom

The box phantom used for body testing and for validation is manufactured from Perspex.

#### IXB – 070 Specification and characterisation parameters

	<b>Constructional details</b>	
	<b>Internal dimensions:</b>	200mm x 200mm x 200mm
	<b>Thickness of base:</b>	2mm +/- 0.2mm
	<b>Wall thickness:</b>	4mm
	<b>Material:</b>	PMMA
	<b>Frequency range</b>	300MHz – 6GHz
	<b>Dielectric properties</b>	Relative permittivity 2.7 Loss tangent <0.02

**Tissue-simulant volume required for 150mm depth (6 litres)**

#### 4.2.3.3 Simulant liquids

Simulant liquids that are used for testing at frequencies of CDMA 800MHz, which are made mainly of sugar, salt and water solutions may be left in the phantoms. Approximately 7litres are needed for an upright head compared to about 27litres for a horizontal bath phantom.

Ingredients (% by weight )	Frequency(MHz)	
	800	
Tissue Type	Head	Body
Water	40.92	56.0
Salt(NaCl)	1.48	0.76
Sugar	56.5	41.76
HEC	1	1.21
Bacterial de	0.0	0.0
DGBE	0.0	0.0
Acticide SPX	0.1	0.27
Dielectric Constant	41.44	52.99
Conductivity (S/m)	0.99	1.12

### 4.2.4 SAR measurement procedure

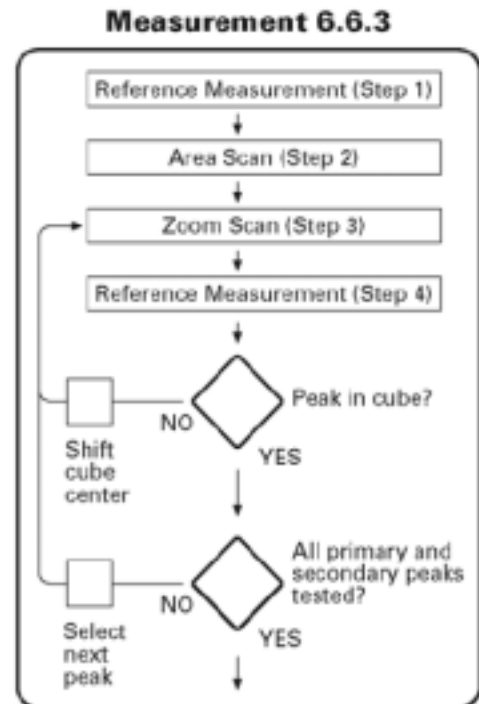
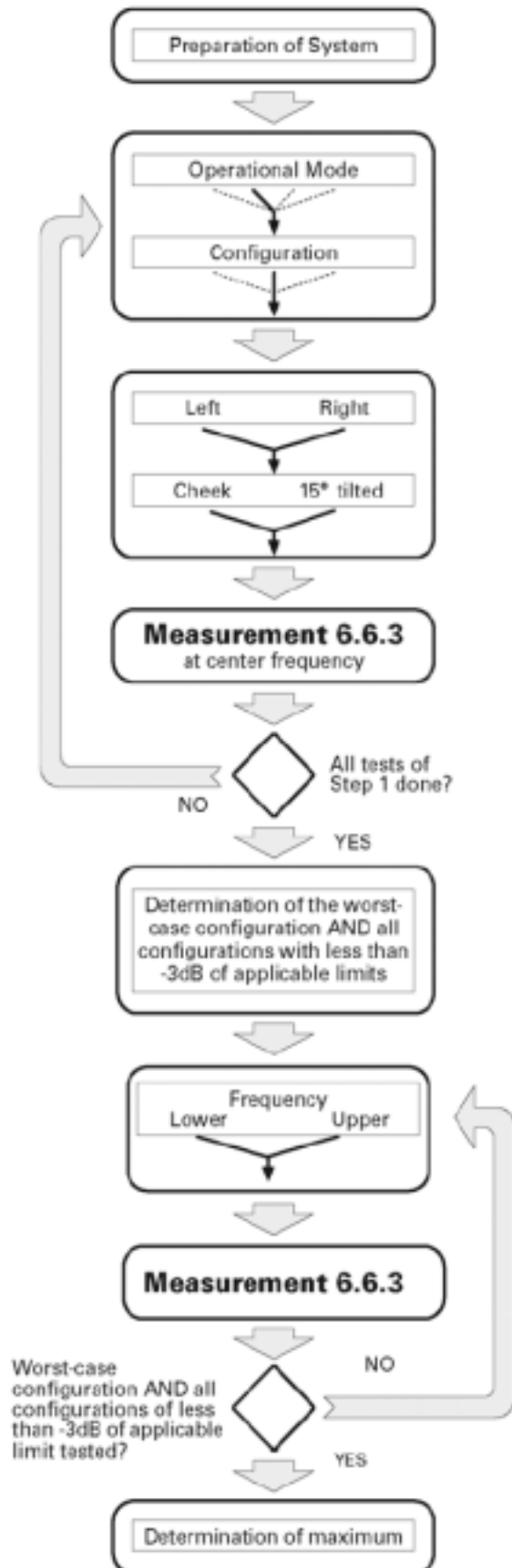

Channel	Left				Right			
	Cheek		Tilt		Cheek		Tilt	
	Retracted	Extended	Retracted	Extended	Retracted	Extended	Retracted	Extended
<b>Mode 1:</b>								
<b>High</b>			S2(-1.4dB)	S2(-0.4dB)			S2(-2.2dB)	S2(-1.4dB)
<b>Middle</b>	S1(-4dB)	S1(-4dB)	S1(-1.5dB)	S1(-0.5dB)	S1(-5dB)	S1(-5dB)	S1(-2.5dB)	S1(-1.5dB)
<b>Low</b>			S2(-1.3dB)	S2(-0.7dB)			S2(-2.7dB)	S2(-0.6dB)
<b>Mode 2:</b>								
<b>High</b>			S2(-2.7dB)	S2(-1.1dB)				
<b>Middle</b>	S1(-5dB)	S1(-5dB)	S1(-2.5dB)	S1(-1dB)	S1(-6dB)	S1(-6dB)	S1(-5dB)	S1(-5dB)
<b>Low</b>			S2(-2.2dB)	S2(-0.8dB)				

After an area scan has been done at a fixed distance of 8mm from the surface of the phantom on the source side, a 3D scan is set up around the location of the maximum spot SAR. First, a point within the scan area is visited by the probe and a SAR reading taken at the start of testing. At the end of testing, the probe is returned to the same point and a second reading is taken. Comparison between these start and end readings enables the power drift during measurement to be assessed.

Above is the scanning procedure flow chart and table from the IEEE p1528 standard. This is the procedure for which all compliant testing should be carried out to ensure that all variations of the device position and transmission behaviour are tested.

### 4.2.5 Validation testing using box phantoms

The following procedure, recommended for performing validation tests using box phantoms is based on the procedures described in the draft IEEE standard P1528. Setup according to the setup diagram below :

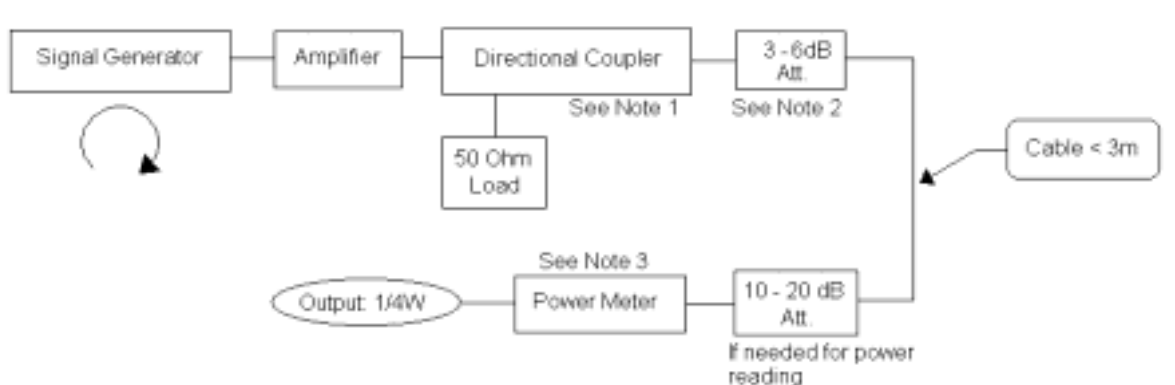

With the SG and Amp and with directional coupler in place, set up the source signal at the relevant

frequency and use a power meter to measure the power at the end of the SMA cable that you intend to connect to the balanced dipole. Adjust the SG to make this, say, 0.25W (24 dBm). If this level is too high to read directly with the power meter sensor, insert a calibrated attenuator (e.g. 10 or 20 dB) and make a suitable correction to the power meter reading.

Note 1: In this method, the directional coupler is used for monitoring rather than setting the exact feed power level. If, however, the directional coupler is used for power measurement, you should check the frequency range and power rating of the coupler and measure the coupling factor (referred to output) at the test frequency using a VNA.

Note 2: Remember that the use of a 3dB attenuator (as shown in Figure 8.1 of P1528) means that you need an RF amplifier of 2 times greater power for the same feed power. The other issue is the cable length. You might get up to 1dB of loss per meter of cable, so the cable length after the coupler needs to be quite short.

Note 3: For the validation testing done using CW signals, most power meters are suitable. However, if you are measuring the output of a modulated signal from either a signal generator or a handset, you must ensure that the power meter correctly reads the modulated signals.

#### 4.2.5.1 Setting up the box phantom for validation testing

The main purpose of the box phantom is for validation of the system. By placing the box phantom in place of the upright head, using the box phantom dipole holder the system can now be used to check that the probe and software are giving accurate readings.

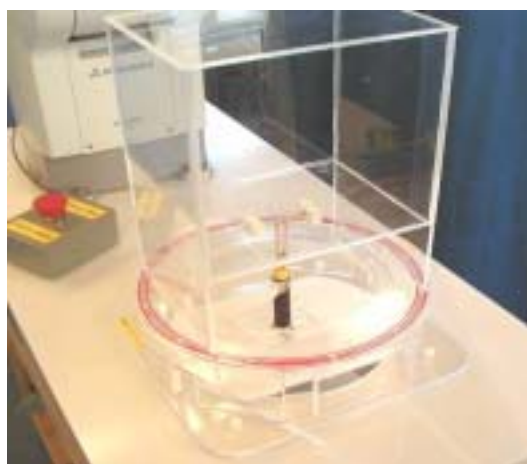

#### 4.2.5.2 Equipments and results of validation testing

Equipments :

name	Type and specification
Signal generator	SML02
Directional coupler	450MHz-3GHz
Amplifier	3W 502(10-2500MHz)
Reference dipole	IXD-090 antenna

Results :

Frequency	Target value ( 1g )	Test value ( 1g )
800MHz	10.8 W/kg	10.448 W/kg(body)

#### **4.2.6 SARA2 Interpolation and Extrapolation schemes**

SARA2 software contains support for both 2D cubic B-spline interpolation as well as 3D cubic B-spline interpolation. In addition, for extrapolation purposes, a general n-th order polynomial fitting routine is implemented following a singular value decomposition algorithm. A 4th order polynomial fit is used by default for data extrapolation, but a linear-logarithmic fitting function can be selected as an option. The polynomial fitting procedures have been tested by comparing the fitting coefficients generated by the SARA2 procedures with those obtained using the polynomial fit functions of Microsoft Excel when applied to the same test input data.

#### **4.2.7 Interpolation of 2D area scan**

The 2D cubic B-spline interpolation is used after the initial area scan at fixed distance from the phantom shell wall. The initial scan data are collected with approx. 10mm spatial resolution and spline interpolation is used to find the location of the local maximum to within a 1mm resolution for positioning the subsequent 3D scanning.

#### **4.2.8 Extrapolation of 3D scan**

For the 3D scan, data are collected on a spatially regular 3D grid having (by default) 6.4 mm steps in the lateral dimensions and 3.5 mm steps in the depth direction (away from the source). SARA2 enables full control over the selection of alternative step sizes in all directions.

The digitised shape of the head is available to the SARA2 software, which decides which points in the 3D array are sufficiently well within the shell wall to be 'visited' by the SAR probe. After the data collection, the data are extrapolated in the depth direction to assign values to points in the 3D array closer to the shell wall. A notional extrapolation value is also assigned to the first point outside the shell wall so that subsequent interpolation schemes will be applicable right up to the shell wall boundary.

#### **4.2.9 Interpolation of 3D scan and volume averaging**

The procedure used for defining the shape of the volumes used for SAR averaging in the SARA2 software follow the method of adapting the surface of the 'cube' to conform with the curved inner surface of the phantom. This is called, here, the conformal scheme.

For each row of data in the depth direction, the data are extrapolated and interpolated to less than 1mm spacing and average values are calculated from the phantom surface for the row of data over distances corresponding to the requisite depth for 10g and 1g cubes. This results in two 2D arrays of data, which are then cubic B-spline interpolated to sub mm lateral resolution. A search routine then moves an



averaging square around through the 2D array and records the maximum value of the corresponding 1g and 10g volume averages. For the definition of the surface in this procedure, the digitized position of the head shell surface is used for measurement in head-shaped phantoms. For measurements in rectangular, box phantoms, the distance between the phantom wall and the closest set of gridded data points is entered into the software. For measurements in box-shaped phantoms, this distance is under the control of the user. The effective distance must be greater than 2.5mm as this is the tip-sensor distance and to avoid interface proximity effects, it should be at least 5mm. A value of 6 or 8mm is recommended. This distance is called **dbe**.

For automated measurements inside the head, the distance cannot be less than 2.5mm, which is the radius of the probe tip and to avoid interface proximity effects, a minimum clearance distance of  $x$  mm is retained. The actual value of  $dbe$  will vary from point to point depending upon how the spatially regular 3D grid points fit within the shell. The greatest separation is when a grid point is just not visited due to the probe tip dimensions. In this case the distance could be as large as the step-size plus the minimum clearance distance (i.e with  $x=5$  and a step size of 3.5,  $dbe$  will be between 3.5 and 8.5mm).

The default step size ( $dstep$ ) used is 3.5mm, but this is under user-control. The compromise is with time of scan, so it is not practical to make it much smaller or scan times become long and power-drop influences become larger.

The robot positioning system specification for the repeatability of the positioning ( $dss$ ) is  $\pm 0.04$ mm.

The phantom shell is made by an industrial moulding process from the CAD files of the SAM shape, with both internal and external moulds. For the upright phantoms, the external shape is subsequently digitized on a Mitutoyo CMM machine (Euro an ultrasonic sensor indicate that the shell thickness ( $dph$ ) away from the ear is  $2.0 \pm 0.1$ mm. The ultrasonic measurements were calibrated using additional mechanical measurements on available cut surfaces of the phantom shells. See support document IXS-020x.

For the upright phantom, the alignment is based upon registration of the rotation axis of the phantom on its 253mm diameter baseplate bearing and the position of the probe axis when commanded to go to the axial position. A laser alignment tool is provided (procedure detailed elsewhere). This enables the registration of the phantom tip ( $dmis$ ) to be assured to within approx. 0.2mm. This alignment is done with reference to the actual probe tip after installation and probe alignment. The rotational positioning of the phantom is variable – offering advantages for special studies, but locating pins ensure accurate repositioning at the principal positions (LH and RH ears).





#### **4.2.10 Probe anisotropy and boundary proximity influence correction software (Virtual Probe Miniaturization VPM software)**

Indexsar Report IXS0223 provides a background to the factors affecting measurements at high frequencies when using SAR probes of size 8 – 5mm tip diameter. Although the Indexsar probes are at the smaller end of this range, SAR probes are not isotropic in 5GHz phantom field gradients and ad

- 1) At >5GHz, the SAR field decays to 1/e of its value within 3-4mm of the surface of a phantom with a source adjacent. So, measurements are significantly affected by small errors in the separation distances employed between the probe and the phantom surface. The distance between the probe tip and the plane of the sensors should be allowed for using the same value as that declared in the probe calibration document. Distances between the probe tip and phantom surface should be measured accurately to 0.1mm. The best way to assure this is to use the robot to position the probe in light contact with the phantom wall and then to withdraw the probe by the selected amount under robot control.
- 2) The preferred test geometry at 5GHz is for testing at the bottom of an open phantom. If tests at the side of a phantom are performed, it will be necessary to apply VPM corrections as described below. In either case, careful monitoring of probe spacing from the phantom is required. Probe isotropy is improved for measuring fields polarized either normal to or parallel to the probe axis. If the source polarization is known, this arrangement should be established, if possible.
- 3) The probe calibration factors including boundary correction terms should be carefully entered from the calibration document. The probe calibration factors require that the probe be oriented in a known rotational position. The red spot on the Indexsar probe should be aligned facing away from the robot arm.
- 4) The latest SARA2 software (VPM editions) contain support for correcting for probe anisotropy in strong field gradients and include a procedure for correcting for boundary proximity influences. As noted above, the probe has to be oriented in a given rotational position and some familiarity with the new measurement procedures is necessary. The calculations can be performed either with or without the extended correction schemes applied.
- 5) If boundary corrections are used, it may be preferable to go rather closer to the phantom surface than is usually recommended and to perform scans using small steps between the measurement planes so that good data on the SAR profiles are collected within the first 10mm of the phantom depth.

## 5 CHARACTERISTICS OF THE TEST

### 5.1 Applicable Limit Regulations

**47CFR § 2.1093:** Radiofrequency Radiation Exposure Evaluation: Portable Devices

**FCC OET Bulletin 65(Edition 97-01), Supplement C(Edition 01-01):** Evaluating Compliance with FCC Guidelines for Human Exposure to Radiofrequency Electromagnetic Fields

**ANSI C95.1–1999:** IEEE Standard for Safety Levels with Respect to Human Exposure to Radio Frequency Electromagnetic Fields, 3 kHz to 300 GHz.

It specifies the maximum exposure limit of **1.6 W/kg** as averaged over any 1 gram of tissue for portable devices being used within 20 cm of the user in the uncontrolled environment.

### 5.2 Applicable Measurement Standards

**IEEE 1528–2003:** Recommended Practice for Determining the Peak Spatial-Average Specific Absorption Rate (SAR) in the Human Body Due to Wireless Communications Devices: Experimental Techniques.

They specify the measurement method for demonstration of compliance with the SAR limits for such equipments.

## 6 LABORATORY ENVIRONMENT

**Table: The Ambient Conditions during SAR Test**

Temperature	Min. = 15 ° C, Max. = 30 ° C
Relative humidity	Min. = 30%, Max. = 70%
Ground system resistance	< 0.5
Ambient noise is checked and found very low and in compliance with requirement of standards. Reflection of surrounding objects is minimized and in compliance with requirement of standards.	



## 7. 3G MEASUREMENT PROCEDURES

### 7.1 Procedures Used To Establish Test Signal

The handset was placed into a simulated call using a base station simulator in a shielded chamber. Such test signals offer a consistent means for testing SAR and are recommended for evaluating SAR. SAR measurements were taken with a fully charged battery. In order to verify that the device was tested and maintained at full power, this was configured with the base station simulator. The SAR measurement software calculates a reference point at the start and end of the test to check for power drifts. If conducted power deviations of more than 5% occurred, the tests were repeated.

### 7.2 SAR Measurement Conditions for CDMA2000 1x

These procedures were followed according to FCC "SAR Measurement Procedures for 3G Devices", June 2006.

#### 7.2.1 Output Power Verification

See 3GPP2 C.S0011/TIA-98-E as recommended by "SAR Measurement Procedures for 3G Devices", June 2006.

Maximum output power is verified on the High, Middle and Low channels according to procedures defined in section 4.4.5.2 of 3GPP2 C.S0011/TIA-98-E. SO55 tests were measured with power control bits in "All Up" condition.

1. If the mobile station supports Reverse TCH RC 1 and Forward TCH RC 1, set up a call using Fundamental Channel Test Mode 1 (RC=1/1) with 9600 bps data rate only.
2. Under RC1, C.S0011 Table 4.4.5.2-1 (Table.A) parameters were applied.
3. If the MS supports the RC 3 Reverse FCH, RC3 Reverse SCH0 and demodulation of RC 3, 4, or 5, set up a call using Supplemental Channel Test Mode 3 (RC 3/3) with 9600 bps Fundamental Channel and 9600 bps SCH0 data rate Channel and 9600 bps SCH0 data rate.
4. Under RC3, C.S0011 Table 4.4.5.2-2(Table.B) was applied.
5. FCHs were configured at full rate for maximum SAR with "All Up" power control bits.

Parameters for Max. Power for RC1

Parameter	Units	Value
$I_{or}$	dBm/1.23 MHz	-104
$\frac{Pilot E_c}{I_{or}}$	dB	-7
$\frac{Traffic E_c}{I_{or}}$	dB	-7.4

Table.A

Parameters for Max. Power for RC3

Parameter	Units	Value
$I_{or}$	dBm/1.23 MHz	-86
$\frac{Pilot E_c}{I_{or}}$	dB	-7
$\frac{Traffic E_c}{I_{or}}$	dB	-7.4

Table.B

#### 7.2.2 Head SAR Measurement

SAR for head exposure configurations is measured in RC3 with the DUT configured to transmit at full rate using Loopback Service Option SO55. SAR for RC1 is not required when the maximum average output of each channel is less than ¼ dB higher than that measured in RC3. Otherwise, SAR is measured on the maximum output channel in RC1 using the exposure configuration that results in the highest SAR for that channel in RC3.



### 7.2.3 Body SAR Measurement

SAR for body exposure configurations is measured in RC3 with the DUT configured to transmit at full rate on FCH with all other code channels disabled using TDSO / SO32. SAR for multiple code channels (FCH + SCHn) is not required when the maximum average output of each RF channel is less than ¼ dB higher than that measured with FCH only. Otherwise, SAR is measured on the maximum output channel (FCH + SCHn) with FCH at full rate and SCH0 enabled at 9600 bps using the exposure configuration that results in the highest SAR for that channel with FCH only.

When multiple code channels are enabled, the DUT output may shift by more than 0.5 dB and lead to higher SAR drifts and SCH dropouts. Body SAR in RC1 is not required when the maximum average output of each channel is less than ¼dB higher than that measured in RC3. Otherwise, SAR is measured on the maximum output channel in RC1; with Loopback Service Option SO55, at full rate, using the body exposure configuration that results in the highest SAR for that channel in RC3 .

Band	Channel	SO2	SO2	SO55	SO55	TDSO SO32
		RC1/1	RC3/3	RC1/1	RC3/3	RC3/3
CDMA 1X	1013	24.21	24.23	24.22	24.25	24.25
	384	24.35	24.36	24.37	24.38	24.40
	777	24.42	24.44	24.43	24.44	24.45

## 8 TEST RESULTS

### 8.1 Dielectric Performance

The measured 1-gram averaged SAR values of the device against the head and the body are provided in Tables 1 and 2 respectively. The humidity and ambient temperature of test facility were 54% ~60% and 23.0 °C ~23.8°C respectively. The SAM head phantom ( SN 0381 SH ) were full of the head tissue simulating liquid. The depth of the body tissue was 15.1cm. The distance between the back of the device and the bottom of the flat phantom is 1.5cm (taking into account of the IEEE 1528 and the place of the antenna). A base station simulator was used to control the device during the SAR measurement. The phone was supplied with full-charged battery for each measurement.

For head measurement, the device was tested at the lowest, middle and highest frequencies in the transmit band.

**Table 1: Dielectric Performance of Head Tissue Simulating Liquid**

Temperature: 23.0~23.8°C, humidity: 54~60%.			
/	Frequency	Permittivity $\epsilon$	Conductivity $\sigma$ (S/m)
<b>Target value</b>	800 MHZ	41.5	0.90
<b>Validation value</b> (Sep 27 )	800 MHZ	41.47	0.902

For body-worn measurements, the device was tested against flat phantom representing the user body. Under measurement phone was put on in the belt holder.

**Table 2: Dielectric Performance of Body Tissue Simulating Liquid**

Temperature: 23.0~23.8°C, humidity: 54~60%.			
/	Frequency	Permittivity $\epsilon$	Conductivity $\sigma$ (S/m)
<b>Target value</b>	800 MHZ	55.0	1.05
<b>Validation value</b> (Sep 27 )	800 MHZ	55.32	0.966

## 8.2 Summary of Measurement Results (CDMA 800MHz Band)

Table 3: SAR Values (CDMA 800MHz Band), Measured against the head.

Temperature: 23.0~23.8°C, humidity: 54~60%.		
Limit of SAR (W/kg)	1 g Average	
	1.6	
Test Case	Measurement Result (W/kg)	
	1 g Average (W/kg)	Power level (dBm)
Left head, Touch cheek, Top frequency	0.924	24.25
Left head, Touch cheek, Mid frequency	0.590	24.40
Left head, Touch cheek, Bottom frequency	1.106	24.45
Left head, Tilt 15 Degree, Top frequency	0.383	24.25
Left head, Tilt 15 Degree, Mid frequency	0.203	24.40
Left head, Tilt 15 Degree, Bottom frequency	0.282	24.45
Right head, Touch cheek, Top frequency	1.046	24.25
Right head, Touch cheek, Mid frequency	0.822	24.40
Right head, Touch cheek, Bottom frequency	0.899	24.45
Right head, Tilt 15 Degree, Top frequency	0.330	24.25
Right head, Tilt 15 Degree, Mid frequency	0.203	24.40
Right head, Tilt 15 Degree, Bottom frequency	0.308	24.45

Table 4: SAR Values (CDMA 800 MHz Band), Measured against the body

Temperature: 23.0~23.9 ° C, humidity: 55~62%.		
Limit of SAR (W/kg)	1 g Average	
	1.6	
Test Case	Measurement Result (W/kg)	
	1 g Average (W/kg)	Power level (dBm)
Side, Top frequency	0.761	24.25
Side, Mid frequency	0.584	24.40
Side , Bottom frequency	0.738	24.45
Side , Top frequency(Face to bottom)	0.439	24.25

**Note:** The depth of the body tissue was 15.1cm. The distance between the back of the device and the bottom of the flat phantom is 1.5cm (taking into account of the IEEE 1528 and the place of the antenna).

## 8.3 Conclusion

Localized Specific Absorption Rate (SAR) of this portable wireless device has been measured in all



No.SAR07-007

---

cases requested by the relevant standards cited in Clause 5.2 of this report. Maximum localized SAR is **below** exposure limits specified in the relevant standards cited in Clause 5.1 of this test report.

## 9 Measurement Uncertainty

No	Uncertainty Component	Type	Uncertainty Value (%)	Probability Distribution	k	$c_i$	Standard Uncertainty (%) $u_i(\%)$	Degree of freedom $V_{eff}$ or $v_i$
<b>Measurement System</b>								
1	- Probe Calibration	B	3.6	N	1	1	3.60	$\infty$
2	- Axial isotropy	B	4.23	R	$\sqrt{3}$	$\sqrt{1-cp}$	0.00	$\infty$
3	- Hemispherical Isotropy	B	10.7	R	$\sqrt{3}$	$\sqrt{cp}$	6.18	$\infty$
4	- Boundary Effect	B	1.7	R	$\sqrt{3}$	1	0.98	$\infty$
5	- Linearity	B	2.98	R	$\sqrt{3}$	1	1.69	$\infty$
6	- System Detection Limits	B	0.00	R	$\sqrt{3}$	1	0.00	$\infty$
7	- Readout Electronics	B	0.00	N	1	1	0.00	$\infty$
8	- Response Time	B	0.00	R	$\sqrt{3}$	1	0.00	$\infty$
9	- Integration Time	B	0.00	R	$\sqrt{3}$	1	0.00	$\infty$
10	- RF Ambient Conditions	B	0.00	R	$\sqrt{3}$	1	0.00	$\infty$
11	- Probe Position Mechanical tolerance	B	1.14	R	$\sqrt{3}$	1	0.33	$\infty$
12	- Probe Position with respect to Phantom Shell	B	2.86	R	$\sqrt{3}$	1	0.83	$\infty$
13	- Extrapolation, Interpolation and Integration Algorithms for Max. SAR evaluation	B	3.6	R	$\sqrt{3}$	1	2.08	$\infty$
<b>Uncertainties of the DUT</b>								
14	- Position of the DUT	A	0.00	N	1	1	0.00	0
15	- Holder of the DUT	A	0.00	N	1	1	0.00	0
16	- Output Power Variation – SAR drift measurement	B	5.0	R	$\sqrt{3}$	1	2.89	$\infty$





No.SAR07-007

Phantom and Tissue Parameters								
17	- Phantom Uncertainty(shape and thickness tolerances)	B	1.43	R	$\sqrt{3}$	1	0.83	$\infty$
18	- Liquid Conductivity Target – tolerance	B	5.0	R	$\sqrt{3}$	0.7	2.02	$\infty$
19	- Liquid Conductivity – measurement Uncertainty)	B	2.0	R	$\sqrt{3}$	0.7	0.81	$\infty$
20	- Liquid Permittivity Target tolerance	B	5.0	R	$\sqrt{3}$	0.6	1.73	$\infty$
21	- Liquid Permittivity – measurement uncertainty	B	1.0	R	$\sqrt{3}$	0.6	0.35	$\infty$
<b>Combined Standard Uncertainty</b>				RSS			±8.95%	
<b>Expanded uncertainty</b> (Confidence interval of 95 %)				K= 2.003935			±17.9%	

## 10 MAIN TEST INSTRUMENTS

No.	EQUIPMENT	TYPE	Due Date
1	E-Field SAR Probe	IXP-050 (SN 0177)	2007-03-28
2	Six-axis AC Servo industrial robot	RV-2A (SN AN406018)	2007-03-28
3	Mobile Phone Tester	4405 (SN 0811211)	2007-03-28
4	System Validation Dipole 800MHZ	IXD-090 (SN 0093)	2007-03-28
5	Probe Amplifier and PC Interface	IFA-010 (SN 0027)	2007-03-28
6	Box Phantom	IXB-070	2007-03-28



**ANNEX A**  
**of**  
**ShenZhen Electronic Product Quality Testing Center**  
**CONFORMANCE TEST REPORT FOR**  
**HUMAN EXPOSURE TO ELECTROMAGNETIC FIELDS**

**SAR07-007**  
**HISENSE COMMUNICATION CO.,LTD.**  
**CDMA 800MHz**  
**Accreditation Certificate**

**This Annex consists of 2 pages**  
**Date of Report: 2007-1-29**





**ACCREDITATION CERTIFICATE  
OF CHINA NATIONAL ACCREDITATION BOARD  
FOR LABORATORIES  
(No.L1659 )**

This is to certify that

**Shenzhen Electronic Product Quality Testing Center**  
Electronic Testing Building, Shahe Road, Xili, Nanshan District,  
Shenzhen, Guangdong, China

has been assessed and proved to be in compliance with CNAL/AC01:  
*2003 Accreditation Criteria for Testing and Calibration Laboratories*  
(identical to ISO/IEC17025: 1999 *General Requirements for the  
Competence of Testing and Calibration Laboratories*).

Accreditation scope of the laboratory is listed in the attachment.

Date of Issue: 2004.10.09

Date of Expiry: 2009.10.08

**Wei Hao**

Secretary General of CNAL



**ANNEX B**  
**of**  
**ShenZhen Electronic Product Quality Testing Center**

**CONFORMANCE TEST REPORT FOR**  
**HUMAN EXPOSURE TO ELECTROMAGNETIC FIELDS**

**SAR07-007**

**HISENSE COMMUNICATION CO.,LTD.**

**CDMA 800MHz**

**Type Name: C677**

**Hardware Version : V 2.00**

**Software Version : CD5.5.00.15.IN**

**TEST LAYOUT**

**This Annex consists of 5 pages**

**Date of Report: 2007-1-29**





**Fig.1 SARA2 System Test Layout**



**Fig.2 The depth of head tissue in SAM**



**Fig.3 EUT Left Head Touch Cheek Position**



**Fig.4 EUT Left Head Tilt15 Position**



**Fig.5 EUT Right Head Touch Cheek Position**



**Fig.6 EUT Right Head Tilt15 Position**



**Fig.7 spacer 1.5cm**

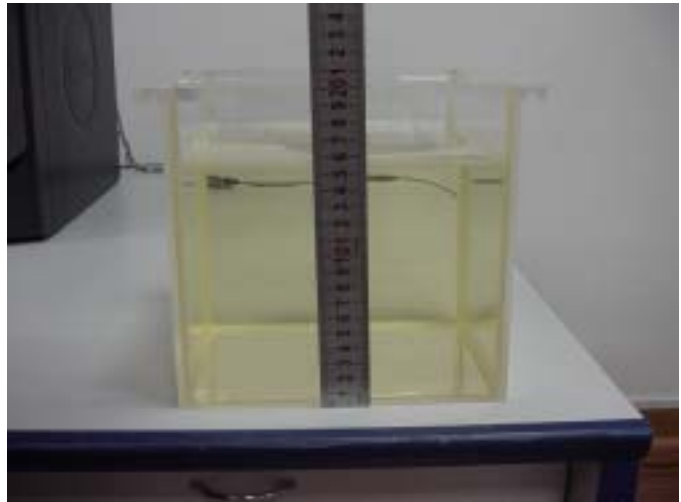

**Fig.8 the depth of body tissue**



**Fig.9 Side Position**





**ANNEX C**  
**of**  
**ShenZhen Electronic Product Quality Testing Center**

**CONFORMANCE TEST REPORT FOR**  
**HUMAN EXPOSURE TO ELECTROMAGNETIC FIELDS**

**SAR07-007**

**HISENSE COMMUNICATION CO.,LTD.**

**CDMA 800MHz**

**Type Name: C677**

**Hardware Version : V 2.00**

**Software Version : CD5.5.00.15.IN**

**Sample Photographs**

**This Annex consists of 5 pages**

**Date of Report: 2007-1-29**



# 1. Photograph of the Equipment under Test

## 1.1. Appearance





### 1.2 Inside





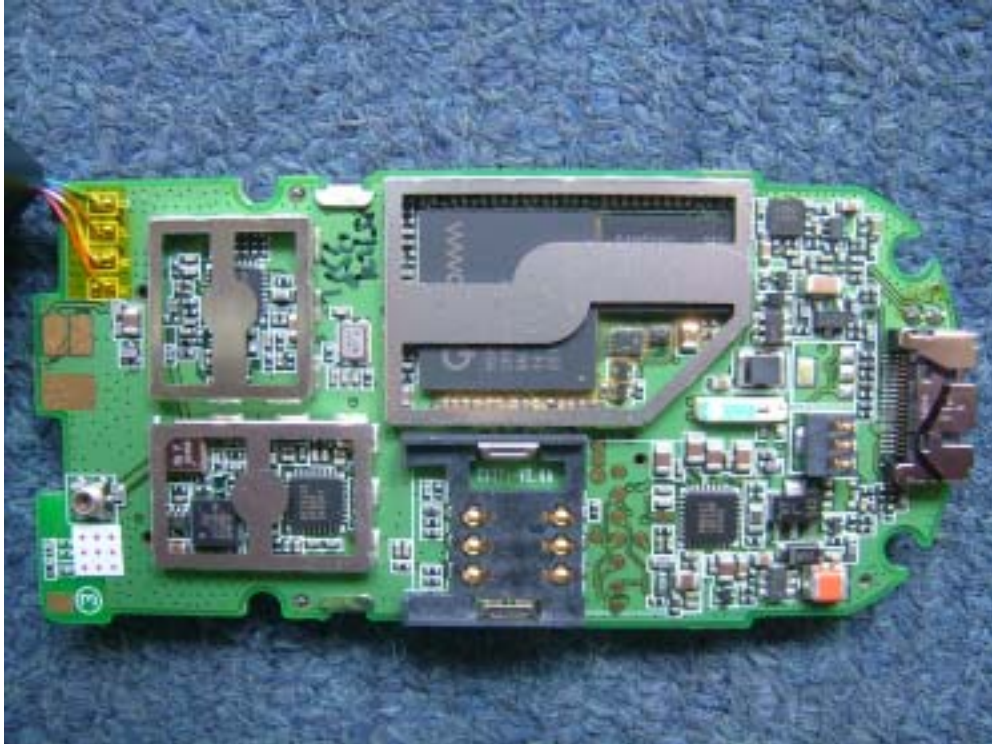



**ANNEX D**

**of**

**ShenZhen Electronic Product Quality Testing Center**

**CONFORMANCE TEST REPORT FOR  
HUMAN EXPOSURE TO ELECTROMAGNETIC FIELDS**

**SAR07-007**

**HISENSE COMMUNICATION CO.,LTD.**

**CDMA 800MHz**

**Type Name: C677**

**Hardware Version : V 2.00**

**Software Version : CD5.5.00.15.IN**

**Graph Test Results**

**This Annex consists of 17 pages**

**Date of Report : 2007-1-29**



### SAR Test CDMA 800 LH\_TouchCheek (Bottom Channel)

<b>System / software:</b>	SARA2 / 2.40 VPM	<b>Input Power Drift:</b>	0.02dB
<b>Date / Time:</b>	2007-1-26 15:55:42	<b>DUT Battery Model/No:</b>	
<b>Filename:</b>	C677_CDMA800_LH_T OUCHCHEEK_T.txt	<b>Probe Serial Number:</b>	0177
<b>Ambient Temperature:</b>	20.0°C	<b>Liquid Simulant:</b>	HEAD tissue
<b>Device Under Test:</b>	C677	<b>Relative Permittivity:</b>	41.47
<b>Relative Humidity:</b>	51%	<b>Conductivity:</b>	.902
<b>Phantom S/No:</b>	Head_380SH.csv	<b>Liquid Temperature:</b>	20.0°C
<b>Phantom Rotation:</b>	0°	<b>Max SAR Y-axis Location:</b>	-62.50 mm
<b>DUT Position:</b>	CDMA800_LH_TOUCH CHEEK	<b>Max SAR Z-axis Location:</b>	-154.00 mm
<b>Antenna Configuration:</b>	BUILD INSIDE	<b>Max E Field:</b>	33.90 V/m
<b>Test Frequency:</b>	800MHz	<b>SAR 1g:</b>	0.924 W/kg
<b>Air Factors:</b>	417.2 / 368.0 / 414.8	<b>SAR 10g:</b>	0.670 W/kg
<b>Conversion Factors:</b>	.287 / .287 / .287	<b>SAR Start:</b>	0.588 W/kg
<b>Type of Modulation:</b>	CDMA	<b>SAR End:</b>	0.612 W/kg
<b>Modn. Duty Cycle:</b>	1	<b>SAR Drift during Scan:</b>	4.05 %
<b>Diode Compression Factors (V*200):</b>	20 / 20 / 20	<b>Probe battery last changed:</b>	20/05/05
<b>Input Power Level:</b>		<b>Extrapolation:</b>	poly4

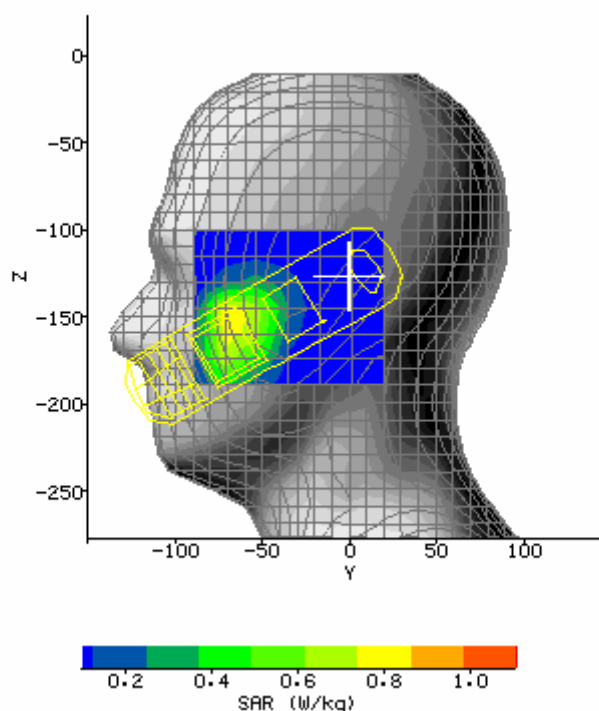

### SAR Test CDMA 800 LH\_TouchCheek (Middle Channel)

<b>System / software:</b>	SARA2 / 2.40 VPM	<b>Input Power Drift:</b>	0.00dB
<b>Date / Time:</b>	2007-1-26 16:06:20	<b>DUT Battery Model/No:</b>	
<b>Filename:</b>	C677_CDMA800_LH_T OUCHCHEEK_M.txt	<b>Probe Serial Number:</b>	0177
<b>Ambient Temperature:</b>	20.0°C	<b>Liquid Simulant:</b>	HEAD tissue
<b>Device Under Test:</b>	C677	<b>Relative Permittivity:</b>	41.47
<b>Relative Humidity:</b>	51%	<b>Conductivity:</b>	.902
<b>Phantom S/No:</b>	Head_380SH.csv	<b>Liquid Temperature:</b>	20.0°C
<b>Phantom Rotation:</b>	0°	<b>Max SAR Y-axis Location:</b>	-60.67 mm
<b>DUT Position:</b>	CDMA800_LH_TOUCH CHEEK	<b>Max SAR Z-axis Location:</b>	-158.50 mm
<b>Antenna Configuration:</b>	BUILD INSIDE	<b>Max E Field:</b>	30.92 V/m
<b>Test Frequency:</b>	800MHz	<b>SAR 1g:</b>	0.590 W/kg
<b>Air Factors:</b>	417.2 / 368.0 / 414.8	<b>SAR 10g:</b>	0.440 W/kg
<b>Conversion Factors:</b>	.287 / .287 / .287	<b>SAR Start:</b>	0.384 W/kg
<b>Type of Modulation:</b>	CDMA	<b>SAR End:</b>	0.382 W/kg
<b>Modn. Duty Cycle:</b>	1	<b>SAR Drift during Scan:</b>	-0.61 %
<b>Diode Compression Factors (V*200):</b>	20 / 20 / 20	<b>Probe battery last changed:</b>	20/05/05
<b>Input Power Level:</b>		<b>Extrapolation:</b>	poly4

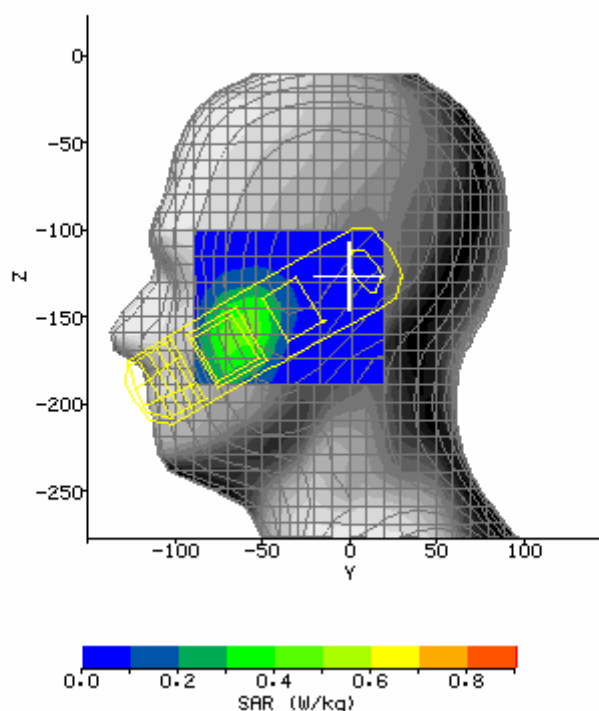



### SAR Test CDMA 800 LH\_TouchCheek (Top Channel)

<b>System / software:</b>	SARA2 / 2.40 VPM	<b>Input Power Drift:</b>	0.01dB
<b>Date / Time:</b>	2007-1-26 16:16:48	<b>DUT Battery Model/No:</b>	
<b>Filename:</b>	C677_CDMA800_LH_T OUCHCHEEK_T.txt	<b>Probe Serial Number:</b>	0177
<b>Ambient Temperature:</b>	20.0°C	<b>Liquid Simulant:</b>	HEAD tissue
<b>Device Under Test:</b>	C677	<b>Relative Permittivity:</b>	41.47
<b>Relative Humidity:</b>	51%	<b>Conductivity:</b>	.902
<b>Phantom S/No:</b>	Head_380SH.csv	<b>Liquid Temperature:</b>	20.0°C
<b>Phantom Rotation:</b>	0°	<b>Max SAR Y-axis Location:</b>	-62.50 mm
<b>DUT Position:</b>	CDMA800_LH_TOUCH CHEEK	<b>Max SAR Z-axis Location:</b>	-158.50 mm
<b>Antenna Configuration:</b>	BUILD INSIDE	<b>Max E Field:</b>	37.65 V/m
<b>Test Frequency:</b>	800MHz	<b>SAR 1g:</b>	1.106 W/kg
<b>Air Factors:</b>	417.2 / 368.0 / 414.8	<b>SAR 10g:</b>	0.816 W/kg
<b>Conversion Factors:</b>	.287 / .287 / .287	<b>SAR Start:</b>	0.740 W/kg
<b>Type of Modulation:</b>	CDMA	<b>SAR End:</b>	0.727 W/kg
<b>Modn. Duty Cycle:</b>	1	<b>SAR Drift during Scan:</b>	-1.88 %
<b>Diode Compression Factors (V*200):</b>	20 / 20 / 20	<b>Probe battery last changed:</b>	20/05/05
<b>Input Power Level:</b>		<b>Extrapolation:</b>	poly4

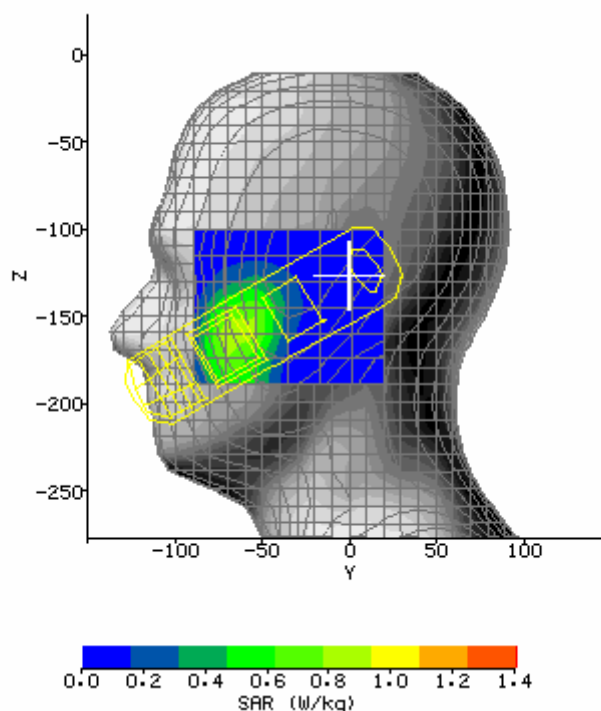



### SAR Test CDMA 800 LH\_Tilt15 (Bottom Channel)

<b>System / software:</b>	SARA2 / 2.40 VPM	<b>Input Power Drift:</b>	0.01dB
<b>Date / Time:</b>	2007-1-26 16:49:36	<b>DUT Battery Model/No:</b>	
<b>Filename:</b>	C677_CDMA800_LH_TILT15_B.txt	<b>Probe Serial Number:</b>	0177
<b>Ambient Temperature:</b>	20.0°C	<b>Liquid Simulant:</b>	HEAD tissue
<b>Device Under Test:</b>	C677	<b>Relative Permittivity:</b>	41.47
<b>Relative Humidity:</b>	51%	<b>Conductivity:</b>	.902
<b>Phantom S/No:</b>	Head_380SH.csv	<b>Liquid Temperature:</b>	20.0°C
<b>Phantom Rotation:</b>	0°	<b>Max SAR Y-axis Location:</b>	-53.33 mm
<b>DUT Position:</b>	CDMA800_LH_TILT15	<b>Max SAR Z-axis Location:</b>	-155.50 mm
<b>Antenna Configuration:</b>	BUILD INSIDE	<b>Max E Field:</b>	23.83 V/m
<b>Test Frequency:</b>	800MHz	<b>SAR 1g:</b>	0.282 W/kg
<b>Air Factors:</b>	417.2 / 368.0 / 414.8	<b>SAR 10g:</b>	0.211 W/kg
<b>Conversion Factors:</b>	.287 / .287 / .287	<b>SAR Start:</b>	0.199 W/kg
<b>Type of Modulation:</b>	CDMA	<b>SAR End:</b>	0.197 W/kg
<b>Modn. Duty Cycle:</b>	1	<b>SAR Drift during Scan:</b>	-2.01 %
<b>Diode Compression Factors (V*200):</b>	20 / 20 / 20	<b>Probe battery last changed:</b>	20/05/05
<b>Input Power Level:</b>		<b>Extrapolation:</b>	poly4

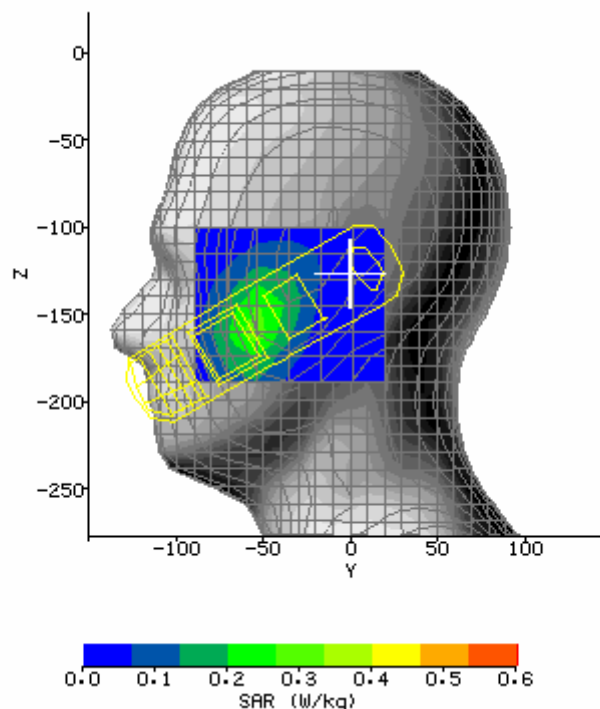



**SAR Test CDMA 800 LH\_Tilt15 (Middle Channel)**

<b>System / software:</b>	SARA2 / 2.40 VPM	<b>Input Power Drift:</b>	0.01dB
<b>Date / Time:</b>	2007-1-26 16:39:04	<b>DUT Battery Model/No:</b>	
<b>Filename:</b>	C677_CDMA800_LH_TILT15_M.txt	<b>Probe Serial Number:</b>	0177
<b>Ambient Temperature:</b>	20.0°C	<b>Liquid Simulant:</b>	HEAD tissue
<b>Device Under Test:</b>	C677	<b>Relative Permittivity:</b>	41.47
<b>Relative Humidity:</b>	51%	<b>Conductivity:</b>	.902
<b>Phantom S/No:</b>	Head_380SH.csv	<b>Liquid Temperature:</b>	20.0°C
<b>Phantom Rotation:</b>	0°	<b>Max SAR Y-axis Location:</b>	-53.33 mm
<b>DUT Position:</b>	CDMA800_LH_TILT15	<b>Max SAR Z-axis Location:</b>	-151.00 mm
<b>Antenna Configuration:</b>	BUILD INSIDE	<b>Max E Field:</b>	18.62 V/m
<b>Test Frequency:</b>	800MHz	<b>SAR 1g:</b>	0.203 W/kg
<b>Air Factors:</b>	417.2 / 368.0 / 414.8	<b>SAR 10g:</b>	0.150 W/kg
<b>Conversion Factors:</b>	.287 / .287 / .287	<b>SAR Start:</b>	0.122 W/kg
<b>Type of Modulation:</b>	CDMA	<b>SAR End:</b>	0.119 W/kg
<b>Modn. Duty Cycle:</b>	1	<b>SAR Drift during Scan:</b>	-2.10 %
<b>Diode Compression Factors (V*200):</b>	20 / 20 / 20	<b>Probe battery last changed:</b>	20/05/05
<b>Input Power Level:</b>		<b>Extrapolation:</b>	poly4

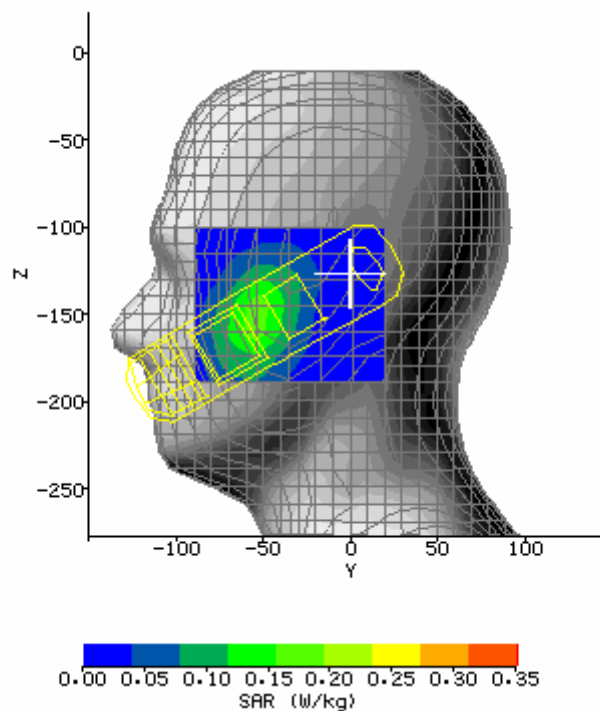



### SAR Test CDMA 800 LH\_Tilt15 (Top Channel)

<b>System / software:</b>	SARA2 / 2.40 VPM	<b>Input Power Drift:</b>	0.01dB
<b>Date / Time:</b>	2007-1-26 16:28:17	<b>DUT Battery Model/No:</b>	
<b>Filename:</b>	C677_CDMA800_LH_T ILT15_T.txt	<b>Probe Serial Number:</b>	0177
<b>Ambient Temperature:</b>	20.0°C	<b>Liquid Simulant:</b>	HEAD tissue
<b>Device Under Test:</b>	C677	<b>Relative Permittivity:</b>	41.47
<b>Relative Humidity:</b>	51%	<b>Conductivity:</b>	.902
<b>Phantom S/No:</b>	Head_380SH.csv	<b>Liquid Temperature:</b>	20.0°C
<b>Phantom Rotation:</b>	0°	<b>Max SAR Y-axis Location:</b>	-55.17 mm
<b>DUT Position:</b>	CDMA800_LH_TILT15	<b>Max SAR Z-axis Location:</b>	-152.50 mm
<b>Antenna Configuration:</b>	BUILD INSIDE	<b>Max E Field:</b>	22.86 V/m
<b>Test Frequency:</b>	800MHz	<b>SAR 1g:</b>	0.383 W/kg
<b>Air Factors:</b>	417.2 / 368.0 / 414.8	<b>SAR 10g:</b>	0.283 W/kg
<b>Conversion Factors:</b>	.287 / .287 / .287	<b>SAR Start:</b>	0.234 W/kg
<b>Type of Modulation:</b>	CDMA	<b>SAR End:</b>	0.245 W/kg
<b>Modn. Duty Cycle:</b>	1	<b>SAR Drift during Scan:</b>	4.74 %
<b>Diode Compression Factors (V*200):</b>	20 / 20 / 20	<b>Probe battery last changed:</b>	20/05/05
<b>Input Power Level:</b>		<b>Extrapolation:</b>	poly4

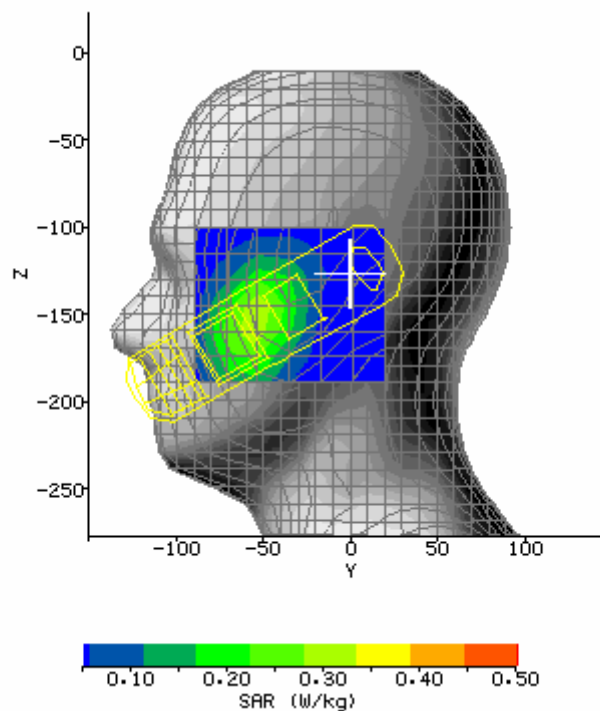

### SAR Test CDMA 800 RH\_TouchCheek (Bottom Channel)

<b>System / software:</b>	SARA2 / 2.40 VPM	<b>Input Power Drift:</b>	0.00dB
<b>Date / Time:</b>	2007-1-27 14:50:22	<b>DUT Battery Model/No:</b>	
<b>Filename:</b>	C677_CDMA800_RH_TOUCHCHEEK_B.txt	<b>Probe Serial Number:</b>	0177
<b>Ambient Temperature:</b>	20.0°C	<b>Liquid Simulant:</b>	HEAD tissue
<b>Device Under Test:</b>	C677	<b>Relative Permittivity:</b>	41.47
<b>Relative Humidity:</b>	51%	<b>Conductivity:</b>	.902
<b>Phantom S/No:</b>	Head_380SH.csv	<b>Liquid Temperature:</b>	20.0°C
<b>Phantom Rotation:</b>	180°	<b>Max SAR Y-axis Location:</b>	58.83 mm
<b>DUT Position:</b>	CDMA800_RH_TOUCHCHEEK	<b>Max SAR Z-axis Location:</b>	-167.50 mm
<b>Antenna Configuration:</b>	BUILD INSIDE	<b>Max E Field:</b>	34.09 V/m
<b>Test Frequency:</b>	800MHz	<b>SAR 1g:</b>	0.899 W/kg
<b>Air Factors:</b>	417.2 / 368.0 / 414.8	<b>SAR 10g:</b>	0.645 W/kg
<b>Conversion Factors:</b>	.287 / .287 / .287	<b>SAR Start:</b>	0.592 W/kg
<b>Type of Modulation:</b>	CDMA	<b>SAR End:</b>	0.596 W/kg
<b>Modn. Duty Cycle:</b>	1	<b>SAR Drift during Scan:</b>	0.72 %
<b>Diode Compression Factors (V*200):</b>	20 / 20 / 20	<b>Probe battery last changed:</b>	20/05/05
<b>Input Power Level:</b>		<b>Extrapolation:</b>	poly4

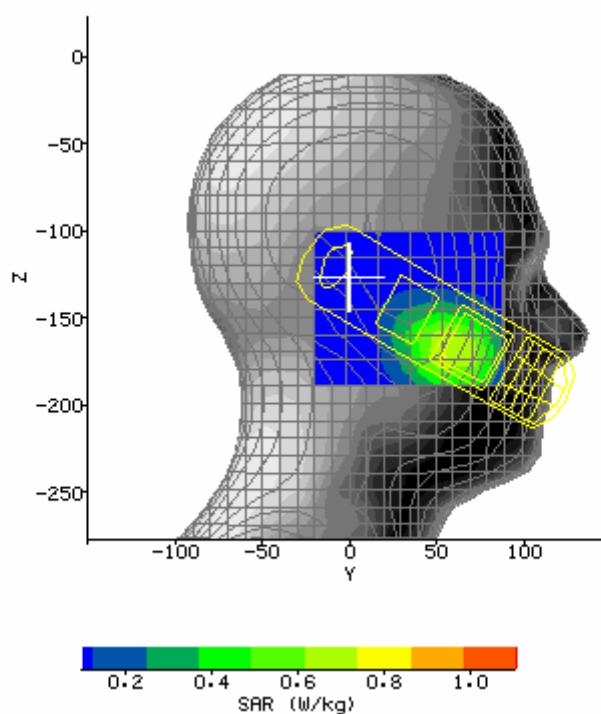

### SAR Test CDMA 800 RH\_TouchCheek (Middle Channel)

<b>System / software:</b>	SARA2 / 2.40 VPM	<b>Input Power Drift:</b>	0.01dB
<b>Date / Time:</b>	2007-1-27 14:39:56	<b>DUT Battery Model/No:</b>	
<b>Filename:</b>	C677_CDMA800_RH_TOUCHCHEEK_M.txt	<b>Probe Serial Number:</b>	0177
<b>Ambient Temperature:</b>	20.0°C	<b>Liquid Simulant:</b>	HEAD tissue
<b>Device Under Test:</b>	C677	<b>Relative Permittivity:</b>	41.47
<b>Relative Humidity:</b>	51%	<b>Conductivity:</b>	.902
<b>Phantom S/No:</b>	Head_380SH.csv	<b>Liquid Temperature:</b>	20.0°C
<b>Phantom Rotation:</b>	180°	<b>Max SAR Y-axis Location:</b>	58.83 mm
<b>DUT Position:</b>	CDMA800_RH_TOUCHCHEEK	<b>Max SAR Z-axis Location:</b>	-167.50 mm
<b>Antenna Configuration:</b>	BUILD INSIDE	<b>Max E Field:</b>	33.97 V/m
<b>Test Frequency:</b>	800MHz	<b>SAR 1g:</b>	0.822 W/kg
<b>Air Factors:</b>	417.2 / 368.0 / 414.8	<b>SAR 10g:</b>	0.474 W/kg
<b>Conversion Factors:</b>	.287 / .287 / .287	<b>SAR Start:</b>	0.401 W/kg
<b>Type of Modulation:</b>	CDMA	<b>SAR End:</b>	0.396 W/kg
<b>Modn. Duty Cycle:</b>	1	<b>SAR Drift during Scan:</b>	-1.28 %
<b>Diode Compression Factors (V*200):</b>	20 / 20 / 20	<b>Probe battery last changed:</b>	20/05/05
<b>Input Power Level:</b>		<b>Extrapolation:</b>	poly4

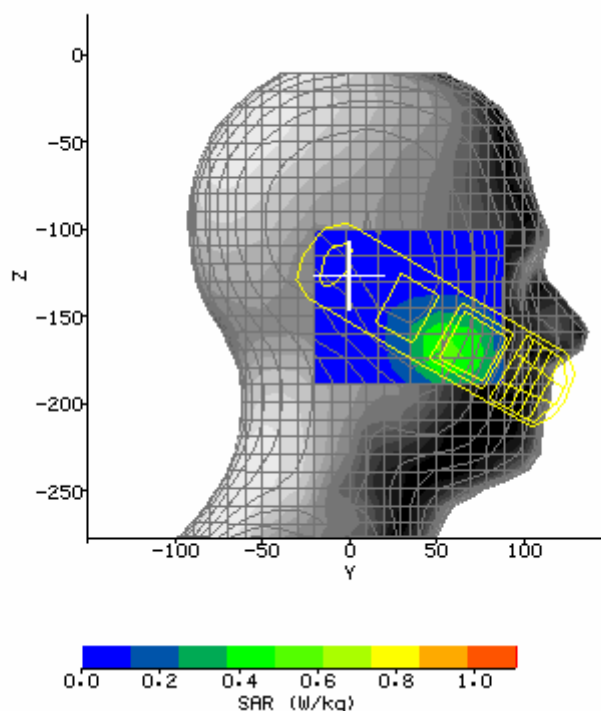

### SAR Test CDMA 800 RH\_TouchCheek (Top Channel)

<b>System / software:</b>	SARA2 / 2.40 VPM	<b>Input Power Drift:</b>	0.02dB
<b>Date / Time:</b>	2007-1-27 15:00:29	<b>DUT Battery Model/No:</b>	
<b>Filename:</b>	C677_CDMA800_RH_TOUCHCHEEK_T.txt	<b>Probe Serial Number:</b>	0177
<b>Ambient Temperature:</b>	20.0°C	<b>Liquid Simulant:</b>	HEAD tissue
<b>Device Under Test:</b>	C677	<b>Relative Permittivity:</b>	41.47
<b>Relative Humidity:</b>	51%	<b>Conductivity:</b>	.902
<b>Phantom S/No:</b>	Head_380SH.csv	<b>Liquid Temperature:</b>	20.0°C
<b>Phantom Rotation:</b>	180°	<b>Max SAR Y-axis Location:</b>	58.83 mm
<b>DUT Position:</b>	CDMA800_RH_TOUCHCHEEK	<b>Max SAR Z-axis Location:</b>	-167.50 mm
<b>Antenna Configuration:</b>	BUILD INSIDE	<b>Max E Field:</b>	39.00 V/m
<b>Test Frequency:</b>	800MHz	<b>SAR 1g:</b>	1.046 W/kg
<b>Air Factors:</b>	417.2 / 368.0 / 414.8	<b>SAR 10g:</b>	0.749 W/kg
<b>Conversion Factors:</b>	.287 / .287 / .287	<b>SAR Start:</b>	0.697 W/kg
<b>Type of Modulation:</b>	CDMA	<b>SAR End:</b>	0.707 W/kg
<b>Modn. Duty Cycle:</b>	1	<b>SAR Drift during Scan:</b>	1.46 %
<b>Diode Compression Factors (V*200):</b>	20 / 20 / 20	<b>Probe battery last changed:</b>	20/05/05
<b>Input Power Level:</b>		<b>Extrapolation:</b>	poly4

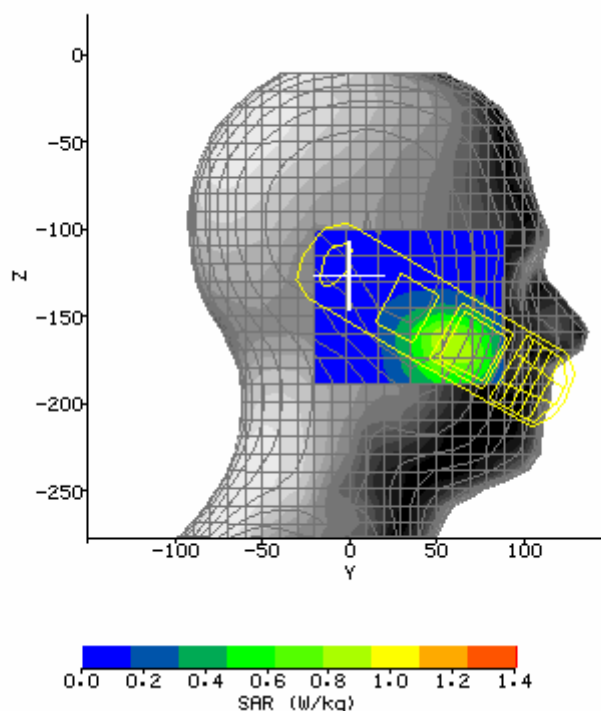

**SAR Test CDMA 800 RH\_Tilt15 (Bottom Channel)**

<b>System / software:</b>	SARA2 / 2.40 VPM	<b>Input Power Drift:</b>	0.02dB
<b>Date / Time:</b>	2007-1-27 15:32:43	<b>DUT Battery Model/No:</b>	
<b>Filename:</b>	C677_CDMA800_RH_TILT15_B.txt	<b>Probe Serial Number:</b>	0177
<b>Ambient Temperature:</b>	20.0°C	<b>Liquid Simulant:</b>	HEAD tissue
<b>Device Under Test:</b>	C677	<b>Relative Permittivity:</b>	41.47
<b>Relative Humidity:</b>	51%	<b>Conductivity:</b>	.902
<b>Phantom S/No:</b>	Head_380SH.csv	<b>Liquid Temperature:</b>	20.0°C
<b>Phantom Rotation:</b>	180°	<b>Max SAR Y-axis Location:</b>	51.50 mm
<b>DUT Position:</b>	CDMA800_RH_TILT15	<b>Max SAR Z-axis Location:</b>	-164.50 mm
<b>Antenna Configuration:</b>	BUILD INSIDE	<b>Max E Field:</b>	23.03 V/m
<b>Test Frequency:</b>	800MHz	<b>SAR 1g:</b>	0.308 W/kg
<b>Air Factors:</b>	417.2 / 368.0 / 414.8	<b>SAR 10g:</b>	0.218 W/kg
<b>Conversion Factors:</b>	.287 / .287 / .287	<b>SAR Start:</b>	0.189 W/kg
<b>Type of Modulation:</b>	CDMA	<b>SAR End:</b>	0.192 W/kg
<b>Modn. Duty Cycle:</b>	1	<b>SAR Drift during Scan:</b>	1.83 %
<b>Diode Compression Factors (V*200):</b>	20 / 20 / 20	<b>Probe battery last changed:</b>	20/05/05
<b>Input Power Level:</b>		<b>Extrapolation:</b>	poly4

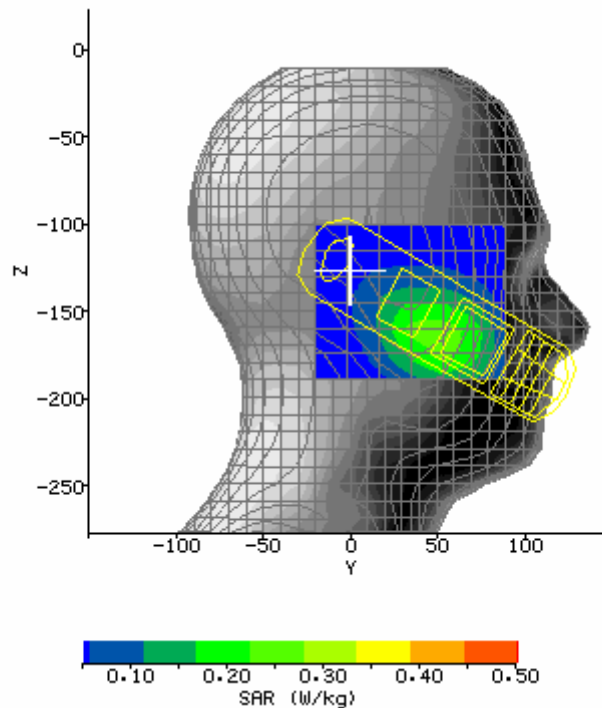



### SAR Test CDMA 800 RH\_Tilt15 (Middle Channel)

<b>System / software:</b>	SARA2 / 2.40 VPM	<b>Input Power Drift:</b>	0.02dB
<b>Date / Time:</b>	2007-1-27 15:22:07	<b>DUT Battery Model/No:</b>	
<b>Filename:</b>	C677_CDMA800_RH_TILT15_M.txt	<b>Probe Serial Number:</b>	0177
<b>Ambient Temperature:</b>	20.0°C	<b>Liquid Simulant:</b>	HEAD tissue
<b>Device Under Test:</b>	C677	<b>Relative Permittivity:</b>	41.47
<b>Relative Humidity:</b>	51%	<b>Conductivity:</b>	.902
<b>Phantom S/No:</b>	Head_380SH.csv	<b>Liquid Temperature:</b>	20.0°C
<b>Phantom Rotation:</b>	180°	<b>Max SAR Y-axis Location:</b>	51.50 mm
<b>DUT Position:</b>	CDMA800_RH_TILT15	<b>Max SAR Z-axis Location:</b>	-163.00 mm
<b>Antenna Configuration:</b>	BUILD INSIDE	<b>Max E Field:</b>	15.91 V/m
<b>Test Frequency:</b>	800MHz	<b>SAR 1g:</b>	0.203 W/kg
<b>Air Factors:</b>	417.2 / 368.0 / 414.8	<b>SAR 10g:</b>	0.133 W/kg
<b>Conversion Factors:</b>	.287 / .287 / .287	<b>SAR Start:</b>	0.119 W/kg
<b>Type of Modulation:</b>	CDMA	<b>SAR End:</b>	0.117 W/kg
<b>Modn. Duty Cycle:</b>	1	<b>SAR Drift during Scan:</b>	-2.42 %
<b>Diode Compression Factors (V*200):</b>	20 / 20 / 20	<b>Probe battery last changed:</b>	20/05/05
<b>Input Power Level:</b>		<b>Extrapolation:</b>	poly4

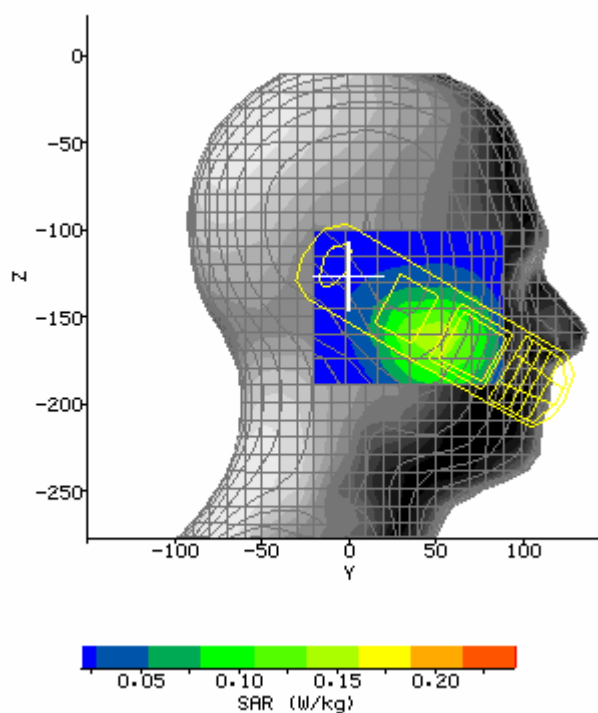

### SAR Test CDMA 800 RH\_Tilt15 (Top Channel)

<b>System / software:</b>	SARA2 / 2.40 VPM	<b>Input Power Drift:</b>	0.02dB
<b>Date / Time:</b>	2007-1-27 15:11:30	<b>DUT Battery Model/No:</b>	
<b>Filename:</b>	C677_CDMA800_RH_TILT15_T.txt	<b>Probe Serial Number:</b>	0177
<b>Ambient Temperature:</b>	20.0°C	<b>Liquid Simulant:</b>	HEAD tissue
<b>Device Under Test:</b>	C677	<b>Relative Permittivity:</b>	41.47
<b>Relative Humidity:</b>	51%	<b>Conductivity:</b>	.902
<b>Phantom S/No:</b>	Head_380SH.csv	<b>Liquid Temperature:</b>	20.0°C
<b>Phantom Rotation:</b>	180°	<b>Max SAR Y-axis Location:</b>	57.00 mm
<b>DUT Position:</b>	CDMA800_RH_TILT15	<b>Max SAR Z-axis Location:</b>	-169.00 mm
<b>Antenna Configuration:</b>	BUILD INSIDE	<b>Max E Field:</b>	20.97 V/m
<b>Test Frequency:</b>	800MHz	<b>SAR 1g:</b>	0.330 W/kg
<b>Air Factors:</b>	417.2 / 368.0 / 414.8	<b>SAR 10g:</b>	0.253 W/kg
<b>Conversion Factors:</b>	.287 / .287 / .287	<b>SAR Start:</b>	0.224 W/kg
<b>Type of Modulation:</b>	CDMA	<b>SAR End:</b>	0.214 W/kg
<b>Modn. Duty Cycle:</b>	1	<b>SAR Drift during Scan:</b>	-4.34 %
<b>Diode Compression Factors (V*200):</b>	20 / 20 / 20	<b>Probe battery last changed:</b>	20/05/05
<b>Input Power Level:</b>		<b>Extrapolation:</b>	poly4

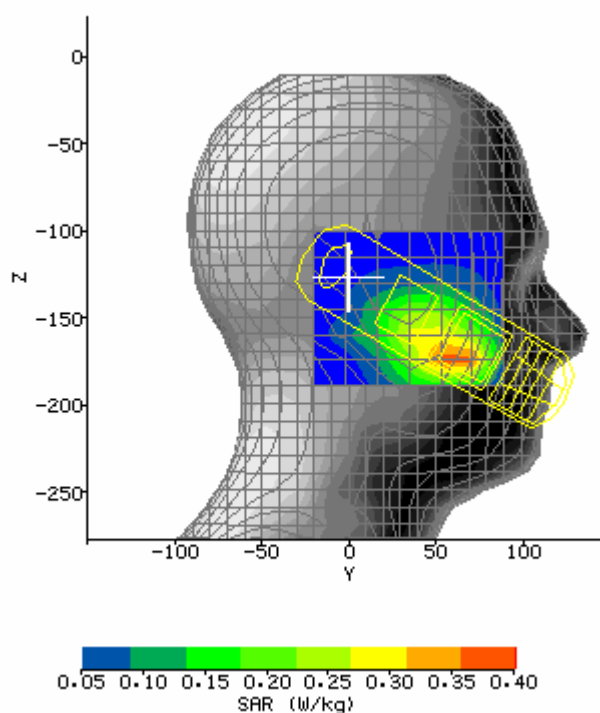

### SAR Test CDMA 800 Side (Bottom Channel)

<b>System / software:</b>	SARA2 / 2.40 VPM	<b>Input Power Drift:</b>	0.02dB
<b>Date / Time:</b>	2007-1-26 15:04:31	<b>DUT Battery Model/No:</b>	
<b>Filename:</b>	C677_CDMA800_BOD Y_B.txt	<b>Probe Serial Number:</b>	0177
<b>Ambient Temperature:</b>	20.0°C	<b>Liquid Simulant:</b>	BODY tissue
<b>Device Under Test:</b>	C677	<b>Relative Permittivity:</b>	55.32
<b>Relative Humidity:</b>	51%	<b>Conductivity:</b>	.966
<b>Phantom S/No:</b>	HeadBox75mm.csv	<b>Liquid Temperature:</b>	20.0°C
<b>Phantom Rotation:</b>	0°	<b>Max SAR X-axis Location:</b>	13.71 mm
<b>DUT Position:</b>	CDMA800_BODY	<b>Max SAR Y-axis Location:</b>	-20.57 mm
<b>Antenna Configuration:</b>	BUILD INSIDE	<b>Max E Field:</b>	30.92 V/m
<b>Test Frequency:</b>	800MHz	<b>SAR 1g:</b>	0.738 W/kg
<b>Air Factors:</b>	417 / 368 / 414	<b>SAR 10g:</b>	0.566 W/kg
<b>Conversion Factors:</b>	.271 / .271 / .271	<b>SAR Start:</b>	0.309 W/kg
<b>Type of Modulation:</b>	CDMA	<b>SAR End:</b>	0.321 W/kg
<b>Modn. Duty Cycle:</b>	1	<b>SAR Drift during Scan:</b>	3.80 %
<b>Diode Compression Factors (V*200):</b>	20 / 20 / 20	<b>Probe battery last changed:</b>	20/05/05
<b>Input Power Level:</b>		<b>Extrapolation:</b>	poly4

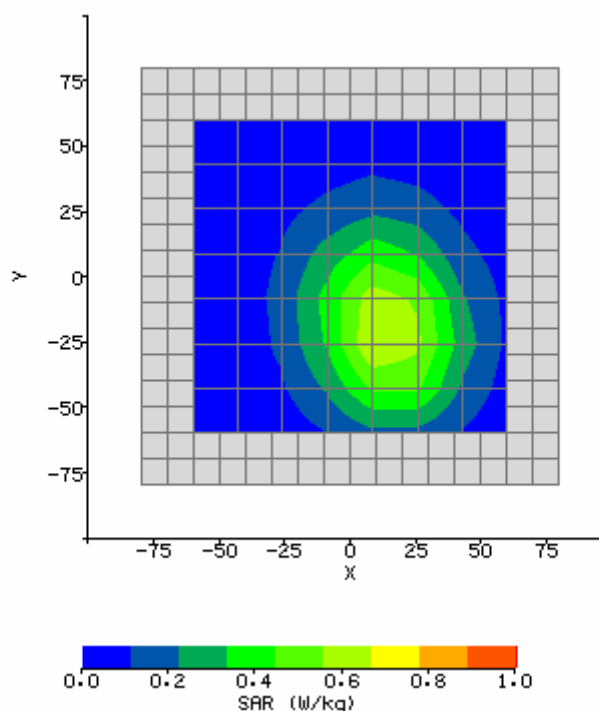

### SAR Test CDMA 800 Side (Middle Channel)

<b>System / software:</b>	SARA2 / 2.40 VPM	<b>Input Power Drift:</b>	0.02dB
<b>Date / Time:</b>	2007-1-26 15:14:18	<b>DUT Battery Model/No:</b>	
<b>Filename:</b>	C677_CDMA800_BOD Y_M.txt	<b>Probe Serial Number:</b>	0177
<b>Ambient Temperature:</b>	20.0°C	<b>Liquid Simulant:</b>	BODY tissue
<b>Device Under Test:</b>	C677	<b>Relative Permittivity:</b>	55.32
<b>Relative Humidity:</b>	51%	<b>Conductivity:</b>	.966
<b>Phantom S/No:</b>	HeadBox75mm.csv	<b>Liquid Temperature:</b>	20.0°C
<b>Phantom Rotation:</b>	0°	<b>Max SAR X-axis Location:</b>	15.43 mm
<b>DUT Position:</b>	CDMA800_BODY	<b>Max SAR Y-axis Location:</b>	-22.29 mm
<b>Antenna Configuration:</b>	BUILD INSIDE	<b>Max E Field:</b>	26.83 V/m
<b>Test Frequency:</b>	800MHz	<b>SAR 1g:</b>	0.584 W/kg
<b>Air Factors:</b>	417 / 368 / 414	<b>SAR 10g:</b>	0.337 W/kg
<b>Conversion Factors:</b>	.271 / .271 / .271	<b>SAR Start:</b>	0.210 W/kg
<b>Type of Modulation:</b>	CDMA	<b>SAR End:</b>	0.217 W/kg
<b>Modn. Duty Cycle:</b>	1	<b>SAR Drift during Scan:</b>	3.12 %
<b>Diode Compression Factors (V*200):</b>	20 / 20 / 20	<b>Probe battery last changed:</b>	20/05/05
<b>Input Power Level:</b>		<b>Extrapolation:</b>	poly4

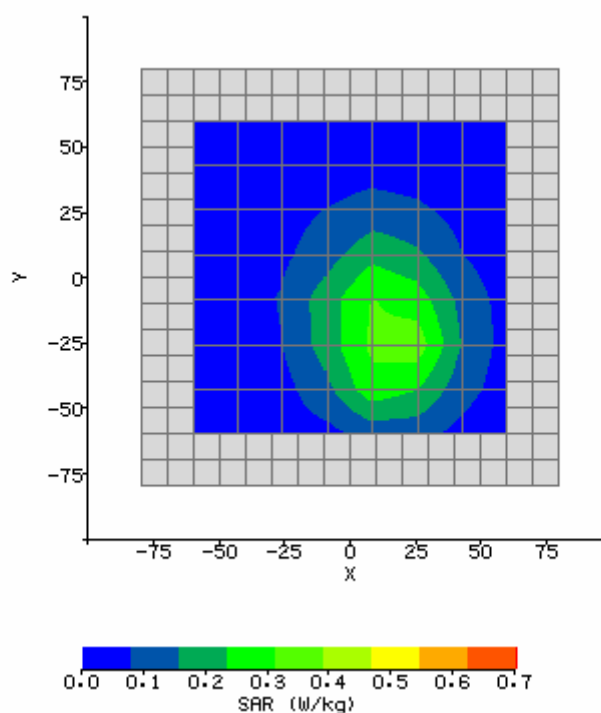

### SAR Test CDMA 800 Side (Top Channel)

<b>System / software:</b>	SARA2 / 2.40 VPM	<b>Input Power Drift:</b>	0.02dB
<b>Date / Time:</b>	2007-1-26 15:24:10	<b>DUT Battery Model/No:</b>	
<b>Filename:</b>	C677_CDMA800_BOD Y_T.txt	<b>Probe Serial Number:</b>	0177
<b>Ambient Temperature:</b>	20.0°C	<b>Liquid Simulant:</b>	BODY tissue
<b>Device Under Test:</b>	C677	<b>Relative Permittivity:</b>	55.32
<b>Relative Humidity:</b>	51%	<b>Conductivity:</b>	.966
<b>Phantom S/No:</b>	HeadBox75mm.csv	<b>Liquid Temperature:</b>	20.0°C
<b>Phantom Rotation:</b>	0°	<b>Max SAR X-axis Location:</b>	15.43 mm
<b>DUT Position:</b>	CDMA800_BODY	<b>Max SAR Y-axis Location:</b>	-18.86 mm
<b>Antenna Configuration:</b>	BUILD INSIDE	<b>Max E Field:</b>	27.22 V/m
<b>Test Frequency:</b>	800MHz	<b>SAR 1g:</b>	0.761 W/kg
<b>Air Factors:</b>	417 / 368 / 414	<b>SAR 10g:</b>	0.580 W/kg
<b>Conversion Factors:</b>	.271 / .271 / .271	<b>SAR Start:</b>	0.328 W/kg
<b>Type of Modulation:</b>	CDMA	<b>SAR End:</b>	0.321 W/kg
<b>Modn. Duty Cycle:</b>	1	<b>SAR Drift during Scan:</b>	-2.09 %
<b>Diode Compression Factors (V*200):</b>	20 / 20 / 20	<b>Probe battery last changed:</b>	20/05/05
<b>Input Power Level:</b>		<b>Extrapolation:</b>	poly4

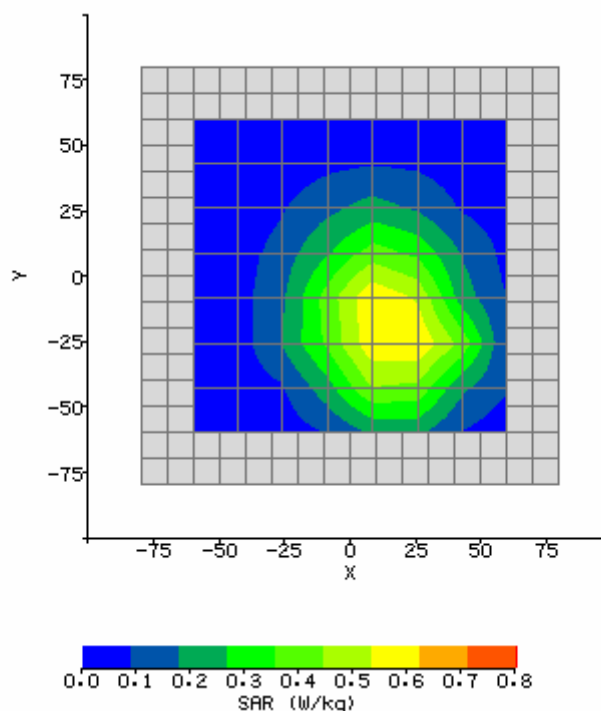

### SAR Test CDMA 800 Side (Top Channel, Face to Bottom)

<b>System / software:</b>	SARA2 / 2.40 VPM	<b>Input Power Drift:</b>	0.01dB
<b>Date / Time:</b>	2007-1-26 15:34:15	<b>DUT Battery Model/No:</b>	
<b>Filename:</b>	C677_CDMA800_BOD Y_T_FACETOBOTTOM .txt	<b>Probe Serial Number:</b>	0177
<b>Ambient Temperature:</b>	20.0°C	<b>Liquid Simulant:</b>	BODY tissue
<b>Device Under Test:</b>	C677	<b>Relative Permittivity:</b>	55.32
<b>Relative Humidity:</b>	51%	<b>Conductivity:</b>	.966
<b>Phantom S/No:</b>	HeadBox75mm.csv	<b>Liquid Temperature:</b>	20.0°C
<b>Phantom Rotation:</b>	0°	<b>Max SAR X-axis Location:</b>	-5.14 mm
<b>DUT Position:</b>	CDMA800_BODY	<b>Max SAR Y-axis Location:</b>	-24.00 mm
<b>Antenna Configuration:</b>	BUILD INSIDE	<b>Max E Field:</b>	23.46 V/m
<b>Test Frequency:</b>	800MHz	<b>SAR 1g:</b>	0.439 W/kg
<b>Air Factors:</b>	417 / 368 / 414	<b>SAR 10g:</b>	0.333 W/kg
<b>Conversion Factors:</b>	.271 / .271 / .271	<b>SAR Start:</b>	0.188 W/kg
<b>Type of Modulation:</b>	CDMA	<b>SAR End:</b>	0.185 W/kg
<b>Modn. Duty Cycle:</b>	1	<b>SAR Drift during Scan:</b>	-1.47 %
<b>Diode Compression Factors (V*200):</b>	20 / 20 / 20	<b>Probe battery last changed:</b>	20/05/05
<b>Input Power Level:</b>		<b>Extrapolation:</b>	poly4

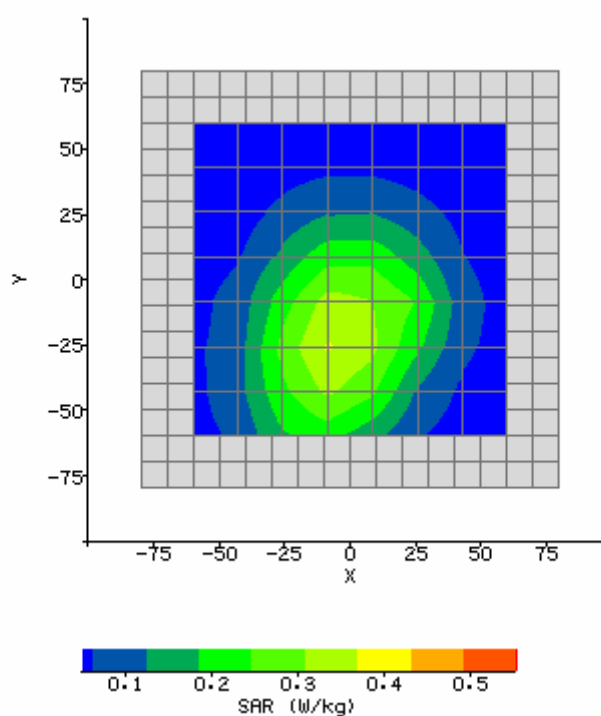

### Annex E: System Performance Check Data

<b>System / software:</b>	SARA2 / 2.40 VPM	<b>Input Power Drift:</b>	-0.03dB
<b>Date / Time:</b>	2006-12-25 8:15:12	<b>DUT Battery Model/No:</b>	
<b>Filename:</b>	System Cheek_Head _800MHz.txt	<b>Probe Serial Number:</b>	0177
<b>Ambient Temperature:</b>	23.3°C	<b>Liquid Simulant:</b>	Head tissue
<b>Device Under Test:</b>	IXD-090antenna (250mw)	<b>Relative Permittivity:</b>	41.47
<b>Relative Humidity:</b>	59%	<b>Conductivity:</b>	.902
<b>Phantom S/No:</b>	HeadBox75mm.csv	<b>Liquid Temperature:</b>	19.8°C
<b>Phantom Rotation:</b>	0°	<b>Max SAR Y-axis Location:</b>	5.35 mm
<b>DUT Position:</b>	800_Head	<b>Max SAR Z-axis Location:</b>	-213.02 mm
<b>Antenna Configuration:</b>	IXD-090antenna	<b>Max E Field:</b>	47.03 V/m
<b>Test Frequency:</b>	800MHz	<b>SAR 1g:</b>	2.632 W/kg
<b>Air Factors:</b>	417.2 / 368.0 / 414.8	<b>SAR 10g:</b>	1.753 W/kg
<b>Conversion Factors:</b>	.287 / .287 / .287	<b>SAR Start:</b>	0.605 W/kg
<b>Type of Modulation:</b>	/	<b>SAR End:</b>	0.596 W/kg
<b>Modn. Duty Cycle:</b>	1	<b>SAR Drift during Scan:</b>	-1.51 %
<b>Diode Compression Factors (V*200):</b>	20 / 20 / 20	<b>Probe battery last changed:</b>	20/05/05
<b>Input Power Level:</b>	24dBm	<b>Extrapolation:</b>	poly4

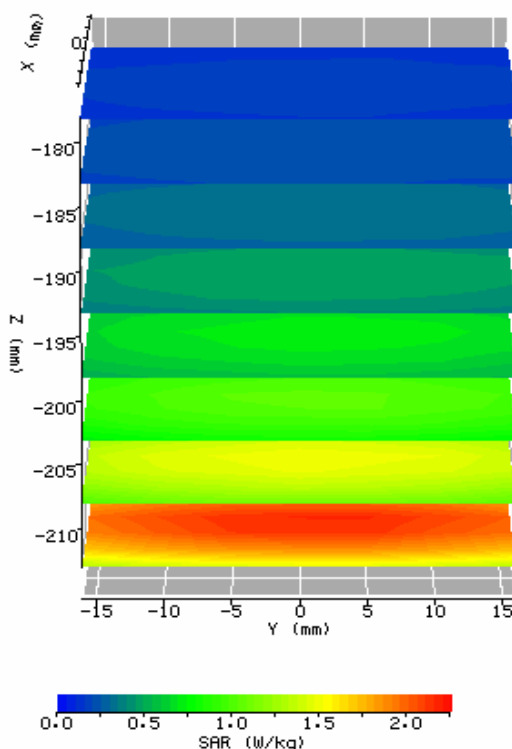

<b>System / software:</b>	SARA2 / 2.40 VPM	<b>Input Power Drift:</b>	0.02dB
<b>Date / Time:</b>	2006-12-25 9:20:12	<b>DUT Battery Model/No:</b>	
<b>Filename:</b>	System Cheek_Body _800MHz.txt	<b>Probe Serial Number:</b>	0177
<b>Ambient Temperature:</b>	23.5°C	<b>Liquid Simulant:</b>	Body tissue
<b>Device Under Test:</b>	IXD-090antenna (250mw)	<b>Relative Permittivity:</b>	55.32
<b>Relative Humidity:</b>	57%	<b>Conductivity:</b>	.966
<b>Phantom S/No:</b>	HeadBox75mm.csv	<b>Liquid Temperature:</b>	19.9°C
<b>Phantom Rotation:</b>	0°	<b>Max SAR X-axis Location:</b>	0.00 mm
<b>DUT Position:</b>	800_Body	<b>Max SAR Y-axis Location:</b>	0.00 mm
<b>Antenna Configuration:</b>	IXD-090antenna	<b>Max E Field:</b>	44.80 V/m
<b>Test Frequency:</b>	800MHz	<b>SAR 1g:</b>	2.566 W/kg
<b>Air Factors:</b>	417 / 368 / 414	<b>SAR 10g:</b>	1.670W/kg
<b>Conversion Factors:</b>	.271 / .271 / .271	<b>SAR Start:</b>	0.538 W/kg
<b>Type of Modulation:</b>	/	<b>SAR End:</b>	0.541 W/kg
<b>Modn. Duty Cycle:</b>	1	<b>SAR Drift during Scan:</b>	0.52 %
<b>Diode Compression Factors (V*200):</b>	20 / 20 / 20	<b>Probe battery last changed:</b>	20/05/05
<b>Input Power Level:</b>	24dBm	<b>Extrapolation:</b>	poly4

