

APPENDIX A: TEST DATA

Liquid Level Photo

MSL 2450MHz D=152mm



Test Laboratory: Advance Data Technology

H70-11b-Ch1-Mode 1

DUT: Notebook ; Type: H70 ; Test Frequency: 2412 MHz

Communication System: 802.11b ; Frequency: 2412 MHz ; Duty Cycle: 1:1

Medium: MSL2450 Medium parameters used: $f = 2412$ MHz; $\sigma = 1.97$ mho/m; $\epsilon_r = 53.8$; $\rho = 1000$ kg/m³ ; Liquid Level : 152 mm

Phantom section: Flat Section ; DUT test position : Body ; Modulation Type: CCK

Separation Distance : 0 mm (The bottom side of the EUT to the Phantom)

Antenna Type : PIFA Antenna ; Air Temp. : 22.1 degrees ; Liquid Temp. : 21.0 degrees

DASY4 Configuration:

- Probe: ET3DV6 - SN1790 ; ConvF(4.35, 4.35, 4.35) ; Calibrated: 2004/12/20
- Sensor-Surface: 4mm (Mechanical Surface Detection)
- Electronics: DAE3 Sn579 ; Calibrated: 2005/3/23
- Phantom: SAM 12 ; Type: SAM V4.0; Serial: TP 1202
- Measurement SW: DASY4, V4.6 Build 23 ; Postprocessing SW: SEMCAD, V1.8 Build 160

Low Channel 1/Area Scan (11x17x1): Measurement grid: dx=15mm, dy=15mm

Maximum value of SAR (measured) = 0.010 mW/g

Low Channel 1/Zoom Scan (7x7x7)/Cube 0: Measurement grid: dx=5mm, dy=5mm, dz=5mm

Reference Value = 2.51 V/m

Peak SAR (extrapolated) = 0.035 W/kg

SAR(1 g) = 0.010 mW/g; SAR(10 g) = 0.00351 mW/g

Maximum value of SAR (measured) = 0.013 mW/g

Low Channel 1/Zoom Scan (7x7x7)/Cube 1: Measurement grid: dx=5mm, dy=5mm, dz=5mm

Reference Value = 2.51 V/m

Peak SAR (extrapolated) = 0.043 W/kg

SAR(1 g) = 0.011 mW/g; SAR(10 g) = 0.00432 mW/g

Maximum value of SAR (measured) = 0.018 mW/g

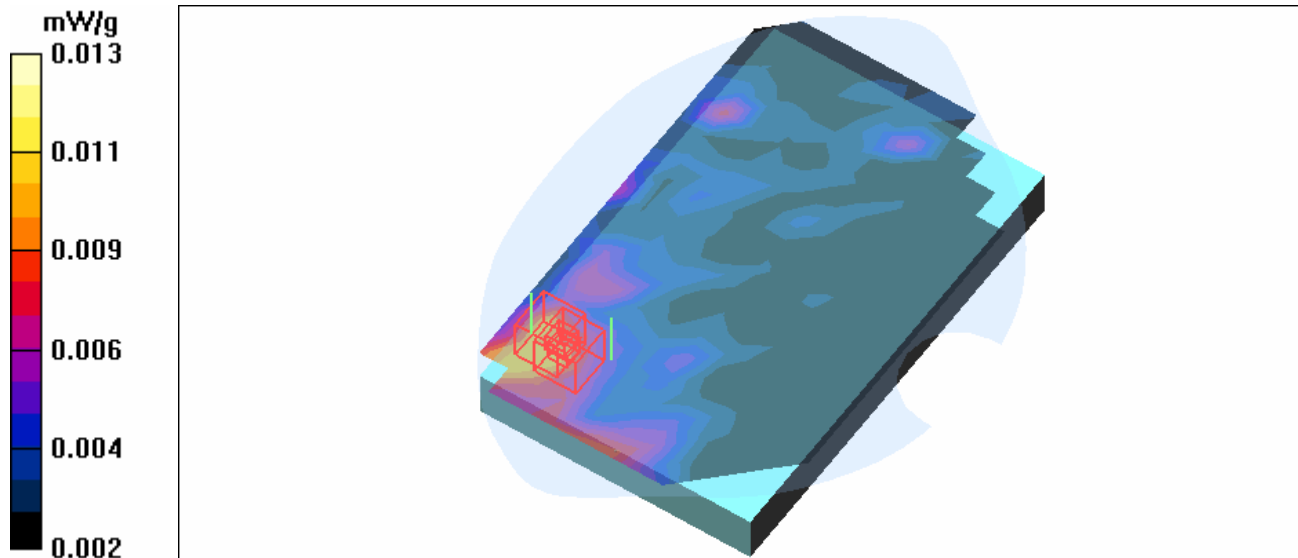

Test Laboratory: Advance Data Technology

H70-11b-11b-Ch6-Mode 1

DUT: Notebook ; Type: H70 ; Test Frequency: 2437 MHz

Communication System: 802.11b ; Frequency: 2437 MHz ; Duty Cycle: 1:1

Medium: MSL2450 Medium parameters used: $f = 2437$ MHz; $\sigma = 2$ mho/m; $\epsilon_r = 53.7$; $\rho = 1000$ kg/m³ ; Liquid Level : 152 mm

Phantom section: Flat Section ; DUT test position : Body ; Modulation Type: CCK

Separation Distance : 0 mm (The bottom side of the EUT to the Phantom)

Antenna Type : PIFA Antenna ; Air Temp. : 22.1 degrees ; Liquid Temp. : 21.0 degrees

DASY4 Configuration:

- Probe: ET3DV6 - SN1790 ; ConvF(4.35, 4.35, 4.35) ; Calibrated: 2004/12/20

- Sensor-Surface: 4mm (Mechanical Surface Detection)

- Electronics: DAE3 Sn579 ; Calibrated: 2005/3/23

- Phantom: SAM 12 ; Type: SAM V4.0; Serial: TP 1202

- Measurement SW: DASY4, V4.6 Build 23 ; Postprocessing SW: SEMCAD, V1.8 Build 160

Mid Channel 6/Area Scan (11x17x1): Measurement grid: dx=15mm, dy=15mm

Maximum value of SAR (measured) = 0.011 mW/g

Mid Channel 6/Zoom Scan (7x7x7)/Cube 0: Measurement grid: dx=5mm, dy=5mm, dz=5mm

Reference Value = 2.44 V/m

Peak SAR (extrapolated) = 0.051 W/kg

SAR(1 g) = 0.012 mW/g; SAR(10 g) = 0.00511 mW/g

Maximum value of SAR (measured) = 0.014 mW/g

Mid Channel 6/Zoom Scan (7x7x7)/Cube 1: Measurement grid: dx=5mm, dy=5mm, dz=5mm

Reference Value = 2.44 V/m

Peak SAR (extrapolated) = 0.042 W/kg

SAR(1 g) = 0.00865 mW/g; SAR(10 g) = 0.00313 mW/g

Maximum value of SAR (measured) = 0.015 mW/g

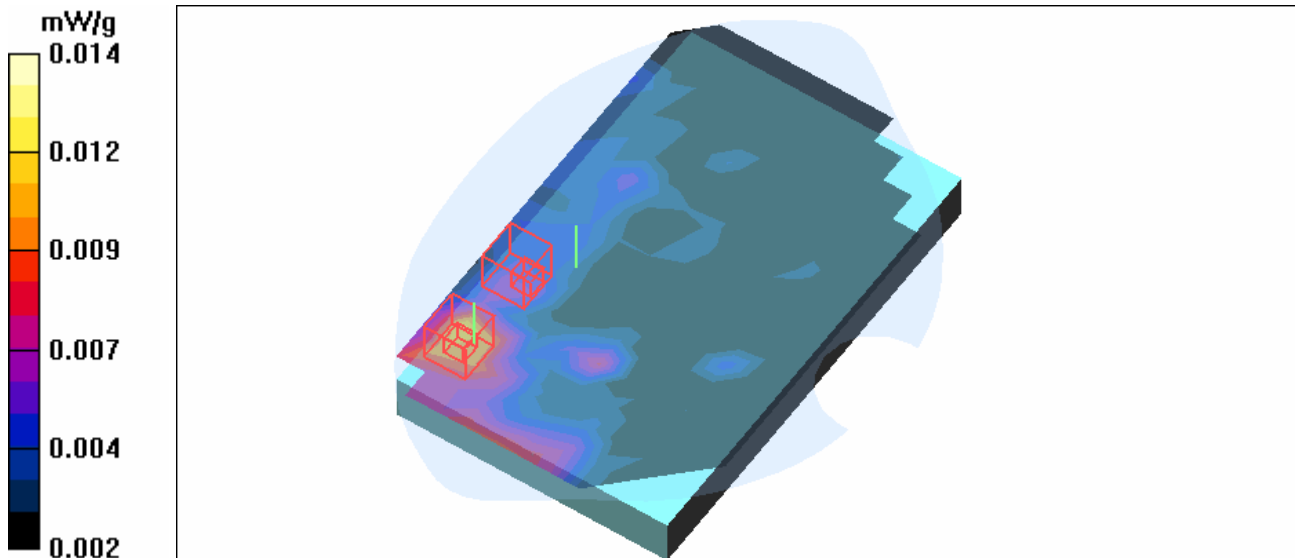

Test Laboratory: Advance Data Technology

H70-11b-Ch11-Mode 1

DUT: Notebook ; Type: H70 ; Test Channel Frequency: 2462 MHz

Communication System: 802.11b ; Frequency: 2462 MHz ; Duty Cycle: 1:1

Medium: MSL2450 Medium parameters used: $f = 2462$ MHz; $\sigma = 2.04$ mho/m; $\epsilon_r = 53.6$; $\rho = 1000$ kg/m³ ; Liquid Level : 152 mm

Phantom section: Flat Section ; DUT test position : Body ; Modulation Type: CCK

Separation Distance : 0 mm (The bottom side of the EUT to the Phantom)

Antenna Type : PIFA Antenna ; Air Temp. : 22.1 degrees ; Liquid Temp. : 21.0 degrees

DASY4 Configuration:

- Probe: ET3DV6 - SN1790 ; ConvF(4.35, 4.35, 4.35) ; Calibrated: 2004/12/20
- Sensor-Surface: 4mm (Mechanical Surface Detection)
- Electronics: DAE3 Sn579 ; Calibrated: 2005/3/23
- Phantom: SAM 12 ; Type: SAM V4.0; Serial: TP 1202
- Measurement SW: DASY4, V4.6 Build 23 ; Postprocessing SW: SEMCAD, V1.8 Build 160

High Channel 11/Area Scan (11x17x1): Measurement grid: dx=15mm, dy=15mm

Maximum value of SAR (measured) = 0.010 mW/g

High Channel 11/Zoom Scan (7x7x7)/Cube 0: Measurement grid: dx=5mm, dy=5mm, dz=5mm

Reference Value = 1.92 V/m

Peak SAR (extrapolated) = 0.018 W/kg

SAR(1 g) = 0.00449 mW/g; SAR(10 g) = 0.00135 mW/g

Maximum value of SAR (measured) = 0.018 mW/g

High Channel 11/Zoom Scan (7x7x7)/Cube 1: Measurement grid: dx=5mm, dy=5mm, dz=5mm

Reference Value = 1.92 V/m

Peak SAR (extrapolated) = 0.016 W/kg

SAR(1 g) = 0.00187 mW/g; SAR(10 g) = 0.000929 mW/g

Maximum value of SAR (measured) = 0.016 mW/g

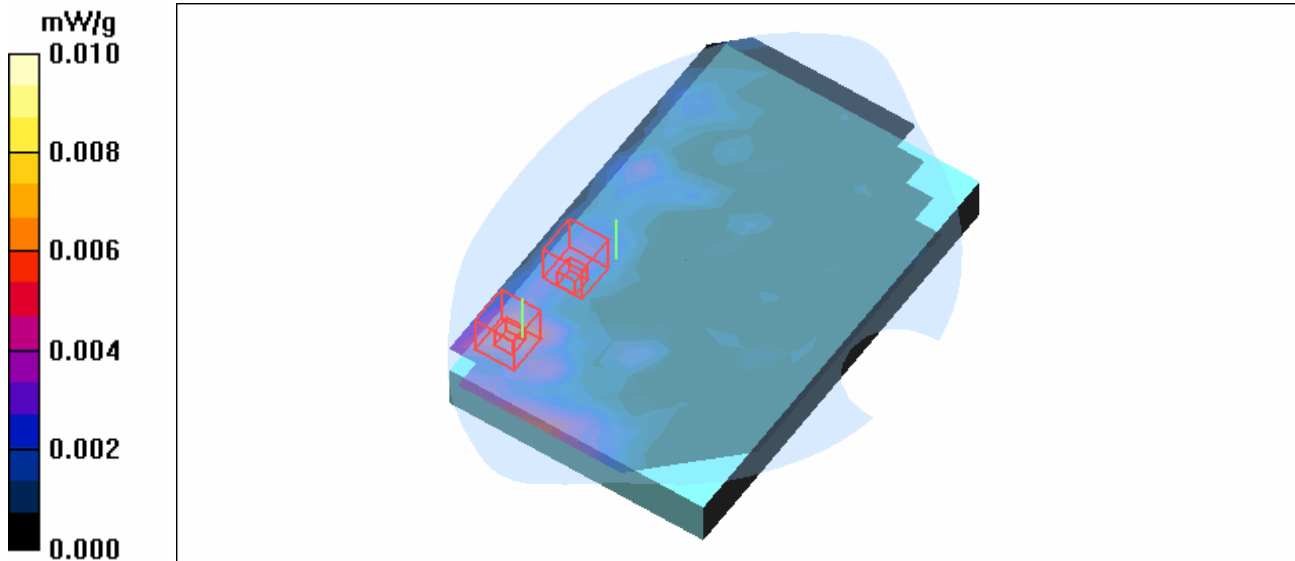

Test Laboratory: Advance Data Technology

H70-11g-Ch1-Mode 2**DUT: Notebook ; Type: H70 ; Test Frequency: 2412 MHz**

Communication System: 802.11g ; Frequency: 2412 MHz ; Duty Cycle: 1:1

Medium: MSL2450 Medium parameters used: $f = 2412$ MHz; $\sigma = 1.97$ mho/m; $\epsilon_r = 53.8$; $\rho = 1000$ kg/m³ ; Liquid Level : 152 mm

Phantom section: Flat Section ; DUT test position : Body ; Modulation Type: OFDM

Separation Distance : 0 mm (The bottom side of the EUT to the Phantom)

Antenna Type : PIFA Antenna ; Air Temp. : 22.1 degrees ; Liquid Temp. : 21.0 degrees

DASY4 Configuration:

- Probe: ET3DV6 - SN1790 ; ConvF(4.35, 4.35, 4.35) ; Calibrated: 2004/12/20

- Sensor-Surface: 4mm (Mechanical Surface Detection)

- Electronics: DAE3 Sn579 ; Calibrated: 2005/3/23

- Phantom: SAM 12 ; Type: SAM V4.0; Serial: TP 1202

- Measurement SW: DASY4, V4.6 Build 23 ; Postprocessing SW: SEMCAD, V1.8 Build 160

Low Channel 1/Area Scan (11x17x1): Measurement grid: dx=15mm, dy=15mm

Maximum value of SAR (measured) = 0.012 mW/g

Low Channel 1/Zoom Scan (7x7x7)/Cube 0: Measurement grid: dx=5mm, dy=5mm, dz=5mm

Reference Value = 2.48 V/m

Peak SAR (extrapolated) = 0.021 W/kg

SAR(1 g) = 0.00985 mW/g; SAR(10 g) = 0.00651 mW/g

Maximum value of SAR (measured) = 0.017 mW/g

Low Channel 1/Zoom Scan (7x7x7)/Cube 1: Measurement grid: dx=5mm, dy=5mm, dz=5mm

Reference Value = 2.48 V/m

Peak SAR (extrapolated) = 0.028 W/kg

SAR(1 g) = 0.0084 mW/g; SAR(10 g) = 0.00583 mW/g

Maximum value of SAR (measured) = 0.018 mW/g

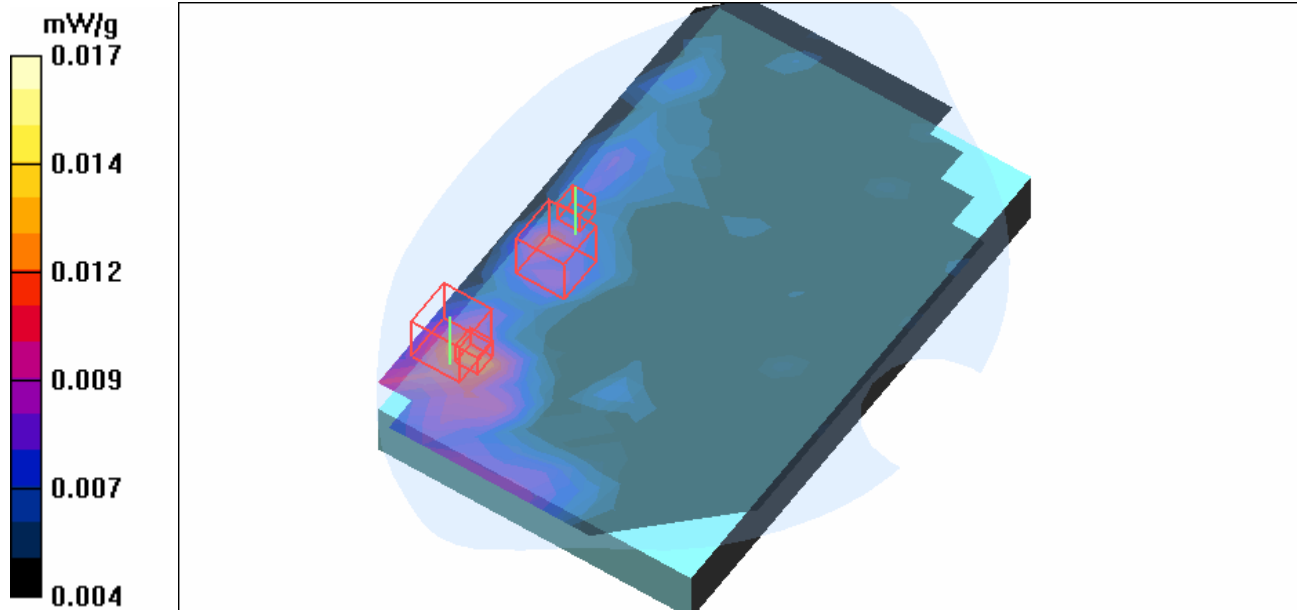

Test Laboratory: Advance Data Technology

H70-11g-Ch6-Mode 2**DUT: Notebook ; Type: H70 ; Test Channel Frequency: 2437 MHz**

Communication System: 802.11g ; Frequency: 2437 MHz ; Duty Cycle: 1:1

Medium: MSL2450 Medium parameters used: $f = 2437$ MHz; $\sigma = 2$ mho/m; $\epsilon_r = 53.7$; $\rho = 1000$ kg/m³ ; Liquid Level : 152 mm

Phantom section: Flat Section ; DUT test position : Body ; Modulation Type: OFDM

Separation Distance : 0 mm (The bottom side of the EUT to the Phantom)

Antenna Type : PIFA Antenna ; Air Temp. : 22.1 degrees ; Liquid Temp. : 21.0 degrees

DASY4 Configuration:

- Probe: ET3DV6 - SN1790 ; ConvF(4.35, 4.35, 4.35) ; Calibrated: 2004/12/20

- Sensor-Surface: 4mm (Mechanical Surface Detection)

- Electronics: DAE3 Sn579 ; Calibrated: 2005/3/23

- Phantom: SAM 12 ; Type: SAM V4.0; Serial: TP 1202

- Measurement SW: DASY4, V4.6 Build 23 ; Postprocessing SW: SEMCAD, V1.8 Build 160

Mid Channel 6/Area Scan (11x17x1): Measurement grid: dx=15mm, dy=15mm

Maximum value of SAR (measured) = 0.011 mW/g

Mid Channel 6/Zoom Scan (7x7x7)/Cube 0: Measurement grid: dx=5mm, dy=5mm, dz=5mm

Reference Value = 2.30 V/m

Peak SAR (extrapolated) = 0.028 W/kg

SAR(1 g) = 0.00903 mW/g; SAR(10 g) = 0.00579 mW/g

Maximum value of SAR (measured) = 0.020 mW/g

Mid Channel 6/Zoom Scan (7x7x7)/Cube 1: Measurement grid: dx=5mm, dy=5mm, dz=5mm

Reference Value = 2.30 V/m

Peak SAR (extrapolated) = 0.028 W/kg

SAR(1 g) = 0.00864 mW/g; SAR(10 g) = 0.00551 mW/g

Maximum value of SAR (measured) = 0.024 mW/g

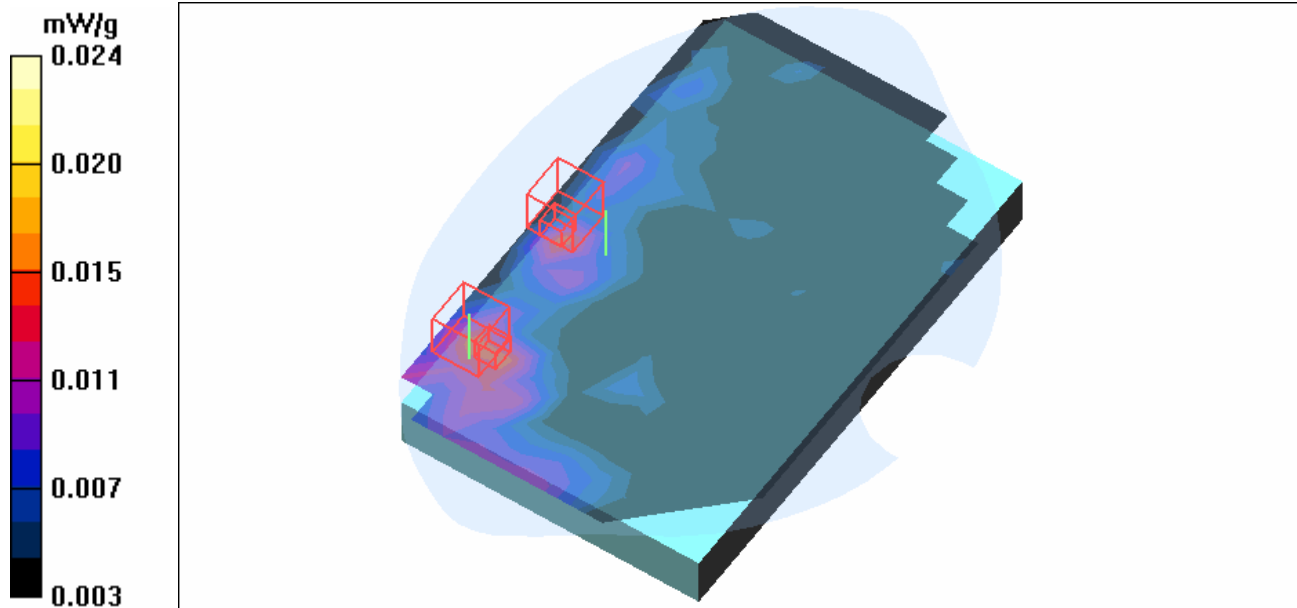

Test Laboratory: Advance Data Technology

H70-11g-Ch11-Mode 2

DUT: Notebook ; Type: H70 ; Test Frequency: 2462 MHz

Communication System: 802.11g ; Frequency: 2462 MHz ; Duty Cycle: 1:1

Medium: MSL2450 Medium parameters used: $f = 2462$ MHz; $\sigma = 2.04$ mho/m; $\epsilon_r = 53.6$; $\rho = 1000$ kg/m³ ; Liquid Level : 152 mm

Phantom section: Flat Section ; DUT test position : Body ; Modulation Type: OFDM

Separation Distance : 0 mm (The bottom side of the EUT to the Phantom)

Antenna Type : PIFA Antenna ; Air Temp. : 22.1 degrees ; Liquid Temp. : 21.0 degrees

DASY4 Configuration:

- Probe: ET3DV6 - SN1790 ; ConvF(4.35, 4.35, 4.35) ; Calibrated: 2004/12/20
- Sensor-Surface: 4mm (Mechanical Surface Detection)
- Electronics: DAE3 Sn579 ; Calibrated: 2005/3/23
- Phantom: SAM 12 ; Type: SAM V4.0; Serial: TP 1202
- Measurement SW: DASY4, V4.6 Build 23 ; Postprocessing SW: SEMCAD, V1.8 Build 160

High Channel 11/Area Scan (11x17x1): Measurement grid: dx=15mm, dy=15mm

Maximum value of SAR (measured) = 0.011 mW/g

High Channel 11/Zoom Scan (7x7x7)/Cube 0: Measurement grid: dx=5mm, dy=5mm, dz=5mm

Reference Value = 2.35 V/m

Peak SAR (extrapolated) = 0.036 W/kg

SAR(1 g) = 0.012 mW/g; SAR(10 g) = 0.00664 mW/g

Maximum value of SAR (measured) = 0.018 mW/g

High Channel 11/Zoom Scan (7x7x7)/Cube 1: Measurement grid: dx=5mm, dy=5mm, dz=5mm

Reference Value = 2.35 V/m

Peak SAR (extrapolated) = 0.041 W/kg

SAR(1 g) = 0.011 mW/g; SAR(10 g) = 0.00551 mW/g

Maximum value of SAR (measured) = 0.017 mW/g

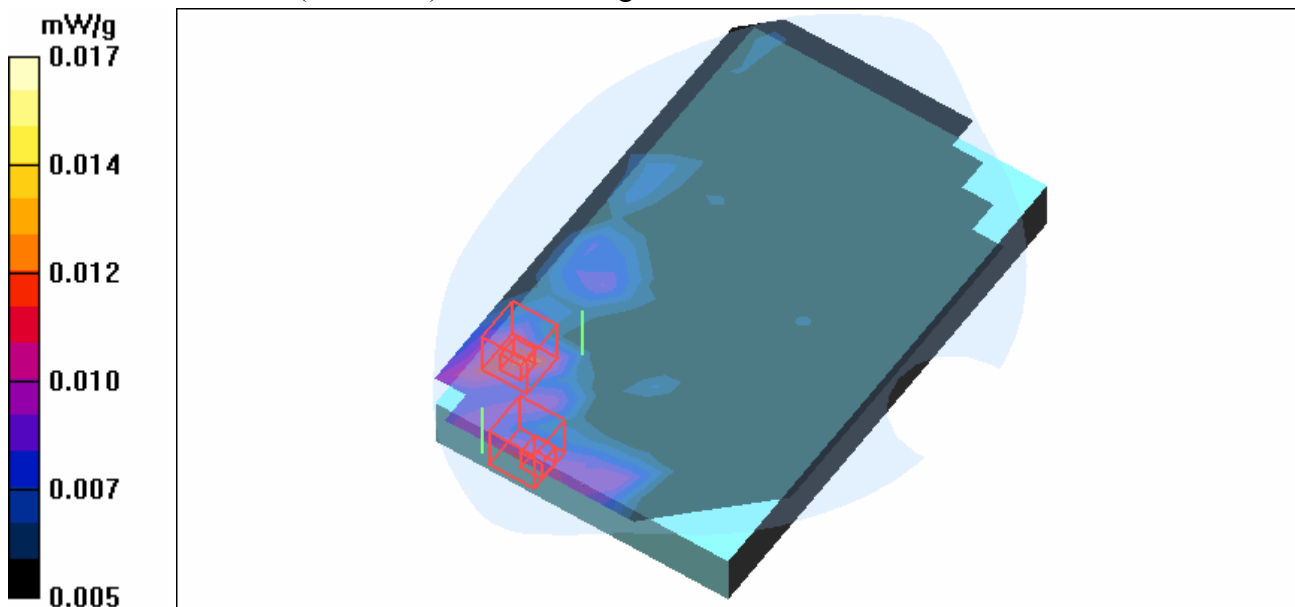

Test Laboratory: Advance Data Technology

H70-11b-Ch1-Mode 3

DUT: Notebook ; Type: H70 ; Test Frequency: 2412 MHz

Communication System: 802.11b ; Frequency: 2412 MHz ; Duty Cycle: 1:1
 Medium: MSL2450 Medium parameters used: $f = 2412$ MHz; $\sigma = 1.97$ mho/m; $\epsilon_r = 53.8$; $\rho = 1000$ kg/m³ ; Liquid Level : 152 mm
 Phantom section: Flat Section ; DUT test position : Body ; Modulation Type: CCK
 Separation Distance : 0 mm (The edge side of the EUT to the Phantom)
 Antenna Type : PIFA Antenna ; Air Temp. : 22.1 degrees ; Liquid Temp. : 21.0 degrees

DASY4 Configuration:

- Probe: ET3DV6 - SN1790 ; ConvF(4.35, 4.35, 4.35) ; Calibrated: 2004/12/20
- Sensor-Surface: 4mm (Mechanical Surface Detection)
- Electronics: DAE3 Sn579 ; Calibrated: 2005/3/23
- Phantom: SAM 12 ; Type: SAM V4.0; Serial: TP 1202
- Measurement SW: DASY4, V4.6 Build 23 ; Postprocessing SW: SEMCAD, V1.8 Build 160

Low Channel 1/Area Scan (5x12x1): Measurement grid: dx=15mm, dy=15mm
 Maximum value of SAR (measured) = 0.103 mW/g

Low Channel 1/Zoom Scan (7x7x7)/Cube 0: Measurement grid: dx=5mm, dy=5mm, dz=5mm
 Reference Value = 4.85 V/m
 Peak SAR (extrapolated) = 0.290 W/kg
SAR(1 g) = 0.095 mW/g; SAR(10 g) = 0.051 mW/g
 Maximum value of SAR (measured) = 0.115 mW/g

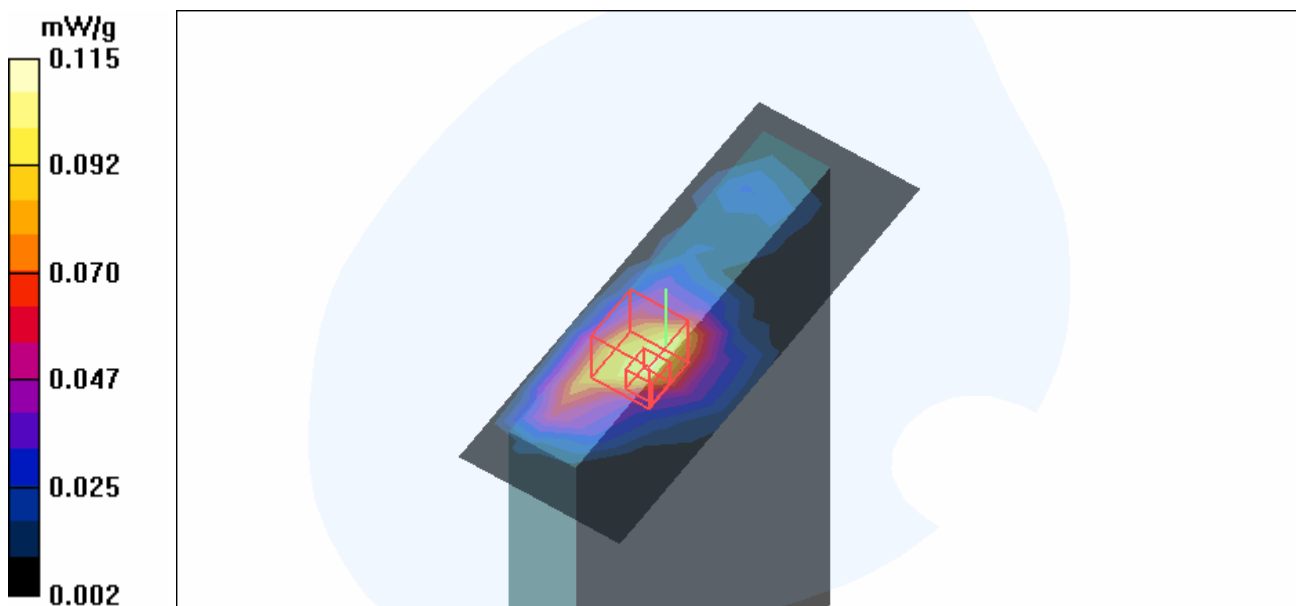

Test Laboratory: Advance Data Technology

H70-11b-Ch6-Mode 3

DUT: Notebook ; Type: H70 ; Test Frequency: 2437 MHz

Communication System: 802.11b ; Frequency: 2437 MHz ; Duty Cycle: 1:1
 Medium: MSL2450 Medium parameters used: $f = 2437$ MHz; $\sigma = 2$ mho/m; $\epsilon_r = 53.7$; $\rho = 1000$ kg/m³ ; Liquid Level : 152 mm
 Phantom section: Flat Section ; DUT test position : Body ; Modulation Type: CCK
 Separation Distance : 0 mm (The edge side of the EUT to the Phantom)
 Antenna Type : PIFA Antenna ; Air Temp. : 22.1 degrees ; Liquid Temp. : 21.0 degrees

DASY4 Configuration:

- Probe: ET3DV6 - SN1790 ; ConvF(4.35, 4.35, 4.35) ; Calibrated: 2004/12/20
- Sensor-Surface: 4mm (Mechanical Surface Detection)
- Electronics: DAE3 Sn579 ; Calibrated: 2005/3/23
- Phantom: SAM 12 ; Type: SAM V4.0; Serial: TP 1202
- Measurement SW: DASY4, V4.6 Build 23 ; Postprocessing SW: SEMCAD, V1.8 Build 160

Mid Channel 6/Area Scan (5x12x1): Measurement grid: dx=15mm, dy=15mm
 Maximum value of SAR (measured) = 0.122 mW/g

Mid Channel 6/Zoom Scan (7x7x7)/Cube 0: Measurement grid: dx=5mm, dy=5mm, dz=5mm
 Reference Value = 4.58 V/m
 Peak SAR (extrapolated) = 0.296 W/kg
SAR(1 g) = 0.120 mW/g; SAR(10 g) = 0.063 mW/g
 Maximum value of SAR (measured) = 0.133 mW/g

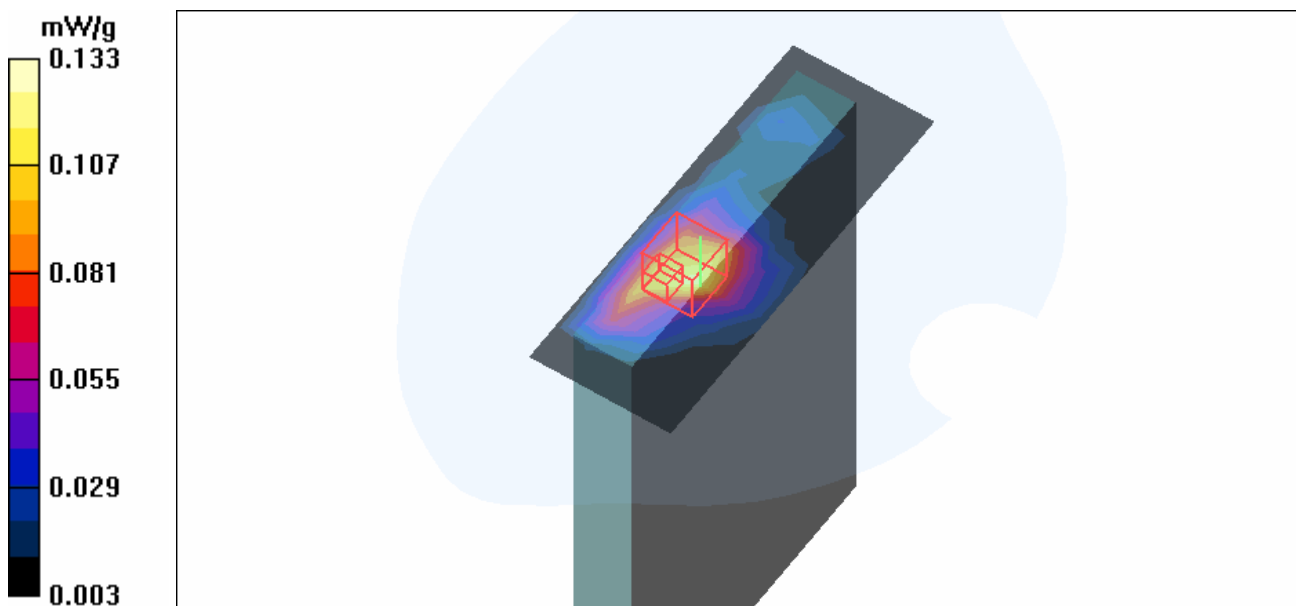

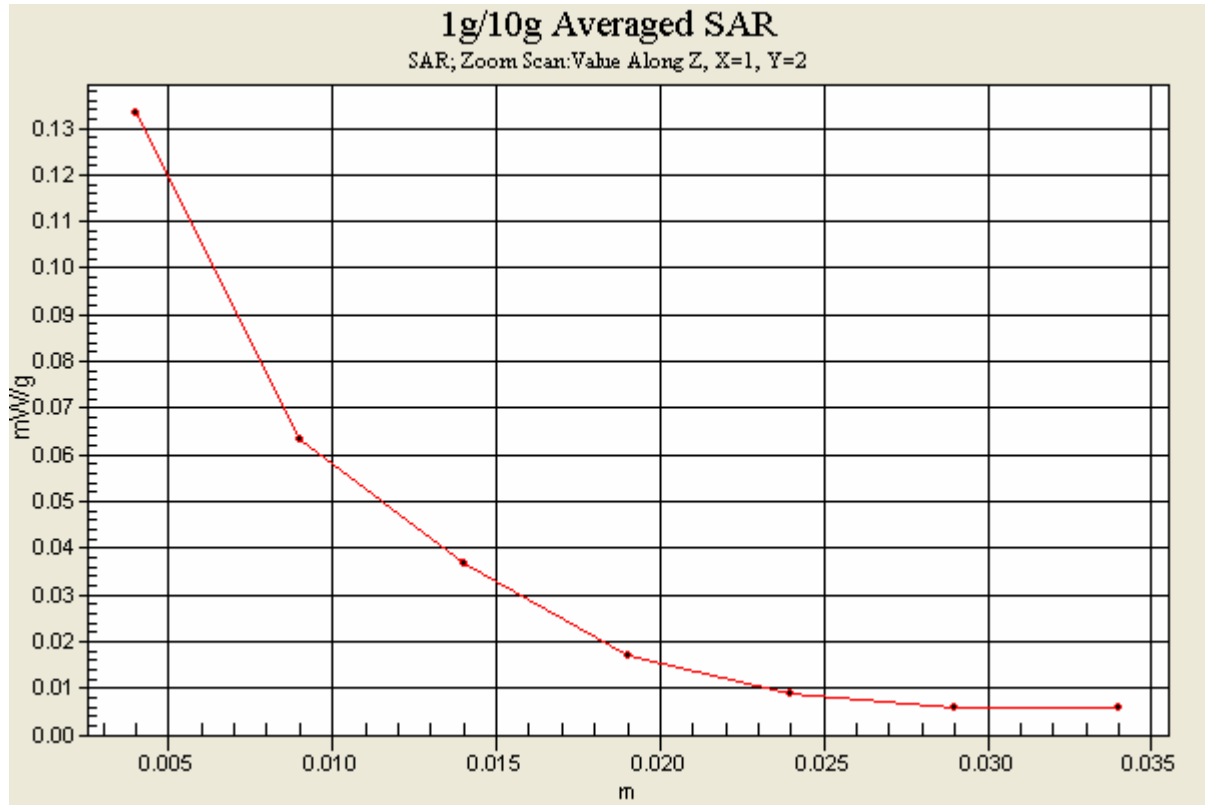

Test Laboratory: Advance Data Technology

H70-11b-Ch11-Mode 3

DUT: Notebook ; Type: H70 ; Test Frequency: 2462 MHz

Communication System: 802.11b ; Frequency: 2462 MHz ; Duty Cycle: 1:1
Medium: MSL2450 Medium parameters used: $f = 2462$ MHz; $\sigma = 2.04$ mho/m; $\epsilon_r = 53.6$; $\rho = 1000$ kg/m³ ; Liquid Level : 152 mm
Phantom section: Flat Section ; DUT test position : Body ; Modulation Type: CCK
Separation Distance : 0 mm (The edge side of the EUT to the Phantom)
Antenna Type : PIFA Antenna ; Air Temp. : 22.1 degrees ; Liquid Temp. : 21.0 degrees

DASY4 Configuration:

- Probe: ET3DV6 - SN1790 ; ConvF(4.35, 4.35, 4.35) ; Calibrated: 2004/12/20
- Sensor-Surface: 4mm (Mechanical Surface Detection)
- Electronics: DAE3 Sn579 ; Calibrated: 2005/3/23
- Phantom: SAM 12 ; Type: SAM V4.0; Serial: TP 1202
- Measurement SW: DASY4, V4.6 Build 23 ; Postprocessing SW: SEMCAD, V1.8 Build 160

High Channel 11/Area Scan (5x12x1): Measurement grid: dx=15mm, dy=15mm
Maximum value of SAR (measured) = 0.108 mW/g

High Channel 11/Zoom Scan (7x7x7)/Cube 0: Measurement grid: dx=5mm, dy=5mm, dz=5mm
Reference Value = 3.73 V/m
Peak SAR (extrapolated) = 0.380 W/kg
SAR(1 g) = 0.090 mW/g; SAR(10 g) = 0.044 mW/g
Maximum value of SAR (measured) = 0.113 mW/g

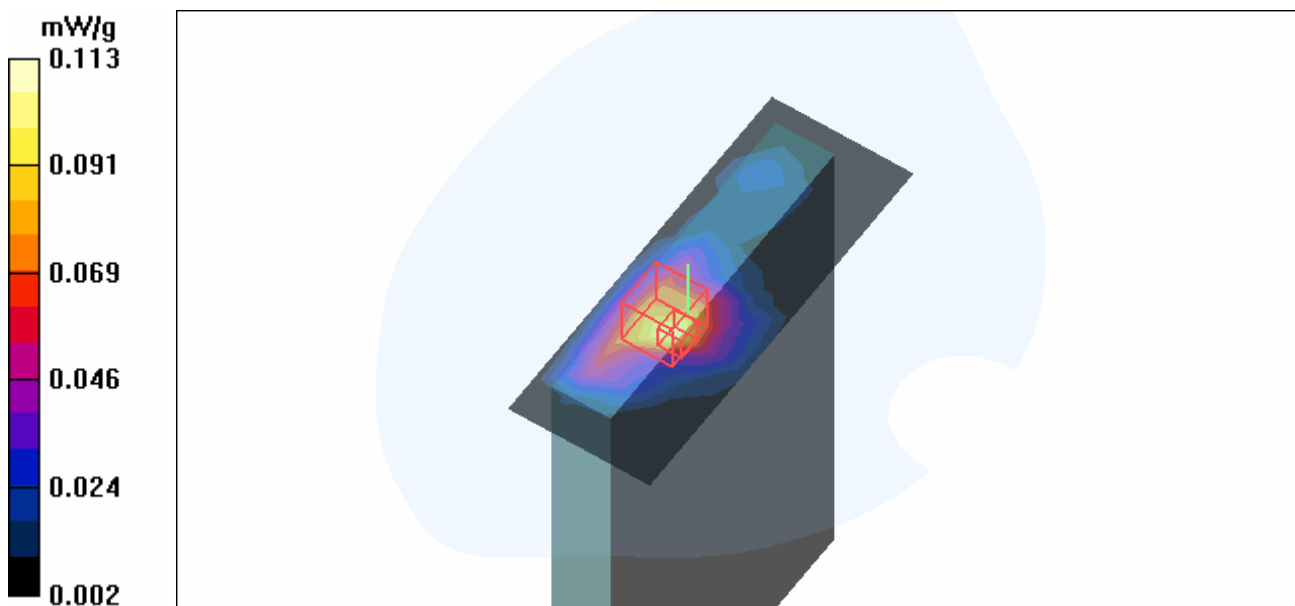

Test Laboratory: Advance Data Technology

H70-11b-Ch6+BT-Ch0-Mode 4

DUT: Notebook ; Type: H70 ; Test Frequency: 2437 MHz

Communication System: 802.11b ; Frequency: 2437 MHz ; Duty Cycle: 1:1
 Medium: MSL2450 Medium parameters used: $f = 2437$ MHz; $\sigma = 2$ mho/m; $\epsilon_r = 53.7$; $\rho = 1000$ kg/m³ ; Liquid Level : 152 mm
 Phantom section: Flat Section ; DUT test position : Body ; Modulation Type: CCK
 Separation Distance : 0 mm (The edge side of the EUT to the Phantom)
 Antenna Type : PIFA Antenna ; Air Temp. : 22.1 degrees ; Liquid Temp. : 21.0 degrees

DASY4 Configuration:

- Probe: ET3DV6 - SN1790 ; ConvF(4.35, 4.35, 4.35) ; Calibrated: 2004/12/20
- Sensor-Surface: 4mm (Mechanical Surface Detection)
- Electronics: DAE3 Sn579 ; Calibrated: 2005/3/23
- Phantom: SAM 12 ; Type: SAM V4.0; Serial: TP 1202
- Measurement SW: DASY4, V4.6 Build 23 ; Postprocessing SW: SEMCAD, V1.8 Build 160

Mid Channel 6/Area Scan (5x12x1): Measurement grid: dx=15mm, dy=15mm
 Maximum value of SAR (measured) = 0.124 mW/g

Mid Channel 6/Zoom Scan (7x7x7)/Cube 0: Measurement grid: dx=5mm, dy=5mm, dz=5mm
 Reference Value = 4.64 V/m
 Peak SAR (extrapolated) = 0.341 W/kg
SAR(1 g) = 0.116 mW/g; SAR(10 g) = 0.060 mW/g
 Maximum value of SAR (measured) = 0.134 mW/g

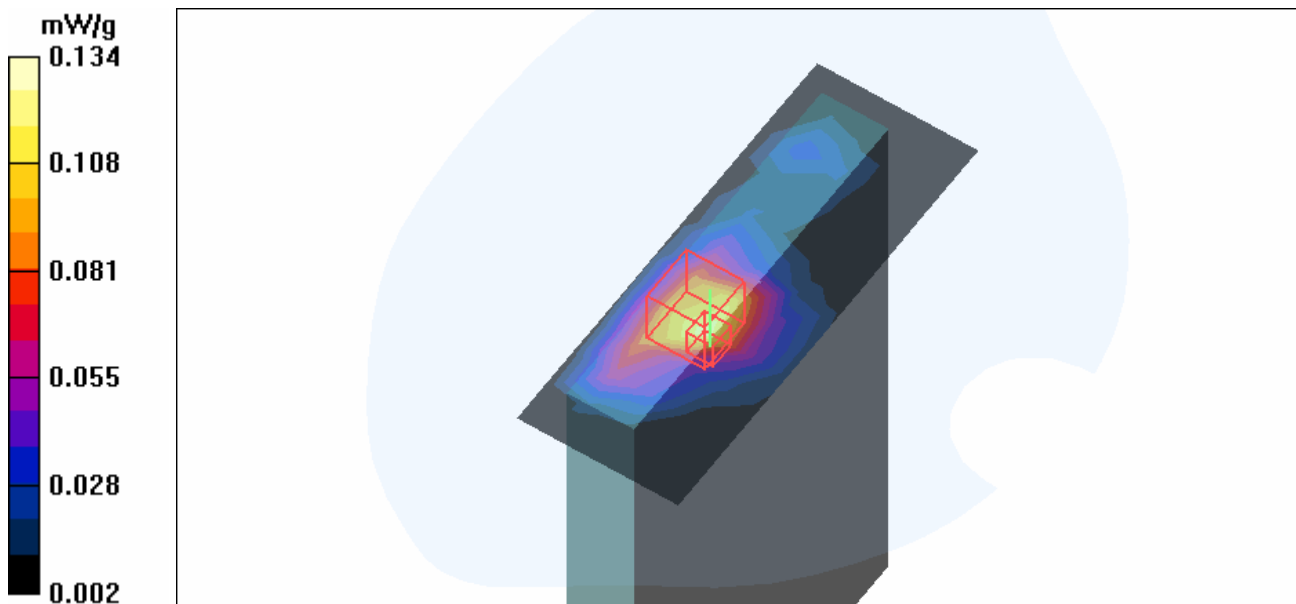

Test Laboratory: Advance Data Technology

H70-11g-Ch1-Mode 5

DUT: Notebook ; Type: H70 ; Test Frequency: 2412 MHz

Communication System: 802.11g ; Frequency: 2412 MHz ; Duty Cycle: 1:1
 Medium: MSL2450 Medium parameters used: $f = 2412 \text{ MHz}$; $\sigma = 1.97 \text{ mho/m}$; $\epsilon_r = 53.8$; $\rho = 1000 \text{ kg/m}^3$; Liquid Level : 152 mm
 Phantom section: Flat Section ; DUT test position : Body ; Modulation Type: OFDM
 Separation Distance : 0 mm (The edge side of the EUT to the Phantom)
 Antenna Type : PIFA Antenna ; Air Temp. : 22.1 degrees ; Liquid Temp. : 21.0 degrees

DASY4 Configuration:

- Probe: ET3DV6 - SN1790 ; ConvF(4.35, 4.35, 4.35) ; Calibrated: 2004/12/20
- Sensor-Surface: 4mm (Mechanical Surface Detection)
- Electronics: DAE3 Sn579 ; Calibrated: 2005/3/23
- Phantom: SAM 12 ; Type: SAM V4.0; Serial: TP 1202
- Measurement SW: DASY4, V4.6 Build 23 ; Postprocessing SW: SEMCAD, V1.8 Build 160

Low Channel 1/Area Scan (5x12x1): Measurement grid: $dx=15\text{mm}$, $dy=15\text{mm}$
 Maximum value of SAR (measured) = 0.078 mW/g

Low Channel 1/Zoom Scan (7x7x7)/Cube 0: Measurement grid: $dx=5\text{mm}$, $dy=5\text{mm}$, $dz=5\text{mm}$
 Reference Value = 4.00 V/m
 Peak SAR (extrapolated) = 0.197 W/kg
SAR(1 g) = 0.067 mW/g; SAR(10 g) = 0.032 mW/g
 Maximum value of SAR (measured) = 0.083 mW/g

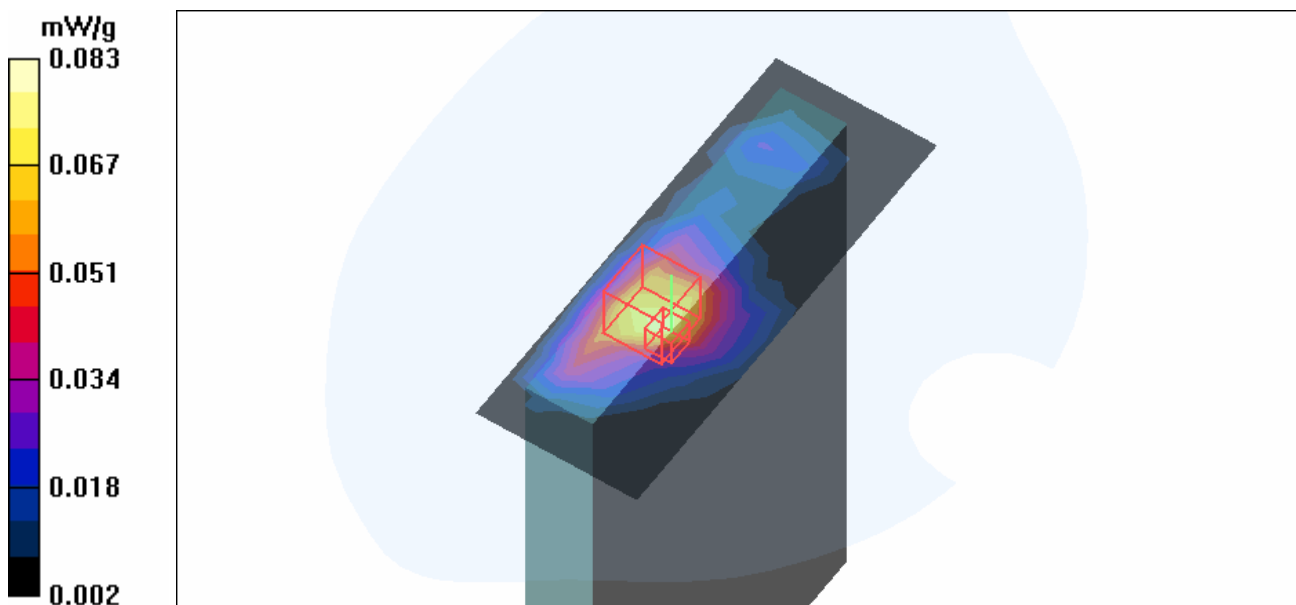

Test Laboratory: Advance Data Technology

H70-11g-Ch6-Mode 5

DUT: Notebook ; Type: H70 ; Test Frequency: 2437 MHz

Communication System: 802.11g ; Frequency: 2437 MHz ; Duty Cycle: 1:1
 Medium: MSL2450 Medium parameters used: $f = 2437 \text{ MHz}$; $\sigma = 2 \text{ mho/m}$; $\epsilon_r = 53.7$; $\rho = 1000 \text{ kg/m}^3$; Liquid Level : 152 mm
 Phantom section: Flat Section ; DUT test position : Body ; Modulation Type: OFDM
 Separation Distance : 0 mm (The edge side of the EUT to the Phantom)
 Antenna Type : PIFA Antenna ; Air Temp. : 22.1 degrees ; Liquid Temp. : 21.0 degrees

DASY4 Configuration:

- Probe: ET3DV6 - SN1790 ; ConvF(4.35, 4.35, 4.35) ; Calibrated: 2004/12/20
- Sensor-Surface: 4mm (Mechanical Surface Detection)
- Electronics: DAE3 Sn579 ; Calibrated: 2005/3/23
- Phantom: SAM 12 ; Type: SAM V4.0; Serial: TP 1202
- Measurement SW: DASY4, V4.6 Build 23 ; Postprocessing SW: SEMCAD, V1.8 Build 160

Mid Channel 6/Area Scan (5x12x1): Measurement grid: $dx=15\text{mm}$, $dy=15\text{mm}$
 Maximum value of SAR (measured) = 0.094 mW/g

Mid Channel 6/Zoom Scan (7x7x7)/Cube 0: Measurement grid: $dx=5\text{mm}$, $dy=5\text{mm}$, $dz=5\text{mm}$
 Reference Value = 3.89 V/m
 Peak SAR (extrapolated) = 0.222 W/kg
SAR(1 g) = 0.088 mW/g; SAR(10 g) = 0.046 mW/g
 Maximum value of SAR (measured) = 0.103 mW/g

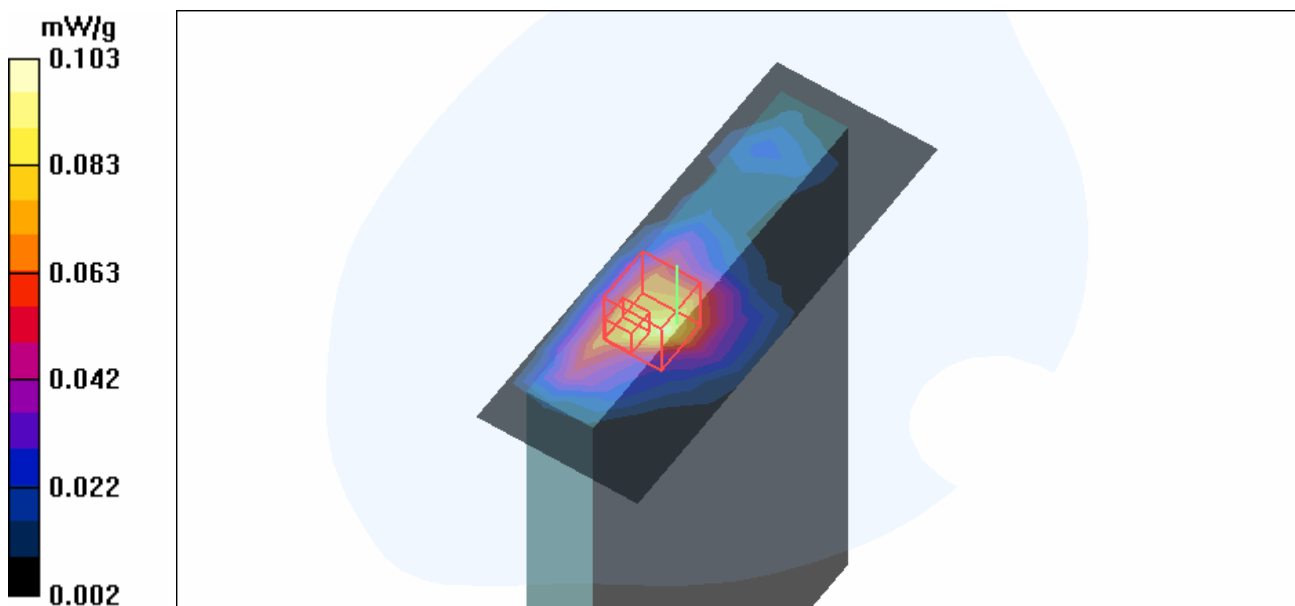

Test Laboratory: Advance Data Technology

H70-11g-Ch11-Mode 5

DUT: Notebook ; Type: H70 ; Test Frequency: 2462 MHz

Communication System: 802.11g ; Frequency: 2462 MHz ; Duty Cycle: 1:1
 Medium: MSL2450 Medium parameters used: $f = 2462$ MHz; $\sigma = 2.04$ mho/m; $\epsilon_r = 53.6$; $\rho = 1000$ kg/m³ ; Liquid Level : 152 mm
 Phantom section: Flat Section ; DUT test position : Body ; Modulation Type: OFDM
 Separation Distance : 0 mm (The edge side of the EUT to the Phantom)
 Antenna Type : PIFA Antenna ; Air Temp. : 22.1 degrees ; Liquid Temp. : 21.0 degrees

DASY4 Configuration:

- Probe: ET3DV6 - SN1790 ; ConvF(4.35, 4.35, 4.35) ; Calibrated: 2004/12/20
- Sensor-Surface: 4mm (Mechanical Surface Detection)
- Electronics: DAE3 Sn579 ; Calibrated: 2005/3/23
- Phantom: SAM 12 ; Type: SAM V4.0; Serial: TP 1202
- Measurement SW: DASY4, V4.6 Build 23 ; Postprocessing SW: SEMCAD, V1.8 Build 160

High Channel 11/Area Scan (5x12x1): Measurement grid: dx=15mm, dy=15mm
 Maximum value of SAR (measured) = 0.078 mW/g

High Channel 11/Zoom Scan (7x7x7)/Cube 0: Measurement grid: dx=5mm, dy=5mm, dz=5mm
 Reference Value = 3.48 V/m
 Peak SAR (extrapolated) = 0.149 W/kg
SAR(1 g) = 0.069 mW/g; SAR(10 g) = 0.034 mW/g
 Maximum value of SAR (measured) = 0.084 mW/g

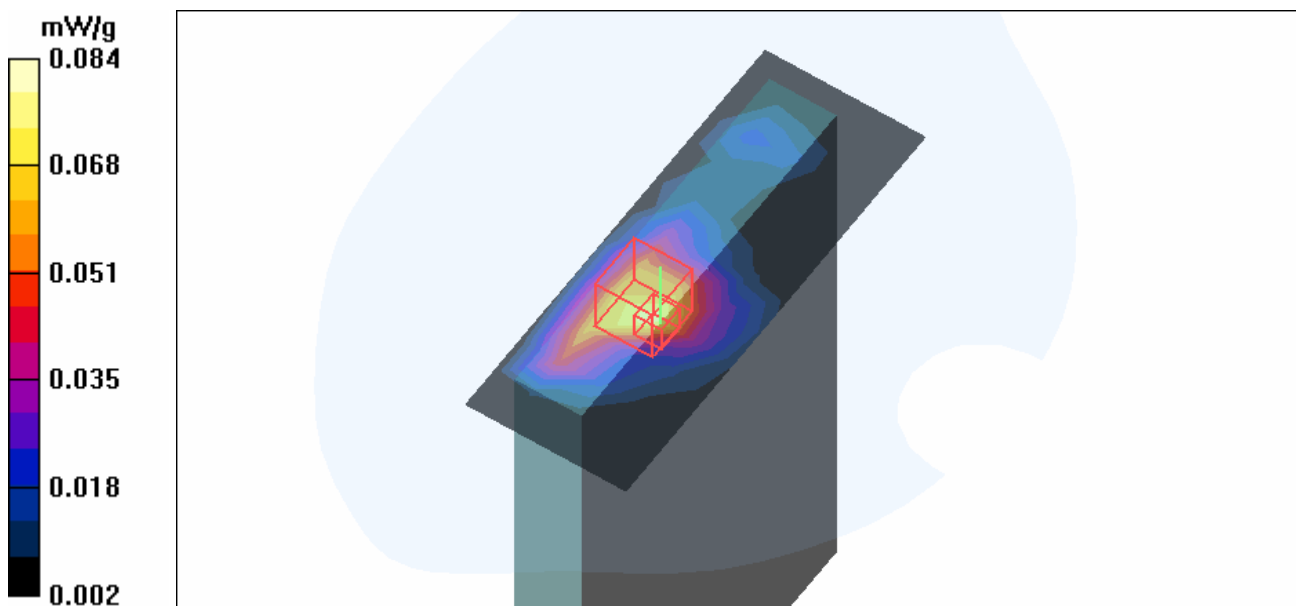

Test Laboratory: Advance Data Technology

System Validation Check-MSL 2450MHz

DUT: Dipole 2450 MHz ; Type: D2450V2 ; Serial: 737 ; Test Frequency: 2450 MHz

Communication System: CW ; Frequency: 2450 MHz; Duty Cycle: 1:1; Modulation type: CW
 Medium: MSL2450; Medium parameters used: $f = 2450$ MHz; $\sigma = 2.02$ mho/m; $\epsilon_r = 53.6$; $\rho = 1000$ kg/m³ ; Liquid level : 152 mm
 Phantom section: Flat Section ; Separation distance : 10 mm (The feetpoint of the dipole to the Phantom) Air temp. : 22.1 degrees ; Liquid temp. : 21.0 degrees

DASY4 Configuration:

- Probe: ET3DV6 - SN1790 ; ConvF(4.35, 4.35, 4.35) ; Calibrated: 2004/12/20
- Sensor-Surface: 4mm (Mechanical Surface Detection)
- Electronics: DAE3 Sn579; Calibrated: 2005/3/23
- Phantom: SAM 12; Type: SAM V4.0; Serial: TP 1202
- Measurement SW: DASY4, V4.6 Build 23; Postprocessing SW: SEMCAD, V1.8 Build 160

d=10mm, Pin=250mW/Area Scan (5x7x1): Measurement grid: dx=15mm, dy=15mm
 Maximum value of SAR (measured) = 14.7 mW/g

d=10mm, Pin=250mW/Zoom Scan (7x7x7)/Cube 0: Measurement grid: dx=5mm, dy=5mm, dz=5mm

Reference Value = 89.7 V/m; Power Drift = -0.095 dB

Peak SAR (extrapolated) = 28.8 W/kg

SAR(1 g) = 12.9 mW/g; SAR(10 g) = 5.84 mW/g

Maximum value of SAR (measured) = 14.6 mW/g

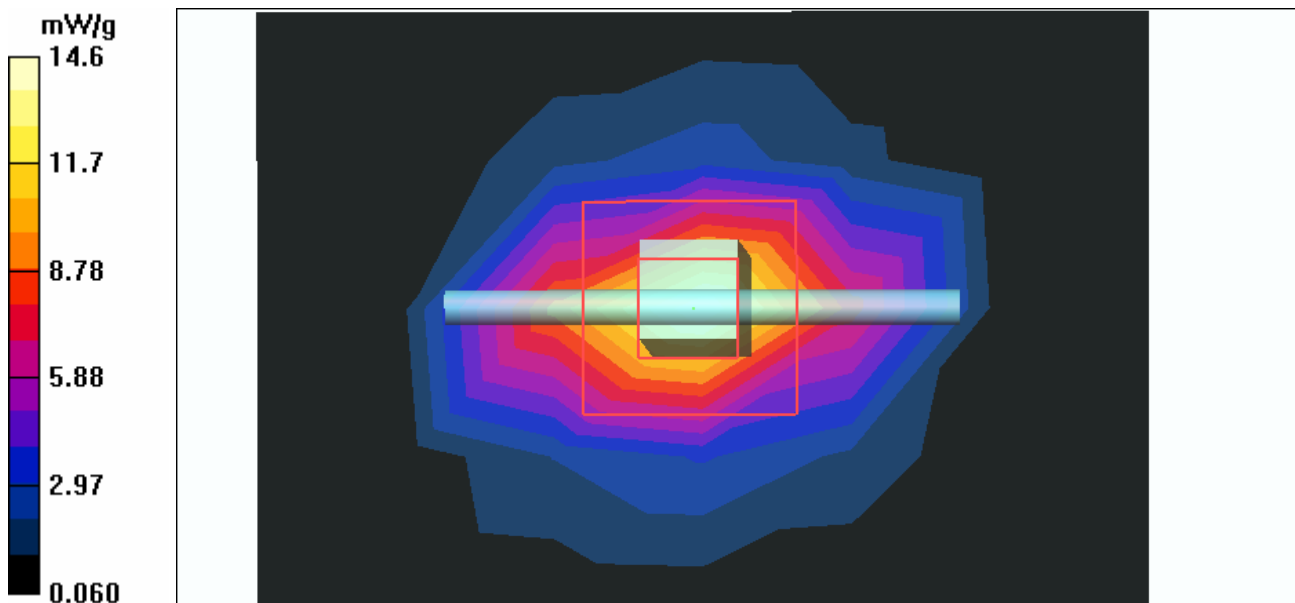

APPENDIX B: ADT SAR MEASUREMENT SYSTEM



APPENDIX C: PHOTOGRAPHS OF SYSTEM VALIDATION

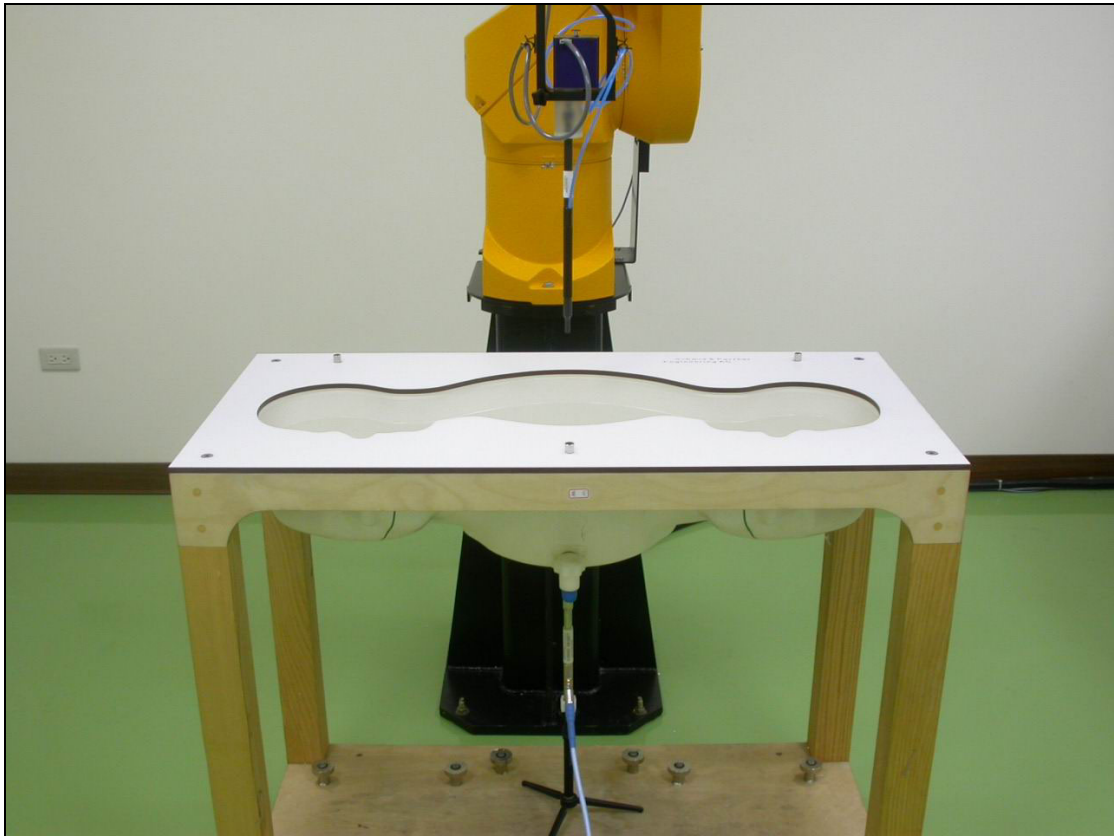

IMPORTANT NOTICE

USAGE OF PROBES IN ORGANIC SOLVENTS

Diethylene Glycol Monobuthy Ether (the basis for liquids above 1 GHz), as many other organic solvents, is a very effective softener for synthetic materials. These solvents can cause irreparable damage to certain SPEAG products, except those which are explicitly declared as compliant with organic solvents.

Compatible Probes:

- ET3DV6
- ET3DV6R
- ES3DVx
- ER3DV6
- H3DV6

Important Note for ET3DV6 Probes:

The ET3DV6 probes shall not be exposed to solvents longer than necessary for the measurements and shall be cleaned daily after use with warm water and stored dry.

s p e a g

Schmid & Partner Engineering AG
Zeughausstrasse 43, 8004 Zurich, Switzerland
Phone +41 1 245 9700, Fax +41 1 245 9779
info@speag.com, <http://www.speag.com>

Schmid & Partner Engineering AG

Zeughausstrasse 43, 8004 Zurich, Switzerland
Phone +41 1 245 9700, Fax +41 1 245 9779
info@speag.com, <http://www.speag.com>

INTRODUCTION OF NEW PROBE CONFIGURATION FILES (*.cf5)

Dear Customer,

Please be informed that as of November 2004, probe configuration files have been change to the new version, i.e., *.cf5 configuration files. Together with the DASY4 v4.4 Build 3 software version, the frequency compensation is applied to measured data providing extension of frequency validity of the probe *ConvF* from ± 50 MHz to ± 100 MHz with the same accuracy.

SOFTWARE INSTALLATION

The new software is available for download from the DASY4 homepage
<http://www.dasy4.com/updates/updates.html>
(via: DASY4 / Support & Downloads / Downloads / Software Updates)

The two new executable files:

DASY4.4 B3 EXE (item 3 within the DASY 4.4 Upgrade section)

SEMCAD V1.8 B130 EXE (item 4 within the DASY 4.4 Upgrade section)

To access and download the files, please use:

Username: **dasy4**

Password: **wowcool**

Please download the two executable files and replace the existing DASY4/SEMCAD software versions located in your DASY4 directory on your PC with these new releases at your earliest convenience.

Best regards

Your SPEAG DASY4 support team

s p e a g

Schmid & Partner Engineering AG
Zeughausstrasse 43, 8004 Zurich, Switzerland
Phone +41 1 245 9700, Fax +41 1 245 9779
info@speag.com, <http://www.speag.com>

Schmid & Partner Engineering AG



Accredited by the Swiss Federal Office of Metrology and Accreditation
The Swiss Accreditation Service is one of the signatories to the EA
Multilateral Agreement for the recognition of calibration certificates

Accreditation No.: **SCS 108**

Client **ADT (Auden)**

Certificate No. **ET3-1790_Dec04**

CALIBRATION CERTIFICATE

Object **ET3DV6 - SN: 1790**

Calibration procedure(s) **QA CAL-01 v5
Calibration procedure for dosimetric E-field probes**

Calibration date: **December 20, 2004**

Condition of the calibrated item **In Tolerance**

This calibration certificate documents the traceability to national standards, which realize the physical units of measurements (SI).
The measurements and the uncertainties with confidence probability are given on the following pages and are part of the certificate.

All calibrations have been conducted in the closed laboratory facility: environment temperature (22 ± 3)°C and humidity < 70%.

Calibration Equipment used (M&TE critical for calibration)

| Primary Standards | ID # | Cal Date (Calibrated by, Certificate No.) | Scheduled Calibration |
|----------------------------|-----------------|---|------------------------|
| Power meter E4419B | GB41293874 | 5-May-04 (METAS, No. 251-00388) | May-05 |
| Power sensor E4412A | MY41495277 | 5-May-04 (METAS, No. 251-00388) | May-05 |
| Reference 3 dB Attenuator | SN: S5054 (3c) | 10-Aug-04 (METAS, No. 251-00403) | Aug-05 |
| Reference 20 dB Attenuator | SN: S5086 (20b) | 3-May-04 (METAS, No. 251-00389) | May-05 |
| Reference 30 dB Attenuator | SN: S5129 (30b) | 10-Aug-04 (METAS, No. 251-00404) | Aug-05 |
| Reference Probe ES3DV2 | SN: 3013 | 8-Jan-04 (SPEAG, No. ES3-3013_Jan04) | Jan-05 |
| DAE4 | SN: 617 | 26-May-04 (SPEAG, No. DAE4-617_May04) | May-05 |
| Secondary Standards | ID # | Check Date (in house) | Scheduled Check |
| Power sensor HP 8481A | MY41092180 | 18-Sep-02 (SPEAG, in house check Oct-03) | In house check: Oct 05 |
| RF generator HP 8648C | US3642U01700 | 4-Aug-99 (SPEAG, in house check Dec-03) | In house check: Dec-05 |
| Network Analyzer HP 8753E | US37390585 | 18-Oct-01 (SPEAG, in house check Nov-04) | In house check: Nov 05 |

| | | | |
|----------------|---------------|-----------------------|-----------|
| Calibrated by: | Name | Function | Signature |
| | Nico Vetterli | Laboratory Technician | |
| Approved by: | Name | Function | Signature |
| | Katja Pokovic | Technical Manager | |

Issued: December 29, 2004

This calibration certificate shall not be reproduced except in full without written approval of the laboratory.



Accredited by the Swiss Federal Office of Metrology and Accreditation
The Swiss Accreditation Service is one of the signatories to the EA
Multilateral Agreement for the recognition of calibration certificates

Accreditation No.: **SCS 108**

Glossary:

| | |
|--------------------------|--|
| TSL | tissue simulating liquid |
| NORM _{x,y,z} | sensitivity in free space |
| ConF | sensitivity in TSL / NORM _{x,y,z} |
| DCP | diode compression point |
| Polarization φ | φ rotation around probe axis |
| Polarization ϑ | ϑ rotation around an axis that is in the plane normal to probe axis (at measurement center), i.e., $\vartheta = 0$ is normal to probe axis |

Calibration is Performed According to the Following Standards:

- IEEE Std 1528-2003, "IEEE Recommended Practice for Determining the Peak Spatial-Averaged Specific Absorption Rate (SAR) in the Human Head from Wireless Communications Devices: Measurement Techniques", December 2003
- CENELEC EN 50361, "Basic standard for the measurement of Specific Absorption Rate related to human exposure to electromagnetic fields from mobile phones (300 MHz - 3 GHz), July 2001

Methods Applied and Interpretation of Parameters:

- NORM_{x,y,z}**: Assessed for E-field polarization $\vartheta = 0$ ($f \leq 900$ MHz in TEM-cell; $f > 1800$ MHz: R22 waveguide). NORM_{x,y,z} are only intermediate values, i.e., the uncertainties of NORM_{x,y,z} does not effect the E^2 -field uncertainty inside TSL (see below *ConvF*).
- NORM(f)_{x,y,z}** = NORM_{x,y,z} * *frequency_response* (see Frequency Response Chart). This linearization is implemented in DASY4 software versions later than 4.2. The uncertainty of the frequency response is included in the stated uncertainty of *ConvF*.
- DCP_{x,y,z}**: DCP are numerical linearization parameters assessed based on the data of power sweep (no uncertainty required). DCP does not depend on frequency nor media.
- ConvF and Boundary Effect Parameters**: Assessed in flat phantom using E-field (or Temperature Transfer Standard for $f \leq 800$ MHz) and inside waveguide using analytical field distributions based on power measurements for $f > 800$ MHz. The same setups are used for assessment of the parameters applied for boundary compensation (alpha, depth) of which typical uncertainty values are given. These parameters are used in DASY4 software to improve probe accuracy close to the boundary. The sensitivity in TSL corresponds to NORM_{x,y,z} * *ConvF* whereby the uncertainty corresponds to that given for *ConvF*. A frequency dependent *ConvF* is used in DASY 4.3 B17 and higher which allows extending the validity from ± 50 MHz to ± 100 MHz.
- Spherical isotropy (3D deviation from isotropy)**: in a field of low gradients realized using a flat phantom exposed by a patch antenna.
- Sensor Offset**: The sensor offset corresponds to the offset of virtual measurement center from the probe tip (on probe axis). No tolerance required.

Probe ET3DV6

SN:1790

| | |
|------------------|-------------------|
| Manufactured: | May 28, 2003 |
| Last calibrated: | August 29, 2003 |
| Repaired: | October 5, 2004 |
| Recalibrated: | December 20, 2004 |

Calibrated for DASY Systems

(Note: non-compatible with DASY2 system!)

DASY - Parameters of Probe: ET3DV6 SN:1790**Sensitivity in Free Space^A****Diode Compression^B**

| | | | | |
|-------|--------------------|-------------------------------------|-------|--------------|
| NormX | 2.07 ± 9.9% | $\mu\text{V}/(\text{V}/\text{m})^2$ | DCP X | 94 mV |
| NormY | 2.04 ± 9.9% | $\mu\text{V}/(\text{V}/\text{m})^2$ | DCP Y | 94 mV |
| NormZ | 1.78 ± 9.9% | $\mu\text{V}/(\text{V}/\text{m})^2$ | DCP Z | 94 mV |

Sensitivity in Tissue Simulating Liquid (Conversion Factors)

Please see Page 8.

Boundary Effect**TSL 900 MHz Typical SAR gradient: 5 % per mm**

| | | | |
|---|------------------------------|---------------|---------------|
| Sensor Center to Phantom Surface Distance | | 3.7 mm | 4.7 mm |
| SAR _{be} [%] | Without Correction Algorithm | 9.2 | 4.9 |
| SAR _{be} [%] | With Correction Algorithm | 0.1 | 0.2 |

TSL 1750 MHz Typical SAR gradient: 10 % per mm

| | | | |
|---|------------------------------|---------------|---------------|
| Sensor Center to Phantom Surface Distance | | 3.7 mm | 4.7 mm |
| SAR _{be} [%] | Without Correction Algorithm | 12.6 | 8.4 |
| SAR _{be} [%] | With Correction Algorithm | 0.5 | 0.0 |

Sensor OffsetProbe Tip to Sensor Center **2.7 mm**

The reported uncertainty of measurement is stated as the standard uncertainty of measurement multiplied by the coverage factor k=2, which for a normal distribution corresponds to a coverage probability of approximately 95%.

^A The uncertainties of NormX,Y,Z do not affect the E²-field uncertainty inside TSL (see Page 8).^B Numerical linearization parameter: uncertainty not required.

Frequency Response of E-Field

(TEM-Cell:ifi110 EXX, Waveguide: R22)

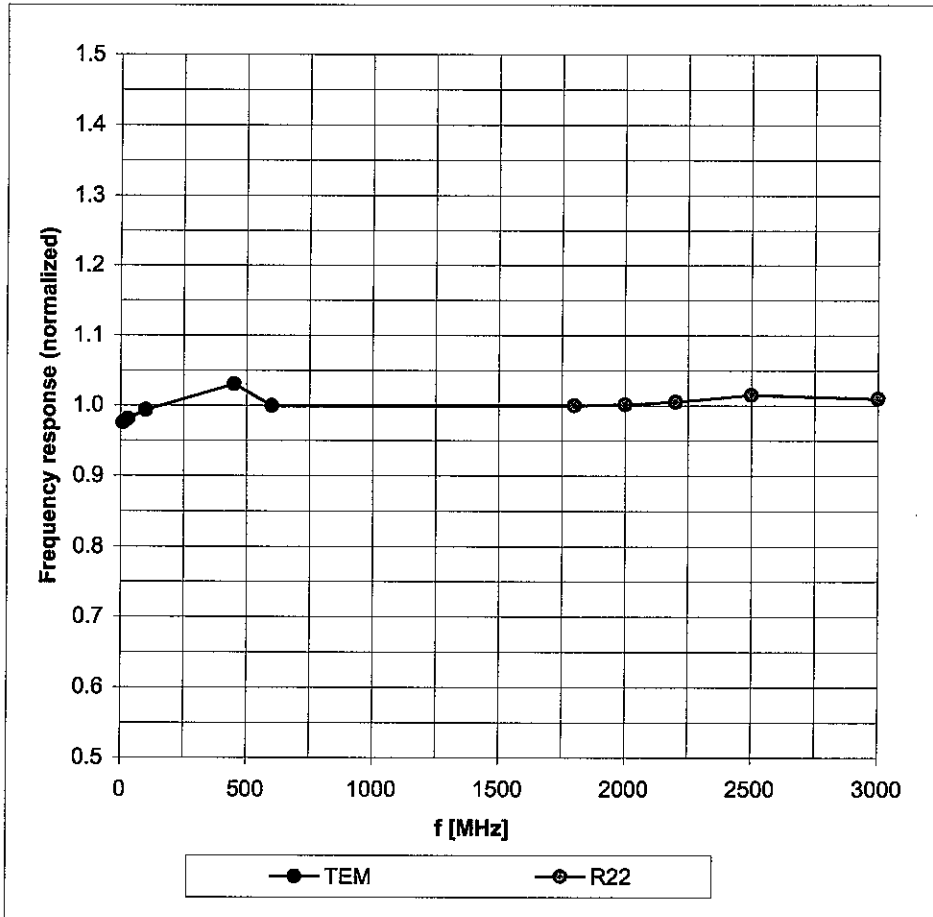

Uncertainty of Frequency Response of E-field: $\pm 6.3\%$ ($k=2$)

Receiving Pattern (ϕ), $\vartheta = 0^\circ$

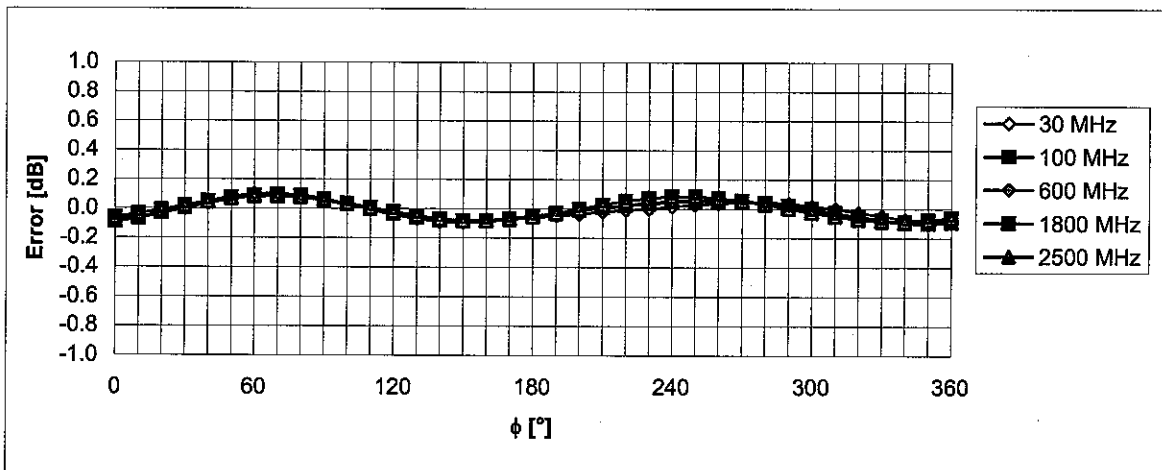
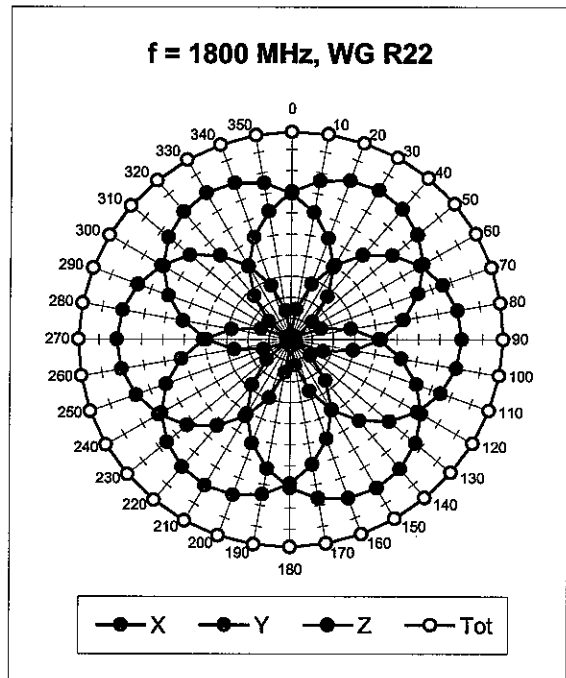
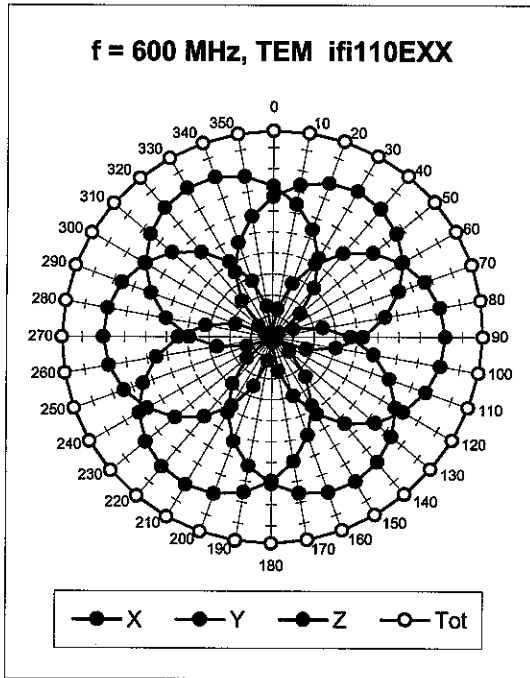

Uncertainty of Axial Isotropy Assessment: $\pm 0.5\%$ ($k=2$)

Dynamic Range $f(\text{SAR}_{\text{head}})$ (Waveguide R22, $f = 1800 \text{ MHz}$)

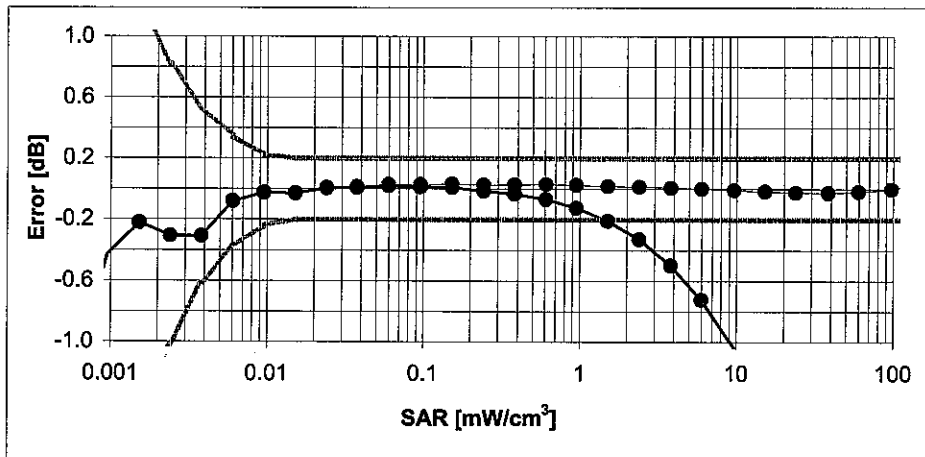
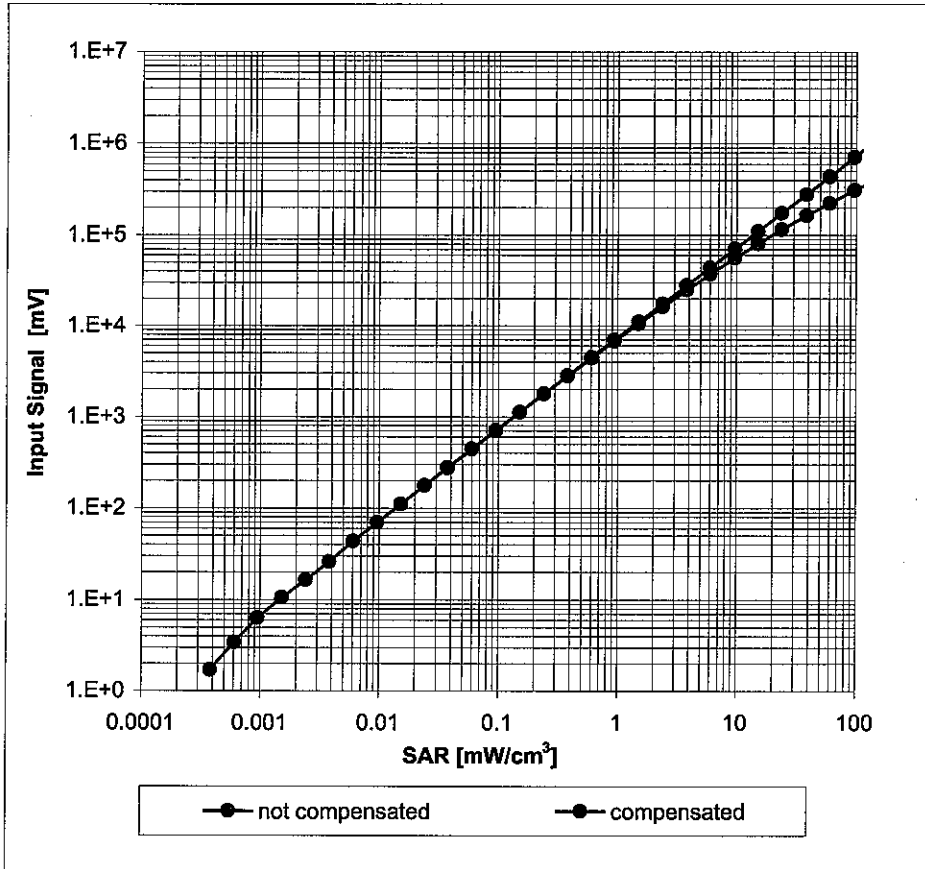

Uncertainty of Linearity Assessment: $\pm 0.6\%$ ($k=2$)

Conversion Factor Assessment

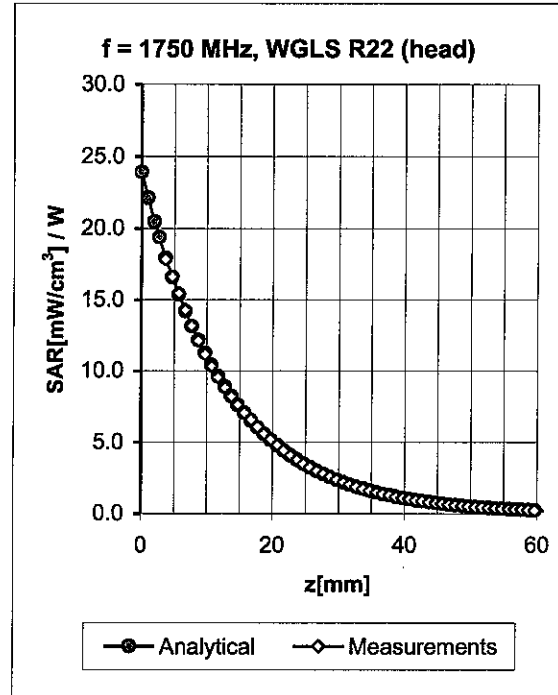
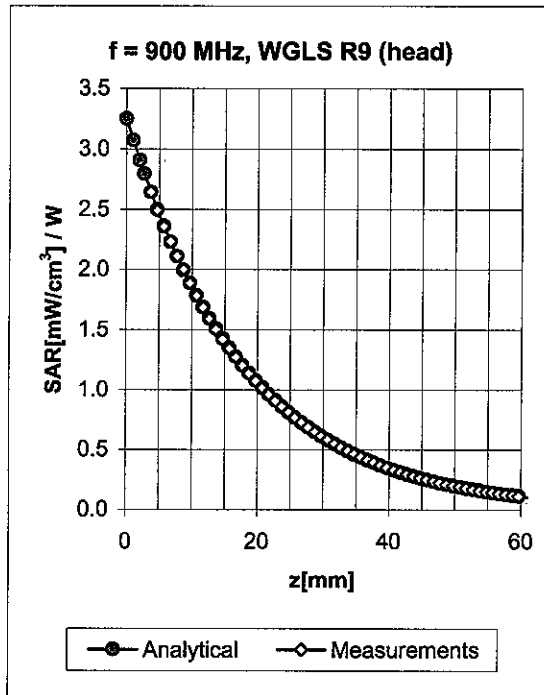

| f [MHz] | Validity [MHz] ^c | TSL | Permittivity | Conductivity | Alpha | Depth | ConvF Uncertainty |
|---------|-----------------------------|------|--------------|--------------|-------|-------|--------------------|
| 835 | ± 50 / ± 100 | Head | 41.5 ± 5% | 0.90 ± 5% | 0.72 | 1.69 | 6.94 ± 11.0% (k=2) |
| 900 | ± 50 / ± 100 | Head | 41.5 ± 5% | 0.97 ± 5% | 0.63 | 1.84 | 6.68 ± 11.0% (k=2) |
| 1750 | ± 50 / ± 100 | Head | 40.1 ± 5% | 1.37 ± 5% | 0.55 | 2.40 | 5.51 ± 11.0% (k=2) |
| 1900 | ± 50 / ± 100 | Head | 40.0 ± 5% | 1.40 ± 5% | 0.53 | 2.51 | 5.26 ± 11.0% (k=2) |
| 2450 | ± 50 / ± 100 | Head | 39.2 ± 5% | 1.80 ± 5% | 0.63 | 2.30 | 4.74 ± 11.8% (k=2) |
| 835 | ± 50 / ± 100 | Body | 55.2 ± 5% | 0.97 ± 5% | 0.50 | 2.07 | 6.65 ± 11.0% (k=2) |
| 900 | ± 50 / ± 100 | Body | 55.0 ± 5% | 1.05 ± 5% | 0.50 | 2.13 | 6.35 ± 11.0% (k=2) |
| 1750 | ± 50 / ± 100 | Body | 53.4 ± 5% | 1.49 ± 5% | 0.52 | 2.81 | 4.83 ± 11.0% (k=2) |
| 1900 | ± 50 / ± 100 | Body | 53.3 ± 5% | 1.52 ± 5% | 0.52 | 2.96 | 4.71 ± 11.0% (k=2) |
| 2450 | ± 50 / ± 100 | Body | 52.7 ± 5% | 1.95 ± 5% | 0.59 | 2.33 | 4.35 ± 11.8% (k=2) |

^c The validity of ± 100 MHz only applies for DASY v4.4 and higher (see Page 2). The uncertainty is the RSS of the ConvF uncertainty at calibration frequency and the uncertainty for the indicated frequency band.

Deviation from Isotropy in HSL

Error (ϕ , θ), $f = 900$ MHz

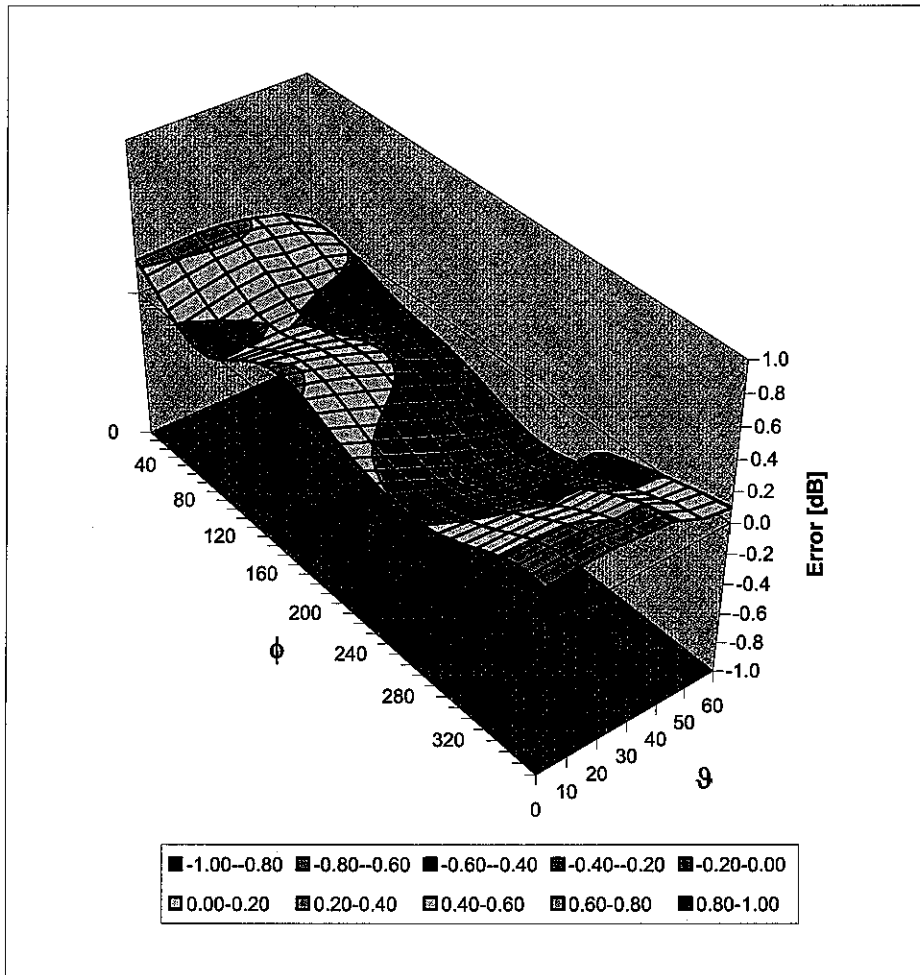

Uncertainty of Spherical Isotropy Assessment: $\pm 2.6\%$ ($k=2$)



Accredited by the Swiss Federal Office of Metrology and Accreditation
The Swiss Accreditation Service is one of the signatories to the EA
Multilateral Agreement for the recognition of calibration certificates

Accreditation No.: **SCS 108**

Client **ADT (Auden)**

Certificate No: **D2450V2-737_Mar05**

CALIBRATION CERTIFICATE

Object **D2450V2 - SN: 737**

Calibration procedure(s) **QA CAL-05.v6
Calibration procedure for dipole validation kits**

Calibration date: **March 16, 2005**

Condition of the calibrated item **In Tolerance**

This calibration certificate documents the traceability to national standards, which realize the physical units of measurements (SI).
The measurements and the uncertainties with confidence probability are given on the following pages and are part of the certificate.

All calibrations have been conducted in the closed laboratory facility: environment temperature (22 ± 3)°C and humidity < 70%.

Calibration Equipment used (M&TE critical for calibration)

| Primary Standards | ID # | Cal Date (Calibrated by, Certificate No.) | Scheduled Calibration |
|----------------------------|------------------|---|------------------------|
| Power meter EPM E442 | GB37480704 | 12-Oct-04 (METAS, No. 251-00412) | Oct-05 |
| Power sensor HP 8481A | US37292783 | 12-Oct-04 (METAS, No. 251-00412) | Oct-05 |
| Reference 20 dB Attenuator | SN: 5086 (20g) | 10-Aug-04 (METAS, No 251-00402) | Aug-05 |
| Reference 10 dB Attenuator | SN: 5047.2 (10r) | 10-Aug-04 (METAS, No 251-00402) | Aug-05 |
| Reference Probe ES3DV2 | SN 3025 | 29-Oct-04 (SPEAG, No. ES3-3025_Oct04) | Oct-05 |
| DAE4 | SN 601 | 07-Jan-05 (SPEAG, No. DAE4-601_Jan05) | Jan-06 |
| Secondary Standards | ID # | Check Date (in house) | Scheduled Check |
| Power sensor HP 8481A | MY41092317 | 18-Oct-02 (SPEAG, in house check Oct-03) | In house check: Oct-05 |
| RF generator R&S SML-03 | 100698 | 27-Mar-02 (SPEAG, in house check Dec-03) | In house check: Dec-05 |
| Network Analyzer HP 8753E | US37390585 S4206 | 18-Oct-01 (SPEAG, in house check Nov-04) | In house check: Nov-05 |

Calibrated by: **Judith Müller** **Laboratory Technician** *[Signature]*

Approved by: **Katja Pokovic** **Technical Manager** *[Signature]*

Issued: March 21, 2005

This calibration certificate shall not be reproduced except in full without written approval of the laboratory.



Accredited by the Swiss Federal Office of Metrology and Accreditation
The Swiss Accreditation Service is one of the signatories to the EA
Multilateral Agreement for the recognition of calibration certificates

Accreditation No.: **SCS 108**

Glossary:

| | |
|-------|---------------------------------|
| TSL | tissue simulating liquid |
| ConvF | sensitivity in TSL / NORM x,y,z |
| N/A | not applicable or not measured |

Calibration is Performed According to the Following Standards:

- IEEE Std 1528-2003, "IEEE Recommended Practice for Determining the Peak Spatial-Averaged Specific Absorption Rate (SAR) in the Human Head from Wireless Communications Devices: Measurement Techniques", December 2003
- CENELEC EN 50361, "Basic standard for the measurement of Specific Absorption Rate related to human exposure to electromagnetic fields from mobile phones (300 MHz - 3 GHz), July 2001
- Federal Communications Commission Office of Engineering & Technology (FCC OET), "Evaluating Compliance with FCC Guidelines for Human Exposure to Radiofrequency Electromagnetic Fields; Additional Information for Evaluating Compliance of Mobile and Portable Devices with FCC Limits for Human Exposure to Radiofrequency Emissions", Supplement C (Edition 01-01) to Bulletin 65

Additional Documentation:

- DASY4 System Handbook

Methods Applied and Interpretation of Parameters:

- Measurement Conditions:* Further details are available from the Validation Report at the end of the certificate. All figures stated in the certificate are valid at the frequency indicated.
- Antenna Parameters with TSL:* The dipole is mounted with the spacer to position its feed point exactly below the center marking of the flat phantom section, with the arms oriented parallel to the body axis.
- Feed Point Impedance and Return Loss:* These parameters are measured with the dipole positioned under the liquid filled phantom. The impedance stated is transformed from the measurement at the SMA connector to the feed point. The Return Loss ensures low reflected power. No uncertainty required.
- Electrical Delay:* One-way delay between the SMA connector and the antenna feed point. No uncertainty required.
- SAR measured:* SAR measured at the stated antenna input power.
- SAR normalized:* SAR as measured, normalized to an input power of 1 W at the antenna connector.
- SAR for nominal TSL parameters:* The measured TSL parameters are used to calculate the nominal SAR result.

Measurement Conditions

DASY system configuration, as far as not given on page 1.

| | | |
|-------------------------------------|---------------------------|-------------|
| DASY Version | DASY4 | V4.5 |
| Extrapolation | Advanced Extrapolation | |
| Phantom | Modular Flat Phantom V5.0 | |
| Distance Dipole Center - TSL | 10 mm | with Spacer |
| Area Scan resolution | dx, dy = 15 mm | |
| Zoom Scan Resolution | dx, dy, dz = 5 mm | |
| Frequency | 2450 MHz ± 1 MHz | |

Head TSL parameters

The following parameters and calculations were applied.

| | Temperature | Permittivity | Conductivity |
|---|-----------------|--------------|------------------|
| Nominal Head TSL parameters | 22.0 °C | 39.2 | 1.80 mho/m |
| Measured Head TSL parameters | (22.0 ± 0.2) °C | 39.9 ± 6 % | 1.78 mho/m ± 6 % |
| Head TSL temperature during test | (21.5 ± 0.2) °C | --- | --- |

SAR result with Head TSL

| SAR averaged over 1 cm³ (1 g) of Head TSL | condition | |
|---|--------------------|-----------------------------------|
| SAR measured | 250 mW input power | 13.7 mW / g |
| SAR normalized | normalized to 1W | 54.8 mW / g |
| SAR for nominal Head TSL parameters ¹ | normalized to 1W | 55.5 mW / g ± 17.0 % (k=2) |

| SAR averaged over 10 cm³ (10 g) of Head TSL | condition | |
|---|--------------------|-----------------------------------|
| SAR measured | 250 mW input power | 6.36 mW / g |
| SAR normalized | normalized to 1W | 25.4 mW / g |
| SAR for nominal Head TSL parameters ¹ | normalized to 1W | 25.8 mW / g ± 16.5 % (k=2) |

¹ Correction to nominal TSL parameters according to d), chapter "SAR Sensitivities"

Body TSL parameters

The following parameters and calculations were applied.

| | Temperature | Permittivity | Conductivity |
|----------------------------------|-----------------|--------------|------------------|
| Nominal Body TSL parameters | 22.0 °C | 52.7 | 1.95 mho/m |
| Measured Body TSL parameters | (22.0 ± 0.2) °C | 52.3 ± 6 % | 2.01 mho/m ± 6 % |
| Body TSL temperature during test | (22.0 ± 0.2) °C | --- | --- |

SAR result with Body TSL

| SAR averaged over 1 cm ³ (1 g) of Body TSL | condition | |
|---|--------------------|-----------------------------------|
| SAR measured | 250 mW input power | 13.4 mW / g |
| SAR normalized | normalized to 1W | 53.6 mW / g |
| SAR for nominal Body TSL parameters ² | normalized to 1W | 52.5 mW / g ± 17.0 % (k=2) |

| SAR averaged over 10 cm ³ (10 g) of Body TSL | condition | |
|---|--------------------|-----------------------------------|
| SAR measured | 250 mW input power | 6.18 mW / g |
| SAR normalized | normalized to 1W | 24.7 mW / g |
| SAR for nominal Body TSL parameters ² | normalized to 1W | 24.2 mW / g ± 16.5 % (k=2) |

² Correction to nominal TSL parameters according to d), chapter "SAR Sensitivities"

Appendix

Antenna Parameters with Head TSL

| | |
|--------------------------------------|--------------------------------|
| Impedance, transformed to feed point | 52.4 Ω + 5.6 j Ω |
| Return Loss | - 24.4 dB |

Antenna Parameters with Body TSL

| | |
|--------------------------------------|--------------------------------|
| Impedance, transformed to feed point | 48.4 Ω + 5.9 j Ω |
| Return Loss | - 24.2 dB |

General Antenna Parameters and Design

| | |
|----------------------------------|----------|
| Electrical Delay (one direction) | 1.161 ns |
|----------------------------------|----------|

After long term use with 100W radiated power, only a slight warming of the dipole near the feedpoint can be measured.

The dipole is made of standard semirigid coaxial cable. The center conductor of the feeding line is directly connected to the second arm of the dipole. The antenna is therefore short-circuited for DC-signals.

No excessive force must be applied to the dipole arms, because they might bend or the soldered connections near the feedpoint may be damaged.

Additional EUT Data

| | |
|-----------------|-----------------|
| Manufactured by | SPEAG |
| Manufactured on | August 26, 2003 |

DASY4 Validation Report for Head TSL

Date/Time: 14.03.2005 16:57:15

Test Laboratory: SPEAG, Zurich, Switzerland

DUT: Dipole 2450 MHz; Type: D2450V2; Serial: D2450V2 - SN737

Communication System: CW-2450; Frequency: 2450 MHz; Duty Cycle: 1:1

Medium: HSL U10 BB;

Medium parameters used: $f = 2450$ MHz; $\sigma = 1.78$ mho/m; $\epsilon_r = 39.9$; $\rho = 1000$ kg/m³

Phantom section: Flat Section

Measurement Standard: DASY4 (High Precision Assessment)

DASY4 Configuration:

- Probe: ES3DV2 - SN3025; ConvF(4.4, 4.4, 4.4); Calibrated: 29.10.2004
- Sensor-Surface: 4mm (Mechanical Surface Detection)
- Electronics: DAE4 Sn601; Calibrated: 22.07.2004
- Phantom: Flat Phantom 5.0; Type: QD000P50AA; Serial: 1001;
- Measurement SW: DASY4, V4.5 Build 19; Postprocessing SW: SEMCAD, V1.8 Build 146

Pin = 250 mW; d = 10 mm/Area Scan (81x81x1): Measurement grid: dx=15mm, dy=15mm
Maximum value of SAR (interpolated) = 15.9 mW/g

Pin = 250 mW; d = 10 mm/Zoom Scan (7x7x7)/Cube 0: Measurement grid: dx=5mm, dy=5mm, dz=5mm

Reference Value = 92.2 V/m; Power Drift = 0.090 dB

Peak SAR (extrapolated) = 28.0 W/kg

SAR(1 g) = 13.7 mW/g; SAR(10 g) = 6.36 mW/g

Maximum value of SAR (measured) = 15.5 mW/g

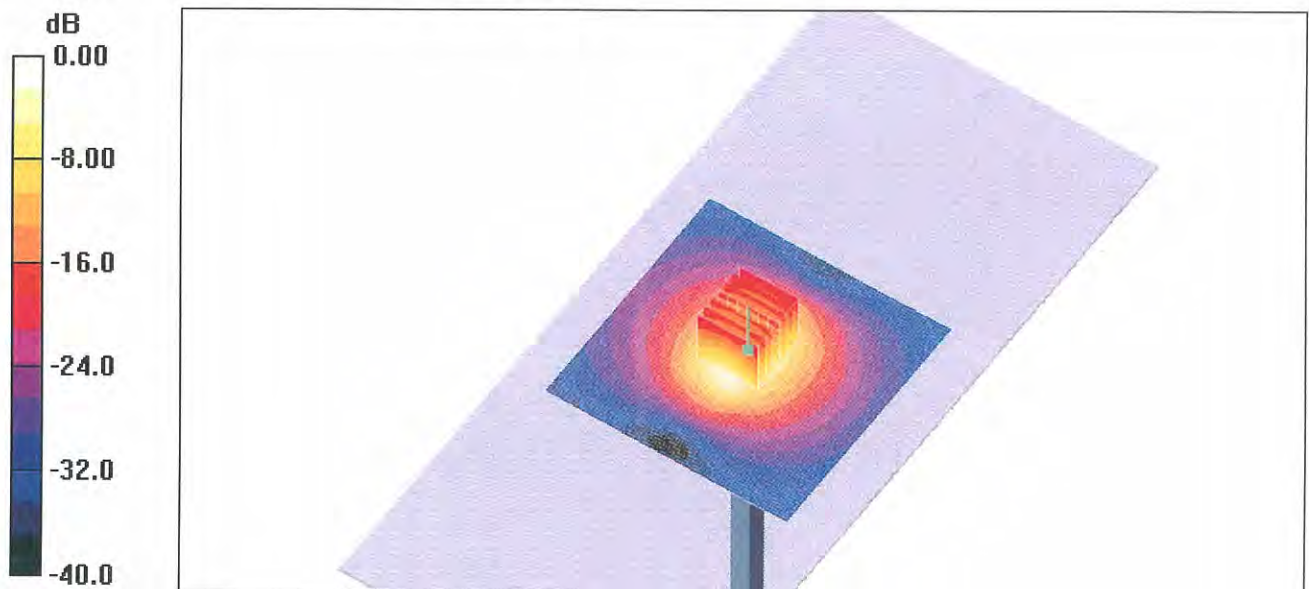

0 dB = 15.5mW/g

Impedance Measurement Plot for Head TSL

14 Mar 2005 16:53:45
[CH1] S11 1 U FS 1: 52.441 Ω 5.6094 Ω 364.39 pF 2 450.000 000 MHz

*
Del
Cor

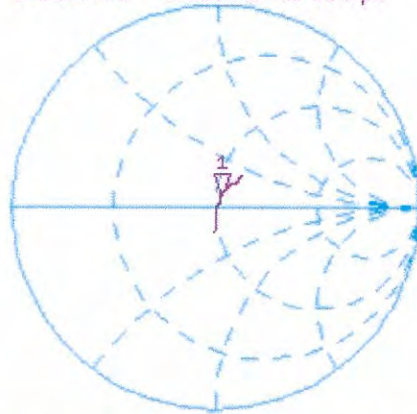

avg
16

↑

CH2 S11 LOG 5 dB/REF -20 dB 1:-24.448 dB 2 450.000 000 MHz

Cor

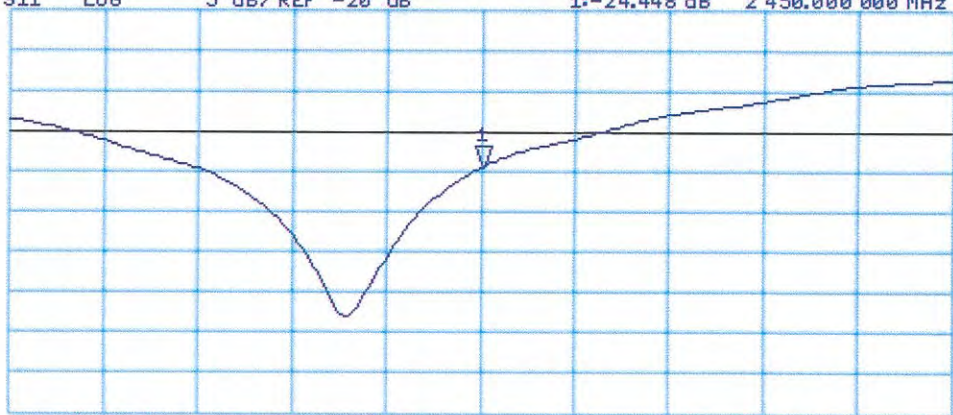

↑

CENTER 2 450.000 000 MHz

SPAN 200.000 000 MHz

DASY4 Validation Report for Body TSL

Date/Time: 16.03.2005 10:09:20

Test Laboratory: SPEAG, Zurich, Switzerland

DUT: Dipole 2450 MHz; Type: D2450V2; Serial: D2450V2 - SN737

Communication System: CW-2450; Frequency: 2450 MHz; Duty Cycle: 1:1

Medium: M2450;

Medium parameters used: $f = 2450$ MHz; $\sigma = 2.01$ mho/m; $\epsilon_r = 52.3$; $\rho = 1000$ kg/m³

Phantom section: Flat Section

Measurement Standard: DASY4 (High Precision Assessment)

DASY4 Configuration:

- Probe: ES3DV2 - SN3025; ConvF(4.13, 4.13, 4.13); Calibrated: 29.10.2004
- Sensor-Surface: 4mm (Mechanical Surface Detection)
- Electronics: DAE4 Sn601; Calibrated: 22.07.2004
- Phantom: Flat Phantom 5.0; Type: QD000P50AA; Serial: 1001;
- Measurement SW: DASY4, V4.5 Build 19; Postprocessing SW: SEMCAD, V1.8 Build 146

Pin = 250 mW; d = 10 mm/Area Scan (81x81x1): Measurement grid: dx=15mm, dy=15mm
Maximum value of SAR (interpolated) = 15.6 mW/g

Pin = 250 mW; d = 10 mm/Zoom Scan (7x7x7)/Cube 0: Measurement grid: dx=5mm, dy=5mm, dz=5mm

Reference Value = 85.5 V/m; Power Drift = 0.079 dB

Peak SAR (extrapolated) = 27.3 W/kg

SAR(1 g) = 13.4 mW/g; SAR(10 g) = 6.18 mW/g

Maximum value of SAR (measured) = 15.1 mW/g

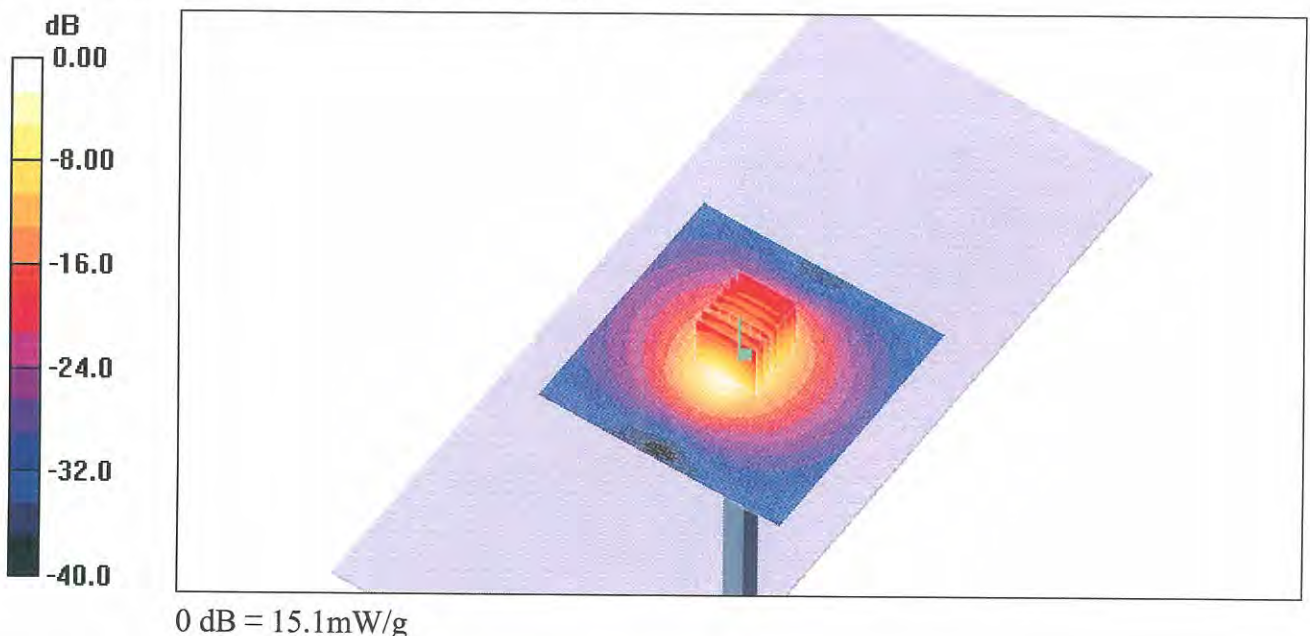

Impedance Measurement Plot for Body TSL

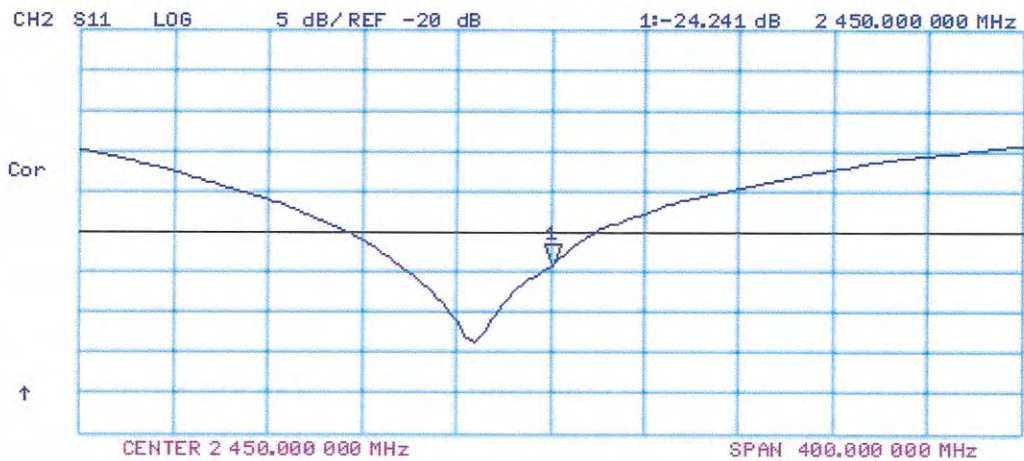
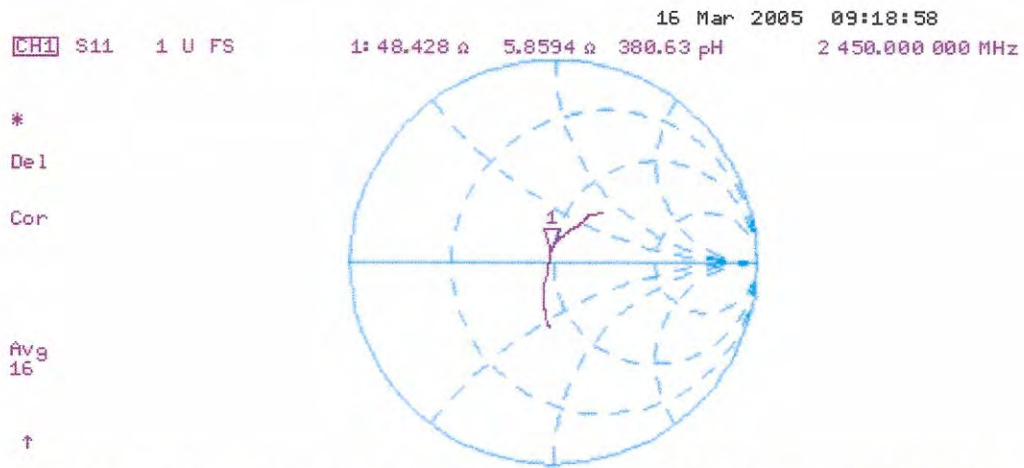



D3: DAE SN: 579

Schmid & Partner Engineering AG

s p e a g

Zeughausstrasse 43, 8004 Zurich, Switzerland
Phone +41 1 245 9700, Fax +41 1 245 9779
info@speag.com, <http://www.speag.com>

IMPORTANT NOTICE

USAGE OF THE DAE 3

The DAE unit is a delicate, high precision instrument and requires careful treatment by the user. There are no serviceable parts inside the DAE. Special attention shall be given to the following points:

Battery Exchange: The battery cover of the DAE3 unit is connected to a fragile 3-pin battery connector. Customer is responsible to apply utmost caution not to bend or damage the connector when changing batteries.

Shipping of the DAE: Before shipping the DAE to SPEAG for calibration Customer shall remove the batteries and pack the DAE in an antistatic bag. The packaging shall protect the DAE from impacts during transportation. The package shall be marked to indicate that a fragile instrument is inside.

E-Stop Failures: Touch detection may be malfunctioning due to broken magnets in the E-stop. Rough handling of the E-stop may lead to damage of these magnets. Touch and collision errors are often caused by dust and dirt accumulated in the E-stop. To prevent E-stop failure, Customer shall always mount the probe to the DAE carefully and keep the DAE unit in a non-dusty environment if not used for measurements.

Repair: Minor repairs are performed at no extra cost during the annual calibration. However, SPEAG reserves the right to charge for any repair especially if rough unprofessional handling caused the defect.

Important Note:

Warranty and calibration is void if the DAE unit is disassembled partly or fully by the Customer.

Important Note:

Never attempt to grease or oil the E-stop assembly. Cleaning and readjusting of the E-stop assembly is allowed by certified SPEAG personnel only and is part of the annual calibration procedure.

Schmid & Partner Engineering

**Calibration Laboratory of
Schmid & Partner
Engineering AG**
Zeughausstrasse 43, 8004 Zurich, Switzerland



S Schweizerischer Kalibrierdienst
C Service suisse d'étalonnage
S Servizio svizzero di taratura
S Swiss Calibration Service

Accredited by the Swiss Federal Office of Metrology and Accreditation
The Swiss Accreditation Service is one of the signatories to the EA
Multilateral Agreement for the recognition of calibration certificates

Accreditation No.: **SCS 108**

Client **ADT (Auden)**

Certificate No: **DAE3-579_Mar05**

CALIBRATION CERTIFICATE

Object **DAE3 - SD 000 D03 AA - SN: 579**

Calibration procedure(s) **QA CAL-06.v10
Calibration procedure for the data acquisition unit (DAE)**

Calibration date: **March 23, 2005**

Condition of the calibrated item **In Tolerance**

This calibration certificate documents the traceability to national standards, which realize the physical units of measurements (SI).
The measurements and the uncertainties with confidence probability are given on the following pages and are part of the certificate.

All calibrations have been conducted in the closed laboratory facility: environment temperature (22 ± 3)°C and humidity < 70%.

Calibration Equipment used (M&TE critical for calibration)

| Primary Standards | ID # | Cal Date (Calibrated by, Certificate No.) | Scheduled Calibration |
|-----------------------------------|-------------|---|-----------------------|
| Fluke Process Calibrator Type 702 | SN: 6295803 | 7-Sep-04 (Sintrel, No.E-040073) | Sep-05 |

| Secondary Standards | ID # | Check Date (in house) | Scheduled Check |
|---------------------|--------------------|-----------------------------------|-----------------------|
| Calibrator Box V1.1 | SE UMS 006 AB 1002 | 16-Jul-04 (SPEAG, in house check) | In house check Jul-05 |

| | | | |
|----------------|-----------------------|------------------------|---|
| Calibrated by: | Name Eric Hainfeld | Function Technician | Signature  |
|----------------|-----------------------|------------------------|---|

| | | | |
|--------------|---------------------|--------------|---|
| Approved by: | Name Fin Bomholt | R&D Director |  |
|--------------|---------------------|--------------|---|

Issued: March 23, 2005

This calibration certificate shall not be reproduced except in full without written approval of the laboratory.

**Calibration Laboratory of
Schmid & Partner
Engineering AG**
Zeughausstrasse 43, 8004 Zurich, Switzerland



S Schweizerischer Kalibrierdienst
C Service suisse d'étalonnage
S Servizio svizzero di taratura
S Swiss Calibration Service

Accredited by the Swiss Federal Office of Metrology and Accreditation
The Swiss Accreditation Service is one of the signatories to the EA
Multilateral Agreement for the recognition of calibration certificates

Accreditation No.: **SCS 108**

Glossary

DAE digital acquisition electronics
Connector angle information used in DASY system to align probe sensor X to the robot coordinate system.

Methods Applied and Interpretation of Parameters

- **DC Voltage Measurement:** Calibration Factor assessed for use in DASY system by comparison with a calibrated instrument traceable to national standards. The figure given corresponds to the full scale range of the voltmeter in the respective range.
- **Connector angle:** The angle of the connector is assessed measuring the angle mechanically by a tool inserted. Uncertainty is not required.
- The following parameters contain technical information as a result from the performance test and require no uncertainty.
- **DC Voltage Measurement Linearity:** Verification of the Linearity at +10% and -10% of the nominal calibration voltage. Influence of offset voltage is included in this measurement.
- **Common mode sensitivity:** Influence of a positive or negative common mode voltage on the differential measurement.
- **Channel separation:** Influence of a voltage on the neighbor channels not subject to an input voltage.
- **AD Converter Values with inputs shorted:** Values on the internal AD converter corresponding to zero input voltage
- **Input Offset Measurement:** Output voltage and statistical results over a large number of zero voltage measurements.
- **Input Offset Current:** Typical value for information; Maximum channel input offset current, not considering the input resistance.
- **Input resistance:** DAE input resistance at the connector, during internal auto-zeroing and during measurement.
- **Low Battery Alarm Voltage:** Typical value for information. Below this voltage, a battery alarm signal is generated.
- **Power consumption:** Typical value for information. Supply currents in various operating modes.

DC Voltage Measurement

A/D - Converter Resolution nominal

High Range: 1LSB = 6.1 μ V , full range = -100...+300 mV
 Low Range: 1LSB = 61nV , full range = -1.....+3mV

DASY measurement parameters: Auto Zero Time: 3 sec; Measuring time: 3 sec

| Calibration Factors | X | Y | Z |
|---------------------|--------------------------|--------------------------|--------------------------|
| High Range | 404.498 \pm 0.1% (k=2) | 404.560 \pm 0.1% (k=2) | 404.343 \pm 0.1% (k=2) |
| Low Range | 3.95298 \pm 0.7% (k=2) | 3.97918 \pm 0.7% (k=2) | 3.94012 \pm 0.7% (k=2) |

Connector Angle

| | |
|---|-----------------------------------|
| Connector Angle to be used in DASY system | 310 $^{\circ}$ \pm 1 $^{\circ}$ |
|---|-----------------------------------|

Appendix

1. DC Voltage Linearity

| High Range | Input (μV) | Reading (μV) | Error (%) |
|-------------------|-------------------------|---------------------------|-----------|
| Channel X + Input | 200000 | 200000 | 0.00 |
| Channel X + Input | 20000 | 20000.39 | 0.00 |
| Channel X - Input | 20000 | -19991.88 | -0.04 |
| Channel Y + Input | 200000 | 200000.2 | 0.00 |
| Channel Y + Input | 20000 | 19997.23 | -0.01 |
| Channel Y - Input | 20000 | -19994.34 | -0.03 |
| Channel Z + Input | 200000 | 199999.8 | 0.00 |
| Channel Z + Input | 20000 | 19996.66 | -0.02 |
| Channel Z - Input | 20000 | -19995.76 | -0.02 |

| Low Range | Input (μV) | Reading (μV) | Error (%) |
|-------------------|-------------------------|---------------------------|-----------|
| Channel X + Input | 2000 | 2000.1 | 0.00 |
| Channel X + Input | 200 | 199.65 | -0.18 |
| Channel X - Input | 200 | -200.44 | 0.22 |
| Channel Y + Input | 2000 | 1999.9 | 0.00 |
| Channel Y + Input | 200 | 199.72 | -0.14 |
| Channel Y - Input | 200 | -200.84 | 0.42 |
| Channel Z + Input | 2000 | 2000 | 0.00 |
| Channel Z + Input | 200 | 199.53 | -0.24 |
| Channel Z - Input | 200 | -201.02 | 0.51 |

2. Common mode sensitivity

DASY measurement parameters: Auto Zero Time: 3 sec; Measuring time: 3 sec

| | Common mode Input Voltage (mV) | High Range Average Reading (μV) | Low Range Average Reading (μV) |
|-----------|--------------------------------|--|---|
| Channel X | 200 | 6.17 | 5.48 |
| | - 200 | -5.20 | -5.89 |
| Channel Y | 200 | 8.93 | 9.11 |
| | - 200 | -9.89 | -10.38 |
| Channel Z | 200 | 9.08 | 8.94 |
| | - 200 | -10.25 | -10.98 |

3. Channel separation

DASY measurement parameters: Auto Zero Time: 3 sec; Measuring time: 3 sec

| | Input Voltage (mV) | Channel X (μV) | Channel Y (μV) | Channel Z (μV) |
|-----------|--------------------|-----------------------------|-----------------------------|-----------------------------|
| Channel X | 200 | - | 0.60 | -0.26 |
| Channel Y | 200 | 1.53 | - | 2.09 |
| Channel Z | 200 | -2.89 | 0.01 | - |

4. AD-Converter Values with inputs shorted

DASY measurement parameters: Auto Zero Time: 3 sec; Measuring time: 3 sec

| | High Range (LSB) | Low Range (LSB) |
|-----------|------------------|-----------------|
| Channel X | 16329 | 16485 |
| Channel Y | 16181 | 15912 |
| Channel Z | 15805 | 16242 |

5. Input Offset Measurement

DASY measurement parameters: Auto Zero Time: 3 sec; Measuring time: 3 sec

Input 10M Ω

| | Average (μ V) | min. Offset (μ V) | max. Offset (μ V) | Std. Deviation (μ V) |
|-----------|--------------------|------------------------|------------------------|---------------------------|
| Channel X | 0.26 | -0.64 | 1.42 | 0.47 |
| Channel Y | -1.12 | -2.09 | 0.11 | 0.36 |
| Channel Z | -0.86 | -1.58 | 0.11 | 0.31 |

6. Input Offset Current

Nominal Input circuitry offset current on all channels: <25fA

7. Input Resistance

| | Zeroing (MOhm) | Measuring (MOhm) |
|-----------|----------------|------------------|
| Channel X | 0.2000 | 200.3 |
| Channel Y | 0.2000 | 203.3 |
| Channel Z | 0.2000 | 204.4 |

8. Low Battery Alarm Voltage (verified during pre test)

| Typical values | Alarm Level (VDC) |
|----------------|-------------------|
| Supply (+ Vcc) | +7.9 |
| Supply (- Vcc) | -7.6 |

9. Power Consumption (verified during pre test)

| Typical values | Switched off (mA) | Stand by (mA) | Transmitting (mA) |
|----------------|-------------------|---------------|-------------------|
| Supply (+ Vcc) | +0.0 | +6 | +14 |
| Supply (- Vcc) | -0.01 | -8 | -9 |

10. Common Mode Bit Generation (verified during pre test)

| Typical values | Bit set to High at Common Mode Error (V _{DC}) |
|-----------------|---|
| Channel X, Y, Z | +1.25 |



APPENDIX D: SYSTEM CERTIFICATE & CALIBRATION

D1: SAM PHANTOM

Schmid & Partner Engineering AG

Zeughausstrasse 43, 8004 Zurich, Switzerland, Phone +41 1 245 97 00, Fax +41 1 245 97 79

Certificate of conformity / First Article Inspection

| | |
|-----------------------|--|
| Item | SAM Twin Phantom V4.0 |
| Type No | QD 000 P40 CA |
| Series No | TP-1150 and higher |
| Manufacturer / Origin | Untersee Composites Hauptstr. 69 CH-8559 Fruthwilen Switzerland |

Tests

The series production process used allows the limitation to test of first articles. Complete tests were made on the pre-series Type No. QD 000 P40 AA, Serial No. TP-1001 and on the series first article Type No. QD 000 P40 BA, Serial No. TP-1006. Certain parameters have been retested using further series units (called samples).

| Test | Requirement | Details | Units tested |
|----------------------|---|--|---------------------------|
| Shape | Compliance with the geometry according to the CAD model. | IT'IS CAD File (*) | First article, Samples |
| Material thickness | Compliant with the requirements according to the standards | 2mm +/- 0.2mm in specific areas | First article, Samples |
| Material parameters | Dielectric parameters for required frequencies | 200 MHz – 3 GHz Relative permittivity < 5 Loss tangent < 0.05. | Material sample TP 104-5 |
| Material resistivity | The material has been tested to be compatible with the liquids defined in the standards | Liquid type HSL 1800 and others according to the standard. | Pre-series, First article |

Standards

- [1] CENELEC EN 50361
 - [2] IEEE P1528-200x draft 6.5
 - [3] IEC PT 62209 draft 0.9
- (*) The IT'IS CAD file is derived from [2] and is also within the tolerance requirements of the shapes of [1] and [3].

Conformity

Based on the sample tests above, we certify that this item is in compliance with the uncertainty requirements of SAR measurements specified in standard [1] and draft standards [2] and [3].

Date 28.02.2002

Signature / Stamp

F. Bombault

**Schmid & Partner
Engineering AG**

Zeughausstrasse 43, CH-8004 Zurich
Tel. +41 1 245 97 00, Fax +41 1 245 97 79

Johannes Kofler