



FCC TEST REPORT

REPORT NO.: RF931008L04
MODEL NO.: 557S
OEM MODEL NO.: 557C
RECEIVED: Oct. 08, 2004
TESTED: Oct. 26 ~ Oct. 29, 2004

APPLICANT: Elitegroup Computer Systems Co., Ltd.
ADDRESS: 3F, No. 240, Sec.1, Nei Hu Rd., Taipei, Taiwan
114, R.O.C.

ISSUED BY: Advance Data Technology Corporation
LAB ADDRESS: No. 47, 14th Ling, Chia Pau Tsuen, Lin Kou
Hsiang 244, Taipei Hsien, Taiwan, R.O.C.
TEST LOCATION: No. 19, Hwa Ya 2nd Rd., Wen Hwa Tsuen, Kwei
Shan Hsiang, Taoyuan Hsien 333, Taiwan,
R.O.C.

This test report consists of 66 pages in total. It may be duplicated completely for legal use with the approval of the applicant. It should not be reproduced except in full, without the written approval of our laboratory. The client should not use it to claim product endorsement by CNLA, A2LA or any government agencies. The test results in the report only apply to the tested sample.



No. 2177-01



0528
ILAC MRA



Table of Contents

1	CERTIFICATION	4
2	SUMMARY OF TEST RESULTS	5
2.1	MEASUREMENT UNCERTAINTY	5
3	GENERAL INFORMATION	6
3.1	GENERAL DESCRIPTION OF EUT	6
3.2	DESCRIPTION OF TEST MODES.....	7
3.3	GENERAL DESCRIPTION OF APPLIED STANDARDS.....	7
3.4	DESCRIPTION OF SUPPORT UNITS	8
3.5	CONFIGURATION OF SYSTEM UNDER TEST.....	8
4	TEST TYPES AND RESULTS	9
4.1	CONDUCTED EMISSION MEASUREMENT	9
4.1.1	LIMITS OF CONDUCTED EMISSION MEASUREMENT	9
4.1.2	TEST INSTRUMENTS	9
4.1.3	TEST PROCEDURES	10
4.1.4	DEVIATION FROM TEST STANDARD	10
4.1.5	TEST SETUP	11
4.1.6	EUT OPERATING CONDITIONS	11
4.1.7	TEST RESULTS.....	12
4.2	RADIATED EMISSION MEASUREMENT	18
4.2.1	LIMITS OF RADIATED EMISSION MEASUREMENT	18
4.2.2	TEST INSTRUMENTS	19
4.2.3	TEST PROCEDURES	20
4.2.4	DEVIATION FROM TEST STANDARD	20
4.2.5	TEST SETUP	21
4.2.6	EUT OPERATING CONDITIONS	21
4.2.7	TEST RESULTS.....	22
4.2.8	TEST RESULTS (A)	24
4.2.9	TEST RESULTS (B).....	27
4.3	6dB BANDWIDTH MEASUREMENT	30
4.3.1	LIMITS OF 6dB BANDWIDTH MEASUREMENT	30
4.3.2	TEST INSTRUMENTS	30
4.3.3	TEST PROCEDURE	31
4.3.4	DEVIATION FROM TEST STANDARD	31
4.3.5	TEST SETUP	31
4.3.6	EUT OPERATING CONDITIONS	31



4.3.7	TEST RESULTS (A)	32
4.3.8	TEST RESULTS (B)	36
4.4	MAXIMUM PEAK OUTPUT POWER	40
4.4.1	LIMITS OF MAXIMUM PEAK OUTPUT POWER MEASUREMENT	40
4.4.2	TEST INSTRUMENTS	40
4.4.3	TEST PROCEDURES	41
4.4.4	DEVIATION FROM TEST STANDARD	41
4.4.5	TEST SETUP	41
4.4.6	EUT OPERATING CONDITIONS	41
4.4.7	TEST RESULTS (A)	42
4.4.8	TEST RESULTS (B)	42
4.5	POWER SPECTRAL DENSITY MEASUREMENT	43
4.5.1	LIMITS OF POWER SPECTRAL DENSITY MEASUREMENT	43
4.5.2	TEST INSTRUMENTS	43
4.5.3	TEST PROCEDURE	44
4.5.4	DEVIATION FROM TEST STANDARD	44
4.5.5	TEST SETUP	44
4.5.6	EUT OPERATING CONDITIONS	44
4.5.7	TEST RESULTS (A)	45
4.5.8	TEST RESULTS (B)	49
4.6	BAND EDGES MEASUREMENT	53
4.6.1	LIMITS OF BAND EDGES MEASUREMENT	53
4.6.2	TEST INSTRUMENTS	53
4.6.3	TEST PROCEDURE	53
4.6.4	DEVIATION FROM TEST STANDARD	53
4.6.5	EUT OPERATING CONDITION	53
4.6.6	TEST RESULTS	54
4.6.7	TEST RESULTS(A)	54
4.6.8	TEST RESULTS(B)	54
4.7	ANTENNA REQUIREMENT	63
4.7.1	STANDARD APPLICABLE	63
4.7.2	ANTENNA CONNECTED CONSTRUCTION	63
5	PHOTOGRAPHS OF THE TEST CONFIGURATION	64
6	INFORMATION ON THE TESTING LABORATORIES	66



1 CERTIFICATION

PRODUCT : Notebook
BRAND NAME : ECS
MODEL NO. : 557S
OEM MODEL NO.: 557C
APPLICANT : Elitegroup Computer Systems Co., Ltd.
TESTED : Oct. 26 ~ Oct. 29, 2004
TEST SAMPLE : ENGINEERING SAMPLE
STANDARDS : FCC Part 15, Subpart C (Section 15.247),
ANSI C63.4-2003

The above equipment (model no.: 557S) has been tested by **Advance Data Technology Corporation**, and found compliance with the requirement of the above standards. The test record, data evaluation & Equipment Under Test (EUT) configurations represented herein are true and accurate accounts of the measurements of the sample's EMC characteristics under the conditions specified in this report.

PREPARED BY : Windy Chou, **DATE:** Nov. 05, 2004
(Windy Chou)

TECHNICAL ACCEPTANCE : Gary Chang, **DATE:** Nov. 05, 2004
Responsible for RF (Gary Chang)

APPROVED BY : Cody Chang, **DATE:** Nov. 05, 2004
(Cody Chang, Deputy Manager)

2 SUMMARY OF TEST RESULTS

The EUT has been tested according to the following specifications:

APPLIED STANDARD: FCC Part 15, Subpart C			
Standard Section	Test Type and Limit	Result	REMARK
15.207	AC Power Conducted Emission	PASS	Meet the requirement of limit. Minimum passing margin is -17.04dB at 0.205MHz
15.247(a)(2)	Spectrum Bandwidth of a Direct Sequence Spread Spectrum System Limit: min. 500kHz	PASS	Meet the requirement of limit.
15.247(b)	Maximum Peak Output Power Limit: max. 30dBm	PASS	Meet the requirement of limit.
15.247(d)	Transmitter Radiated Emissions Limit: Table 15.209	PASS	Meet the requirement of limit. Minimum passing margin is -0.52dB at 2063.00MHz
15.247(e)	Power Spectral Density Limit: max. 8dBm	PASS	Meet the requirement of limit.
15.247(d)	Band Edge Measurement Limit: 20 dB less than the peak value of fundamental frequency	PASS	Meet the requirement of limit.

2.1 MEASUREMENT UNCERTAINTY

Where relevant, the following measurement uncertainty levels have been estimated for tests performed on the EUT as specified in CISPR 16-4:

Measurement	Frequency	Uncertainty
Conducted emissions	9k~30MHz	2.44 dB
Radiated emissions	30MHz ~ 200MHz	3.63 dB
	200MHz ~ 1000MHz	3.65 dB
	1GHz ~ 18GHz	2.20 dB
	18GHz ~ 40GHz	1.88 dB



3 GENERAL INFORMATION

3.1 GENERAL DESCRIPTION OF EUT

PRODUCT	Notebook
MODEL NO.	557S
OEM MODEL NO.	557C
POWER SUPPLY	19.0Vdc from power adapter
MODULATION TYPE	BPSK, QPSK, CCK, 16QAM, 64QAM
RADIO TECHNOLOGY	DSSS, OFDM
TRANSFER RATE	802.11b: 11/5.5/2/1Mbps 802.11g: 54/48/36/24/18/12/9/6Mbps
FREQUENCY RANGE	2412MHz ~ 2462MHz
NUMBER OF CHANNEL	11
MAXIMUM OUTPUT POWER	52.481mW
ANTENNA TYPE	PIFA antenna with 0.632dBi gain
DATA CABLE	NA
I/O PORTS	NA
ASSOCIATED DEVICES	NA

NOTE:

1. The mini-PCI card which brand is Qcom, the model is Q802MKG is installed in Notebook PC.
2. The EUT operates in the 2.4GHz frequency spectrum with throughput of up to 54Mbps.
3. The EUT complies with IEEE 802.11g standards and backwards compatible with IEEE 802.11b products.
4. The EUT was powered by the following adapter:

Brand	LITEON
Model	PA-1600-06
Input	100-240Vac, 1.5A, 50-60Hz
Output	19Vdc, 3.16A

5. This EUT has other different models that listed below due to marketing requirement.

Brand Name	Model Name
ECS	557S
ECS	557C

6. The above EUT information was declared by manufacturer and for more detailed features description, please refer to the manufacturer's specifications or User's Manual.



3.2 DESCRIPTION OF TEST MODES

Eleven channels are provided to this EUT.

Channel	Frequency	Channel	Frequency
1	2412 MHz	7	2442 MHz
2	2417 MHz	8	2447 MHz
3	2422 MHz	9	2452 MHz
4	2427 MHz	10	2457 MHz
5	2432 MHz	11	2462 MHz
6	2437 MHz		

NOTE:

1. Below 1GHz, the channel 1, 6, and 11 were pre-tested in chamber. The channel 11, the worst case, was chosen for final test.
2. Above 1GHz, the channel 1, 6, and 11 were tested individually.
3. From our experience and technical viewpoint, we have chosen data rates 11Mbps for CCK technique and 6Mbps for OFDM technique, as the worst cases for the test among other data rates.
4. Two test results were presented in the following sections. The test result A was for CCK technique and the test result B was for OFDM technique.

3.3 GENERAL DESCRIPTION OF APPLIED STANDARDS

The EUT is a Notebook. According to the specifications of the manufacturer, it must comply with the requirements of the following standards:

FCC Part 15, Subpart C. (15.247)
ANSI C63.4-2003

All test items have been performed and recorded as per the above standards.

NOTE: The EUT is also considered as a kind of computer peripheral, because the connection to computer is necessary for typical use. It has been verified to comply with the requirements of FCC Part 15, Subpart B, Class B (DoC). The test report has been issued separately.



3.4 DESCRIPTION OF SUPPORT UNITS

The EUT has been tested as an independent unit together with other necessary accessories or support units. The following support units or accessories were used to form a representative test configuration during the tests.

NO.	PRODUCT	BRAND	MODEL NO.	SERIAL NO.	FCC ID
1	PRINTER	EPSON	LQ-300+	DCGY054147	FCC DoC Approved
2	600 O Load	NA	NA	NA	NA

NO.	SIGNAL CABLE DESCRIPTION OF THE ABOVE SUPPORT UNITS
1	1.2 shielded cable without core
2	NA

NOTE: 1. All power cords of the above support units are non shielded (1.8m).

3.5 CONFIGURATION OF SYSTEM UNDER TEST

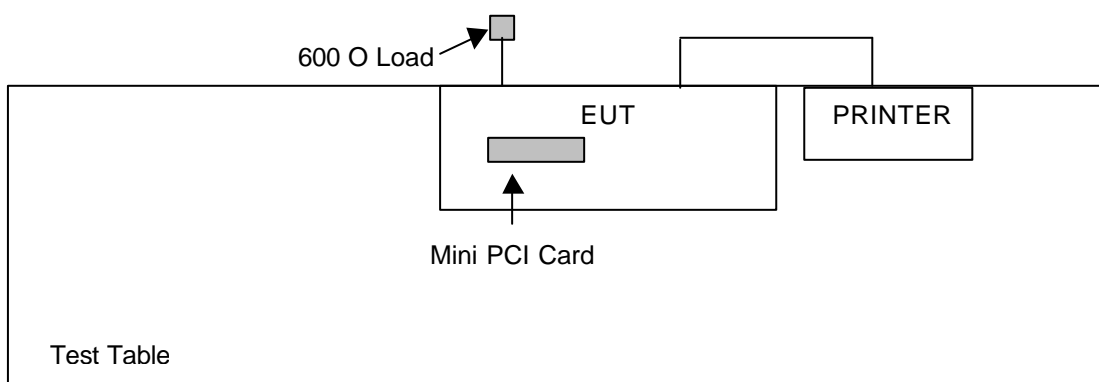



4 TEST TYPES AND RESULTS

4.1 CONDUCTED EMISSION MEASUREMENT

4.1.1 LIMITS OF CONDUCTED EMISSION MEASUREMENT

FREQUENCY OF EMISSION (MHz)	CONDUCTED LIMIT (dB μ V)	
	Quasi-peak	Average
0.15-0.5	66 to 56	56 to 46
0.5-5	56	46
5-30	60	50

- NOTE:**
1. The lower limit shall apply at the transition frequencies.
 2. The limit decreases in line with the logarithm of the frequency in the range of 0.15 to 0.50 MHz.
 3. All emanations from a class A/B digital device or system, including any network of conductors and apparatus connected thereto, shall not exceed the level of field strengths specified above.

4.1.2 TEST INSTRUMENTS

DESCRIPTION & MANUFACTURER	MODEL NO.	SERIAL NO.	CALIBRATED UNTIL
Test Receiver ROHDE & SCHWARZ	ESCS30	100291	Dec. 12, 2004
RF signal cable Woken	5D-FB	Cable-HYC01-01	Mar. 02, 2005
LISN ROHDE & SCHWARZ	ESH3-Z5	100312	Mar. 03, 2005
LISN ROHDE & SCHWARZ	ESH2-Z5	100104	Mar. 02, 2005
Software ADT	ADT_Cond_V3	NA	NA

- NOTE:**
1. The calibration interval of the above test instruments is 12 months and the calibrations are traceable to NML/ROC and NIST/USA.
 2. The test was performed in HwaYa Shielded Room 1.
 3. The VCCI Site Registration No. is C-2040.



4.1.3 TEST PROCEDURES

- a. The EUT was placed 0.4 meters from the conducting wall of the shielded room with EUT being connected to the power mains through a line impedance stabilization network (LISN). Other support units were connected to the power mains through another LISN. The two LISNs provide 50 ohm/ 50uH of coupling impedance for the measuring instrument.
- b. Both lines of the power mains connected to the EUT were checked for maximum conducted interference.
- c. The frequency range from 150kHz to 30MHz was searched. Emission levels under Limit - 20dB was not recorded.

4.1.4 DEVIATION FROM TEST STANDARD

No deviation

4.1.5 TEST SETUP

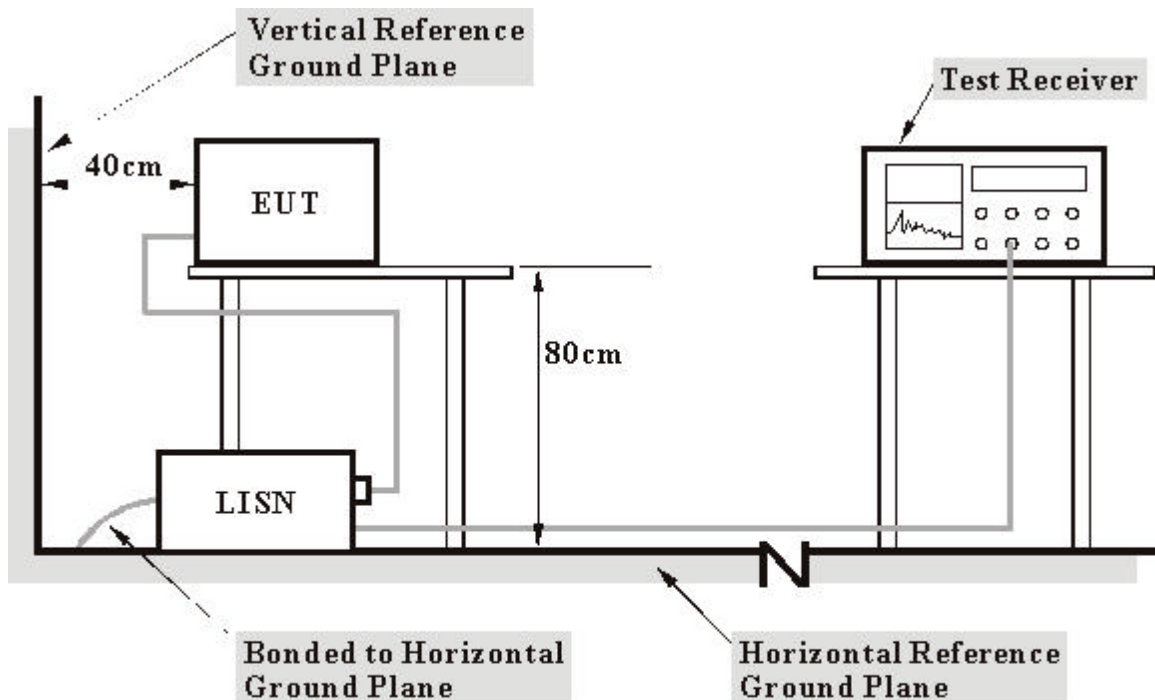

- Note:**
1. Support units were connected to second LISN.
 2. Both of LISNs (AMN) 80 cm from EUT and at the least 80 cm from other units and other metal planes support units.

For the actual test configuration, please refer to the related item – Photographs of the Test Configuration.

4.1.6 EUT OPERATING CONDITIONS

- a. Placed the EUT on the testing table.
- b. The EUT ran a test program (provided by manufacturer) to enable under transmission/receiving condition continuously at specific channel frequency.
- c. The EUT sent "H" messages to its screen.
- d. The EUT sent "H" messages to printer, and the printer printed them on paper.
- e. Steps c ~ d were repeated.



4.1.7 TEST RESULTS

EUT	Notebook	MODEL	557S
CHANNEL	1	6dB BANDWIDTH	9 kHz
INPUT POWER (SYSTEM)	120 Vac, 60 Hz	PHASE	Line (L)
ENVIRONMENTAL CONDITIONS	23deg. C, 65% RH, 991 hPa	TESTED BY	Gary Chang

No	Freq. [MHz]	Corr. Factor (dB)	Reading Value [dB (uV)]		Emission Level [dB (uV)]		Limit [dB (uV)]		Margin (dB)	
			Q.P.	AV.	Q.P.	AV.	Q.P.	AV.	Q.P.	AV.
			1	0.166	0.11	41.43	-	41.54	-	65.18
2	0.205	0.12	45.99	-	46.11	-	63.42	53.42	-17.31	-
3	0.275	0.12	38.83	-	38.95	-	60.97	50.97	-22.01	-
4	3.027	0.18	26.26	-	26.44	-	56.00	46.00	-29.56	-
5	14.801	0.76	25.90	-	26.66	-	60.00	50.00	-33.34	-
6	19.621	1.00	19.52	-	20.52	-	60.00	50.00	-39.48	-

- REMARKS:**
1. Q.P. and AV. are abbreviations of quasi-peak and average individually.
 2. "-": The Quasi-peak reading value also meets average limit and measurement with the average detector is unnecessary.
 3. The emission levels of other frequencies were very low against the limit.
 4. Margin value = Emission level - Limit value
 5. Correction factor = Insertion loss + Cable loss
 6. Emission Level = Correction Factor + Reading Value.

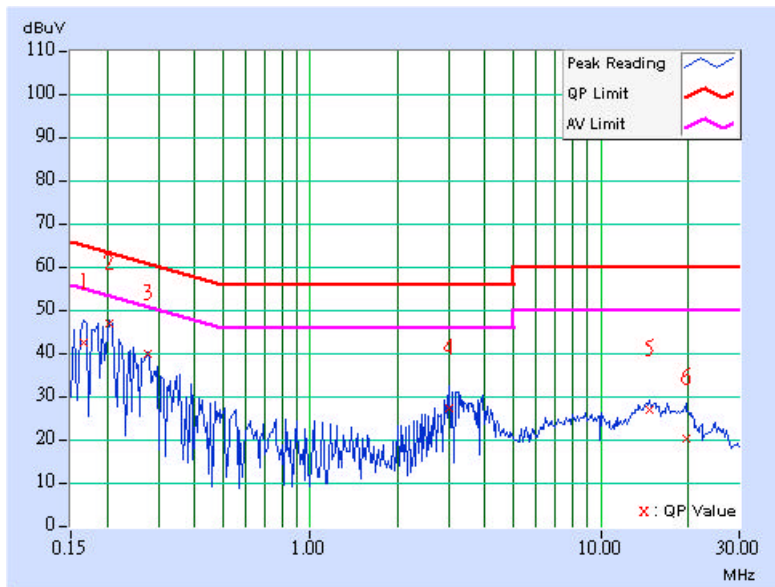



EUT	Notebook	MODEL	557S
CHANNEL	1	6dB BANDWIDTH	9 kHz
INPUT POWER (SYSTEM)	120 Vac, 60 Hz	PHASE	Neutral (N)
ENVIRONMENTAL CONDITIONS	23deg. C, 65% RH, 991 hPa	TESTED BY	Gary Chang

No	Freq. [MHz]	Corr. Factor (dB)	Reading Value [dB (uV)]		Emission Level [dB (uV)]		Limit [dB (uV)]		Margin (dB)	
			Q.P.	AV.	Q.P.	AV.	Q.P.	AV.	Q.P.	AV.
			1	0.154	0.10	42.53	-	42.63	-	65.79
2	0.205	0.11	46.27	-	46.38	-	63.42	53.42	-17.04	-
3	0.271	0.11	35.43	-	35.54	-	61.08	51.08	-25.54	-
4	0.344	0.11	33.84	-	33.95	-	59.10	49.10	-25.14	-
5	3.648	0.19	28.84	-	29.03	-	56.00	46.00	-26.97	-
6	14.938	0.64	24.31	-	24.95	-	60.00	50.00	-35.05	-

- REMARKS:**
1. Q.P. and AV. are abbreviations of quasi-peak and average individually.
 2. "-": The Quasi-peak reading value also meets average limit and measurement with the average detector is unnecessary.
 3. The emission levels of other frequencies were very low against the limit.
 4. Margin value = Emission level - Limit value
 5. Correction factor = Insertion loss + Cable loss
 6. Emission Level = Correction Factor + Reading Value.

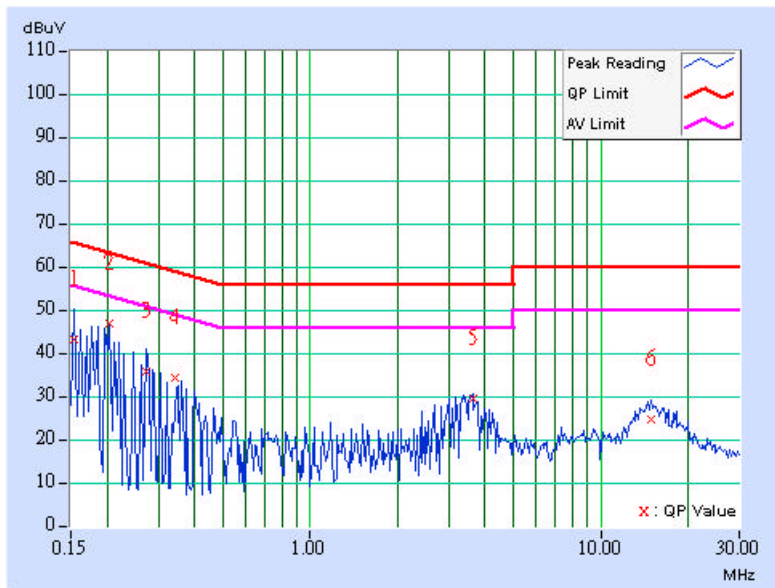



EUT	Notebook	MODEL	557S
CHANNEL	6	6dB BANDWIDTH	9 kHz
INPUT POWER (SYSTEM)	120 Vac, 60 Hz	PHASE	Line (L)
ENVIRONMENTAL CONDITIONS	23deg. C, 65% RH, 991 hPa	TESTED BY	Gary Chang

No	Freq. [MHz]	Corr. Factor (dB)	Reading Value		Emission Level		Limit		Margin	
			[dB (uV)]		[dB (uV)]		[dB (uV)]		(dB)	
			Q.P.	AV.	Q.P.	AV.	Q.P.	AV.	Q.P.	AV.
1	0.166	0.11	40.83	-	40.94	-	65.18	55.18	-24.24	-
2	0.209	0.12	45.59	-	45.71	-	63.26	53.26	-17.55	-
3	0.279	0.12	34.39	-	34.51	-	60.83	50.83	-26.32	-
4	2.891	0.18	24.86	-	25.04	-	56.00	46.00	-30.96	-
5	3.781	0.20	26.68	-	26.88	-	56.00	46.00	-29.12	-
6	14.863	0.77	26.46	-	27.23	-	60.00	50.00	-32.77	-

- REMARKS:**
1. Q.P. and AV. are abbreviations of quasi-peak and average individually.
 2. "-": The Quasi-peak reading value also meets average limit and measurement with the average detector is unnecessary.
 3. The emission levels of other frequencies were very low against the limit.
 4. Margin value = Emission level - Limit value
 5. Correction factor = Insertion loss + Cable loss
 6. Emission Level = Correction Factor + Reading Value.

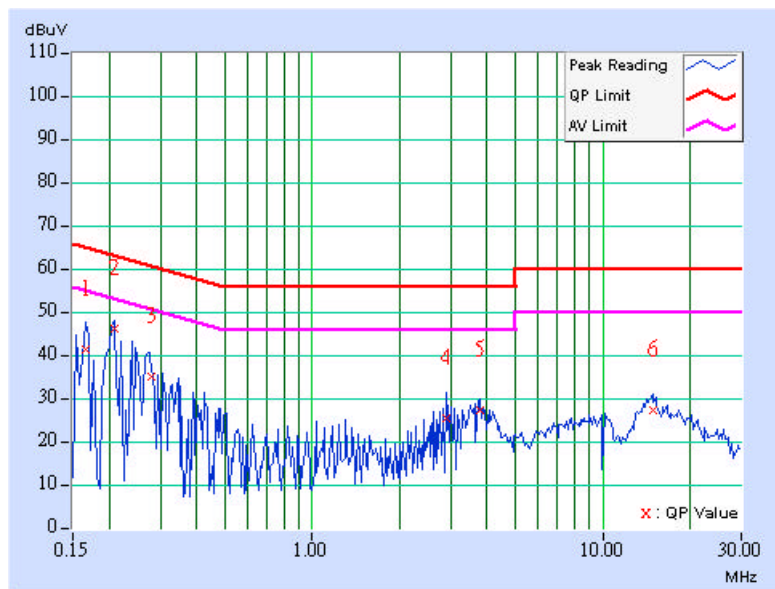



EUT	Notebook	MODEL	557S
CHANNEL	6	6dB BANDWIDTH	9 kHz
INPUT POWER (SYSTEM)	120 Vac, 60 Hz	PHASE	Neutral (N)
ENVIRONMENTAL CONDITIONS	23deg. C, 65% RH, 991 hPa	TESTED BY	Gary Chang

No	Freq. [MHz]	Corr. Factor (dB)	Reading Value		Emission Level		Limit		Margin	
			[dB (uV)]		[dB (uV)]		[dB (uV)]		(dB)	
			Q.P.	AV.	Q.P.	AV.	Q.P.	AV.	Q.P.	AV.
1	0.166	0.10	40.79	-	40.89	-	65.18	55.18	-24.28	-
2	0.205	0.11	46.11	-	46.22	-	63.42	53.42	-17.20	-
3	0.276	0.11	38.47	-	38.58	-	60.94	50.94	-22.36	-
4	0.341	0.11	32.61	-	32.72	-	59.17	49.17	-26.44	-
5	3.719	0.19	27.96	-	28.15	-	56.00	46.00	-27.85	-
6	14.934	0.64	25.20	-	25.84	-	60.00	50.00	-34.16	-

- REMARKS:**
1. Q.P. and AV. are abbreviations of quasi-peak and average individually.
 2. "-": The Quasi-peak reading value also meets average limit and measurement with the average detector is unnecessary.
 3. The emission levels of other frequencies were very low against the limit.
 4. Margin value = Emission level - Limit value
 5. Correction factor = Insertion loss + Cable loss
 6. Emission Level = Correction Factor + Reading Value.

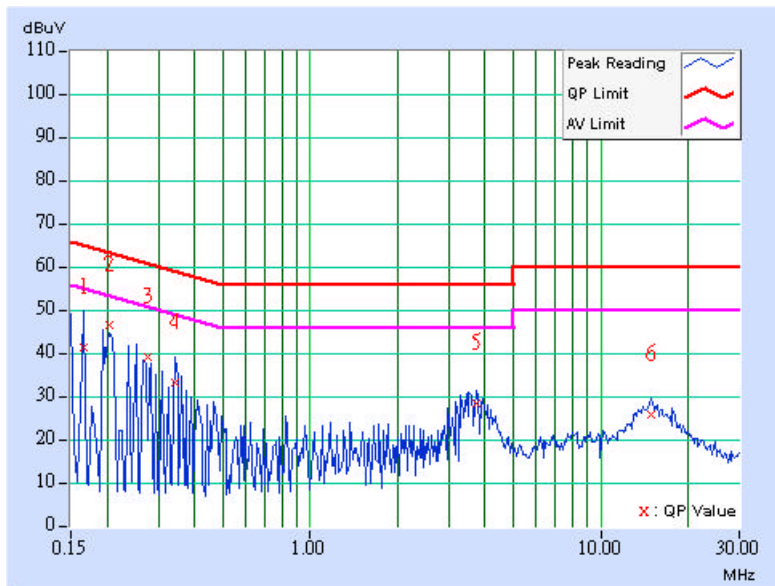



EUT	Notebook	MODEL	557S
CHANNEL	11	6dB BANDWIDTH	9 kHz
INPUT POWER (SYSTEM)	120 Vac, 60 Hz	PHASE	Line (L)
ENVIRONMENTAL CONDITIONS	23deg. C, 65% RH, 991 hPa	TESTED BY	Gary Chang

No	Freq. [MHz]	Corr. Factor (dB)	Reading Value		Emission Level		Limit		Margin	
			[dB (uV)]		[dB (uV)]		[dB (uV)]		(dB)	
			Q.P.	AV.	Q.P.	AV.	Q.P.	AV.	Q.P.	AV.
1	0.158	0.11	41.27	-	41.38	-	65.58	55.58	-24.20	-
2	0.205	0.12	45.53	-	45.65	-	63.42	53.42	-17.77	-
3	0.275	0.12	37.99	-	38.11	-	60.97	50.97	-22.85	-
4	0.416	0.13	27.04	-	27.17	-	57.54	47.54	-30.37	-
5	3.852	0.20	28.20	-	28.40	-	56.00	46.00	-27.60	-
6	14.934	0.77	25.20	-	25.97	-	60.00	50.00	-34.03	-

- REMARKS:**
1. Q.P. and AV. are abbreviations of quasi-peak and average individually.
 2. "-": The Quasi-peak reading value also meets average limit and measurement with the average detector is unnecessary.
 3. The emission levels of other frequencies were very low against the limit.
 4. Margin value = Emission level - Limit value
 5. Correction factor = Insertion loss + Cable loss
 6. Emission Level = Correction Factor + Reading Value.

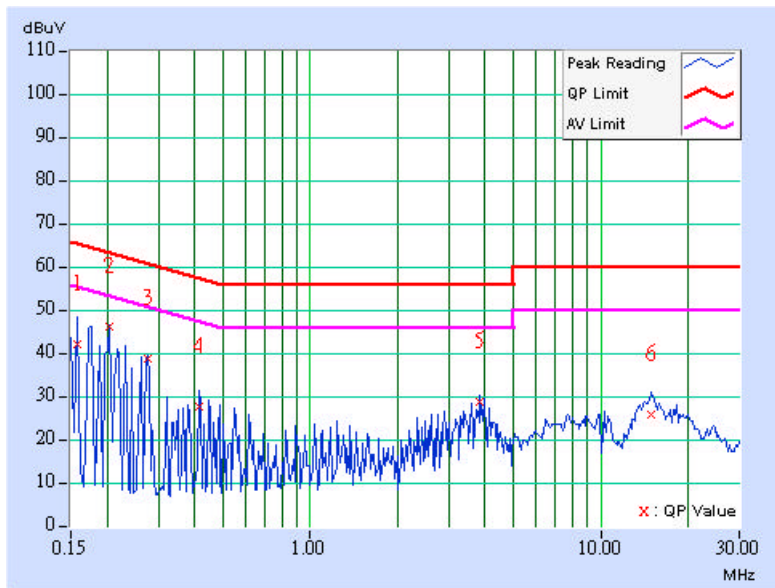



EUT	Notebook	MODEL	557S
CHANNEL	11	6dB BANDWIDTH	9 kHz
INPUT POWER (SYSTEM)	120 Vac, 60 Hz	PHASE	Netural (N)
ENVIRONMENTAL CONDITIONS	23deg. C, 65% RH, 991 hPa	TESTED BY	Gary Chang

No	Freq. [MHz]	Corr. Factor (dB)	Reading Value		Emission Level		Limit		Margin	
			[dB (uV)]		[dB (uV)]		[dB (uV)]		(dB)	
			Q.P.	AV.	Q.P.	AV.	Q.P.	AV.	Q.P.	AV.
1	0.154	0.10	42.72	-	42.82	-	65.79	55.79	-22.97	-
2	0.209	0.11	45.59	-	45.70	-	63.26	53.26	-17.56	-
3	0.271	0.11	35.07	-	35.18	-	61.08	51.08	-25.90	-
4	0.345	0.11	33.24	-	33.35	-	59.07	49.07	-25.72	-
5	3.512	0.19	27.17	-	27.36	-	56.00	46.00	-28.64	-
6	14.793	0.63	25.09	-	25.72	-	60.00	50.00	-34.28	-

- REMARKS:**
1. Q.P. and AV. are abbreviations of quasi-peak and average individually.
 2. "-": The Quasi-peak reading value also meets average limit and measurement with the average detector is unnecessary.
 3. The emission levels of other frequencies were very low against the limit.
 4. Margin value = Emission level - Limit value
 5. Correction factor = Insertion loss + Cable loss
 6. Emission Level = Correction Factor + Reading Value.

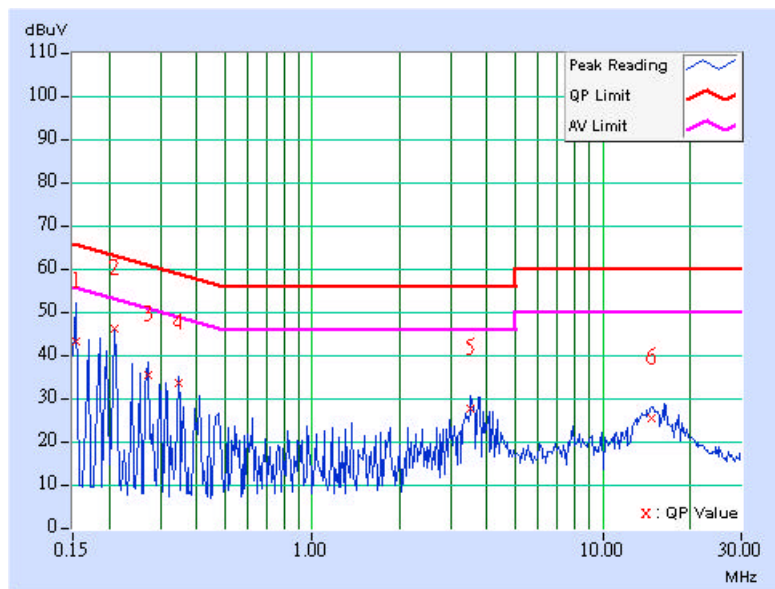



4.2 RADIATED EMISSION MEASUREMENT

4.2.1 LIMITS OF RADIATED EMISSION MEASUREMENT

Emissions radiated outside of the specified bands, shall be according to the general radiated limits in 15.209 as following:

Frequencies (MHz)	Field strength (microvolts/meter)	Measurement distance (meters)
0.009-0.490	2400/F(kHz)	300
0.490-1.705	24000/F(kHz)	30
1.705-30.0	30	30
30-88	100	3
88-216	150	3
216-960	200	3
Above 960	500	3

NOTE:

1. The lower limit shall apply at the transition frequencies.
2. Emission level (dBuV/m) = 20 log Emission level (uV/m).
3. As shown in 15.35(b), for frequencies above 1000MHz, the field strength limits are based on average detector, however, the peak field strength of any emission shall not exceed the maximum permitted average limits, specified above by more than 20dB under any condition of modulation.



4.2.2 TEST INSTRUMENTS

DESCRIPTION & MANUFACTURER	MODEL NO.	SERIAL NO.	CALIBRATED UNTIL
Test Receiver ROHDE & SCHWARZ	ESI7	838496/016	Feb. 09, 2005
Spectrum Analyzer ROHDE & SCHWARZ	FSP40	100041	Dec. 15, 2004
BILOG Antenna SCHWARZBECK	VULB9168	9168-155	Feb. 03, 2005
HORN Antenna SCHWARZBECK	BBHA 9120D	9120D-404	Feb. 03, 2005
HORN Antenna SCHWARZBECK	BBHA 9170	BBHA 9170242	Feb. 23, 2005
Preamplifier Agilent	8447D	2944A10631	Jan. 15, 2005
Preamplifier Agilent	8449B	3008A01960	Jan. 22, 2005
RF signal cable HUBER+SUHNNER	SUCOFLEX 104	219272/4	Mar. 04, 2005
RF signal cable HUBER+SUHNNER	SUCOFLEX 104	219275/4	Mar. 04, 2005
Software ADT.	ADT_Radiated_V5.14	NA	NA
Antenna Tower inn-co GmbH	MA 4000	010303	NA
Antenna Tower Controller inn-co GmbH	CO2000	019303	NA
Turn Table ADT.	TT100.	TT93021704	NA
Turn Table Controller ADT.	SC100.	SC93021704	NA

- NOTE:**
1. The calibration interval of the above test instruments is 12 months and the calibrations are traceable to NML/ROC and NIST/USA.
 2. The test was performed in HwaYa Chamber 3.
 3. The horn antenna and HP preamplifier (model: 8449B) are used only for the measurement of emission frequency above 1GHz if tested.
 4. The IC Site Registration No. is IC4924-4.



4.2.3 TEST PROCEDURES

- a. The EUT was placed on the top of a rotating table 0.8 meters above the ground at a 3 meter semi-anechoic chamber. The table was rotated 360 degrees to determine the position of the highest radiation.
- b. The EUT was set 3 meters away from the interference-receiving antenna, which was mounted on the top of a variable-height antenna tower.
- c. The antenna is a broadband antenna, and its height is varied from one meter to four meters above the ground to determine the maximum value of the field strength. Both horizontal and vertical polarizations of the antenna are set to make the measurement.
- d. For each suspected emission, the EUT was arranged to its worst case and then the antenna was tuned to heights from 1 meter to 4 meters and the rotatable table was turned from 0 degrees to 360 degrees to find the maximum reading.
- e. The test-receiver system was set to Peak Detect Function and Specified Bandwidth with Maximum Hold Mode.
- f. If the emission level of the EUT in peak mode was 10 dB lower than the limit specified, then testing could be stopped and the peak values of the EUT would be reported. Otherwise the emissions that did not have 10 dB margin would be re-tested one by one using peak, quasi-peak or average method as specified and then reported in a data sheet.

NOTE:

1. The resolution bandwidth and video bandwidth of test receiver/spectrum analyzer is 120kHz for Peak detection (PK) and Quasi-peak detection (QP) at frequency below 1GHz.
2. The resolution bandwidth and video bandwidth of test receiver/spectrum analyzer is 1 MHz for Peak detection at frequency above 1GHz.
3. The resolution bandwidth of test receiver/spectrum analyzer is 1 MHz and the video bandwidth is 10 Hz for Average detection (AV) at frequency above 1GHz.

4.2.4 DEVIATION FROM TEST STANDARD

No deviation

4.2.5 TEST SETUP

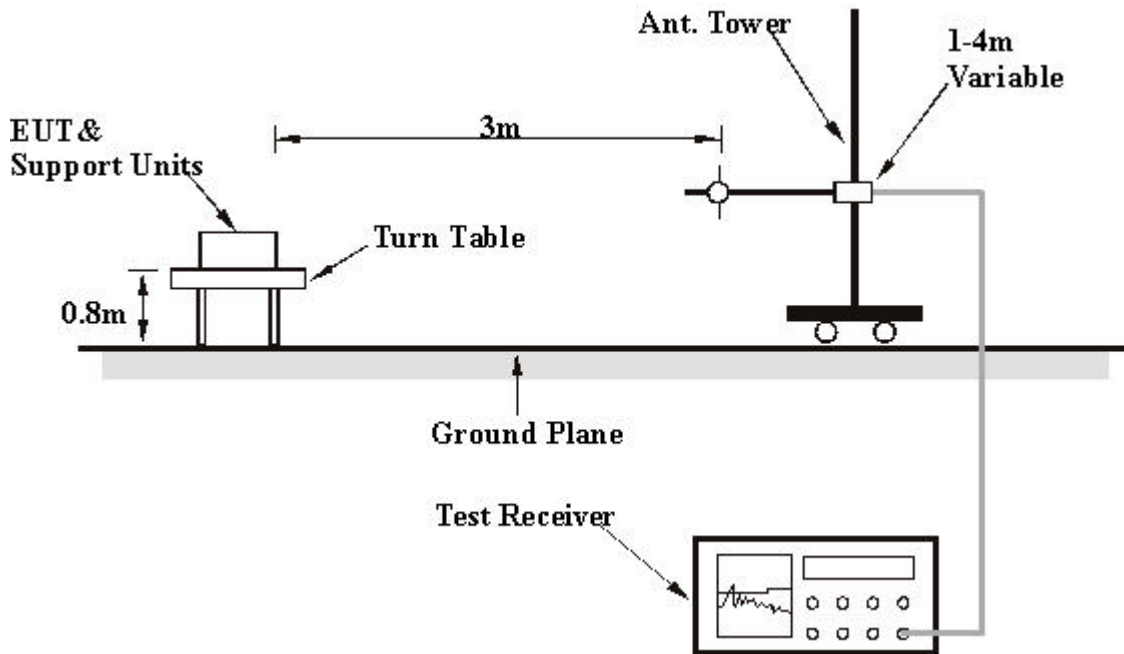

For the actual test configuration, please refer to the related item – Photographs of the Test Configuration.

4.2.6 EUT OPERATING CONDITIONS

Same as 4.1.6

4.2.7 TEST RESULTS

EUT	Notebook	MODEL	557S
CHANNEL	11	FREQUENCY RANGE	Below 1000 MHz
INPUT POWER (SYSTEM)	120 Vac, 60Hz	DETECTOR FUNCTION	Quasi-Peak
ENVIRONMENTAL CONDITIONS	25 deg. C, 65% RH, 991 hPa	TESTED BY	Rush Kao

ANTENNA POLARITY & TEST DISTANCE: HORIZONTAL AT 3 M								
No.	Freq. (MHz)	Emission Level (dBuV/m)	Limit (dBuV/m)	Margin (dB)	Antenna Height (m)	Table Angle (Degree)	Raw Value (dBuV)	Correction Factor (dB/m)
1	195.23	34.47 QP	43.50	-9.03	2.00 H	52	22.81	11.66
2	325.47	36.78 QP	46.00	-9.22	1.25 H	199	21.81	14.98
3	675.37	37.76 QP	46.00	-8.24	1.25 H	223	16.02	21.74
4	725.91	34.60 QP	46.00	-11.40	1.25 H	145	11.95	22.65
5	782.28	34.95 QP	46.00	-11.05	2.00 H	103	11.57	23.38
6	900.86	36.04 QP	46.00	-9.96	1.75 H	16	11.22	24.82

- REMARKS:**
1. Emission level(dBuV/m)=Raw Value(dBuV) + Correction Factor(dB/m)
 2. Correction Factor(dB/m) = Antenna Factor (dB/m) + Cable Factor (dB)
 3. The other emission levels were very low against the limit.
 4. Margin value = Emission level – Limit value.



EUT	Notebook	MODEL	557S
CHANNEL	11	FREQUENCY RANGE	Below 1000 MHz
INPUT POWER (SYSTEM)	120 Vac, 60Hz	DETECTOR FUNCTION	Quasi-Peak
ENVIRONMENTAL CONDITIONS	25 deg. C, 65% RH, 991 hPa	TESTED BY	Rush Kao

ANTENNA POLARITY & TEST DISTANCE: VERTICAL AT 3 M

No.	Freq. (MHz)	Emission Level (dBuV/m)	Limit (dBuV/m)	Margin (dB)	Antenna Height (m)	Table Angle (Degree)	Raw Value (dBuV)	Correction Factor (dB/m)
1	195.23	33.85 QP	43.50	-9.65	1.25 V	133	22.19	11.66
2	325.47	38.89 QP	46.00	-7.11	1.50 V	151	23.92	14.98
3	455.71	36.30 QP	46.00	-9.70	1.00 V	1	18.24	18.07
4	675.37	38.88 QP	46.00	-7.12	1.50 V	202	17.14	21.74
5	716.19	37.84 QP	46.00	-8.16	1.75 V	187	15.43	22.41
6	912.53	39.29 QP	46.00	-6.71	1.00 V	292	14.35	24.94

- REMARKS:**
1. Emission level(dBuV/m)=Raw Value(dBuV) + Correction Factor(dB/m)
 2. Correction Factor(dB/m) = Antenna Factor (dB/m) + Cable Factor (dB)
 3. The other emission levels were very low against the limit.
 4. Margin value = Emission level – Limit value.

4.2.8 TEST RESULTS (A)

EUT	Notebook	MODEL	557S
CHANNEL	1	FREQUENCY RANGE	1~25 GHz
INPUT POWER (SYSTEM)	120 Vac, 60 Hz	DETECTOR FUNCTION	Peak (PK) Average (AV)
ENVIRONMENTAL CONDITIONS	25deg. C, 65% RH, 991 hPa	TESTED BY	Rush Kuo

ANTENNA POLARITY & TEST DISTANCE: HORIZONTAL AT 3 M

No.	Freq. (MHz)	Emission Level (dBuV/m)	Limit (dBuV/m)	Margin (dB)	Antenna Height (m)	Table Angle (Degree)	Raw Value (dBuV)	Correction Factor (dB/m)
1	2038.00	49.42 PK	74.00	-24.58	1.00 H	305	19.50	29.92
1	2038.00	46.01 AV	54.00	-7.99	1.00 H	305	16.09	29.92
2	2390.00	47.35 PK	74.00	-26.65	1.92 H	45	16.21	31.14
2	2390.00	39.74 AV	54.00	-14.26	1.92 H	45	8.60	31.14
3	*2412.00	102.06 PK			1.92 H	45	70.85	31.21
3	*2412.00	94.45 AV			1.92 H	45	63.24	31.21
4	4824.00	56.78 PK	74.00	-17.22	1.02 H	304	18.90	37.88
4	4824.00	44.38 AV	54.00	-9.62	1.02 H	304	6.50	37.88

ANTENNA POLARITY & TEST DISTANCE: VERTICAL AT 3 M

No.	Freq. (MHz)	Emission Level (dBuV/m)	Limit (dBuV/m)	Margin (dB)	Antenna Height (m)	Table Angle (Degree)	Raw Value (dBuV)	Correction Factor (dB/m)
1	2038.00	53.45 PK	74.00	-20.55	1.05 V	61	23.53	29.92
1	2038.00	51.84 AV	54.00	-2.16	1.05 V	61	21.92	29.92
2	2390.00	56.51 PK	74.00	-17.49	1.04 V	355	25.37	31.14
2	2390.00	49.02 AV	54.00	-4.98	1.04 V	355	17.88	31.14
3	*2412.00	111.22 PK			1.04 V	355	80.01	31.21
3	*2412.00	103.73 AV			1.04 V	355	72.52	31.21
4	4824.00	61.96 PK	74.00	-12.04	1.02 V	353	24.08	37.88
4	4824.00	49.23 AV	54.00	-4.77	1.02 V	353	11.35	37.88

- REMARKS:**
1. Emission level(dBuV/m)=Raw Value(dBuV) + Correction Factor(dB/m)
 2. Correction Factor(dB/m) = Antenna Factor (dB/m) + Cable Factor (dB)
 3. The other emission levels were very low against the limit.
 4. Margin value = Emission level – Limit value.
 5. “ * ” : Fundamental frequency.



EUT	Notebook	MODEL	557S
CHANNEL	6	FREQUENCY RANGE	1~25 GHz
INPUT POWER (SYSTEM)	120 Vac, 60 Hz	DETECTOR FUNCTION	Peak(PK) Average (AV)
ENVIRONMENTAL CONDITIONS	25deg. C, 65% RH, 991 hPa	TESTED BY	Rush Kuo

ANTENNA POLARITY & TEST DISTANCE: HORIZONTAL AT 3 M

No.	Freq. (MHz)	Emission Level (dBuV/m)	Limit (dBuV/m)	Margin (dB)	Antenna Height (m)	Table Angle (Degree)	Raw Value (dBuV)	Correction Factor (dB/m)
1	2063.00	47.39 PK	74.00	-26.61	1.00 H	15	17.37	30.02
1	2063.00	44.07 AV	54.00	-9.93	1.00 H	15	14.05	30.02
2	*2437.00	101.84 PK			1.96 H	47	70.50	31.34
2	*2437.00	94.48 AV			1.96 H	47	63.15	31.34
3	4874.00	53.67 PK	74.00	-20.33	1.00 H	301	15.68	37.99
3	4874.00	40.86 AV	54.00	-13.14	1.00 H	301	2.87	37.99

ANTENNA POLARITY & TEST DISTANCE: VERTICAL AT 3 M

No.	Freq. (MHz)	Emission Level (dBuV/m)	Limit (dBuV/m)	Margin (dB)	Antenna Height (m)	Table Angle (Degree)	Raw Value (dBuV)	Correction Factor (dB/m)
1	2063.00	53.18 PK	74.00	-20.82	1.04 V	66	23.16	30.02
1	2063.00	52.57 AV	54.00	-1.43	1.04 V	66	22.55	30.02
2	*2437.00	110.21 PK			1.02 V	351	78.87	31.34
2	*2437.00	102.89 AV			1.02 V	351	71.56	31.34
3	4874.00	58.68 PK	74.00	-15.32	1.04 V	352	20.69	37.99
3	4874.00	45.89 AV	54.00	-8.11	1.04 V	352	7.90	37.99

- REMARKS:**
1. Emission level(dBuV/m)=Raw Value(dBuV) + Correction Factor(dB/m)
 2. Correction Factor(dB/m) = Antenna Factor (dB/m) + Cable Factor (dB)
 3. The other emission levels were very low against the limit.
 4. Margin value = Emission level – Limit value.
 5. " * " : Fundamental frequency.



EUT	Notebook	MODEL	557S
CHANNEL	11	FREQUENCY RANGE	1~25 GHz
INPUT POWER (SYSTEM)	120 Vac, 60 Hz	DETECTOR FUNCTION	Peak(PK) Average (AV)
ENVIRONMENTAL CONDITIONS	25deg. C, 65% RH, 991 hPa	TESTED BY	Rush Kuo

ANTENNA POLARITY & TEST DISTANCE: HORIZONTAL AT 3 M

No.	Freq. (MHz)	Emission Level (dBuV/m)	Limit (dBuV/m)	Margin (dB)	Antenna Height (m)	Table Angle (Degree)	Raw Value (dBuV)	Correction Factor (dB/m)
1	2088.00	46.58 PK	74.00	-27.42	1.23 H	351	16.45	30.13
1	2088.00	42.37 AV	54.00	-11.63	1.23 H	351	12.24	30.13
2	*2462.00	103.49 PK			1.27 H	81	72.03	31.46
2	*2462.00	96.23 AV			1.27 H	81	64.77	31.46
3	2483.50	48.35 PK	74.00	-25.65	1.27 H	81	16.78	31.57
3	2483.50	41.09 AV	54.00	-12.91	1.27 H	81	9.52	31.57
4	2543.00	45.43 PK	74.00	-28.57	1.18 H	277	13.63	31.80
4	2543.00	34.80 AV	54.00	-19.20	1.18 H	277	3.00	31.80
5	4924.00	51.59 PK	74.00	-22.41	1.00 H	145	13.48	38.11
5	4924.00	39.21 AV	54.00	-14.79	1.00 H	145	1.10	38.11

ANTENNA POLARITY & TEST DISTANCE: VERTICAL AT 3 M

No.	Freq. (MHz)	Emission Level (dBuV/m)	Limit (dBuV/m)	Margin (dB)	Antenna Height (m)	Table Angle (Degree)	Raw Value (dBuV)	Correction Factor (dB/m)
1	2088.00	53.14 PK	74.00	-20.86	1.00 V	37	23.01	30.13
1	2088.00	51.95 AV	54.00	-2.05	1.00 V	37	21.82	30.13
2	*2462.00	111.28 PK			1.01 V	352	79.82	31.46
2	*2462.00	103.67 AV			1.01 V	352	72.21	31.46
3	2483.50	56.14 PK	74.00	-17.86	1.01 V	352	24.57	31.57
3	2483.50	48.53 AV	54.00	-5.47	1.01 V	352	16.96	31.57
4	2543.00	50.59 PK	74.00	-23.41	1.00 V	348	18.79	31.80
4	2543.00	44.62 AV	54.00	-9.38	1.00 V	348	12.82	31.80
5	4924.00	56.90 PK	74.00	-17.10	1.02 V	352	18.79	38.11
5	4924.00	44.36 AV	54.00	-9.64	1.02 V	352	6.25	38.11

- REMARKS:**
1. Emission level(dBuV/m)=Raw Value(dBuV) + Correction Factor(dB/m)
 2. Correction Factor(dB/m) = Antenna Factor (dB/m) + Cable Factor (dB)
 3. The other emission levels were very low against the limit.
 4. Margin value = Emission level – Limit value.
 5. “ * “ : Fundamental frequency.



4.2.9 TEST RESULTS (B)

EUT	Notebook	MODEL	557S
CHANNEL	1	FREQUENCY RANGE	1~25 GHz
INPUT POWER (SYSTEM)	120 Vac, 60 Hz	DETECTOR FUNCTION	Peak(PK) Average (AV)
ENVIRONMENTAL CONDITIONS	25deg. C, 65% RH, 991 hPa	TESTED BY	Rush Kuo

ANTENNA POLARITY & TEST DISTANCE: HORIZONTAL AT 3 M

No.	Freq. (MHz)	Emission Level (dBuV/m)	Limit (dBuV/m)	Margin (dB)	Antenna Height (m)	Table Angle (Degree)	Raw Value (dBuV)	Correction Factor (dB/m)
1	2038.00	54.28 PK	74.00	-19.72	1.05 H	34	24.36	29.92
1	2038.00	52.49 AV	54.00	-1.51	1.05 H	34	22.57	29.92
2	2390.00	35.11 PK	74.00	-38.89	1.05 H	352	3.97	31.14
2	2390.00	26.24 AV	54.00	-27.76	1.05 H	352	-4.90	31.14
3	*2412.00	93.57 PK			1.05 H	352	62.36	31.21
3	*2412.00	84.70 AV			1.05 H	352	53.49	31.21
4	4824.00	52.27 PK	74.00	-21.73	1.02 H	34	14.39	37.88
4	4824.00	39.64 AV	54.00	-14.36	1.02 H	34	1.76	37.88

ANTENNA POLARITY & TEST DISTANCE: VERTICAL AT 3 M

No.	Freq. (MHz)	Emission Level (dBuV/m)	Limit (dBuV/m)	Margin (dB)	Antenna Height (m)	Table Angle (Degree)	Raw Value (dBuV)	Correction Factor (dB/m)
1	2038.00	49.70 PK	74.00	-24.30	1.21 V	192	19.78	29.92
1	2038.00	46.32 AV	54.00	-7.68	1.21 V	192	16.40	29.92
2	2390.00	45.03 PK	74.00	-28.97	1.53 V	299	13.89	31.14
2	2390.00	43.77 AV	54.00	-16.23	1.53 V	299	6.63	31.14
3	*2412.00	103.49 PK			1.27 V	81	72.28	31.21
3	*2412.00	96.23 AV			1.27 V	81	65.02	31.21
4	4824.00	51.80 PK	74.00	-22.20	1.14 V	60	13.92	37.88
4	4824.00	39.05 AV	54.00	-14.95	1.14 V	60	1.17	37.88

- REMARKS:**
1. Emission level(dBuV/m)=Raw Value(dBuV) + Correction Factor(dB/m)
 2. Correction Factor(dB/m) = Antenna Factor (dB/m) + Cable Factor (dB)
 3. The other emission levels were very low against the limit.
 4. Margin value = Emission level – Limit value.
 5. “ * ” : Fundamental frequency.



EUT	Notebook	MODEL	557S
CHANNEL	6	FREQUENCY RANGE	1~25 GHz
INPUT POWER (SYSTEM)	120 Vac, 60 Hz	DETECTOR FUNCTION	Peak(PK) Average (AV)
ENVIRONMENTAL CONDITIONS	25deg. C, 65% RH, 991 hPa	TESTED BY	Rush Kuo

ANTENNA POLARITY & TEST DISTANCE: HORIZONTAL AT 3 M

No.	Freq. (MHz)	Emission Level (dBuV/m)	Limit (dBuV/m)	Margin (dB)	Antenna Height (m)	Table Angle (Degree)	Raw Value (dBuV)	Correction Factor (dB/m)
1	2063.00	48.84 PK	74.00	-25.16	1.55 H	56	18.82	30.02
1	2063.00	44.75 AV	54.00	-9.25	1.55 H	56	14.73	30.02
2	*2437.00	93.36 PK			1.08 H	53	62.02	31.34
2	*2437.00	84.64 AV			1.08 H	53	53.30	31.34
3	4874.00	51.07 PK	74.00	-22.93	1.15 H	64	13.08	37.99
3	4874.00	38.72 AV	54.00	-15.28	1.15 H	64	0.73	37.99

ANTENNA POLARITY & TEST DISTANCE: VERTICAL AT 3 M

No.	Freq. (MHz)	Emission Level (dBuV/m)	Limit (dBuV/m)	Margin (dB)	Antenna Height (m)	Table Angle (Degree)	Raw Value (dBuV)	Correction Factor (dB/m)
1	2063.00	55.26 PK	74.00	-18.74	1.03 V	60	25.24	30.02
1	2063.00	53.48 AV	54.00	-0.52	1.03 V	60	23.46	30.02
2	*2437.00	101.25 PK			1.05 V	350	69.91	31.34
2	*2437.00	92.62 AV			1.05 V	350	61.29	31.34
3	4874.00	51.63 PK	74.00	-22.37	1.03 V	44	13.64	37.99
3	4874.00	39.02 AV	54.00	-14.98	1.03 V	44	1.03	37.99

- REMARKS:**
1. Emission level(dBuV/m)=Raw Value(dBuV) + Correction Factor(dB/m)
 2. Correction Factor(dB/m) = Antenna Factor (dB/m) + Cable Factor (dB)
 3. The other emission levels were very low against the limit.
 4. Margin value = Emission level – Limit value.
 5. “ * ” : Fundamental frequency.



EUT	Notebook	MODEL	557S
CHANNEL	11	FREQUENCY RANGE	1~25 GHz
INPUT POWER (SYSTEM)	120 Vac, 60 Hz	DETECTOR FUNCTION	Peak(PK) Average (AV)
ENVIRONMENTAL CONDITIONS	25deg. C, 65% RH, 991 hPa	TESTED BY	Rush Kuo

ANTENNA POLARITY & TEST DISTANCE: HORIZONTAL AT 3 M

No.	Freq. (MHz)	Emission Level (dBuV/m)	Limit (dBuV/m)	Margin (dB)	Antenna Height (m)	Table Angle (Degree)	Raw Value (dBuV)	Correction Factor (dB/m)
1	1172.00	43.24 PK	74.00	-30.76	1.28 H	5	14.97	28.27
1	1172.00	30.75 AV	54.00	-23.25	1.28 H	5	2.48	28.27
2	2088.00	47.23 PK	74.00	-26.77	1.06 H	208	17.10	30.13
2	2088.00	43.00 AV	54.00	-11.00	1.06 H	208	12.87	30.13
3	*2462.00	93.68 PK			1.84 H	20	62.22	31.46
3	*2462.00	84.89 AV			1.84 H	20	53.43	31.46
4	2483.50	42.71 PK	74.00	-31.29	1.84 H	20	11.14	31.57
4	2483.50	30.92 AV	54.00	-23.08	1.84 H	20	-0.65	31.57
5	2544.00	45.70 PK	74.00	-28.30	1.82 H	26	13.90	31.80
5	2544.00	37.30 AV	54.00	-16.70	1.82 H	26	5.50	31.80
6	4924.00	52.10 PK	74.00	-21.90	1.10 H	34	13.99	38.11
6	4924.00	38.85 AV	54.00	-15.15	1.10 H	34	0.74	38.11

ANTENNA POLARITY & TEST DISTANCE: VERTICAL AT 3 M

No.	Freq. (MHz)	Emission Level (dBuV/m)	Limit (dBuV/m)	Margin (dB)	Antenna Height (m)	Table Angle (Degree)	Raw Value (dBuV)	Correction Factor (dB/m)
1	1172.00	46.07 PK	74.00	-27.93	1.00 V	208	17.80	28.27
1	1172.00	36.46 AV	54.00	-17.54	1.00 V	208	8.19	28.27
2	2088.00	53.13 PK	74.00	-20.87	1.00 V	35	23.00	30.13
2	2088.00	50.85 AV	54.00	-3.15	1.00 V	35	20.72	30.13
3	*2462.00	103.42 PK			1.02 V	348	71.96	31.46
3	*2462.00	96.12 AV			1.02 V	348	64.66	31.46
4	2483.50	47.03 PK	74.00	-26.97	1.02 V	348	15.46	31.57
4	2483.50	39.73 AV	54.00	-14.27	1.02 V	348	8.16	31.57
5	2544.00	51.05 PK	74.00	-22.95	1.00 V	346	19.25	31.80
6	4924.00	52.26 PK	74.00	-21.74	1.00 V	23	14.15	38.11
6	4924.00	39.68 AV	54.00	-14.32	1.00 V	23	1.57	38.11

- REMARKS:**
1. Emission level(dBuV/m)=Raw Value(dBuV) + Correction Factor(dB/m)
 2. Correction Factor(dB/m) = Antenna Factor (dB/m) + Cable Factor (dB)
 3. The other emission levels were very low against the limit.
 4. Margin value = Emission level – Limit value.
 5. " * " : Fundamental frequency.



4.3 6dB BANDWIDTH MEASUREMENT

4.3.1 LIMITS OF 6dB BANDWIDTH MEASUREMENT

The minimum of 6dB Bandwidth Measurement is 0.5 MHz.

4.3.2 TEST INSTRUMENTS

Description & Manufacturer	Model No.	Serial No.	Calibrated Until
SPECTRUM ANALYZER	FSEK30	100049	Aug. 12, 2005

NOTE: The calibration interval of the above test instruments is 12 months and the calibrations are traceable to NML/ROC and NIST/USA.

4.3.3 TEST PROCEDURE

The transmitter output was connected to the spectrum analyzer through an attenuator. The bandwidth of the fundamental frequency was measured by spectrum analyzer with 100 kHz RBW and 100kHz VBW. The 6dB bandwidth is defined as the total spectrum the power of which is higher than peak power minus 6dB.

4.3.4 DEVIATION FROM TEST STANDARD

No deviation

4.3.5 TEST SETUP

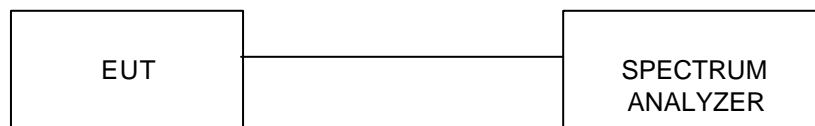

For the actual test configuration, please refer to the related Item – Photographs of the Test Configuration.

4.3.6 EUT OPERATING CONDITIONS

The software provided by client to enable the EUT under transmission condition continuously at lowest, middle and highest channel frequencies individually.



4.3.7 TEST RESULTS (A)

EUT	Notebook	MODEL	557S
INPUT POWER (SYSTEM)	120 Vac, 60 Hz	ENVIRONMENTAL CONDITIONS	23 deg. C, 69% RH, 991 hPa
TESTED BY	Rush Kuo		

CHANNEL	CHANNEL FREQUENCY (MHz)	6dB BANDWIDTH (MHz)	MINIMUM LIMIT (MHz)	PASS/FAIL
1	2412	11.72	0.5	PASS
6	2437	11.88	0.5	PASS
11	2462	11.52	0.5	PASS



CH 1

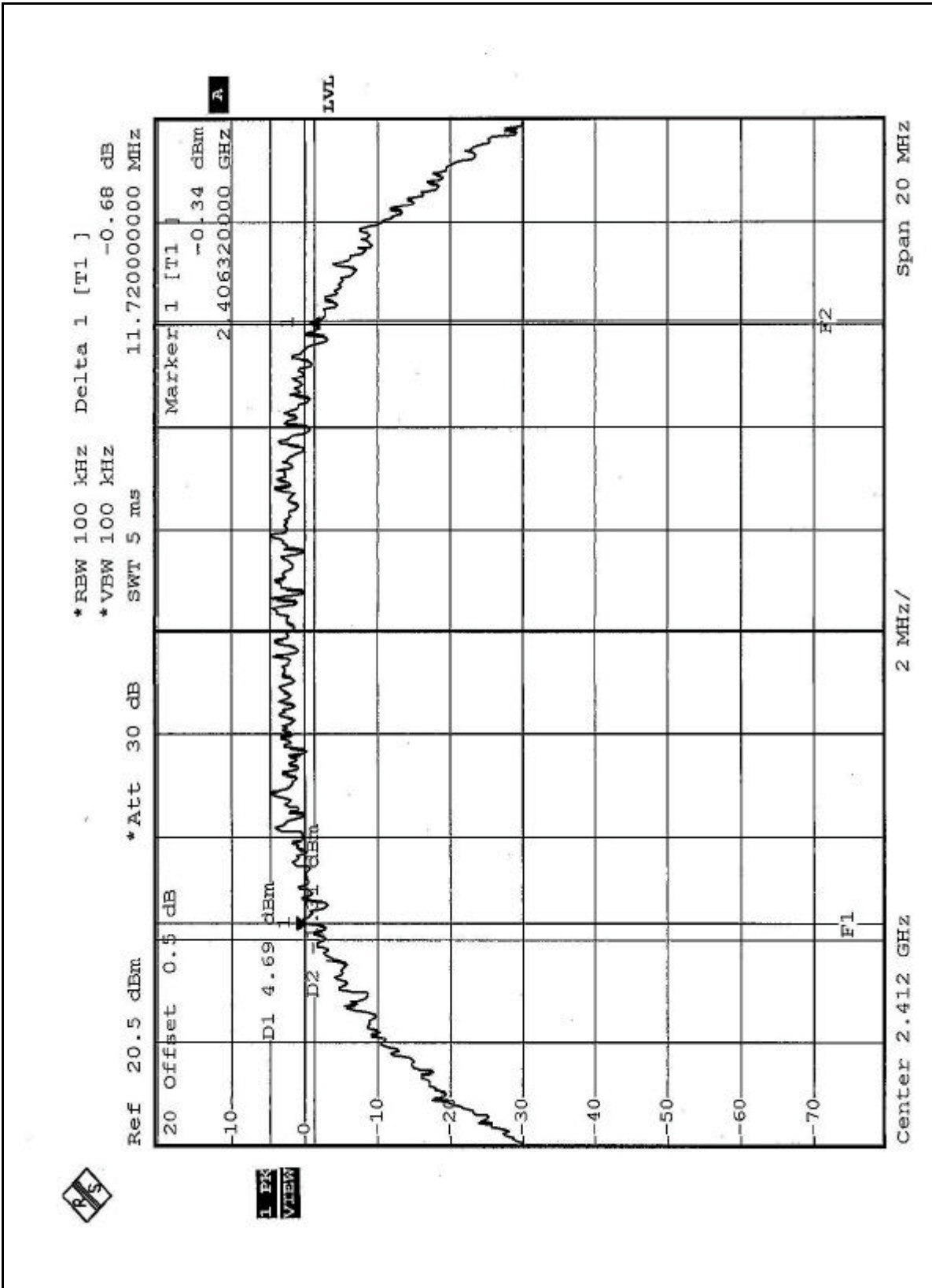



CH 6

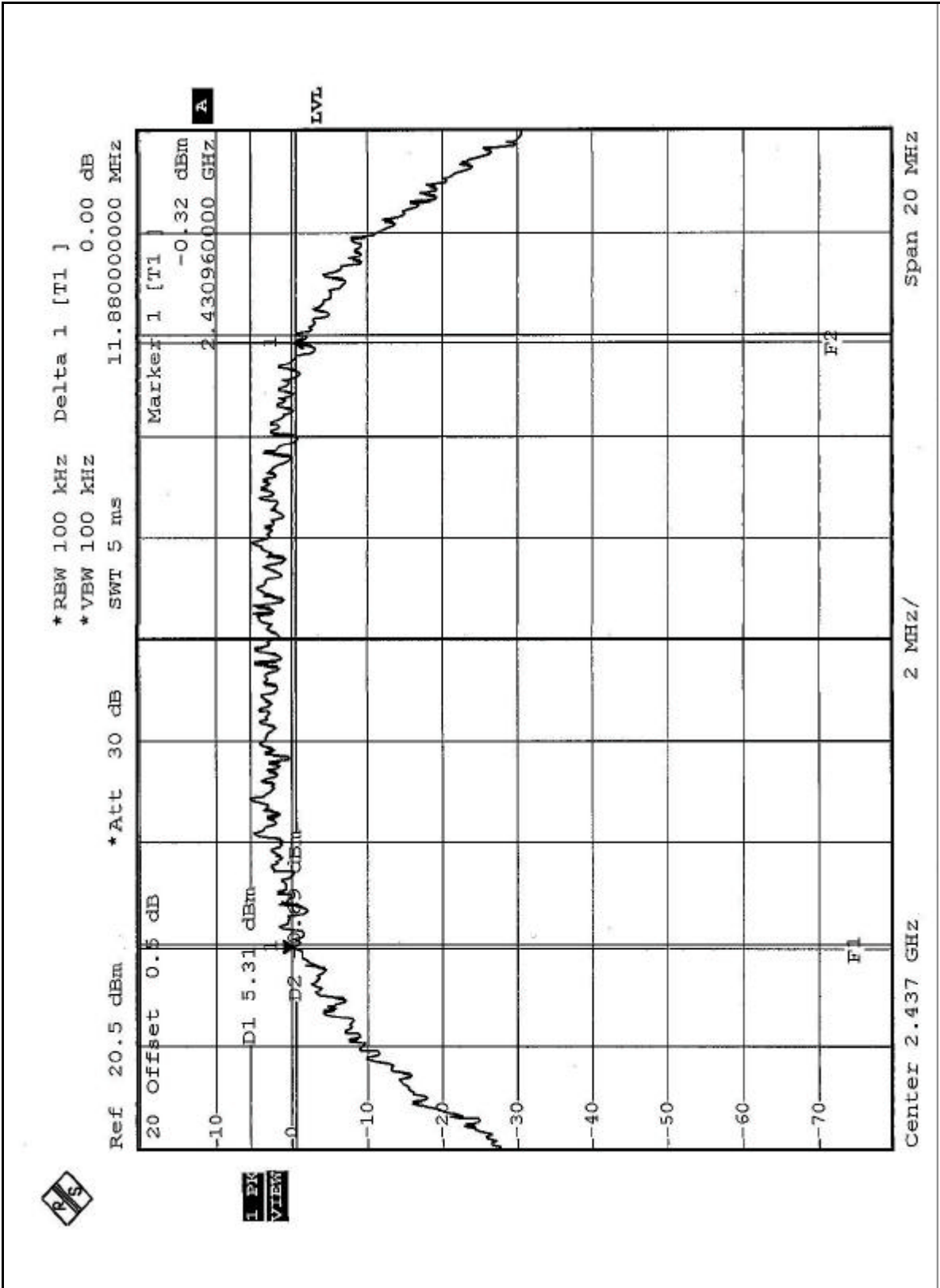



CH 11

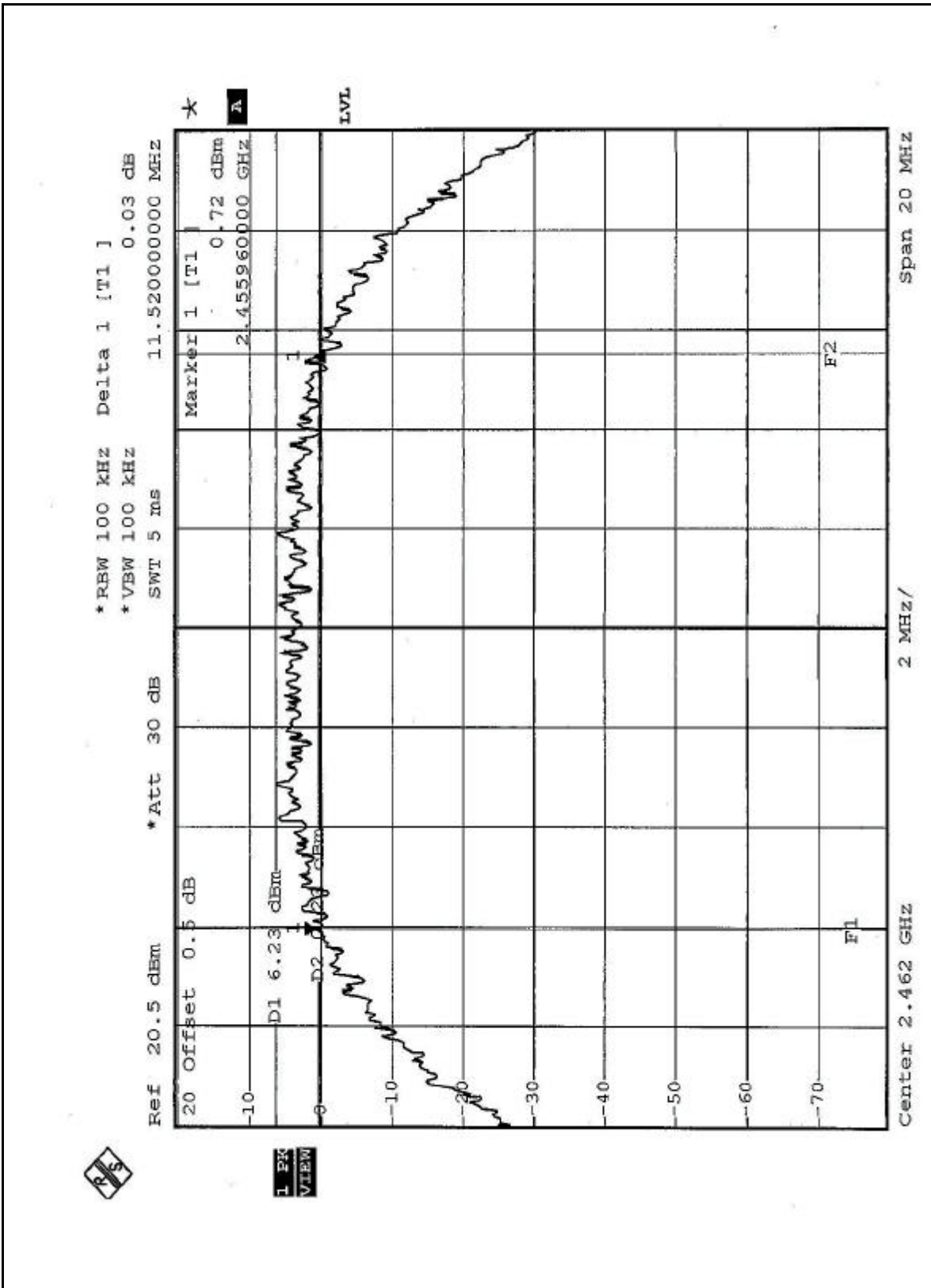



4.3.8 TEST RESULTS (B)

EUT	Notebook	MODEL	557S
INPUT POWER (SYSTEM)	120 Vac, 60 Hz	ENVIRONMENTAL CONDITIONS	23 deg. C, 69% RH, 991 hPa
TESTED BY	Rush Kuo		

CHANNEL	CHANNEL FREQUENCY (MHz)	6 dB BANDWIDTH (MHz)	MINIMUM LIMIT (MHz)	PASS/FAIL
1	2412	16.52	0.5	PASS
6	2437	16.48	0.5	PASS
11	2462	16.52	0.5	PASS



CH 1

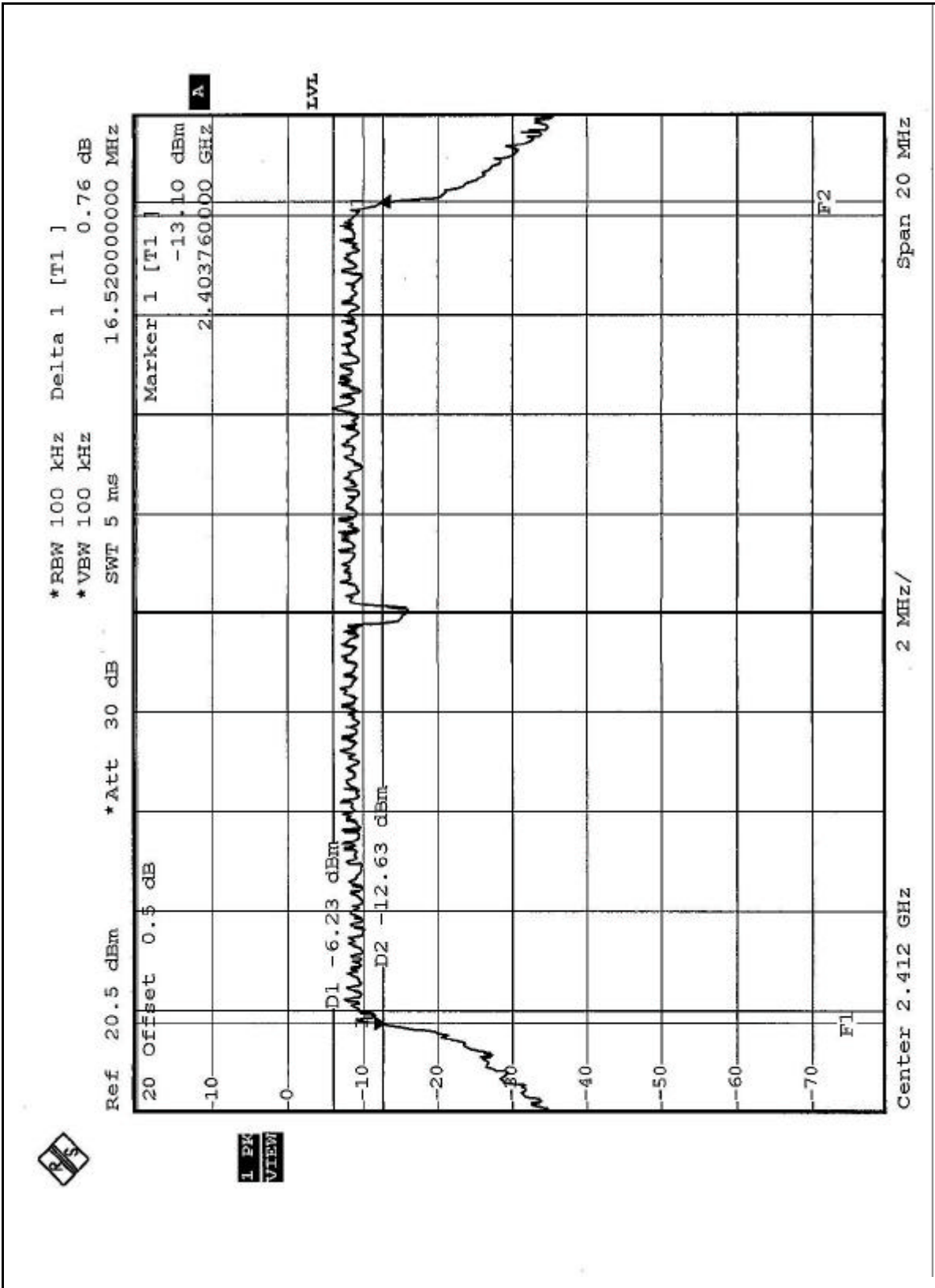



CH 6

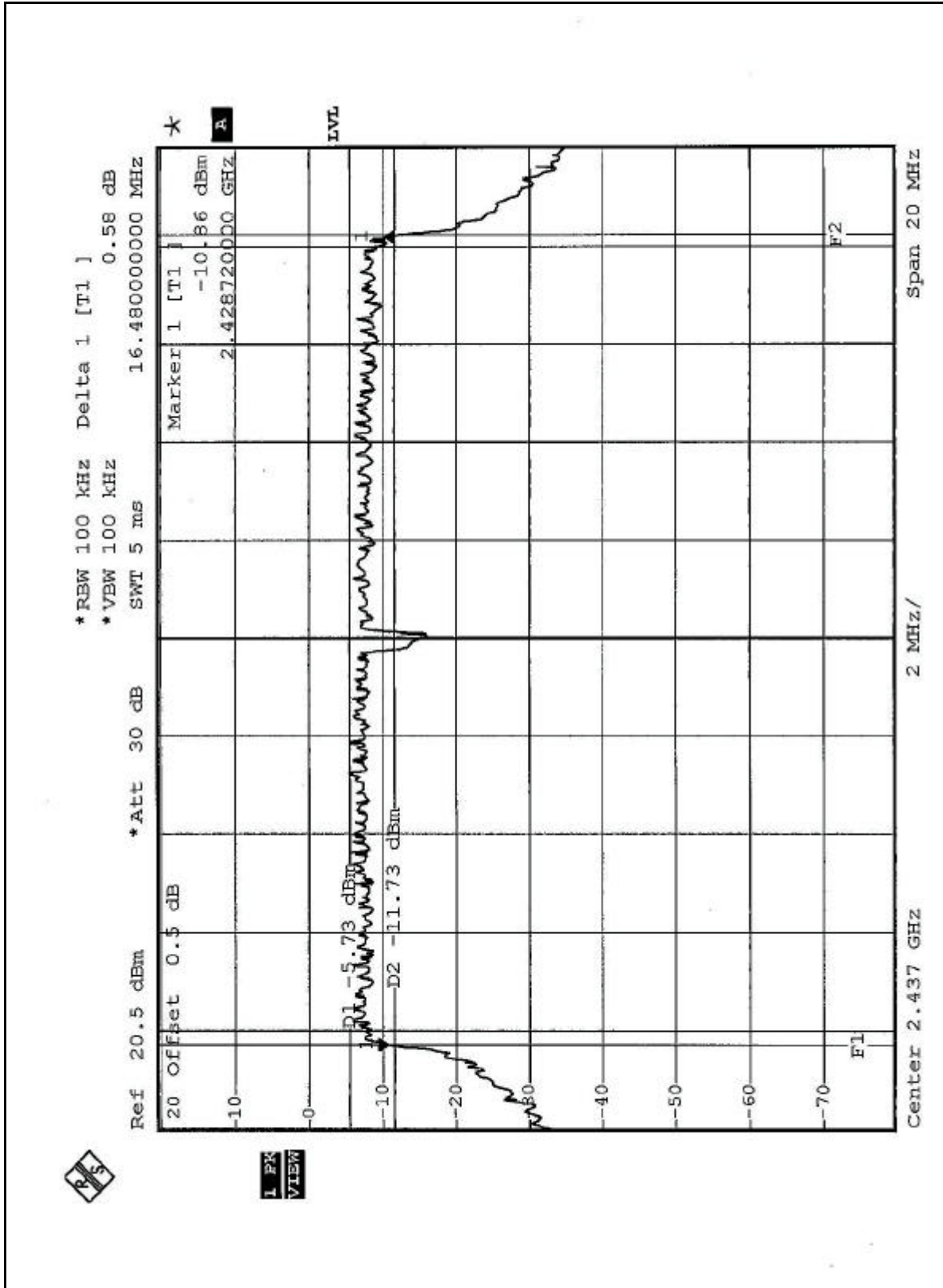



CH 11

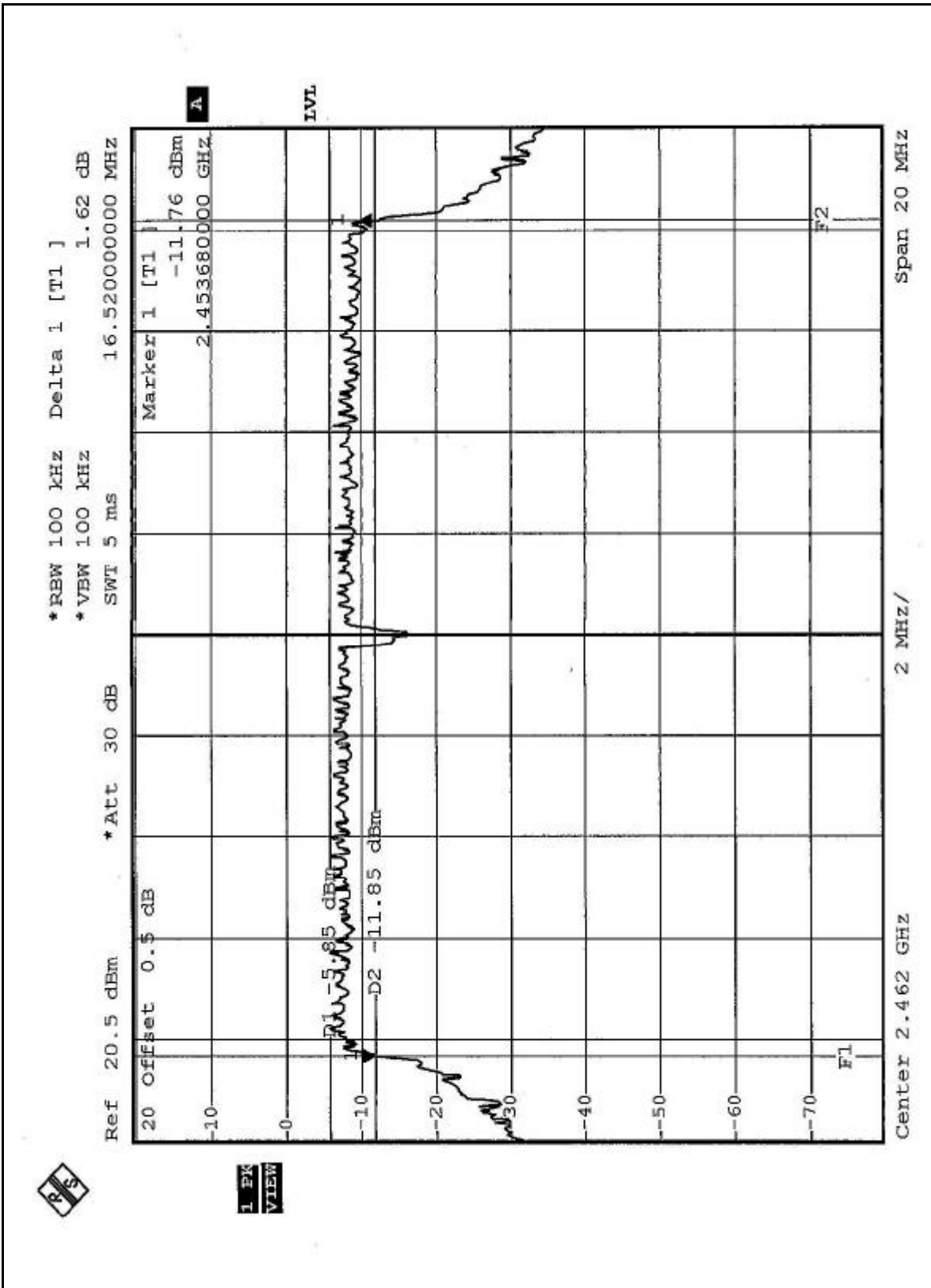

4.4 MAXIMUM PEAK OUTPUT POWER

4.4.1 LIMITS OF MAXIMUM PEAK OUTPUT POWER MEASUREMENT

The Maximum Peak Output Power Measurement is 30dBm.

4.4.2 TEST INSTRUMENTS

Description & Manufacturer	Model No.	Serial No.	Calibrated Until
R&S SPECTRUM ANALYZER	FSEK30	100049	Aug. 12, 2005
AGILENT SIGNAL GENERATOR	E8257C	MY43320668	Dec. 31, 2004
TEKTRONIX OSCILLOSCOPE	TDS 220	C019167	Feb. 1, 2005
NARDA DETECTOR	4503A	FSCM99899	NA

NOTE:

The calibration interval of the above test instruments is 12 months and the calibrations are traceable to NML/ROC and NIST/USA.



4.4.3 TEST PROCEDURES

1. A detector was used on the output port of the EUT. An oscilloscope was used to peak the response of the detector.
2. Replaced the EUT by the signal generator. The center frequency of the S.G was adjusted to the center frequency of the measured channel.
3. Adjusted the power to have the same peak reading on oscilloscope. Record the power level.

4.4.4 DEVIATION FROM TEST STANDARD

No deviation

4.4.5 TEST SETUP



4.4.6 EUT OPERATING CONDITIONS

Same as Item 4.3.6



4.4.7 TEST RESULTS (A)

EUT	Notebook	MODEL	557S
INPUT POWER (SYSTEM)	120 Vac, 60 Hz	ENVIRONMENTAL CONDITIONS	23 deg. C, 69% RH, 991 hPa
TESTED BY	Rush Kuo		

CHANNEL	CHANNEL FREQUENCY (MHz)	PEAK POWER OUTPUT (mW)	PEAK POWER OUTPUT (dBm)	PEAK POWER LIMIT (dBm)	PASS/FAIL
1	2412	51.286	17.10	30	PASS
6	2437	52.481	17.20	30	PASS
11	2462	50.119	17.00	30	PASS

4.4.8 TEST RESULTS (B)

EUT	Notebook	MODEL	557S
INPUT POWER (SYSTEM)	120 Vac, 60 Hz	ENVIRONMENTAL CONDITIONS	23 deg. C, 69% RH, 991 hPa
TESTED BY	Rush Kuo		

CHANNEL	CHANNEL FREQUENCY (MHz)	PEAK POWER OUTPUT (mW)	PEAK POWER OUTPUT (dBm)	PEAK POWER LIMIT (dBm)	PASS/FAIL
1	2412	16.596	12.20	30	PASS
6	2437	15.849	12.00	30	PASS
11	2462	16.218	12.10	30	PASS