

FCC TEST REPORT

(PART 15, SUBPART C, 15.247)

REPORT NO.: RF950414L16
MODEL NO.: G420
RECEIVED: Apr. 21, 2006
TESTED: Apr. 21 ~ May 05, 2006
ISSUED: May 08, 2006

APPLICANT: ELITEGROUP COMPUTER SYSTEMS
CO., LTD.

ADDRESS: 2F. No. 240, Sec. 1, Nei Hu Road, Taipei,
Taiwan 114, R.O.C.

ISSUED BY: Advance Data Technology Corporation

LAB ADDRESS: No. 47, 14th Ling, Chia Pau Tsuen, Lin Kou
Hsiang 244, Taipei Hsien, Taiwan, R.O.C.

TEST LOCATION: No. 19, Hwa Ya 2nd Rd., Wen Hwa Tsuen, Kwei
Shan Hsiang, Taoyuan Hsien 333, Taiwan,
R.O.C.

This test report consists of 168 pages in total. It may be duplicated completely for legal use with the approval of the applicant. It should not be reproduced except in full, without the written approval of our laboratory. The client should not use it to claim product endorsement by CNLA, A2LA or any government agencies. The test results in the report only apply to the tested sample.



Table of Contents

1.	CERTIFICATION	6
2.	SUMMARY OF TEST RESULTS	7
2.1	MEASUREMENT UNCERTAINTY	8
3.	GENERAL INFORMATION	9
3.1	GENERAL DESCRIPTION OF EUT	9
3.2	DESCRIPTION OF TEST MODES	11
3.2.1	CONFIGURATION OF SYSTEM UNDER TEST	13
3.2.2	TEST MODE APPLICABILITY AND TESTED CHANNEL DETAIL	14
3.3	GENERAL DESCRIPTION OF APPLIED STANDARDS	18
3.4	DESCRIPTION OF SUPPORT UNITS.....	18
4.	TEST TYPES AND RESULTS (FOR 802.11b & g 2412~2462MHz BAND)	19
4.1	CONDUCTED EMISSION MEASUREMENT	19
4.1.1	LIMITS OF CONDUCTED EMISSION MEASUREMENT	19
4.1.2	TEST INSTRUMENTS.....	19
4.1.3	TEST PROCEDURES	20
4.1.4	DEVIATION FROM TEST STANDARD	20
4.1.5	TEST SETUP	21
4.1.6	EUT OPERATING CONDITIONS	21
4.1.7	TEST RESULTS	22
4.2	RADIATED EMISSION MEASUREMENT	28
4.2.1	LIMITS OF RADIATED EMISSION MEASUREMENT	28
4.2.2	TEST INSTRUMENTS.....	29
4.2.3	TEST PROCEDURES	30
4.2.4	DEVIATION FROM TEST STANDARD	30
4.2.5	TEST SETUP	31
4.2.6	EUT OPERATING CONDITIONS	31
4.2.7	TEST RESULTS	32
4.3	6dB BANDWIDTH MEASUREMENT	39
4.3.1	LIMITS OF 6dB BANDWIDTH MEASUREMENT	39
4.3.2	TEST INSTRUMENTS.....	39
4.3.3	TEST PROCEDURE.....	40
4.3.4	DEVIATION FROM TEST STANDARD	40
4.3.5	TEST SETUP	40
4.3.6	EUT OPERATING CONDITIONS	40
4.3.7	TEST RESULTS	41
4.4	MAXIMUM PEAK OUTPUT POWER.....	47
4.4.1	LIMITS OF MAXIMUM PEAK OUTPUT POWER MEASUREMENT	47
4.4.2	INSTRUMENTS.....	47
4.4.1	TEST PROCEDURES	48
4.4.2	DEVIATION FROM TEST STANDARD	48
4.4.3	TEST SETUP	48
4.4.4	EUT OPERATING CONDITIONS	48
4.4.3	TEST RESULTS	49
4.5	POWER SPECTRAL DENSITY MEASUREMENT.....	50
4.5.1	LIMITS OF POWER SPECTRAL DENSITY MEASUREMENT.....	50
4.5.2	TEST INSTRUMENTS.....	50

4.5.3	TEST PROCEDURE.....	51
4.5.4	DEVIATION FROM TEST STANDARD.....	51
4.5.5	TEST SETUP.....	51
4.5.6	EUT OPERATING CONDITION.....	51
4.5.7	TEST RESULTS.....	52
4.6	BAND EDGES MEASUREMENT.....	58
4.6.1	LIMITS OF BAND EDGES MEASUREMENT.....	58
4.6.2	TEST INSTRUMENTS.....	58
4.6.3	TEST PROCEDURE.....	58
4.6.4	DEVIATION FROM TEST STANDARD.....	58
4.6.5	EUT OPERATING CONDITION.....	58
4.6.6	TEST RESULTS.....	59
4.7	ANTENNA REQUIREMENT.....	67
4.7.1	STANDARD APPLICABLE.....	67
4.7.2	ANTENNA CONNECTED CONSTRUCTION.....	67
5.	TEST TYPES AND RESULTS (FOR 802.11a 5745~5825MHz Band).....	68
5.1	CONDUCTED EMISSION MEASUREMENT.....	68
5.1.1	LIMITS OF CONDUCTED EMISSION MEASUREMENT.....	68
5.1.2	TEST INSTRUMENTS.....	68
5.1.3	TEST PROCEDURES.....	69
5.1.4	DEVIATION FROM TEST STANDARD.....	69
5.1.5	TEST SETUP.....	70
5.1.6	EUT OPERATING CONDITIONS.....	70
5.1.7	TEST RESULTS.....	71
5.2	RADIATED EMISSION MEASUREMENT.....	73
5.2.1	LIMITS OF RADIATED EMISSION MEASUREMENT.....	73
5.2.2	TEST INSTRUMENTS.....	74
5.2.3	TEST PROCEDURES.....	75
5.2.4	DEVIATION FROM TEST STANDARD.....	75
5.2.5	TEST SETUP.....	76
5.2.6	EUT OPERATING CONDITIONS.....	76
5.2.7	TEST RESULTS.....	77
5.3	6dB BANDWIDTH MEASUREMENT.....	81
5.3.1	LIMITS OF 6dB BANDWIDTH MEASUREMENT.....	81
5.3.2	TEST INSTRUMENTS.....	81
5.3.3	TEST PROCEDURE.....	82
5.3.4	DEVIATION FROM TEST STANDARD.....	82
5.3.5	TEST SETUP.....	82
5.3.6	EUT OPERATING CONDITIONS.....	82
5.3.7	TEST RESULTS.....	83
5.4	MAXIMUM PEAK OUTPUT POWER.....	86
5.4.1	LIMITS OF MAXIMUM PEAK OUTPUT POWER MEASUREMENT.....	86
5.4.2	INSTRUMENTS.....	86
5.4.3	TEST PROCEDURES.....	87
5.4.4	DEVIATION FROM TEST STANDARD.....	87
5.4.5	TEST SETUP.....	87
5.4.6	EUT OPERATING CONDITIONS.....	87
5.4.7	TEST RESULTS.....	88
5.5	POWER SPECTRAL DENSITY MEASUREMENT.....	89
5.5.1	LIMITS OF POWER SPECTRAL DENSITY MEASUREMENT.....	89



5.5.2	TEST INSTRUMENTS.....	89
5.5.3	TEST PROCEDURE.....	90
5.5.4	DEVIATION FROM TEST STANDARD.....	90
5.5.5	TEST SETUP.....	90
5.5.6	EUT OPERATING CONDITION.....	90
5.5.7	TEST RESULTS.....	91
5.6	BAND EDGES MEASUREMENT.....	94
5.6.1	LIMITS OF BAND EDGES MEASUREMENT.....	94
5.6.2	TEST INSTRUMENTS.....	94
5.6.3	TEST PROCEDURE.....	94
5.6.4	DEVIATION FROM TEST STANDARD.....	94
5.6.5	EUT OPERATING CONDITION.....	95
5.6.6	TEST RESULTS.....	95
5.7	ANTENNA REQUIREMENT.....	99
5.7.1	STANDARD APPLICABLE.....	99
5.7.2	ANTENNA CONNECTED CONSTRUCTION.....	99
6.	TEST TYPES AND RESULTS (FOR BLUETOOTH).....	100
6.1.1	CONDUCTED EMISSION MEASUREMENT.....	100
6.1.2	LIMITS OF CONDUCTED EMISSION MEASUREMENT.....	100
6.1.3	TEST INSTRUMENTS.....	100
6.1.4	TEST PROCEDURES.....	101
6.1.5	DEVIATION FROM TEST STANDARD.....	101
6.1.6	TEST SETUP.....	102
6.1.7	EUT OPERATING CONDITIONS.....	102
6.1.8	TEST RESULTS.....	103
6.2	RADIATED EMISSION MEASUREMENT.....	109
6.2.1	LIMITS OF RADIATED EMISSION MEASUREMENT.....	109
6.2.2	TEST INSTRUMENTS.....	110
6.2.3	TEST PROCEDURES.....	111
6.2.4	DEVIATION FROM TEST STANDARD.....	111
6.2.5	TEST SETUP.....	112
6.2.6	EUT OPERATING CONDITIONS.....	112
6.2.7	TEST RESULTS.....	113
6.3	NUMBER OF HOPPING FREQUENCY USED.....	121
6.3.1	LIMIT OF HOPPING FREQUENCY USED.....	121
6.3.2	TEST INSTRUMENTS.....	121
6.3.3	TEST PROCEDURES.....	121
6.3.4	DEVIATION FROM TEST STANDARD.....	122
6.3.5	TEST SETUP.....	122
6.3.6	TEST RESULTS.....	122
6.4	DWELL TIME ON EACH CHANNEL.....	125
6.4.1	LIMIT OF DWELL TIME USED.....	125
6.4.2	TEST INSTRUMENTS.....	125
6.4.3	TEST PROCEDURES.....	125
6.4.4	DEVIATION FROM TEST STANDARD.....	125
6.4.5	TEST SETUP.....	126
6.4.6	TEST RESULTS.....	126
6.5	CHANNEL BANDWIDTH.....	134
6.5.1	LIMITS OF CHANNEL BANDWIDTH.....	134
6.5.2	TEST INSTRUMENTS.....	134



6.5.3	TEST PROCEDURE.....	134
6.5.4	DEVIATION FROM TEST STANDARD.....	134
6.5.5	TEST SETUP.....	135
6.5.6	EUT OPERATING CONDITION.....	135
6.5.7	TEST RESULTS.....	136
6.6	HOPPING CHANNEL SEPARATION.....	142
6.6.1	LIMIT OF HOPPING CHANNEL SEPARATION.....	142
6.6.2	TEST INSTRUMENTS.....	142
6.6.3	TEST PROCEDURES.....	142
6.6.4	DEVIATION FROM TEST STANDARD.....	142
6.6.5	TEST SETUP.....	142
6.6.6	TEST RESULTS.....	143
6.7	MAXIMUM PEAK OUTPUT POWER.....	149
6.7.1	LIMITS OF MAXIMUM PEAK OUTPUT POWER MEASUREMENT.....	149
6.7.2	TEST INSTRUMENTS.....	149
6.7.3	TEST PROCEDURES.....	149
6.7.4	DEVIATION FROM TEST STANDARD.....	149
6.7.5	TEST SETUP.....	150
6.7.6	EUT OPERATING CONDITION.....	150
6.7.7	TEST RESULTS.....	151
6.8	BAND EDGES MEASUREMENT.....	157
6.8.1	LIMITS OF BAND EDGES MEASUREMENT.....	157
6.8.2	TEST INSTRUMENTS.....	157
6.8.3	TEST PROCEDURE.....	157
6.8.4	DEVIATION FROM TEST STANDARD.....	157
6.8.5	EUT OPERATING CONDITION.....	157
6.8.6	TEST RESULTS.....	158
6.9	ANTENNA REQUIREMENT.....	164
6.9.1	STANDARD APPLICABLE.....	164
6.9.2	ANTENNA CONNECTED CONSTRUCTION.....	164
7.	PHOTOGRAPHS OF THE TEST CONFIGURATION.....	165
8.	INFORMATION ON THE TESTING LABORATORIES.....	167
	APPENDIX-A.....	A-1



1. CERTIFICATION

PRODUCT: Notebook

MODEL: G420

BRAND: ECS

APPLICANT: ELITEGROUP COMPUTER SYSTEMS CO., LTD.

TEST SAMPLE: ENGINEERING SAMPLE

TESTED: Apr. 21 ~ May 05, 2006

STANDARDS: FCC Part 15, Subpart C (Section 15.247),
ANSI C63.4-2003

The above equipment has been tested by **Advance Data Technology Corporation**, and found compliance with the requirement of the above standards. The test record, data evaluation & Equipment Under Test (EUT) configurations represented herein are true and accurate accounts of the measurements of the sample's EMC characteristics under the conditions specified in this report.

PREPARED BY Wendy Liao , **DATE :** May 08, 2006
Wendy Liao

TECHNICAL
ACCEPTANCE : Stanely Hsu , **DATE :** May 08, 2006
Responsible for RF Stanely Hsu

APPROVED BY : Gary Chang , **DATE :** May 08, 2006
Gary Chang / Supervisor

2. SUMMARY OF TEST RESULTS

The EUT has been tested according to the following specifications:

For WLAN Function

APPLIED STANDARD: FCC Part 15, Subpart C (Section 15.247)			
Standard Section	Test Type and Limit	Result	Remark
15.207	AC Power Conducted Emission	PASS	Meet the requirement of limit. Minimum passing margin is -22.10dB at 0.505MHz
15.247(a)(2)	Spectrum Bandwidth of a Direct Sequence Spread Spectrum System Limit: min. 500kHz	PASS	Meet the requirement of limit.
15.247(b)	Maximum Peak Output Power Limit: max. 30dBm	PASS	Meet the requirement of limit.
15.247(d)	Radiated Emissions Limit: Table 15.209	PASS	Meet the requirement of limit. Minimum passing margin is -6.88dB at 2483.50MHz
15.247(e)	Power Spectral Density Limit: max. 8dBm	PASS	Meet the requirement of limit.
15.247(d)	Band Edge Measurement Limit: 20dB less than the peak value of fundamental frequency	PASS	Meet the requirement of limit.

For Bluetooth Function

APPLIED STANDARD: FCC Part 15, Subpart C			
Standard Section	Test Type and Limit	Result	Remark
15.207	AC Power Conducted Emission	PASS	Meet the requirement of limit Minimum passing margin is -17.31dB at 16.626MHz
15.247 (a) (1) (iii)	Number of Hopping Frequency Used Spec.: At least 15 channels	PASS	Meet the requirement of limit
15.247 (a) (1) (iii)	Dwell Time on Each Channel Spec.: Max. 0.4 second within 31.6 second	PASS	Meet the requirement of limit
15.247 (a) (1)	Hopping Channel Separation Spec. : Min. 25 kHz or 20 dB bandwidth, which ever is greater	PASS	Meet the requirement of limit
15.247 (a) (1)	Spectrum Bandwidth of a Frequency Hopping Sequence Spread Spectrum System	NA	NA
15.247 (b)	Maximum Peak Output Power Spec.: max. 30dBm	PASS	Meet the requirement of limit
15.247 (d)	Transmitter Radiated Emissions Spec.: Table 15.209	PASS	Meet the requirement of limit Minimum passing margin is -9.18dB at 624.83MHz
15.247 (d)	Band Edge Measurement	PASS	Meet the requirement of limit

2.1 MEASUREMENT UNCERTAINTY

Where relevant, the following measurement uncertainty levels have been estimated for tests performed on the EUT as specified in CISPR 16-4:

Measurement	Frequency	Uncertainty
Conducted emissions	9kHz~30MHz	2.44 dB
	30MHz ~ 200MHz	3.55 dB
Radiated emissions	200MHz ~1000MHz	3.58 dB
	1GHz ~ 18GHz	1.10 dB
	18GHz ~ 40GHz	0.91 dB

This uncertainty represents an expanded uncertainty expressed at approximately the 95% confidence level using a coverage factor of k=2.

3. GENERAL INFORMATION

GENERAL DESCRIPTION OF EUT

EUT	Notebook
MODEL NO.	G420
FCC ID	SA6G420IABGHBT
POWER SUPPLY	19.0Vdc from AC Adapter
MODULATION TYPE	Wireless LAN: CCK, DQPSK, DBPSK for DSSS 64QAM, 16QAM, QPSK, BPSK for OFDM Bluetooth: GFSK, $\pi/4$ -DQPSK, 8DPSK for FHSS
MODULATION TECHNOLOGY	DSSS, OFDM, FHSS
TRANSFER RATE	Wireless LAN: 802.11b: 11/5.5/2/1Mbps 802.11g: 54/48/36/24/18/12/9/6Mbps 802.11a: 54/48/36/24/18/12/9/6Mbps Bluetooth: 1/2/3Mbps
FREQUENCY RANGE	Wireless LAN: 802.11b & 802.11g: 2.412 ~ 2.462GHz 802.11a: 5.180 ~ 5.320GHz, 5.745 ~ 5.825GHz Bluetooth: 2.402 ~ 2.480GHz
NUMBER OF CHANNEL	Wireless LAN: 802.11b & 802.11g: 11 802.11a: 13 Bluetooth: 79
CHANNEL SPACING	Wireless LAN: 802.11b & 802.11g: 5MHz 802.11a: 20MHz Bluetooth: 1MHz
OUTPUT POWER	Wireless LAN: 40.179mW for 802.11b 36.058mW for 802.11g 28.445mW for 5.180 ~ 5.320GHz 36.058mW for 5.745 ~ 5.825GHz Bluetooth: 1.016mW
ANTENNA TYPE	For 2.4GHz Left: PIFA antenna with -1.54486dBi gain Right: PIFA antenna with -1.09449dBi gain For 5.0GHz Left: PIFA antenna with -0.84897dBi gain Right: PIFA antenna with -2.84636Bi gain For Bluetooth PIFA antenna with -1.51038dBi gain
DATA CABLE	NA
I/O PORTS	Refer to user's manual
ASSOCIATED DEVICES	NA

NOTE:

1. The EUT is a Notebook with wireless LAN and bluetooth functions.
2. The adapter were operated with following power adapters:

BRAND:	LI SHIN INTERNATIONAL ENTERPRISE CORP.
MODEL:	LSE0202C1990
INPUT:	100-240Vac, 50-60Hz, 1.5A
OUTPUT:	19Vdc, 4.74A
POWER LINE:	AC 1.6m non-shielded cable without core DC 1.6m non-shielded cable with one core

3. The EUT operates in both the 5GHz and 2.4GHz Bands and compatibility with 802.11a and 802.11b, 802.11g technology.
4. The above EUT information was declared by the manufacturer and for more detailed features description, please refer to the manufacturer's specifications or User's Manual.

DESCRIPTION OF TEST MODES

Operated in 2400 ~ 2483.5MHz band:

11 channels are provided to the EUT for wireless LAN function:

CHANNEL	FREQUENCY	CHANNEL	FREQUENCY
1	2412 MHz	7	2442 MHz
2	2417 MHz	8	2447 MHz
3	2422 MHz	9	2452 MHz
4	2427 MHz	10	2457 MHz
5	2432 MHz	11	2462 MHz
6	2437 MHz		

79 channels are provided to this EUT for bluetooth function:

CHANNEL	FREQ. (MHz)	CHANNEL	FREQ. (MHz)	CHANNEL	FREQ. (MHz)	CHANNEL	FREQ. (MHz)
0	2402	20	2422	40	2442	60	2462
1	2403	21	2423	41	2443	61	2463
2	2404	22	2424	42	2444	62	2464
3	2405	23	2425	43	2445	63	2465
4	2406	24	2426	44	2446	64	2466
5	2407	25	2427	45	2447	65	2467
6	2408	26	2428	46	2448	66	2468
7	2409	27	2429	47	2449	67	2469
8	2410	28	2430	48	2450	68	2470
9	2411	29	2431	49	2451	69	2471
10	2412	30	2431	50	2452	70	2472
11	2413	31	2433	51	2453	71	2473
12	2414	32	2434	52	2454	72	2474
13	2415	33	2435	53	2455	73	2475
14	2416	34	2436	54	2456	74	2476
15	2417	35	2437	55	2457	75	2477
16	2418	36	2438	56	2458	76	2478
17	2419	37	2439	57	2459	77	2479
18	2420	38	2440	58	2460	78	2480
19	2421	39	2441	59	2461		

Operated in 5745 ~ 5825MHz band:

5 channels are provided to this EUT for wireless LAN function:

CHANNEL	FREQUENCY
1	5745 MHz
2	5765 MHz
3	5785 MHz
4	5805 MHz
5	5825 MHz

CONFIGURATION OF SYSTEM UNDER TEST

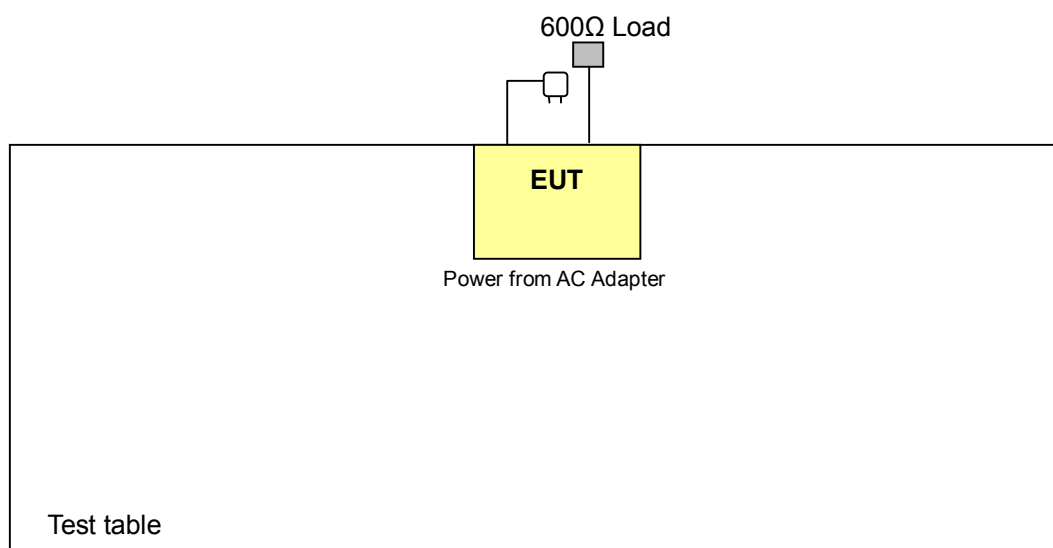

TEST MODE APPLICABILITY AND TESTED CHANNEL DETAIL

FOR WIRELESS LAN FUNCTION:

EUT configure mode	Applicable to				Description
	PLC	RE<1G	RE≥1G	APCM	
-	√	√	√	√	-

Where PLC: Power Line Conducted Emission

RE<1G RE: Radiated Emission below 1GHz

RE≥1G: Radiated Emission above 1GHz

APCM: Antenna Port Conducted Measurement

Power Line Conducted Emission Test:

- Pre-Scan has been conducted to determine the worst-case mode from all possible combinations between available modulations, data rates and antenna ports (if EUT with antenna diversity architecture).
- Following channel(s) was (were) selected for the final test as listed below.

Mode	AVAILABLE CHANNEL	TESTED CHANNEL	MODULATION TECHNOLOGY	MODULATION TYPE	DATA RATE (Mbps)
802.11g	1 to 11	1, 6, 11	OFDM	BPSK	6
802.11a	1 to 5	5	OFDM	BPSK	6

Radiated Emission Test (Below 1 GHz):

- Pre-Scan has been conducted to determine the worst-case mode from all possible combinations between available modulations, data rates, antenna ports (if EUT with antenna diversity architecture).
- Following channel(s) was (were) selected for the final test as listed below.

Mode	AVAILABLE CHANNEL	TESTED CHANNEL	MODULATION TECHNOLOGY	MODULATION TYPE	DATA RATE (Mbps)
802.11g	1 to 11	11	OFDM	BPSK	6
802.11a	1 to 5	5	OFDM	BPSK	6



Radiated Emission Test (Above 1 GHz):

- Pre-Scan has been conducted to determine the worst-case mode from all possible combinations between available modulations, data rates and antenna ports (if EUT with antenna diversity architecture).
- Following channel(s) was (were) selected for the final test as listed below.

Mode	AVAILABLE CHANNEL	TESTED CHANNEL	MODULATION TECHNOLOGY	MODULATION TYPE	DATA RATE (Mbps)
802.11b	1 to 11	1, 6, 11	DSSS	DBPSK	1
802.11g	1 to 11	1, 6, 11	OFDM	BPSK	6
802.11a	1 to 5	1, 3, 5	OFDM	BPSK	6

Bandedge Measurement:

- Pre-Scan has been conducted to determine the worst-case mode from all possible combinations between available modulations, data rates and antenna ports (if EUT with antenna diversity architecture).
- Following channel(s) was (were) selected for the final test as listed below.

Mode	AVAILABLE CHANNEL	TESTED CHANNEL	MODULATION TECHNOLOGY	MODULATION TYPE	DATA RATE (Mbps)
802.11b	1 to 11	1, 11	DSSS	DBPSK	1
802.11g	1 to 11	1, 11	OFDM	BPSK	6
802.11a	1 to 5	1, 5	OFDM	BPSK	6

Antenna Port Conducted Measurement:

- Pre-Scan has been conducted to determine the worst-case mode from all possible combinations between available modulations, data rates and antenna ports (if EUT with antenna diversity architecture).
- Following channel(s) was (were) selected for the final test as listed below.

Mode	AVAILABLE CHANNEL	TESTED CHANNEL	MODULATION TECHNOLOGY	MODULATION TYPE	DATA RATE (Mbps)
802.11b	1 to 11	1, 6, 11	DSSS	DBPSK	1
802.11g	1 to 11	1, 6, 11	OFDM	BPSK	6
802.11a	1 to 5	1, 3, 5	OFDM	BPSK	6

FOR BLUETOOTH FUNCTION:

EUT configure mode	Applicable to				Description
	PLC	RE<1G	RE≥1G	APCM	
A	√	√	√	√	Modulation Type: GFSK
B	-	-	√	√	Modulation Type: 8DPSK

Where PLC: Power Line Conducted Emission
RE≥1G: Radiated Emission above 1GHz

RE<1G RE: Radiated Emission below 1GHz
APCM: Antenna Port Conducted Measurement

NOTE: "-" means no effect

Power Line Conducted Emission Test:

- Pre-Scan has been conducted to determine the worst-case mode from all possible combinations between available modulations, data rates and antenna ports (if EUT with antenna diversity architecture), and packet types.
- Following channel(s) was (were) selected for the final test as listed below.

EUT configure mode	AVAILABLE CHANNEL	TESTED CHANNEL	MODULATION TECHNOLOGY	MODULATION TYPE	PACKET TYPE
A	0 to 78	0, 39, 78	FHSS	GFSK	DH5

Radiated Emission Test (Below 1 GHz):

- Pre-Scan has been conducted to determine the worst-case mode from all possible combinations between available modulations, data rates, antenna ports (if EUT with antenna diversity architecture).
- Following channel(s) was (were) selected for the final test as listed below.
- Following channel(s) was (were) selected for the final test as listed below.

EUT configure mode	AVAILABLE CHANNEL	TESTED CHANNEL	MODULATION TECHNOLOGY	MODULATION TYPE	PACKET TYPE
A	0 to 78	78	FHSS	GFSK	DH5

Radiated Emission Test (Above 1 GHz):

- Pre-Scan has been conducted to determine the worst-case mode from all possible combinations between available modulations, data rates and antenna ports (if EUT with antenna diversity architecture).
- Following channel(s) was (were) selected for the final test as listed below.

EUT configure mode	AVAILABLE CHANNEL	TESTED CHANNEL	MODULATION TECHNOLOGY	MODULATION TYPE	PACKET TYPE
A	0 to 78	0, 39, 78	FHSS	GFSK	DH5
B	0 to 78	0, 39, 78	FHSS	8DPSK	DH5

Bandedge Measurement:

- Pre-Scan has been conducted to determine the worst-case mode from all possible combinations between available modulations, data rates and antenna ports (if EUT with antenna diversity architecture).
- Following channel(s) was (were) selected for the final test as listed below.

EUT configure mode	AVAILABLE CHANNEL	TESTED CHANNEL	MODULATION TECHNOLOGY	MODULATION TYPE	PACKET TYPE
A	0 to 78	0, 78	FHSS	GFSK	DH5
B	0 to 78	0, 78	FHSS	8DPSK	DH5

Antenna Port Conducted Measurement:

- Pre-Scan has been conducted to determine the worst-case mode from all possible combinations between available modulations, data rates and antenna ports (if EUT with antenna diversity architecture).
- Following channel(s) was (were) selected for the final test as listed below.

EUT configure mode	AVAILABLE CHANNEL	TESTED CHANNEL	MODULATION TECHNOLOGY	MODULATION TYPE	PACKET TYPE
A	0 to 78	0, 39, 78	FHSS	GFSK	DH5
B	0 to 78	0, 39, 78	FHSS	8DPSK	DH5



GENERAL DESCRIPTION OF APPLIED STANDARDS

The EUT is a RF Product. According to the specifications of the manufacturer, it must comply with the requirements of the following standards:

FCC Part 15, Subpart C. (15.247)

ANSI C63.4-2003

All test items have been performed and recorded as per the above standards.

NOTE: The EUT is also considered as a kind of computer peripheral, because the connection to computer is necessary for typical use. It has been verified to comply with the requirements of FCC Part 15, Subpart B, Class B (DoC). The test report has been issued separately.

DESCRIPTION OF SUPPORT UNITS

The EUT has been tested as an independent unit together with other necessary accessories or support units. The following support units or accessories were used to form a representative test configuration during the tests.

NO.	PRODUCT	BRAND	MODEL NO.	SERIAL NO.	FCC ID
1	600Ω Load	NA	NA	NA	NA

NO.	SIGNAL CABLE DESCRIPTION OF THE ABOVE SUPPORT UNITS
1	NA

NOTE: All power cords of the above support units are non shielded (1.8m).



TEST TYPES AND RESULTS (FOR 802.11b & g 2412~2462MHz BAND)

CONDUCTED EMISSION MEASUREMENT

LIMITS OF CONDUCTED EMISSION MEASUREMENT

FREQUENCY OF EMISSION (MHz)	CONDUCTED LIMIT (dB μ V)	
	Quasi-peak	Average
0.15-0.5	66 to 56	56 to 46
0.5-5	56	46
5-30	60	50

- NOTE:**
1. The lower limit shall apply at the transition frequencies.
 2. The limit decreases in line with the logarithm of the frequency in the range of 0.15 to 0.50 MHz.
 3. All emanations from a class A/B digital device or system, including any network of conductors and apparatus connected thereto, shall not exceed the level of field strengths specified above.

TEST INSTRUMENTS

DESCRIPTION & MANUFACTURER	MODEL NO.	SERIAL NO.	CALIBRATED UNTIL
Test Receiver ROHDE & SCHWARZ	ESCS30	100291	Nov. 11, 2006
RF signal cable Woken	5D-FB	Cable-HYC01-01	Jan. 06, 2007
LISN ROHDE & SCHWARZ	ESH3-Z5	100312	Feb. 15, 2007
LISN ROHDE & SCHWARZ	ESH2-Z5	100104	Feb. 07, 2007
Software ADT	ADT_Cond_V3	NA	NA

- NOTE:**
1. The calibration interval of the above test instruments is 12 months and the calibrations are traceable to NML/ROC and NIST/USA.
 2. The test was performed in HwaYa Shielded Room 1.
 3. The VCCI Site Registration No. is C-2040.

TEST PROCEDURES

- a. The EUT was placed 0.4 meters from the conducting wall of the shielded room with EUT being connected to the power mains through a line impedance stabilization network (LISN). Other support units were connected to the power mains through another LISN. The two LISNs provide 50 ohm/ 50uH of coupling impedance for the measuring instrument.
- b. Both lines of the power mains connected to the EUT were checked for maximum conducted interference.
- c. The frequency range from 150kHz to 30MHz was searched. Emission levels under (Limit - 20dB) was not recorded.

DEVIATION FROM TEST STANDARD

No deviation

TEST SETUP

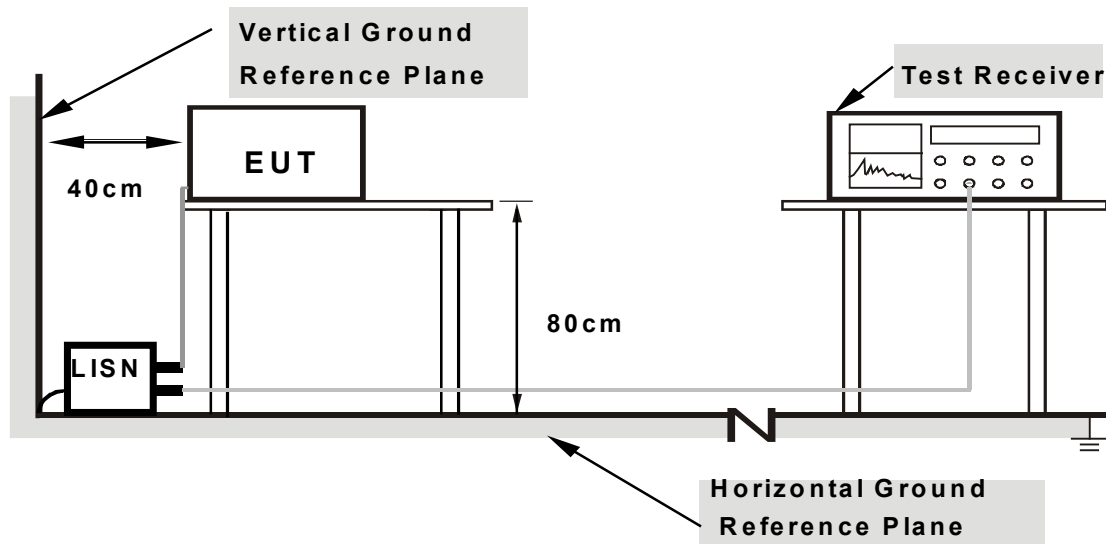

- Note:**
1. Support units were connected to second LISN.
 2. Both of LISNs (AMN) are 80 cm from EUT and at least 80 from other units and other metal planes

For the actual test configuration, please refer to the related item – Photographs of the Test Configuration.

EUT OPERATING CONDITIONS

- a. Placed the EUT on a testing table.
- b. The EUT ran a test program (provided by manufacturer) to enable all functions under transmission condition continuously at specific channel frequency.
- c. The EUT sent "H" messages to monitor.
- d. Step c was repeated.

TEST RESULTS

Conducted Worst-Case Data

EUT TEST CONDITION		MEASUREMENT DETAIL	
CHANNEL	Channel 1	PHASE	Line 1
MODULATION TYPE	BPSK	6dB BANDWIDTH	9 kHz
TRANSFER RATE	6Mbps	ENVIRONMENTAL CONDITIONS	20deg. C, 60%RH, 991hPa
TESTED BY	Match Tsui	INPUT POWER (SYSTEM)	120Vac, 60 Hz

No	Freq. [MHz]	Corr. Factor (dB)	Reading Value [dB (uV)]		Emission Level [dB (uV)]		Limit [dB (uV)]		Margin (dB)	
			Q.P.	AV.	Q.P.	AV.	Q.P.	AV.	Q.P.	AV.
			1	0.189	0.10	40.03	-	40.13	-	64.08
2	0.380	0.10	33.72	-	33.82	-	58.27	48.27	-24.45	-
3	0.443	0.11	34.25	-	34.36	-	57.01	47.01	-22.65	-
4	0.505	0.12	33.34	-	33.46	-	56.00	46.00	-22.54	-
5	4.535	0.47	27.98	-	28.45	-	56.00	46.00	-27.55	-
6	16.508	0.69	34.10	-	34.79	-	60.00	50.00	-25.21	-

- REMARKS:**
1. Q.P. and AV. are abbreviations of quasi-peak and average individually.
 2. "-": The Quasi-peak reading value also meets average limit and measurement with the average detector is unnecessary.
 3. The emission levels of other frequencies were very low against the limit.
 4. Margin value = Emission level - Limit value
 5. Correction factor = Insertion loss + Cable loss
 6. Emission Level = Correction Factor + Reading Value.

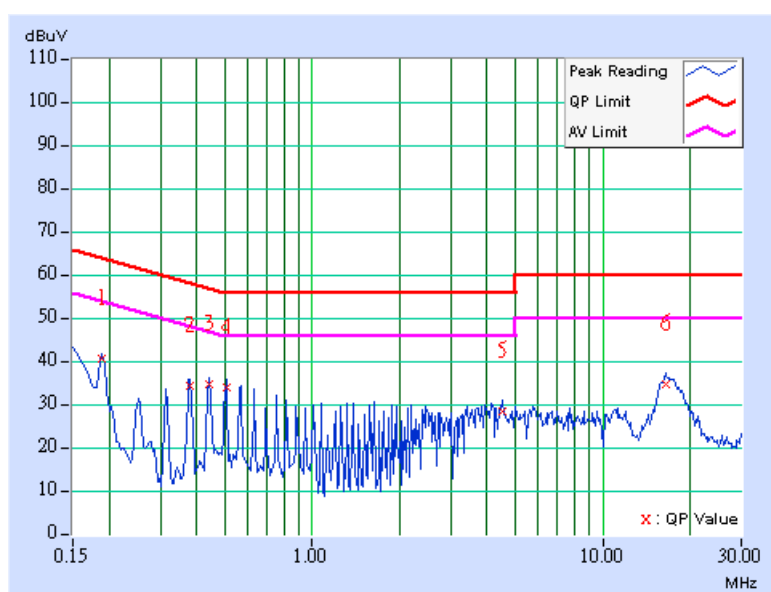

EUT TEST CONDITION		MEASUREMENT DETAIL	
CHANNEL	Channel 1	PHASE	Line 2
MODULATION TYPE	BPSK	6dB BANDWIDTH	9 kHz
TRANSFER RATE	6Mbps	ENVIRONMENTAL CONDITIONS	20deg. C, 60%RH, 991hPa
TESTED BY	Match Tsui	INPUT POWER (SYSTEM)	120Vac, 60 Hz

No	Freq. [MHz]	Corr. Factor [dB]	Reading Value [dB (uV)]		Emission Level [dB (uV)]		Limit [dB (uV)]		Margin (dB)	
			Q.P.	AV.	Q.P.	AV.	Q.P.	AV.	Q.P.	AV.
			1	0.188	0.10	39.60	-	39.70	-	64.13
2	0.380	0.10	35.13	-	35.23	-	58.27	48.27	-23.04	-
3	0.439	0.10	33.71	-	33.81	-	57.08	47.08	-23.27	-
4	0.568	0.10	32.08	-	32.18	-	56.00	46.00	-23.82	-
5	3.402	0.32	28.51	-	28.83	-	56.00	46.00	-27.17	-
6	16.379	0.56	33.30	-	33.86	-	60.00	50.00	-26.14	-

- REMARKS:**
1. Q.P. and AV. are abbreviations of quasi-peak and average individually.
 2. "-": The Quasi-peak reading value also meets average limit and measurement with the average detector is unnecessary.
 3. The emission levels of other frequencies were very low against the limit.
 4. Margin value = Emission level - Limit value
 5. Correction factor = Insertion loss + Cable loss
 6. Emission Level = Correction Factor + Reading Value.

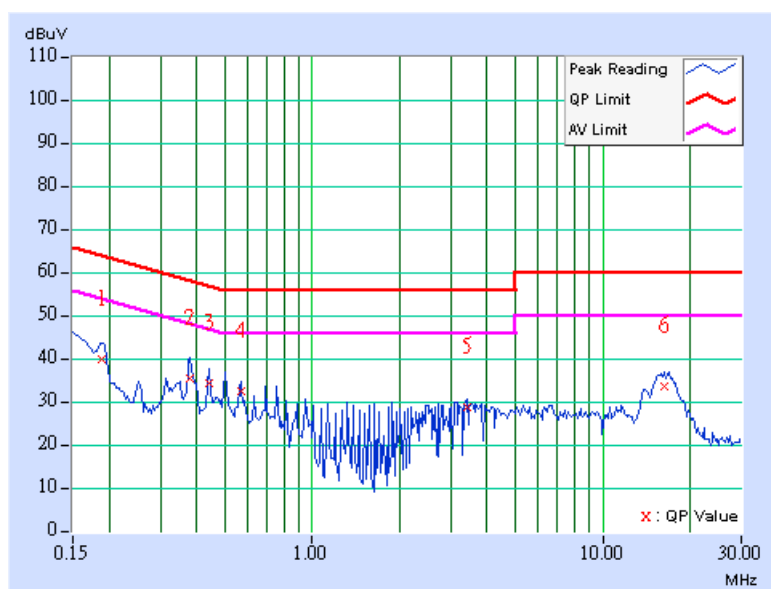

EUT TEST CONDITION		MEASUREMENT DETAIL	
CHANNEL	Channel 6	PHASE	Line 1
MODULATION TYPE	BPSK	6dB BANDWIDTH	9 kHz
TRANSFER RATE	6Mbps	ENVIRONMENTAL CONDITIONS	20deg. C, 60%RH, 991hPa
TESTED BY	Match Tsui	INPUT POWER (SYSTEM)	120Vac, 60 Hz

No	Freq. [MHz]	Corr. Factor (dB)	Reading Value [dB (uV)]		Emission Level [dB (uV)]		Limit [dB (uV)]		Margin (dB)	
			Q.P.	AV.	Q.P.	AV.	Q.P.	AV.	Q.P.	AV.
1	0.189	0.10	39.97	-	40.07	-	64.08	54.08	-24.01	-
2	0.377	0.10	35.14	-	35.24	-	58.35	48.35	-23.11	-
3	0.443	0.11	34.25	-	34.36	-	57.01	47.01	-22.65	-
4	0.505	0.12	33.30	-	33.42	-	56.00	46.00	-22.58	-
5	4.602	0.47	26.68	-	27.15	-	56.00	46.00	-28.85	-
6	16.637	0.70	33.57	-	34.27	-	60.00	50.00	-25.73	-

- REMARKS:**
1. Q.P. and AV. are abbreviations of quasi-peak and average individually.
 2. "-": The Quasi-peak reading value also meets average limit and measurement with the average detector is unnecessary.
 3. The emission levels of other frequencies were very low against the limit.
 4. Margin value = Emission level - Limit value
 5. Correction factor = Insertion loss + Cable loss
 6. Emission Level = Correction Factor + Reading Value.

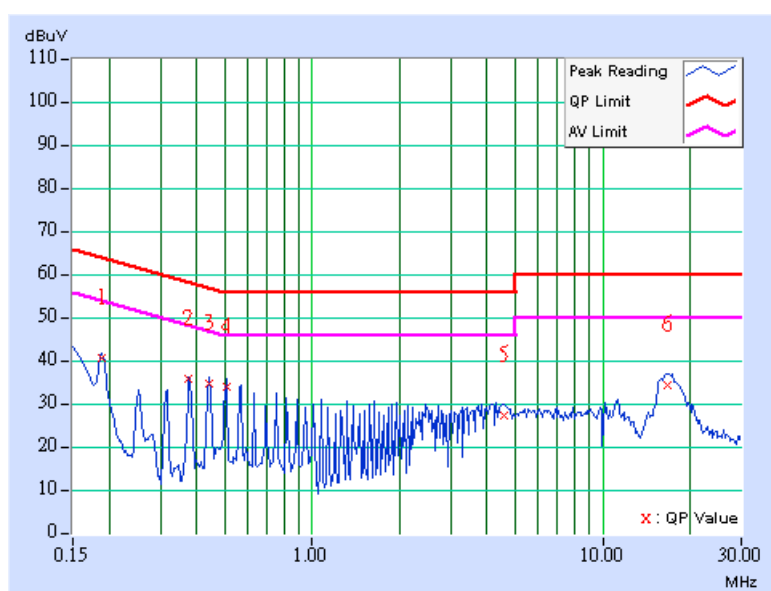

EUT TEST CONDITION		MEASUREMENT DETAIL	
CHANNEL	Channel 6	PHASE	Line 2
MODULATION TYPE	BPSK	6dB BANDWIDTH	9 kHz
TRANSFER RATE	6Mbps	ENVIRONMENTAL CONDITIONS	20deg. C, 60%RH, 991hPa
TESTED BY	Match Tsui	INPUT POWER (SYSTEM)	120Vac, 60 Hz

No	Freq. [MHz]	Corr. Factor (dB)	Reading Value [dB (uV)]		Emission Level [dB (uV)]		Limit [dB (uV)]		Margin (dB)	
			Q.P.	AV.	Q.P.	AV.	Q.P.	AV.	Q.P.	AV.
1	0.189	0.10	39.72	-	39.82	-	64.08	54.08	-24.26	-
2	0.377	0.10	35.43	-	35.53	-	58.35	48.35	-22.82	-
3	0.443	0.10	33.97	-	34.07	-	57.01	47.01	-22.94	-
4	0.505	0.10	33.80	-	33.90	-	56.00	46.00	-22.10	-
5	3.402	0.32	28.49	-	28.81	-	56.00	46.00	-27.19	-
6	16.507	0.56	33.52	-	34.08	-	60.00	50.00	-25.92	-

- REMARKS:**
1. Q.P. and AV. are abbreviations of quasi-peak and average individually.
 2. "-": The Quasi-peak reading value also meets average limit and measurement with the average detector is unnecessary.
 3. The emission levels of other frequencies were very low against the limit.
 4. Margin value = Emission level - Limit value
 5. Correction factor = Insertion loss + Cable loss
 6. Emission Level = Correction Factor + Reading Value.

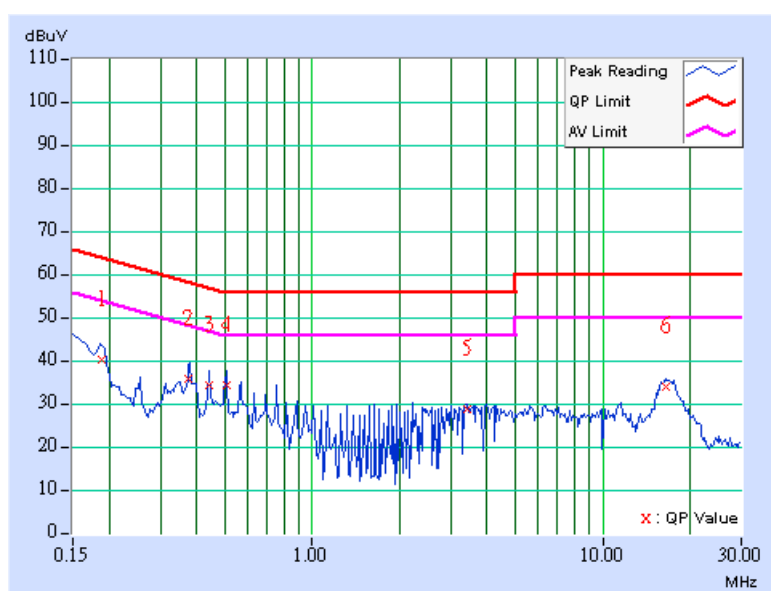

EUT TEST CONDITION		MEASUREMENT DETAIL	
CHANNEL	Channel 11	PHASE	Line 1
MODULATION TYPE	BPSK	6dB BANDWIDTH	9 kHz
TRANSFER RATE	6Mbps	ENVIRONMENTAL CONDITIONS	20deg. C, 60%RH, 991hPa
TESTED BY	Match Tsui	INPUT POWER (SYSTEM)	120Vac, 60 Hz

No	Freq. [MHz]	Corr. Factor (dB)	Reading Value		Emission Level		Limit		Margin	
			[dB (uV)]		[dB (uV)]		[dB (uV)]		(dB)	
			Q.P.	AV.	Q.P.	AV.	Q.P.	AV.	Q.P.	AV.
1	0.189	0.10	39.99	-	40.09	-	64.08	54.08	-23.99	-
2	0.377	0.10	35.15	-	35.25	-	58.35	48.35	-23.10	-
3	0.443	0.11	34.27	-	34.38	-	57.01	47.01	-22.63	-
4	0.568	0.13	32.34	-	32.47	-	56.00	46.00	-23.53	-
5	0.568	0.13	32.32	-	32.45	-	56.00	46.00	-23.55	-
6	16.570	0.69	34.34	-	35.03	-	60.00	50.00	-24.97	-

- REMARKS:**
1. Q.P. and AV. are abbreviations of quasi-peak and average individually.
 2. "-": The Quasi-peak reading value also meets average limit and measurement with the average detector is unnecessary.
 3. The emission levels of other frequencies were very low against the limit.
 4. Margin value = Emission level - Limit value
 5. Correction factor = Insertion loss + Cable loss
 6. Emission Level = Correction Factor + Reading Value.

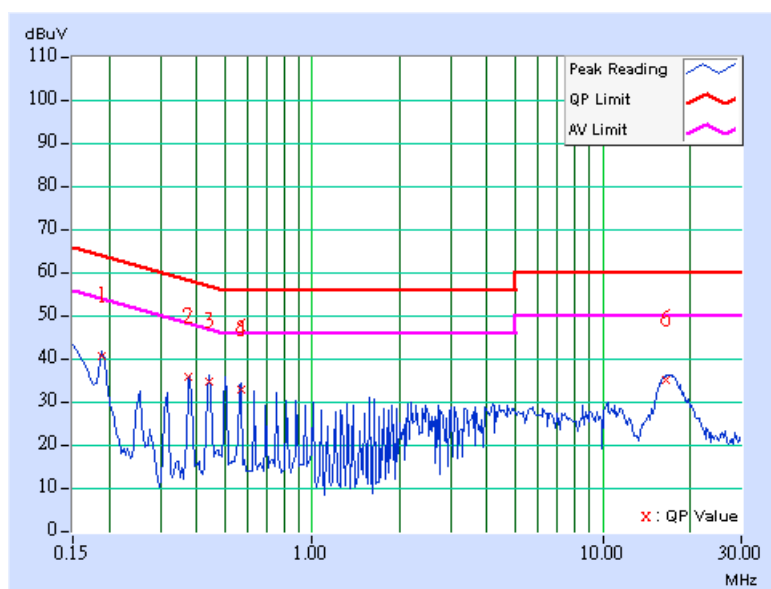

EUT TEST CONDITION		MEASUREMENT DETAIL	
CHANNEL	Channel 11	PHASE	Line 2
MODULATION TYPE	BPSK	6dB BANDWIDTH	9 kHz
TRANSFER RATE	6Mbps	ENVIRONMENTAL CONDITIONS	20deg. C, 60%RH, 991hPa
TESTED BY	Match Tsui	INPUT POWER (SYSTEM)	120Vac, 60 Hz

No	Freq. [MHz]	Corr. Factor (dB)	Reading Value [dB (uV)]		Emission Level [dB (uV)]		Limit [dB (uV)]		Margin (dB)	
			Q.P.	AV.	Q.P.	AV.	Q.P.	AV.	Q.P.	AV.
1	0.189	0.10	39.86	-	39.96	-	64.08	54.08	-24.12	-
2	0.377	0.10	35.35	-	35.45	-	58.35	48.35	-22.90	-
3	0.440	0.10	34.23	-	34.33	-	57.05	47.05	-22.72	-
4	0.568	0.10	32.22	-	32.32	-	56.00	46.00	-23.68	-
5	3.656	0.34	27.89	-	28.23	-	56.00	46.00	-27.77	-
6	16.821	0.57	33.44	-	34.01	-	60.00	50.00	-25.99	-

- REMARKS:**
1. Q.P. and AV. are abbreviations of quasi-peak and average individually.
 2. "-": The Quasi-peak reading value also meets average limit and measurement with the average detector is unnecessary.
 3. The emission levels of other frequencies were very low against the limit.
 4. Margin value = Emission level - Limit value
 5. Correction factor = Insertion loss + Cable loss
 6. Emission Level = Correction Factor + Reading Value.

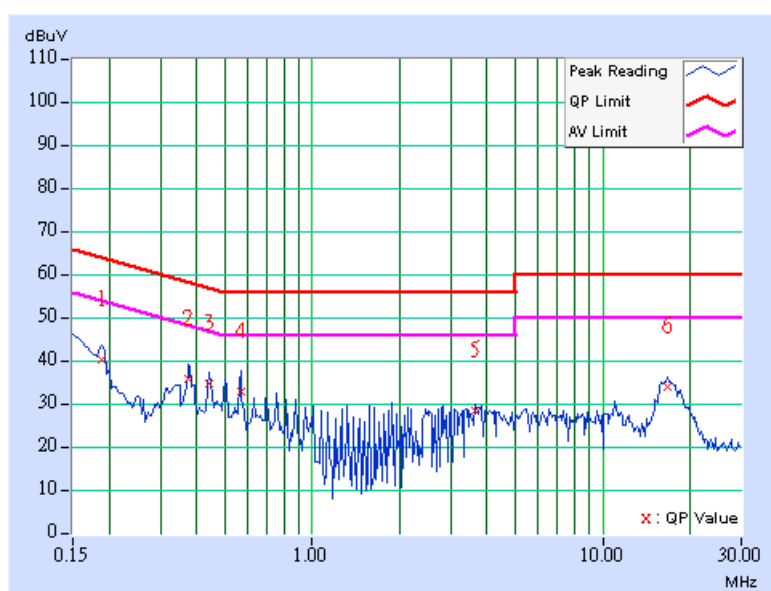

RADIATED EMISSION MEASUREMENT

LIMITS OF RADIATED EMISSION MEASUREMENT

Emissions radiated outside of the specified bands, shall be according to the general radiated limits in 15.209 as following:

Frequencies (MHz)	Field strength (microvolts/meter)	Measurement distance (meters)
0.009-0.490	2400/F(kHz)	300
0.490-1.705	24000/F(kHz)	30
1.705-30.0	30	30
30-88	100	3
88-216	150	3
216-960	200	3
Above 960	500	3

NOTE:

1. The lower limit shall apply at the transition frequencies.
2. Emission level (dBuV/m) = 20 log Emission level (uV/m).
3. As shown in 15.35(b), for frequencies above 1000MHz, the field strength limits are based on average detector, however, the peak field strength of any emission shall not exceed the maximum permitted average limits, specified above by more than 20dB under any condition of modulation.



TEST INSTRUMENTS

DESCRIPTION & MANUFACTURER	MODEL NO.	SERIAL NO.	CALIBRATED UNTIL
Test Receiver ROHDE & SCHWARZ	ESI7	100033	May. 19, 2006
Spectrum Analyzer ROHDE & SCHWARZ	FSP40	100025	Dec. 05, 2006
BILOG Antenna SCHWARZBECK	VULB9168	9168-160	Jun. 01, 2006
HORN Antenna SCHWARZBECK	9120D	9120D-408	Jan. 08, 2007
HORN Antenna SCHWARZBECK	BBHA 9170	BBHA9170243	Jan. 19, 2007
Preamplifier Agilent	8447D	2944A10633	Nov. 04, 2006
Preamplifier Agilent	8449B	3008A01964	Oct. 30, 2006
RF signal cable HUBER+SUHNNER	SUCOFLEX 104	214377/4	Dec. 13, 2006
RF signal cable HUBER+SUHNNER	SUCOFLEX 104	219272/4	Dec. 13, 2006
Software ADT.	ADT_Radiated_V5.14	NA	NA
Antenna Tower inn-co GmbH	MA 4000	013303	NA
Antenna Tower Controller inn-co GmbH	CO2000	017303	NA
Turn Table ADT.	TT100.	TT93021703	NA
Turn Table Controller ADT.	SC100.	SC93021703	NA
26GHz ~ 40GHz Amplifier	AMF-6F-2600400	923362	Mar. 27, 2007

- NOTE:**
1. The calibration interval of the above test instruments is 12 months and the calibrations are traceable to NML/ROC and NIST/USA.
 2. The test was performed in HwaYa Chamber 2.
 3. The horn antenna and HP preamplifier (model: 8449B) are used only for the measurement of emission frequency above 1GHz if tested.
 4. The VCCI Site Registration No. is R-237.
 5. The IC Site Registration No. is IC4924-3.

TEST PROCEDURES

- a. The EUT was placed on the top of a rotating table 0.8 meters above the ground at a 3 meters semi-anechoic chamber. The table was rotated 360 degrees to determine the position of the highest radiation.
- b. The EUT was set 3 meters away from the interference-receiving antenna, which was mounted on the top of a variable-height antenna tower.
- c. The antenna is a broadband antenna, and its height is varied from one meter to four meters above the ground to determine the maximum value of the field strength. Both horizontal and vertical polarizations of the antenna are set to make the measurement.
- d. For each suspected emission, the EUT was arranged to its worst case and then the antenna was tuned to heights from 1 meter to 4 meters and the rotatable table was turned from 0 degrees to 360 degrees to find the maximum reading.
- e. The test-receiver system was set to Peak Detect Function and Specified Bandwidth with Maximum Hold Mode.
- f. If the emission level of the EUT in peak mode was lower than the limit specified, then testing could be stopped and the peak values of the EUT would be reported. Otherwise the emissions would be re-tested one by one using peak, quasi-peak or average method as specified and then reported in a data sheet.

NOTE:

1. The resolution bandwidth and video bandwidth of test receiver/spectrum analyzer is 120kHz for Quasi-peak detection at frequency below 1GHz.
2. The resolution bandwidth and video bandwidth of test receiver/spectrum analyzer is 1 MHz for Peak detection (PK) at frequency above 1GHz.
3. The resolution bandwidth of test receiver/spectrum analyzer is 1 MHz and the video bandwidth is 1kHz for Average detection (AV) at frequency above 1GHz.

DEVIATION FROM TEST STANDARD

No deviation

TEST SETUP

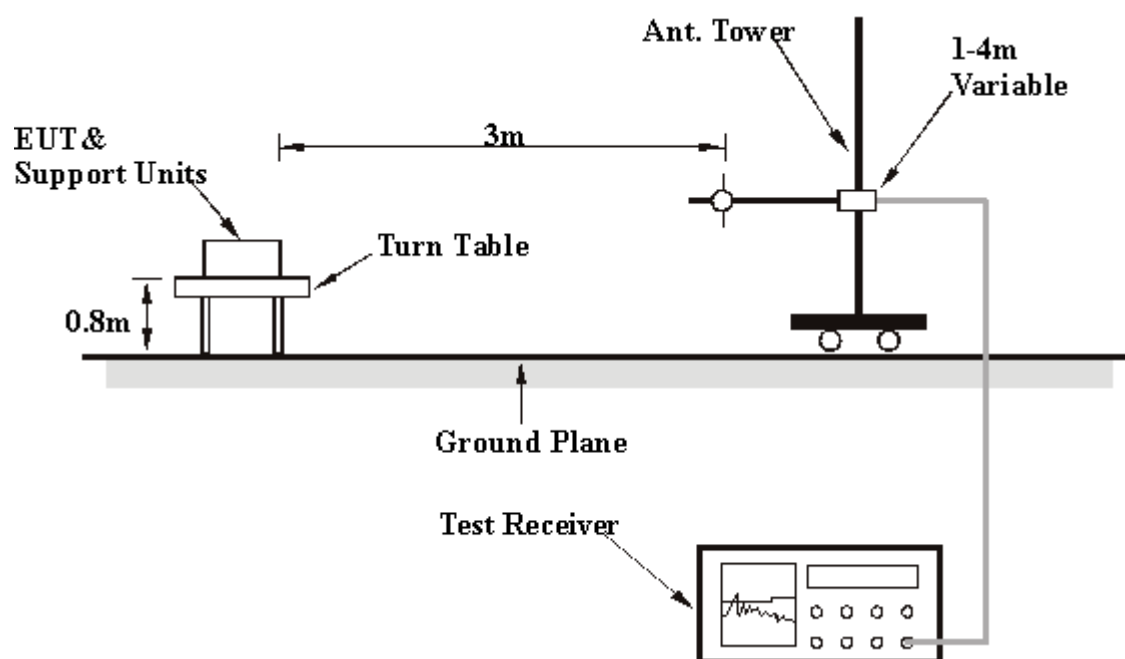

For the actual test configuration, please refer to the related item – Photographs of the Test Configuration.

EUT OPERATING CONDITIONS

Same as 4.1.6

TEST RESULTS

Below 1GHz Worst-Case Data

EUT TEST CONDITION		MEASUREMENT DETAIL	
CHANNEL	Channel 11	FREQUENCY RANGE	Below 1000MHz
MODULATION TYPE	BPSK	DETECTOR FUNCTION	Quasi-Peak
TRANSFER RATE	6Mbps	ENVIRONMENTAL CONDITIONS	25deg. C, 68%RH, 991hPa
TESTED BY	Morgan Chen	INPUT POWER (SYSTEM)	120Vac, 60 Hz

ANTENNA POLARITY & TEST DISTANCE: HORIZONTAL AT 3 M								
No.	Freq. (MHz)	Emission Level (dBuV/m)	Limit (dBuV/m)	Margin (dB)	Antenna Height (m)	Table Angle (Degree)	Raw Value (dBuV)	Correction Factor (dB/m)
1	245.77	31.84 QP	46.00	-14.16	1.50 H	301	19.30	12.54
2	527.64	28.10 QP	46.00	-17.90	1.25 H	319	7.14	20.96
3	620.94	29.96 QP	46.00	-16.04	1.25 H	148	6.64	23.32
4	624.83	28.92 QP	46.00	-17.08	1.50 H	307	5.57	23.35
5	675.37	29.14 QP	46.00	-16.86	1.50 H	301	5.21	23.93
6	720.08	29.31 QP	46.00	-16.69	1.25 H	148	4.21	25.10
7	729.80	28.83 QP	46.00	-17.17	1.25 H	223	3.34	25.49
8	768.68	29.01 QP	46.00	-16.99	1.00 H	235	2.58	26.43
9	799.78	28.02 QP	46.00	-17.98	1.00 H	235	1.35	26.67
10	828.94	29.83 QP	46.00	-16.17	1.50 H	301	2.89	26.94
11	881.42	30.03 QP	46.00	-15.97	1.50 H	238	2.62	27.41
12	912.53	28.99 QP	46.00	-17.01	1.50 H	238	1.22	27.77

ANTENNA POLARITY & TEST DISTANCE: VERTICAL AT 3 M								
No.	Freq. (MHz)	Emission Level (dBuV/m)	Limit (dBuV/m)	Margin (dB)	Antenna Height (m)	Table Angle (Degree)	Raw Value (dBuV)	Correction Factor (dB/m)
1	432.38	32.60 QP	46.00	-13.40	1.00 V	340	13.73	18.87
2	527.64	33.11 QP	46.00	-12.89	1.25 V	103	12.15	20.96
3	566.51	33.42 QP	46.00	-12.58	1.00 V	187	11.47	21.95
4	624.83	36.95 QP	46.00	-9.05	1.00 V	91	13.60	23.35
5	675.37	32.72 QP	46.00	-13.28	1.25 V	142	8.79	23.93
6	766.73	32.22 QP	46.00	-13.78	1.00 V	205	5.81	26.42
7	912.53	32.37 QP	46.00	-13.63	1.00 V	88	4.60	27.77

- REMARKS:**
1. Emission level(dBuV/m)=Raw Value(dBuV) + Correction Factor(dB/m)
 2. Correction Factor(dB/m) = Antenna Factor (dB/m) + Cable Factor (dB)
 3. The other emission levels were very low against the limit.
 4. Margin value = Emission level – Limit value.

802.11b DSSS modulation

EUT TEST CONDITION		MEASUREMENT DETAIL	
CHANNEL	Channel 1	FREQUENCY RANGE	1 ~ 25GHz
MODULATION TYPE	DBPSK	DETECTOR FUNCTION	Peak(PK) Average (AV)
TRANSFER RATE	1Mbps	ENVIRONMENTAL CONDITIONS	25deg. C, 68%RH, 991hPa
TESTED BY	Morgan Chen	INPUT POWER (SYSTEM)	120Vac, 60 Hz

ANTENNA POLARITY & TEST DISTANCE: HORIZONTAL AT 3 M								
No.	Freq. (MHz)	Emission Level (dBuV/m)	Limit (dBuV/m)	Margin (dB)	Antenna Height (m)	Table Angle (Degree)	Raw Value (dBuV)	Correction Factor (dB/m)
1	2390.00	53.12 PK	74.00	-20.88	1.46 H	355	21.21	31.91
1	2390.00	44.75 AV	54.00	-9.25	1.46 H	355	12.84	31.91
2	*2412.00	104.44 PK			1.46 H	359	72.40	32.04
2	*2412.00	100.89 AV			1.46 H	359	68.85	32.04
3	4824.00	45.82 PK	74.00	-28.18	1.05 H	28	8.31	37.51
3	4824.00	34.11 AV	54.00	-19.89	1.05 H	28	-3.40	37.51

ANTENNA POLARITY & TEST DISTANCE: VERTICAL AT 3 M								
No.	Freq. (MHz)	Emission Level (dBuV/m)	Limit (dBuV/m)	Margin (dB)	Antenna Height (m)	Table Angle (Degree)	Raw Value (dBuV)	Correction Factor (dB/m)
1	2390.00	53.91 PK	74.00	-20.09	1.39 V	128	22.00	31.91
1	2390.00	44.62 AV	54.00	-9.38	1.39 V	128	12.71	31.91
2	*2412.00	102.32 PK			1.39 V	127	70.28	32.04
2	*2412.00	98.72 AV			1.39 V	127	66.68	32.04
3	4824.00	45.75 PK	74.00	-28.25	1.05 V	2	8.24	37.51
3	4824.00	33.98 AV	54.00	-20.02	1.05 V	2	-3.53	37.51

- REMARKS:**
1. Emission level(dBuV/m)=Raw Value(dBuV) + Correction Factor(dB/m)
 2. Correction Factor(dB/m) = Antenna Factor (dB/m) + Cable Factor (dB)
 3. The other emission levels were very low against the limit.
 4. Margin value = Emission level – Limit value.
 5. “ * “ : Fundamental frequency.

EUT TEST CONDITION		MEASUREMENT DETAIL	
CHANNEL	Channel 6	FREQUENCY RANGE	1 ~ 25GHz
MODULATION TYPE	DBPSK	DETECTOR FUNCTION	Peak(PK) Average (AV)
TRANSFER RATE	1Mbps	ENVIRONMENTAL CONDITIONS	25deg. C, 68%RH, 991hPa
TESTED BY	Morgan Chen	INPUT POWER (SYSTEM)	120Vac, 60 Hz

ANTENNA POLARITY & TEST DISTANCE: HORIZONTAL AT 3 M								
No.	Freq. (MHz)	Emission Level (dBuV/m)	Limit (dBuV/m)	Margin (dB)	Antenna Height (m)	Table Angle (Degree)	Raw Value (dBuV)	Correction Factor (dB/m)
1	*2437.00	103.21 PK			1.46 H	176	71.01	32.20
1	*2437.00	99.45 AV			1.46 H	176	67.25	32.20
2	4874.00	46.25 PK	74.00	-27.75	1.00 H	15	8.70	37.55
2	4874.00	33.52 AV	54.00	-20.48	1.00 H	15	-4.03	37.55

ANTENNA POLARITY & TEST DISTANCE: VERTICAL AT 3 M								
No.	Freq. (MHz)	Emission Level (dBuV/m)	Limit (dBuV/m)	Margin (dB)	Antenna Height (m)	Table Angle (Degree)	Raw Value (dBuV)	Correction Factor (dB/m)
1	*2437.00	102.18 PK			1.44 V	122	69.98	32.20
1	*2437.00	98.63 AV			1.44 V	122	66.43	32.20
2	4824.00	45.95 PK	74.00	-28.05	1.20 V	98	8.44	37.51
2	4824.00	33.38 AV	54.00	-20.62	1.20 V	98	-4.13	37.51

- REMARKS:**
1. Emission level(dBuV/m)=Raw Value(dBuV) + Correction Factor(dB/m)
 2. Correction Factor(dB/m) = Antenna Factor (dB/m) + Cable Factor (dB)
 3. The other emission levels were very low against the limit.
 4. Margin value = Emission level – Limit value.
 5. " * " : Fundamental frequency.

EUT TEST CONDITION		MEASUREMENT DETAIL	
CHANNEL	Channel 11	FREQUENCY RANGE	1 ~ 25GHz
MODULATION TYPE	DBPSK	DETECTOR FUNCTION	Peak(PK) Average (AV)
TRANSFER RATE	1Mbps	ENVIRONMENTAL CONDITIONS	25deg. C, 68%RH, 991hPa
TESTED BY	Morgan Chen	INPUT POWER (SYSTEM)	120Vac, 60 Hz

ANTENNA POLARITY & TEST DISTANCE: HORIZONTAL AT 3 M								
No.	Freq. (MHz)	Emission Level (dBuV/m)	Limit (dBuV/m)	Margin (dB)	Antenna Height (m)	Table Angle (Degree)	Raw Value (dBuV)	Correction Factor (dB/m)
1	*2462.00	103.42 PK			1.48 H	189	71.07	32.35
1	*2462.00	99.95 AV			1.48 H	189	67.60	32.35
2	2487.00	54.32 PK	74.00	-19.68	1.32 H	189	21.81	32.51
2	2487.00	45.68 AV	54.00	-8.32	1.32 H	189	13.17	32.51
3	4924.00	45.52 PK	74.00	-28.48	1.08 H	19	7.94	37.58
3	4924.00	33.81 AV	54.00	-20.19	1.08 H	19	-3.77	37.58

ANTENNA POLARITY & TEST DISTANCE: VERTICAL AT 3 M								
No.	Freq. (MHz)	Emission Level (dBuV/m)	Limit (dBuV/m)	Margin (dB)	Antenna Height (m)	Table Angle (Degree)	Raw Value (dBuV)	Correction Factor (dB/m)
1	*2462.00	102.55 PK			1.39 V	110	70.20	32.35
1	*2462.00	98.92 AV			1.39 V	110	66.57	32.35
2	2487.00	55.65 PK	74.00	-18.35	1.35 V	108	23.14	32.51
2	2487.00	45.82 AV	54.00	-8.18	1.35 V	108	13.31	32.51
3	4924.00	47.11 PK	74.00	-26.89	1.38 V	16	9.53	37.58
3	4924.00	34.21 AV	54.00	-19.79	1.38 V	16	-3.37	37.58

- REMARKS:**
1. Emission level(dBuV/m)=Raw Value(dBuV) + Correction Factor(dB/m)
 2. Correction Factor(dB/m) = Antenna Factor (dB/m) + Cable Factor (dB)
 3. The other emission levels were very low against the limit.
 4. Margin value = Emission level – Limit value.
 5. “ * “ : Fundamental frequency.

802.11g OFDM modulation

EUT TEST CONDITION		MEASUREMENT DETAIL	
CHANNEL	Channel 1	FREQUENCY RANGE	1 ~ 25GHz
MODULATION TYPE	BPSK	DETECTOR FUNCTION	Peak(PK) Average (AV)
TRANSFER RATE	6Mbps	ENVIRONMENTAL CONDITIONS	25deg. C, 68%RH, 991hPa
TESTED BY	Morgan Chen	INPUT POWER (SYSTEM)	120Vac, 60 Hz

ANTENNA POLARITY & TEST DISTANCE: HORIZONTAL AT 3 M								
No.	Freq. (MHz)	Emission Level (dBuV/m)	Limit (dBuV/m)	Margin (dB)	Antenna Height (m)	Table Angle (Degree)	Raw Value (dBuV)	Correction Factor (dB/m)
1	2390.00	54.11 PK	74.00	-19.89	1.48 H	169	22.20	31.91
1	2390.00	45.85 AV	54.00	-8.15	1.48 H	169	13.94	31.91
2	*2412.00	103.75 PK			1.37 H	158	71.71	32.04
2	*2412.00	95.69 AV			1.37 H	158	63.65	32.04
3	4824.00	45.33 PK	74.00	-28.67	1.02 H	25	7.82	37.51
3	4824.00	34.39 AV	54.00	-19.61	1.02 H	25	-3.12	37.51

ANTENNA POLARITY & TEST DISTANCE: VERTICAL AT 3 M								
No.	Freq. (MHz)	Emission Level (dBuV/m)	Limit (dBuV/m)	Margin (dB)	Antenna Height (m)	Table Angle (Degree)	Raw Value (dBuV)	Correction Factor (dB/m)
1	2390.00	53.02 PK	74.00	-20.98	1.28 V	165	21.11	31.91
1	2390.00	44.65 AV	54.00	-9.35	1.28 V	165	12.74	31.91
2	*2412.00	102.35 PK			1.25 V	165	70.31	32.04
2	*2412.00	94.41 AV			1.25 V	165	62.37	32.04
3	4824.00	44.98 PK	74.00	-29.02	1.36 V	128	7.47	37.51
3	4824.00	33.65 AV	54.00	-20.35	1.36 V	128	-3.86	37.51

- REMARKS:**
1. Emission level(dBuV/m)=Raw Value(dBuV) + Correction Factor(dB/m)
 2. Correction Factor(dB/m) = Antenna Factor (dB/m) + Cable Factor (dB)
 3. The other emission levels were very low against the limit.
 4. Margin value = Emission level – Limit value.
 5. “ * “ : Fundamental frequency.



EUT TEST CONDITION		MEASUREMENT DETAIL	
CHANNEL	Channel 6	FREQUENCY RANGE	1 ~ 25GHz
MODULATION TYPE	BPSK	DETECTOR FUNCTION	Peak(PK) Average (AV)
TRANSFER RATE	6Mbps	ENVIRONMENTAL CONDITIONS	25deg. C, 68%RH, 991hPa
TESTED BY	Morgan Chen	INPUT POWER (SYSTEM)	120Vac, 60 Hz

ANTENNA POLARITY & TEST DISTANCE: HORIZONTAL AT 3 M								
No.	Freq. (MHz)	Emission Level (dBuV/m)	Limit (dBuV/m)	Margin (dB)	Antenna Height (m)	Table Angle (Degree)	Raw Value (dBuV)	Correction Factor (dB/m)
1	*2437.00	103.42 PK			1.38 H	145	71.22	32.20
1	*2437.00	95.55 AV			1.38 H	145	63.35	32.20
2	4874.00	44.71 PK	74.00	-29.29	1.35 H	126	7.16	37.55
2	4874.00	33.65 AV	54.00	-20.35	1.35 H	126	-3.90	37.55

ANTENNA POLARITY & TEST DISTANCE: VERTICAL AT 3 M								
No.	Freq. (MHz)	Emission Level (dBuV/m)	Limit (dBuV/m)	Margin (dB)	Antenna Height (m)	Table Angle (Degree)	Raw Value (dBuV)	Correction Factor (dB/m)
1	*2437.00	102.51 PK			1.32 V	165	70.31	32.20
1	*2437.00	94.67 AV			1.32 V	165	62.47	32.20
2	4874.00	44.95 PK	74.00	-29.05	1.30 V	125	7.40	37.55
2	4874.00	33.86 AV	54.00	-20.14	1.30 V	125	-3.69	37.55

- REMARKS:**
1. Emission level(dBuV/m)=Raw Value(dBuV) + Correction Factor(dB/m)
 2. Correction Factor(dB/m) = Antenna Factor (dB/m) + Cable Factor (dB)
 3. The other emission levels were very low against the limit.
 4. Margin value = Emission level – Limit value.
 5. " * " : Fundamental frequency.

EUT TEST CONDITION		MEASUREMENT DETAIL	
CHANNEL	Channel 11	FREQUENCY RANGE	1 ~ 25GHz
MODULATION TYPE	BPSK	DETECTOR FUNCTION	Peak(PK) Average (AV)
TRANSFER RATE	6Mbps	ENVIRONMENTAL CONDITIONS	25deg. C, 68%RH, 991hPa
TESTED BY	Morgan Chen	INPUT POWER (SYSTEM)	120Vac, 60 Hz

ANTENNA POLARITY & TEST DISTANCE: HORIZONTAL AT 3 M								
No.	Freq. (MHz)	Emission Level (dBuV/m)	Limit (dBuV/m)	Margin (dB)	Antenna Height (m)	Table Angle (Degree)	Raw Value (dBuV)	Correction Factor (dB/m)
1	*2462.00	103.68 PK			1.48 H	174	71.33	32.35
1	*2462.00	95.61 AV			1.48 H	174	63.26	32.35
2	2483.50	60.11 PK	74.00	-13.89	1.29 H	182	27.62	32.49
2	2483.50	47.12 AV	54.00	-6.88	1.29 H	182	14.63	32.49
3	4924.00	46.88 PK	74.00	-27.12	1.25 H	145	9.30	37.58
3	4924.00	33.52 AV	54.00	-20.48	1.25 H	145	-4.06	37.58

ANTENNA POLARITY & TEST DISTANCE: VERTICAL AT 3 M								
No.	Freq. (MHz)	Emission Level (dBuV/m)	Limit (dBuV/m)	Margin (dB)	Antenna Height (m)	Table Angle (Degree)	Raw Value (dBuV)	Correction Factor (dB/m)
1	*2462.00	102.65 PK			1.18 V	162	70.30	32.35
1	*2462.00	94.72 AV			1.18 V	162	62.37	32.35
2	2483.50	53.05 PK	74.00	-20.95	1.15 V	155	20.56	32.49
2	2483.50	44.96 AV	54.00	-9.04	1.15 V	155	12.47	32.49
3	4924.00	45.12 PK	74.00	-28.88	1.25 V	111	7.54	37.58
3	4924.00	33.98 AV	54.00	-20.02	1.25 V	111	-3.60	37.58

- REMARKS:**
1. Emission level(dBuV/m)=Raw Value(dBuV) + Correction Factor(dB/m)
 2. Correction Factor(dB/m) = Antenna Factor (dB/m) + Cable Factor (dB)
 3. The other emission levels were very low against the limit.
 4. Margin value = Emission level – Limit value.
 5. “ * “ : Fundamental frequency.



6dB BANDWIDTH MEASUREMENT

LIMITS OF 6dB BANDWIDTH MEASUREMENT

The minimum of 6dB Bandwidth Measurement is 0.5 MHz.

TEST INSTRUMENTS

Description & Manufacturer	Model No.	Serial No.	Calibrated Until
SPECTRUM ANALYZER	FSEK 30	100049	Aug. 14, 2006

NOTE: The calibration interval of the above test instruments is 12 months and the calibrations are traceable to NML/ROC and NIST/USA.

TEST PROCEDURE

The transmitter output was connected to the spectrum analyzer through an attenuator. The bandwidth of the fundamental frequency was measured by spectrum analyzer with 100kHz RBW and 100kHz VBW. The 6dB bandwidth is defined as the total spectrum the power of which is higher than peak power minus 6dB.

DEVIATION FROM TEST STANDARD

No deviation

TEST SETUP



EUT OPERATING CONDITIONS

The software provided by client to enable the EUT under transmission condition continuously at lowest, middle and highest channel frequencies individually.



TEST RESULTS

802.11b DSSS modulation

MODULATION TYPE	DBPSK	TRANSFER RATE	1Mbps
INPUT POWER (SYSTEM)	120Vac, 60 Hz	ENVIRONMENTAL CONDITIONS	25deg.C, 68%RH, 991hPa
TESTED BY	Morgan Chen		

CHANNEL	CHANNEL FREQUENCY (MHz)	6dB BANDWIDTH (MHz)	MINIMUM LIMIT (MHz)	PASS/FAIL
1	2412	9.56	0.5	PASS
6	2437	9.12	0.5	PASS
11	2462	9.08	0.5	PASS

CH 1

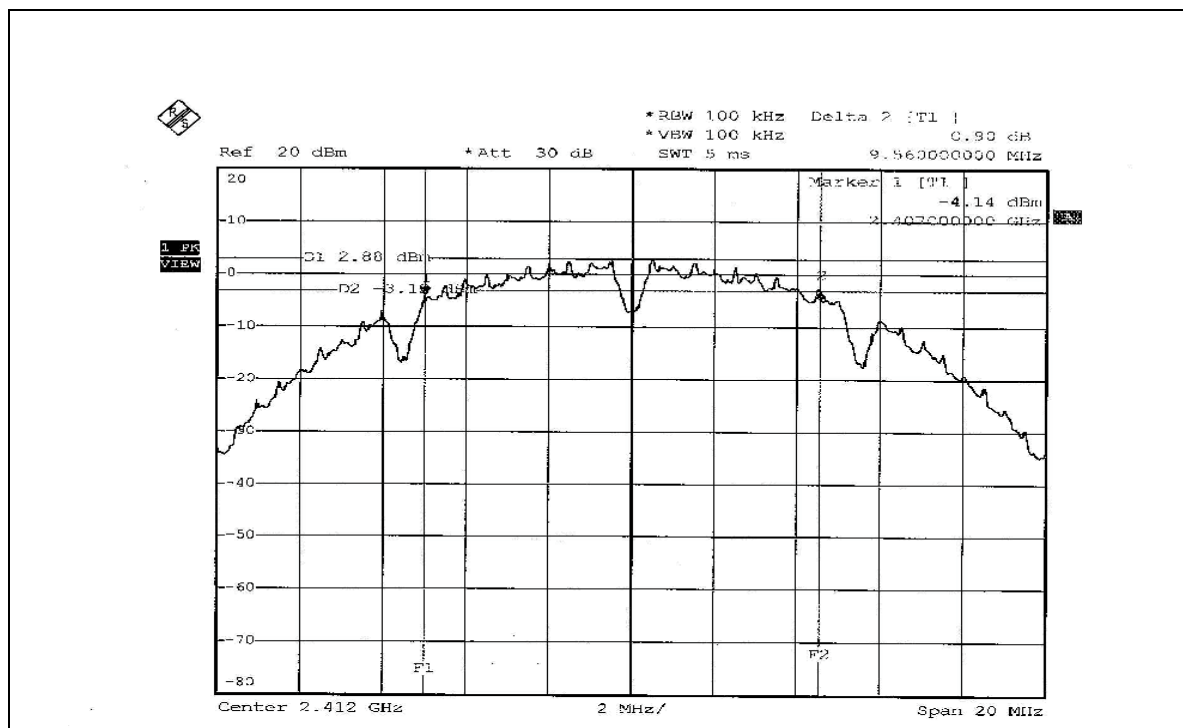

CH 6

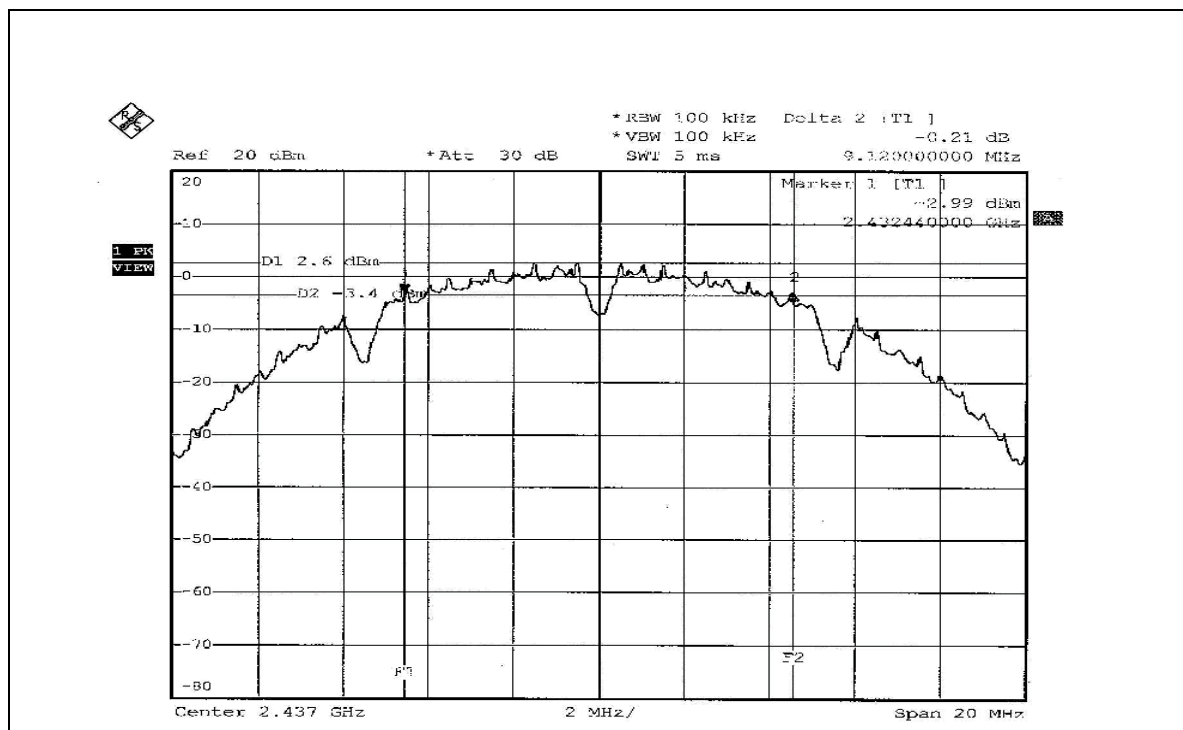

CH 11

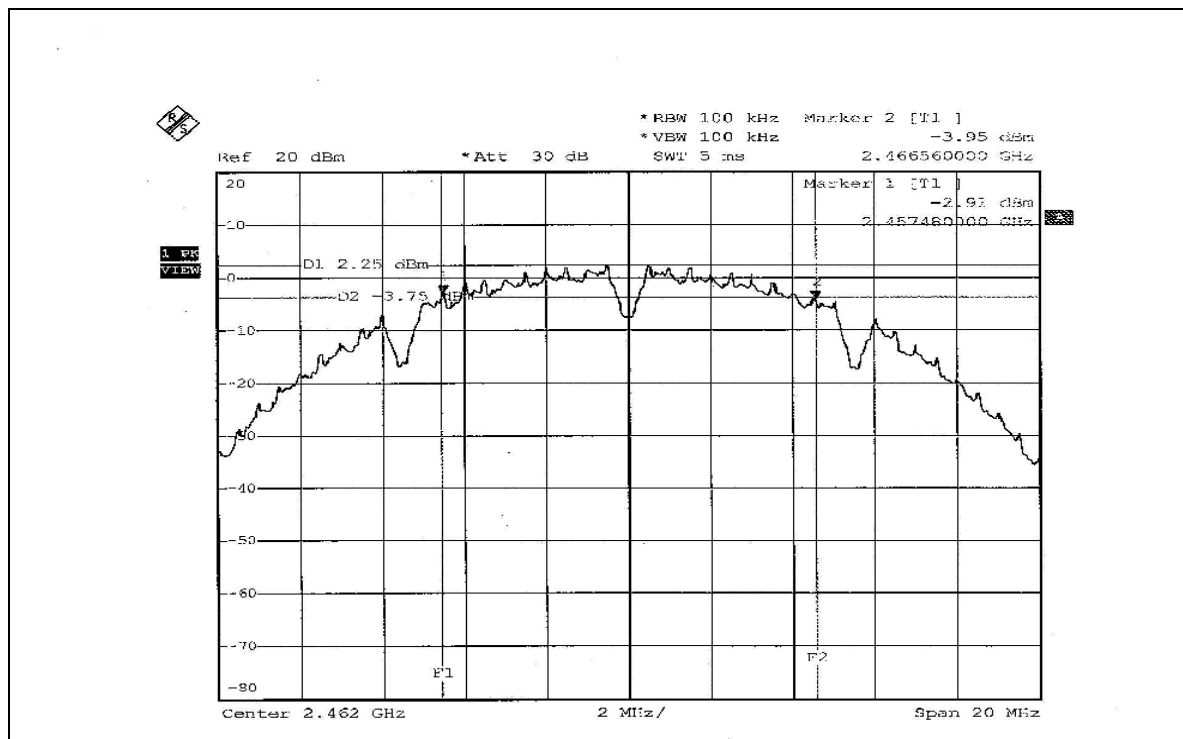



802.11g OFDM modulation

MODULATION TYPE	BPSK	TRANSFER RATE	6Mbps
INPUT POWER (SYSTEM)	120Vac, 60 Hz	ENVIRONMENTAL CONDITIONS	25deg.C, 68%RH, 991hPa
TESTED BY	Morgan Chen		

CHANNEL	CHANNEL FREQUENCY (MHz)	6dB BANDWIDTH (MHz)	MINIMUM LIMIT (MHz)	PASS/FAIL
1	2412	16.48	0.5	PASS
6	2437	16.52	0.5	PASS
11	2462	16.44	0.5	PASS

CH 1

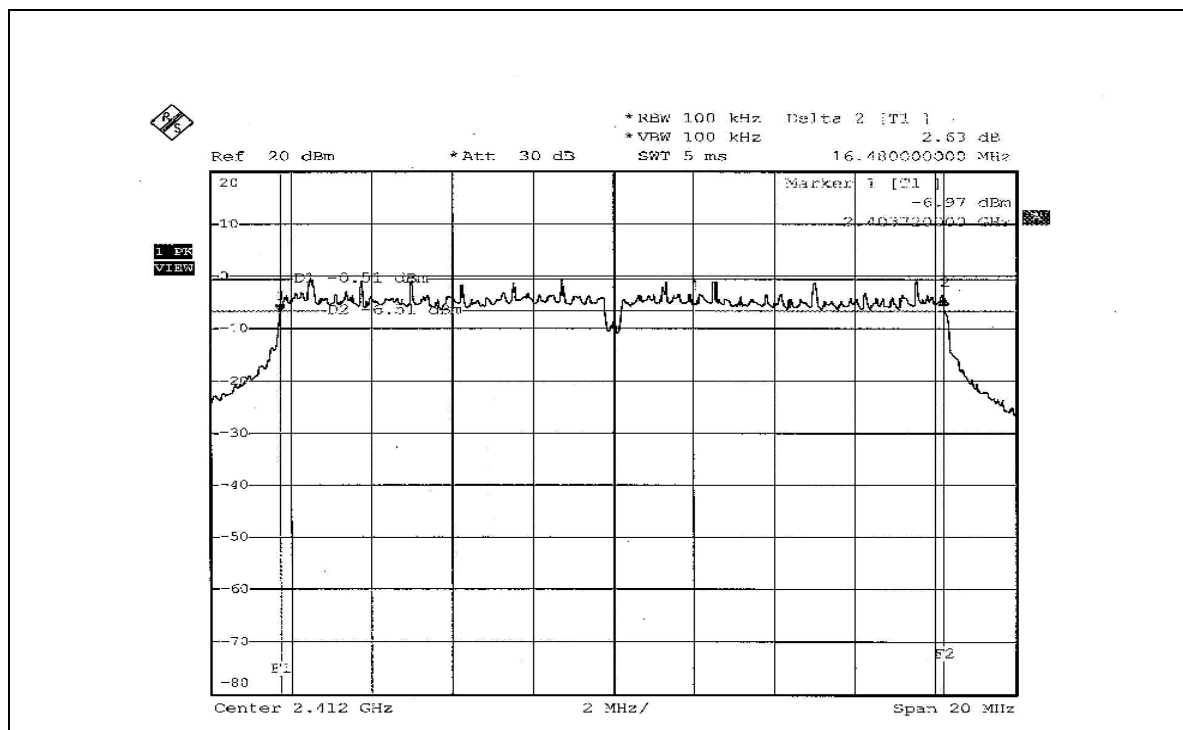

CH 6

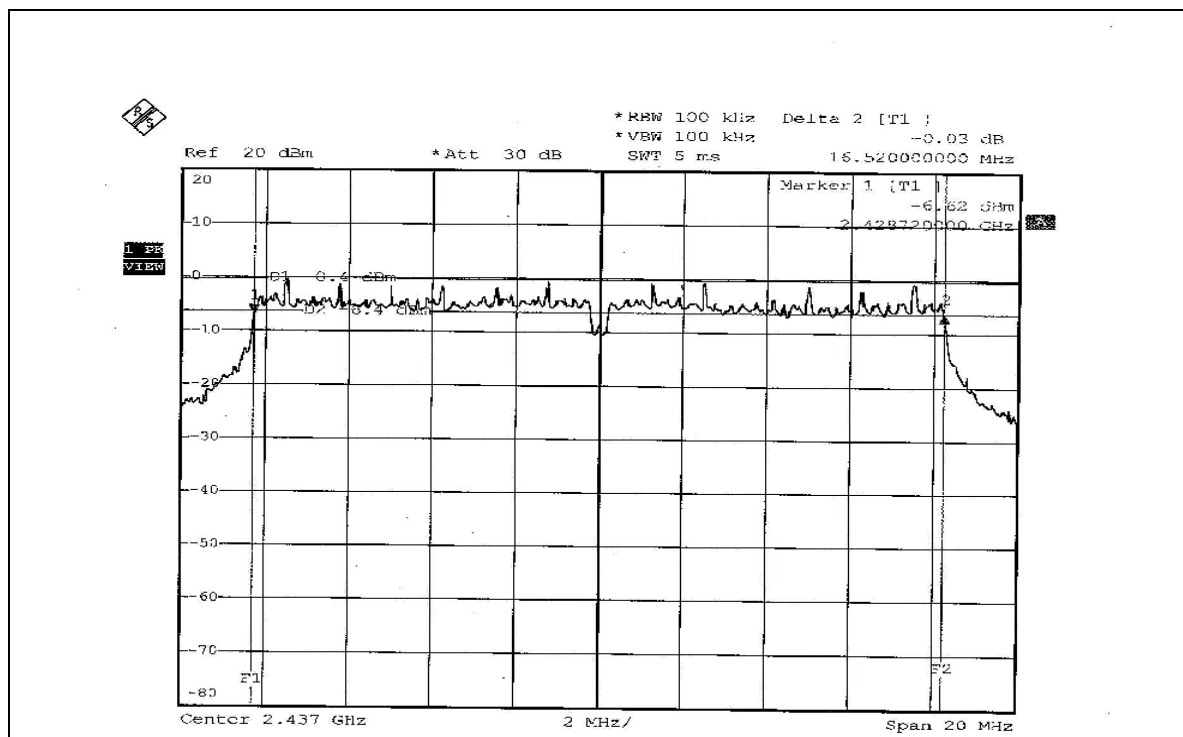

CH 11

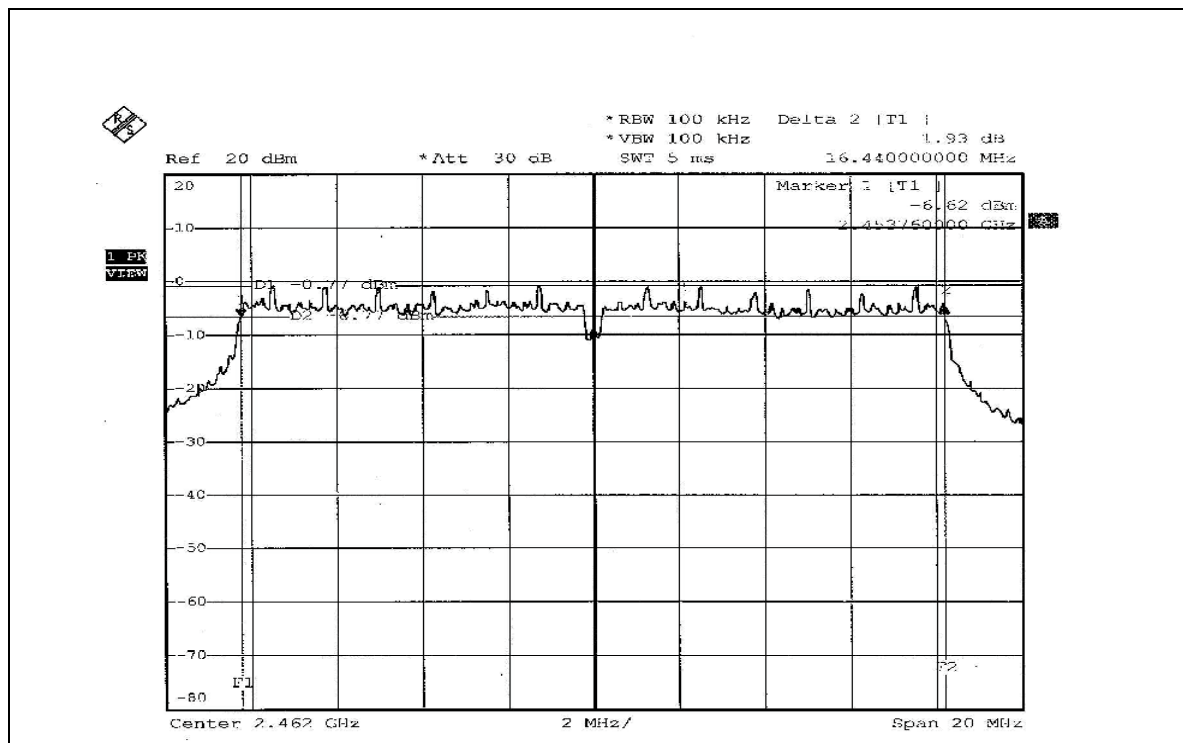



MAXIMUM PEAK OUTPUT POWER

LIMITS OF MAXIMUM PEAK OUTPUT POWER MEASUREMENT

The Maximum Peak Output Power Measurement is 30dBm.

INSTRUMENTS

Description & Manufacturer	Model No.	Serial No.	Calibrated Until
R&S SPECTRUM ANALYZER	FSEK30	100049	Aug. 14, 2006
AGILENT SIGNAL GENERATOR	E8257C	MY43320668	Dec. 30, 2006
TEKTRONIX OSCILLOSCOPE	TDS 1012	C019167	Jan. 16, 2007
NARDA DETECTOR	4503A	FSCM99899	NA

NOTE:

The calibration interval of the above test instruments is 12 months and the calibrations are traceable to NML/ROC and NIST/USA.

4.4.1 TEST PROCEDURES

1. A detector was used on the output port of the EUT. An oscilloscope was used to read the response of the detector.
2. Replaced the EUT by the signal generator. The center frequency of the S.G was adjusted to the center frequency of the measured channel.
3. Adjusted the power to have the same reading on oscilloscope. Record the power level.

4.4.2 DEVIATION FROM TEST STANDARD

No deviation

4.4.3 TEST SETUP



4.4.4 EUT OPERATING CONDITIONS

Same as Item 4.3.6



TEST RESULTS

802.11b DSSS modulation

MODULATION TYPE	DBPSK	TRANSFER RATE	1Mbps
INPUT POWER (SYSTEM)	120Vac, 60 Hz	ENVIRONMENTAL CONDITIONS	25deg.C, 68%RH, 991hPa
TESTED BY	Morgan Chen		

CHANNEL	CHANNEL FREQUENCY (MHz)	PEAK POWER OUTPUT (mW)	PEAK POWER OUTPUT (dBm)	PEAK POWER LIMIT (dBm)	PASS/FAIL
1	2412	40.179	16.04	30	PASS
6	2437	39.811	16.00	30	PASS
11	2462	40.087	16.03	30	PASS

802.11g OFDM modulation

MODULATION TYPE	BPSK	TRANSFER RATE	6Mbps
INPUT POWER (SYSTEM)	120Vac, 60 Hz	ENVIRONMENTAL CONDITIONS	25deg.C, 68%RH, 991hPa
TESTED BY	Morgan Chen		

CHANNEL	CHANNEL FREQUENCY (MHz)	PEAK POWER OUTPUT (mW)	PEAK POWER OUTPUT (dBm)	PEAK POWER LIMIT (dBm)	PASS/FAIL
1	2412	35.892	15.55	30	PASS
6	2437	35.975	15.56	30	PASS
11	2462	36.058	15.57	30	PASS



POWER SPECTRAL DENSITY MEASUREMENT

LIMITS OF POWER SPECTRAL DENSITY MEASUREMENT

The Maximum of Power Spectral Density Measurement is 8dBm.

TEST INSTRUMENTS

Description & Manufacturer	Model No.	Serial No.	Calibrated Until
R&S SPECTRUM ANALYZER	FSEK30	100049	Aug. 14, 2006

NOTE:

The calibration interval of the above test instruments is 12 months and the calibrations are traceable to NML/ROC and NIST/USA.

TEST PROCEDURE

The transmitter output was connected to the spectrum analyzer through an attenuator, the bandwidth of the fundamental frequency was measured with the spectrum analyzer using 3kHz RBW and 30kHz VBW, set sweep time = span/3kHz. The power spectral density was measured and recorded. The sweep time is allowed to be longer than span/3kHz for a full response of the mixer in the spectrum analyzer.

DEVIATION FROM TEST STANDARD

No deviation

TEST SETUP

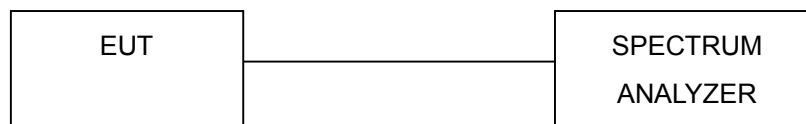

EUT OPERATING CONDITION

Same as Item 4.3.6



TEST RESULTS

802.11b DSSS modulation

MODULATION TYPE	DBPSK	TRANSFER RATE	1Mbps
INPUT POWER (SYSTEM)	120Vac, 60 Hz	ENVIRONMENTAL CONDITIONS	25deg.C, 68%RH, 991hPa
TESTED BY	Morgan Chen		

CHANNEL	CHANNEL FREQUENCY (MHz)	RF POWER LEVEL IN 3kHz BW (dBm)	MAXIMUM LIMIT (dBm)	PASS/FAIL
1	2412	-12.88	8	PASS
6	2437	-12.70	8	PASS
11	2462	-12.35	8	PASS

CH 1

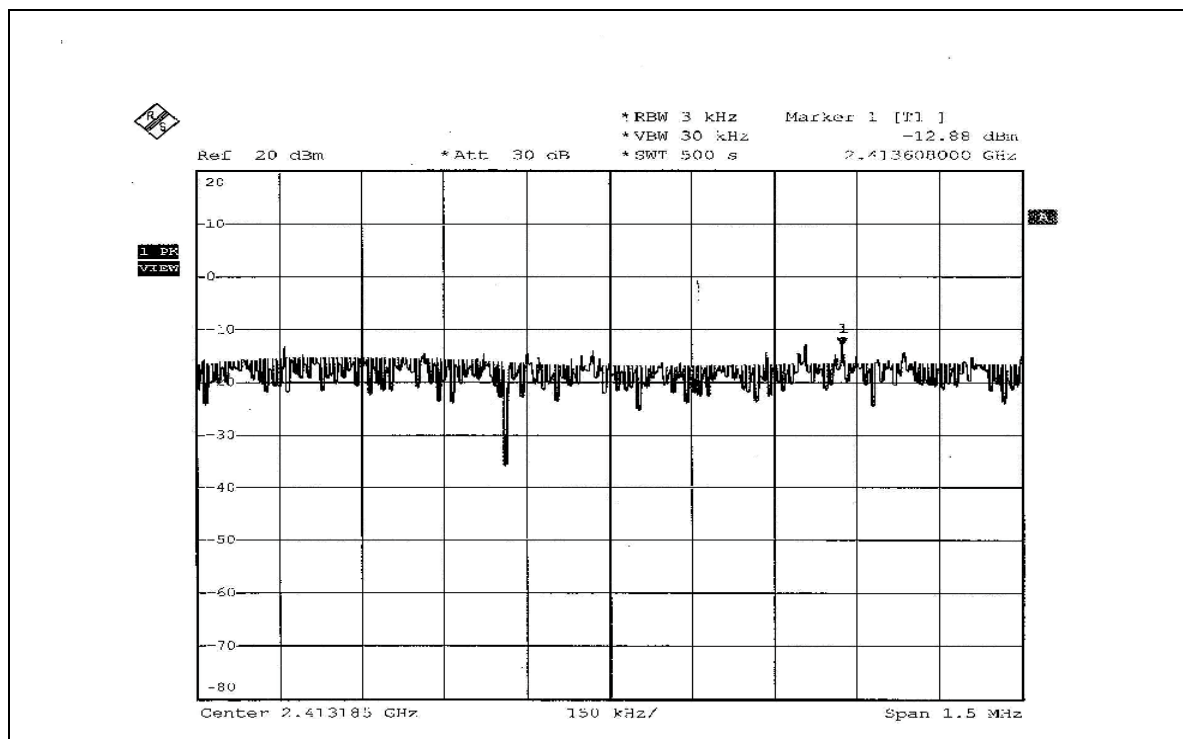

CH 6

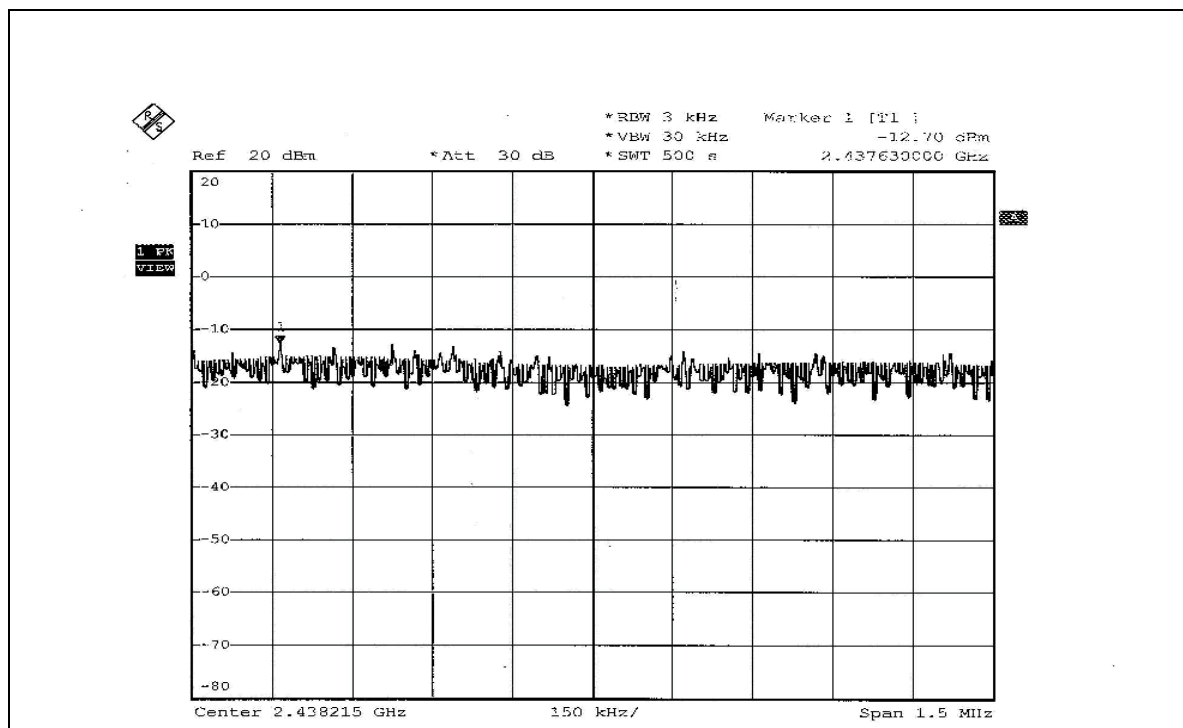

CH 11

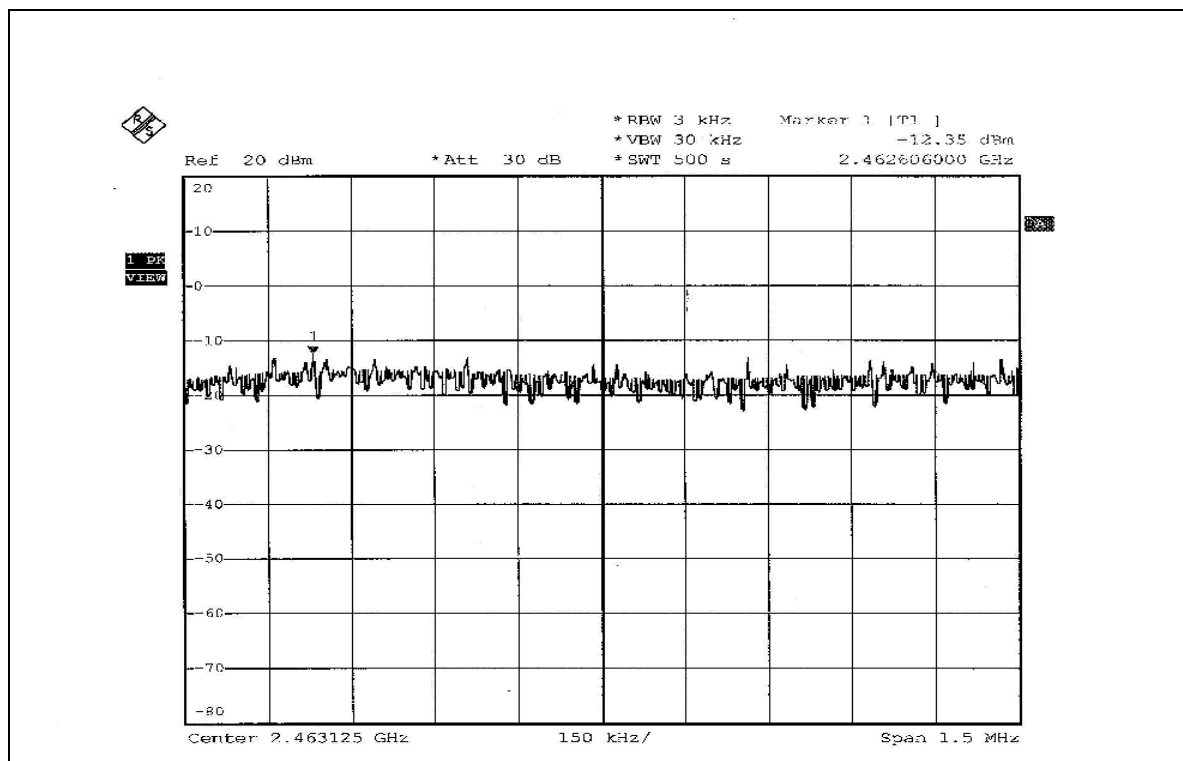



802.11g OFDM modulation

MODULATION TYPE	BPSK	TRANSFER RATE	6Mbps
INPUT POWER (SYSTEM)	120Vac, 60 Hz	ENVIRONMENTAL CONDITIONS	25deg.C, 68%RH, 991hPa
TESTED BY	Morgan Chen		

CHANNEL	CHANNEL FREQUENCY (MHz)	RF POWER LEVEL IN 3kHz BW (dBm)	MAXIMUM LIMIT (dBm)	PASS/FAIL
1	2412	-12.50	8	PASS
6	2437	-12.16	8	PASS
11	2462	-12.17	8	PASS

CH 11

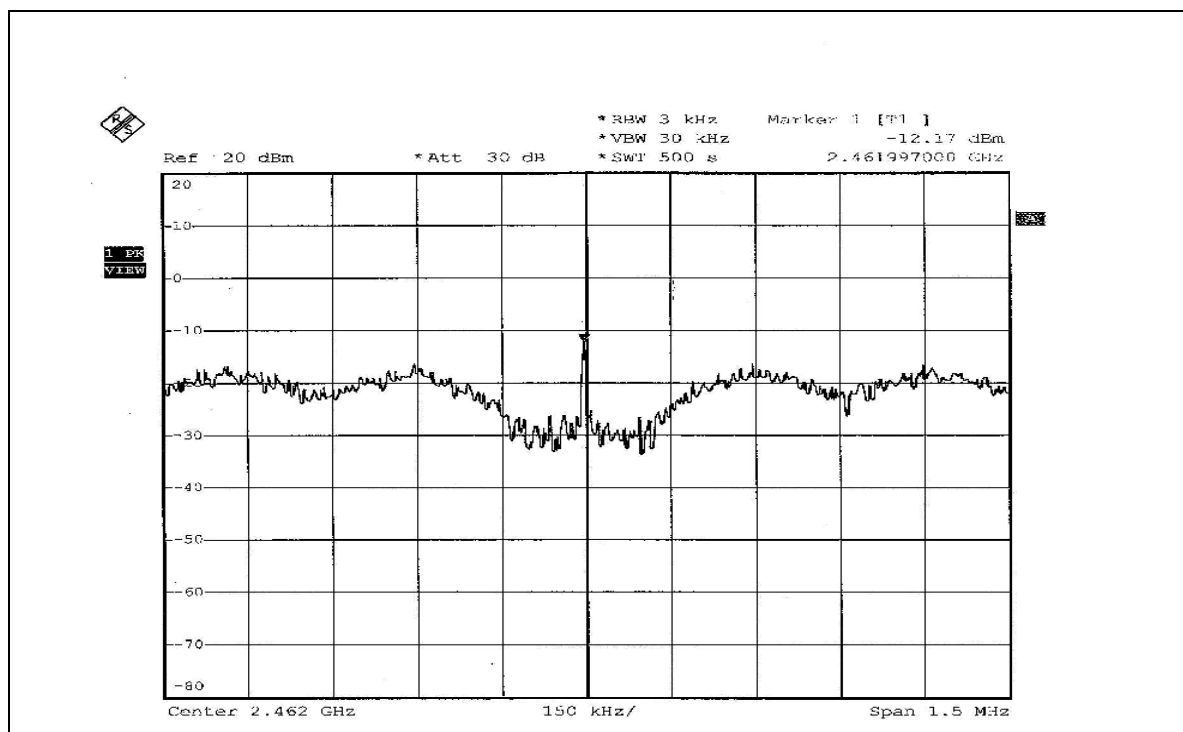



BAND EDGES MEASUREMENT

LIMITS OF BAND EDGES MEASUREMENT

Below -20dB of the highest emission level of operating band (in 100kHz Resolution Bandwidth).

TEST INSTRUMENTS

Description & Manufacturer	Model No.	Serial No.	Calibrated Until
R&S SPECTRUM ANALYZER	FSEK30	100049	Aug. 14, 2006

NOTE: The calibration interval of the above test instruments is 12 months and the calibrations are traceable to NML/ROC and NIST/USA.

TEST PROCEDURE

The transmitter output was connected to the spectrum analyzer via a low lose cable. Set both RBW and VBW of spectrum analyzer to 100kHz with suitable frequency span including 100 MHz bandwidth from band edge. The band edges was measured and recorded.

The spectrum plots (Peak RBW=VBW=100kHz; Average RBW=1MHz, VBW= 1kHz) are attached on the following pages.

DEVIATION FROM TEST STANDARD

No deviation

EUT OPERATING CONDITION

Same as Item 4.3.6



TEST RESULTS

The spectrum plots are attached on the following 12 images. D1 line indicates the highest level, and D2 line indicates the 20dB offset below D1. It shows compliance with the requirement in part 15.247(d).

802.11b DSSS modulation

NOTE 1: The band edge emission plot on the next page shows 50.60dBc between carrier maximum power and local maximum emission in restrict band (2.38404GHz). The emission of carrier strength list in the test result of channel 1 at the item 4.2.7 is 104.44dBuV/m (Peak), so the maximum field strength in restrict band is $104.44 - 50.60 = 53.84$ dBuV/m which is under 74dBuV/m limit.

The band edge emission plot of on the next page shows 57.33dBc between carrier maximum power and local maximum emission in restrict band (2.38720GHz). The emission of carrier strength list in the test result of channel 1 at the item 4.2.7 is 100.89dBuV/m (Average), so the maximum field strength in restrict band is $100.89 - 57.33 = 43.56$ dBuV/m which is under 54dBuV/m limit.

NOTE 2: The band edge emission plot on the next second page shows 50.15dBc between carrier maximum power and local maximum emission in restrict band (2.48802GHz). The emission of carrier strength list in the test result of channel 11 at the item 4.2.7 is 103.42dBuV/m (Peak), so the maximum field strength in restrict band is $103.42 - 50.15 = 53.27$ dBuV/m which is under 74dBuV/m limit.

The band edge emission plot on the next third page shows 58.52dBc between carrier maximum power and local maximum emission in restrict band (2.48682GHz). The emission of carrier strength list in the test result of channel 11 at the item 4.2.7 is 99.95dBuV/m (Average), so the maximum field strength in restrict band is $99.95 - 58.52 = 41.43$ dBuV/m which is under 54dBuV/m limit.

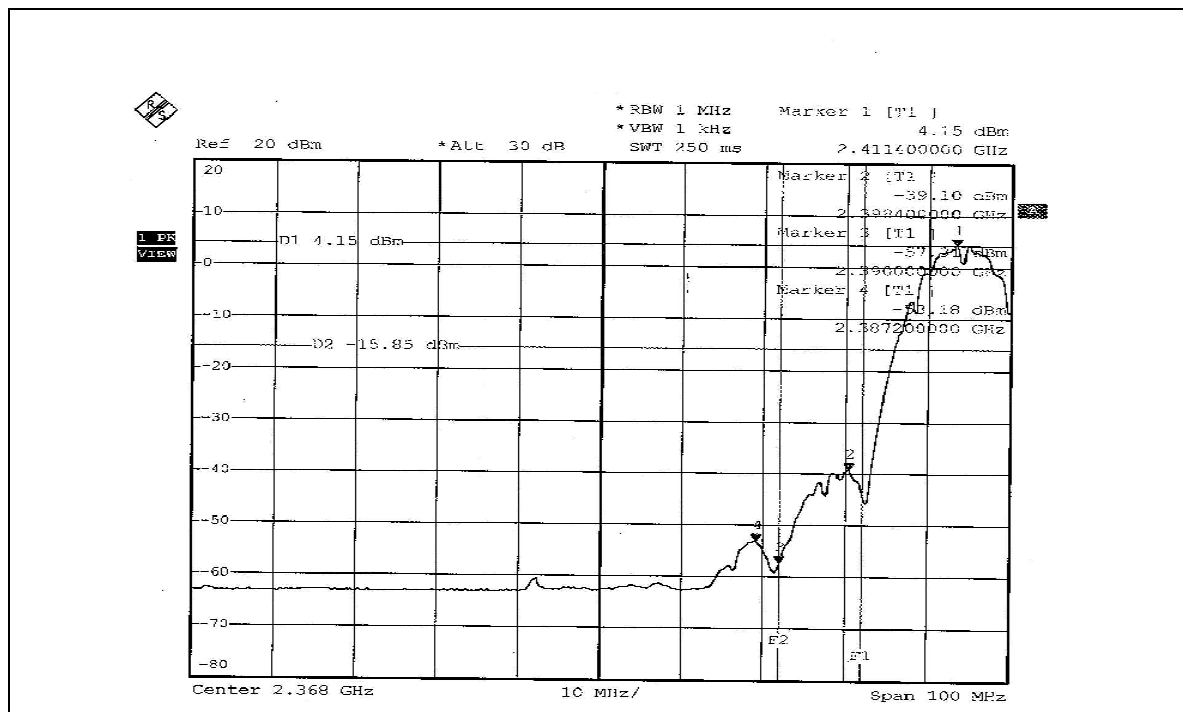
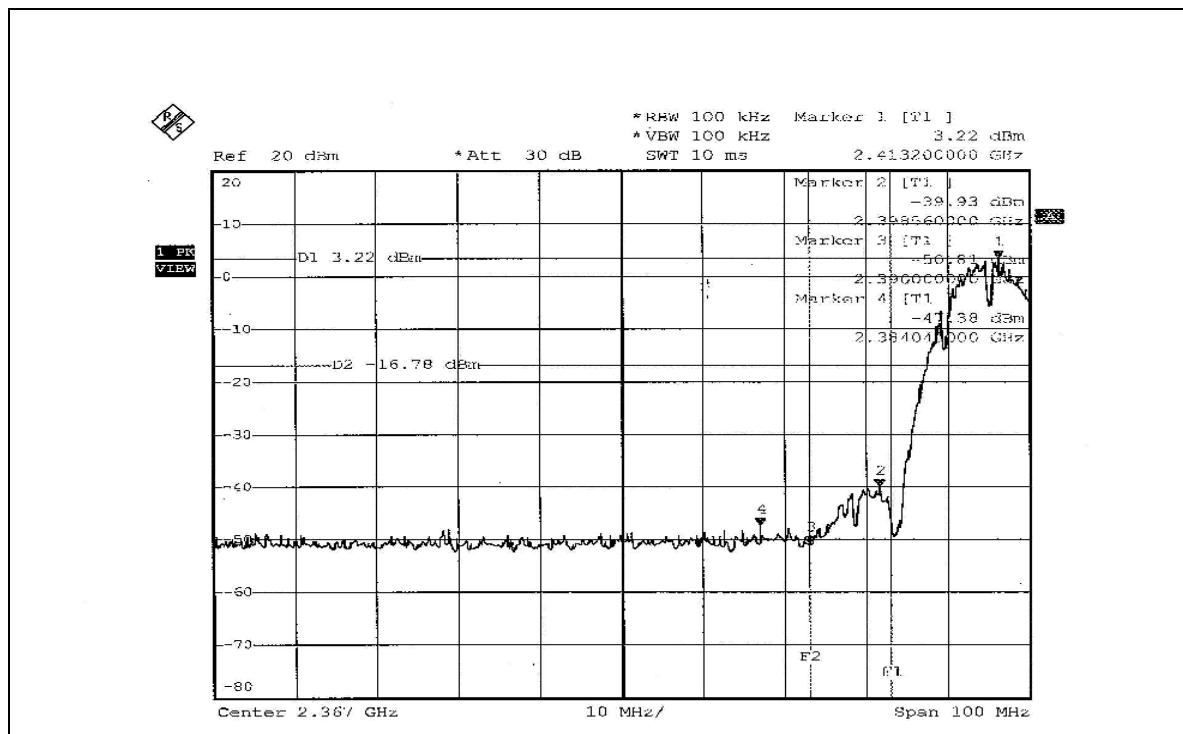

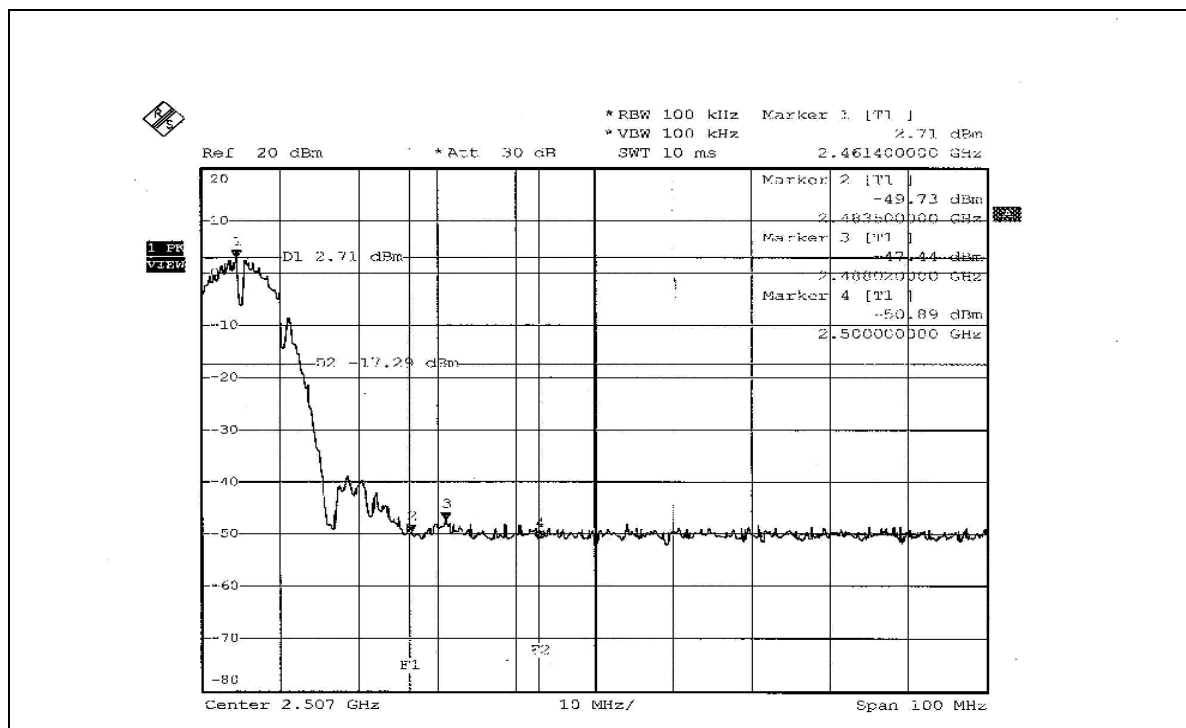
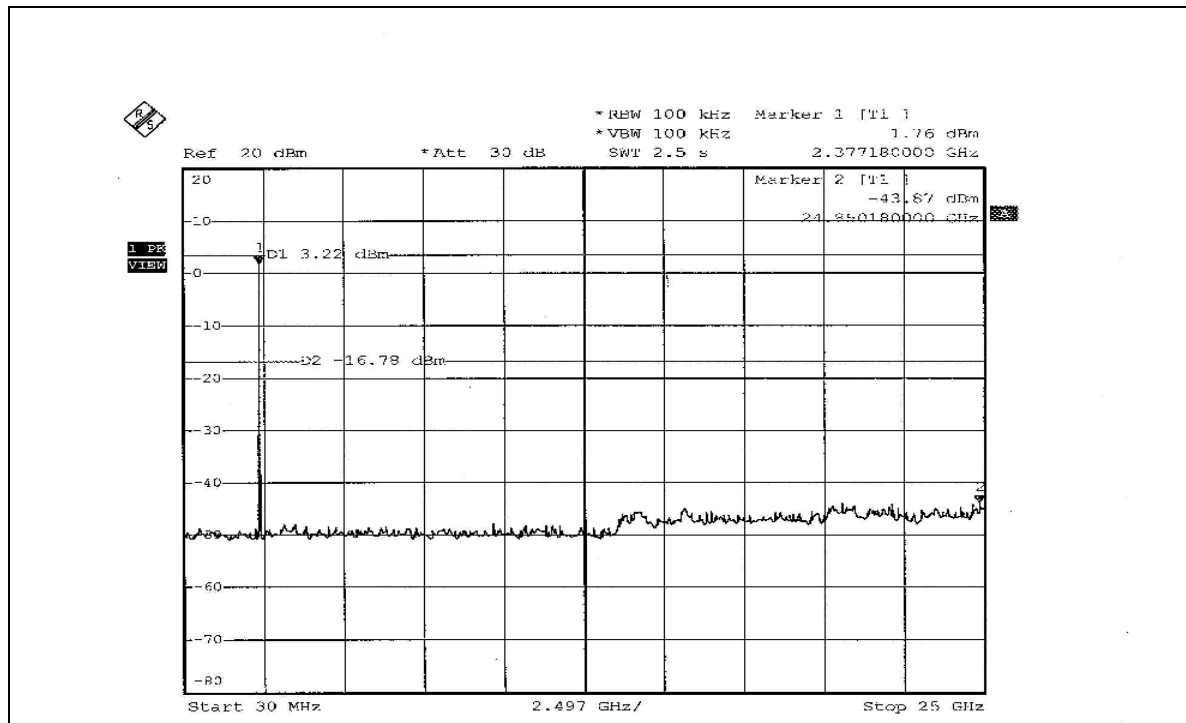

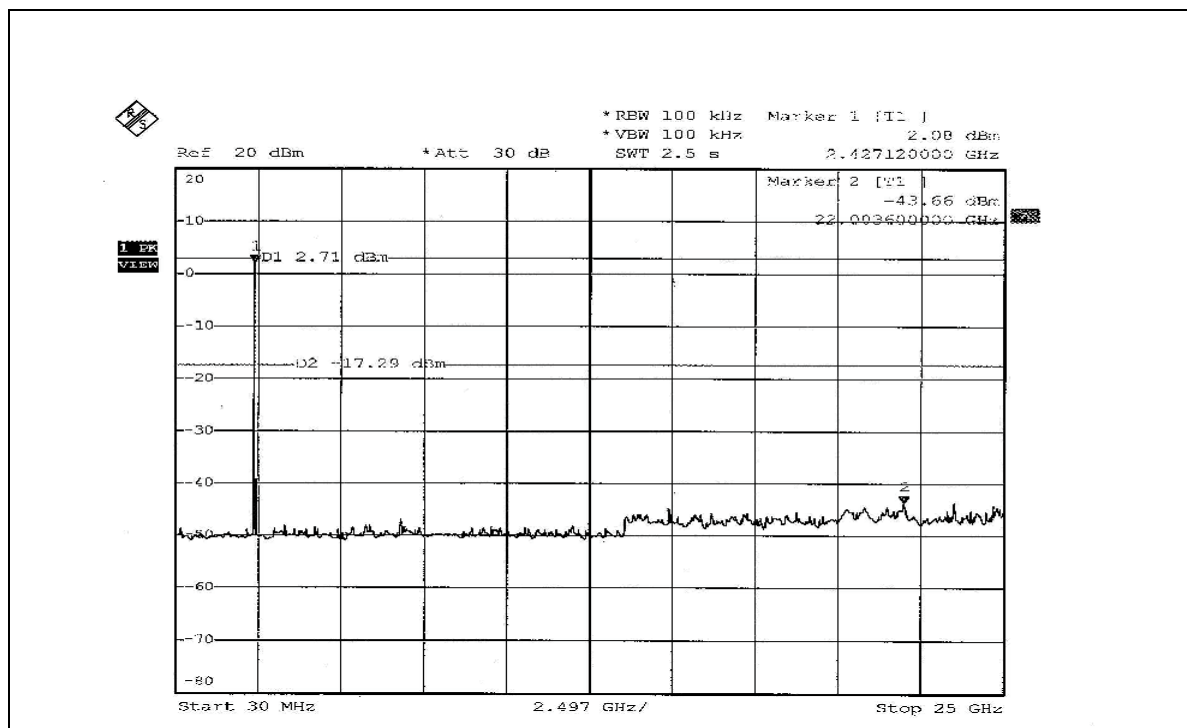
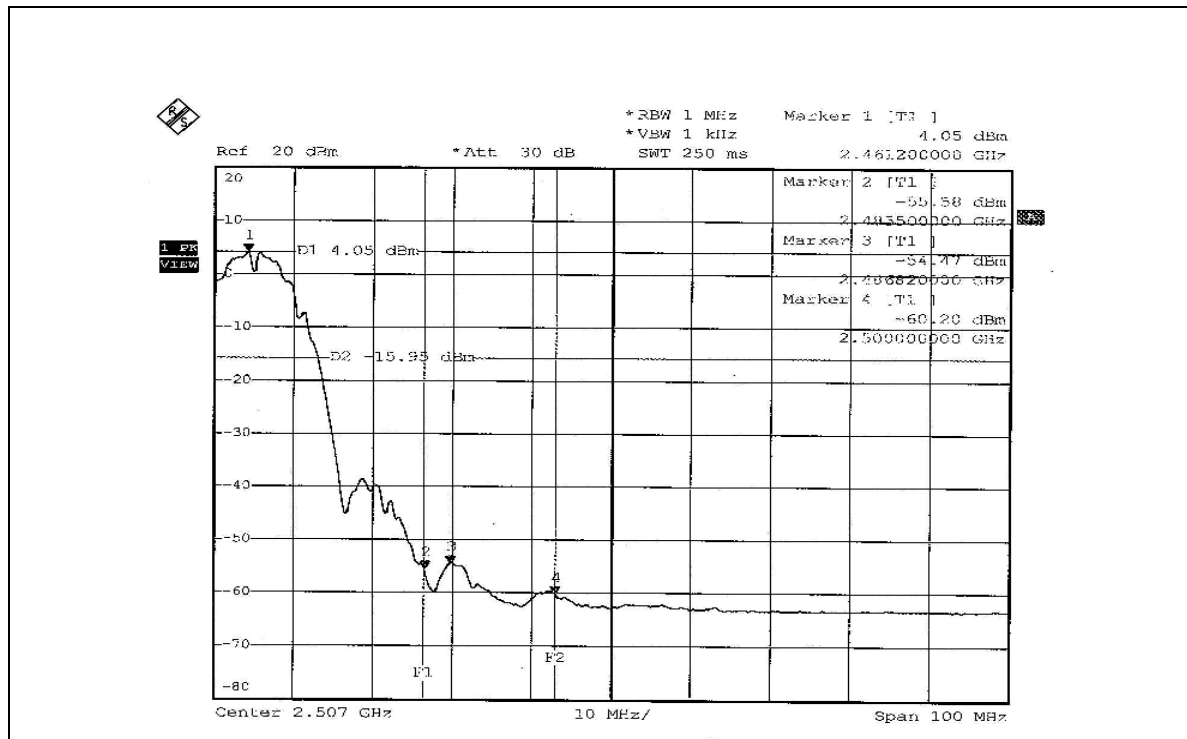

802.11g OFDM modulation

NOTE 1: The band edge emission plot on the next page shows 43.63dBc between carrier maximum power and local maximum emission in restrict band (2.3890GHz). The emission of carrier strength list in the test result of channel 1 at the item 4.2.7 is 103.75dBuV/m (Peak), so the maximum field strength in restrict band is $103.75-43.63=60.12$ dBuV/m which is under 74dBuV/m limit.

The band edge emission plot of on the next page shows 46.92dBc between carrier maximum power and local maximum emission in restrict band (2.3900GHz). The emission of carrier strength list in the test result of channel 1 at the item 4.2.7 is 95.69dBuV/m (Average), so the maximum field strength in restrict band is $95.69-46.92=48.77$ dBuV/m which is under 54dBuV/m limit.

NOTE 2: The band edge emission plot on the next second page shows 47.75dBc between carrier maximum power and local maximum emission in restrict band (2.4835GHz). The emission of carrier strength list in the test result of channel 11 at the item 4.2.7 is 103.68dBuV/m (Peak), so the maximum field strength in restrict band is $103.68-47.75=55.93$ dBuV/m which is under 74dBuV/m limit.

The band edge emission plot on the next third page shows 49.35dBc between carrier maximum power and local maximum emission in restrict band (2.4835GHz). The emission of carrier strength list in the test result of channel 11 at the item 4.2.7 is 95.61dBuV/m (Average), so the maximum field strength in restrict band is $95.61-49.35=46.26$ dBuV/m which is under 54dBuV/m limit.

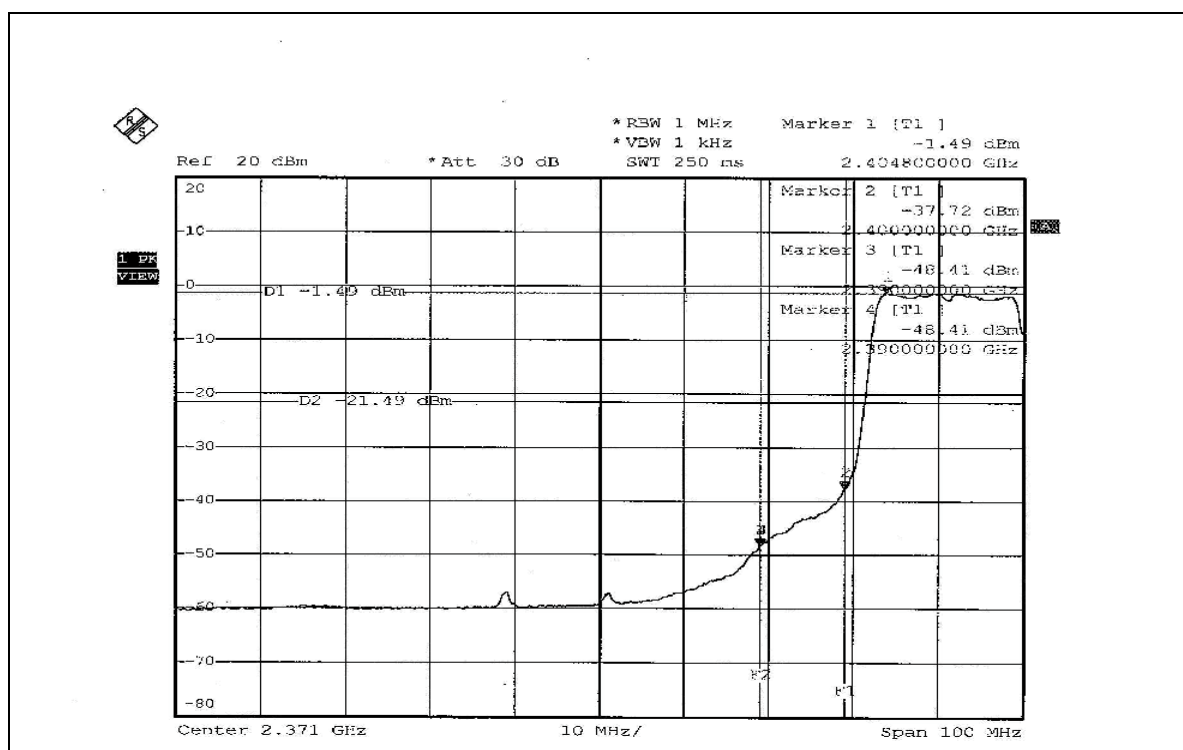
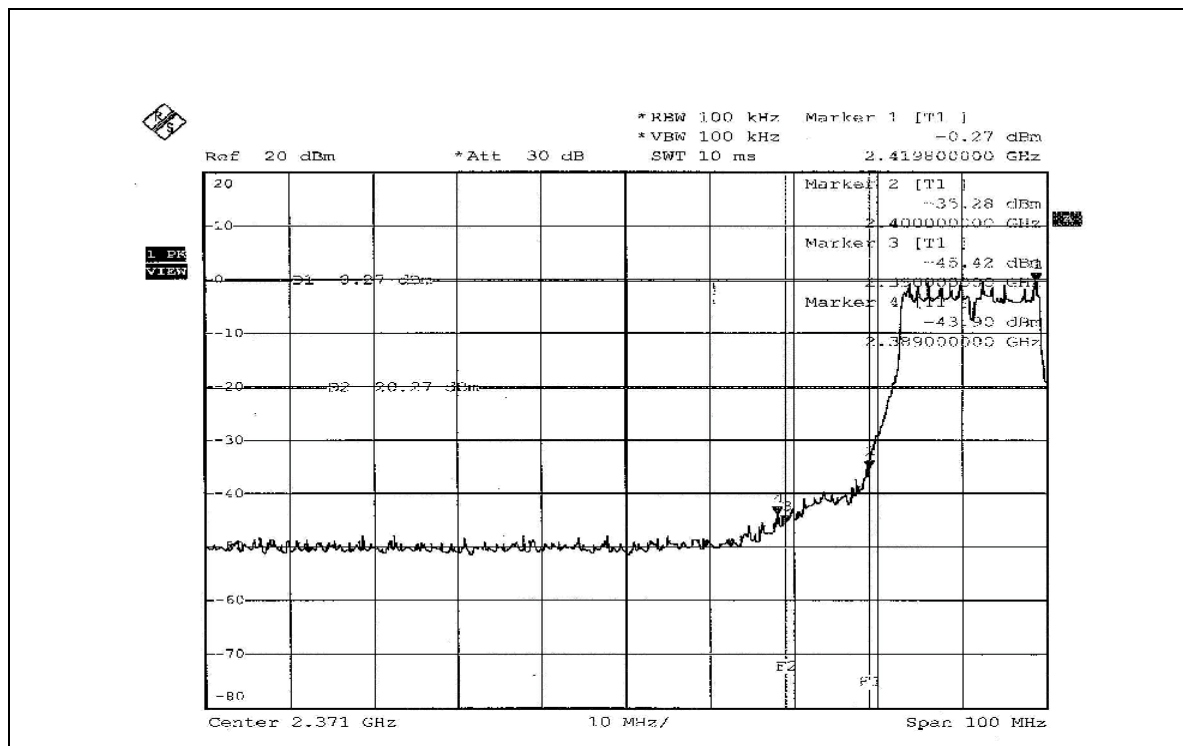

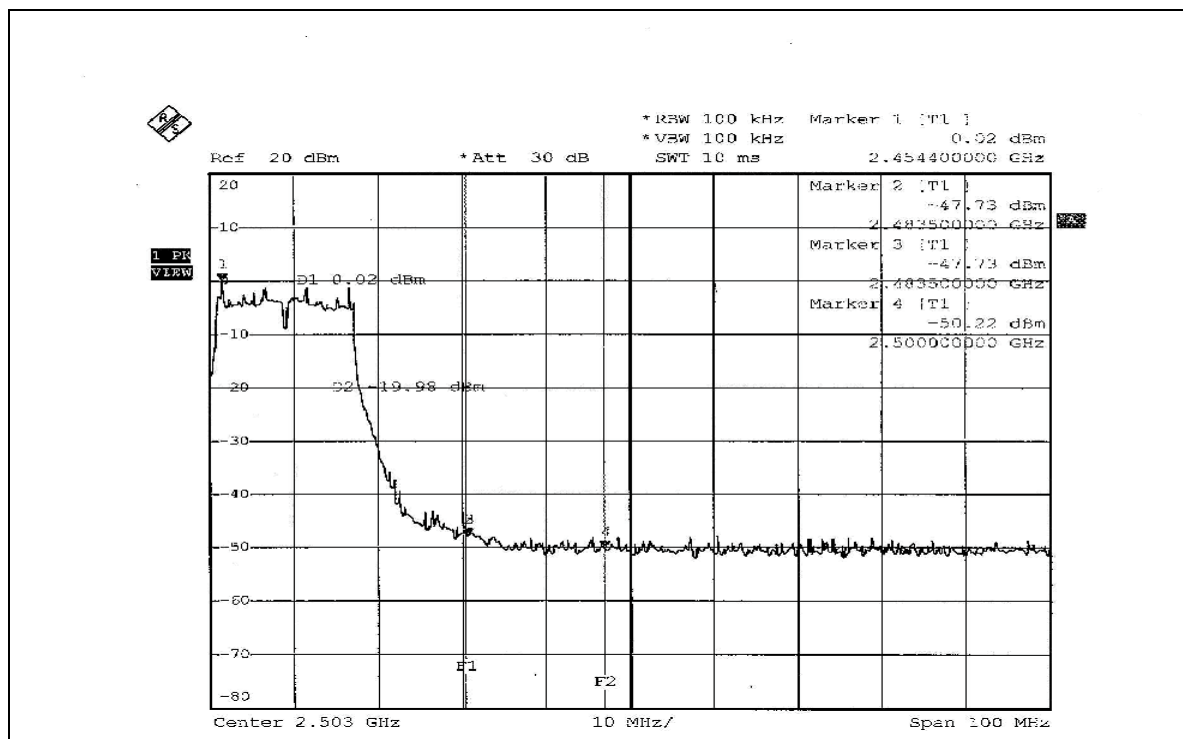
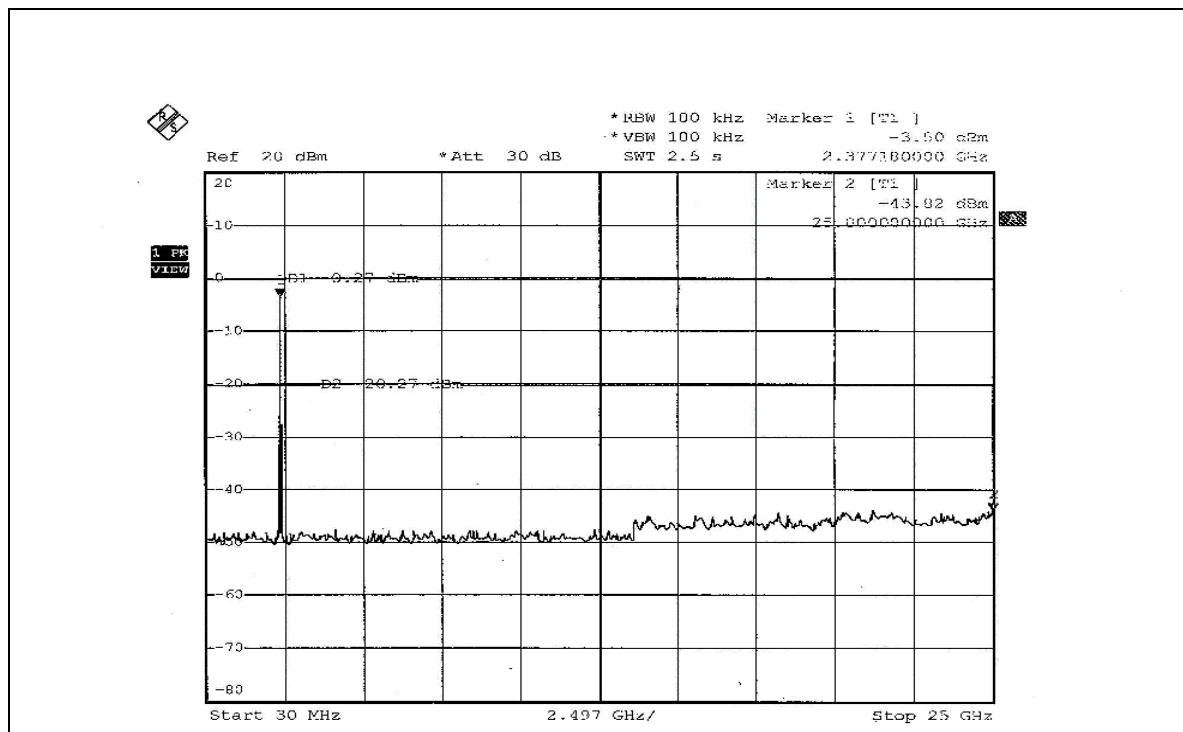

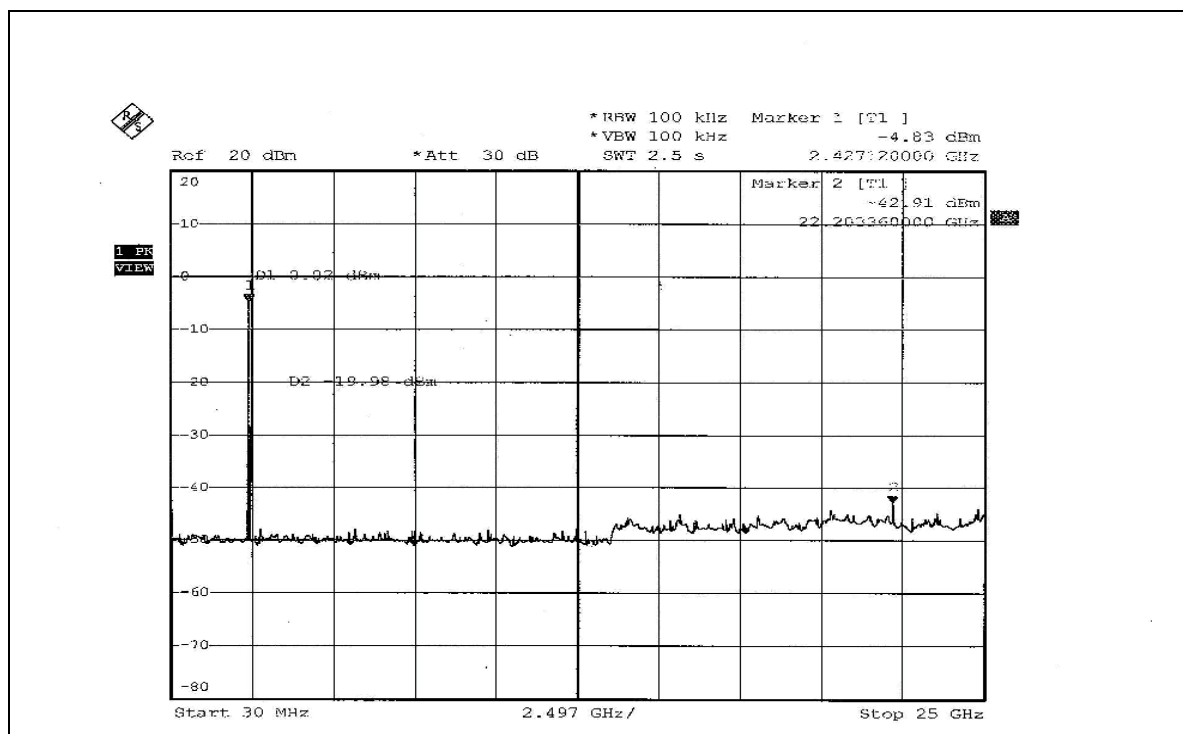
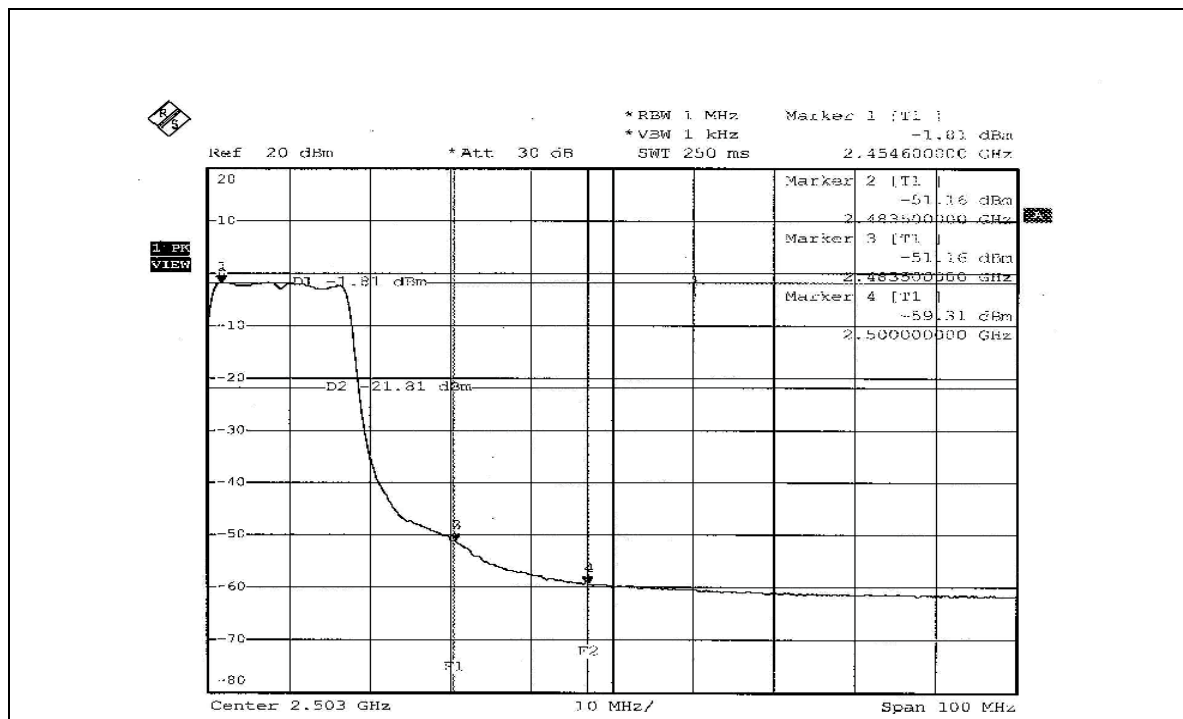



ANTENNA REQUIREMENT

STANDARD APPLICABLE

For intentional device, according to FCC 47 CFR Section 15.203, an intentional radiator shall be designed to ensure that no antenna other than that furnished by the responsible party shall be used with the device. And according to FCC 47 CFR Section 15.247 (b), if transmitting antennas of directional gain greater than 6dBi are used, the power shall be reduced by the amount in dB that the directional gain of the antenna exceeds 6dBi.

ANTENNA CONNECTED CONSTRUCTION

The antenna used in this product is PIFA antenna with UFL connector. The maximum Gain of the antenna is -1.09449dBi .



TEST TYPES AND RESULTS (FOR 802.11a 5745~5825MHz Band)

CONDUCTED EMISSION MEASUREMENT

LIMITS OF CONDUCTED EMISSION MEASUREMENT

FREQUENCY OF EMISSION (MHz)	CONDUCTED LIMIT (dB μ V)	
	Quasi-peak	Average
0.15-0.5	66 to 56	56 to 46
0.5-5	56	46
5-30	60	50

- NOTE:**
- The lower limit shall apply at the transition frequencies.
 - The limit decreases in line with the logarithm of the frequency in the range of 0.15 to 0.50 MHz.
 - All emanations from a class A/B digital device or system, including any network of conductors and apparatus connected thereto, shall not exceed the level of field strengths specified above.

TEST INSTRUMENTS

DESCRIPTION & MANUFACTURER	MODEL NO.	SERIAL NO.	CALIBRATED UNTIL
Test Receiver ROHDE & SCHWARZ	ESCS30	100291	Nov. 11, 2006
RF signal cable Woken	5D-FB	Cable-HYC01-01	Jan. 06, 2007
LISN ROHDE & SCHWARZ	ESH3-Z5	100312	Feb. 15, 2007
LISN ROHDE & SCHWARZ	ESH2-Z5	100104	Feb. 07, 2007
Software ADT	ADT_Cond_V3	NA	NA

- NOTE:**
- The calibration interval of the above test instruments is 12 months and the calibrations are traceable to NML/ROC and NIST/USA.
 - The test was performed in HwaYa Shielded Room 1.
 - The VCCI Site Registration No. is C-2040.

TEST PROCEDURES

- a. The EUT was placed 0.4 meters from the conducting wall of the shielded room with EUT being connected to the power mains through a line impedance stabilization network (LISN). Other support units were connected to the power mains through another LISN. The two LISNs provide 50 ohm/ 50uH of coupling impedance for the measuring instrument.
- b. Both lines of the power mains connected to the EUT were checked for maximum conducted interference.
- c. The frequency range from 150kHz to 30MHz was searched. Emission levels under (Limit – 20dB) was not recorded.

DEVIATION FROM TEST STANDARD

No deviation

TEST SETUP

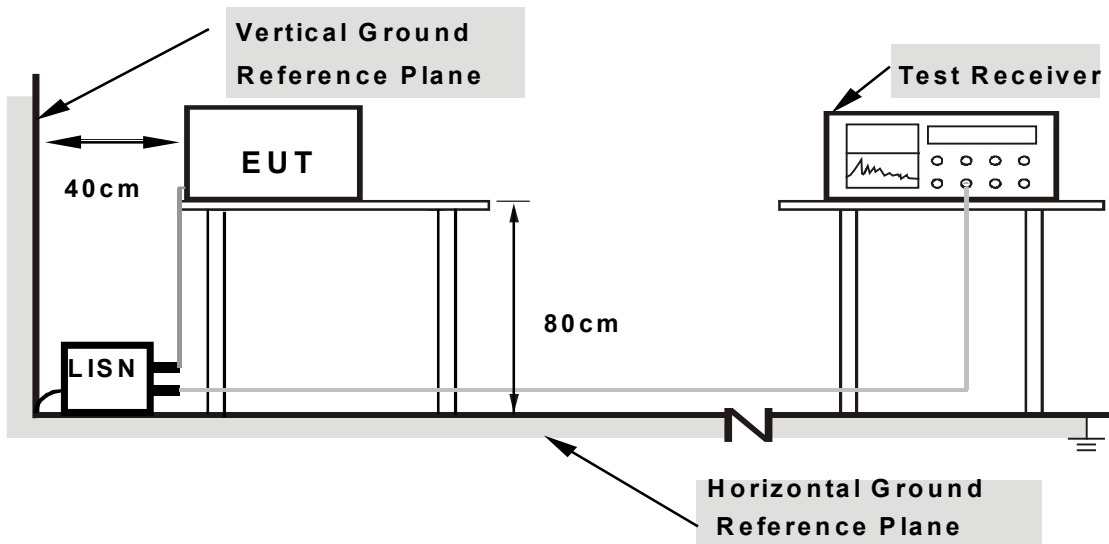

- Note:**
1. Support units were connected to second LISN.
 2. Both of LISNs (AMN) are 80 cm from EUT and at least 80 cm from other units and other metal planes

For the actual test configuration, please refer to the related item – Photographs of the Test Configuration.

3.1.1 EUT OPERATING CONDITIONS

Same as 4.1.6

TEST RESULTS

Conducted Worst-Case Data

EUT TEST CONDITION		MEASUREMENT DETAIL	
CHANNEL	Channel 5	PHASE	Line 1
MODULATION TYPE	BPSK	6dB BANDWIDTH	9 kHz
TRANSFER RATE	6Mbps	ENVIRONMENTAL CONDITIONS	20deg. C, 60%RH, 991hPa
TESTED BY	Match Tsui	INPUT POWER (SYSTEM)	120Vac, 60 Hz

No	Freq. [MHz]	Corr. Factor (dB)	Reading Value		Emission Level		Limit		Margin	
			[dB (uV)]		[dB (uV)]		[dB (uV)]		(dB)	
			Q.P.	AV.	Q.P.	AV.	Q.P.	AV.	Q.P.	AV.
1	0.189	0.10	40.01	-	40.11	-	64.08	54.08	-23.97	-
2	0.377	0.10	34.18	-	34.28	-	58.35	48.35	-24.07	-
3	0.443	0.11	34.31	-	34.42	-	57.01	47.01	-22.59	-
4	0.505	0.12	33.08	-	33.20	-	56.00	46.00	-22.80	-
5	4.285	0.47	27.74	-	28.21	-	56.00	46.00	-27.79	-
6	16.762	0.70	33.92	-	34.62	-	60.00	50.00	-25.38	-

- REMARKS:**
1. Q.P. and AV. are abbreviations of quasi-peak and average individually.
 2. "-": The Quasi-peak reading value also meets average limit and measurement with the average detector is unnecessary.
 3. The emission levels of other frequencies were very low against the limit.
 4. Margin value = Emission level - Limit value
 5. Correction factor = Insertion loss + Cable loss
 6. Emission Level = Correction Factor + Reading Value.

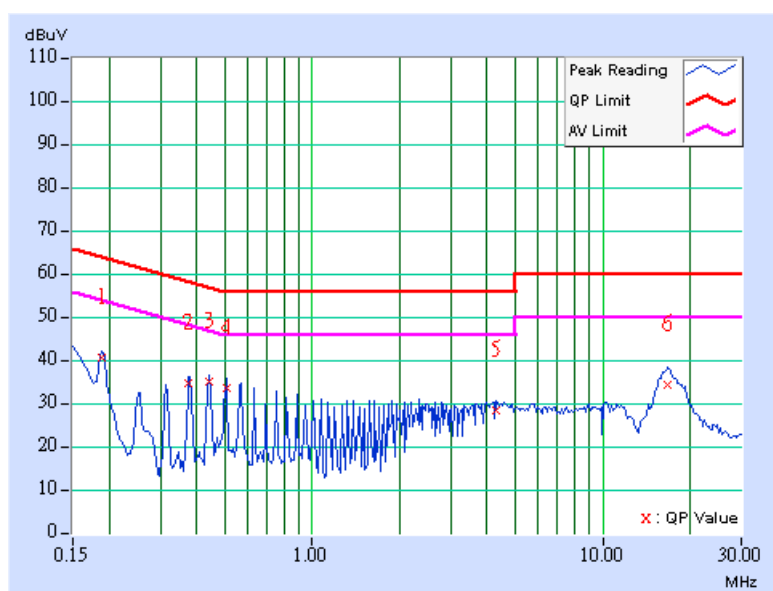

EUT TEST CONDITION		MEASUREMENT DETAIL	
CHANNEL	Channel 5	PHASE	Line 2
MODULATION TYPE	BPSK	6dB BANDWIDTH	9 kHz
TRANSFER RATE	6Mbps	ENVIRONMENTAL CONDITIONS	20deg. C, 60%RH, 991hPa
TESTED BY	Match Tsui	INPUT POWER (SYSTEM)	120Vac, 60 Hz

No	Freq. [MHz]	Corr. Factor (dB)	Reading Value		Emission Level		Limit		Margin	
			[dB (uV)]		[dB (uV)]		[dB (uV)]		(dB)	
			Q.P.	AV.	Q.P.	AV.	Q.P.	AV.	Q.P.	AV.
1	0.190	0.10	39.94	-	40.04	-	64.03	54.03	-23.99	-
2	0.380	0.10	35.39	-	35.49	-	58.27	48.27	-22.78	-
3	0.439	0.10	33.83	-	33.93	-	57.08	47.08	-23.15	-
4	0.564	0.10	30.91	-	31.01	-	56.00	46.00	-24.99	-
5	3.590	0.34	28.08	-	28.42	-	56.00	46.00	-27.58	-
6	16.824	0.57	33.44	-	34.01	-	60.00	50.00	-25.99	-

- REMARKS:**
1. Q.P. and AV. are abbreviations of quasi-peak and average individually.
 2. "-": The Quasi-peak reading value also meets average limit and measurement with the average detector is unnecessary.
 3. The emission levels of other frequencies were very low against the limit.
 4. Margin value = Emission level - Limit value
 5. Correction factor = Insertion loss + Cable loss
 6. Emission Level = Correction Factor + Reading Value.

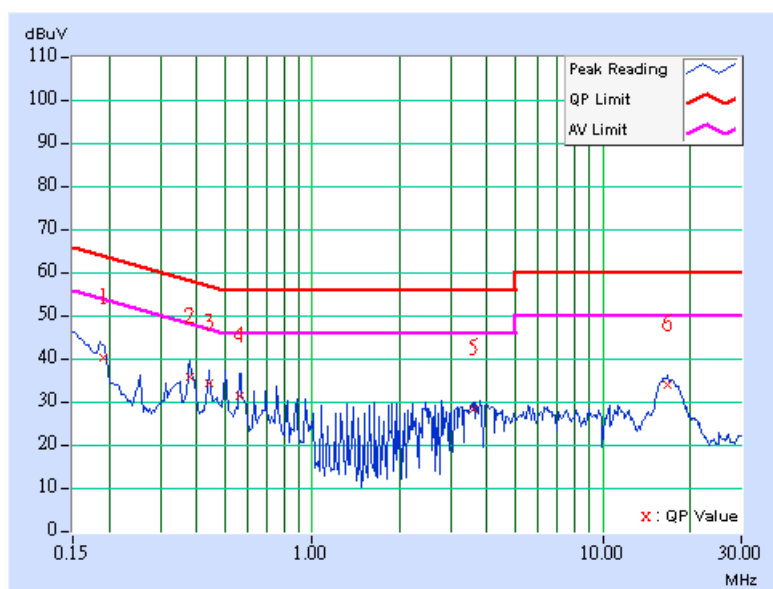

RADIATED EMISSION MEASUREMENT

LIMITS OF RADIATED EMISSION MEASUREMENT

Emissions radiated outside of the specified bands, shall be according to the general radiated limits in 15.209 as following:

Frequencies (MHz)	Field strength (microvolts/meter)	Measurement distance (meters)
0.009-0.490	2400/F(kHz)	300
0.490-1.705	24000/F(kHz)	30
1.705-30.0	30	30
30-88	100	3
88-216	150	3
216-960	200	3
Above 960	500	3

NOTE:

1. The lower limit shall apply at the transition frequencies.
2. Emission level (dBuV/m) = 20 log Emission level (uV/m).
3. As shown in 15.35(b), for frequencies above 1000MHz, the field strength limits are based on average detector, however, the peak field strength of any emission shall not exceed the maximum permitted average limits, specified above by more than 20dB under any condition of modulation.



TEST INSTRUMENTS

DESCRIPTION & MANUFACTURER	MODEL NO.	SERIAL NO.	CALIBRATED UNTIL
Test Receiver ROHDE & SCHWARZ	ESI7	100033	May. 19, 2006
Spectrum Analyzer ROHDE & SCHWARZ	FSP40	100025	Dec. 05, 2006
BILOG Antenna SCHWARZBECK	VULB9168	9168-160	Jun. 01, 2006
HORN Antenna SCHWARZBECK	9120D	9120D-408	Jan. 08, 2007
HORN Antenna SCHWARZBECK	BBHA 9170	BBHA9170243	Jan. 19, 2007
Preamplifier Agilent	8447D	2944A10633	Nov. 04, 2006
Preamplifier Agilent	8449B	3008A01964	Oct. 30, 2006
RF signal cable HUBER+SUHNNER	SUCOFLEX 104	214377/4	Dec. 13, 2006
RF signal cable HUBER+SUHNNER	SUCOFLEX 104	219272/4	Dec. 13, 2006
Software ADT.	ADT_Radiated_V5.14	NA	NA
Antenna Tower inn-co GmbH	MA 4000	013303	NA
Antenna Tower Controller inn-co GmbH	CO2000	017303	NA
Turn Table ADT.	TT100.	TT93021703	NA
Turn Table Controller ADT.	SC100.	SC93021703	NA
26GHz ~ 40GHz Amplifier	AMF-6F-2600400	923362	Mar. 27, 2007

- NOTE:**
1. The calibration interval of the above test instruments is 12 months and the calibrations are traceable to NML/ROC and NIST/USA.
 2. The test was performed in HwaYa Chamber 2.
 3. The horn antenna and HP preamplifier (model: 8449B) are used only for the measurement of emission frequency above 1GHz if tested.
 4. The VCCI Site Registration No. is R-237.
 5. The IC Site Registration No. is IC4924-3.

TEST PROCEDURES

- a. The EUT was placed on the top of a rotating table 0.8 meters above the ground at a 3 meters semi-anechoic chamber. The table was rotated 360 degrees to determine the position of the highest radiation.
- b. The EUT was set 3 meters away from the interference-receiving antenna, which was mounted on the top of a variable-height antenna tower.
- c. The antenna is a broadband antenna, and its height is varied from one meter to four meters above the ground to determine the maximum value of the field strength. Both horizontal and vertical polarizations of the antenna are set to make the measurement.
- d. For each suspected emission, the EUT was arranged to its worst case and then the antenna was tuned to heights from 1 meter to 4 meters and the rotatable table was turned from 0 degrees to 360 degrees to find the maximum reading.
- e. The test-receiver system was set to Peak Detect Function and Specified Bandwidth with Maximum Hold Mode.
- f. If the emission level of the EUT in peak mode was lower than the limit specified, then testing could be stopped and the peak values of the EUT would be reported. Otherwise the emissions would be re-tested one by one using peak, quasi-peak or average method as specified and then reported in a data sheet.

NOTE:

1. The resolution bandwidth and video bandwidth of test receiver/spectrum analyzer is 120kHz for Peak detection (PK) and Quasi-peak detection (QP) at frequency below 1GHz.
2. The resolution bandwidth and video bandwidth of test receiver/spectrum analyzer is 1 MHz for Peak detection at frequency above 1GHz.
3. The resolution bandwidth of test receiver/spectrum analyzer is 1 MHz and the video bandwidth is 1 kHz for Average detection (AV) at frequency above 1GHz.

DEVIATION FROM TEST STANDARD

No deviation

TEST SETUP

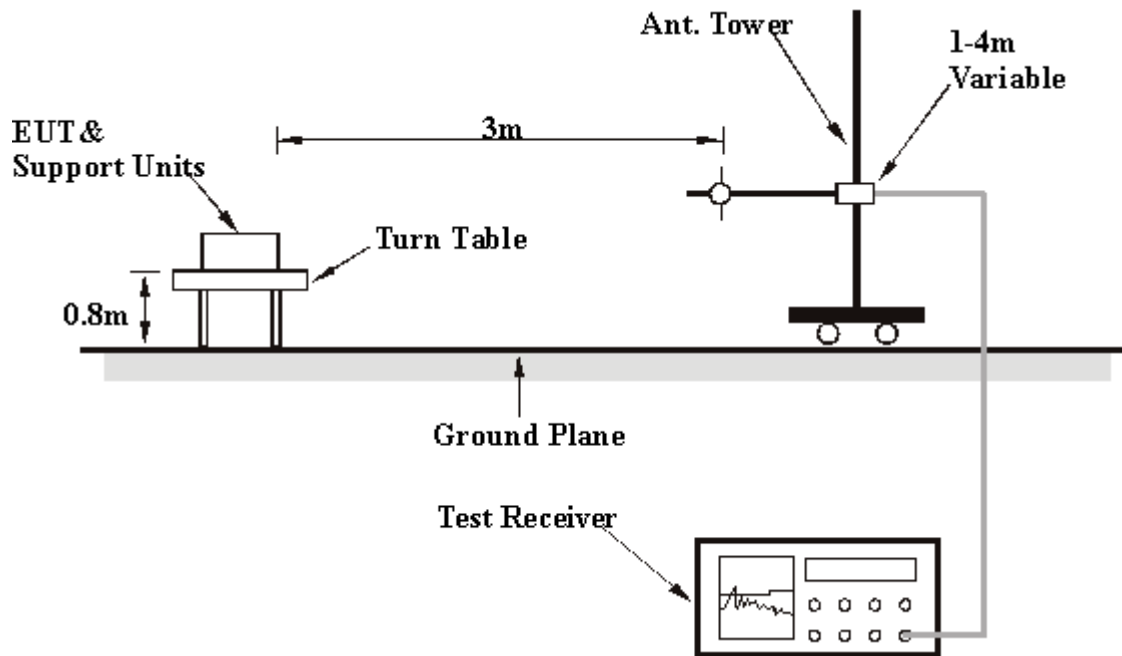

For the actual test configuration, please refer to the related item – Photographs of the Test Configuration.

EUT OPERATING CONDITIONS

Same as 4.1.6

TEST RESULTS

Below 1GHz Worst-Case Data

EUT TEST CONDITION		MEASUREMENT DETAIL	
CHANNEL	Channel 5	FREQUENCY RANGE	Below 1000MHz
MODULATION TYPE	BPSK	DETECTOR FUNCTION	Quasi-Peak
TRANSFER RATE	6Mbps	ENVIRONMENTAL CONDITIONS	25deg. C, 68%RH, 991hPa
TESTED BY	Morgan Chen	INPUT POWER (SYSTEM)	120Vac, 60 Hz

ANTENNA POLARITY & TEST DISTANCE: HORIZONTAL AT 3 M								
No.	Freq. (MHz)	Emission Level (dBuV/m)	Limit (dBuV/m)	Margin (dB)	Antenna Height (m)	Table Angle (Degree)	Raw Value (dBuV)	Correction Factor (dB/m)
1	208.84	26.09 QP	43.50	-17.41	1.25 H	304	14.66	11.44
2	243.83	31.58 QP	46.00	-14.42	1.25 H	289	19.10	12.48
3	620.94	31.13 QP	46.00	-14.87	1.25 H	259	7.81	23.32
4	624.83	28.41 QP	46.00	-17.59	1.25 H	130	5.06	23.35
5	675.37	29.64 QP	46.00	-16.36	1.25 H	31	5.71	23.93
6	720.08	29.01 QP	46.00	-16.99	1.25 H	259	3.91	25.10
7	729.80	29.01 QP	46.00	-16.99	1.25 H	19	3.52	25.49
8	762.85	28.37 QP	46.00	-17.63	1.00 H	253	1.99	26.39
9	828.94	32.42 QP	46.00	-13.58	1.25 H	304	5.48	26.94
10	900.86	31.32 QP	46.00	-14.68	1.00 H	274	3.73	27.59
11	912.53	28.61 QP	46.00	-17.39	1.00 H	289	0.84	27.77

ANTENNA POLARITY & TEST DISTANCE: VERTICAL AT 3 M								
No.	Freq. (MHz)	Emission Level (dBuV/m)	Limit (dBuV/m)	Margin (dB)	Antenna Height (m)	Table Angle (Degree)	Raw Value (dBuV)	Correction Factor (dB/m)
1	432.38	33.43 QP	46.00	-12.57	1.00 V	118	14.56	18.87
2	527.64	33.05 QP	46.00	-12.95	1.00 V	118	12.09	20.96
3	566.51	33.81 QP	46.00	-12.19	1.00 V	271	11.86	21.95
4	620.94	32.41 QP	46.00	-13.59	1.25 V	169	9.10	23.32
5	624.83	37.46 QP	46.00	-8.54	1.00 V	22	14.12	23.35
6	675.37	32.74 QP	46.00	-13.26	1.00 V	46	8.81	23.93
7	696.75	34.93 QP	46.00	-11.07	1.00 V	118	10.68	24.25
8	848.38	32.63 QP	46.00	-13.37	1.00 V	118	5.51	27.12

- REMARKS:**
1. Emission level(dBuV/m)=Raw Value(dBuV) + Correction Factor(dB/m)
 2. Correction Factor(dB/m) = Antenna Factor (dB/m) + Cable Factor (dB)
 3. The other emission levels were very low against the limit.
 4. Margin value = Emission level – Limit value.

802.11a OFDM modulation

EUT TEST CONDITION		MEASUREMENT DETAIL	
CHANNEL	Channel 1	FREQUENCY RANGE	1 ~ 40 GHz
MODULATION TYPE	BPSK	DETECTOR FUNCTION	Peak(PK) Average (AV)
TRANSFER RATE	6Mbps	ENVIRONMENTAL CONDITIONS	25deg. C, 68%RH, 991hPa
TESTED BY	Morgan Chen	INPUT POWER (SYSTEM)	120Vac, 60 Hz

ANTENNA POLARITY & TEST DISTANCE: HORIZONTAL AT 3 M

No.	Freq. (MHz)	Emission Level (dBuV/m)	Limit (dBuV/m)	Margin (dB)	Antenna Height (m)	Table Angle (Degree)	Raw Value (dBuV)	Correction Factor (dB/m)
1	5725.00	45.98 PK	75.12	-29.14	1.51 H	8	6.95	39.03
1	5725.00	36.95 AV	66.11	-29.16	1.51 H	8	-2.08	39.03
2	*5745.00	95.12 PK			1.50 H	5	56.07	39.05
2	*5745.00	86.11 AV			1.50 H	5	47.06	39.05
3	#11490.00	59.12 PK	74.00	-14.88	1.48 H	15	9.06	50.06
3	#11490.00	46.10 AV	54.00	-7.90	1.48 H	15	-3.96	50.06

ANTENNA POLARITY & TEST DISTANCE: VERTICAL AT 3 M

No.	Freq. (MHz)	Emission Level (dBuV/m)	Limit (dBuV/m)	Margin (dB)	Antenna Height (m)	Table Angle (Degree)	Raw Value (dBuV)	Correction Factor (dB/m)
1	5725.00	43.68 PK	72.95	-29.27	1.40 V	3	4.65	39.03
1	5725.00	34.91 AV	64.11	-29.20	1.40 V	3	-4.12	39.03
2	*5745.00	92.95 PK			1.35 V	1	53.90	39.05
2	*5745.00	84.11 AV			1.35 V	1	45.06	39.05
3	#11490.00	58.45 PK	74.00	-15.55	1.12 V	255	8.39	50.06
3	#11490.00	45.25 AV	54.00	-8.75	1.12 V	255	-4.81	50.06

- NOTE:**
1. Emission level(dBuV/m)=Raw Value(dBuV) + Correction Factor(dB/m)
 2. Correction Factor(dB/m) = Antenna Factor (dB/m) + Cable Factor (dB)
 3. The other emission levels were very low against the limit.
 4. Margin value = Emission level – Limit value
 5. "*" : Fundamental frequency
 6. "#"The radiated frequency falling in the restricted band.
 7. The limit value is defined as per 15.247

EUT TEST CONDITION		MEASUREMENT DETAIL	
CHANNEL	Channel 3	FREQUENCY RANGE	1 ~ 40 GHz
MODULATION TYPE	BPSK	DETECTOR FUNCTION	Peak(PK) Average (AV)
TRANSFER RATE	6Mbps	ENVIRONMENTAL CONDITIONS	25deg. C, 68%RH, 991hPa
TESTED BY	Morgan Chen	INPUT POWER (SYSTEM)	120Vac, 60 Hz

ANTENNA POLARITY & TEST DISTANCE: HORIZONTAL AT 3 M

No.	Freq. (MHz)	Emission Level (dBuV/m)	Limit (dBuV/m)	Margin (dB)	Antenna Height (m)	Table Angle (Degree)	Raw Value (dBuV)	Correction Factor (dB/m)
1	*5785.00	96.25 PK			1.32 H	15	57.16	39.09
1	*5785.00	86.46 AV			1.32 H	15	47.37	39.09
2	#11570.00	59.32 PK	74.00	-14.68	1.25 H	222	9.66	49.66
2	#11570.00	46.25 AV	54.00	-7.75	1.25 H	222	-3.41	49.66

ANTENNA POLARITY & TEST DISTANCE: VERTICAL AT 3 M

No.	Freq. (MHz)	Emission Level (dBuV/m)	Limit (dBuV/m)	Margin (dB)	Antenna Height (m)	Table Angle (Degree)	Raw Value (dBuV)	Correction Factor (dB/m)
1	*5785.00	92.65 PK			1.15 V	265	53.56	39.09
1	*5785.00	84.32 AV			1.15 V	265	45.23	39.09
2	#11570.00	58.45 PK	74.00	-15.55	1.45 V	344	8.79	49.66
2	#11570.00	45.25 AV	54.00	-8.75	1.45 V	344	-4.41	49.66

- NOTE:**
1. Emission level(dBuV/m)=Raw Value(dBuV) + Correction Factor(dB/m)
 2. Correction Factor(dB/m) = Antenna Factor (dB/m) + Cable Factor (dB)
 3. The other emission levels were very low against the limit.
 4. Margin value = Emission level – Limit value
 5. "*" : Fundamental frequency
 6. "#"The radiated frequency falling in the restricted band.
 7. The limit value is defined as per 15.247

EUT TEST CONDITION		MEASUREMENT DETAIL	
CHANNEL	Channel 5	FREQUENCY RANGE	1 ~ 40 GHz
MODULATION TYPE	BPSK	DETECTOR FUNCTION	Peak(PK) Average (AV)
TRANSFER RATE	6Mbps	ENVIRONMENTAL CONDITIONS	25deg. C, 68%RH, 991hPa
TESTED BY	Morgan Chen	INPUT POWER (SYSTEM)	120Vac, 60 Hz

ANTENNA POLARITY & TEST DISTANCE: HORIZONTAL AT 3 M

No.	Freq. (MHz)	Emission Level (dBuV/m)	Limit (dBuV/m)	Margin (dB)	Antenna Height (m)	Table Angle (Degree)	Raw Value (dBuV)	Correction Factor (dB/m)
1	*5825.00	96.58 PK			1.45 H	11	57.44	39.14
1	*5825.00	87.15 AV			1.45 H	11	48.01	39.14
2	5850.00	47.20 PK	76.58	-29.38	1.29 H	11	8.03	39.17
2	5850.00	37.90 AV	67.15	-29.25	1.29 H	11	-1.27	39.17
3	#11650.00	59.55 PK	74.00	-14.45	1.35 H	241	10.15	49.40
3	#11650.00	46.45 AV	54.00	-7.55	1.35 H	241	-2.95	49.40

ANTENNA POLARITY & TEST DISTANCE: VERTICAL AT 3 M

No.	Freq. (MHz)	Emission Level (dBuV/m)	Limit (dBuV/m)	Margin (dB)	Antenna Height (m)	Table Angle (Degree)	Raw Value (dBuV)	Correction Factor (dB/m)
1	*5825.00	93.61 PK			1.30 V	10	54.47	39.14
1	*5825.00	84.50 AV			1.30 V	10	45.36	39.14
2	5850.00	44.55 PK	73.61	-29.06	1.20 V	15	5.37	39.17
2	5850.00	35.23 AV	64.50	-29.27	1.20 V	15	-3.95	39.17
3	#11650.00	58.55 PK	74.00	-15.45	1.25 V	25	9.15	49.40
3	#11650.00	45.35 AV	54.00	-8.65	1.25 V	25	-4.05	49.40

- NOTE:**
1. Emission level(dBuV/m)=Raw Value(dBuV) + Correction Factor(dB/m)
 2. Correction Factor(dB/m) = Antenna Factor (dB/m) + Cable Factor (dB)
 3. The other emission levels were very low against the limit.
 4. Margin value = Emission level – Limit value
 5. "*" : Fundamental frequency
 6. "#"The radiated frequency falling in the restricted band.
 7. The limit value is defined as per 15.247



6dB BANDWIDTH MEASUREMENT

3.1.2 LIMITS OF 6dB BANDWIDTH MEASUREMENT

The minimum of 6dB Bandwidth Measurement is 0.5 MHz.

3.1.3 TEST INSTRUMENTS

Description & Manufacturer	Model No.	Serial No.	Calibrated Until
R&S SPECTRUM ANALYZER	FSEK30	100049	Aug. 14, 2006

NOTES: The calibration interval of the above test instruments is 12 months and the calibrations are traceable to NML/ROC and NIST/USA.

3.1.4 TEST PROCEDURE

The transmitter output was connected to the spectrum analyzer through an attenuator. The bandwidth of the fundamental frequency was measured by spectrum analyzer with 100kHz RBW and 100kHz VBW. The 6dB bandwidth is defined as the total spectrum the power of which is higher than peak power minus 6dB.

DEVIATION FROM TEST STANDARD

No deviation

3.1.5 TEST SETUP

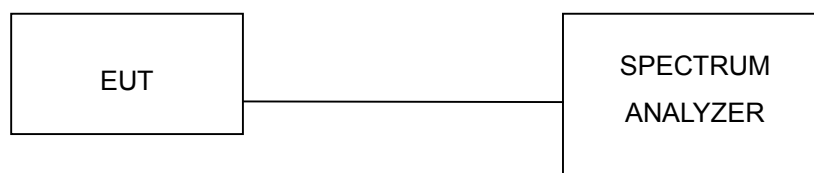

3.1.6 EUT OPERATING CONDITIONS

The software provided by client to enable the EUT under transmission condition continuously at lowest, middle and highest channel frequencies individually.



3.1.7 TEST RESULTS

802.11a OFDM modulation

MODULATION TYPE	BPSK	TRANSFER RATE	6Mbps
INPUT POWER (SYSTEM)	120Vac, 60 Hz	ENVIRONMENTAL CONDITIONS	25deg.C, 68%RH, 991hPa
TESTED BY	Morgan Chen		

CHANNEL	CHANNEL FREQUENCY (MHz)	6dB BANDWIDTH (MHz)	MINIMUM LIMIT (MHz)	PASS/FAIL
1	5745	16.48	0.5	PASS
3	5785	16.48	0.5	PASS
5	5825	16.48	0.5	PASS

CH 1

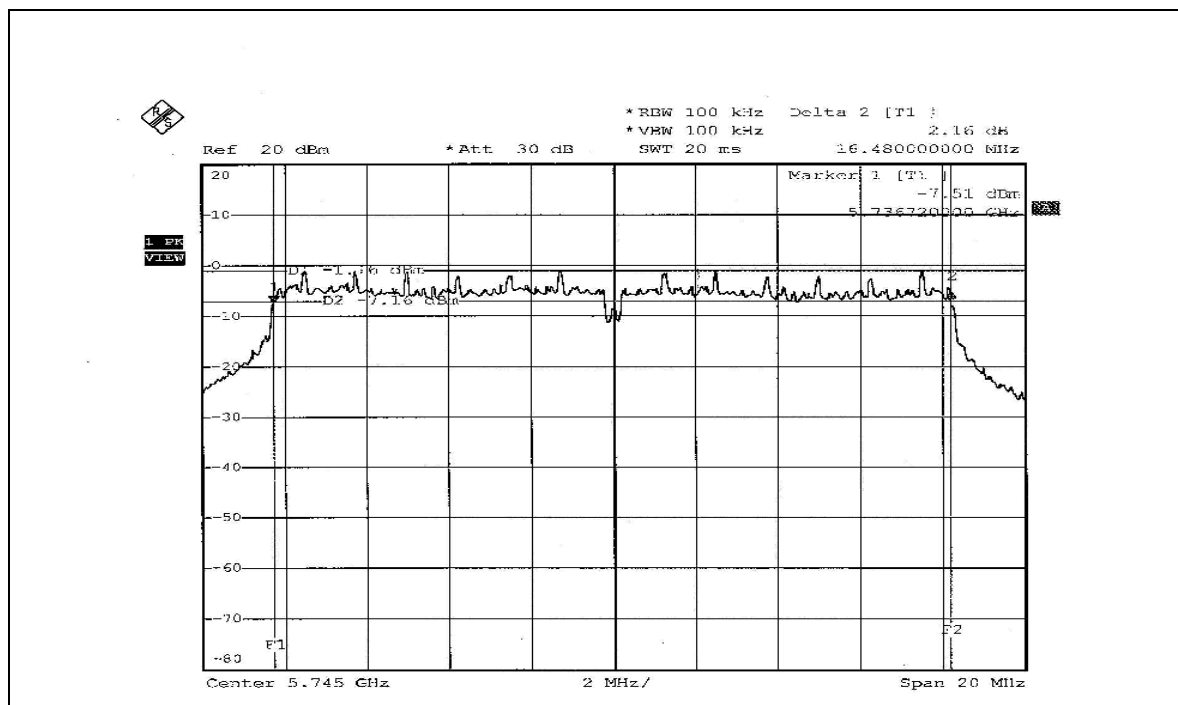

CH 3

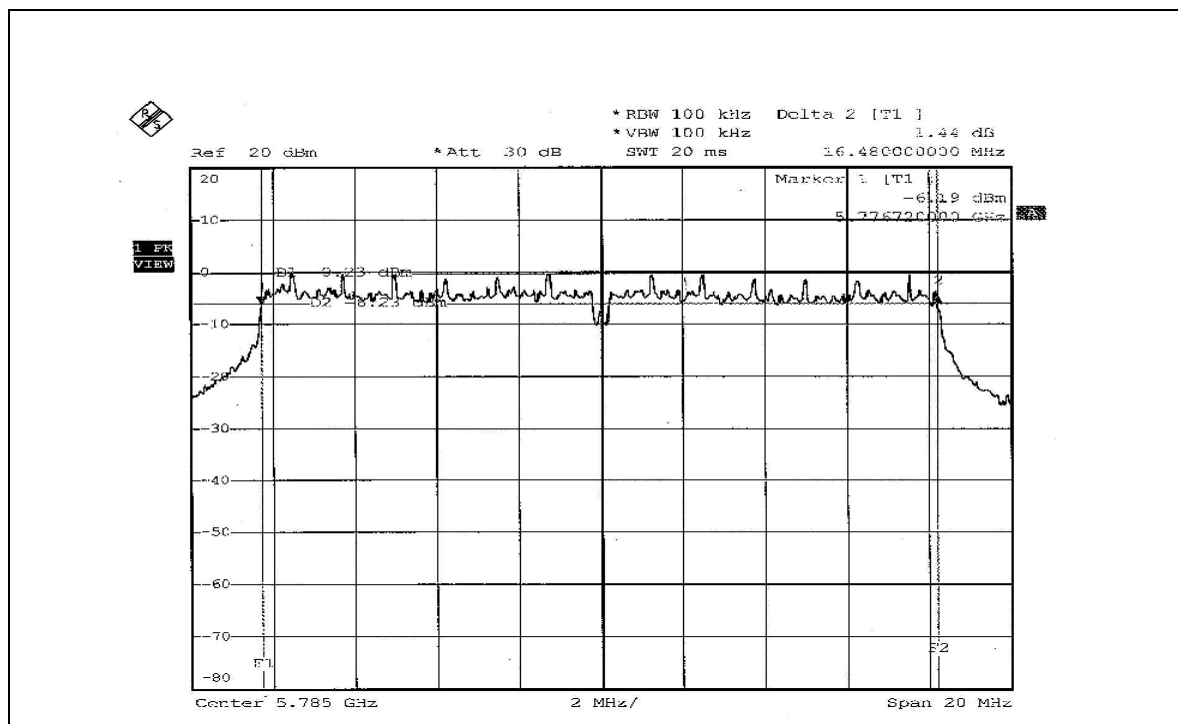

CH 5

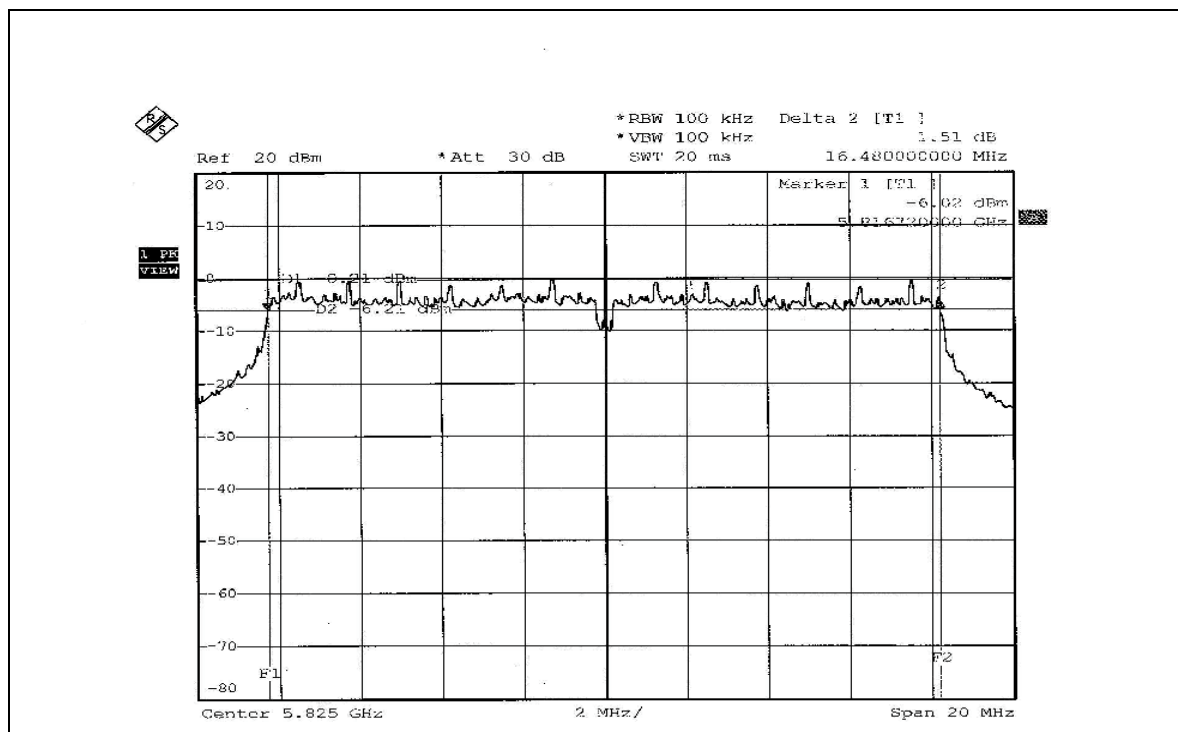



MAXIMUM PEAK OUTPUT POWER

3.1.8 LIMITS OF MAXIMUM PEAK OUTPUT POWER MEASUREMENT

The Maximum Peak Output Power Measurement is 30dBm.

3.1.9 INSTRUMENTS

Description & Manufacturer	Model No.	Serial No.	Calibrated Until
R&S SPECTRUM ANALYZER	FSEK30	100049	Aug. 14, 2006
AGILENT SIGNAL GENERATOR	E8257C	MY43320668	Dec. 30, 2006
TEKTRONIX OSCILLOSCOPE	TDS 1012	C019167	Jan. 16, 2007
NARDA DETECTOR	4503A	FSCM99899	NA

NOTE:

The calibration interval of the above test instruments is 12 months and the calibrations are traceable to NML/ROC and NIST/USA..

3.1.10 TEST PROCEDURES

1. A detector was used on the output port of the EUT. An oscilloscope was used to read the response of the detector.
2. Replaced the EUT by the signal generator . The center frequency of the S.G was adjusted to the center frequency of the measured channel.
3. Adjusted the power to have the same reading on oscilloscope. Record the power level.

DEVIATION FROM TEST STANDARD

No deviation

3.1.11 TEST SETUP



3.1.12 EUT OPERATING CONDITIONS

Same as Item 5.3.6



3.1.13 TEST RESULTS

802.11a OFDM modulation

MODULATION TYPE	BPSK	TRANSFER RATE	6Mbps
INPUT POWER (SYSTEM)	120Vac, 60 Hz	ENVIRONMENTAL CONDITIONS	25deg.C, 68%RH, 991hPa
TESTED BY	Morgan Chen		

CHANNEL	CHANNEL FREQUENCY (MHz)	PEAK POWER OUTPUT (mW)	PEAK POWER OUTPUT (dBm)	PEAK POWER LIMIT (dBm)	PASS/FAIL
1	5745	36.058	15.57	30	PASS
3	5785	35.727	15.53	30	PASS
5	5825	35.892	15.55	30	PASS



POWER SPECTRAL DENSITY MEASUREMENT

3.1.14 LIMITS OF POWER SPECTRAL DENSITY MEASUREMENT

The Maximum of Power Spectral Density Measurement is 8dBm.

3.1.15 TEST INSTRUMENTS

Description & Manufacturer	Model No.	Serial No.	Calibrated Until
R&S SPECTRUM ANALYZER	FSEK30	100049	Aug. 14, 2006

NOTES:

The calibration interval of the above test instruments is 12 months and the calibrations are traceable to NML/ROC and NIST/USA.

3.1.16 TEST PROCEDURE

The transmitter output was connected to the spectrum analyzer through an attenuator, the bandwidth of the fundamental frequency was measured with the spectrum analyzer using 3 kHz RBW and 30 kHz VBW, set sweep time = span/3 kHz. The power spectral density was measured and recorded. The sweep time is allowed to be longer than span/3 kHz for a full response of the mixer in the spectrum analyzer.

DEVIATION FROM TEST STANDARD

No deviation

3.1.17 TEST SETUP



3.1.18 EUT OPERATING CONDITION

Same as Item 5.3.6



3.1.19 TEST RESULTS

802.11a OFDM modulation

MODULATION TYPE	BPSK	TRANSFER RATE	6Mbps
INPUT POWER (SYSTEM)	120Vac, 60 Hz	ENVIRONMENTAL CONDITIONS	25deg.C, 68%RH, 991hPa
TESTED BY	Morgan Chen		

CHANNEL	CHANNEL FREQUENCY (MHz)	RF POWER LEVEL IN 3 kHz BW (dBm)	MAXIMUM LIMIT (dBm)	PASS/FAIL
1	5745	-14.13	8	PASS
3	5785	-14.14	8	PASS
5	5825	-14.43	8	PASS

3.2 BAND EDGES MEASUREMENT

3.2.1 LIMITS OF BAND EDGES MEASUREMENT

Below -20dB of the highest emission level of operating band (in 100kHz Resolution Bandwidth).

3.2.2 TEST INSTRUMENTS

Description & Manufacturer	Model No.	Serial No.	Calibrated Until
R&S SPECTRUM ANALYZER	FSEK30	100049	Aug. 14, 2006

NOTES:

The calibration interval of the above test instruments is 12 months and the calibrations are traceable to NML/ROC and NIST/USA.

3.2.3 TEST PROCEDURE

The transmitter output was connected to the spectrum analyzer via a low lose cable. Set both RBW and VBW of spectrum analyzer to 100 kHz with suitable frequency span including 100 MHz bandwidth from band edge. The band edges was measured and recorded.

DEVIATION FROM TEST STANDARD

No deviation



3.2.4 EUT OPERATING CONDITION

Same as Item 5.9.6

3.2.5 TEST RESULTS

The spectrum plots are attached on the following pages. D1 line indicates the highest level, D2 line indicates the 20dB offset below D1. It shows compliance with the requirement in part 15.247(d).

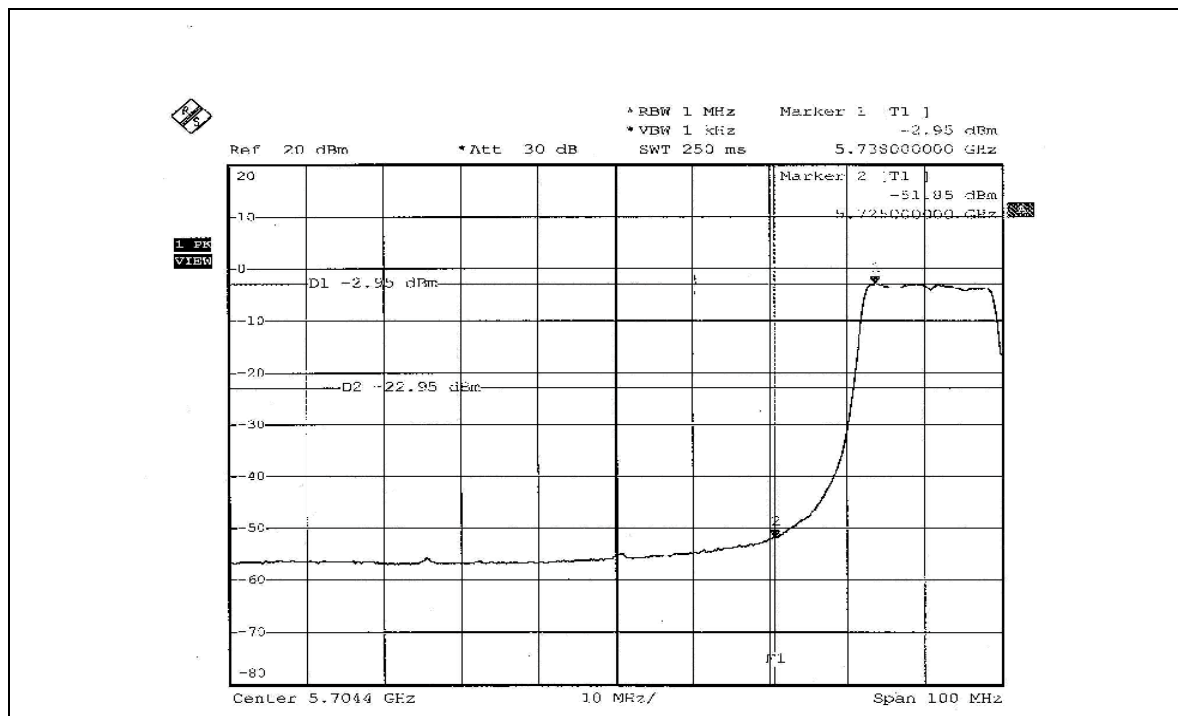
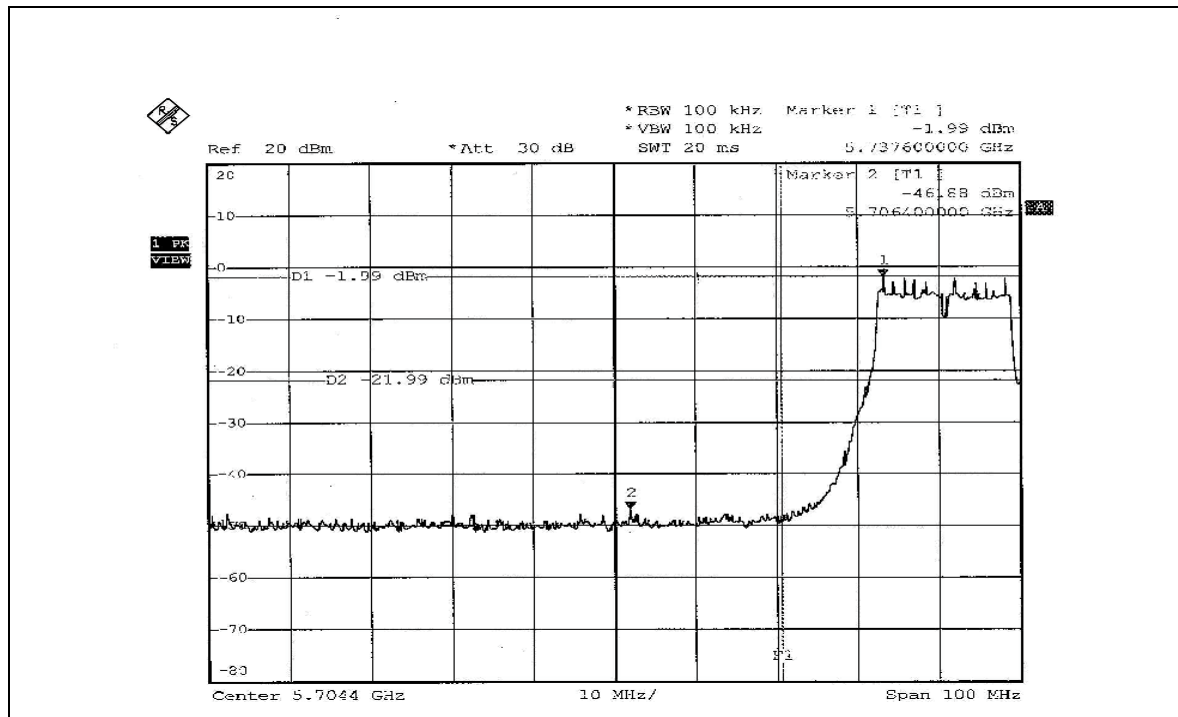

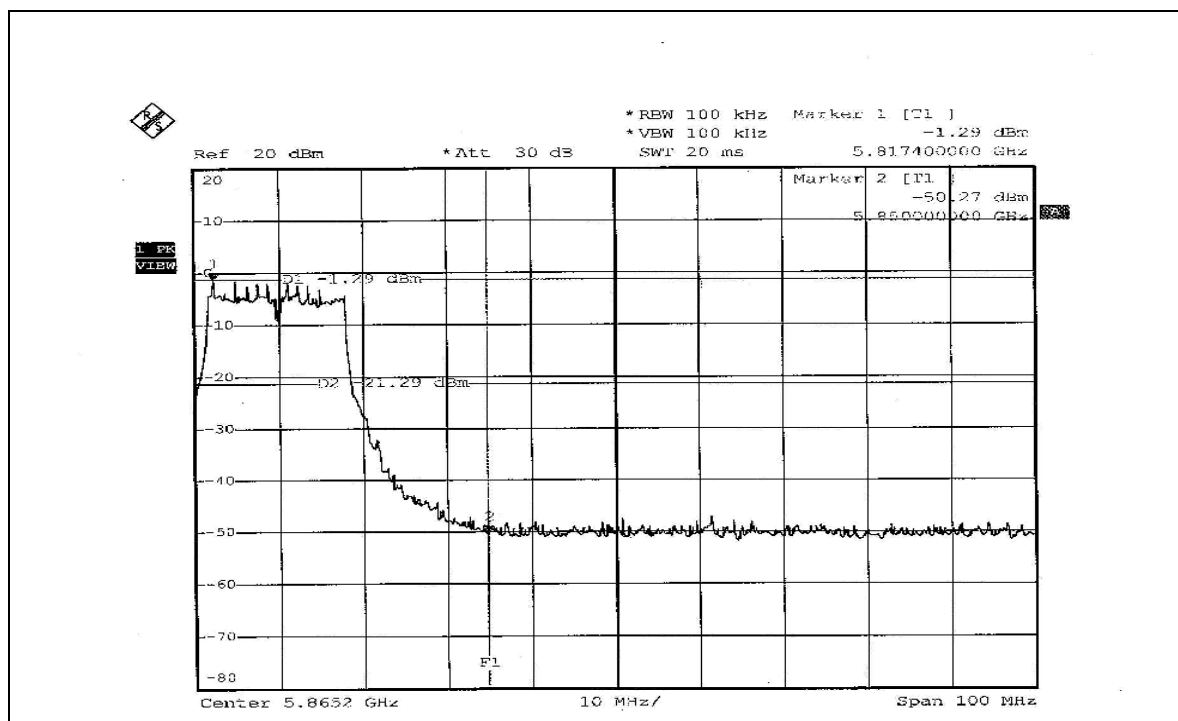
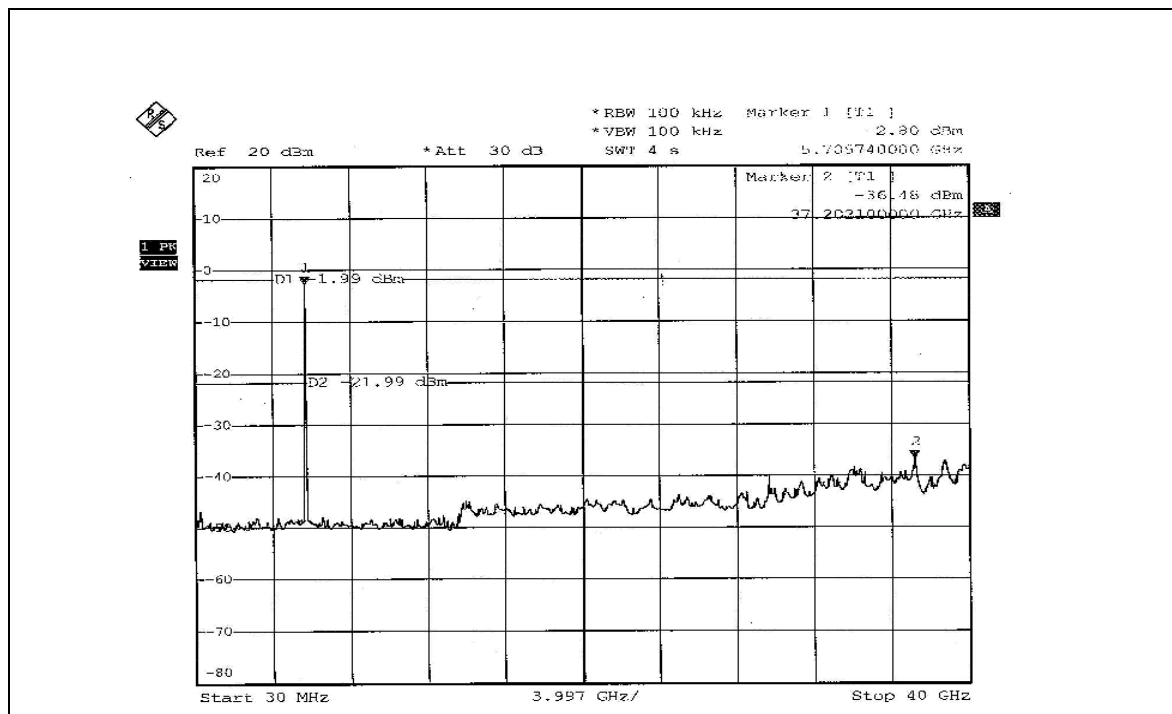

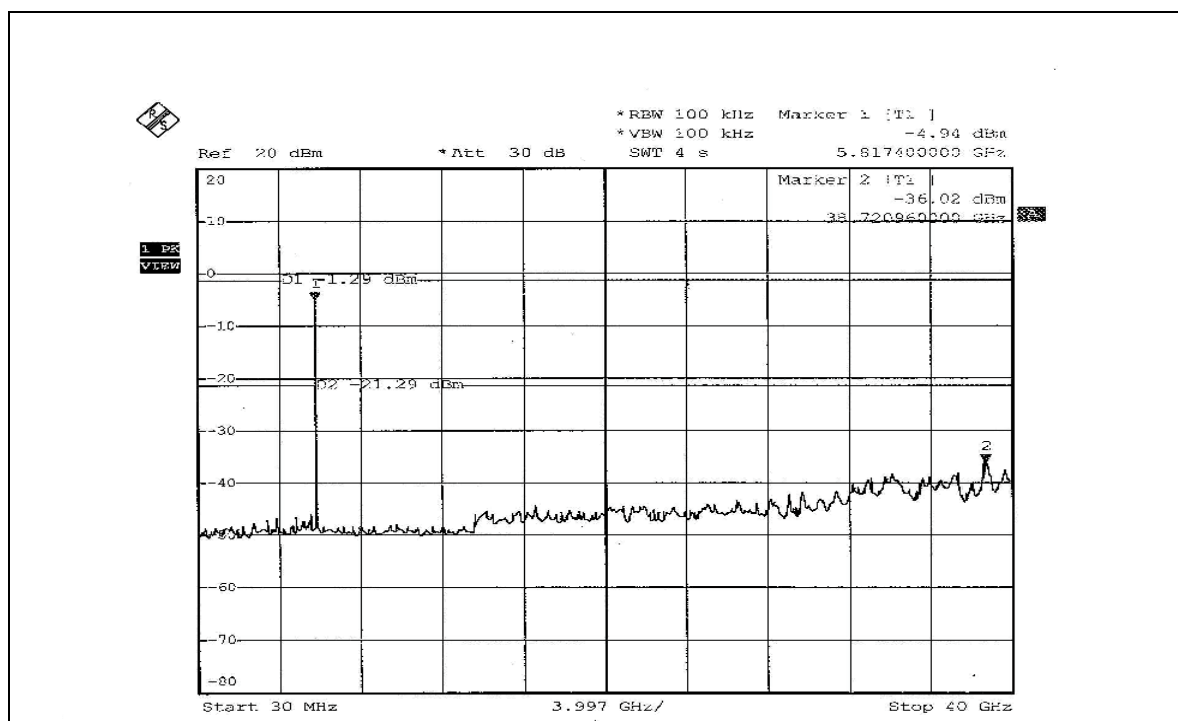
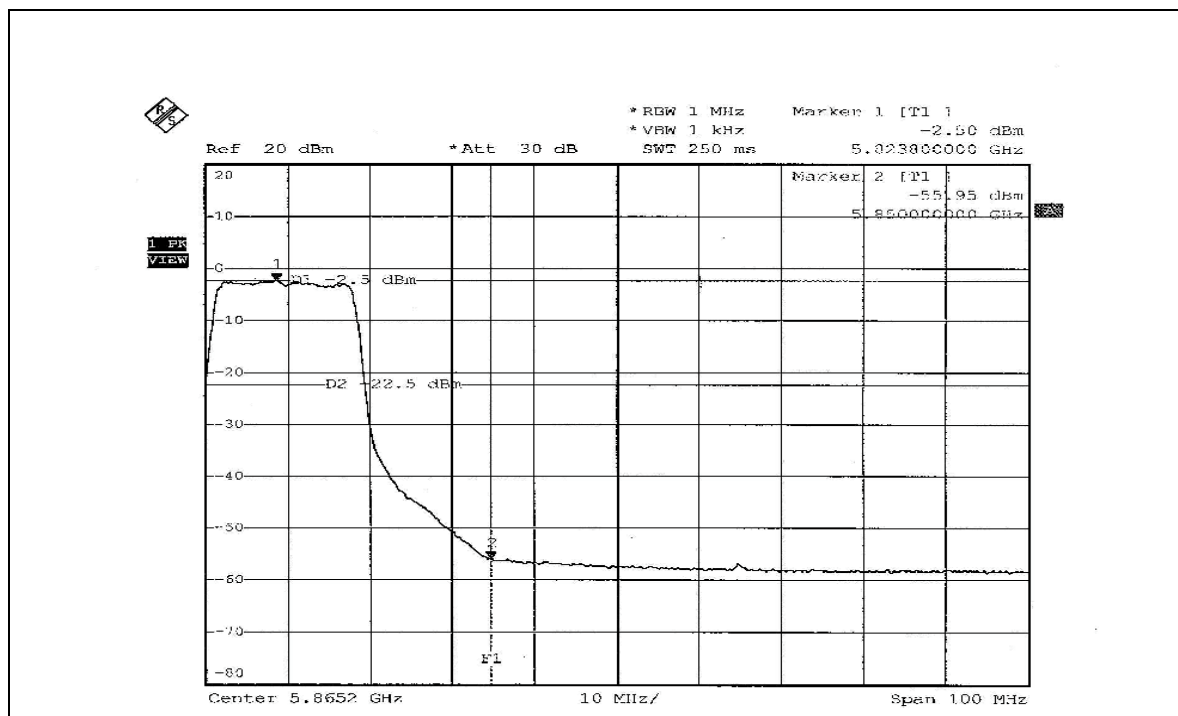



ANTENNA REQUIREMENT

STANDARD APPLICABLE

For intentional device, according to FCC 47 CFR Section 15.203, an intentional radiator shall be designed to ensure that no antenna other than that furnished by the responsible party shall be used with the device.

And according to FCC 47 CFR Section 15.247(a), if transmitting antennas of directional gain greater than 6dBi are used, the power shall be reduced by the amount in dB that the directional gain of the antenna exceeds 6dBi.

ANTENNA CONNECTED CONSTRUCTION

The antenna used in this product is PIFA antenna with UFL connector. The maximum Gain of the antenna is -0.84897dBi .