



FCC TEST REPORT (15.247)

REPORT NO.: RF950308L05
MODEL NO.: G410
RECEIVED: Feb. 16, 2006
TESTED: Feb. 16 ~ Mar. 10, 2006
ISSUED: Mar. 15, 2006

APPLICANT: ELITEGROUP COMPUTER SYSTEMS
CO., LTD.

ADDRESS: 2F. No. 240, Sec. 1, Nei Hu Road, Taipei,
Taiwan 114, R.O.C.

ISSUED BY: Advance Data Technology Corporation

LAB ADDRESS: No. 47, 14th Ling, Chia Pau Tsuen, Lin Kou
Hsiang 244, Taipei Hsien, Taiwan, R.O.C.

TEST LOCATION: No. 19, Hwa Ya 2nd Rd., Wen Hwa Tsuen, Kwei
Shan Hsiang, Taoyuan Hsien 333, Taiwan,
R.O.C.

This test report consists of 109 pages in total. It may be duplicated completely for legal use with the approval of the applicant. It should not be reproduced except in full, without the written approval of our laboratory. The client should not use it to claim product endorsement by CNLA, A2LA or any government agencies. The test results in the report only apply to the tested sample.



No. 2177-01



Table of Contents

1.	CERTIFICATION	5
2.	SUMMARY OF TEST RESULTS	6
2.1	MEASUREMENT UNCERTAINTY	6
3.	GENERAL INFORMATION.....	7
3.1	GENERAL DESCRIPTION OF EUT.....	7
3.2	DESCRIPTION OF TEST MODES.....	9
3.2.1	CONFIGURATION OF SYSTEM UNDER TEST	9
3.2.2	TEST MODE APPLICABILITY AND TESTED CHANNEL DETAIL	10
3.3	GENERAL DESCRIPTION OF APPLIED STANDARDS	12
3.4	DESCRIPTION OF SUPPORT UNITS	12
4.	TEST TYPES AND RESULTS (FOR 802.11b & g 2412~2462MHz BAND).....	13
4.1	CONDUCTED EMISSION MEASUREMENT	13
4.1.1	LIMITS OF CONDUCTED EMISSION MEASUREMENT.....	13
4.1.2	TEST INSTRUMENTS.....	13
4.1.3	TEST PROCEDURES	14
4.1.4	DEVIATION FROM TEST STANDARD	14
4.1.5	TEST SETUP	15
4.1.6	EUT OPERATING CONDITIONS	15
4.1.7	TEST RESULTS	16
4.2	RADIATED EMISSION MEASUREMENT	28
4.2.1	LIMITS OF RADIATED EMISSION MEASUREMENT.....	28
4.2.2	TEST INSTRUMENTS.....	29
4.2.3	TEST PROCEDURES	30
4.2.4	DEVIATION FROM TEST STANDARD	30
4.2.5	TEST SETUP	31
4.2.6	EUT OPERATING CONDITIONS	31
4.2.7	TEST RESULTS	32
4.3	6dB BANDWIDTH MEASUREMENT	40
4.3.1	LIMITS OF 6dB BANDWIDTH MEASUREMENT	40
4.3.2	TEST INSTRUMENTS.....	40
4.3.3	TEST PROCEDURE.....	41
4.3.4	DEVIATION FROM TEST STANDARD	41
4.3.5	TEST SETUP	41
4.3.6	EUT OPERATING CONDITIONS	41
4.3.7	TEST RESULTS	42
4.4	MAXIMUM PEAK OUTPUT POWER	48
4.4.1	LIMITS OF MAXIMUM PEAK OUTPUT POWER MEASUREMENT	48
4.4.2	INSTRUMENTS.....	48
4.4.1	TEST PROCEDURES	49
4.4.2	DEVIATION FROM TEST STANDARD	49
4.4.3	TEST SETUP	49
4.4.4	EUT OPERATING CONDITIONS	49
4.4.3	TEST RESULTS	50
4.5	POWER SPECTRAL DENSITY MEASUREMENT.....	51
4.5.1	LIMITS OF POWER SPECTRAL DENSITY MEASUREMENT	51
4.5.2	TEST INSTRUMENTS.....	51



4.5.3	TEST PROCEDURE.....	52
4.5.4	DEVIATION FROM TEST STANDARD	52
4.5.5	TEST SETUP	52
4.5.6	EUT OPERATING CONDITION	52
4.5.7	TEST RESULTS	53
4.6	BAND EDGES MEASUREMENT	59
4.6.1	LIMITS OF BAND EDGES MEASUREMENT	59
4.6.2	TEST INSTRUMENTS.....	59
4.6.3	TEST PROCEDURE.....	59
4.6.4	DEVIATION FROM TEST STANDARD	59
4.6.5	EUT OPERATING CONDITION	59
4.6.6	TEST RESULTS	60
4.7	ANTENNA REQUIREMENT	68
4.7.1	STANDARD APPLICABLE	68
4.7.2	ANTENNA CONNECTED CONSTRUCTION.....	68
5.	TEST TYPES AND RESULTS (FOR 802.11a 5745~5825MHz Band)	69
5.1	CONDUCTED EMISSION MEASUREMENT	69
5.1.1	LIMITS OF CONDUCTED EMISSION MEASUREMENT.....	69
5.1.2	TEST INSTRUMENTS.....	69
5.1.3	TEST PROCEDURES	70
5.1.4	DEVIATION FROM TEST STANDARD	70
5.1.5	TEST SETUP	71
5.1.6	EUT OPERATING CONDITIONS	71
5.1.7	TEST RESULTS	72
5.2	RADIATED EMISSION MEASUREMENT	76
5.2.1	LIMITS OF RADIATED EMISSION MEASUREMENT.....	76
5.2.2	TEST INSTRUMENTS.....	77
5.2.3	TEST PROCEDURES	78
5.2.4	DEVIATION FROM TEST STANDARD	78
5.2.5	TEST SETUP	79
5.2.6	EUT OPERATING CONDITIONS	79
5.2.7	TEST RESULTS	80
5.3	6dB BANDWIDTH MEASUREMENT	85
5.3.1	LIMITS OF 6dB BANDWIDTH MEASUREMENT	85
5.3.2	TEST INSTRUMENTS.....	85
5.3.3	TEST PROCEDURE.....	86
5.3.4	DEVIATION FROM TEST STANDARD	86
5.3.5	TEST SETUP	86
5.3.6	EUT OPERATING CONDITIONS	86
5.3.7	TEST RESULTS	87
5.4	MAXIMUM PEAK OUTPUT POWER	90
5.4.1	LIMITS OF MAXIMUM PEAK OUTPUT POWER MEASUREMENT.....	90
5.4.2	INSTRUMENTS.....	90
5.4.3	TEST PROCEDURES	91
5.4.4	DEVIATION FROM TEST STANDARD	91
5.4.5	TEST SETUP	91
5.4.6	EUT OPERATING CONDITIONS	91
5.4.7	TEST RESULTS	92
5.5	POWER SPECTRAL DENSITY MEASUREMENT.....	93
5.5.1	LIMITS OF POWER SPECTRAL DENSITY MEASUREMENT	93



5.5.2	TEST INSTRUMENTS.....	93
5.5.3	TEST PROCEDURE.....	94
5.5.4	DEVIATION FROM TEST STANDARD	94
5.5.5	TEST SETUP	94
5.5.6	EUT OPERATING CONDITION	94
5.5.7	TEST RESULTS	95
5.6	BAND EDGES MEASUREMENT	98
5.6.1	LIMITS OF BAND EDGES MEASUREMENT	98
5.6.2	TEST INSTRUMENTS.....	98
5.6.3	TEST PROCEDURE.....	98
5.6.4	DEVIATION FROM TEST STANDARD	98
5.6.5	EUT OPERATING CONDITION	99
5.6.6	TEST RESULTS	99
5.7	ANTENNA REQUIREMENT	103
5.7.1	STANDARD APPLICABLE	103
5.7.2	ANTENNA CONNECTED CONSTRUCTION.....	103
6.	PHOTOGRAPHS OF THE TEST CONFIGURATION.....	104
7.	INFORMATION ON THE TESTING LABORATORIES	108
	APPENDIX-A.....	A-1



1. CERTIFICATION

PRODUCT: Notebook

MODEL: G410

BRAND: ECS

APPLICANT: ELITEGROUP COMPUTER SYSTEMS CO., LTD.

TEST SAMPLE: ENGINEERING SAMPLE

TESTED: Feb. 16 ~ Mar. 10, 2006

STANDARDS: FCC Part 15, Subpart C (Section 15.247),
ANSI C63.4-2003

The above equipment has been tested by **Advance Data Technology Corporation**, and found compliance with the requirement of the above standards. The test record, data evaluation & Equipment Under Test (EUT) configurations represented herein are true and accurate accounts of the measurements of the sample's EMC characteristics under the conditions specified in this report.

PREPARED BY : Andrea Hsia **DATE:** Mar. 15, 2006
Andrea Hsia

TECHNICAL ACCEPTANCE : Long Chen **DATE:** Mar. 15, 2006
Responsible for RF Long Chen

APPROVED BY : Gary Chang **DATE:** Mar. 15, 2006
Gary Chang / Supervisor

2. SUMMARY OF TEST RESULTS

The EUT has been tested according to the following specifications:

APPLIED STANDARD: FCC Part 15, Subpart C (Section 15.247)			
Standard Section	Test Type and Limit	Result	Remark
15.207	AC Power Conducted Emission	PASS	Meet the requirement of limit. Minimum passing margin is -15.77dB at 0.150MHz
15.247(a)(2)	Spectrum Bandwidth of a Direct Sequence Spread Spectrum System Limit: min. 500kHz	PASS	Meet the requirement of limit.
15.247(b)	Maximum Peak Output Power Limit: max. 30dBm	PASS	Meet the requirement of limit.
15.247(d)	Radiated Emissions Limit: Table 15.209	PASS	Meet the requirement of limit. Minimum passing margin is -2.23dB at 168.02MHz
15.247(e)	Power Spectral Density Limit: max. 8dBm	PASS	Meet the requirement of limit.
15.247(d)	Band Edge Measurement Limit: 20dB less than the peak value of fundamental frequency	PASS	Meet the requirement of limit.

2.1 MEASUREMENT UNCERTAINTY

Where relevant, the following measurement uncertainty levels have been estimated for tests performed on the EUT as specified in CISPR 16-4:

Measurement	Frequency	Uncertainty
Conducted emissions	9kHz~30MHz	2.44 dB
	30MHz ~ 200MHz	3.55 dB
Radiated emissions	200MHz ~1000MHz	3.58 dB
	1GHz ~ 18GHz	1.10 dB
	18GHz ~ 40GHz	0.91 dB

This uncertainty represents an expanded uncertainty expressed at approximately the 95% confidence level using a coverage factor of k=2.

3. GENERAL INFORMATION

3.1 GENERAL DESCRIPTION OF EUT

EUT	Notebook
MODEL NO.	G410
FCC ID	SA6G410IABG
POWER SUPPLY	19.0Vdc from AC Adapter
MODULATION TYPE	CCK, DQPSK, DBPSK for DSSS 64QAM, 16QAM, QPSK, BPSK for OFDM
MODULATION TECHNOLOGY	DSSS, OFDM
TRANSFER RATE	802.11b: 11/5.5/2/1Mbps 802.11g: 54/48/36/24/18/12/9/6Mbps 802.11a: 54/48/36/24/18/12/9/6Mbps
FREQUENCY RANGE	802.11b & 802.11g: 2.412 ~ 2.462GHz 802.11a: 5.180 ~ 5.320GHz, 5.745 ~ 5.825GHz
NUMBER OF CHANNEL	802.11b & 802.11g: 11 802.11a: 13
CHANNEL SPACING	802.11b & 802.11g: 5MHz 802.11a: 20MHz
OUTPUT POWER	63.680mW for 802.11b 64.121mW for 802.11g 32.063mW for 5.180 ~ 5.320GHz 64.417mW for 5.745 ~ 5.825GHz
ANTENNA TYPE	Refer to Note 2 as below
DATA CABLE	NA
I/O PORTS	Refer to user's manual
ASSOCIATED DEVICES	NA

NOTE:

- The adapter were operated with following power adapters:

BRAND:	LITE-ON TECHNOLOGY CORPORATION
MODEL:	PA-1650-02
INPUT:	100-240Vac, 50-60Hz, 1.6A
OUTPUT:	19Vdc, 3.42A
POWER LINE:	AC 1.8m non-shielded cable without core DC 1.6m non-shielded cable with one core

BRAND:	LI SHIN INTERNATIONAL ENTERPRISE CORP.
MODEL:	0335A1965
INPUT:	100-240Vac, 50-60Hz, 1.7A
OUTPUT:	19Vdc, 3.42A
POWER LINE:	AC 1.8m non-shielded cable without core DC 1.6m non-shielded cable with one core



2. The following antennas were provided to the EUT.

Location	Model Name	Antenna Type	Connector	MAXIMUM GAIN (dBi)		
				2.4GHz	5.180 ~ 5.320GHz	5.745 ~ 5.825GHz
Right	12-211-F66021	PIFA	UFL	-1.09449	-3.03579	-2.84636
Left	12-211-F66041	PIFA	UFL	-1.54486	-0.84897	-5.79289

*After pre-testing each antenna, highest one was chosen for the final test and recorded in the report.

3. The EUT operates in both the 5GHz and 2.4GHz Bands and compatibility with 802.11a and 802.11b, 802.11g technology.
4. The above EUT information was declared by the manufacturer and for more detailed features description, please refer to the manufacturer's specifications or User's Manual.

3.2 DESCRIPTION OF TEST MODES

Operated in 2400 ~ 2483.5MHz band:

11 channels are provided to the EUT for wireless LAN function:

CHANNEL	FREQUENCY	CHANNEL	FREQUENCY
1	2412 MHz	7	2442 MHz
2	2417 MHz	8	2447 MHz
3	2422 MHz	9	2452 MHz
4	2427 MHz	10	2457 MHz
5	2432 MHz	11	2462 MHz
6	2437 MHz		

Operated in 5745 ~ 5825MHz band:

5 channels are provided to this EUT for wireless LAN function:

CHANNEL	FREQUENCY
1	5745 MHz
2	5765 MHz
3	5785 MHz
4	5805 MHz
5	5825 MHz

3.2.1 CONFIGURATION OF SYSTEM UNDER TEST

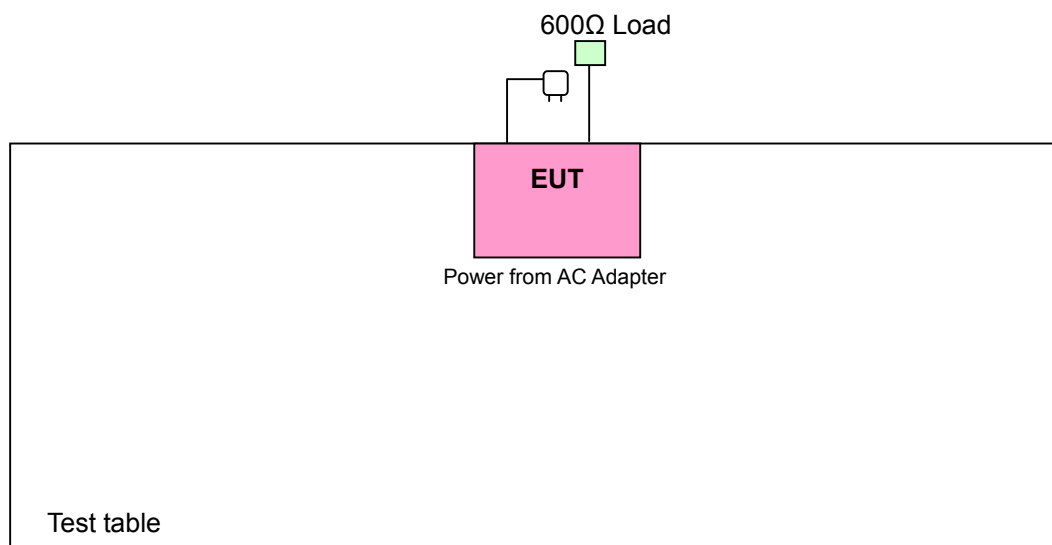

3.2.2 TEST MODE APPLICABILITY AND TESTED CHANNEL DETAIL

EUT configure mode	Applicable to				Description
	PLC	RE<1G	RE≥1G	APCM	
A	√	√	√	√	powered by the adapter model: PA-1650-02
B	√	√	-	-	powered by the adapter model: 0335A1965

Where **PLC**: Power Line Conducted Emission **RE<1G**: Radiated Emission below 1GHz
RE≥1G: Radiated Emission above 1GHz **APCM**: Antenna Port Conducted Measurement
NOTE: “-“ means no effect.

Power Line Conducted Emission Test:

- Pre-Scan has been conducted to determine the worst-case mode from all possible combinations between available modulations, data rates and antenna ports (if EUT with antenna diversity architecture).
- Following channel(s) was (were) selected for the final test as listed below.

EUT CONFIGURE MODE	Mode	AVAILABLE CHANNEL	TESTED CHANNEL	MODULATION TECHNOLOGY	MODULATION TYPE	DATA RATE (Mbps)
A	802.11g	1 to 11	1, 6, 11	OFDM	BPSK	6
A	802.11a	1 to 5	5	OFDM	BPSK	6
B	802.11g	1 to 11	1, 6, 11	OFDM	BPSK	6
B	802.11a	1 to 5	5	OFDM	BPSK	6

Radiated Emission Test (Below 1 GHz):

- Pre-Scan has been conducted to determine the worst-case mode from all possible combinations between available modulations, data rates, antenna ports (if EUT with antenna diversity architecture).
- Following channel(s) was (were) selected for the final test as listed below.

EUT CONFIGURE MODE	MODE	AVAILABLE CHANNEL	TESTED CHANNEL	MODULATION TECHNOLOGY	MODULATION TYPE	DATA RATE (Mbps)
A	802.11g	1 to 11	11	DSSS	DBPSK	1
A	802.11a	1 to 5	5	OFDM	BPSK	6
B	802.11g	1 to 11	11	DSSS	DBPSK	1
B	802.11a	1 to 5	5	OFDM	BPSK	6

Radiated Emission Test (Above 1 GHz):

- Pre-Scan has been conducted to determine the worst-case mode from all possible combinations between available modulations, data rates and antenna ports (if EUT with antenna diversity architecture).
- Following channel(s) was (were) selected for the final test as listed below.

EUT CONFIGURE MODE	MODE	AVAILABLE CHANNEL	TESTED CHANNEL	MODULATION TECHNOLOGY	MODULATION TYPE	DATA RATE (Mbps)
A	802.11b	1 to 11	1, 6, 11	DSSS	DBPSK	1
A	802.11g	1 to 11	1, 6, 11	OFDM	BPSK	6
A	802.11a	1 to 5	1, 3, 5	OFDM	BPSK	6

Bandedge Measurement:

- Pre-Scan has been conducted to determine the worst-case mode from all possible combinations between available modulations, data rates and antenna ports (if EUT with antenna diversity architecture).
- Following channel(s) was (were) selected for the final test as listed below.

MODE	AVAILABLE CHANNEL	TESTED CHANNEL	MODULATION TECHNOLOGY	MODULATION TYPE	DATA RATE (Mbps)
802.11b	1 to 11	1, 11	DSSS	DBPSK	1
802.11g	1 to 11	1, 11	OFDM	BPSK	6
802.11a	1 to 5	1, 5	OFDM	BPSK	6

Antenna Port Conducted Measurement:

- Pre-Scan has been conducted to determine the worst-case mode from all possible combinations between available modulations, data rates and antenna ports (if EUT with antenna diversity architecture).
- Following channel(s) was (were) selected for the final test as listed below.

MODE	AVAILABLE CHANNEL	TESTED CHANNEL	MODULATION TECHNOLOGY	MODULATION TYPE	DATA RATE (Mbps)
802.11b	1 to 11	1, 6, 11	DSSS	DBPSK	1
802.11g	1 to 11	1, 6, 11	OFDM	BPSK	6
802.11a	1 to 5	1, 3, 5	OFDM	BPSK	6



3.3 GENERAL DESCRIPTION OF APPLIED STANDARDS

The EUT is a RF Product. According to the specifications of the manufacturer, it must comply with the requirements of the following standards:

FCC Part 15, Subpart C. (15.247)

ANSI C63.4-2003

All test items have been performed and recorded as per the above standards.

NOTE: The EUT is also considered as a kind of computer peripheral, because the connection to computer is necessary for typical use. It has been verified to comply with the requirements of FCC Part 15, Subpart B, Class B (DoC). The test report has been issued separately.

3.4 DESCRIPTION OF SUPPORT UNITS

The EUT has been tested as an independent unit together with other necessary accessories or support units. The following support units or accessories were used to form a representative test configuration during the tests.

NO.	PRODUCT	BRAND	MODEL NO.	SERIAL NO.	FCC ID
1	600Ω Load	NA	NA	NA	NA

NO.	SIGNAL CABLE DESCRIPTION OF THE ABOVE SUPPORT UNITS
1	NA

NOTE: All power cords of the above support units are non shielded (1.8m).



4. TEST TYPES AND RESULTS (FOR 802.11b & g 2412~2462MHz BAND)

4.1 CONDUCTED EMISSION MEASUREMENT

4.1.1 LIMITS OF CONDUCTED EMISSION MEASUREMENT

FREQUENCY OF EMISSION (MHz)	CONDUCTED LIMIT (dB μ V)	
	Quasi-peak	Average
0.15-0.5	66 to 56	56 to 46
0.5-5	56	46
5-30	60	50

- NOTE:**
1. The lower limit shall apply at the transition frequencies.
 2. The limit decreases in line with the logarithm of the frequency in the range of 0.15 to 0.50 MHz.
 3. All emanations from a class A/B digital device or system, including any network of conductors and apparatus connected thereto, shall not exceed the level of field strengths specified above.

4.1.2 TEST INSTRUMENTS

DESCRIPTION & MANUFACTURER	MODEL NO.	SERIAL NO.	CALIBRATED UNTIL
Test Receiver ROHDE & SCHWARZ	ESCS30	100291	Nov. 11, 2006
RF signal cable Woken	5D-FB	Cable-HYC01-01	Jan. 06, 2007
LISN ROHDE & SCHWARZ	ESH3-Z5	100312	Feb. 15, 2007
LISN ROHDE & SCHWARZ	ESH2-Z5	100104	Feb. 07, 2007
Software ADT	ADT_Cond_V3	NA	NA

- NOTE:**
1. The calibration interval of the above test instruments is 12 months and the calibrations are traceable to NML/ROC and NIST/USA.
 2. The test was performed in HwaYa Shielded Room 1.
 3. The VCCI Site Registration No. is C-2040.

4.1.3 TEST PROCEDURES

- a. The EUT was placed 0.4 meters from the conducting wall of the shielded room with EUT being connected to the power mains through a line impedance stabilization network (LISN). Other support units were connected to the power mains through another LISN. The two LISNs provide 50 ohm/ 50uH of coupling impedance for the measuring instrument.
- b. Both lines of the power mains connected to the EUT were checked for maximum conducted interference.
- c. The frequency range from 150kHz to 30MHz was searched. Emission levels under (Limit - 20dB) was not recorded.

4.1.4 DEVIATION FROM TEST STANDARD

No deviation

4.1.5 TEST SETUP

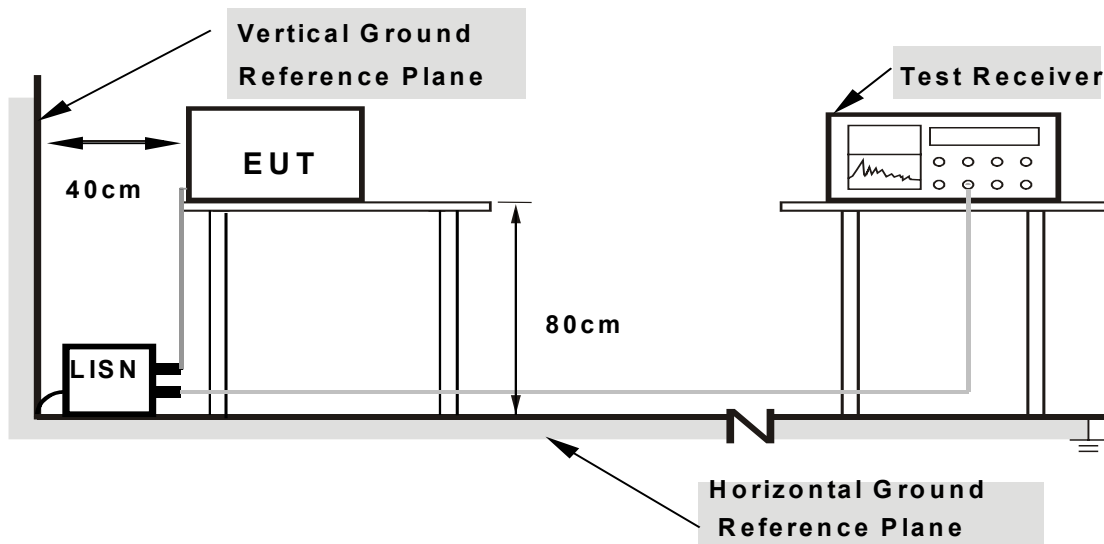

- Note:**
- 1.Support units were connected to second LISN.
 - 2.Both of LISNs (AMN) are 80 cm from EUT and at least 80 from other units and other metal planes

For the actual test configuration, please refer to the related item – Photographs of the Test Configuration.

4.1.6 EUT OPERATING CONDITIONS

- a. Placed the EUT on a testing table.
- b. The EUT ran a test program (provided by manufacturer) to enable all functions under transmission condition continuously at specific channel frequency.
- c. The EUT sent "H" messages to monitor.
- d. Step c was repeated.

4.1.7 TEST RESULTS

Conducted Worst-Case Data (For Adapter: PA-1650-02)

EUT TEST CONDITION		MEASUREMENT DETAIL	
CHANNEL	Channel 1	PHASE	Line 1
MODULATION TYPE	BPSK	6dB BANDWIDTH	9 kHz
TRANSFER RATE	6Mbps	ENVIRONMENTAL CONDITIONS	25deg. C, 68%RH, 991hPa
INPUT POWER (SYSTEM)	120Vac, 60 Hz	TEST MODE	A
TESTED BY	Morgan Chen		

No	Freq. [MHz]	Corr. Factor (dB)	Reading Value		Emission Level		Limit		Margin	
			[dB (uV)]		[dB (uV)]		[dB (uV)]		(dB)	
			Q.P.	AV.	Q.P.	AV.	Q.P.	AV.	Q.P.	AV.
1	0.150	0.10	48.61	-	48.71	-	66.00	56.00	-17.29	-
2	0.216	0.10	42.11	-	42.21	-	62.96	52.96	-20.75	-
3	0.287	0.10	35.48	-	35.58	-	60.62	50.62	-25.04	-
4	0.361	0.10	33.13	-	33.23	-	58.71	48.71	-25.48	-
5	0.580	0.13	34.67	-	34.80	-	56.00	46.00	-21.20	-
6	1.160	0.20	36.01	-	36.21	-	56.00	46.00	-19.79	-

- REMARKS:**
1. Q.P. and AV. are abbreviations of quasi-peak and average individually.
 2. "-": The Quasi-peak reading value also meets average limit and measurement with the average detector is unnecessary.
 3. The emission levels of other frequencies were very low against the limit.
 4. Margin value = Emission level - Limit value
 5. Correction factor = Insertion loss + Cable loss
 6. Emission Level = Correction Factor + Reading Value.

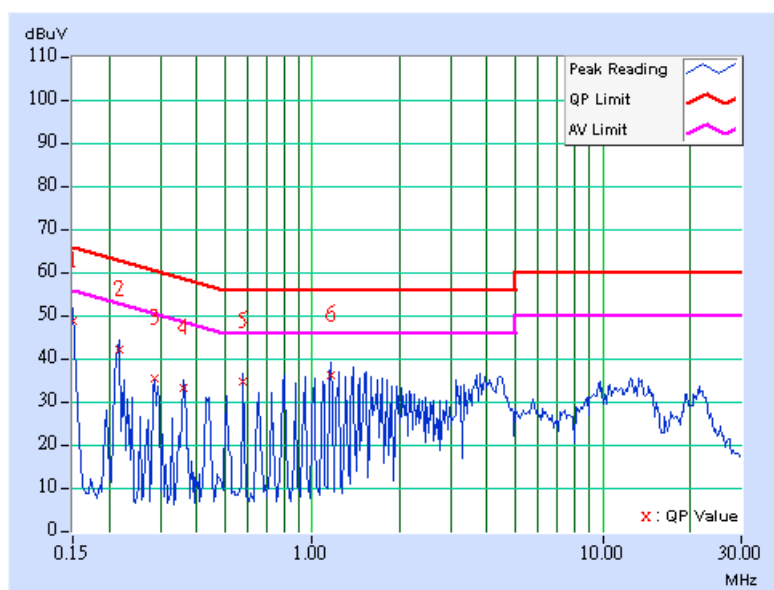

EUT TEST CONDITION		MEASUREMENT DETAIL	
CHANNEL	Channel 1	PHASE	Line 2
MODULATION TYPE	BPSK	6dB BANDWIDTH	9 kHz
TRANSFER RATE	6Mbps	ENVIRONMENTAL CONDITIONS	25deg. C, 68%RH, 991hPa
INPUT POWER (SYSTEM)	120Vac, 60 Hz	TEST MODE	A
TESTED BY	Morgan Chen		

No	Freq. [MHz]	Corr. Factor (dB)	Reading Value [dB (uV)]		Emission Level [dB (uV)]		Limit [dB (uV)]		Margin (dB)	
			Q.P.	AV.	Q.P.	AV.	Q.P.	AV.	Q.P.	AV.
			1	0.150	0.10	49.10	-	49.20	-	66.00
2	0.216	0.10	42.86	-	42.96	-	62.96	52.96	-20.00	-
3	0.291	0.10	36.62	-	36.72	-	60.51	50.51	-23.79	-
4	0.580	0.10	33.96	-	34.06	-	56.00	46.00	-21.94	-
5	0.943	0.10	34.62	-	34.72	-	56.00	46.00	-21.28	-
6	1.449	0.14	36.75	-	36.89	-	56.00	46.00	-19.11	-

- REMARKS:**
1. Q.P. and AV. are abbreviations of quasi-peak and average individually.
 2. "-": The Quasi-peak reading value also meets average limit and measurement with the average detector is unnecessary.
 3. The emission levels of other frequencies were very low against the limit.
 4. Margin value = Emission level - Limit value
 5. Correction factor = Insertion loss + Cable loss
 6. Emission Level = Correction Factor + Reading Value.

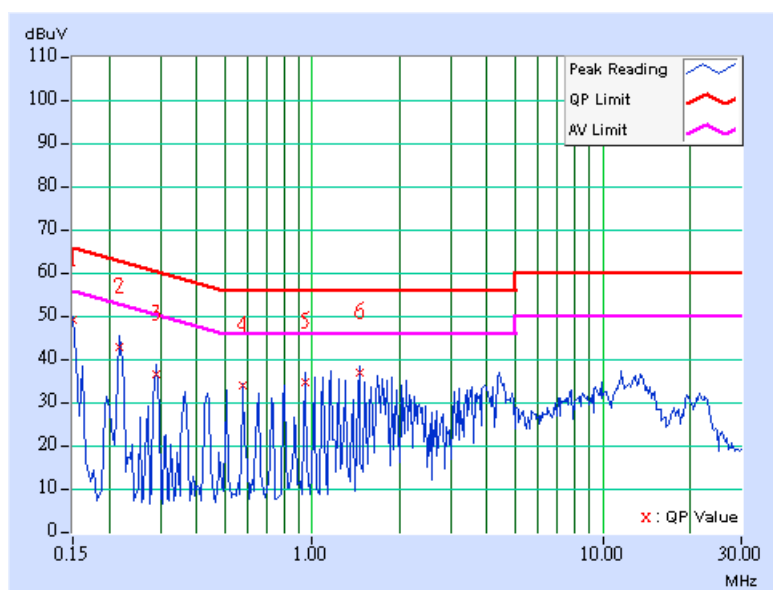

EUT TEST CONDITION		MEASUREMENT DETAIL	
CHANNEL	Channel 6	PHASE	Line 1
MODULATION TYPE	BPSK	6dB BANDWIDTH	9 kHz
TRANSFER RATE	6Mbps	ENVIRONMENTAL CONDITIONS	25deg. C, 68%RH, 991hPa
INPUT POWER (SYSTEM)	120Vac, 60 Hz	TEST MODE	A
TESTED BY	Morgan Chen		

No	Freq. [MHz]	Corr. Factor (dB)	Reading Value [dB (uV)]		Emission Level [dB (uV)]		Limit [dB (uV)]		Margin (dB)	
			Q.P.	AV.	Q.P.	AV.	Q.P.	AV.	Q.P.	AV.
			1	0.150	0.10	48.35	-	48.45	-	66.00
2	0.173	0.10	29.79	-	29.89	-	64.79	54.79	-34.90	-
3	0.216	0.10	42.71	-	42.81	-	62.96	52.96	-20.15	-
4	0.291	0.10	36.75	-	36.85	-	60.51	50.51	-23.66	-
5	0.365	0.10	31.80	-	31.90	-	58.62	48.62	-26.72	-
6	1.016	0.20	35.87	-	36.07	-	56.00	46.00	-19.93	-

- REMARKS:**
1. Q.P. and AV. are abbreviations of quasi-peak and average individually.
 2. "-": The Quasi-peak reading value also meets average limit and measurement with the average detector is unnecessary.
 3. The emission levels of other frequencies were very low against the limit.
 4. Margin value = Emission level - Limit value
 5. Correction factor = Insertion loss + Cable loss
 6. Emission Level = Correction Factor + Reading Value.

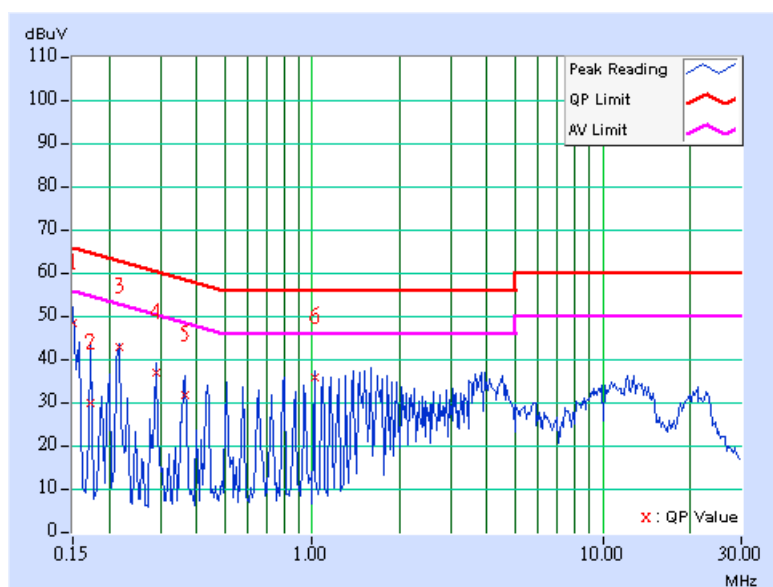

EUT TEST CONDITION		MEASUREMENT DETAIL	
CHANNEL	Channel 6	PHASE	Line 2
MODULATION TYPE	BPSK	6dB BANDWIDTH	9 kHz
TRANSFER RATE	6Mbps	ENVIRONMENTAL CONDITIONS	25deg. C, 68%RH, 991hPa
INPUT POWER (SYSTEM)	120Vac, 60 Hz	TEST MODE	A
TESTED BY	Morgan Chen		

No	Freq. [MHz]	Corr. Factor (dB)	Reading Value [dB (uV)]		Emission Level [dB (uV)]		Limit [dB (uV)]		Margin (dB)	
			Q.P.	AV.	Q.P.	AV.	Q.P.	AV.	Q.P.	AV.
			1	0.150	0.10	48.11	-	48.21	-	66.00
2	0.220	0.10	41.30	-	41.40	-	62.81	52.81	-21.41	-
3	0.291	0.10	36.31	-	36.41	-	60.51	50.51	-24.10	-
4	0.943	0.10	34.83	-	34.93	-	56.00	46.00	-21.07	-
5	1.449	0.14	37.14	-	37.28	-	56.00	46.00	-18.72	-
6	1.664	0.17	34.31	-	34.48	-	56.00	46.00	-21.52	-

- REMARKS:**
1. Q.P. and AV. are abbreviations of quasi-peak and average individually.
 2. "-": The Quasi-peak reading value also meets average limit and measurement with the average detector is unnecessary.
 3. The emission levels of other frequencies were very low against the limit.
 4. Margin value = Emission level - Limit value
 5. Correction factor = Insertion loss + Cable loss
 6. Emission Level = Correction Factor + Reading Value.

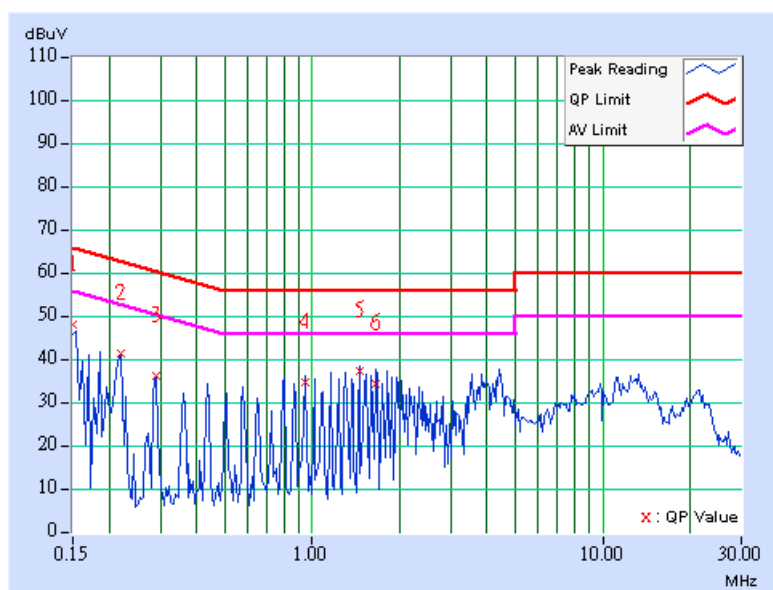

EUT TEST CONDITION		MEASUREMENT DETAIL	
CHANNEL	Channel 11	PHASE	Line 1
MODULATION TYPE	BPSK	6dB BANDWIDTH	9 kHz
TRANSFER RATE	6Mbps	ENVIRONMENTAL CONDITIONS	25deg. C, 68%RH, 991hPa
INPUT POWER (SYSTEM)	120Vac, 60 Hz	TEST MODE	A
TESTED BY	Morgan Chen		

No	Freq. [MHz]	Corr. Factor (dB)	Reading Value [dB (uV)]		Emission Level [dB (uV)]		Limit [dB (uV)]		Margin (dB)	
			Q.P.	AV.	Q.P.	AV.	Q.P.	AV.	Q.P.	AV.
			1	0.150	0.10	47.70	-	47.80	-	66.00
2	0.216	0.10	41.56	-	41.66	-	62.96	52.96	-21.30	-
3	0.291	0.10	36.73	-	36.83	-	60.51	50.51	-23.68	-
4	1.449	0.20	36.92	-	37.12	-	56.00	46.00	-18.88	-
5	3.844	0.45	35.75	-	36.20	-	56.00	46.00	-19.80	-
6	4.496	0.47	35.36	-	35.83	-	56.00	46.00	-20.17	-

- REMARKS:**
1. Q.P. and AV. are abbreviations of quasi-peak and average individually.
 2. "-": The Quasi-peak reading value also meets average limit and measurement with the average detector is unnecessary.
 3. The emission levels of other frequencies were very low against the limit.
 4. Margin value = Emission level - Limit value
 5. Correction factor = Insertion loss + Cable loss
 6. Emission Level = Correction Factor + Reading Value.

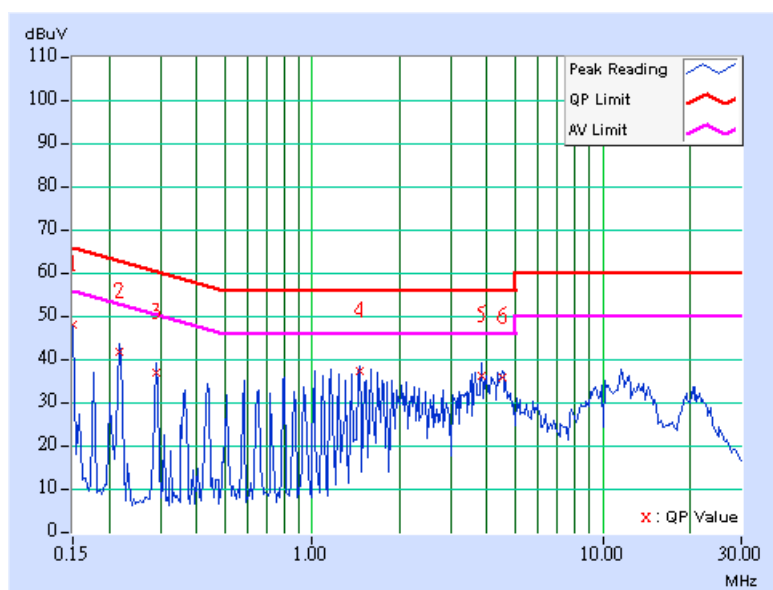

EUT TEST CONDITION		MEASUREMENT DETAIL	
CHANNEL	Channel 11	PHASE	Line 2
MODULATION TYPE	BPSK	6dB BANDWIDTH	9 kHz
TRANSFER RATE	6Mbps	ENVIRONMENTAL CONDITIONS	25deg. C, 68%RH, 991hPa
INPUT POWER (SYSTEM)	120Vac, 60 Hz	TEST MODE	A
TESTED BY	Morgan Chen		

No	Freq. [MHz]	Corr. Factor (dB)	Reading Value [dB (uV)]		Emission Level [dB (uV)]		Limit [dB (uV)]		Margin (dB)	
			Q.P.	AV.	Q.P.	AV.	Q.P.	AV.	Q.P.	AV.
	1	0.150	0.10	47.93	-	48.03	-	66.00	56.00	-17.97
2	0.216	0.10	42.09	-	42.19	-	62.96	52.96	-20.77	-
3	0.291	0.10	36.19	-	36.29	-	60.51	50.51	-24.22	-
4	0.435	0.10	32.78	-	32.88	-	57.15	47.15	-24.27	-
5	1.379	0.14	36.46	-	36.60	-	56.00	46.00	-19.40	-
6	3.770	0.35	34.58	-	34.93	-	56.00	46.00	-21.07	-

- REMARKS:**
1. Q.P. and AV. are abbreviations of quasi-peak and average individually.
 2. "-": The Quasi-peak reading value also meets average limit and measurement with the average detector is unnecessary.
 3. The emission levels of other frequencies were very low against the limit.
 4. Margin value = Emission level - Limit value
 5. Correction factor = Insertion loss + Cable loss
 6. Emission Level = Correction Factor + Reading Value.

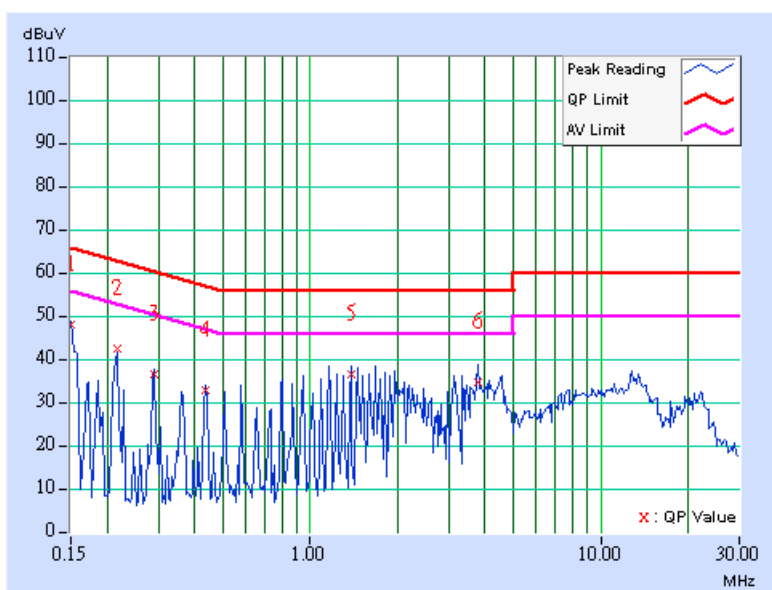

Conducted Worst-Case Data (For Adapter: 0335A1965)

EUT TEST CONDITION		MEASUREMENT DETAIL	
CHANNEL	Channel 1	PHASE	Line 1
MODULATION TYPE	BPSK	6dB BANDWIDTH	9 kHz
TRANSFER RATE	6Mbps	ENVIRONMENTAL CONDITIONS	25deg. C, 68%RH, 991hPa
INPUT POWER (SYSTEM)	120Vac, 60 Hz	TEST MODE	B
TESTED BY	Morgan Chen		

No	Freq. [MHz]	Corr. Factor (dB)	Reading Value [dB (uV)]		Emission Level [dB (uV)]		Limit [dB (uV)]		Margin (dB)	
			Q.P.	AV.	Q.P.	AV.	Q.P.	AV.	Q.P.	AV.
	1	0.150	0.10	50.13	-	50.23	-	66.00	56.00	-15.77
2	0.219	0.10	42.71	-	42.81	-	62.86	52.86	-20.05	-
3	0.291	0.10	39.41	-	39.51	-	60.51	50.51	-21.00	-
4	0.435	0.11	32.52	-	32.63	-	57.15	47.15	-24.53	-
5	1.313	0.20	27.80	-	28.00	-	56.00	46.00	-28.00	-
6	4.086	0.47	29.28	-	29.75	-	56.00	46.00	-26.25	-

- REMARKS:**
1. Q.P. and AV. are abbreviations of quasi-peak and average individually.
 2. "-": The Quasi-peak reading value also meets average limit and measurement with the average detector is unnecessary.
 3. The emission levels of other frequencies were very low against the limit.
 4. Margin value = Emission level - Limit value
 5. Correction factor = Insertion loss + Cable loss
 6. Emission Level = Correction Factor + Reading Value.

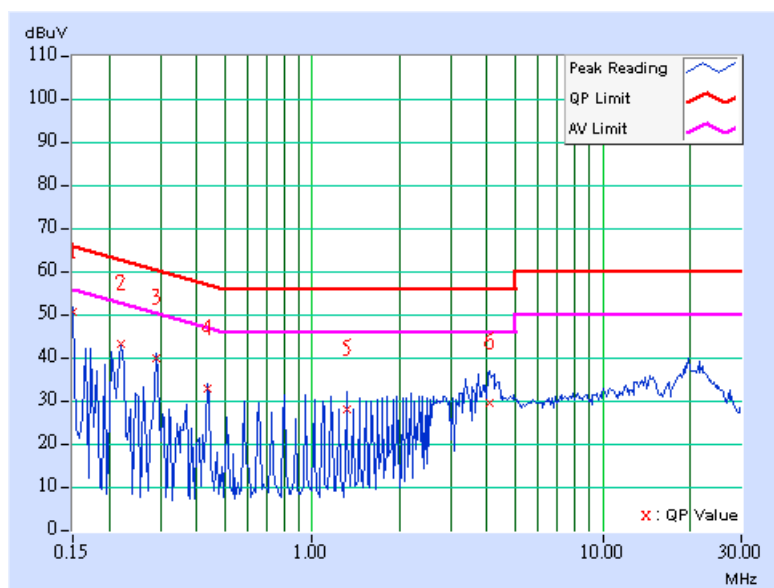

EUT TEST CONDITION		MEASUREMENT DETAIL	
CHANNEL	Channel 1	PHASE	Line 2
MODULATION TYPE	BPSK	6dB BANDWIDTH	9 kHz
TRANSFER RATE	6Mbps	ENVIRONMENTAL CONDITIONS	25deg. C, 68%RH, 991hPa
INPUT POWER (SYSTEM)	120Vac, 60 Hz	TEST MODE	B
TESTED BY	Morgan Chen		

No	Freq. [MHz]	Corr. Factor (dB)	Reading Value		Emission Level		Limit		Margin	
			[dB (uV)]		[dB (uV)]		[dB (uV)]		(dB)	
			Q.P.	AV.	Q.P.	AV.	Q.P.	AV.	Q.P.	AV.
1	0.150	0.10	48.67	-	48.77	-	66.00	56.00	-17.23	-
2	0.216	0.10	42.43	-	42.53	-	62.96	52.96	-20.43	-
3	0.291	0.10	38.78	-	38.88	-	60.51	50.51	-21.63	-
4	0.435	0.10	31.06	-	31.16	-	57.15	47.15	-25.99	-
5	0.655	0.10	27.44	-	27.54	-	56.00	46.00	-28.46	-
6	2.113	0.21	28.70	-	28.91	-	56.00	46.00	-27.09	-

- REMARKS:**
1. Q.P. and AV. are abbreviations of quasi-peak and average individually.
 2. "-": The Quasi-peak reading value also meets average limit and measurement with the average detector is unnecessary.
 3. The emission levels of other frequencies were very low against the limit.
 4. Margin value = Emission level - Limit value
 5. Correction factor = Insertion loss + Cable loss
 6. Emission Level = Correction Factor + Reading Value.

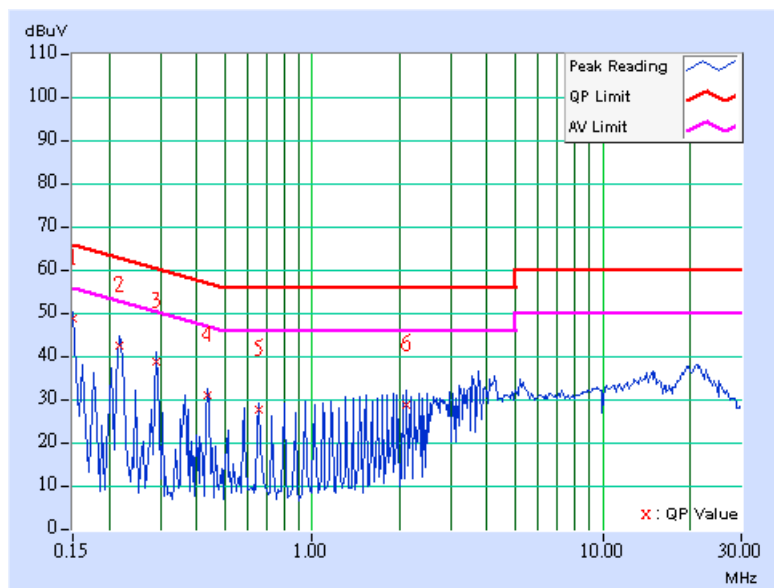

EUT TEST CONDITION		MEASUREMENT DETAIL	
CHANNEL	Channel 6	PHASE	Line 1
MODULATION TYPE	BPSK	6dB BANDWIDTH	9 kHz
TRANSFER RATE	6Mbps	ENVIRONMENTAL CONDITIONS	25deg. C, 68%RH, 991hPa
INPUT POWER (SYSTEM)	120Vac, 60 Hz	TEST MODE	B
TESTED BY	Morgan Chen		

No	Freq. [MHz]	Corr. Factor (dB)	Reading Value [dB (uV)]		Emission Level [dB (uV)]		Limit [dB (uV)]		Margin (dB)	
			Q.P.	AV.	Q.P.	AV.	Q.P.	AV.	Q.P.	AV.
			1	0.154	0.10	40.74	-	40.84	-	65.79
2	0.216	0.10	41.74	-	41.84	-	62.96	52.96	-21.12	-
3	0.291	0.10	39.24	-	39.34	-	60.49	50.49	-21.15	-
4	0.435	0.11	32.58	-	32.69	-	57.15	47.15	-24.47	-
5	0.654	0.14	29.75	-	29.89	-	56.00	46.00	-26.11	-
6	0.728	0.15	29.61	-	29.76	-	56.00	46.00	-26.24	-

- REMARKS:**
1. Q.P. and AV. are abbreviations of quasi-peak and average individually.
 2. "-": The Quasi-peak reading value also meets average limit and measurement with the average detector is unnecessary.
 3. The emission levels of other frequencies were very low against the limit.
 4. Margin value = Emission level - Limit value
 5. Correction factor = Insertion loss + Cable loss
 6. Emission Level = Correction Factor + Reading Value.

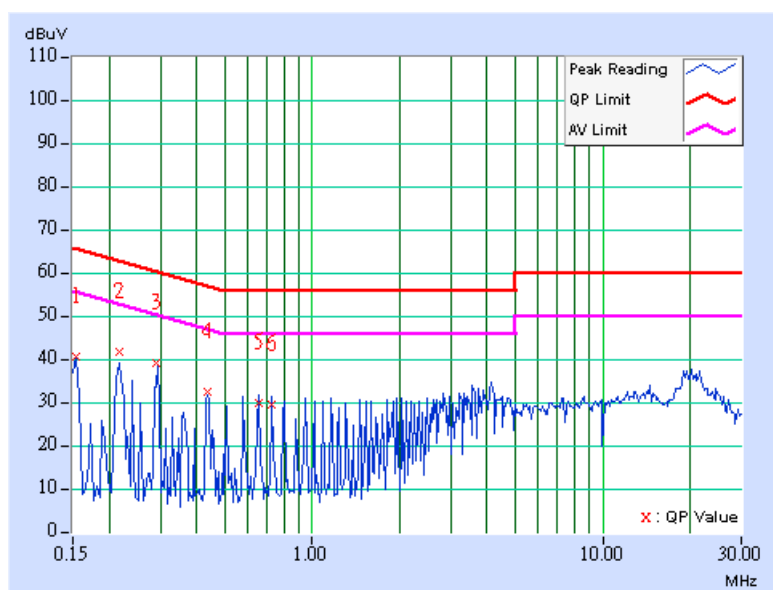

EUT TEST CONDITION		MEASUREMENT DETAIL	
CHANNEL	Channel 6	PHASE	Line 2
MODULATION TYPE	BPSK	6dB BANDWIDTH	9 kHz
TRANSFER RATE	6Mbps	ENVIRONMENTAL CONDITIONS	25deg. C, 68%RH, 991hPa
INPUT POWER (SYSTEM)	120Vac, 60 Hz	TEST MODE	B
TESTED BY	Morgan Chen		

No	Freq. [MHz]	Corr. Factor (dB)	Reading Value [dB (uV)]		Emission Level [dB (uV)]		Limit [dB (uV)]		Margin (dB)	
			Q.P.	AV.	Q.P.	AV.	Q.P.	AV.	Q.P.	AV.
	1	0.150	0.10	48.23	-	48.33	-	66.00	56.00	-17.67
2	0.158	0.10	37.85	-	37.95	-	65.58	55.58	-27.63	-
3	0.216	0.10	42.87	-	42.97	-	62.96	52.96	-19.99	-
4	0.295	0.10	34.85	-	34.95	-	60.40	50.40	-25.45	-
5	0.439	0.10	29.04	-	29.14	-	57.08	47.08	-27.94	-
6	0.654	0.10	27.61	-	27.71	-	56.00	46.00	-28.29	-

- REMARKS:**
1. Q.P. and AV. are abbreviations of quasi-peak and average individually.
 2. "-": The Quasi-peak reading value also meets average limit and measurement with the average detector is unnecessary.
 3. The emission levels of other frequencies were very low against the limit.
 4. Margin value = Emission level - Limit value
 5. Correction factor = Insertion loss + Cable loss
 6. Emission Level = Correction Factor + Reading Value.

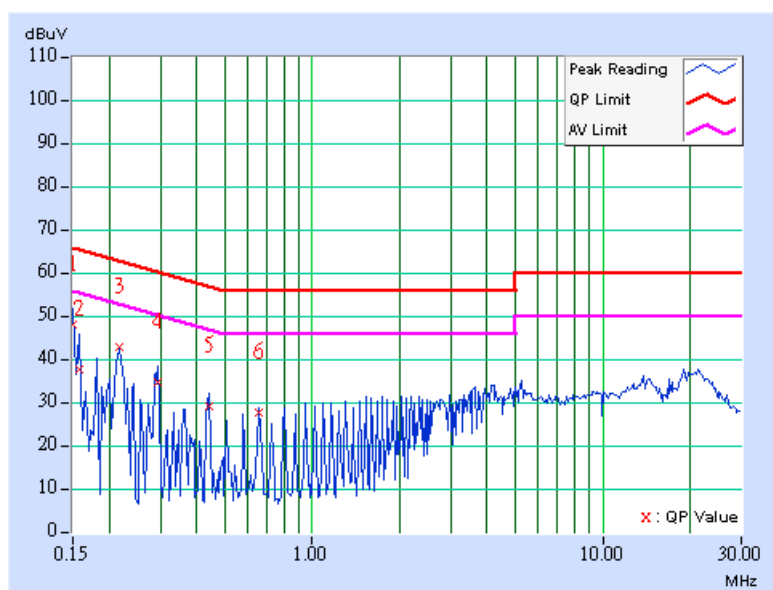

EUT TEST CONDITION		MEASUREMENT DETAIL	
CHANNEL	Channel 11	PHASE	Line 1
MODULATION TYPE	BPSK	6dB BANDWIDTH	9 kHz
TRANSFER RATE	6Mbps	ENVIRONMENTAL CONDITIONS	25deg. C, 68%RH, 991hPa
INPUT POWER (SYSTEM)	120Vac, 60 Hz	TEST MODE	B
TESTED BY	Morgan Chen		

No	Freq. [MHz]	Corr. Factor (dB)	Reading Value [dB (uV)]		Emission Level [dB (uV)]		Limit [dB (uV)]		Margin (dB)	
			Q.P.	AV.	Q.P.	AV.	Q.P.	AV.	Q.P.	AV.
	1	0.150	0.10	48.41	-	48.51	-	66.00	56.00	-17.49
2	0.173	0.10	36.48	-	36.58	-	64.79	54.79	-28.21	-
3	0.232	0.10	30.50	-	30.60	-	62.38	52.38	-31.78	-
4	0.291	0.10	38.68	-	38.78	-	60.51	50.51	-21.73	-
5	1.672	0.20	29.49	-	29.69	-	56.00	46.00	-26.31	-
6	4.145	0.47	33.28	-	33.75	-	56.00	46.00	-22.25	-

- REMARKS:**
1. Q.P. and AV. are abbreviations of quasi-peak and average individually.
 2. "-": The Quasi-peak reading value also meets average limit and measurement with the average detector is unnecessary.
 3. The emission levels of other frequencies were very low against the limit.
 4. Margin value = Emission level - Limit value
 5. Correction factor = Insertion loss + Cable loss
 6. Emission Level = Correction Factor + Reading Value.

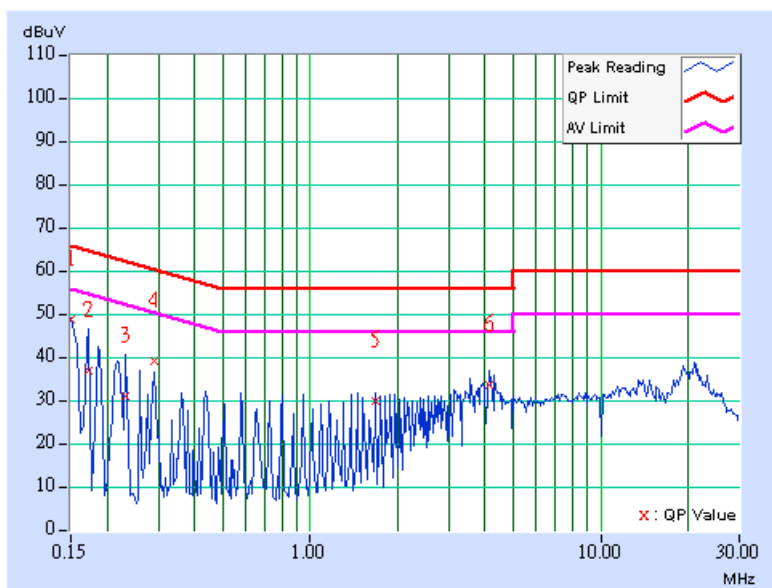

EUT TEST CONDITION		MEASUREMENT DETAIL	
CHANNEL	Channel 11	PHASE	Line 2
MODULATION TYPE	BPSK	6dB BANDWIDTH	9 kHz
TRANSFER RATE	6Mbps	ENVIRONMENTAL CONDITIONS	25deg. C, 68%RH, 991hPa
INPUT POWER (SYSTEM)	120Vac, 60 Hz	TEST MODE	B
TESTED BY	Morgan Chen		

No	Freq. [MHz]	Corr. Factor (dB)	Reading Value [dB (uV)]		Emission Level [dB (uV)]		Limit [dB (uV)]		Margin (dB)	
			Q.P.	AV.	Q.P.	AV.	Q.P.	AV.	Q.P.	AV.
	1	0.150	0.10	48.43	-	48.53	-	66.00	56.00	-17.47
2	0.216	0.10	41.78	-	41.88	-	62.96	52.96	-21.08	-
3	0.288	0.10	37.47	-	37.57	-	60.57	50.57	-23.00	-
4	0.435	0.10	30.98	-	31.08	-	57.15	47.15	-26.07	-
5	0.580	0.10	28.68	-	28.78	-	56.00	46.00	-27.22	-
6	1.164	0.12	29.06	-	29.18	-	56.00	46.00	-26.82	-

- REMARKS:**
1. Q.P. and AV. are abbreviations of quasi-peak and average individually.
 2. "-": The Quasi-peak reading value also meets average limit and measurement with the average detector is unnecessary.
 3. The emission levels of other frequencies were very low against the limit.
 4. Margin value = Emission level - Limit value
 5. Correction factor = Insertion loss + Cable loss
 6. Emission Level = Correction Factor + Reading Value.

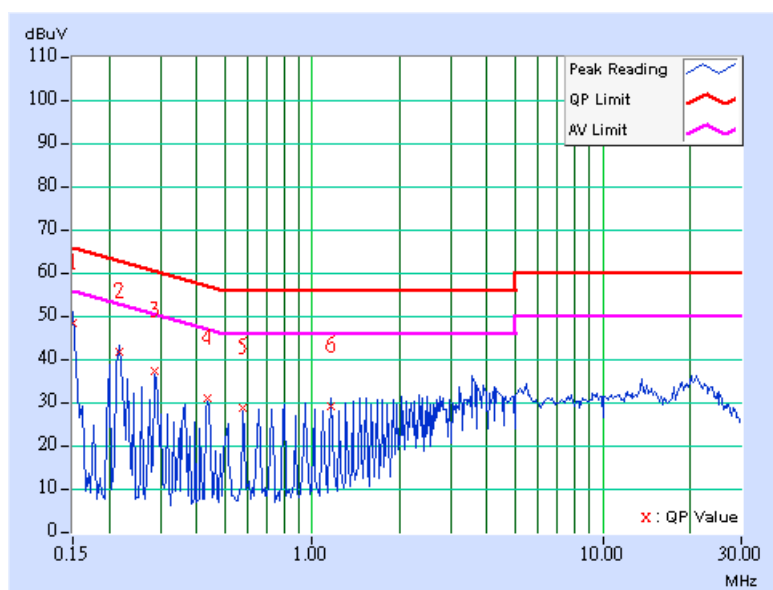

4.2 RADIATED EMISSION MEASUREMENT

4.2.1 LIMITS OF RADIATED EMISSION MEASUREMENT

Emissions radiated outside of the specified bands, shall be according to the general radiated limits in 15.209 as following:

Frequencies (MHz)	Field strength (microvolts/meter)	Measurement distance (meters)
0.009-0.490	2400/F(kHz)	300
0.490-1.705	24000/F(kHz)	30
1.705-30.0	30	30
30-88	100	3
88-216	150	3
216-960	200	3
Above 960	500	3

NOTE:

1. The lower limit shall apply at the transition frequencies.
2. Emission level (dBuV/m) = 20 log Emission level (uV/m).
3. As shown in 15.35(b), for frequencies above 1000MHz, the field strength limits are based on average detector, however, the peak field strength of any emission shall not exceed the maximum permitted average limits, specified above by more than 20dB under any condition of modulation.



4.2.2 TEST INSTRUMENTS

DESCRIPTION & MANUFACTURER	MODEL NO.	SERIAL NO.	CALIBRATED UNTIL
Test Receiver ROHDE & SCHWARZ	ESI7	838496/016	Jan. 01, 2007
Spectrum Analyzer ROHDE & SCHWARZ	FSP40	100041	Dec. 04, 2006
BILOG Antenna SCHWARZBECK	VULB9168	9168-155	Jan. 15, 2007
HORN Antenna SCHWARZBECK	BBHA 9120D	9120D-404	Jan. 01, 2007
HORN Antenna SCHWARZBECK	BBHA 9170	BBHA9170242	Jan. 19, 2007
Preamplifier Agilent	8449B	3008A01960	Nov. 09, 2006
RF signal cable HUBER+SUHNNER	SUCOFLEX 104	219268/4	Dec. 20, 2006
RF signal cable HUBER+SUHNNER	SUCOFLEX 104	230129/4	Dec. 20, 2006
Software ADT.	ADT_Radiated_V5.14	NA	NA
Antenna Tower inn-co GmbH	MA 4000	010303	NA
Antenna Tower Controller inn-co GmbH	CO2000	019303	NA
Turn Table ADT.	TT100.	TT93021704	NA
Turn Table Controller ADT.	SC100.	SC93021704	NA

- NOTE:**
1. The calibration interval of the above test instruments is 12 months and the calibrations are traceable to NML/ROC and NIST/USA.
 2. The test was performed in HwaYa Chamber 3.
 3. The horn antenna and HP preamplifier (model: 8449B) are used only for the measurement of emission frequency above 1GHz if tested.
 4. The IC Site Registration No. is IC4924-4.

4.2.3 TEST PROCEDURES

- a. The EUT was placed on the top of a rotating table 0.8 meters above the ground at a 3 meters semi-anechoic chamber. The table was rotated 360 degrees to determine the position of the highest radiation.
- b. The EUT was set 3 meters away from the interference-receiving antenna, which was mounted on the top of a variable-height antenna tower.
- c. The antenna is a broadband antenna, and its height is varied from one meter to four meters above the ground to determine the maximum value of the field strength. Both horizontal and vertical polarizations of the antenna are set to make the measurement.
- d. For each suspected emission, the EUT was arranged to its worst case and then the antenna was tuned to heights from 1 meter to 4 meters and the rotatable table was turned from 0 degrees to 360 degrees to find the maximum reading.
- e. The test-receiver system was set to Peak Detect Function and Specified Bandwidth with Maximum Hold Mode.
- f. If the emission level of the EUT in peak mode was lower than the limit specified, then testing could be stopped and the peak values of the EUT would be reported. Otherwise the emissions would be re-tested one by one using peak, quasi-peak or average method as specified and then reported in a data sheet.

NOTE:

1. The resolution bandwidth and video bandwidth of test receiver/spectrum analyzer is 120kHz for Quasi-peak detection at frequency below 1GHz.
2. The resolution bandwidth and video bandwidth of test receiver/spectrum analyzer is 1 MHz for Peak detection (PK) at frequency above 1GHz.
3. The resolution bandwidth of test receiver/spectrum analyzer is 1 MHz and the video bandwidth are 100Hz(for 802.11b) and 1kHz (for 802.11g) for Average detection (AV) at frequency above 1GHz.

4.2.4 DEVIATION FROM TEST STANDARD

No deviation

4.2.5 TEST SETUP

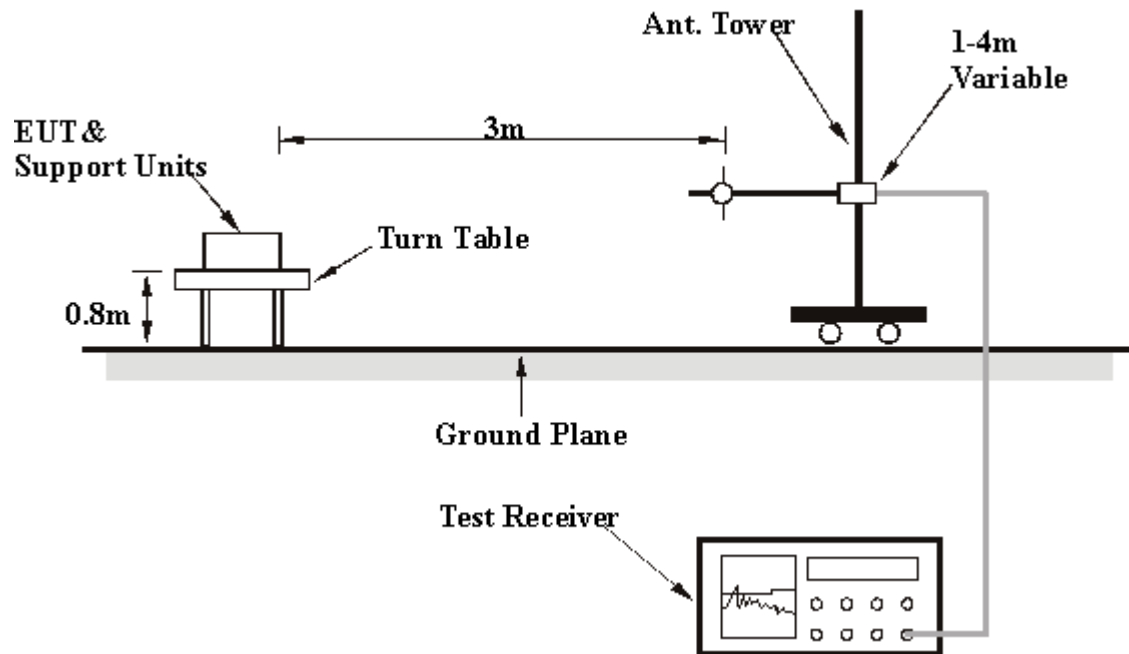

For the actual test configuration, please refer to the related item – Photographs of the Test Configuration.

4.2.6 EUT OPERATING CONDITIONS

Same as 4.1.6



4.2.7 TEST RESULTS

Below 1GHz Worst-Case Data (For Adapter: PA-1650-02)

EUT TEST CONDITION		MEASUREMENT DETAIL	
CHANNEL	Channel 11	FREQUENCY RANGE	Below 1000MHz
MODULATION TYPE	DBPSK	DETECTOR FUNCTION	Quasi-Peak
TRANSFER RATE	1Mbps	ENVIRONMENTAL CONDITIONS	22deg. C, 64%RH, 991hPa
INPUT POWER (SYSTEM)	120Vac, 60 Hz	TEST MODE	A
TESTED BY	Brad Wu		

ANTENNA POLARITY & TEST DISTANCE: HORIZONTAL AT 3 M								
No.	Freq. (MHz)	Emission Level (dBuV/m)	Limit (dBuV/m)	Margin (dB)	Antenna Height (m)	Table Angle (Degree)	Raw Value (dBuV)	Correction Factor (dB/m)
1	168.02	39.18 QP	43.50	-4.32	1.25 H	145	26.48	12.70
2	272.99	34.50 QP	46.00	-11.50	1.75 H	91	20.26	14.24
3	576.23	33.75 QP	46.00	-12.25	1.00 H	31	11.94	21.81
4	768.68	33.41 QP	46.00	-12.59	1.50 H	58	7.50	25.91
5	863.93	38.28 QP	46.00	-7.72	1.25 H	28	11.35	26.94
6	912.53	39.14 QP	46.00	-6.86	1.25 H	316	11.11	28.04

ANTENNA POLARITY & TEST DISTANCE: VERTICAL AT 3 M								
No.	Freq. (MHz)	Emission Level (dBuV/m)	Limit (dBuV/m)	Margin (dB)	Antenna Height (m)	Table Angle (Degree)	Raw Value (dBuV)	Correction Factor (dB/m)
1	168.02	41.27 QP	43.50	-2.23	1.25 V	262	28.57	12.70
2	272.99	30.19 QP	46.00	-15.81	1.25 V	19	15.95	14.24
3	409.06	34.06 QP	46.00	-11.94	1.00 V	34	16.10	17.96
4	531.52	36.03 QP	46.00	-9.97	1.00 V	181	15.42	20.61
5	863.93	36.71 QP	46.00	-9.29	1.50 V	160	9.77	26.94
6	912.53	40.77 QP	46.00	-5.23	1.00 V	13	12.73	28.04

- REMARKS:**
1. Emission level(dBuV/m)=Raw Value(dBuV) + Correction Factor(dB/m)
 2. Correction Factor(dB/m) = Antenna Factor (dB/m) + Cable Factor (dB)
 3. The other emission levels were very low against the limit.
 4. Margin value = Emission level – Limit value.



Below 1GHz Worst-Case Data (For Adapter: 0335A1965)

EUT TEST CONDITION		MEASUREMENT DETAIL	
CHANNEL	Channel 11	FREQUENCY RANGE	Below 1000MHz
MODULATION TYPE	DBPSK	DETECTOR FUNCTION	Quasi-Peak
TRANSFER RATE	1Mbps	ENVIRONMENTAL CONDITIONS	22deg. C, 64%RH, 991hPa
INPUT POWER (SYSTEM)	120Vac, 60 Hz	TEST MODE	B
TESTED BY	Brad Wu		

ANTENNA POLARITY & TEST DISTANCE: HORIZONTAL AT 3 M								
No.	Freq. (MHz)	Emission Level (dBuV/m)	Limit (dBuV/m)	Margin (dB)	Antenna Height (m)	Table Angle (Degree)	Raw Value (dBuV)	Correction Factor (dB/m)
1	168.02	34.99 QP	43.50	-8.51	1.00 H	268	22.29	12.70
2	272.99	33.05 QP	46.00	-12.95	1.00 H	253	18.80	14.24
3	527.64	33.03 QP	46.00	-12.97	1.25 H	223	12.51	20.53
4	751.18	33.10 QP	46.00	-12.90	1.25 H	322	7.31	25.79
5	863.93	39.29 QP	46.00	-6.71	1.00 H	322	12.35	26.94
6	912.53	38.78 QP	46.00	-7.22	1.50 H	160	10.74	28.04

ANTENNA POLARITY & TEST DISTANCE: VERTICAL AT 3 M								
No.	Freq. (MHz)	Emission Level (dBuV/m)	Limit (dBuV/m)	Margin (dB)	Antenna Height (m)	Table Angle (Degree)	Raw Value (dBuV)	Correction Factor (dB/m)
1	168.02	38.77 QP	43.50	-4.73	1.25 V	181	26.07	12.70
2	407.11	34.16 QP	46.00	-11.84	1.00 V	304	16.24	17.93
3	533.47	36.91 QP	46.00	-9.09	1.00 V	76	16.26	20.65
4	751.18	34.94 QP	46.00	-11.06	1.00 V	70	9.15	25.79
5	863.93	36.02 QP	46.00	-9.98	1.00 V	358	9.09	26.94
6	912.53	40.29 QP	46.00	-5.71	1.00 V	352	12.25	28.04

- REMARKS:**
1. Emission level(dBuV/m)=Raw Value(dBuV) + Correction Factor(dB/m)
 2. Correction Factor(dB/m) = Antenna Factor (dB/m) + Cable Factor (dB)
 3. The other emission levels were very low against the limit.
 4. Margin value = Emission level – Limit value.



802.11b DSSS modulation

EUT TEST CONDITION		MEASUREMENT DETAIL	
CHANNEL	Channel 1	FREQUENCY RANGE	1 ~ 25GHz
MODULATION TYPE	DBPSK	DETECTOR FUNCTION	Peak(PK) Average (AV)
TRANSFER RATE	1Mbps	ENVIRONMENTAL CONDITIONS	22deg. C, 63%RH, 991hPa
INPUT POWER (SYSTEM)	120Vac, 60 Hz	TESTED BY	Brad Wu

ANTENNA POLARITY & TEST DISTANCE: HORIZONTAL AT 3 M								
No.	Freq. (MHz)	Emission Level (dBuV/m)	Limit (dBuV/m)	Margin (dB)	Antenna Height (m)	Table Angle (Degree)	Raw Value (dBuV)	Correction Factor (dB/m)
1	1250.00	42.13 PK	74.00	-31.87	1.02 H	14	13.74	28.39
1	1250.00	37.41 AV	54.00	-16.59	1.02 H	14	9.01	28.39
2	2390.00	45.87 PK	74.00	-28.13	1.47 H	356	13.76	32.11
2	2390.00	42.37 AV	54.00	-11.63	1.47 H	356	10.26	32.11
3	*2412.00	102.95 PK			1.47 H	356	70.76	32.19
3	*2412.00	99.45 AV			1.47 H	356	67.26	32.19
4	4824.00	48.72 PK	74.00	-25.28	1.04 H	236	10.07	38.65
4	4824.00	36.39 AV	54.00	-17.61	1.04 H	236	-2.26	38.65

ANTENNA POLARITY & TEST DISTANCE: VERTICAL AT 3 M								
No.	Freq. (MHz)	Emission Level (dBuV/m)	Limit (dBuV/m)	Margin (dB)	Antenna Height (m)	Table Angle (Degree)	Raw Value (dBuV)	Correction Factor (dB/m)
1	1250.00	48.20 PK	74.00	-25.80	1.00 V	111	19.81	28.39
1	1250.00	38.36 AV	54.00	-15.64	1.00 V	111	9.96	28.39
2	2390.00	49.01 PK	74.00	-24.99	1.72 V	353	16.90	32.11
2	2390.00	45.54 AV	54.00	-8.46	1.72 V	353	13.43	32.11
3	*2412.00	106.09 PK			1.72 V	353	73.90	32.19
3	*2412.00	102.62 AV			1.72 V	353	70.43	32.19
4	4824.00	50.94 PK	74.00	-23.06	1.00 V	214	12.29	38.65
4	4824.00	38.52 AV	54.00	-15.48	1.00 V	214	-0.13	38.65

- REMARKS:**
1. Emission level(dBuV/m)=Raw Value(dBuV) + Correction Factor(dB/m)
 2. Correction Factor(dB/m) = Antenna Factor (dB/m) + Cable Factor (dB)
 3. The other emission levels were very low against the limit.
 4. Margin value = Emission level – Limit value.
 5. “ * “ : Fundamental frequency.



EUT TEST CONDITION		MEASUREMENT DETAIL	
CHANNEL	Channel 6	FREQUENCY RANGE	1 ~ 25GHz
MODULATION TYPE	DBPSK	DETECTOR FUNCTION	Peak(PK) Average (AV)
TRANSFER RATE	1Mbps	ENVIRONMENTAL CONDITIONS	22deg. C, 63%RH, 991hPa
INPUT POWER (SYSTEM)	120Vac, 60 Hz	TESTED BY	Brad Wu

ANTENNA POLARITY & TEST DISTANCE: HORIZONTAL AT 3 M								
No.	Freq. (MHz)	Emission Level (dBuV/m)	Limit (dBuV/m)	Margin (dB)	Antenna Height (m)	Table Angle (Degree)	Raw Value (dBuV)	Correction Factor (dB/m)
1	1250.00	42.29 PK	74.00	-31.71	1.02 H	65	13.89	28.39
1	1250.00	37.58 AV	54.00	-16.42	1.02 H	65	9.18	28.39
2	*2437.00	102.53 PK			1.41 H	350	70.24	32.29
2	*2437.00	99.12 AV			1.41 H	350	66.83	32.29
3	4874.00	48.72 PK	74.00	-25.28	1.03 H	227	9.93	38.79
3	4874.00	36.41 AV	54.00	-17.59	1.03 H	227	-2.38	38.79

ANTENNA POLARITY & TEST DISTANCE: VERTICAL AT 3 M								
No.	Freq. (MHz)	Emission Level (dBuV/m)	Limit (dBuV/m)	Margin (dB)	Antenna Height (m)	Table Angle (Degree)	Raw Value (dBuV)	Correction Factor (dB/m)
1	1250.00	48.95 PK	74.00	-25.05	1.07 V	162	20.56	28.39
1	1250.00	39.07 AV	54.00	-14.93	1.07 V	162	10.68	28.39
2	*2437.00	105.88 PK			1.68 V	352	73.59	32.29
2	*2437.00	102.47 AV			1.68 V	352	70.18	32.29
3	4874.00	50.76 PK	74.00	-23.24	1.01 V	204	11.97	38.79
3	4874.00	38.35 AV	54.00	-15.65	1.01 V	204	-0.44	38.79

- REMARKS:**
1. Emission level(dBuV/m)=Raw Value(dBuV) + Correction Factor(dB/m)
 2. Correction Factor(dB/m) = Antenna Factor (dB/m) + Cable Factor (dB)
 3. The other emission levels were very low against the limit.
 4. Margin value = Emission level – Limit value.
 5. “ * “ : Fundamental frequency.



EUT TEST CONDITION		MEASUREMENT DETAIL	
CHANNEL	Channel 11	FREQUENCY RANGE	1 ~ 25GHz
MODULATION TYPE	DBPSK	DETECTOR FUNCTION	Peak(PK) Average (AV)
TRANSFER RATE	1Mbps	ENVIRONMENTAL CONDITIONS	22deg. C, 63%RH, 991hPa
INPUT POWER (SYSTEM)	120Vac, 60 Hz	TESTED BY	Brad Wu

ANTENNA POLARITY & TEST DISTANCE: HORIZONTAL AT 3 M								
No.	Freq. (MHz)	Emission Level (dBuV/m)	Limit (dBuV/m)	Margin (dB)	Antenna Height (m)	Table Angle (Degree)	Raw Value (dBuV)	Correction Factor (dB/m)
1	1250.00	42.34 PK	74.00	-31.66	1.06 H	29	13.95	28.39
1	1250.00	37.68 AV	54.00	-16.32	1.06 H	29	9.29	28.39
2	*2462.00	102.41 PK			1.45 H	352	70.03	32.38
2	*2462.00	98.96 AV			1.45 H	352	66.58	32.38
3	2483.50	48.29 PK	74.00	-25.71	1.45 H	352	15.83	32.46
3	2483.50	44.84 AV	54.00	-9.16	1.45 H	352	12.38	32.46
4	4924.00	48.93 PK	74.00	-25.07	1.08 H	219	10.01	38.92
4	4924.00	36.62 AV	54.00	-17.38	1.08 H	219	-2.30	38.92

ANTENNA POLARITY & TEST DISTANCE: VERTICAL AT 3 M								
No.	Freq. (MHz)	Emission Level (dBuV/m)	Limit (dBuV/m)	Margin (dB)	Antenna Height (m)	Table Angle (Degree)	Raw Value (dBuV)	Correction Factor (dB/m)
1	1250.00	48.61 PK	74.00	-25.39	1.03 V	142	20.21	28.39
1	1250.00	38.77 AV	54.00	-15.23	1.03 V	142	10.38	28.39
2	*2462.00	105.52 PK			1.70 V	348	73.14	32.38
2	*2462.00	102.14 AV			1.70 V	348	69.76	32.38
3	2483.50	51.40 PK	74.00	-22.60	1.38 V	33	18.94	32.46
3	2483.50	48.02 AV	54.00	-5.98	1.38 V	33	15.56	32.46
4	4924.00	50.82 PK	74.00	-23.18	1.06 V	195	11.90	38.92
4	4924.00	38.41 AV	54.00	-15.59	1.06 V	195	-0.51	38.92

- REMARKS:**
1. Emission level(dBuV/m)=Raw Value(dBuV) + Correction Factor(dB/m)
 2. Correction Factor(dB/m) = Antenna Factor (dB/m) + Cable Factor (dB)
 3. The other emission levels were very low against the limit.
 4. Margin value = Emission level – Limit value.
 5. “ * “ : Fundamental frequency.

802.11g OFDM modulation

EUT TEST CONDITION		MEASUREMENT DETAIL	
CHANNEL	Channel 1	FREQUENCY RANGE	1 ~ 25GHz
MODULATION TYPE	BPSK	DETECTOR FUNCTION	Peak(PK) Average (AV)
TRANSFER RATE	6Mbps	ENVIRONMENTAL CONDITIONS	22deg. C, 63%RH, 991hPa
INPUT POWER (SYSTEM)	120Vac, 60 Hz	TESTED BY	Brad Wu

ANTENNA POLARITY & TEST DISTANCE: HORIZONTAL AT 3 M								
No.	Freq. (MHz)	Emission Level (dBuV/m)	Limit (dBuV/m)	Margin (dB)	Antenna Height (m)	Table Angle (Degree)	Raw Value (dBuV)	Correction Factor (dB/m)
1	1250.00	42.26 PK	74.00	-31.74	1.09 H	57	13.86	28.39
1	1250.00	37.58 AV	54.00	-16.42	1.09 H	57	9.18	28.39
2	2390.00	54.11 PK	74.00	-19.89	1.64 H	18	22.00	32.11
2	2390.00	45.26 AV	54.00	-8.74	1.64 H	18	13.15	32.11
3	*2412.00	100.83 PK			1.64 H	18	68.64	32.19
3	*2412.00	91.98 AV			1.64 H	18	59.79	32.19
4	4824.00	48.63 PK	74.00	-25.37	1.09 H	241	9.98	38.65
4	4824.00	36.31 AV	54.00	-17.69	1.09 H	241	-2.34	38.65

ANTENNA POLARITY & TEST DISTANCE: VERTICAL AT 3 M								
No.	Freq. (MHz)	Emission Level (dBuV/m)	Limit (dBuV/m)	Margin (dB)	Antenna Height (m)	Table Angle (Degree)	Raw Value (dBuV)	Correction Factor (dB/m)
1	1250.00	48.35 PK	74.00	-25.65	1.03 V	108	19.96	28.39
1	1250.00	38.46 AV	54.00	-15.54	1.03 V	108	10.07	28.39
2	2390.00	56.62 PK	74.00	-17.38	1.43 V	42	24.51	32.11
2	2390.00	47.74 AV	54.00	-6.26	1.43 V	42	15.63	32.11
3	*2412.00	103.34 PK			1.43 V	42	71.15	32.19
3	*2412.00	94.46 AV			1.43 V	42	62.27	32.19
4	4824.00	50.28 PK	74.00	-23.72	1.03 V	196	11.63	38.65
4	4824.00	37.85 AV	54.00	-16.15	1.03 V	196	-0.80	38.65

- REMARKS:**
1. Emission level(dBuV/m)=Raw Value(dBuV) + Correction Factor(dB/m)
 2. Correction Factor(dB/m) = Antenna Factor (dB/m) + Cable Factor (dB)
 3. The other emission levels were very low against the limit.
 4. Margin value = Emission level – Limit value.
 5. “ * ” : Fundamental frequency.



EUT TEST CONDITION		MEASUREMENT DETAIL	
CHANNEL	Channel 6	FREQUENCY RANGE	1 ~ 25GHz
MODULATION TYPE	BPSK	DETECTOR FUNCTION	Peak(PK) Average (AV)
TRANSFER RATE	6Mbps	ENVIRONMENTAL CONDITIONS	22deg. C, 63%RH, 991hPa
INPUT POWER (SYSTEM)	120Vac, 60 Hz	TESTED BY	Brad Wu

ANTENNA POLARITY & TEST DISTANCE: HORIZONTAL AT 3 M								
No.	Freq. (MHz)	Emission Level (dBuV/m)	Limit (dBuV/m)	Margin (dB)	Antenna Height (m)	Table Angle (Degree)	Raw Value (dBuV)	Correction Factor (dB/m)
1	1250.00	42.19 PK	74.00	-31.81	1.08 H	66	13.79	28.39
1	1250.00	37.42 AV	54.00	-16.58	1.08 H	66	9.03	28.39
2	*2437.00	100.98 PK			1.59 H	36	68.69	32.29
2	*2437.00	92.11 AV			1.59 H	36	59.82	32.29
3	4874.00	48.26 PK	74.00	-25.74	1.10 H	257	9.47	38.79
3	4874.00	35.94 AV	54.00	-18.06	1.10 H	257	-2.85	38.79

ANTENNA POLARITY & TEST DISTANCE: VERTICAL AT 3 M								
No.	Freq. (MHz)	Emission Level (dBuV/m)	Limit (dBuV/m)	Margin (dB)	Antenna Height (m)	Table Angle (Degree)	Raw Value (dBuV)	Correction Factor (dB/m)
1	1250.00	48.67 PK	74.00	-25.33	1.17 V	206	20.28	28.39
1	1250.00	38.79 AV	54.00	-15.21	1.17 V	206	10.39	28.39
2	*2437.00	103.52 PK			1.01 V	73	71.23	32.29
2	*2437.00	94.71 AV			1.01 V	73	62.42	32.29
3	4874.00	50.73 PK	74.00	-23.27	1.05 V	201	11.94	38.79
3	4874.00	38.31 AV	54.00	-15.69	1.05 V	201	-0.48	38.79

- REMARKS:**
1. Emission level(dBuV/m)=Raw Value(dBuV) + Correction Factor(dB/m)
 2. Correction Factor(dB/m) = Antenna Factor (dB/m) + Cable Factor (dB)
 3. The other emission levels were very low against the limit.
 4. Margin value = Emission level – Limit value.
 5. “ * “ : Fundamental frequency.



EUT TEST CONDITION		MEASUREMENT DETAIL	
CHANNEL	Channel 11	FREQUENCY RANGE	1 ~ 25GHz
MODULATION TYPE	BPSK	DETECTOR FUNCTION	Peak(PK) Average (AV)
TRANSFER RATE	6Mbps	ENVIRONMENTAL CONDITIONS	22deg. C, 63%RH, 991hPa
INPUT POWER (SYSTEM)	120Vac, 60 Hz	TESTED BY	Brad Wu

ANTENNA POLARITY & TEST DISTANCE: HORIZONTAL AT 3 M								
No.	Freq. (MHz)	Emission Level (dBuV/m)	Limit (dBuV/m)	Margin (dB)	Antenna Height (m)	Table Angle (Degree)	Raw Value (dBuV)	Correction Factor (dB/m)
1	1250.00	42.07 PK	74.00	-31.93	1.01 H	42	13.68	28.39
1	1250.00	37.29 AV	54.00	-16.71	1.01 H	42	8.89	28.39
2	*2462.00	100.91 PK			1.62 H	23	68.53	32.38
2	*2462.00	92.04 AV			1.62 H	23	59.66	32.38
3	2483.50	54.32 PK	74.00	-19.68	1.62 H	23	21.86	32.46
3	2483.50	45.45 AV	54.00	-8.55	1.62 H	23	12.99	32.46
4	4924.00	48.51 PK	74.00	-25.49	1.18 H	223	9.59	38.92
4	4924.00	36.13 AV	54.00	-17.87	1.18 H	223	-2.79	38.92

ANTENNA POLARITY & TEST DISTANCE: VERTICAL AT 3 M								
No.	Freq. (MHz)	Emission Level (dBuV/m)	Limit (dBuV/m)	Margin (dB)	Antenna Height (m)	Table Angle (Degree)	Raw Value (dBuV)	Correction Factor (dB/m)
1	1250.00	48.64 PK	74.00	-25.36	1.07 V	114	20.25	28.39
1	1250.00	38.78 AV	54.00	-15.22	1.07 V	114	10.39	28.39
2	*2462.00	103.48 PK			1.01 V	66	71.10	32.38
2	*2462.00	94.66 AV			1.01 V	66	62.28	32.38
3	2483.50	56.89 PK	74.00	-17.11	1.01 V	66	24.43	32.46
3	2483.50	48.07 AV	54.00	-5.93	1.01 V	66	15.61	32.46
4	4924.00	50.39 PK	74.00	-23.61	1.07 V	214	11.47	38.92
4	4924.00	37.92 AV	54.00	-16.08	1.07 V	214	-1.00	38.92

- REMARKS:**
1. Emission level(dBuV/m)=Raw Value(dBuV) + Correction Factor(dB/m)
 2. Correction Factor(dB/m) = Antenna Factor (dB/m) + Cable Factor (dB)
 3. The other emission levels were very low against the limit.
 4. Margin value = Emission level – Limit value.
 5. “ * “ : Fundamental frequency.



4.3 6dB BANDWIDTH MEASUREMENT

4.3.1 LIMITS OF 6dB BANDWIDTH MEASUREMENT

The minimum of 6dB Bandwidth Measurement is 0.5 MHz.

4.3.2 TEST INSTRUMENTS

Description & Manufacturer	Model No.	Serial No.	Calibrated Until
SPECTRUM ANALYZER	FSEK 30	100049	Aug. 14, 2006

NOTE: The calibration interval of the above test instruments is 12 months and the calibrations are traceable to NML/ROC and NIST/USA.

4.3.3 TEST PROCEDURE

The transmitter output was connected to the spectrum analyzer through an attenuator. The bandwidth of the fundamental frequency was measured by spectrum analyzer with 100kHz RBW and 100kHz VBW. The 6dB bandwidth is defined as the total spectrum the power of which is higher than peak power minus 6dB.

4.3.4 DEVIATION FROM TEST STANDARD

No deviation

4.3.5 TEST SETUP



4.3.6 EUT OPERATING CONDITIONS

The software provided by client to enable the EUT under transmission condition continuously at lowest, middle and highest channel frequencies individually.



4.3.7 TEST RESULTS

802.11b DSSS modulation

MODULATION TYPE	DBPSK	TRANSFER RATE	1Mbps
INPUT POWER (SYSTEM)	120Vac, 60 Hz	ENVIRONMENTAL CONDITIONS	25deg.C, 61%RH, 991hPa
TESTED BY	Long Chen		

CHANNEL	CHANNEL FREQUENCY (MHz)	6dB BANDWIDTH (MHz)	MINIMUM LIMIT (MHz)	PASS/FAIL
1	2412	9.12	0.5	PASS
6	2437	9.12	0.5	PASS
11	2462	8.56	0.5	PASS

CH 1

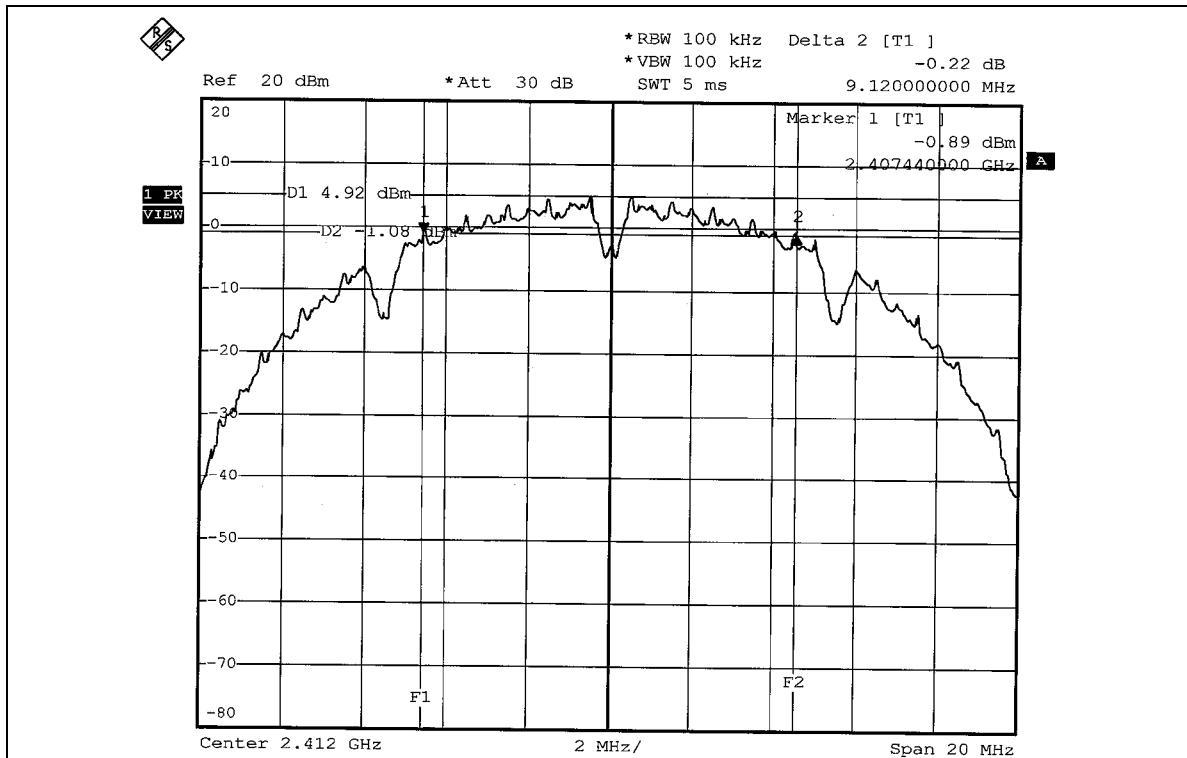

CH 6

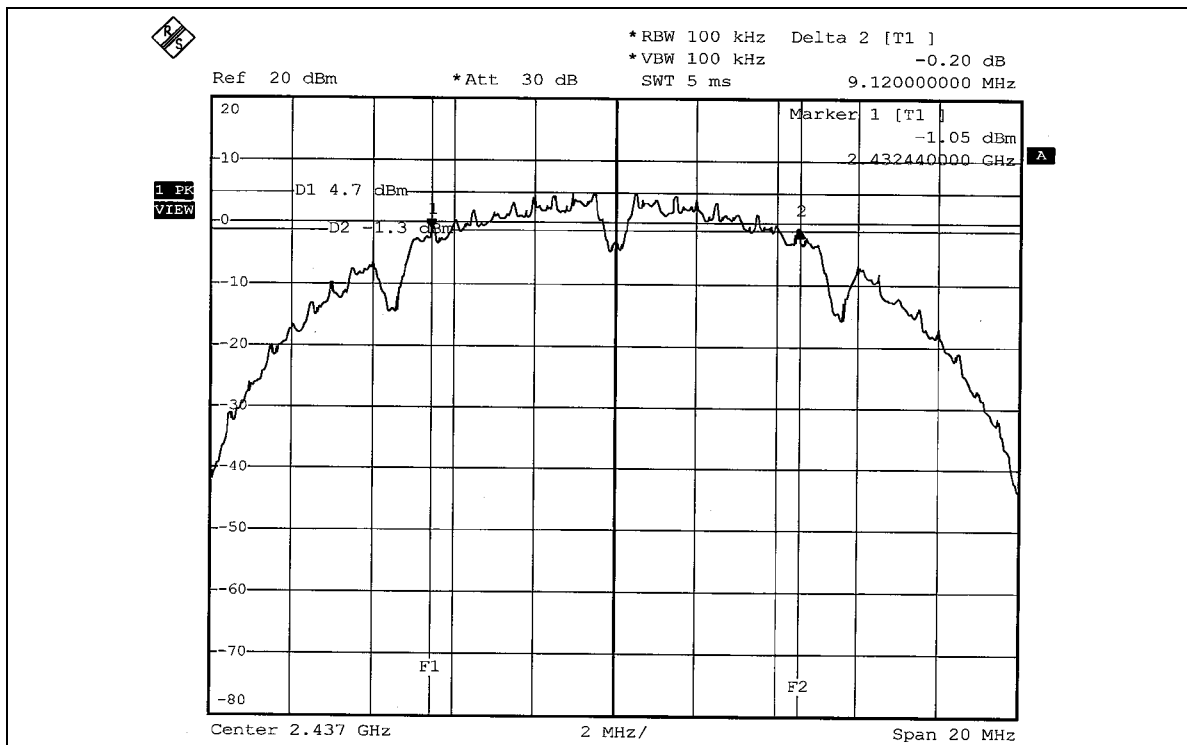

CH 11

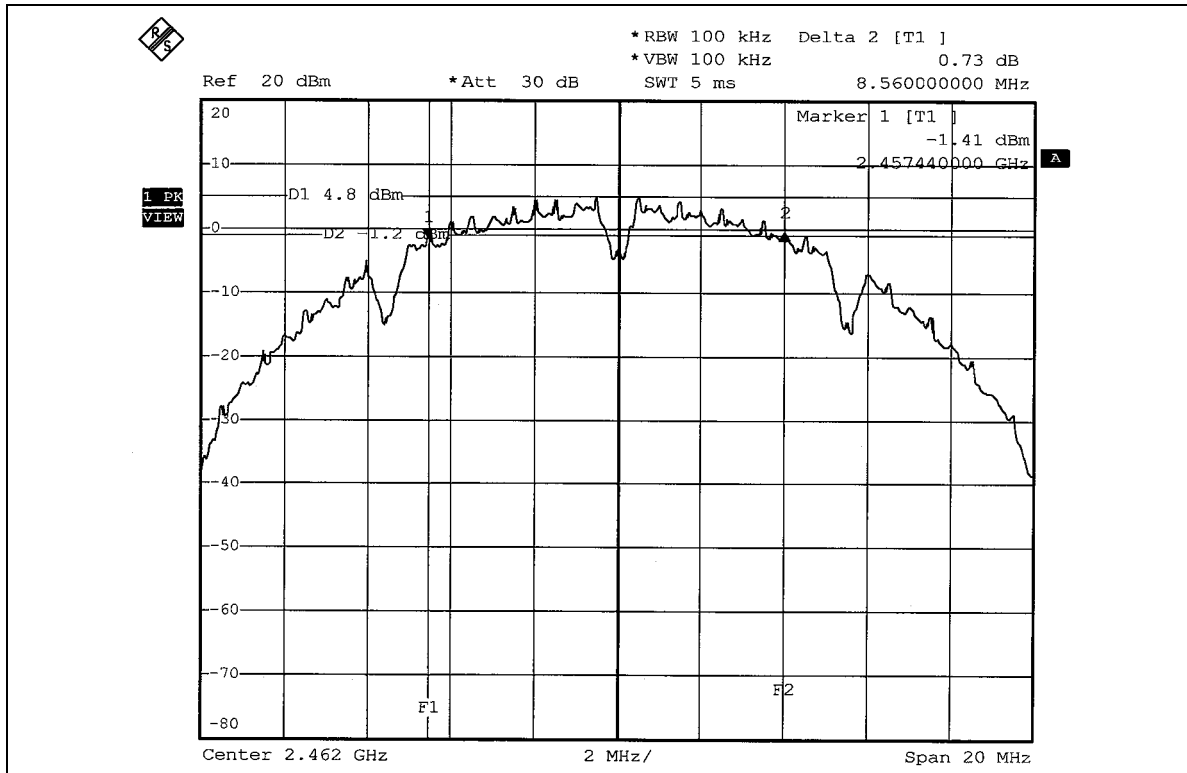



802.11g OFDM modulation

MODULATION TYPE	BPSK	TRANSFER RATE	6Mbps
INPUT POWER (SYSTEM)	120Vac, 60 Hz	ENVIRONMENTAL CONDITIONS	25deg.C, 61%RH, 991hPa
TESTED BY	Long Chen		

CHANNEL	CHANNEL FREQUENCY (MHz)	6dB BANDWIDTH (MHz)	MINIMUM LIMIT (MHz)	PASS/FAIL
1	2412	16.44	0.5	PASS
6	2437	16.44	0.5	PASS
11	2462	16.48	0.5	PASS

CH 1

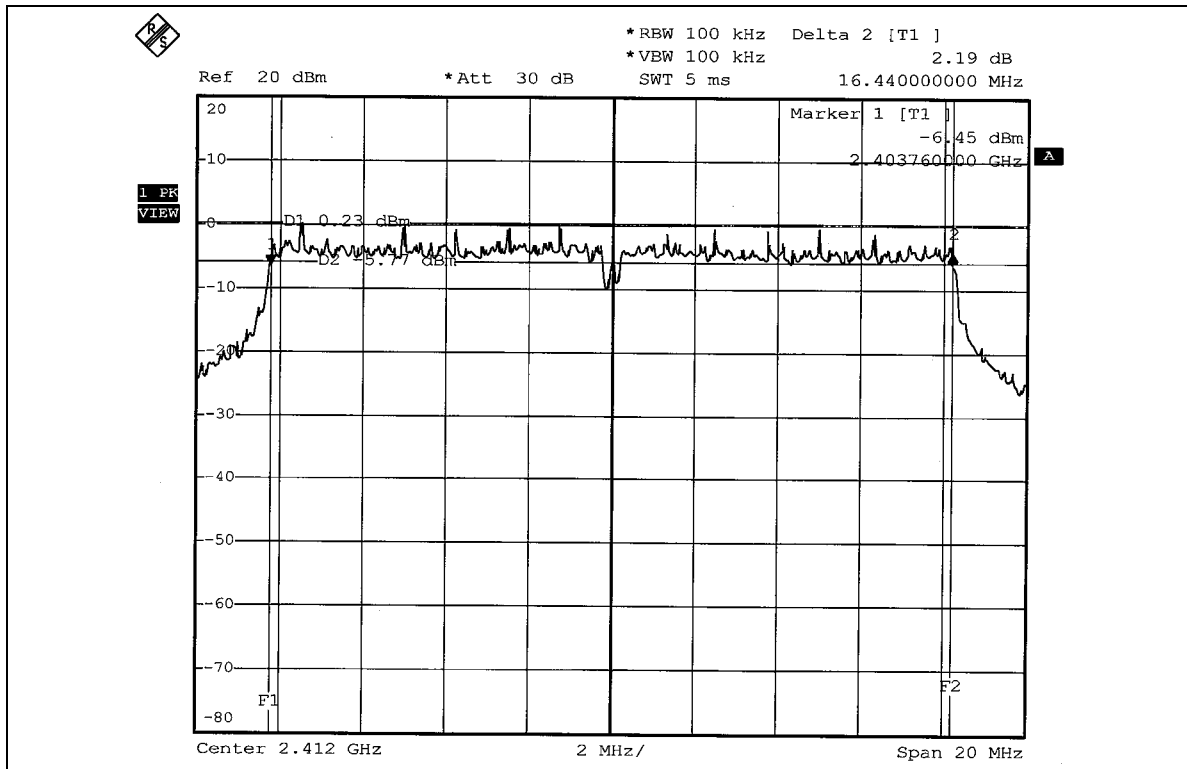

CH 6

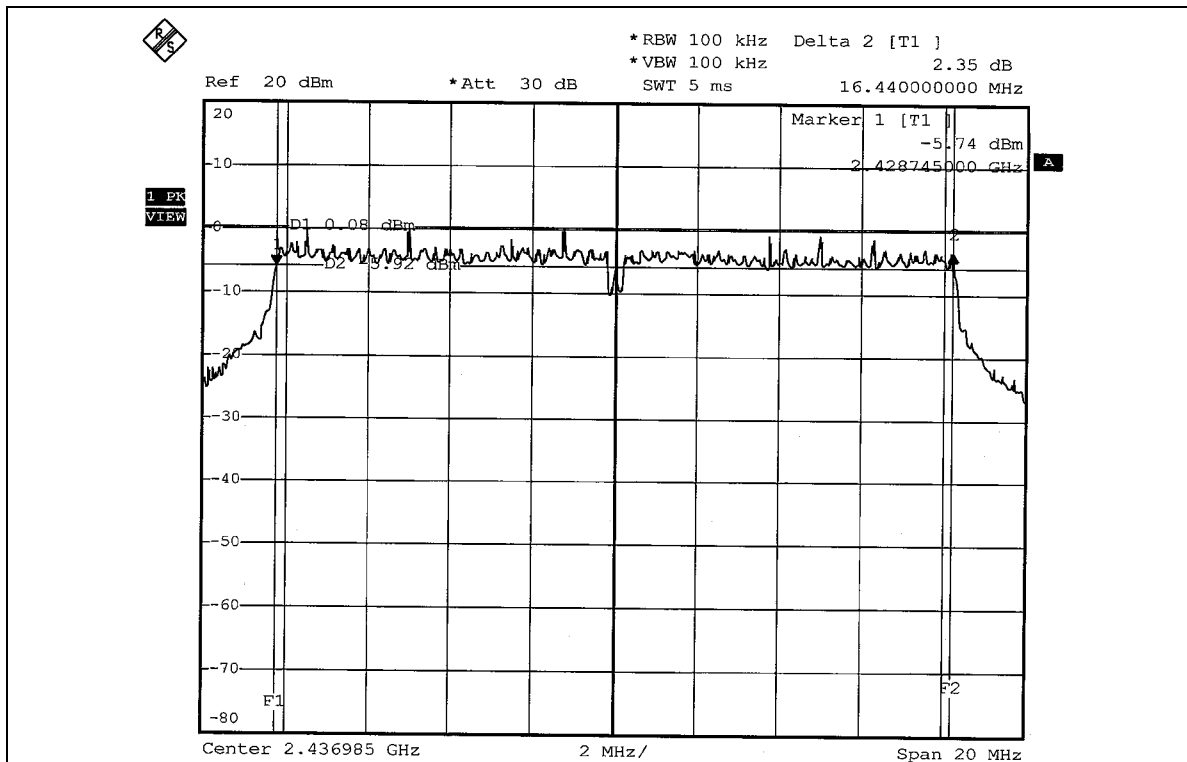

CH 11

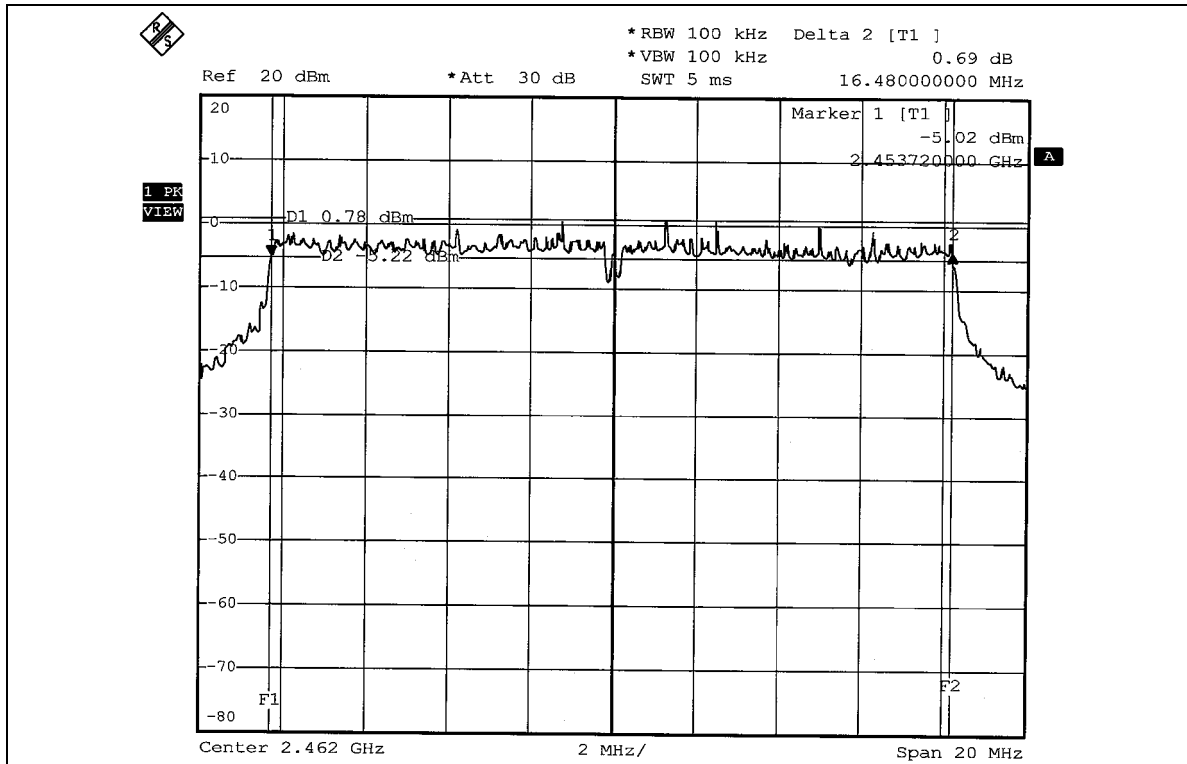



4.4 MAXIMUM PEAK OUTPUT POWER

4.4.1 LIMITS OF MAXIMUM PEAK OUTPUT POWER MEASUREMENT

The Maximum Peak Output Power Measurement is 30dBm.

4.4.2 INSTRUMENTS

Description & Manufacturer	Model No.	Serial No.	Calibrated Until
R&S SPECTRUM ANALYZER	FSEK30	100049	Aug. 14, 2006
AGILENT SIGNAL GENERATOR	E8257C	MY43320668	Dec. 30, 2006
TEKTRONIX OSCILLOSCOPE	TDS 1012	C019167	Jan. 16, 2007
NARDA DETECTOR	4503A	FSCM99899	NA

NOTE:

The calibration interval of the above test instruments is 12 months and the calibrations are traceable to NML/ROC and NIST/USA.

4.4.1 TEST PROCEDURES

1. A detector was used on the output port of the EUT. An oscilloscope was used to read the response of the detector.
2. Replaced the EUT by the signal generator. The center frequency of the S.G was adjusted to the center frequency of the measured channel.
3. Adjusted the power to have the same reading on oscilloscope. Record the power level.

4.4.2 DEVIATION FROM TEST STANDARD

No deviation

4.4.3 TEST SETUP



4.4.4 EUT OPERATING CONDITIONS

Same as Item 4.3.6



4.4.3 TEST RESULTS

802.11b DSSS modulation

MODULATION TYPE	DBPSK	TRANSFER RATE	1Mbps
INPUT POWER (SYSTEM)	120Vac, 60 Hz	ENVIRONMENTAL CONDITIONS	25deg.C, 61%RH, 991hPa
TESTED BY	Long Chen		

CHANNEL	CHANNEL FREQUENCY (MHz)	PEAK POWER OUTPUT (mW)	PEAK POWER OUTPUT (dBm)	PEAK POWER LIMIT (dBm)	PASS/FAIL
1	2412	63.387	18.02	30	PASS
6	2437	63.533	18.03	30	PASS
11	2462	63.680	18.04	30	PASS

802.11g OFDM modulation

MODULATION TYPE	BPSK	TRANSFER RATE	6Mbps
INPUT POWER (SYSTEM)	120Vac, 60 Hz	ENVIRONMENTAL CONDITIONS	25deg.C, 61%RH, 991hPa
TESTED BY	Long Chen		

CHANNEL	CHANNEL FREQUENCY (MHz)	PEAK POWER OUTPUT (mW)	PEAK POWER OUTPUT (dBm)	PEAK POWER LIMIT (dBm)	PASS/FAIL
1	2412	63.973	18.06	30	PASS
6	2437	64.121	18.07	30	PASS
11	2462	63.096	18.00	30	PASS



4.5 POWER SPECTRAL DENSITY MEASUREMENT

4.5.1 LIMITS OF POWER SPECTRAL DENSITY MEASUREMENT

The Maximum of Power Spectral Density Measurement is 8dBm.

4.5.2 TEST INSTRUMENTS

Description & Manufacturer	Model No.	Serial No.	Calibrated Until
R&S SPECTRUM ANALYZER	FSEK30	100049	Aug. 14, 2006

NOTE:

The calibration interval of the above test instruments is 12 months and the calibrations are traceable to NML/ROC and NIST/USA.

4.5.3 TEST PROCEDURE

The transmitter output was connected to the spectrum analyzer through an attenuator, the bandwidth of the fundamental frequency was measured with the spectrum analyzer using 3kHz RBW and 30kHz VBW, set sweep time = span/3kHz. The power spectral density was measured and recorded. The sweep time is allowed to be longer than span/3kHz for a full response of the mixer in the spectrum analyzer.

4.5.4 DEVIATION FROM TEST STANDARD

No deviation

4.5.5 TEST SETUP

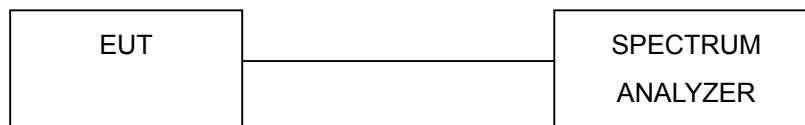

4.5.6 EUT OPERATING CONDITION

Same as Item 4.3.6



4.5.7 TEST RESULTS

802.11b DSSS modulation

MODULATION TYPE	DBPSK	TRANSFER RATE	1Mbps
INPUT POWER (SYSTEM)	120Vac, 60 Hz	ENVIRONMENTAL CONDITIONS	25deg.C, 61%RH, 991hPa
TESTED BY	Long Chen		

CHANNEL	CHANNEL FREQUENCY (MHz)	RF POWER LEVEL IN 3kHz BW (dBm)	MAXIMUM LIMIT (dBm)	PASS/FAIL
1	2412	-10.08	8	PASS
6	2437	-10.22	8	PASS
11	2462	-10.29	8	PASS

CH 11

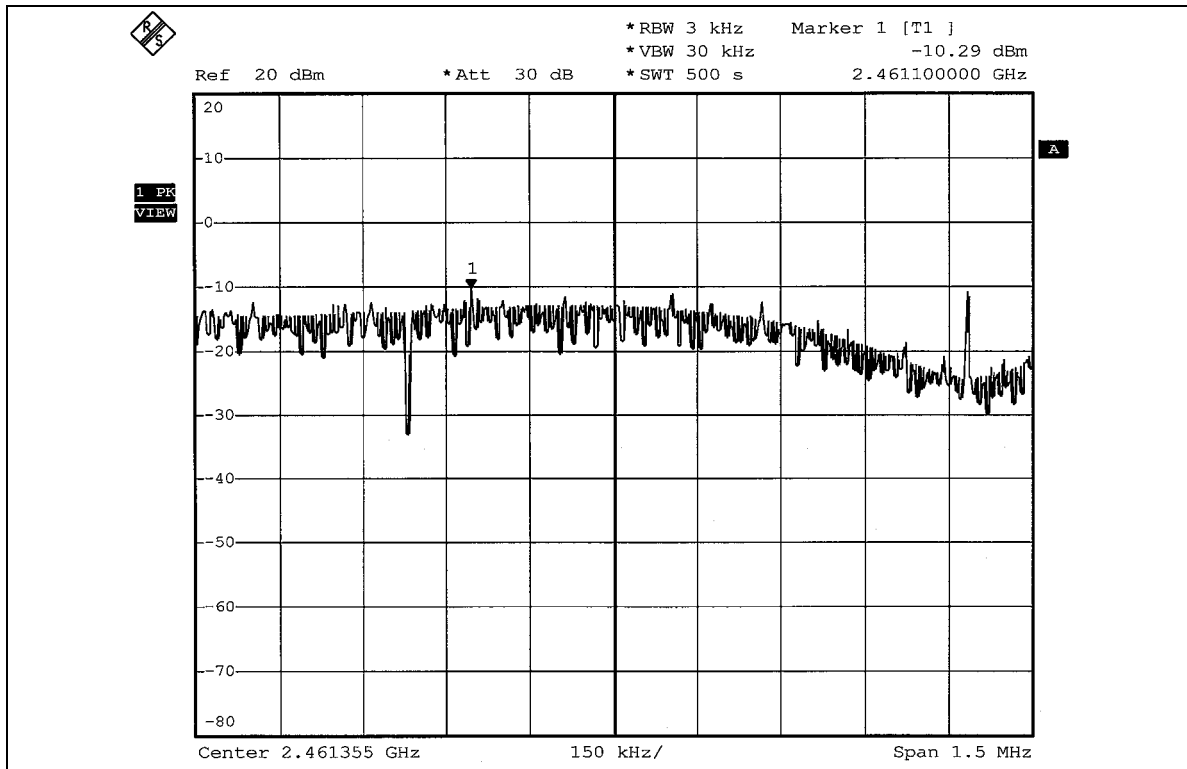



802.11g OFDM modulation

MODULATION TYPE	BPSK	TRANSFER RATE	6Mbps
INPUT POWER (SYSTEM)	120Vac, 60 Hz	ENVIRONMENTAL CONDITIONS	25deg.C, 61%RH, 991hPa
TESTED BY	Long Chen		

CHANNEL	CHANNEL FREQUENCY (MHz)	RF POWER LEVEL IN 3kHz BW (dBm)	MAXIMUM LIMIT (dBm)	PASS/FAIL
1	2412	-9.57	8	PASS
6	2437	-9.66	8	PASS
11	2462	-9.73	8	PASS



CH 1

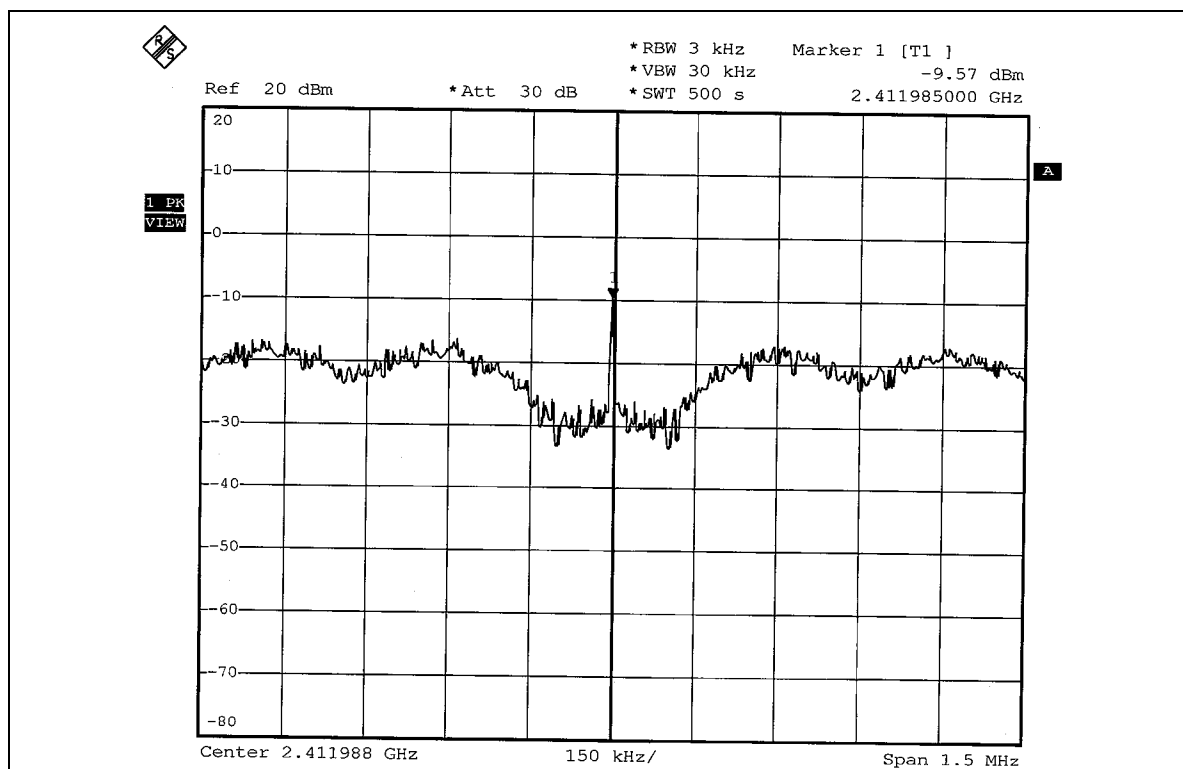

CH 6

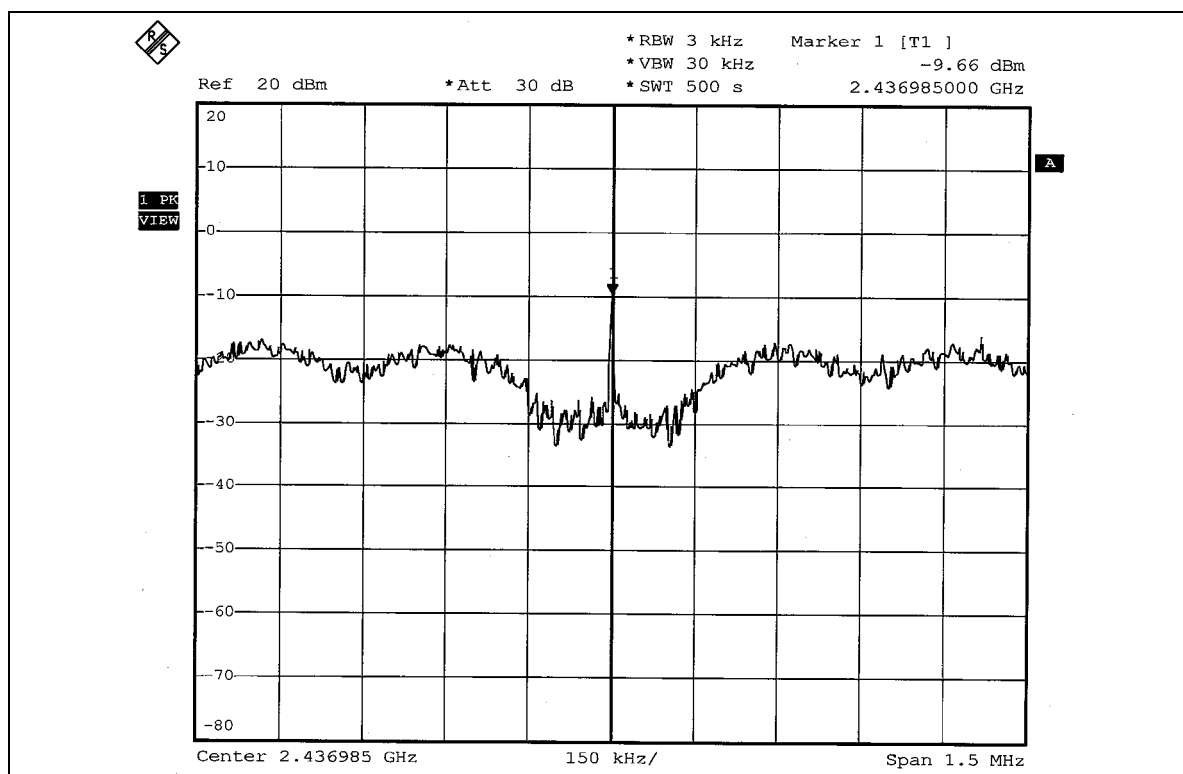



CH 11

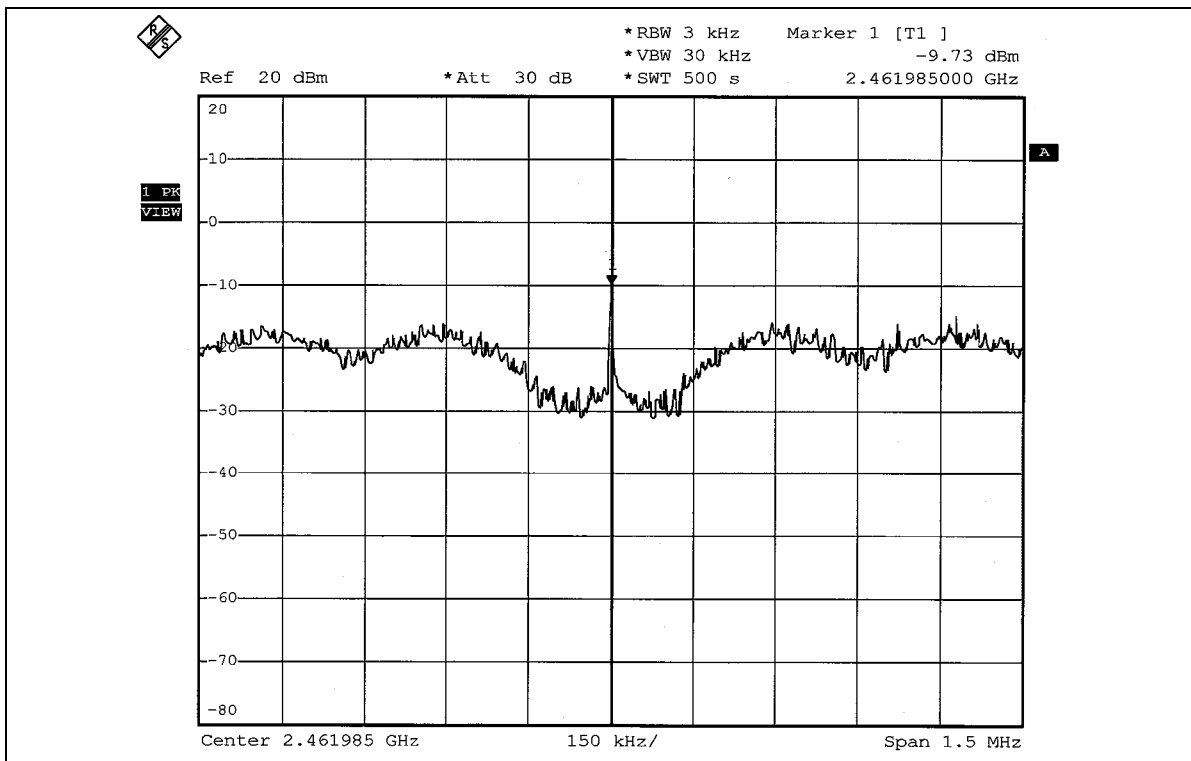



4.6 BAND EDGES MEASUREMENT

4.6.1 LIMITS OF BAND EDGES MEASUREMENT

Below -20dB of the highest emission level of operating band (in 100kHz Resolution Bandwidth).

4.6.2 TEST INSTRUMENTS

Description & Manufacturer	Model No.	Serial No.	Calibrated Until
R&S SPECTRUM ANALYZER	FSEK30	100049	Aug. 14, 2006

NOTE: The calibration interval of the above test instruments is 12 months and the calibrations are traceable to NML/ROC and NIST/USA.

4.6.3 TEST PROCEDURE

The transmitter output was connected to the spectrum analyzer via a low lose cable. Set both RBW and VBW of spectrum analyzer to 100kHz with suitable frequency span including 100 MHz bandwidth from band edge. The band edges was measured and recorded.

The spectrum plots (Peak RBW=VBW=100kHz; Average RBW=1MHz, VBW=100Hz(for 802.11b) and 1kHz(for 802.11g)) are attached on the following pages.

4.6.4 DEVIATION FROM TEST STANDARD

No deviation

4.6.5 EUT OPERATING CONDITION

Same as Item 4.3.6

4.6.6 TEST RESULTS

The spectrum plots are attached on the following 12 images. D1 line indicates the highest level, and D2 line indicates the 20dB offset below D1. It shows compliance with the requirement in part 15.247(d).

802.11b DSSS modulation

NOTE 1: The band edge emission plot on the next page shows 52.74dBc between carrier maximum power and local maximum emission in restrict band (2.33868GHz). The emission of carrier strength list in the test result of channel 1 at the item 4.2.7 is 106.09dBuV/m (Peak), so the maximum field strength in restrict band is $106.09 - 52.74 = 53.35$ dBuV/m which is under 74dBuV/m limit.

The band edge emission plot of on the next page shows 63.61dBc between carrier maximum power and local maximum emission in restrict band (2.37208GHz). The emission of carrier strength list in the test result of channel 1 at the item 4.2.7 is 102.62dBuV/m (Average), so the maximum field strength in restrict band is $102.62 - 63.61 = 39.01$ dBuV/m which is under 54dBuV/m limit.

NOTE 2: The band edge emission plot on the next second page shows 52.39dBc between carrier maximum power and local maximum emission in restrict band (2.4910GHz). The emission of carrier strength list in the test result of channel 11 at the item 4.2.7 is 105.52dBuV/m (Peak), so the maximum field strength in restrict band is $105.52 - 52.39 = 53.13$ dBuV/m which is under 74dBuV/m limit.

The band edge emission plot on the next third page shows 61.11dBc between carrier maximum power and local maximum emission in restrict band (2.4888GHz). The emission of carrier strength list in the test result of channel 11 at the item 4.2.7 is 102.51dBuV/m (Average), so the maximum field strength in restrict band is $102.51 - 61.11 = 41.03$ dBuV/m which is under 54dBuV/m limit.

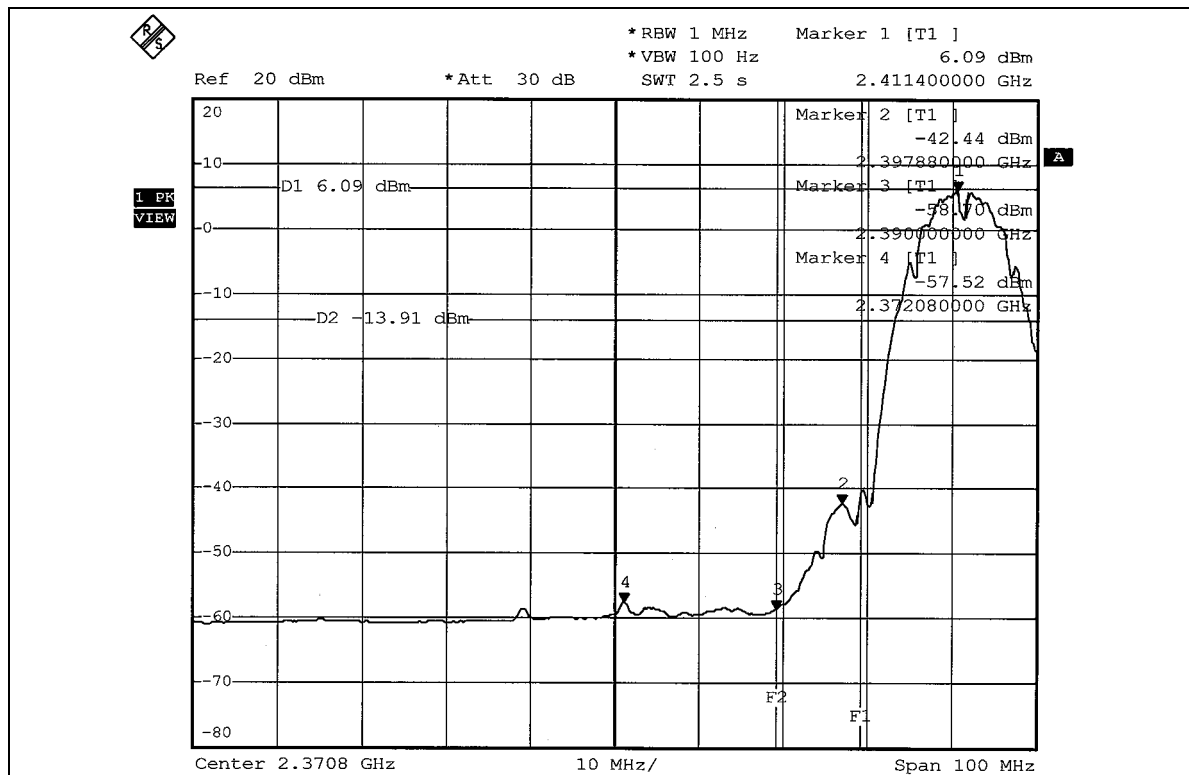
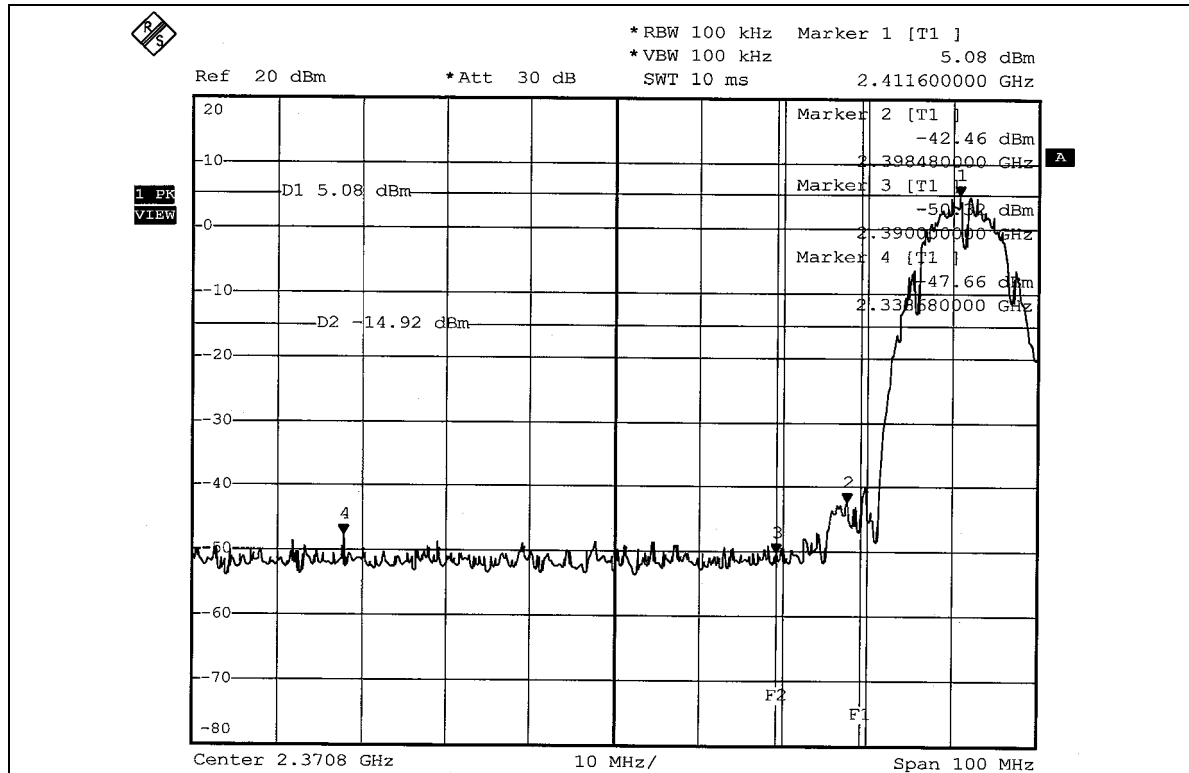

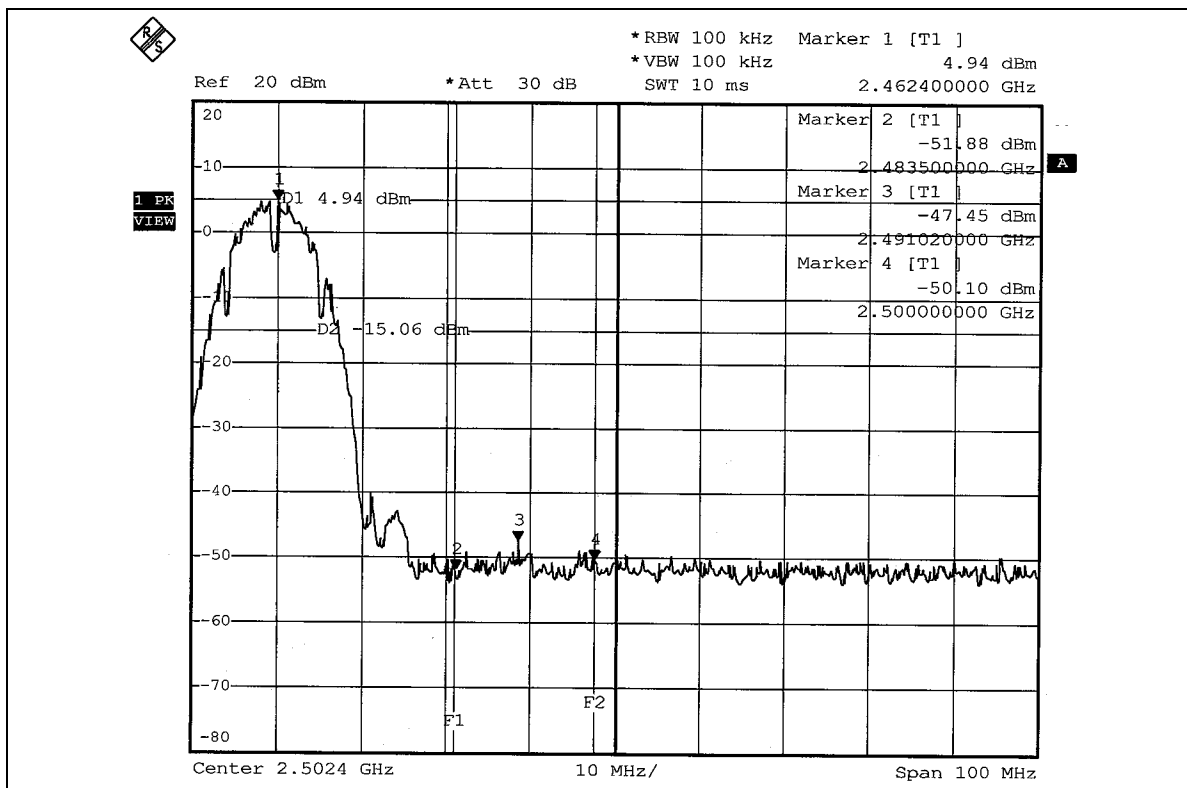
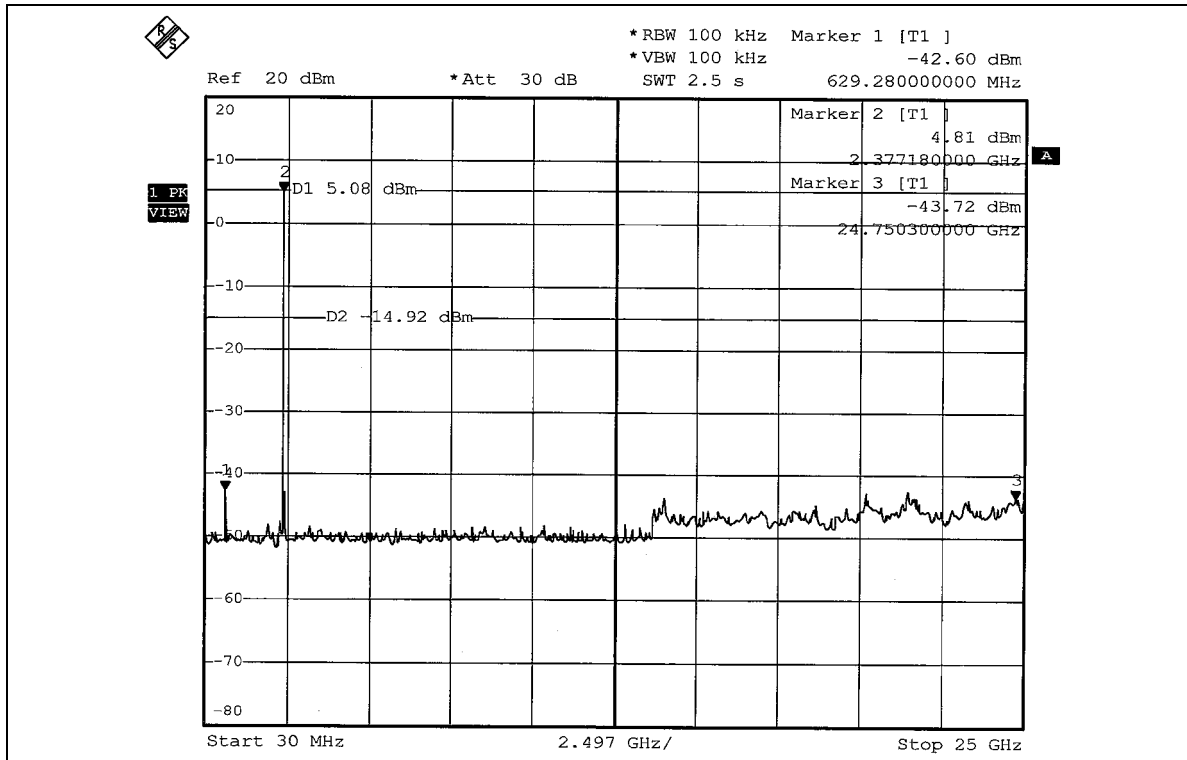

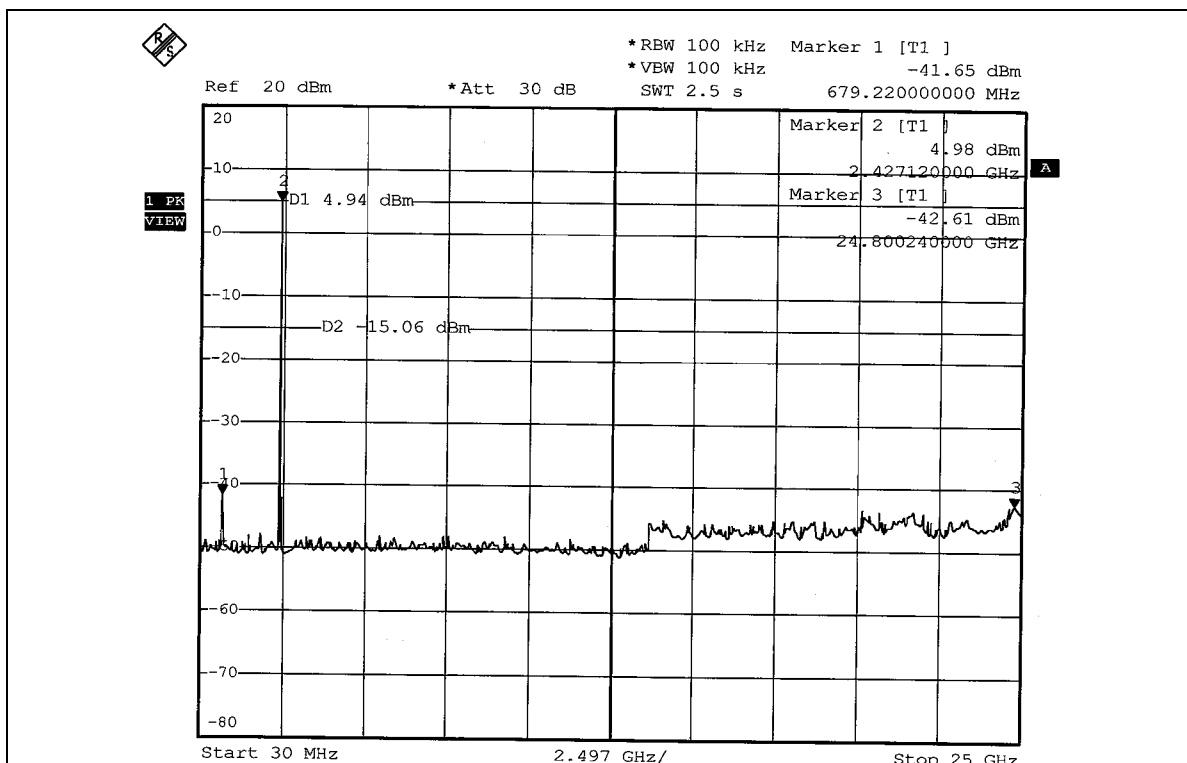
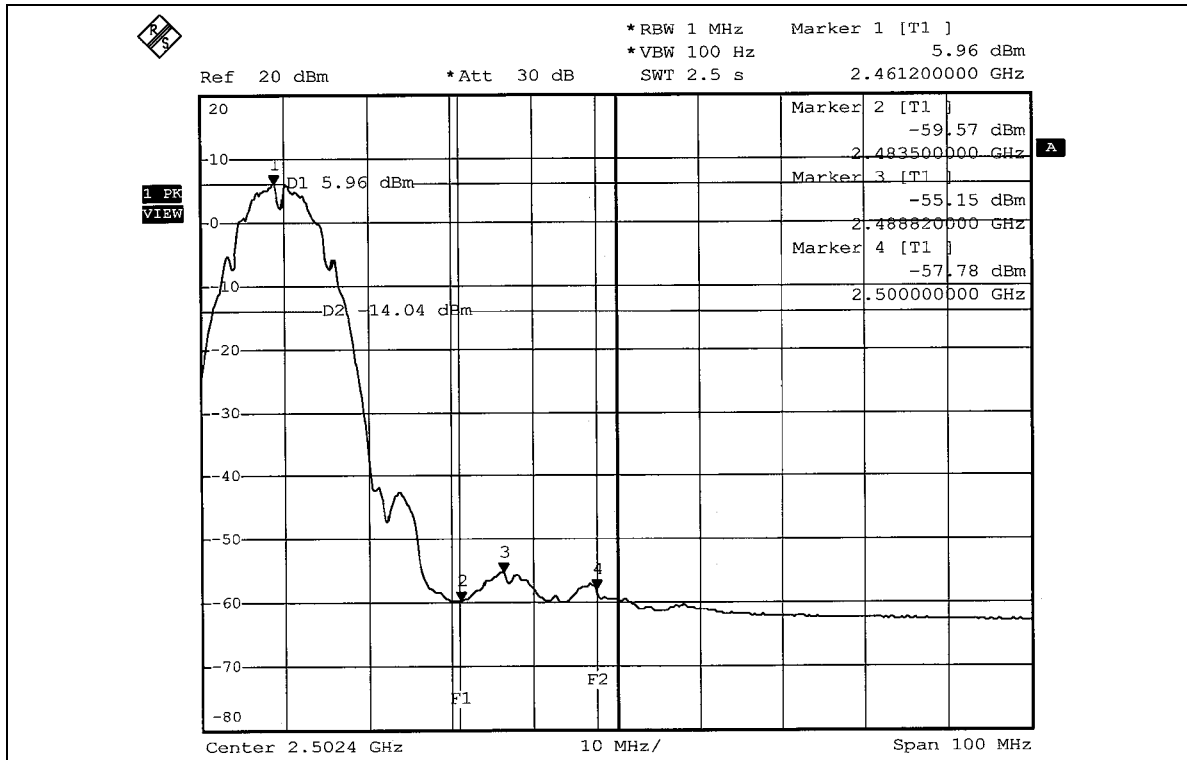



802.11g OFDM modulation

NOTE 1: The band edge emission plot on the next page shows 45.45dBc between carrier maximum power and local maximum emission in restrict band (2.38940GHz). The emission of carrier strength list in the test result of channel 1 at the item 4.2.7 is 103.34dBuV/m (Peak), so the maximum field strength in restrict band is $103.34 - 45.45 = 57.89$ dBuV/m which is under 74dBuV/m limit.

The band edge emission plot of on the next page shows 47.25dBc between carrier maximum power and local maximum emission in restrict band (2.3900GHz). The emission of carrier strength list in the test result of channel 1 at the item 4.2.7 is 94.46dBuV/m (Average), so the maximum field strength in restrict band is $94.46 - 47.25 = 47.21$ dBuV/m which is under 54dBuV/m limit.

NOTE 2: The band edge emission plot on the next second page shows 45.08dBc between carrier maximum power and local maximum emission in restrict band (2.4839GHz). The emission of carrier strength list in the test result of channel 11 at the item 4.2.7 is 103.48dBuV/m (Peak), so the maximum field strength in restrict band is $103.48 - 45.08 = 58.40$ dBuV/m which is under 74dBuV/m limit.

The band edge emission plot on the next third page shows 49.72dBc between carrier maximum power and local maximum emission in restrict band (2.4835GHz). The emission of carrier strength list in the test result of channel 11 at the item 4.2.7 is 94.85dBuV/m (Average), so the maximum field strength in restrict band is $94.66 - 49.72 = 44.94$ dBuV/m which is under 54dBuV/m limit.

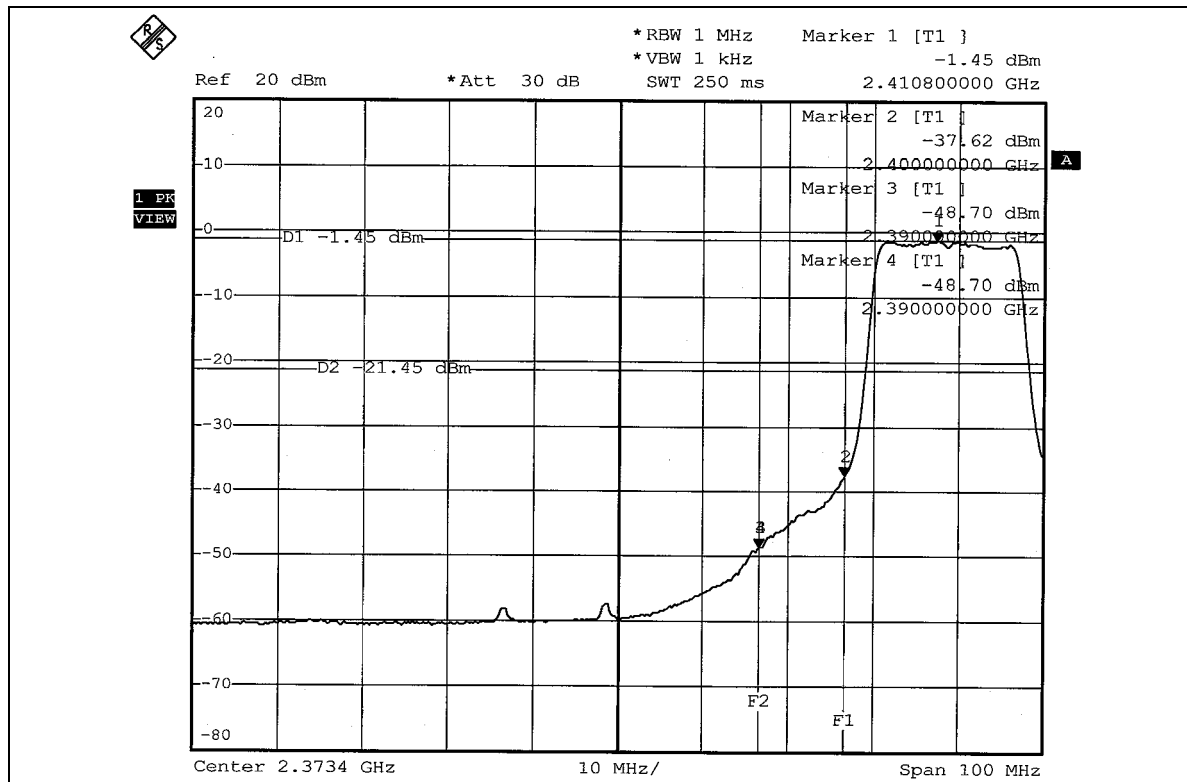
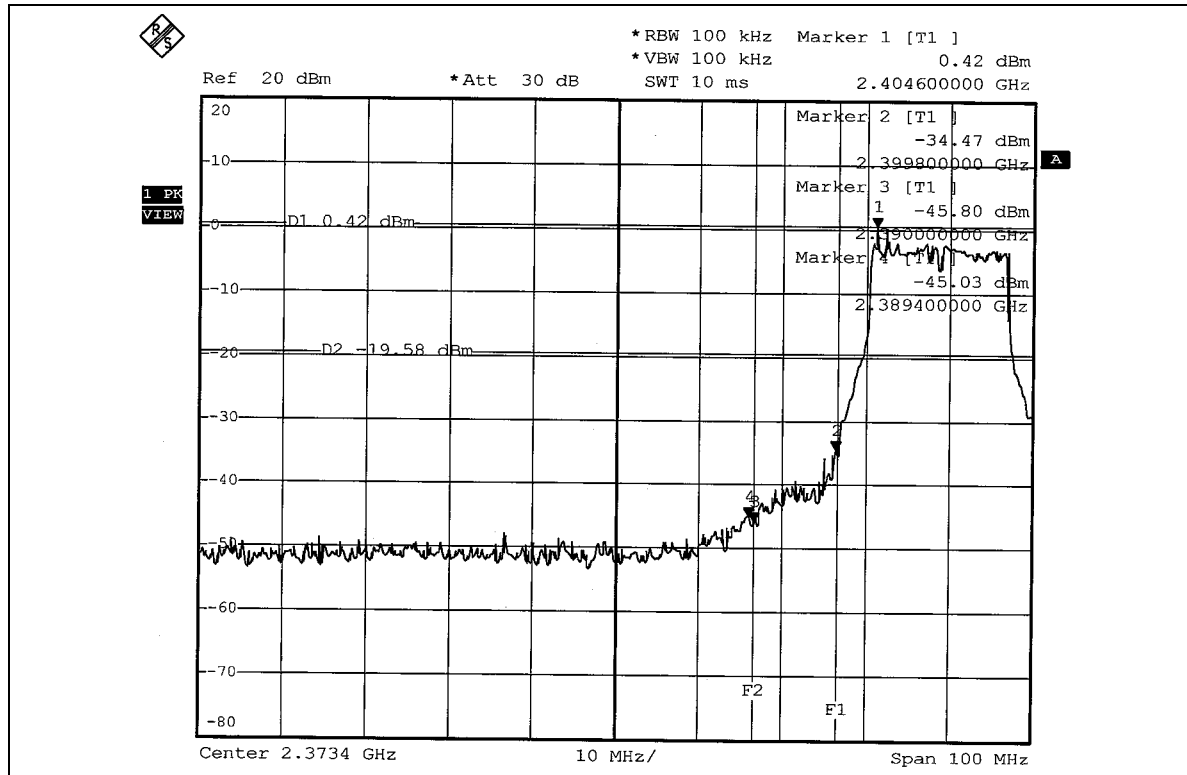

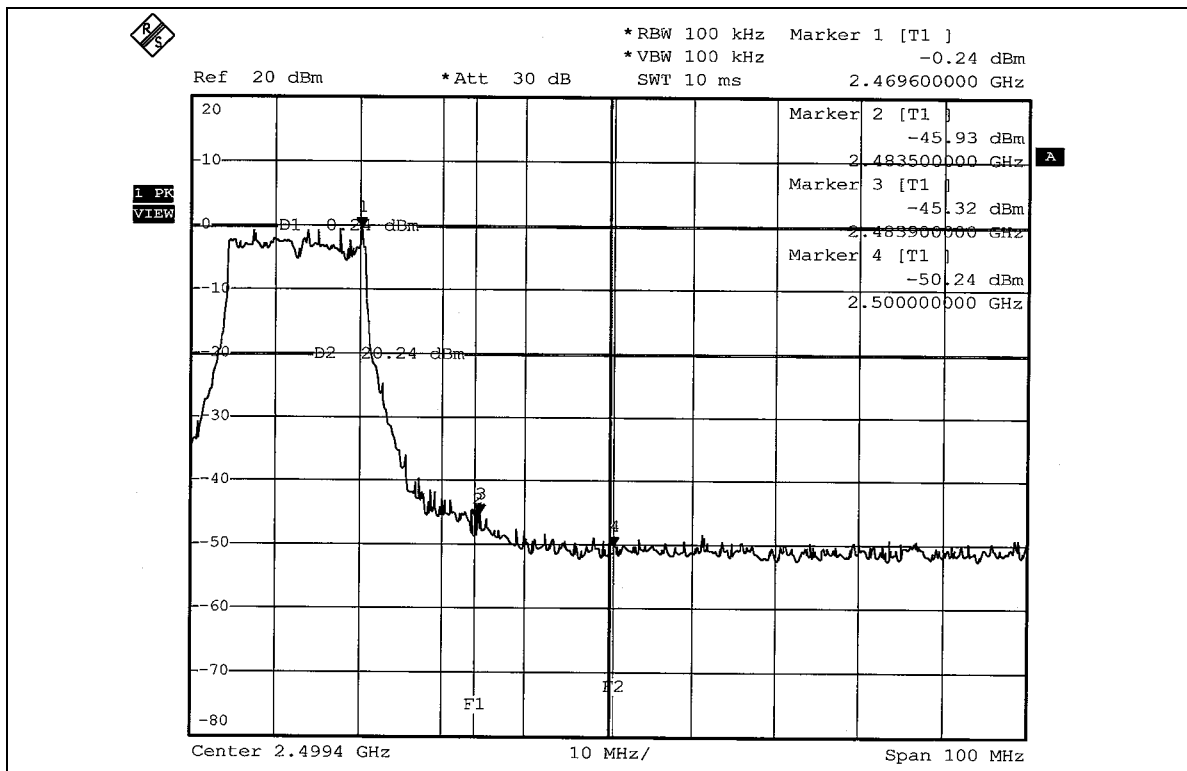
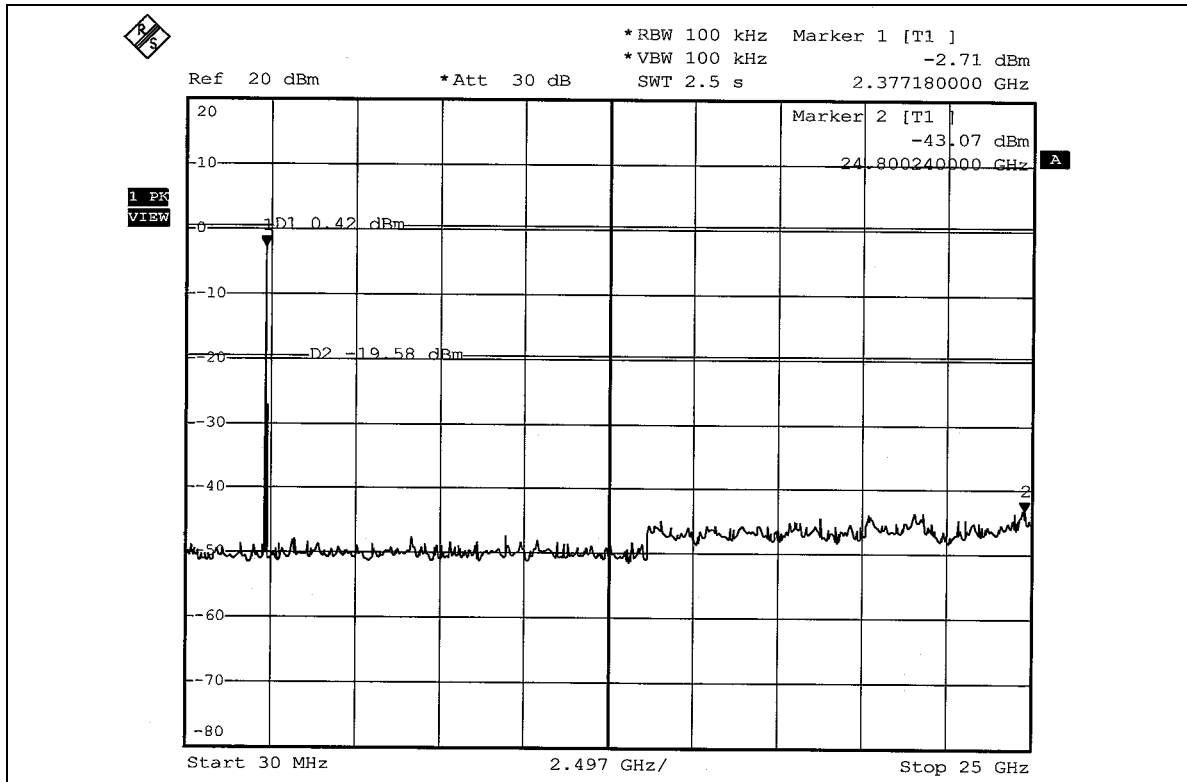

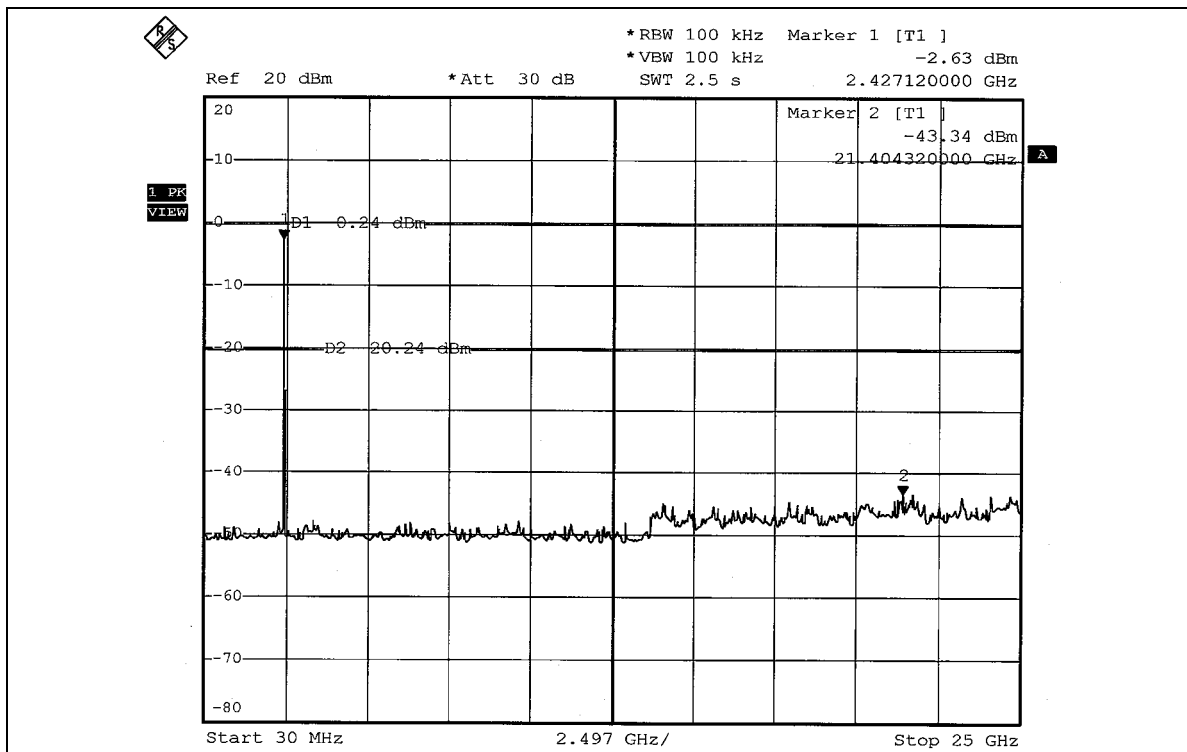
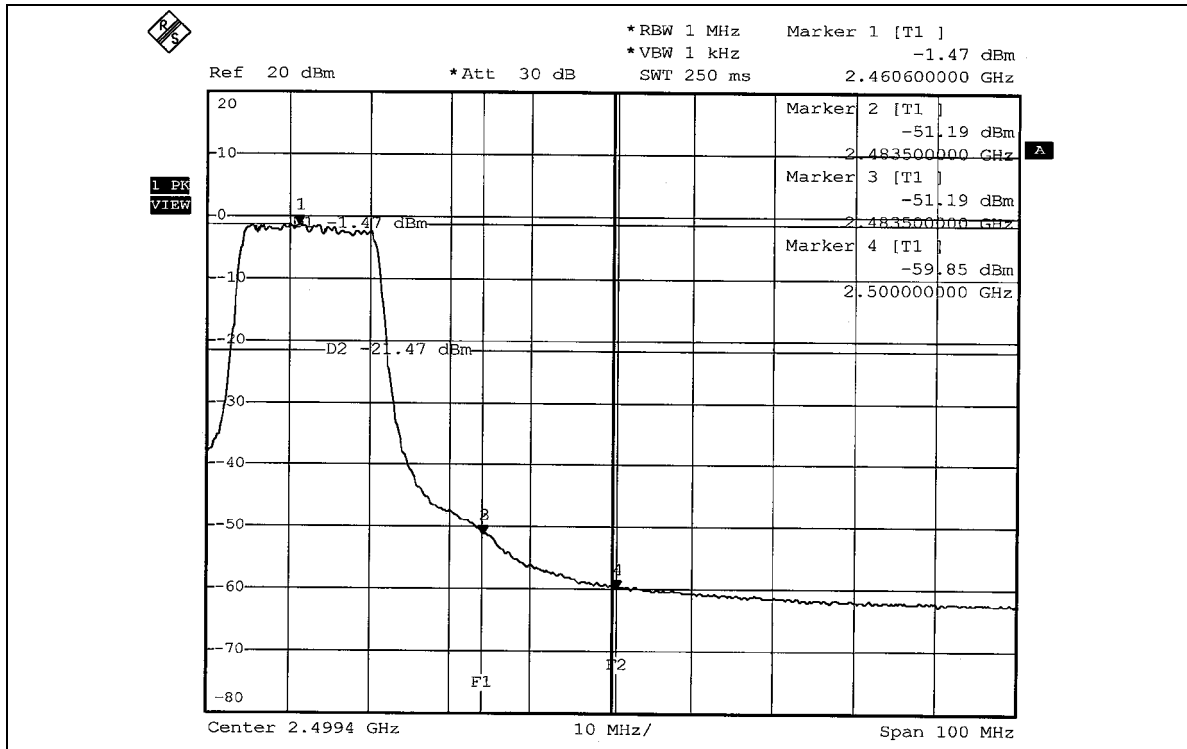



4.7 ANTENNA REQUIREMENT

4.7.1 STANDARD APPLICABLE

For intentional device, according to FCC 47 CFR Section 15.203, an intentional radiator shall be designed to ensure that no antenna other than that furnished by the responsible party shall be used with the device. And according to FCC 47 CFR Section 15.247 (b), if transmitting antennas of directional gain greater than 6dBi are used, the power shall be reduced by the amount in dB that the directional gain of the antenna exceeds 6dBi.

4.7.2 ANTENNA CONNECTED CONSTRUCTION

The antenna used in this product is PIFA antenna with UFL connector. The maximum Gain of the antenna is -1.09449dBi .



5. TEST TYPES AND RESULTS (FOR 802.11a 5745~5825MHz Band)

5.1 CONDUCTED EMISSION MEASUREMENT

5.1.1 LIMITS OF CONDUCTED EMISSION MEASUREMENT

FREQUENCY OF EMISSION (MHz)	CONDUCTED LIMIT (dBµV)	
	Quasi-peak	Average
0.15-0.5	66 to 56	56 to 46
0.5-5	56	46
5-30	60	50

- NOTE:**
- The lower limit shall apply at the transition frequencies.
 - The limit decreases in line with the logarithm of the frequency in the range of 0.15 to 0.50 MHz.
 - All emanations from a class A/B digital device or system, including any network of conductors and apparatus connected thereto, shall not exceed the level of field strengths specified above.

5.1.2 TEST INSTRUMENTS

DESCRIPTION & MANUFACTURER	MODEL NO.	SERIAL NO.	CALIBRATED UNTIL
Test Receiver ROHDE & SCHWARZ	ESCS30	100291	Nov. 11, 2006
RF signal cable Woken	5D-FB	Cable-HYC01-01	Jan. 06, 2007
LISN ROHDE & SCHWARZ	ESH3-Z5	100312	Feb. 15, 2007
LISN ROHDE & SCHWARZ	ESH2-Z5	100104	Feb. 07, 2007
Software ADT	ADT_Cond_V3	NA	NA

- NOTE:**
- The calibration interval of the above test instruments is 12 months and the calibrations are traceable to NML/ROC and NIST/USA.
 - The test was performed in HwaYa Shielded Room 1.
 - The VCCI Site Registration No. is C-2040.

5.1.3 TEST PROCEDURES

- a. The EUT was placed 0.4 meters from the conducting wall of the shielded room with EUT being connected to the power mains through a line impedance stabilization network (LISN). Other support units were connected to the power mains through another LISN. The two LISNs provide 50 ohm/ 50uH of coupling impedance for the measuring instrument.
- b. Both lines of the power mains connected to the EUT were checked for maximum conducted interference.
- c. The frequency range from 150kHz to 30MHz was searched. Emission levels under (Limit – 20dB) was not recorded.

5.1.4 DEVIATION FROM TEST STANDARD

No deviation

5.1.5 TEST SETUP

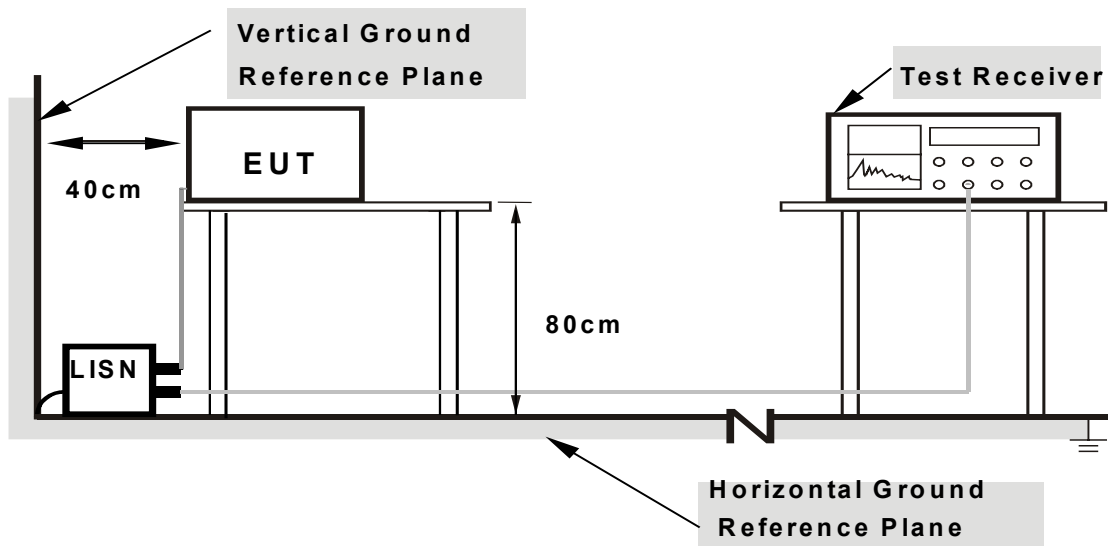

- Note:**
- 1.Support units were connected to second LISN.
 - 2.Both of LISNs (AMN) are 80 cm from EUT and at least 80 from other units and other metal planes

For the actual test configuration, please refer to the related item – Photographs of the Test Configuration.

5.1.6 EUT OPERATING CONDITIONS

Same as 4.1.6

5.1.7 TEST RESULTS

Conducted Worst-Case Data (For Adapter: PA-1650-02)

EUT TEST CONDITION		MEASUREMENT DETAIL	
CHANNEL	Channel 5	PHASE	Line 1
MODULATION TYPE	BPSK	6dB BANDWIDTH	9 kHz
TRANSFER RATE	6Mbps	ENVIRONMENTAL CONDITIONS	25deg. C, 68%RH, 991hPa
INPUT POWER (SYSTEM)	120Vac, 60 Hz	TEST MODE	A
TESTED BY	Morgan Chen		

No	Freq. [MHz]	Corr. Factor (dB)	Reading Value		Emission Level		Limit		Margin	
			[dB (uV)]		[dB (uV)]		[dB (uV)]		(dB)	
			Q.P.	AV.	Q.P.	AV.	Q.P.	AV.	Q.P.	AV.
1	0.154	0.10	37.63	-	37.73	-	65.79	55.79	-28.06	-
2	0.213	0.10	36.19	-	36.29	-	63.11	53.11	-26.82	-
3	0.287	0.10	34.81	-	34.91	-	60.62	50.62	-25.71	-
4	0.361	0.10	33.21	-	33.31	-	58.71	48.71	-25.40	-
5	0.580	0.13	34.96	-	35.09	-	56.00	46.00	-20.91	-
6	0.943	0.19	35.44	-	35.63	-	56.00	46.00	-20.37	-

- REMARKS:**
1. Q.P. and AV. are abbreviations of quasi-peak and average individually.
 2. "-": The Quasi-peak reading value also meets average limit and measurement with the average detector is unnecessary.
 3. The emission levels of other frequencies were very low against the limit.
 4. Margin value = Emission level - Limit value
 5. Correction factor = Insertion loss + Cable loss
 6. Emission Level = Correction Factor + Reading Value.

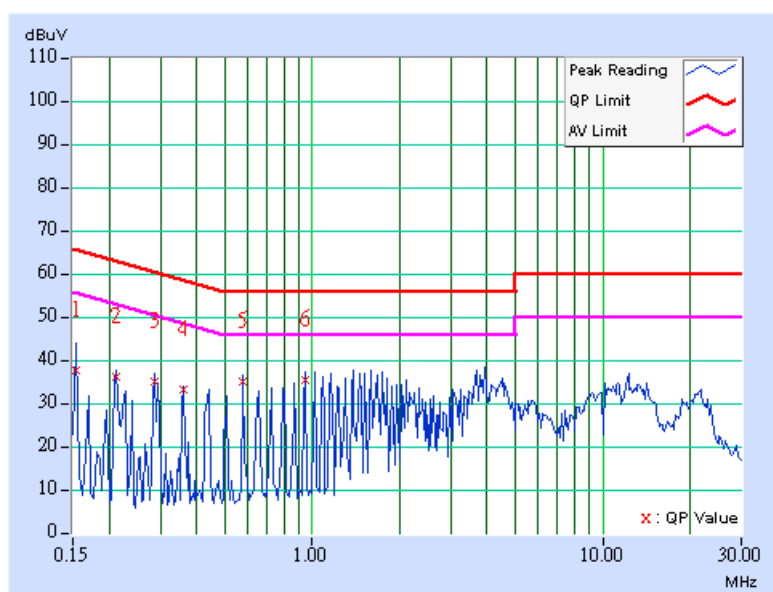

EUT TEST CONDITION		MEASUREMENT DETAIL	
CHANNEL	Channel 5	PHASE	Line 2
MODULATION TYPE	BPSK	6dB BANDWIDTH	9 kHz
TRANSFER RATE	6Mbps	ENVIRONMENTAL CONDITIONS	25deg. C, 68%RH, 991hPa
INPUT POWER (SYSTEM)	120Vac, 60 Hz	TEST MODE	A
TESTED BY	Morgan Chen		

No	Freq. [MHz]	Corr. Factor (dB)	Reading Value		Emission Level		Limit		Margin	
			[dB (uV)]		[dB (uV)]		[dB (uV)]		(dB)	
			Q.P.	AV.	Q.P.	AV.	Q.P.	AV.	Q.P.	AV.
1	0.150	0.10	47.28	-	47.38	-	66.00	56.00	-18.62	-
2	0.216	0.10	41.72	-	41.82	-	62.96	52.96	-21.14	-
3	0.291	0.10	35.95	-	36.05	-	60.51	50.51	-24.46	-
4	1.305	0.13	37.09	-	37.22	-	56.00	46.00	-18.78	-
5	4.492	0.38	34.15	-	34.53	-	56.00	46.00	-21.47	-
6	13.125	0.50	33.00	-	33.50	-	60.00	50.00	-26.50	-

- REMARKS:**
1. Q.P. and AV. are abbreviations of quasi-peak and average individually.
 2. "-": The Quasi-peak reading value also meets average limit and measurement with the average detector is unnecessary.
 3. The emission levels of other frequencies were very low against the limit.
 4. Margin value = Emission level - Limit value
 5. Correction factor = Insertion loss + Cable loss
 6. Emission Level = Correction Factor + Reading Value.

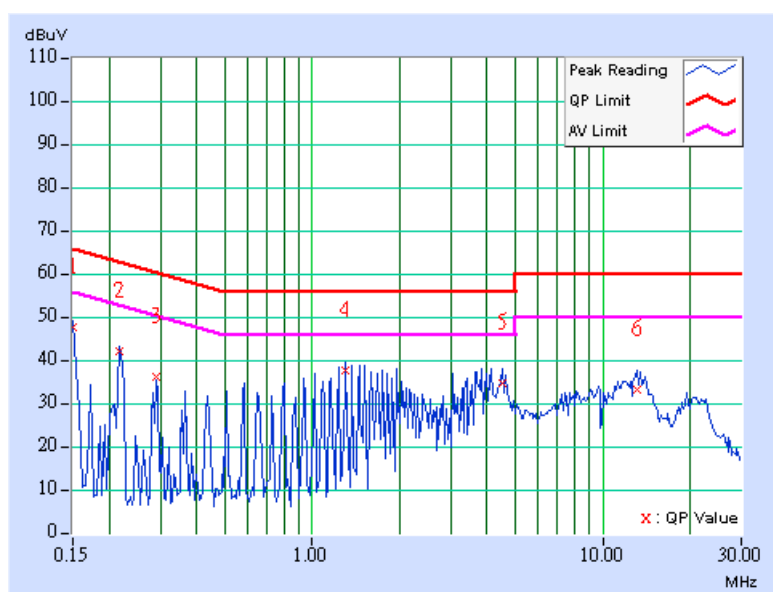

Conducted Worst-Case Data (For Adapter: 0335A1965)

EUT TEST CONDITION		MEASUREMENT DETAIL	
CHANNEL	Channel 5	PHASE	Line 1
MODULATION TYPE	BPSK	6dB BANDWIDTH	9 kHz
TRANSFER RATE	6Mbps	ENVIRONMENTAL CONDITIONS	25deg. C, 68%RH, 991hPa
TEST MODE	B	INPUT POWER (SYSTEM)	120Vac, 60 Hz
TESTED BY	Morgan Chen		

No	Freq. [MHz]	Corr. Factor [dB]	Reading Value [dB (uV)]		Emission Level [dB (uV)]		Limit [dB (uV)]		Margin (dB)	
			Q.P.	AV.	Q.P.	AV.	Q.P.	AV.	Q.P.	AV.
			1	0.150	0.10	48.15	-	48.25	-	66.00
2	0.216	0.10	42.29	-	42.39	-	62.96	52.96	-20.57	-
3	0.291	0.10	38.40	-	38.50	-	60.51	50.51	-22.01	-
4	0.365	0.10	31.78	-	31.88	-	58.62	48.62	-26.74	-
5	0.435	0.11	31.78	-	31.89	-	57.15	47.15	-25.27	-
6	4.074	0.47	32.79	-	33.26	-	56.00	46.00	-22.74	-

- REMARKS:**
1. Q.P. and AV. are abbreviations of quasi-peak and average individually.
 2. "-": The Quasi-peak reading value also meets average limit and measurement with the average detector is unnecessary.
 3. The emission levels of other frequencies were very low against the limit.
 4. Margin value = Emission level - Limit value
 5. Correction factor = Insertion loss + Cable loss
 6. Emission Level = Correction Factor + Reading Value.

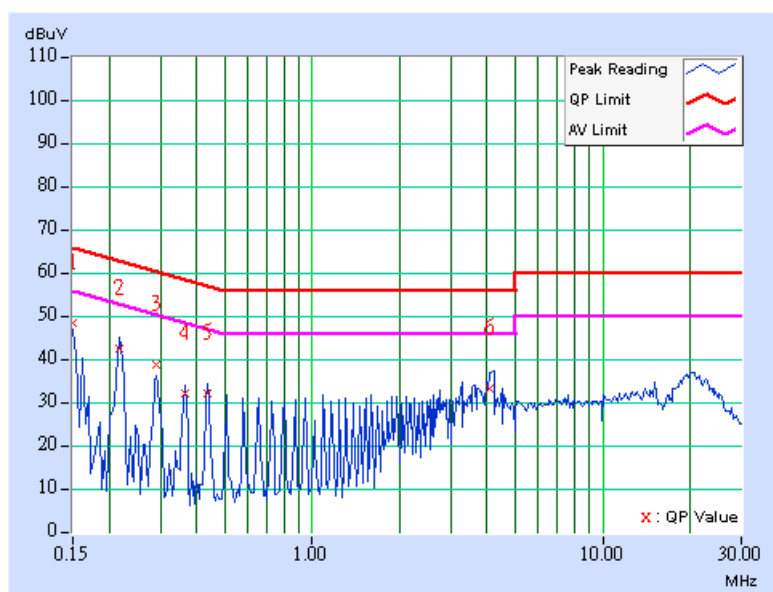

EUT TEST CONDITION		MEASUREMENT DETAIL	
CHANNEL	Channel 5	PHASE	Line 2
MODULATION TYPE	BPSK	6dB BANDWIDTH	9 kHz
TRANSFER RATE	6Mbps	ENVIRONMENTAL CONDITIONS	25deg. C, 68%RH, 991hPa
TEST MODE	B	INPUT POWER (SYSTEM)	120Vac, 60 Hz
TESTED BY	Morgan Chen		

No	Freq. [MHz]	Corr. Factor (dB)	Reading Value [dB (uV)]		Emission Level [dB (uV)]		Limit [dB (uV)]		Margin (dB)	
			Q.P.	AV.	Q.P.	AV.	Q.P.	AV.	Q.P.	AV.
			1	0.150	0.10	47.87	-	47.97	-	66.00
2	0.162	0.10	31.40	-	31.50	-	65.38	55.38	-33.88	-
3	0.197	0.10	21.18	-	21.28	-	63.74	53.74	-42.46	-
4	0.216	0.10	42.65	-	42.75	-	62.96	52.96	-20.21	-
5	0.435	0.10	30.41	-	30.51	-	57.15	47.15	-26.64	-
6	4.145	0.37	31.04	-	31.41	-	56.00	46.00	-24.59	-

- REMARKS:**
1. Q.P. and AV. are abbreviations of quasi-peak and average individually.
 2. "-": The Quasi-peak reading value also meets average limit and measurement with the average detector is unnecessary.
 3. The emission levels of other frequencies were very low against the limit.
 4. Margin value = Emission level - Limit value
 5. Correction factor = Insertion loss + Cable loss
 6. Emission Level = Correction Factor + Reading Value.

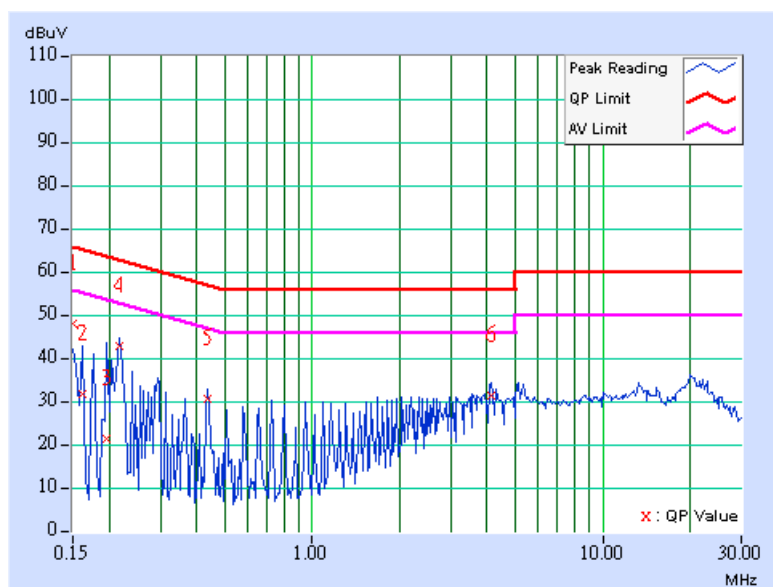

5.2 RADIATED EMISSION MEASUREMENT

5.2.1 LIMITS OF RADIATED EMISSION MEASUREMENT

Emissions radiated outside of the specified bands, shall be according to the general radiated limits in 15.209 as following:

Frequencies (MHz)	Field strength (microvolts/meter)	Measurement distance (meters)
0.009-0.490	2400/F(kHz)	300
0.490-1.705	24000/F(kHz)	30
1.705-30.0	30	30
30-88	100	3
88-216	150	3
216-960	200	3
Above 960	500	3

NOTE:

1. The lower limit shall apply at the transition frequencies.
2. Emission level (dBuV/m) = 20 log Emission level (uV/m).
3. As shown in 15.35(b), for frequencies above 1000MHz, the field strength limits are based on average detector, however, the peak field strength of any emission shall not exceed the maximum permitted average limits, specified above by more than 20dB under any condition of modulation.



5.2.2 TEST INSTRUMENTS

DESCRIPTION & MANUFACTURER	MODEL NO.	SERIAL NO.	CALIBRATED UNTIL
Test Receiver ROHDE & SCHWARZ	ESI7	838496/016	Jan. 01, 2007
Spectrum Analyzer ROHDE & SCHWARZ	FSP40	100041	Dec. 04, 2006
BILOG Antenna SCHWARZBECK	VULB9168	9168-155	Jan. 15, 2007
HORN Antenna SCHWARZBECK	BBHA 9120D	9120D-404	Jan. 01, 2007
HORN Antenna SCHWARZBECK	BBHA 9170	BBHA9170242	Jan. 19, 2007
Preamplifier Agilent	8449B	3008A01960	Nov. 09, 2006
RF signal cable HUBER+SUHNNER	SUCOFLEX 104	219268/4	Dec. 20, 2006
RF signal cable HUBER+SUHNNER	SUCOFLEX 104	230129/4	Dec. 20, 2006
Software ADT.	ADT_Radiated_V5.14	NA	NA
Antenna Tower inn-co GmbH	MA 4000	010303	NA
Antenna Tower Controller inn-co GmbH	CO2000	019303	NA
Turn Table ADT.	TT100.	TT93021704	NA
Turn Table Controller ADT.	SC100.	SC93021704	NA
26GHz ~ 40GHz Amplifier	AMF-6F-2600400	900619	Nov. 13, 2006

- NOTE:**
1. The calibration interval of the above test instruments is 12 months and the calibrations are traceable to NML/ROC and NIST/USA.
 2. The test was performed in HwaYa Chamber 3.
 3. The horn antenna and HP preamplifier (model: 8449B) are used only for the measurement of emission frequency above 1GHz if tested.
 4. The IC Site Registration No. is IC4924-4.

5.2.3 TEST PROCEDURES

- a. The EUT was placed on the top of a rotating table 0.8 meters above the ground at a 3 meters semi-anechoic chamber. The table was rotated 360 degrees to determine the position of the highest radiation.
- b. The EUT was set 3 meters away from the interference-receiving antenna, which was mounted on the top of a variable-height antenna tower.
- c. The antenna is a broadband antenna, and its height is varied from one meter to four meters above the ground to determine the maximum value of the field strength. Both horizontal and vertical polarizations of the antenna are set to make the measurement.
- d. For each suspected emission, the EUT was arranged to its worst case and then the antenna was tuned to heights from 1 meter to 4 meters and the rotatable table was turned from 0 degrees to 360 degrees to find the maximum reading.
- e. The test-receiver system was set to Peak Detect Function and Specified Bandwidth with Maximum Hold Mode.
- f. If the emission level of the EUT in peak mode was lower than the limit specified, then testing could be stopped and the peak values of the EUT would be reported. Otherwise the emissions would be re-tested one by one using peak, quasi-peak or average method as specified and then reported in a data sheet.

NOTE:

1. The resolution bandwidth and video bandwidth of test receiver/spectrum analyzer is 120kHz for Peak detection (PK) and Quasi-peak detection (QP) at frequency below 1GHz.
2. The resolution bandwidth and video bandwidth of test receiver/spectrum analyzer is 1 MHz for Peak detection at frequency above 1GHz.
3. The resolution bandwidth of test receiver/spectrum analyzer is 1 MHz and the video bandwidth is 1 kHz for Average detection (AV) at frequency above 1GHz.

5.2.4 DEVIATION FROM TEST STANDARD

No deviation

5.2.5 TEST SETUP

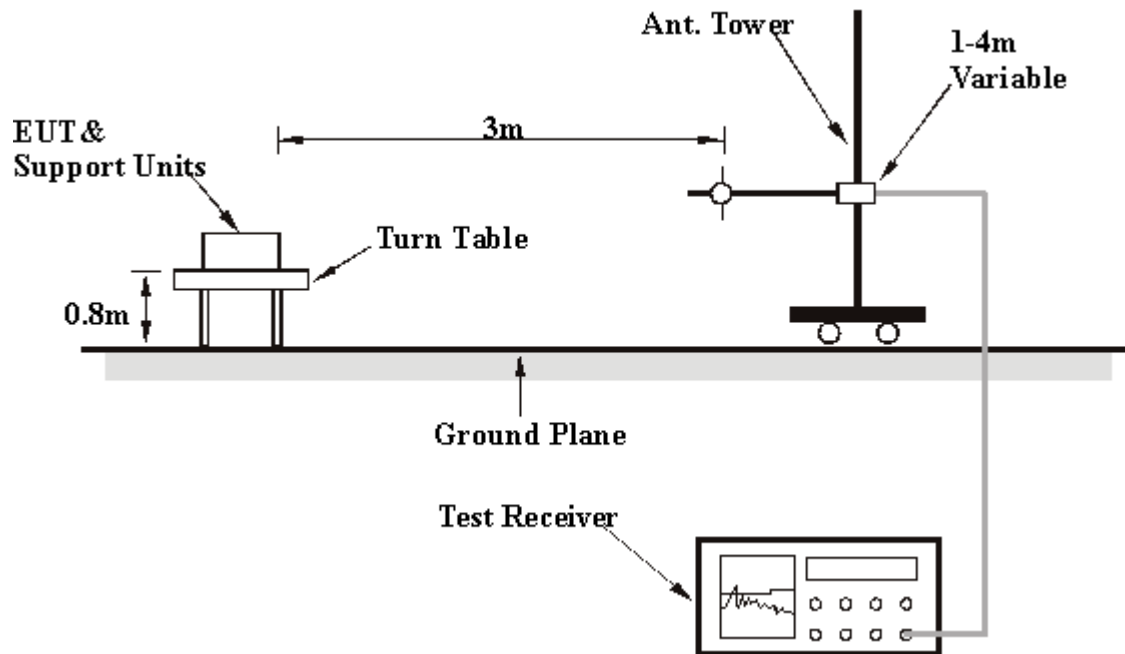

For the actual test configuration, please refer to the related item – Photographs of the Test Configuration.

5.2.6 EUT OPERATING CONDITIONS

Same as 4.1.6



5.2.7 TEST RESULTS

Below 1GHz Worst-Case Data (For Adapter: PA-1650-02)

EUT TEST CONDITION		MEASUREMENT DETAIL	
CHANNEL	Channel 5	FREQUENCY RANGE	Below 1000MHz
MODULATION TYPE	BPSK	DETECTOR FUNCTION	Quasi-Peak
TRANSFER RATE	6Mbps	ENVIRONMENTAL CONDITIONS	22deg. C, 64%RH, 991hPa
INPUT POWER (SYSTEM)	120Vac, 60 Hz	TEST MODE	A
TESTED BY	Brad Wu		

ANTENNA POLARITY & TEST DISTANCE: HORIZONTAL AT 3 M								
No.	Freq. (MHz)	Emission Level (dBuV/m)	Limit (dBuV/m)	Margin (dB)	Antenna Height (m)	Table Angle (Degree)	Raw Value (dBuV)	Correction Factor (dB/m)
1	160.24	33.80 QP	43.50	-9.70	1.50 H	139	20.56	13.24
2	168.02	35.29 QP	43.50	-8.21	1.50 H	223	22.59	12.70
3	341.02	32.51 QP	46.00	-13.49	1.00 H	112	16.52	15.99
4	527.64	33.10 QP	46.00	-12.90	1.25 H	67	12.57	20.53
5	863.93	34.16 QP	46.00	-11.84	1.50 H	262	7.23	26.94
6	912.53	37.35 QP	46.00	-8.65	1.00 H	76	9.32	28.04

ANTENNA POLARITY & TEST DISTANCE: VERTICAL AT 3 M								
No.	Freq. (MHz)	Emission Level (dBuV/m)	Limit (dBuV/m)	Margin (dB)	Antenna Height (m)	Table Angle (Degree)	Raw Value (dBuV)	Correction Factor (dB/m)
1	84.43	28.45 QP	40.00	-11.55	1.50 V	352	18.60	9.85
2	168.02	40.23 QP	43.50	-3.27	1.25 V	58	27.53	12.70
3	409.06	32.66 QP	46.00	-13.34	1.00 V	22	14.70	17.96
4	533.47	37.19 QP	46.00	-8.81	1.25 V	85	16.54	20.65
5	863.93	35.13 QP	46.00	-10.87	1.00 V	328	8.20	26.94
6	912.53	40.17 QP	46.00	-5.83	1.00 V	295	12.14	28.04

- REMARKS:**
1. Emission level(dBuV/m)=Raw Value(dBuV) + Correction Factor(dB/m)
 2. Correction Factor(dB/m) = Antenna Factor (dB/m) + Cable Factor (dB)
 3. The other emission levels were very low against the limit.
 4. Margin value = Emission level – Limit value.



Below 1GHz Worst-Case Data (For Adapter: 0335A1965)

EUT TEST CONDITION		MEASUREMENT DETAIL	
CHANNEL	Channel 5	FREQUENCY RANGE	Below 1000MHz
MODULATION TYPE	BPSK	DETECTOR FUNCTION	Quasi-Peak
TRANSFER RATE	6Mbps	ENVIRONMENTAL CONDITIONS	22deg. C, 64%RH, 991hPa
INPUT POWER (SYSTEM)	120Vac, 60 Hz	TEST MODE	B
TESTED BY	Brad Wu		

ANTENNA POLARITY & TEST DISTANCE: HORIZONTAL AT 3 M								
No.	Freq. (MHz)	Emission Level (dBuV/m)	Limit (dBuV/m)	Margin (dB)	Antenna Height (m)	Table Angle (Degree)	Raw Value (dBuV)	Correction Factor (dB/m)
1	168.02	34.96 QP	43.50	-8.54	1.50 H	238	22.26	12.70
2	272.99	33.00 QP	46.00	-13.00	1.25 H	196	18.76	14.24
3	407.11	33.25 QP	46.00	-12.75	1.00 H	10	15.32	17.93
4	527.64	32.13 QP	46.00	-13.87	1.25 H	325	11.60	20.53
5	863.93	38.61 QP	46.00	-7.39	1.00 H	184	11.67	26.94
6	912.53	39.15 QP	46.00	-6.85	1.00 H	178	11.11	28.04

ANTENNA POLARITY & TEST DISTANCE: VERTICAL AT 3 M								
No.	Freq. (MHz)	Emission Level (dBuV/m)	Limit (dBuV/m)	Margin (dB)	Antenna Height (m)	Table Angle (Degree)	Raw Value (dBuV)	Correction Factor (dB/m)
1	160.24	32.45 QP	43.50	-11.05	1.00 V	232	19.21	13.24
2	168.02	38.74 QP	43.50	-4.76	1.00 V	241	26.04	12.70
3	531.52	36.92 QP	46.00	-9.08	1.00 V	241	16.31	20.61
4	751.18	34.42 QP	46.00	-11.58	1.00 V	298	8.63	25.79
5	863.93	35.71 QP	46.00	-10.29	1.00 V	319	8.77	26.94
6	912.53	39.72 QP	46.00	-6.28	1.25 V	214	11.68	28.04

- REMARKS:**
1. Emission level(dBuV/m)=Raw Value(dBuV) + Correction Factor(dB/m)
 2. Correction Factor(dB/m) = Antenna Factor (dB/m) + Cable Factor (dB)
 3. The other emission levels were very low against the limit.
 4. Margin value = Emission level – Limit value.

802.11a OFDM modulation

EUT TEST CONDITION		MEASUREMENT DETAIL	
CHANNEL	Channel 1	FREQUENCY RANGE	1 ~ 40 GHz
MODULATION TYPE	BPSK	DETECTOR FUNCTION	Peak(PK) Average (AV)
TRANSFER RATE	6Mbps	ENVIRONMENTAL CONDITIONS	22deg. C, 64%RH, 991hPa
INPUT POWER (SYSTEM)	120Vac, 60 Hz	TESTED BY	Brad Wu

ANTENNA POLARITY & TEST DISTANCE: HORIZONTAL AT 3 M								
No.	Freq. (MHz)	Emission Level (dBuV/m)	Limit (dBuV/m)	Margin (dB)	Antenna Height (m)	Table Angle (Degree)	Raw Value (dBuV)	Correction Factor (dB/m)
1	1250.00	43.51 PK	78.20	-34.69	1.10 H	86	15.11	28.39
1	1250.00	38.81 AV	69.22	-30.41	1.10 H	86	10.42	28.39
2	5725.00	51.10 PK	78.20	-25.10	1.20 H	349	10.90	40.20
2	5725.00	42.11 AV	69.22	-27.11	1.20 H	349	1.91	40.20
3	*5745.00	98.21 PK			1.20 H	349	57.95	40.26
3	*5745.00	89.22 AV			1.20 H	349	48.96	40.26
4	#11490.00	59.36 PK	74.00	-14.64	1.04 H	167	7.52	51.84
4	#11490.00	47.03 AV	54.00	-6.97	1.04 H	167	-4.81	51.84

ANTENNA POLARITY & TEST DISTANCE: VERTICAL AT 3 M								
No.	Freq. (MHz)	Emission Level (dBuV/m)	Limit (dBuV/m)	Margin (dB)	Antenna Height (m)	Table Angle (Degree)	Raw Value (dBuV)	Correction Factor (dB/m)
1	1250.00	44.83 PK	81.39	-36.56	1.20 V	74	16.43	28.39
1	1250.00	40.65 AV	72.45	-31.80	1.20 V	74	12.25	28.39
2	5725.00	54.28 PK	81.39	-27.11	1.36 V	338	14.08	40.20
2	5725.00	45.34 AV	72.45	-27.11	1.36 V	338	5.14	40.20
3	*5745.00	101.39 PK			1.36 V	338	61.13	40.26
3	*5745.00	92.45 AV			1.36 V	338	52.19	40.26
4	#11490.00	61.47 PK	74.00	-12.53	1.10 V	75	9.63	51.84
4	#11490.00	49.28 AV	54.00	-4.72	1.10 V	75	-2.56	51.84

- NOTE:**
1. Emission level(dBuV/m)=Raw Value(dBuV) + Correction Factor(dB/m)
 2. Correction Factor(dB/m) = Antenna Factor (dB/m) + Cable Factor (dB)
 3. The other emission levels were very low against the limit.
 4. Margin value = Emission level – Limit value
 5. "*" : Fundamental frequency
 6. "#"The radiated frequency falling in the restricted band.
 7. The limit value is defined as per 15.247

EUT TEST CONDITION		MEASUREMENT DETAIL	
CHANNEL	Channel 3	FREQUENCY RANGE	1 ~ 40 GHz
MODULATION TYPE	BPSK	DETECTOR FUNCTION	Peak(PK) Average (AV)
TRANSFER RATE	6Mbps	ENVIRONMENTAL CONDITIONS	22deg. C, 64%RH, 991hPa
TESTED BY	Brad Wu	INPUT POWER (SYSTEM)	120Vac, 60 Hz

ANTENNA POLARITY & TEST DISTANCE: HORIZONTAL AT 3 M

No.	Freq. (MHz)	Emission Level (dBuV/m)	Limit (dBuV/m)	Margin (dB)	Antenna Height (m)	Table Angle (Degree)	Raw Value (dBuV)	Correction Factor (dB/m)
1	1250.00	43.69 PK	78.36	-34.67	1.02 H	101	15.29	28.39
1	1250.00	38.97 AV	69.40	-30.43	1.02 H	101	10.57	28.39
2	*5785.00	98.36 PK			1.21 H	352	58.00	40.36
2	*5785.00	89.40 AV			1.21 H	352	49.04	40.36
3	#11570.00	59.22 PK	74.00	-14.78	1.05 H	110	7.52	51.70
3	#11570.00	46.87 AV	54.00	-7.13	1.05 H	110	-4.83	51.70

ANTENNA POLARITY & TEST DISTANCE: VERTICAL AT 3 M

No.	Freq. (MHz)	Emission Level (dBuV/m)	Limit (dBuV/m)	Margin (dB)	Antenna Height (m)	Table Angle (Degree)	Raw Value (dBuV)	Correction Factor (dB/m)
1	1250.00	44.91 PK	81.45	-36.54	1.17 V	69	16.51	28.39
1	1250.00	40.72 AV	72.53	-21.72	1.17 V	69	12.32	28.39
2	*5785.00	101.45 PK			1.35 V	347	61.09	40.36
2	*5785.00	92.53 AV			1.35 V	347	52.17	40.36
3	#11570.00	61.23 PK	74.00	-12.77	1.05 V	66	9.53	51.70
3	#11570.00	49.07 AV	54.00	-4.93	1.05 V	66	-2.63	51.70

- NOTE:**
1. Emission level(dBuV/m)=Raw Value(dBuV) + Correction Factor(dB/m)
 2. Correction Factor(dB/m) = Antenna Factor (dB/m) + Cable Factor (dB)
 3. The her emission levels were very low against the limit.
 4. Margin value = Emission level – Limit value
 5. "*" : Fundamental frequency
 6. "#"The radiated frequency falling in the restricted band.
 7. The limit value is defined as per 15.247



EUT TEST CONDITION		MEASUREMENT DETAIL	
CHANNEL	Channel 5	FREQUENCY RANGE	1 ~ 40 GHz
MODULATION TYPE	BPSK	DETECTOR FUNCTION	Peak(PK) Average (AV)
TRANSFER RATE	6Mbps	ENVIRONMENTAL CONDITIONS	22deg. C, 64%RH, 991hPa
TESTED BY	Brad Wu	INPUT POWER (SYSTEM)	120Vac, 60 Hz

ANTENNA POLARITY & TEST DISTANCE: HORIZONTAL AT 3 M								
No.	Freq. (MHz)	Emission Level (dBuV/m)	Limit (dBuV/m)	Margin (dB)	Antenna Height (m)	Table Angle (Degree)	Raw Value (dBuV)	Correction Factor (dB/m)
1	1250.00	43.62 PK	78.36	-34.74	1.07 H	72	15.22	28.39
1	1250.00	38.95 AV	69.42	-30.47	1.07 H	72	10.56	28.39
2	*5825.00	98.36 PK			1.22 H	351	57.90	40.46
2	*5825.00	89.42 AV			1.22 H	351	48.96	40.46
3	5850.00	49.67 PK	78.36	-28.69	1.22 H	351	9.15	40.52
3	5850.00	40.73 AV	69.42	-28.69	1.22 H	351	0.20	40.52
4	#11700.00	59.57 PK	74.00	-14.43	1.02 H	261	8.24	51.33
4	#11700.00	47.28 AV	54.00	-6.72	1.02 H	261	-4.05	51.33

ANTENNA POLARITY & TEST DISTANCE: VERTICAL AT 3 M								
No.	Freq. (MHz)	Emission Level (dBuV/m)	Limit (dBuV/m)	Margin (dB)	Antenna Height (m)	Table Angle (Degree)	Raw Value (dBuV)	Correction Factor (dB/m)
1	1250.00	44.92 PK	81.57	-36.65	1.13 V	60	16.53	28.39
1	1250.00	40.78 AV	72.66	-31.88	1.13 V	60	12.39	28.39
2	*5825.00	101.57 PK			1.31 V	340	61.11	40.46
2	*5825.00	92.66 AV			1.31 V	340	52.20	40.46
3	5850.00	52.88 PK	81.57	-28.69	1.31 V	340	12.36	40.52
3	5850.00	43.97 AV	72.66	-28.69	1.31 V	340	3.45	40.52
4	#11700.00	61.53 PK	74.00	-12.47	1.08 V	69	10.20	51.33
4	#11700.00	49.37 AV	54.00	-4.63	1.08 V	69	-1.96	51.33

- NOTE:**
1. Emission level(dBuV/m)=Raw Value(dBuV) + Correction Factor(dB/m)
 2. Correction Factor(dB/m) = Antenna Factor (dB/m) + Cable Factor (dB)
 3. The other emission levels were very low against the limit.
 4. Margin value = Emission level – Limit value
 5. "*" : Fundamental frequency
 6. "#"The radiated frequency falling in the restricted band.
 7. The limit value is defined as per 15.247



5.3 6dB BANDWIDTH MEASUREMENT

5.3.1 LIMITS OF 6dB BANDWIDTH MEASUREMENT

The minimum of 6dB Bandwidth Measurement is 0.5 MHz.

5.3.2 TEST INSTRUMENTS

Description & Manufacturer	Model No.	Serial No.	Calibrated Until
R&S SPECTRUM ANALYZER	FSEK30	100049	Aug. 14, 2006

NOTES: The calibration interval of the above test instruments is 12 months and the calibrations are traceable to NML/ROC and NIST/USA.

5.3.3 TEST PROCEDURE

The transmitter output was connected to the spectrum analyzer through an attenuator. The bandwidth of the fundamental frequency was measured by spectrum analyzer with 100kHz RBW and 100kHz VBW. The 6dB bandwidth is defined as the total spectrum the power of which is higher than peak power minus 6dB.

5.3.4 DEVIATION FROM TEST STANDARD

No deviation

5.3.5 TEST SETUP

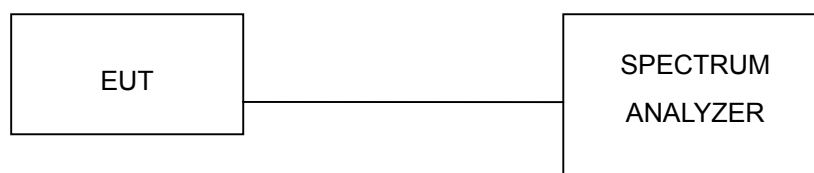

5.3.6 EUT OPERATING CONDITIONS

The software provided by client to enable the EUT under transmission condition continuously at lowest, middle and highest channel frequencies individually.



5.3.7 TEST RESULTS

802.11a OFDM modulation

MODULATION TYPE	BPSK	TRANSFER RATE	6Mbps
INPUT POWER (SYSTEM)	120Vac, 60 Hz	ENVIRONMENTAL CONDITIONS	25deg.C, 61%RH, 991hPa
TESTED BY	Long Chen		

CHANNEL	CHANNEL FREQUENCY (MHz)	6dB BANDWIDTH (MHz)	MINIMUM LIMIT (MHz)	PASS/FAIL
1	5745	16.40	0.5	PASS
3	5785	16.48	0.5	PASS
5	5825	16.48	0.5	PASS

CH 1

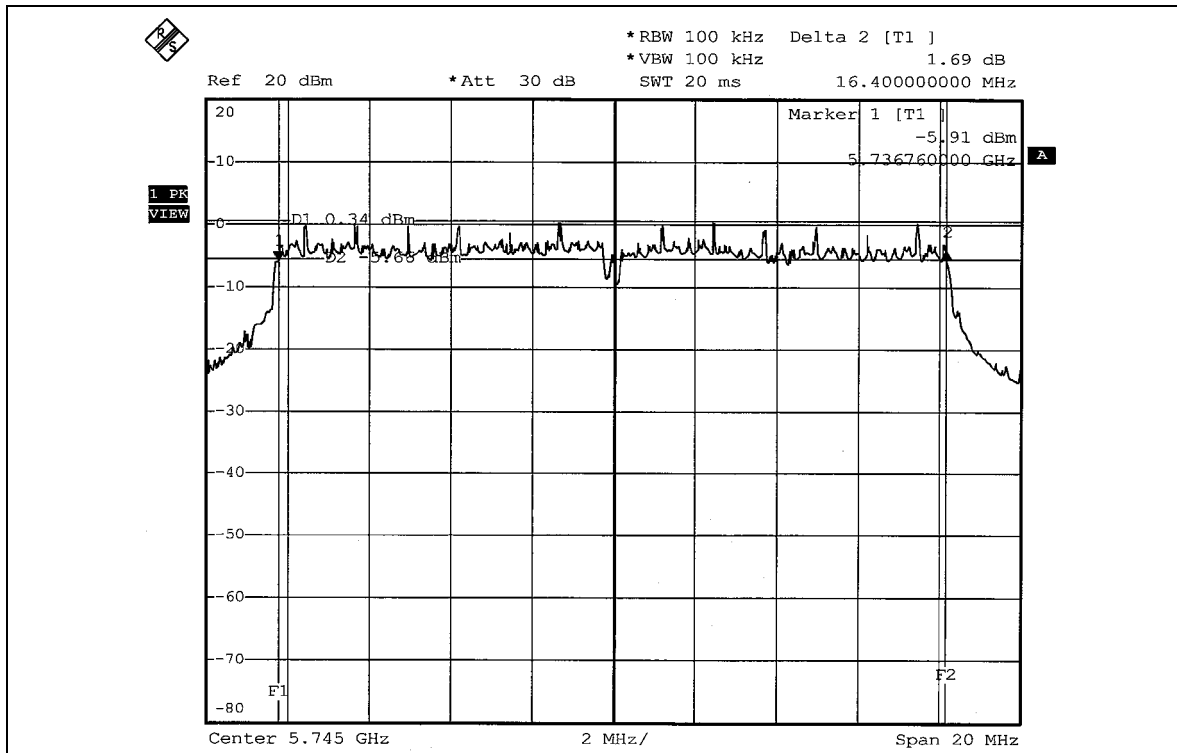

CH 3

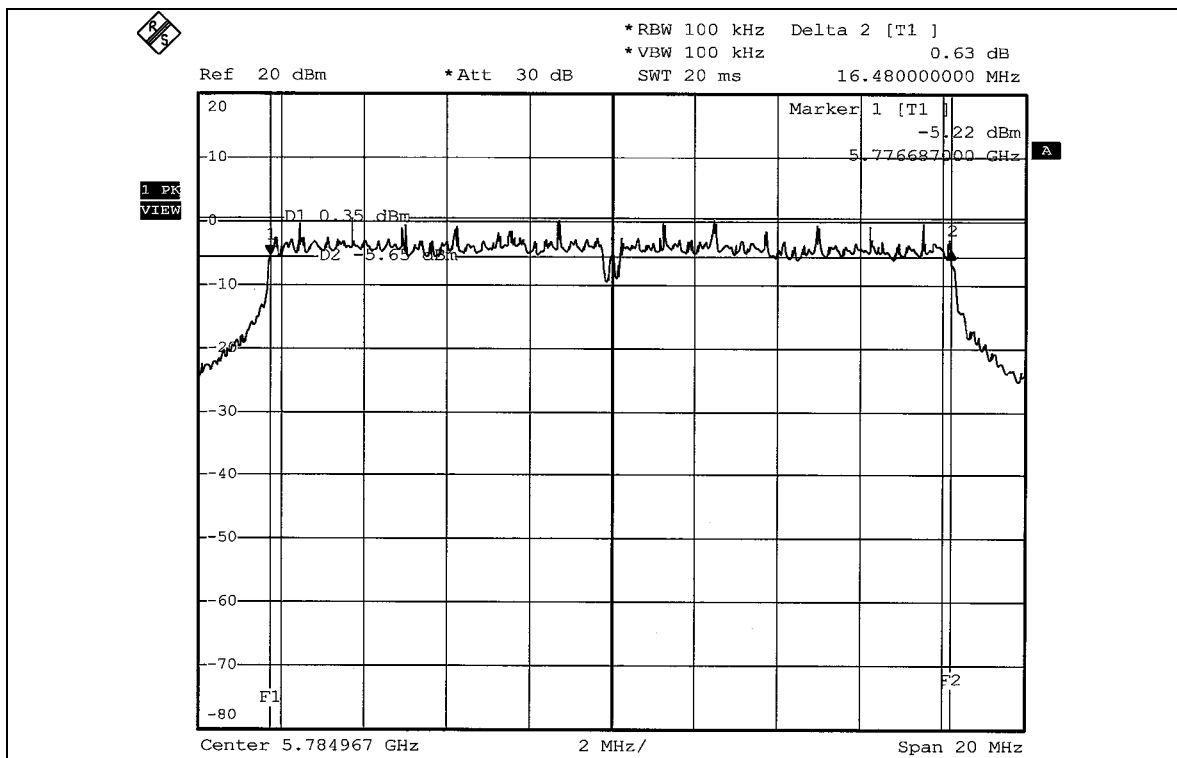

CH 5

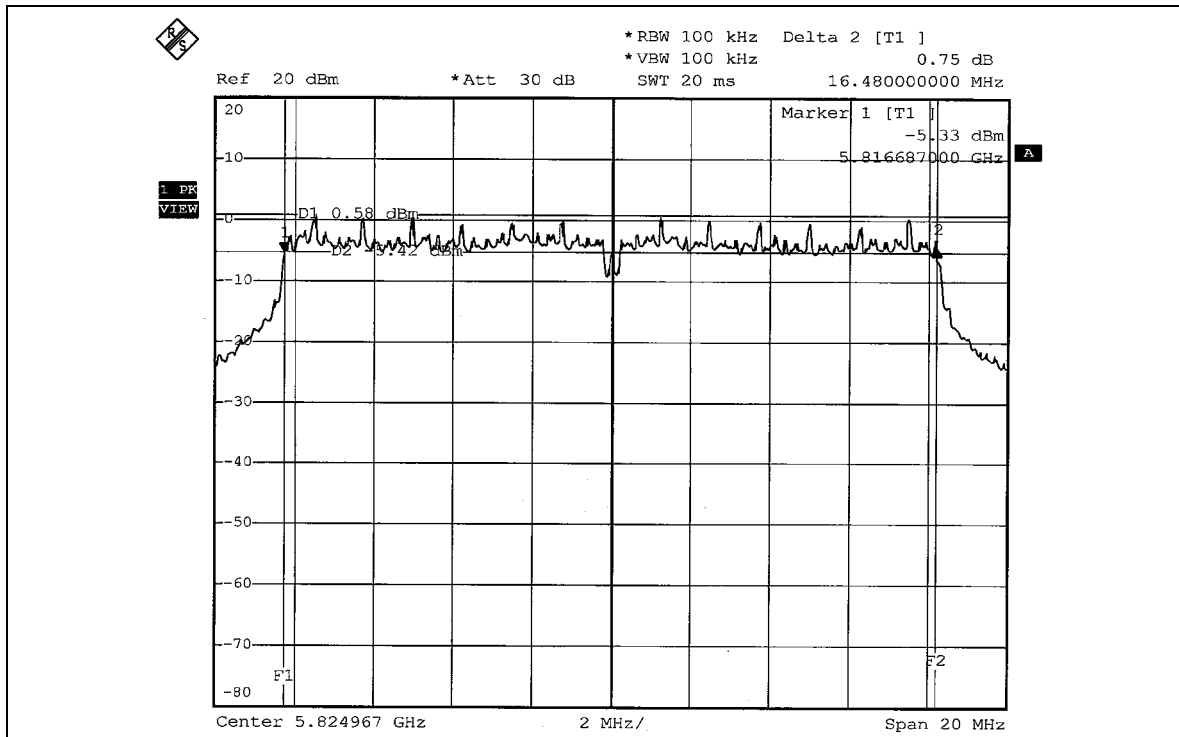



5.4 MAXIMUM PEAK OUTPUT POWER

5.4.1 LIMITS OF MAXIMUM PEAK OUTPUT POWER MEASUREMENT

The Maximum Peak Output Power Measurement is 30dBm.

5.4.2 INSTRUMENTS

Description & Manufacturer	Model No.	Serial No.	Calibrated Until
R&S SPECTRUM ANALYZER	FSEK30	100049	Aug. 14, 2006
AGILENT SIGNAL GENERATOR	E8257C	MY43320668	Dec. 30, 2006
TEKTRONIX OSCILLOSCOPE	TDS 1012	C019167	Jan. 16, 2007
NARDA DETECTOR	4503A	FSCM99899	NA

NOTE:

The calibration interval of the above test instruments is 12 months and the calibrations are traceable to NML/ROC and NIST/USA..

5.4.3 TEST PROCEDURES

1. A detector was used on the output port of the EUT. An oscilloscope was used to read the response of the detector.
2. Replaced the EUT by the signal generator. The center frequency of the S.G was adjusted to the center frequency of the measured channel.
3. Adjusted the power to have the same reading on oscilloscope. Record the power level.

5.4.4 DEVIATION FROM TEST STANDARD

No deviation

5.4.5 TEST SETUP



5.4.6 EUT OPERATING CONDITIONS

Same as Item 5.3.6



5.4.7 TEST RESULTS

802.11a OFDM modulation

MODULATION TYPE	BPSK	TRANSFER RATE	6Mbps
INPUT POWER (SYSTEM)	120Vac, 60 Hz	ENVIRONMENTAL CONDITIONS	25deg.C, 61%RH, 991hPa
TESTED BY	Long Chen		

CHANNEL	CHANNEL FREQUENCY (MHz)	PEAK POWER OUTPUT (mW)	PEAK POWER OUTPUT (dBm)	PEAK POWER LIMIT (dBm)	PASS/FAIL
1	5745	63.387	18.02	30	PASS
3	5785	64.417	18.09	30	PASS
5	5825	64.417	18.09	30	PASS



5.5 POWER SPECTRAL DENSITY MEASUREMENT

5.5.1 LIMITS OF POWER SPECTRAL DENSITY MEASUREMENT

The Maximum of Power Spectral Density Measurement is 8dBm.

5.5.2 TEST INSTRUMENTS

Description & Manufacturer	Model No.	Serial No.	Calibrated Until
R&S SPECTRUM ANALYZER	FSEK30	100049	Aug. 14, 2006

NOTES:

The calibration interval of the above test instruments is 12 months and the calibrations are traceable to NML/ROC and NIST/USA.

5.5.3 TEST PROCEDURE

The transmitter output was connected to the spectrum analyzer through an attenuator, the bandwidth of the fundamental frequency was measured with the spectrum analyzer using 3 kHz RBW and 30 kHz VBW, set sweep time = span/3 kHz. The power spectral density was measured and recorded.

The sweep time is allowed to be longer than span/3 kHz for a full response of the mixer in the spectrum analyzer.

5.5.4 DEVIATION FROM TEST STANDARD

No deviation

5.5.5 TEST SETUP

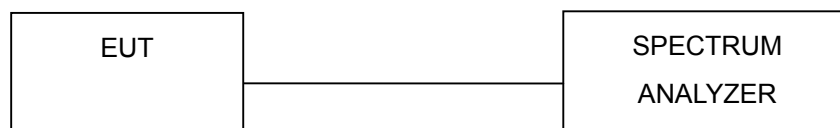

5.5.6 EUT OPERATING CONDITION

Same as Item 5.3.6



5.5.7 TEST RESULTS

802.11a OFDM modulation

MODULATION TYPE	BPSK	TRANSFER RATE	6Mbps
INPUT POWER (SYSTEM)	120Vac, 60 Hz	ENVIRONMENTAL CONDITIONS	25deg.C, 61%RH, 991hPa
TESTED BY	Long Chen		

CHANNEL	CHANNEL FREQUENCY (MHz)	RF POWER LEVEL IN 3 kHz BW (dBm)	MAXIMUM LIMIT (dBm)	PASS/FAIL
1	5745	-9.56	8	PASS
3	5785	-9.41	8	PASS
5	5825	-9.33	8	PASS

CH 1

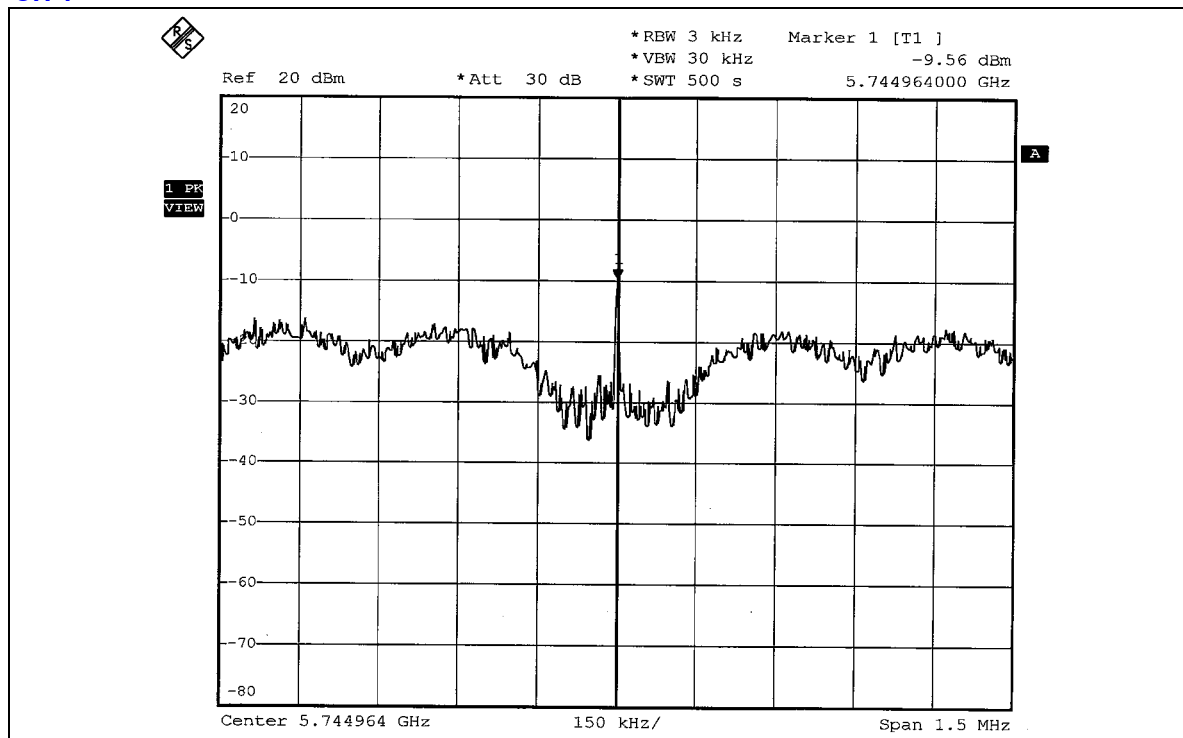

CH 3

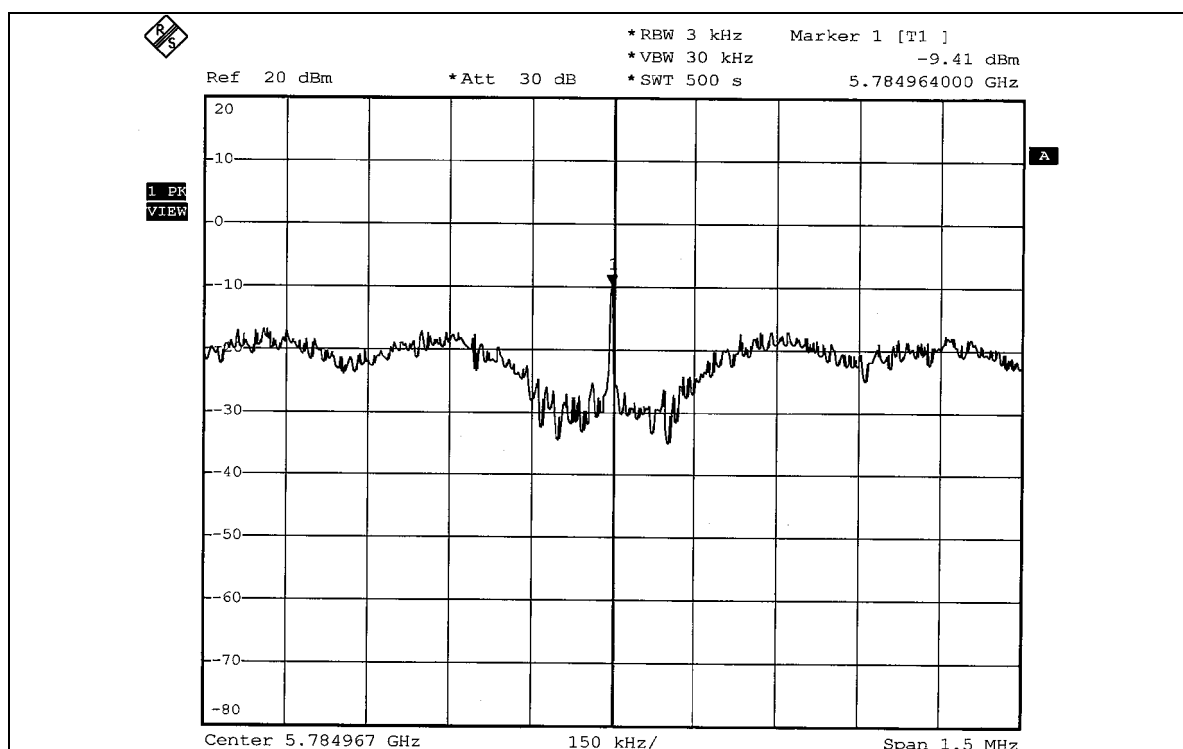

CH 5

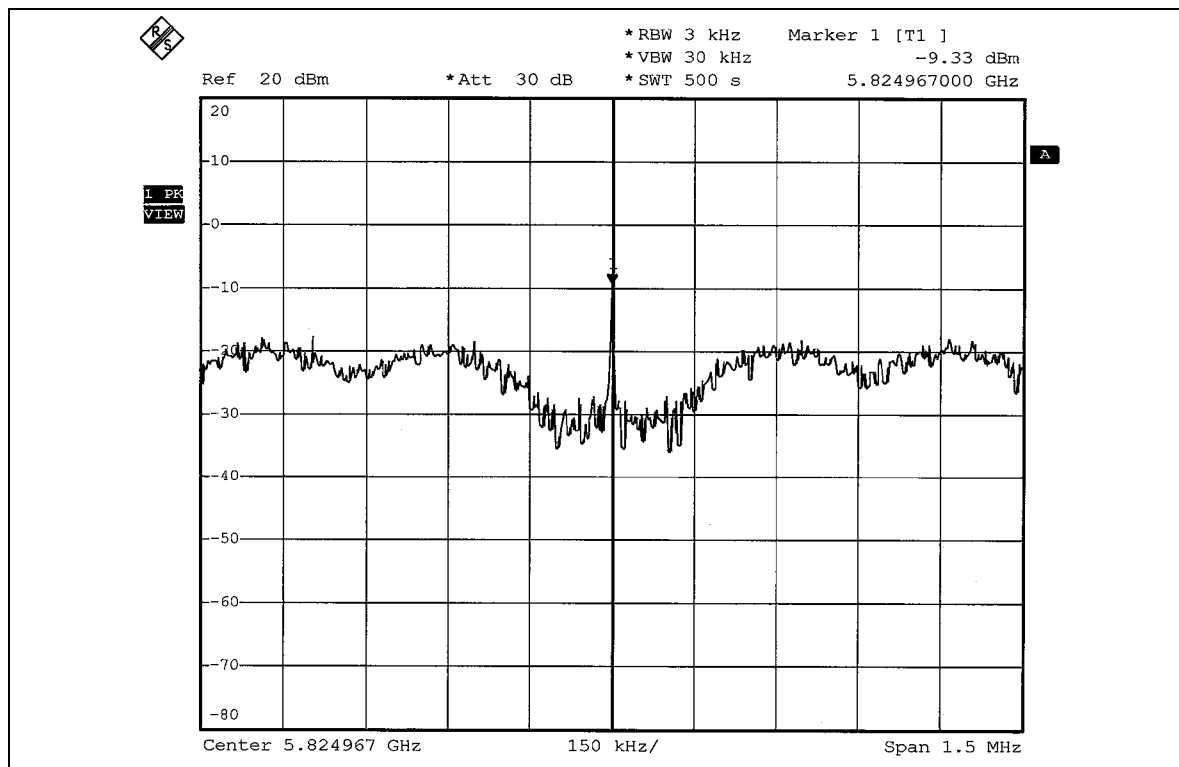



5.6 BAND EDGES MEASUREMENT

5.6.1 LIMITS OF BAND EDGES MEASUREMENT

Below -20dB of the highest emission level of operating band (in 100kHz Resolution Bandwidth).

5.6.2 TEST INSTRUMENTS

Description & Manufacturer	Model No.	Serial No.	Calibrated Until
R&S SPECTRUM ANALYZER	FSEK30	100049	Aug. 14, 2006

NOTES:

The calibration interval of the above test instruments is 12 months and the calibrations are traceable to NML/ROC and NIST/USA.

5.6.3 TEST PROCEDURE

The transmitter output was connected to the spectrum analyzer via a low lose cable. Set both RBW and VBW of spectrum analyzer to 100 kHz with suitable frequency span including 100 MHz bandwidth from band edge. The band edges was measured and recorded.

5.6.4 DEVIATION FROM TEST STANDARD

No deviation

5.6.5 EUT OPERATING CONDITION

Same as Item 5.9.6

5.6.6 TEST RESULTS

The spectrum plots are attached on the following pages. D1 line indicates the highest level, D2 line indicates the 20dB offset below D1. It shows compliance with the requirement in part 15.247(d).

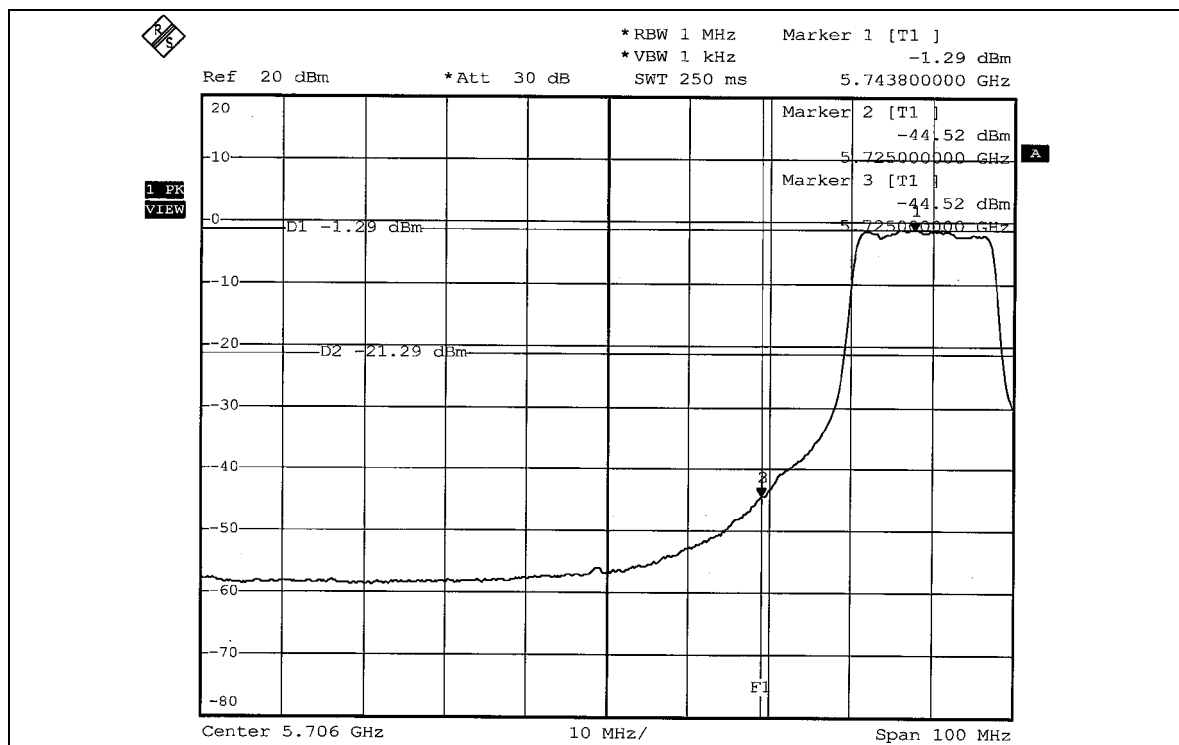
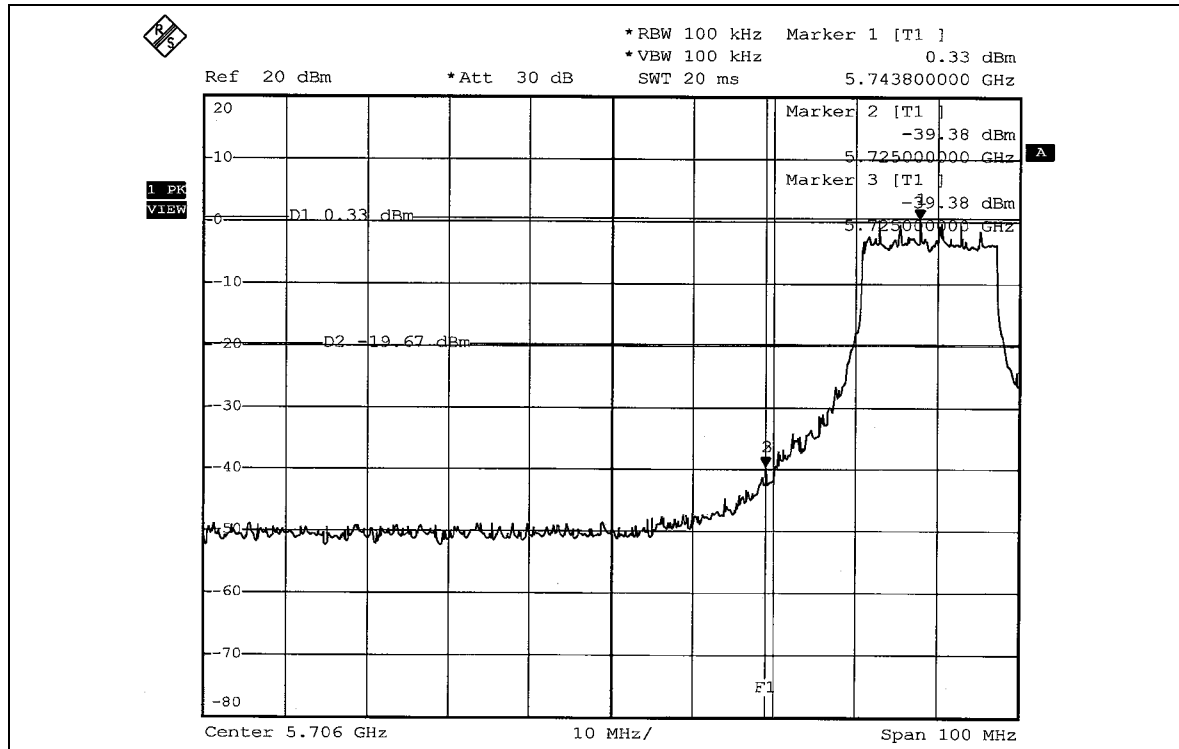

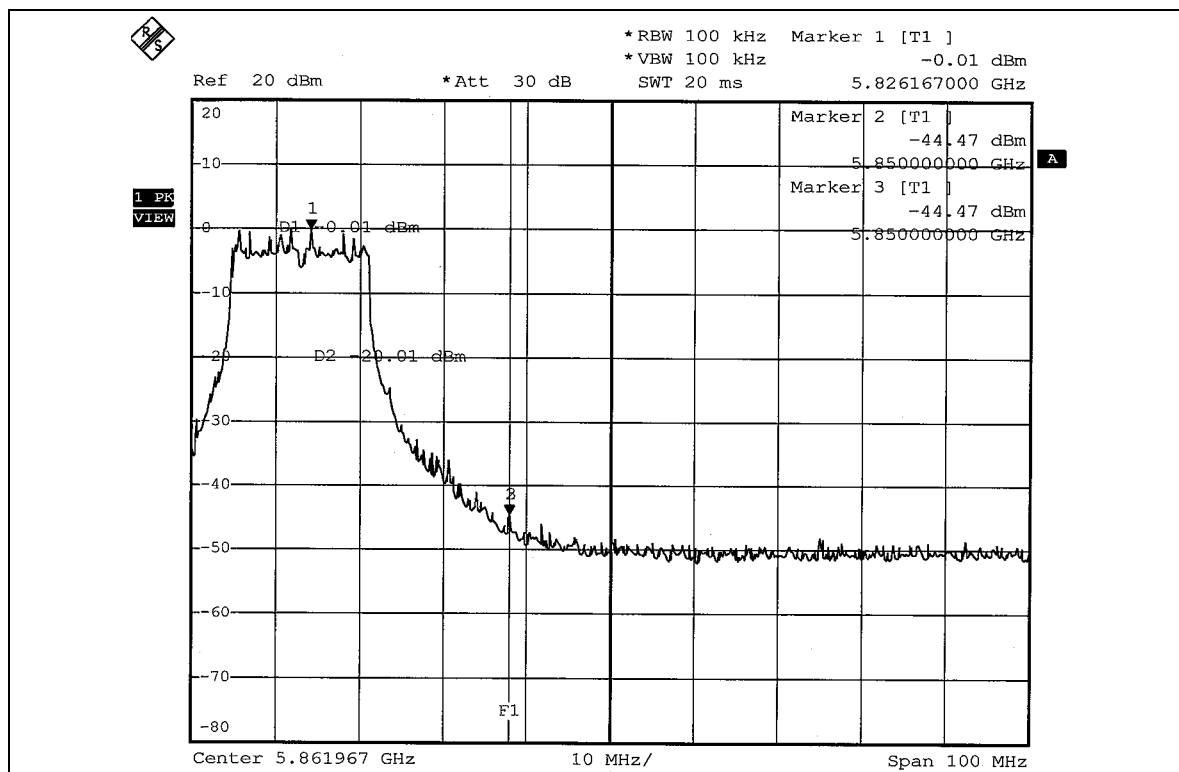
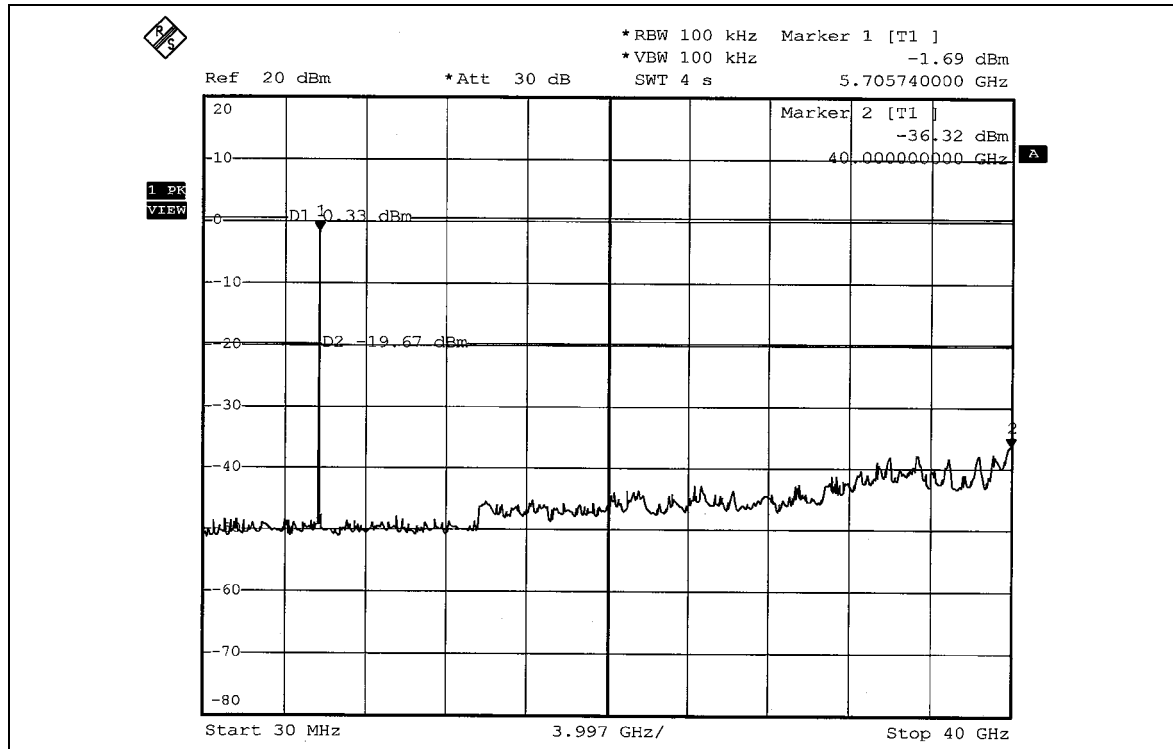

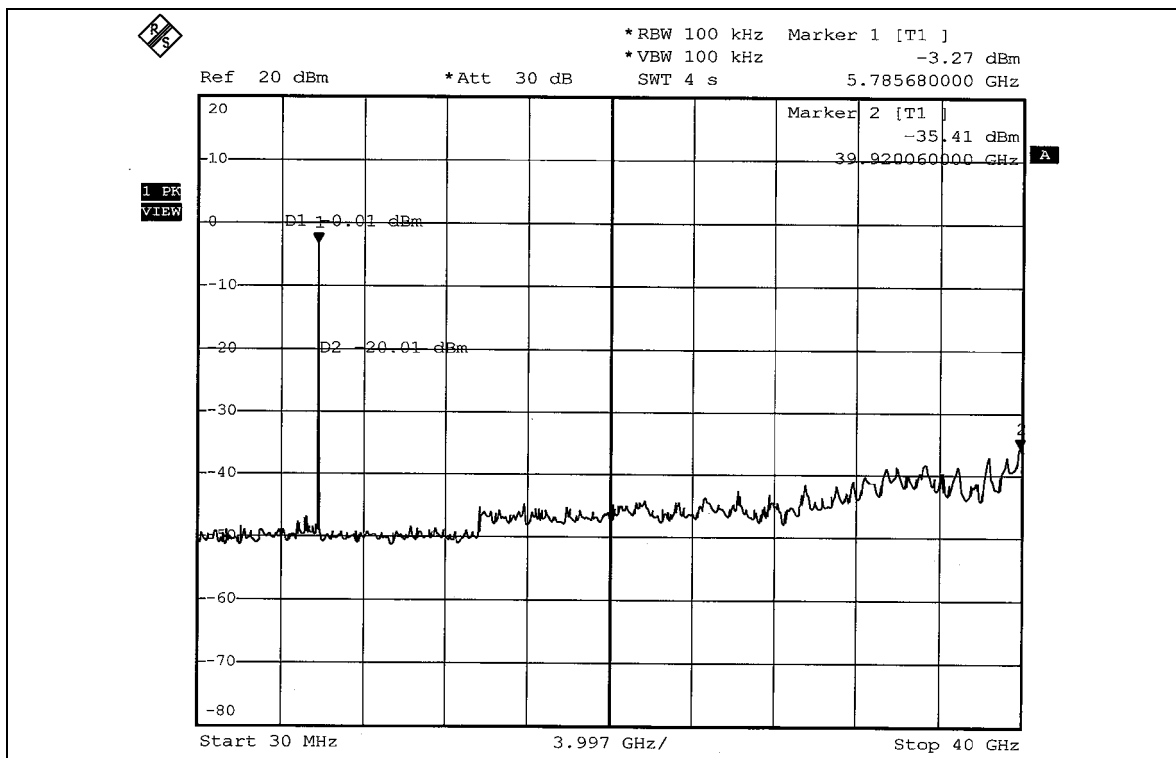
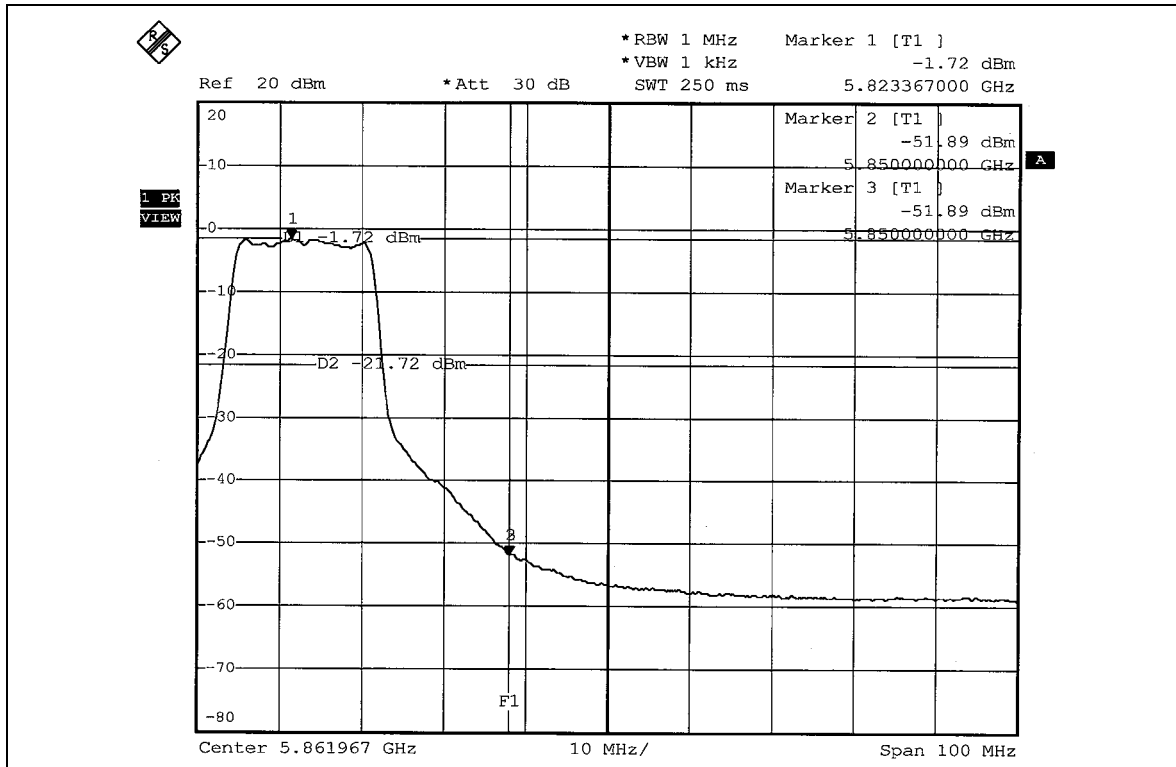



5.7 ANTENNA REQUIREMENT

5.7.1 STANDARD APPLICABLE

For intentional device, according to FCC 47 CFR Section 15.203, an intentional radiator shall be designed to ensure that no antenna other than that furnished by the responsible party shall be used with the device.

And according to FCC 47 CFR Section 15.247(a), if transmitting antennas of directional gain greater than 6dBi are used, the power shall be reduced by the amount in dB that the directional gain of the antenna exceeds 6dBi.

5.7.2 ANTENNA CONNECTED CONSTRUCTION

The antenna used in this product is PIFA antenna with UFL connector. The maximum Gain of the antenna is -2.84636dBi .

6. PHOTOGRAPHS OF THE TEST CONFIGURATION

CONDUCTED EMISSION TEST
TEST MODE A



TEST MODE B



RADIATED EMISSION TEST TEST MODE A

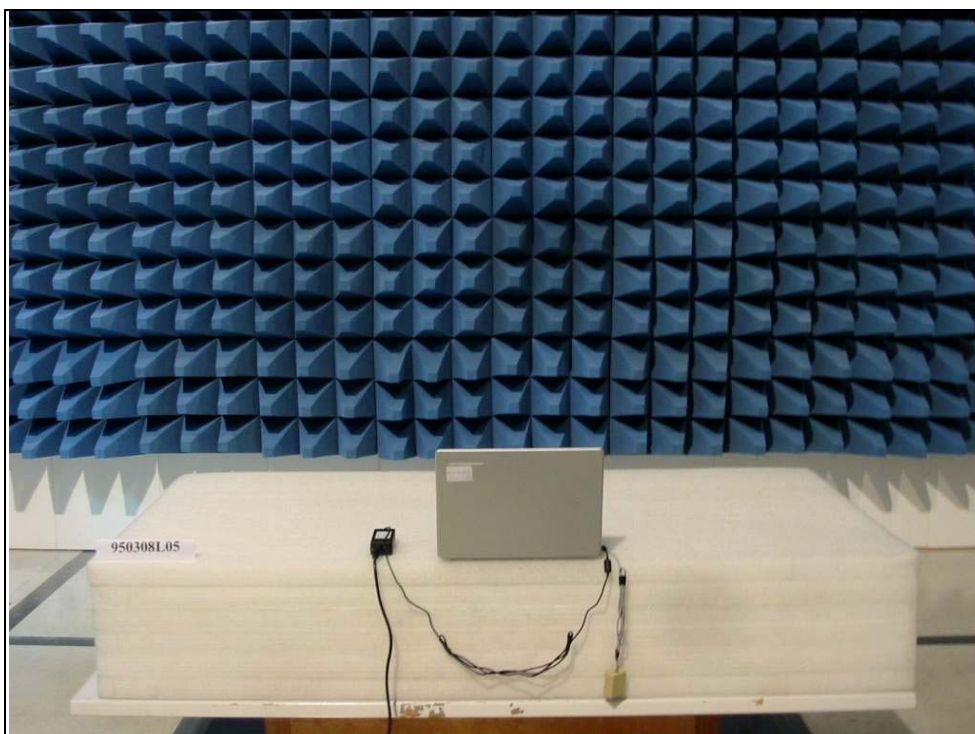
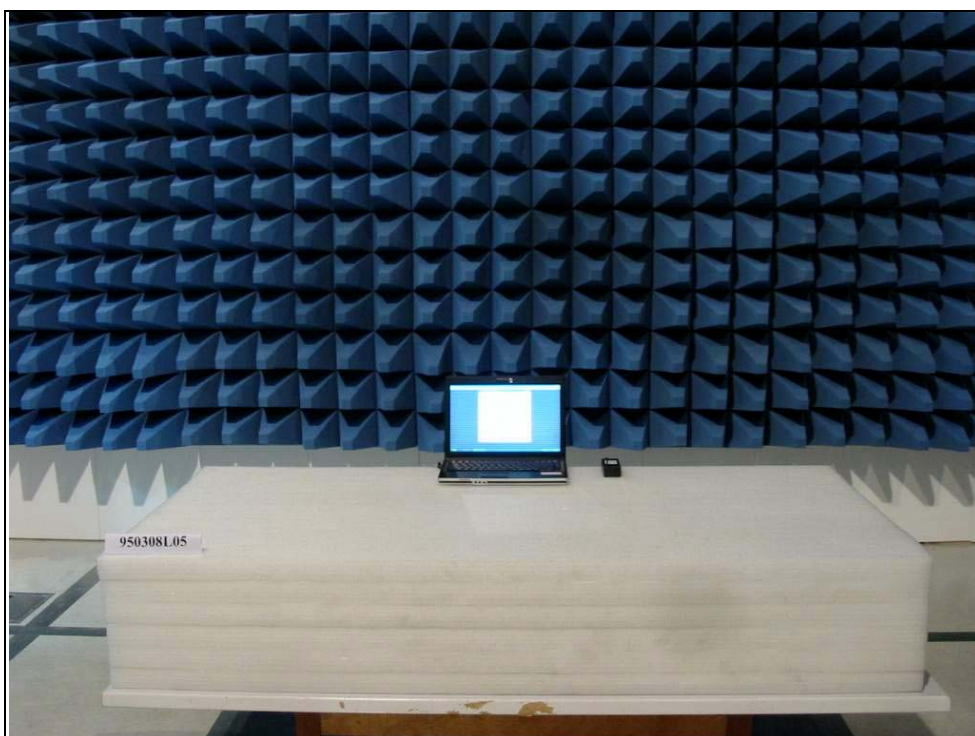

TEST MODE B

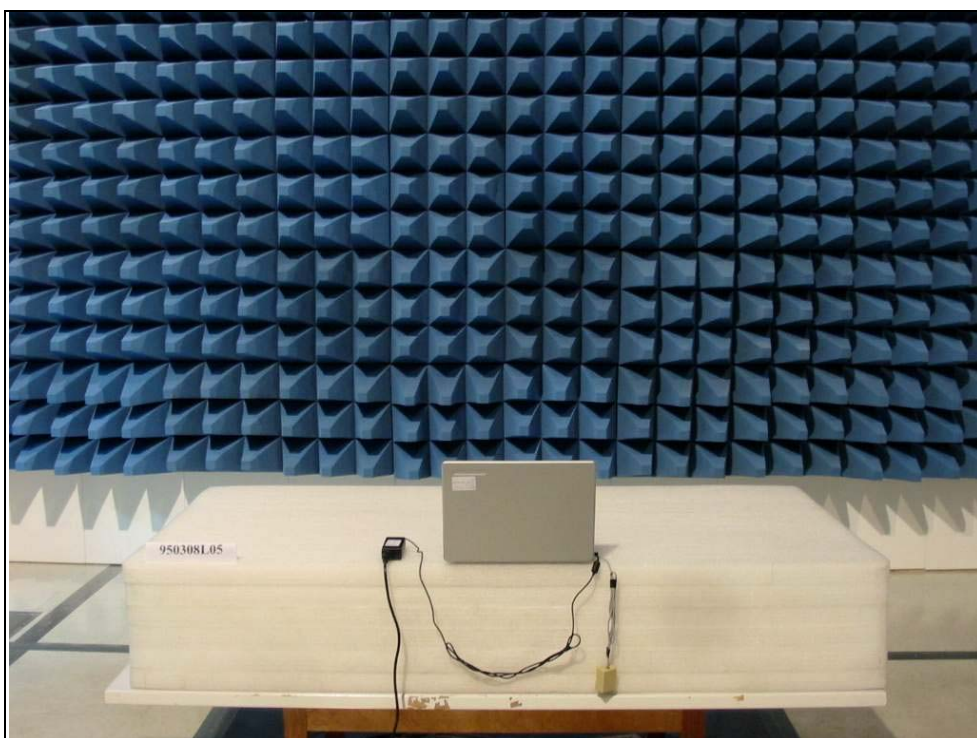
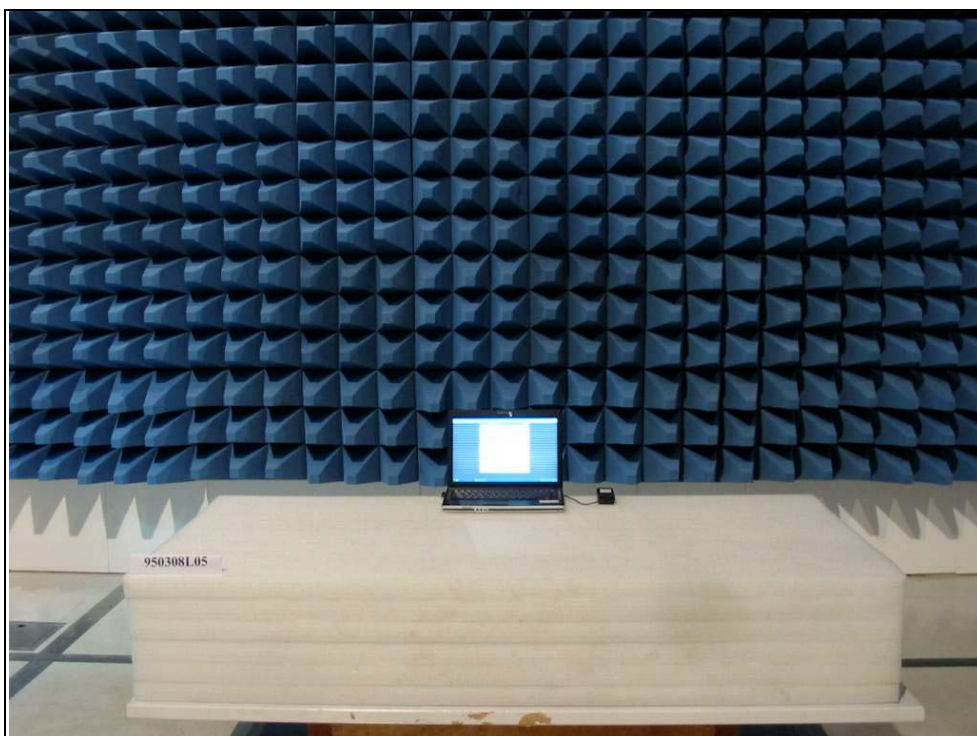



7. INFORMATION ON THE TESTING LABORATORIES

We, ADT Corp., were founded in 1988 to provide our best service in EMC, Radio, Telecom and Safety consultation. Our laboratories are accredited and approved by the following approval agencies according to ISO/IEC 17025.

USA	FCC, UL, A2LA
Germany	TUV Rheinland
Japan	VCCI
Norway	NEMKO
Canada	INDUSTRY CANADA , CSA
R.O.C.	CNLA, BSMI, DGT
Netherlands	Telefication
Singapore	PSB , GOST-ASIA(MOU)
Russia	CERTIS(MOU)

Copies of accreditation certificates of our laboratories obtained from approval agencies can be downloaded from our web site:

www.adt.com.tw/index.5/phtml. If you have any comments, please feel free to contact us at the following:

Linko EMC/RF Lab:

Tel: 886-2-26052180

Fax: 886-2-26052943

Hsin Chu EMC/RF Lab:

Tel: 886-3-5935343

Fax: 886-3-5935342

Hwa Ya EMC/RF/Safety Telecom Lab:

Tel: 886-3-3183232

Fax: 886-3-3185050

Linko RF Lab.

Tel: 886-3-3270910

Fax: 886-3-3270892

Web Site: www.adt.com.tw

The address and road map of all our labs can be found in our web site also.



APPENDIX-A

MODIFICATIONS RECORDERS FOR ENGINEERING CHANGES TO THE EUT BY THE LAB

No any modifications are made to the EUT by the lab during the test.