



FCC TEST REPORT (15.247)

REPORT NO.: RF940317L14
MODEL NO.: 600
RECEIVED: Mar. 17, 2005
TESTED: Mar. 31 ~ Apr. 07, 2005
ISSUED: Apr. 08, 2005

APPLICANT: ELITEGROUP COMPUTER SYSTEMS CO., LTD.

ADDRESS: 2F. No. 240, Sec. 1, Nei Hu Road, Taipei, Taiwan 114,
R.O.C

ISSUED BY: Advance Data Technology Corporation

LAB ADDRESS: No. 47, 14th Ling, Chia Pau Tsuen, Lin Kou
Hsiang 244, Taipei Hsien, Taiwan, R.O.C.

TEST LOCATION: No. 19, Hwa Ya 2nd Rd., Wen Hwa Tsuen,
Kwei Shan Hsiang, Taoyuan Hsien 333,
Taiwan, R.O.C.

This test report consists of 98 pages in total. It may be duplicated completely for legal use with the approval of the applicant. It should not be reproduced except in full, without the written approval of our laboratory. The client should not use it to claim product endorsement by CNLA, A2LA or any government agencies. The test results in the report only apply to the tested sample.



0528
ILAC MRA



No. 2177-01



Table of Contents

1.	CERTIFICATION	5
2.	SUMMARY OF TEST RESULTS	6
2.1	MEASUREMENT UNCERTAINTY	7
3.	GENERAL INFORMATION.....	8
3.1	GENERAL DESCRIPTION OF EUT	8
3.2	DESCRIPTION OF TEST MODES.....	9
3.2.1	CONFIGURATION OF SYSTEM UNDER TEST	10
3.2.2	TEST MODE APPLICABILITY AND TESTED CHANNEL DETAIL:.....	11
3.3	GENERAL DESCRIPTION OF APPLIED STANDARDS	13
3.4	DESCRIPTION OF SUPPORT UNITS	13
4.	TEST TYPES AND RESULTS (802.11b & g 2412~2462MHz BAND)	14
4.1	CONDUCTED EMISSION MEASUREMENT	14
4.1.1	LIMITS OF CONDUCTED EMISSION MEASUREMENT.....	14
4.1.2	TEST INSTRUMENTS.....	14
4.1.3	TEST PROCEDURES	15
4.1.4	DEVIATION FROM TEST STANDARD	15
4.1.5	TEST SETUP	16
4.1.6	EUT OPERATING CONDITIONS	16
4.1.7	TEST RESULTS	16
4.2	RADIATED EMISSION MEASUREMENT	23
4.2.1	LIMITS OF RADIATED EMISSION MEASUREMENT.....	23
4.2.2	TEST INSTRUMENTS.....	24
4.2.3	TEST PROCEDURES	25
4.2.4	DEVIATION FROM TEST STANDARD	25
4.2.5	TEST SETUP	26
4.2.6	EUT OPERATING CONDITIONS	26
4.2.7	TEST RESULTS	27
4.3	6dB BANDWIDTH MEASUREMENT	34
4.3.1	LIMITS OF 6dB BANDWIDTH MEASUREMENT	34
4.3.2	TEST INSTRUMENTS.....	34
4.3.3	TEST PROCEDURE.....	35
4.3.4	DEVIATION FROM TEST STANDARD	35
4.3.5	TEST SETUP	35
4.3.6	EUT OPERATING CONDITIONS	35
4.3.7	TEST RESULTS	36
4.4	MAXIMUM PEAK OUTPUT POWER	42
4.4.1	LIMITS OF MAXIMUM PEAK OUTPUT POWER MEASUREMENT	42
4.4.2	INSTRUMENTS.....	42



4.4.3	TEST PROCEDURES	43
4.4.4	DEVIATION FROM TEST STANDARD	43
4.4.5	TEST SETUP	43
4.4.6	EUT OPERATING CONDITIONS	43
4.4.7	TEST RESULTS	44
4.5	POWER SPECTRAL DENSITY MEASUREMENT	46
4.5.1	LIMITS OF POWER SPECTRAL DENSITY MEASUREMENT	46
4.5.2	TEST INSTRUMENTS.....	46
4.5.3	TEST PROCEDURE.....	47
4.5.4	DEVIATION FROM TEST STANDARD	47
4.5.5	TEST SETUP	47
4.5.6	EUT OPERATING CONDITION	47
4.5.7	TEST RESULTS	48
4.6	BAND EDGES MEASUREMENT	54
4.6.1	LIMITS OF BAND EDGES MEASUREMENT	54
4.6.2	TEST INSTRUMENTS.....	54
4.6.3	TEST PROCEDURE.....	54
4.6.4	DEVIATION FROM TEST STANDARD	54
4.6.5	EUT OPERATING CONDITION	54
4.6.6	TEST RESULTS	55
4.7	ANTENNA REQUIREMENT	63
4.7.1	STANDARD APPLICABLE	63
4.7.2	ANTENNA CONNECTED CONSTRUCTION.....	63
5.	TEST TYPES AND RESULTS (802.11a 5725~5850MHz BAND)	64
5.1	CONDUCTED EMISSION MEASUREMENT	64
5.1.1	LIMITS OF CONDUCTED EMISSION MEASUREMENT.....	64
5.1.2	TEST INSTRUMENTS.....	64
5.1.3	TEST PROCEDURES	65
5.1.4	DEVIATION FROM TEST STANDARD	65
5.1.5	TEST SETUP	66
5.1.6	EUT OPERATING CONDITIONS	66
5.1.7	TEST RESULTS	67
5.2	RADIATED EMISSION MEASUREMENT	69
5.2.1	LIMITS OF RADIATED EMISSION MEASUREMENT.....	69
5.2.2	TEST INSTRUMENTS.....	70
5.2.3	TEST PROCEDURES	70
5.2.4	DEVIATION FROM TEST STANDARD	71
5.2.5	TEST SETUP	72
5.2.6	EUT OPERATING CONDITIONS	72
5.2.7	TEST RESULTS	73
5.3	6dB BANDWIDTH MEASUREMENT	77



5.3.1	LIMITS OF 6dB BANDWIDTH MEASUREMENT	77
5.3.2	TEST INSTRUMENTS.....	77
5.3.3	TEST PROCEDURE.....	78
5.3.4	DEVIATION FROM TEST STANDARD	78
5.3.5	TEST SETUP	78
5.3.6	EUT OPERATING CONDITIONS	78
5.3.7	TEST RESULTS	79
5.4	MAXIMUM PEAK OUTPUT POWER	82
5.4.1	LIMITS OF MAXIMUM PEAK OUTPUT POWER MEASUREMENT	82
5.4.2	INSTRUMENTS.....	82
5.4.3	TEST PROCEDURES	83
5.4.4	DEVIATION FROM TEST STANDARD	83
5.4.5	TEST SETUP	83
5.4.6	EUT OPERATING CONDITIONS	83
5.4.7	TEST RESULTS	84
5.5	POWER SPECTRAL DENSITY MEASUREMENT.....	85
5.5.1	LIMITS OF POWER SPECTRAL DENSITY MEASUREMENT	85
5.5.2	TEST INSTRUMENTS.....	85
5.5.3	TEST PROCEDURE.....	86
5.5.4	DEVIATION FROM TEST STANDARD	86
5.5.5	TEST SETUP	86
5.5.6	EUT OPERATING CONDITION	86
5.5.7	TEST RESULTS	87
5.6	BAND EDGES MEASUREMENT	90
5.6.1	LIMITS OF BAND EDGES MEASUREMENT	90
5.6.2	TEST INSTRUMENTS.....	90
5.6.3	TEST PROCEDURE.....	90
5.6.4	DEVIATION FROM TEST STANDARD	90
5.6.5	EUT OPERATING CONDITION	91
5.6.6	TEST RESULTS	91
5.7	ANTENNA REQUIREMENT	95
5.7.1	STANDARD APPLICABLE	95
5.7.2	ANTENNA CONNECTED CONSTRUCTION.....	95
6.	PHOTOGRAPHS OF THE TEST CONFIGURATION.....	96
7.	INFORMATION ON THE TESTING LABORATORIES	98



1. CERTIFICATION

PRODUCT: Notebook
BRAND NAME: ECS
MODEL NO.: 600
TEST SAMPLE: ENGINEERING SAMPLE
TESTED: Mar. 31 ~ Apr. 07, 2005
APPLICANT: ELITEGROUP COMPUTER SYSTEMS CO., LTD.
STANDARDS: FCC Part 15, Subpart C (Section 15.247),
ANSI C63.4-2003

The above equipment has been tested by **Advance Data Technology Corporation**, and found compliance with the requirement of the above standards. The test record, data evaluation & Equipment Under Test (EUT) configurations represented herein are true and accurate accounts of the measurements of the sample's EMC characteristics under the conditions specified in this report.

PREPARED BY : Candice Chen , **DATE:** Apr. 08, 2005
(Candice Chen)

TECHNICAL
ACCEPTANCE : Gary Chang , **DATE:** Apr. 08, 2005
Responsible for RF (Gary Chang)

APPROVED BY : Cody Chang , **DATE:** Apr. 08, 2005
(Cody Chang,
Deputy Manager)

2. SUMMARY OF TEST RESULTS

The EUT has been tested according to the following specifications:

APPLIED STANDARD: FCC Part 15, Subpart C (Section 15.247)			
Standard Section	Test Type and Limit	Result	Remark
15.207	AC Power Conducted Emission	PASS	Meet the requirement of limit. Minimum passing margin is -23.27dB at 13.402MHz
15.247(a)(2)	Spectrum Bandwidth of a Direct Sequence Spread Spectrum System Limit: min. 500kHz	PASS	Meet the requirement of limit.
15.247(b)	Maximum Peak Output Power Limit: max. 30dBm	PASS	Meet the requirement of limit.
15.247(d)	Radiated Emissions Limit: Table 15.209	PASS	Meet the requirement of limit. Minimum passing margin is -4.29dB at 11490.00MHz
15.247(e)	Power Spectral Density Limit: max. 8dBm	PASS	Meet the requirement of limit.
15.247(d)	Band Edge Measurement Limit: 20dB less than the peak value of fundamental frequency	PASS	Meet the requirement of limit.

2.1 MEASUREMENT UNCERTAINTY

Where relevant, the following measurement uncertainty levels have been estimated for tests performed on the EUT as specified in CISPR 16-4:

Measurement	Frequency	Uncertainty
Conducted emissions	9kHz~30MHz	2.44 dB
	30MHz ~ 200MHz	3.63 dB
Radiated emissions	200MHz ~1000MHz	3.65 dB
	1GHz ~ 18GHz	2.20 dB
	18GHz ~ 40GHz	1.88 dB

3. GENERAL INFORMATION

3.1 GENERAL DESCRIPTION OF EUT

EUT	Notebook
MODEL NO.	600
POWER SUPPLY	19Vdc from AC adapter
MODULATION TYPE	CCK, DQPSK, DBPSK for DSSS 64QAM, 16QAM, QPSK, BPSK for OFDM
MODULATION TECHNOLOGY	DSSS, OFDM
TRANSFER RATE	802.11b: 11/5.5/2/1Mbps 802.11g: 54/48/36/24/18/12/9/6Mbps 802.11a: 54/48/36/24/18/12/9/6Mbps
FREQUENCY RANGE	802.11b & 802.11g: 2412 ~ 2462MHz 802.11a: 5.15 ~ 5.35GHz and 5.725 ~ 5.850GHz
NUMBER OF CHANNEL	802.11b & 802.11g: 11 802.11a: 13
CHANNEL SPACING	802.11b & 802.11g: 5MHz 802.11a: 20MHz
OUTPUT POWER	802.11b: 63.826mW 802.11g: 50.350mW 802.11a: 40.365mW
DATA CABLE	NA
ANTENNA TYPE	PIFA antenna with -3.37dBi gain (for 2.4GHz) PIFA antenna with -4.39dBi gain (for 5.0GHz)
I/O PORTS	Refer to user's manual
ASSOCIATED DEVICES	NA

NOTE:

1. The EUT was tested with the following adapter.

BRAND	LITEON
MODEL	PA-1900-05
INPUT	100-240Vac , 50-60Hz , 1.5A
OUTPUT	19Vdc, 4.74A
POWER LINE	AC 1.6m non-shielded cable without core DC 1.6m non-shielded cable with one core

2. The EUT operates in both the 5GHz and 2.4GHz Bands and compatibility with 802.11a and 802.11b, 802.11g technology.
3. The above EUT information was declared by the manufacturer and for more detailed features description, please refer to the manufacturer's specifications or User's Manual.



3.2 DESCRIPTION OF TEST MODES

Operated in 2400 ~ 2483.5MHz band:

For 802.11b/g: Eleven channels are provided to this EUT.

Channel	Frequency	Channel	Frequency
1	2412 MHz	7	2442 MHz
2	2417 MHz	8	2447 MHz
3	2422 MHz	9	2452 MHz
4	2427 MHz	10	2457 MHz
5	2432 MHz	11	2462 MHz
6	2437 MHz		

Operated in 5725 ~ 5850MHz band:

For 802.11a: Five channels are provided to this EUT.

Channel	Frequency
1	5745 MHz
2	5765 MHz
3	5785 MHz
4	5805 MHz
5	5825 MHz

3.2.1 CONFIGURATION OF SYSTEM UNDER TEST

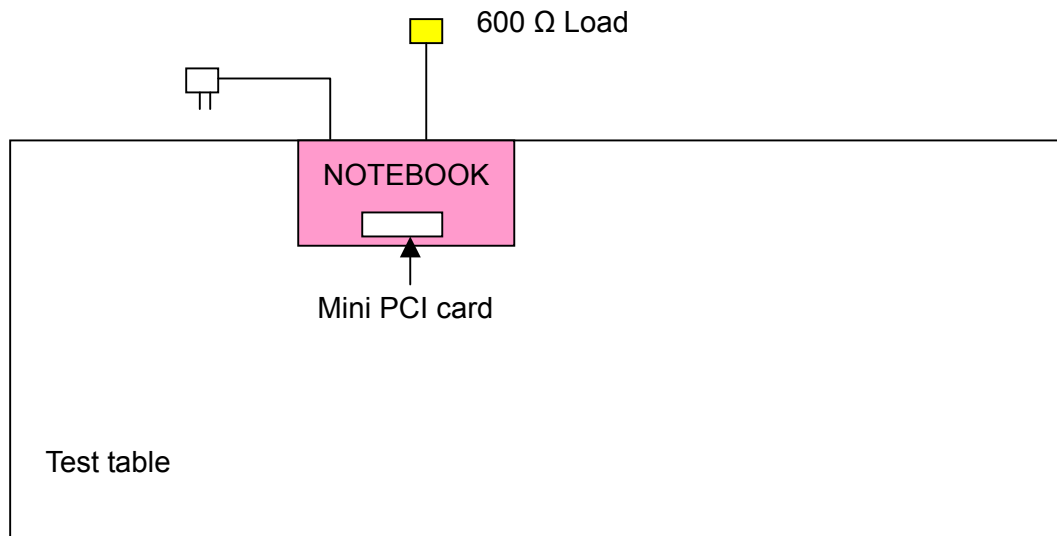



3.2.2 TEST MODE APPLICABILITY AND TESTED CHANNEL DETAIL:

EUT configure mode	Applicable to				Description
	PLC	RE<1G	RE≥1G	APCM	
-	X	X	X	X	NA

Where PLC: Power Line Conducted Emission RE<1G RE: Radiated Emission below 1GHz
 RE≥1G: Radiated Emission above 1GHz APCM: Antenna Port Conducted Measurement

Power Line Conducted Emission Test:

- Pre-Scan has been conducted to determine the worst-case mode from all possible combinations between available modulations, data rates and antenna ports (if EUT with antenna diversity architecture).
- Following channel(s) was (were) selected for the final test as listed below.

Mode	Available Channel	Tested Channel	Modulation Technology	Modulation Type	Data Rate (Mbps)
802.11g	1 to 11	1, 6, 11	OFDM	BPSK	6
802.11a	1 to 5	3	OFDM	BPSK	6

Radiated Emission Test (Below 1 GHz):

- Pre-Scan has been conducted to determine the worst-case mode from all possible combinations between available modulations, data rates and antenna ports (if EUT with antenna diversity architecture).
- Following channel(s) was (were) selected for the final test as listed below.

Mode	Available Channel	Tested Channel	Modulation Technology	Modulation Type	Data Rate (Mbps)
802.11g	1 to 11	11	OFDM	BPSK	6
802.11a	1 to 5	3	OFDM	BPSK	6

Radiated Emission Test (Above 1 GHz):

- Pre-Scan has been conducted to determine the worst-case mode from all possible combinations between available modulations, data rates and antenna ports (if EUT with antenna diversity architecture).
- Following channel(s) was (were) selected for the final test as listed below.

Mode	Available Channel	Tested Channel	Modulation Technology	Modulation Type	Data Rate (Mbps)
802.11b	1 to 11	1, 6, 11	DSSS	CCK	11
802.11g	1 to 11	1, 6, 11	OFDM	BPSK	6
802.11a	1 to 5	1, 3, 5	OFDM	BPSK	6



Bandedge Measurement:

- Pre-Scan has been conducted to determine the worst-case mode from all possible combinations between available modulations, data rates and antenna ports (if EUT with antenna diversity architecture).
- Following channel(s) was (were) selected for the final test as listed below.

Mode	Available Channel	Tested Channel	Modulation Technology	Modulation Type	Data Rate (Mbps)
802.11b	1 to 11	1, 11	DSSS	CCK	11
802.11g	1 to 11	1, 11	OFDM	BPSK	6
802.11a	1 to 5	1, 5	OFDM	BPSK	6

Antenna Port Conducted Measurement:

- Pre-Scan has been conducted to determine the worst-case mode from all possible combinations between available modulations, data rates and antenna ports (if EUT with antenna diversity architecture).
- Following channel(s) was (were) selected for the final test as listed below.

Mode	Available Channel	Tested Channel	Modulation Technology	Modulation Type	Data Rate (Mbps)
802.11b	1 to 11	1, 6, 11	DSSS	CCK	11
802.11g	1 to 11	1, 6, 11	OFDM	BPSK	6
802.11a	1 to 5	1, 3, 5	OFDM	BPSK	6



3.3 GENERAL DESCRIPTION OF APPLIED STANDARDS

The EUT is a Notebook. According to the specifications of the manufacturer, it must comply with the requirements of the following standards:

FCC Part 15, Subpart C. (15.247)

ANSI C63.4-2003

All test items have been performed and recorded as per the above standards.

NOTE: The EUT is also considered as a kind of computer peripheral, because the connection to computer is necessary for typical use. It has been verified to comply with the requirements of FCC Part 15, Subpart B, Class B (DoC). The test report has been issued separately.

3.4 DESCRIPTION OF SUPPORT UNITS

The EUT has been tested as an independent unit together with other necessary accessories or support units. The following support units or accessories were used to form a representative test configuration during the tests.

NO.	PRODUCT	BRAND	MODEL NO.	SERIAL NO.	FCC ID
1	600 Ω LOAD	NA	NA	NA	NA

NO.	SIGNAL CABLE DESCRIPTION OF THE ABOVE SUPPORT UNITS
1	NA

NOTE: All power cords of the above support units are non shielded (1.8m).



4. TEST TYPES AND RESULTS (802.11b & g 2412~2462MHz Band)

4.1 CONDUCTED EMISSION MEASUREMENT

4.1.1 LIMITS OF CONDUCTED EMISSION MEASUREMENT

FREQUENCY OF EMISSION (MHz)	CONDUCTED LIMIT (dB μ V)	
	Quasi-peak	Average
0.15-0.5	66 to 56	56 to 46
0.5-5	56	46
5-30	60	50

- NOTE:**
1. The lower limit shall apply at the transition frequencies.
 2. The limit decreases in line with the logarithm of the frequency in the range of 0.15 to 0.50 MHz.
 3. All emanations from a class A/B digital device or system, including any network of conductors and apparatus connected thereto, shall not exceed the level of field strengths specified above.

4.1.2 TEST INSTRUMENTS

DESCRIPTION & MANUFACTURER	MODEL NO.	SERIAL NO.	CALIBRATED UNTIL
Test Receiver ROHDE & SCHWARZ	ESCS30	100291	Nov. 16, 2005
RF signal cable Woken	5D-FB	Cable-HYC01-01	Jan. 09, 2006
LISN ROHDE & SCHWARZ	ESH3-Z5	100312	Feb. 15, 2006
LISN ROHDE & SCHWARZ	ESH2-Z5	100104	Feb. 15, 2006
Software ADT	ADT_Cond_V3	NA	NA

- NOTE:**
1. The calibration interval of the above test instruments is 12 months and the calibrations are traceable to NML/ROC and NIST/USA.
 2. The test was performed in HwaYa Shielded Room 1.
 3. The VCCI Site Registration No. is C-2040.



4.1.3 TEST PROCEDURES

- a. The EUT was placed 0.4 meters from the conducting wall of the shielded room with EUT being connected to the power mains through a line impedance stabilization network (LISN). Other support units were connected to the power mains through another LISN. The two LISNs provide 50 ohm/ 50uH of coupling impedance for the measuring instrument.
- b. Both lines of the power mains connected to the EUT were checked for maximum conducted interference.
- c. The frequency range from 150kHz to 30MHz was searched. Emission levels under (Limit - 20dB) was not recorded.

4.1.4 DEVIATION FROM TEST STANDARD

No deviation

4.1.5 TEST SETUP

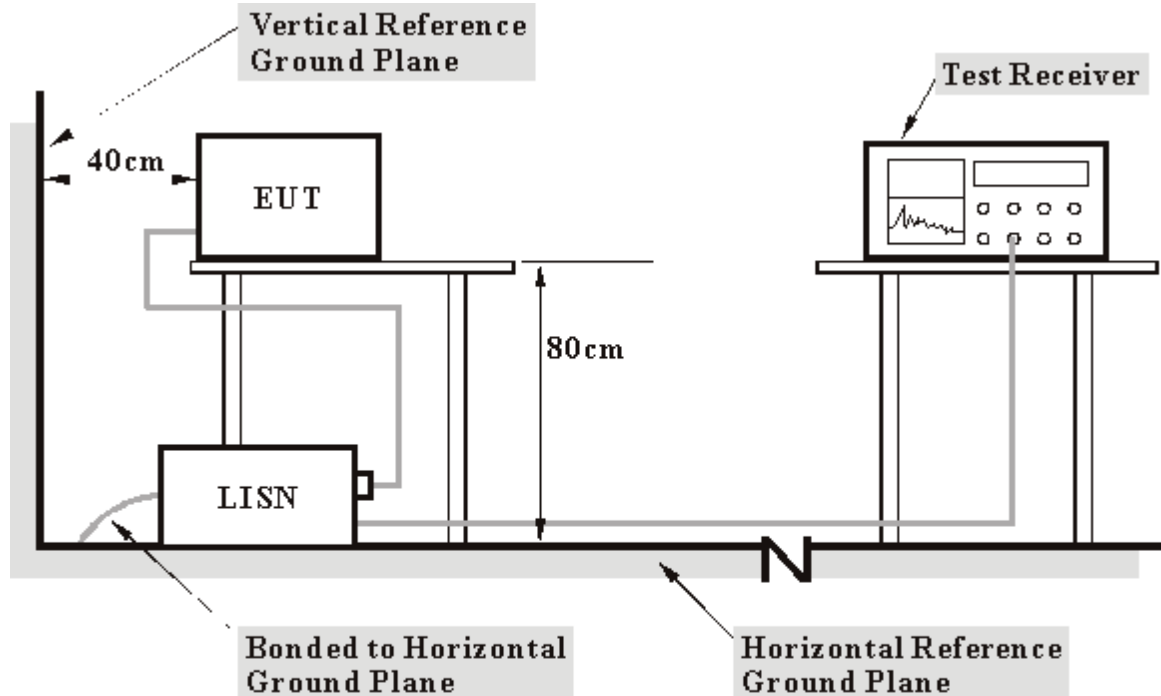

- Note:**
1. Support units were connected to second LISN.
 2. Both of LISNs (AMN) 80 cm from EUT and at the least 80 cm from other units and other metal planes support units.

For the actual test configuration, please refer to the related item – Photographs of the Test Configuration.

4.1.6 EUT OPERATING CONDITIONS

- a. Placed the EUT on a testing table.
- b. The EUT ran a test program (provided by manufacturer) to enable all functions under transmission/receiving condition continuously at specific channel frequency.
- c. The notebook system sent "H" messages to its screen.



4.1.7 TEST RESULTS

Conducted Worst-Case Data

EUT	Notebook	MODEL	600
CHANNEL	Channel 1	6dB BANDWIDTH	9 kHz
MODULATION TYPE	BPSK	TRANSFER RATE	6Mbps
INPUT POWER (SYSTEM)	120Vac, 60 Hz	PHASE	Line (L)
ENVIRONMENTAL CONDITIONS	22deg. C, 70%RH, 991hPa	TESTED BY	Derry Tsui

No	Freq. [MHz]	Corr. Factor (dB)	Reading Value [dB (uV)]		Emission Level [dB (uV)]		Limit [dB (uV)]		Margin (dB)	
			Q.P.	AV.	Q.P.	AV.	Q.P.	AV.	Q.P.	AV.
			1	0.160	0.10	39.24	-	39.34	-	65.46
2	0.480	0.12	20.58	-	20.70	-	56.33	46.33	-35.63	-
3	0.880	0.17	25.26	-	25.43	-	56.00	46.00	-30.57	-
4	2.422	0.23	25.44	-	25.67	-	56.00	46.00	-30.33	-
5	12.512	0.53	34.82	-	35.35	-	60.00	50.00	-24.65	-
6	15.684	0.67	32.22	-	32.89	-	60.00	50.00	-27.11	-

- REMARKS:**
1. Q.P. and AV. are abbreviations of quasi-peak and average individually.
 2. "-": The Quasi-peak reading value also meets average limit and measurement with the average detector is unnecessary.
 3. The emission levels of other frequencies were very low against the limit.
 4. Margin value = Emission level - Limit value
 5. Correction factor = Insertion loss + Cable loss
 6. Emission Level = Correction Factor + Reading Value.

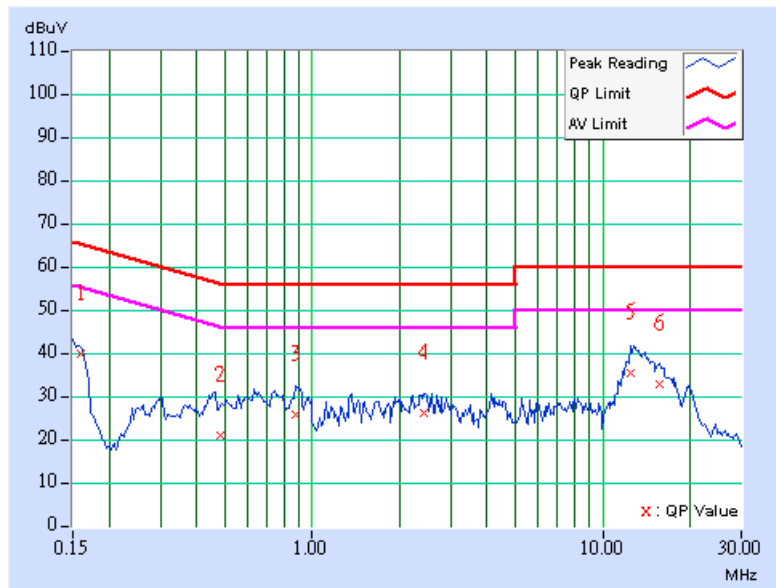



EUT	Notebook	MODEL	600
CHANNEL	Channel 1	6dB BANDWIDTH	9 kHz
MODULATION TYPE	BPSK	TRANSFER RATE	6Mbps
INPUT POWER (SYSTEM)	120Vac, 60 Hz	PHASE	Neutral (N)
ENVIRONMENTAL CONDITIONS	22deg. C, 70%RH, 991hPa	TESTED BY	Derry Tsui

No	Freq. [MHz]	Corr. Factor (dB)	Reading Value [dB (uV)]		Emission Level [dB (uV)]		Limit [dB (uV)]		Margin (dB)	
			Q.P.	AV.	Q.P.	AV.	Q.P.	AV.	Q.P.	AV.
			1	0.158	0.10	39.26	-	39.36	-	65.58
2	0.634	0.13	25.75	-	25.88	-	56.00	46.00	-30.12	-
3	0.873	0.16	23.91	-	24.07	-	56.00	46.00	-31.93	-
4	3.164	0.25	22.17	-	22.42	-	56.00	46.00	-33.58	-
5	12.559	0.45	35.54	-	35.99	-	60.00	50.00	-24.01	-
6	14.449	0.48	35.08	-	35.56	-	60.00	50.00	-24.44	-

- REMARKS:**
1. Q.P. and AV. are abbreviations of quasi-peak and average individually.
 2. "-": The Quasi-peak reading value also meets average limit and measurement with the average detector is unnecessary.
 3. The emission levels of other frequencies were very low against the limit.
 4. Margin value = Emission level - Limit value
 5. Correction factor = Insertion loss + Cable loss
 6. Emission Level = Correction Factor + Reading Value.

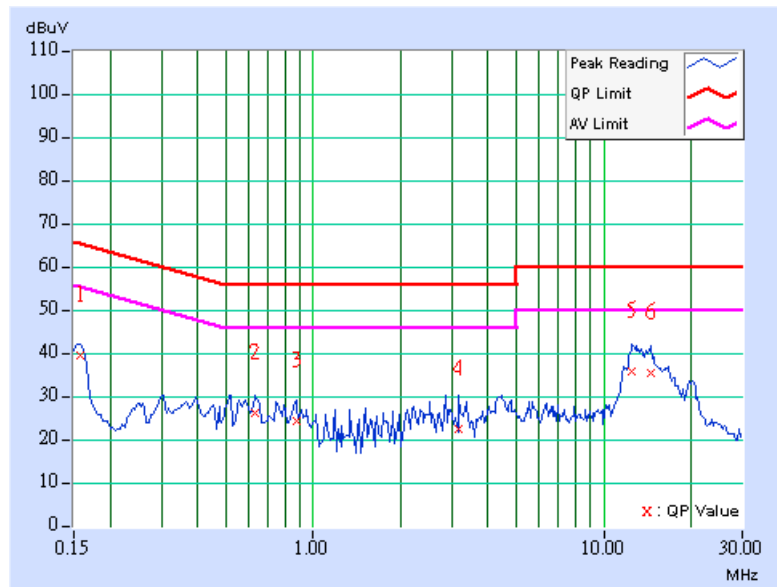



EUT	Notebook	MODEL	600
CHANNEL	Channel 6	6dB BANDWIDTH	9 kHz
MODULATION TYPE	BPSK	TRANSFER RATE	6Mbps
INPUT POWER (SYSTEM)	120Vac, 60 Hz	PHASE	Line (L)
ENVIRONMENTAL CONDITIONS	22deg. C, 70%RH, 991hPa	TESTED BY	Derry Tsui

No	Freq. [MHz]	Corr. Factor (dB)	Reading Value [dB (uV)]		Emission Level [dB (uV)]		Limit [dB (uV)]		Margin (dB)	
			Q.P.	AV.	Q.P.	AV.	Q.P.	AV.	Q.P.	AV.
			1	0.178	0.11	36.20	-	36.31	-	64.57
2	0.179	0.11	36.22	-	36.33	-	64.55	54.55	-28.22	-
3	0.994	0.18	30.73	-	30.91	-	56.00	46.00	-25.09	-
4	2.221	0.22	27.95	-	28.17	-	56.00	46.00	-27.83	-
5	13.389	0.56	35.40	-	35.96	-	60.00	50.00	-24.04	-
6	19.668	0.92	25.53	-	26.45	-	60.00	50.00	-33.55	-

- REMARKS:**
1. Q.P. and AV. are abbreviations of quasi-peak and average individually.
 2. "-": The Quasi-peak reading value also meets average limit and measurement with the average detector is unnecessary.
 3. The emission levels of other frequencies were very low against the limit.
 4. Margin value = Emission level - Limit value
 5. Correction factor = Insertion loss + Cable loss
 6. Emission Level = Correction Factor + Reading Value.

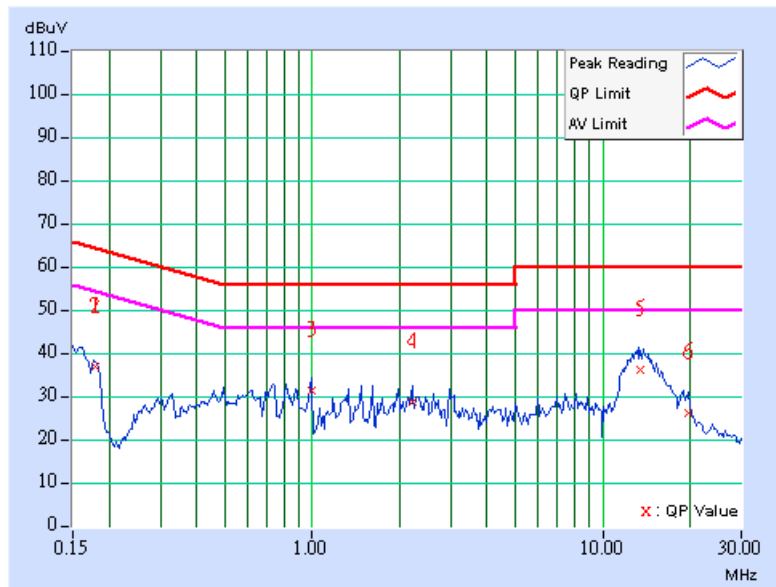



EUT	Notebook	MODEL	600
CHANNEL	Channel 6	6dB BANDWIDTH	9 kHz
MODULATION TYPE	BPSK	TRANSFER RATE	6Mbps
INPUT POWER (SYSTEM)	120Vac, 60 Hz	PHASE	Neutral (N)
ENVIRONMENTAL CONDITIONS	22deg. C, 70%RH, 991hPa	TESTED BY	Derry Tsui

No	Freq. [MHz]	Corr. Factor (dB)	Reading Value [dB (uV)]		Emission Level [dB (uV)]		Limit [dB (uV)]		Margin (dB)	
			Q.P.	AV.	Q.P.	AV.	Q.P.	AV.	Q.P.	AV.
			1	0.151	0.10	37.29	-	37.39	-	65.93
2	0.179	0.10	35.71	-	35.81	-	64.55	54.55	-28.74	-
3	0.716	0.14	26.30	-	26.44	-	56.00	46.00	-29.56	-
4	2.945	0.24	24.48	-	24.72	-	56.00	46.00	-31.28	-
5	13.020	0.45	36.21	-	36.66	-	60.00	50.00	-23.34	-
6	15.047	0.49	33.16	-	33.65	-	60.00	50.00	-26.35	-

- REMARKS:**
1. Q.P. and AV. are abbreviations of quasi-peak and average individually.
 2. "-": The Quasi-peak reading value also meets average limit and measurement with the average detector is unnecessary.
 3. The emission levels of other frequencies were very low against the limit.
 4. Margin value = Emission level - Limit value
 5. Correction factor = Insertion loss + Cable loss
 6. Emission Level = Correction Factor + Reading Value.

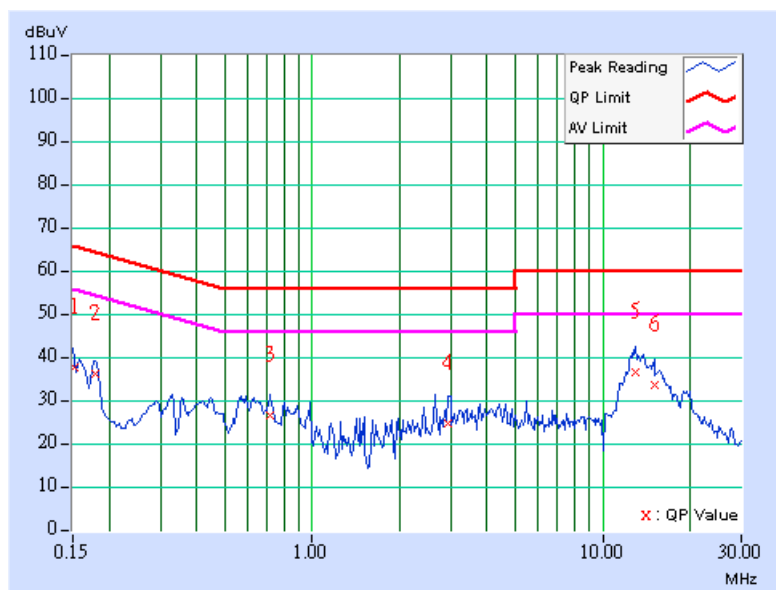



EUT	Notebook	MODEL	600
CHANNEL	Channel 11	6dB BANDWIDTH	9 kHz
MODULATION TYPE	BPSK	TRANSFER RATE	6Mbps
INPUT POWER (SYSTEM)	120Vac, 60 Hz	PHASE	Line (L)
ENVIRONMENTAL CONDITIONS	22deg. C, 70%RH, 991hPa	TESTED BY	Derry Tsui

No	Freq. [MHz]	Corr. Factor (dB)	Reading Value [dB (uV)]		Emission Level [dB (uV)]		Limit [dB (uV)]		Margin (dB)	
			Q.P.	AV.	Q.P.	AV.	Q.P.	AV.	Q.P.	AV.
			1	0.150	0.10	37.66	-	37.76	-	66.00
2	0.177	0.11	36.60	-	36.71	-	64.61	54.61	-27.90	-
3	0.977	0.18	30.35	-	30.53	-	56.00	46.00	-25.47	-
4	1.793	0.20	29.03	-	29.23	-	56.00	46.00	-26.77	-
5	13.184	0.55	35.94	-	36.49	-	60.00	50.00	-23.51	-
6	15.875	0.68	30.61	-	31.29	-	60.00	50.00	-28.71	-

- REMARKS:**
1. Q.P. and AV. are abbreviations of quasi-peak and average individually.
 2. "-": The Quasi-peak reading value also meets average limit and measurement with the average detector is unnecessary.
 3. The emission levels of other frequencies were very low against the limit.
 4. Margin value = Emission level - Limit value
 5. Correction factor = Insertion loss + Cable loss
 6. Emission Level = Correction Factor + Reading Value.

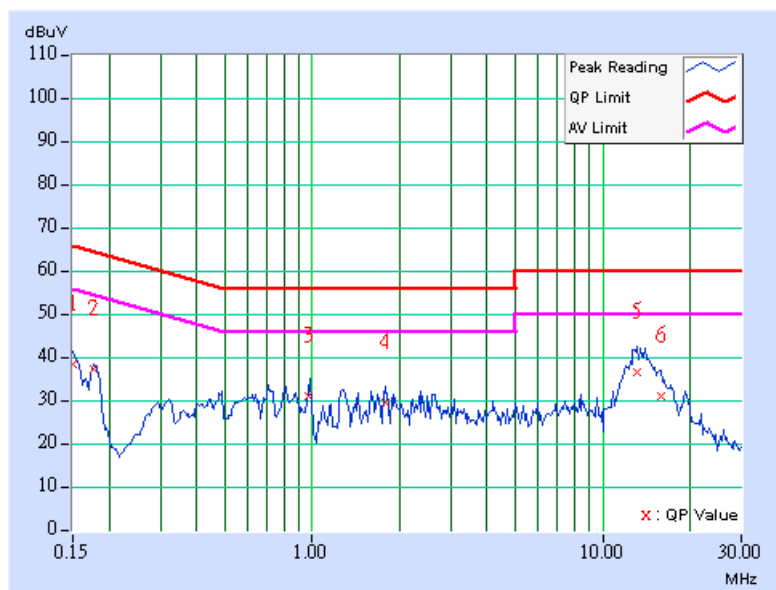



EUT	Notebook	MODEL	600
CHANNEL	Channel 11	6dB BANDWIDTH	9 kHz
MODULATION TYPE	BPSK	TRANSFER RATE	6Mbps
INPUT POWER (SYSTEM)	120Vac, 60 Hz	PHASE	Neutral (N)
ENVIRONMENTAL CONDITIONS	22deg. C, 70%RH, 991hPa	TESTED BY	Derry Tsui

No	Freq. [MHz]	Corr. Factor (dB)	Reading Value [dB (uV)]		Emission Level [dB (uV)]		Limit [dB (uV)]		Margin (dB)	
			Q.P.	AV.	Q.P.	AV.	Q.P.	AV.	Q.P.	AV.
			1	0.151	0.10	36.30	-	36.40	-	65.94
2	0.177	0.10	36.00	-	36.10	-	64.61	54.61	-28.51	-
3	0.586	0.12	26.86	-	26.98	-	56.00	46.00	-29.02	-
4	2.785	0.24	24.72	-	24.96	-	56.00	46.00	-31.04	-
5	13.504	0.46	36.21	-	36.67	-	60.00	50.00	-23.33	-
6	15.242	0.50	33.19	-	33.69	-	60.00	50.00	-26.31	-

- REMARKS:**
1. Q.P. and AV. are abbreviations of quasi-peak and average individually.
 2. "-": The Quasi-peak reading value also meets average limit and measurement with the average detector is unnecessary.
 3. The emission levels of other frequencies were very low against the limit.
 4. Margin value = Emission level - Limit value
 5. Correction factor = Insertion loss + Cable loss
 6. Emission Level = Correction Factor + Reading Value.

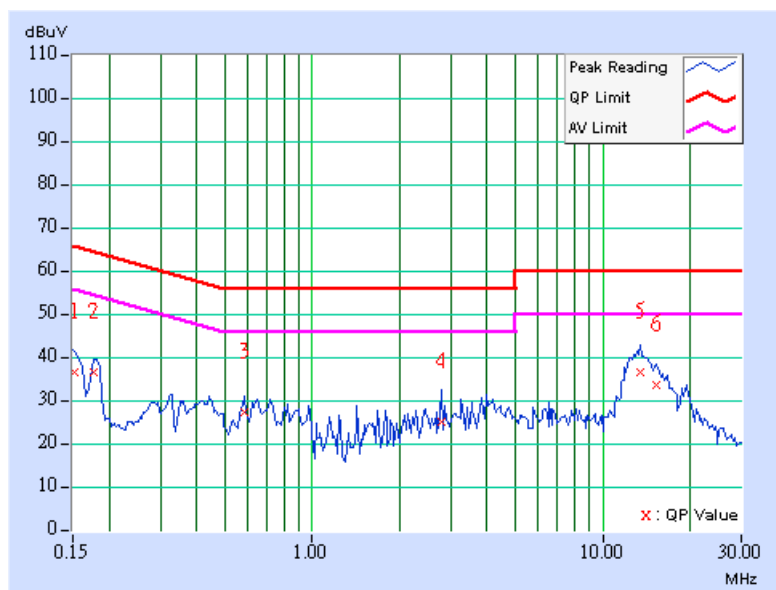



4.2 RADIATED EMISSION MEASUREMENT

4.2.1 LIMITS OF RADIATED EMISSION MEASUREMENT

Emissions radiated outside of the specified bands, shall be according to the general radiated limits in 15.209 as following:

Frequencies (MHz)	Field strength (microvolts/meter)	Measurement distance (meters)
0.009-0.490	2400/F(kHz)	300
0.490-1.705	24000/F(kHz)	30
1.705-30.0	30	30
30-88	100	3
88-216	150	3
216-960	200	3
Above 960	500	3

NOTE:

1. The lower limit shall apply at the transition frequencies.
2. Emission level (dBuV/m) = 20 log Emission level (uV/m).
3. As shown in 15.35(b), for frequencies above 1000MHz, the field strength limits are based on average detector, however, the peak field strength of any emission shall not exceed the maximum permitted average limits, specified above by more than 20dB under any condition of modulation.



4.2.2 TEST INSTRUMENTS

DESCRIPTION & MANUFACTURER	MODEL NO.	SERIAL NO.	CALIBRATED UNTIL
Test Receiver ROHDE & SCHWARZ	ESI7	838496/016	Jan. 07, 2006
Spectrum Analyzer ROHDE & SCHWARZ	FSP40	100041	Nov. 29, 2005
BILOG Antenna SCHWARZBECK	VULB9168	9168-155	Jan. 22, 2006
HORN Antenna SCHWARZBECK	BBHA 9120D	9120D-404	Jan. 05, 2006
HORN Antenna SCHWARZBECK	BBHA 9170	BBHA 9170242	Jan. 23, 2006
Preamplifier Agilent	8447D	2944A10631	Nov. 17, 2005
Preamplifier Agilent	8449B	3008A01960	Nov. 14, 2005
RF signal cable HUBER+SUHNNER	SUCOFLEX 104	219272/4	Jan. 26, 2006
RF signal cable HUBER+SUHNNER	SUCOFLEX 104	219275/4	Jan. 26, 2006
Software ADT.	ADT_Radiated_V5.14	NA	NA
Antenna Tower inn-co GmbH	MA 4000	010303	NA
Antenna Tower Controller inn-co GmbH	CO2000	019303	NA
Turn Table ADT.	TT100.	TT93021704	NA
Turn Table Controller ADT.	SC100.	SC93021704	NA

- NOTE:**
1. The calibration interval of the above test instruments is 12 months and the calibrations are traceable to NML/ROC and NIST/USA.
 2. The test was performed in HwaYa Chamber 3.
 3. The horn antenna and HP preamplifier (model: 8449B) are used only for the measurement of emission frequency above 1GHz if tested.
 4. The IC Site Registration No. is IC4924-4.



4.2.3 TEST PROCEDURES

- a. The EUT was placed on the top of a rotating table 0.8 meters above the ground at a 3 meter semi- anechoic. The table was rotated 360 degrees to determine the position of the highest radiation.
- b. The EUT was set 3 meters away from the interference-receiving antenna, which was mounted on the top of a variable-height antenna tower.
- c. The antenna is a broadband antenna, and its height is varied from one meter to four meters above the ground to determine the maximum value of the field strength. Both horizontal and vertical polarizations of the antenna are set to make the measurement.
- d. For each suspected emission, the EUT was arranged to its worst case and then the antenna was tuned to heights from 1 meter to 4 meters and the rotatable table was turned from 0 degrees to 360 degrees to find the maximum reading.
- e. The test-receiver system was set to Peak Detect Function and Specified Bandwidth with Maximum Hold Mode.
- f. If the emission level of the EUT in peak mode was 10 dB lower than the limit specified, then testing could be stopped and the peak values of the EUT would be reported. Otherwise the emissions that did not have 10 dB margin would be re-tested one by one using the quasi-peak method or average method as specified and then reported in Data sheet peak mode and QP mode.

NOTE:

1. The resolution bandwidth and video bandwidth of test receiver/spectrum analyzer is 120kHz for Quasi-peak detection at frequency below 1GHz.
2. The resolution bandwidth and video bandwidth of test receiver/spectrum analyzer is 1 MHz for Peak detection (PK) at frequency above 1GHz.
3. The resolution bandwidth of test receiver/spectrum analyzer is 1 MHz and the video bandwidth is 10 Hz for Average detection (AV) at frequency above 1GHz.

4.2.4 DEVIATION FROM TEST STANDARD

No deviation

4.2.5 TEST SETUP

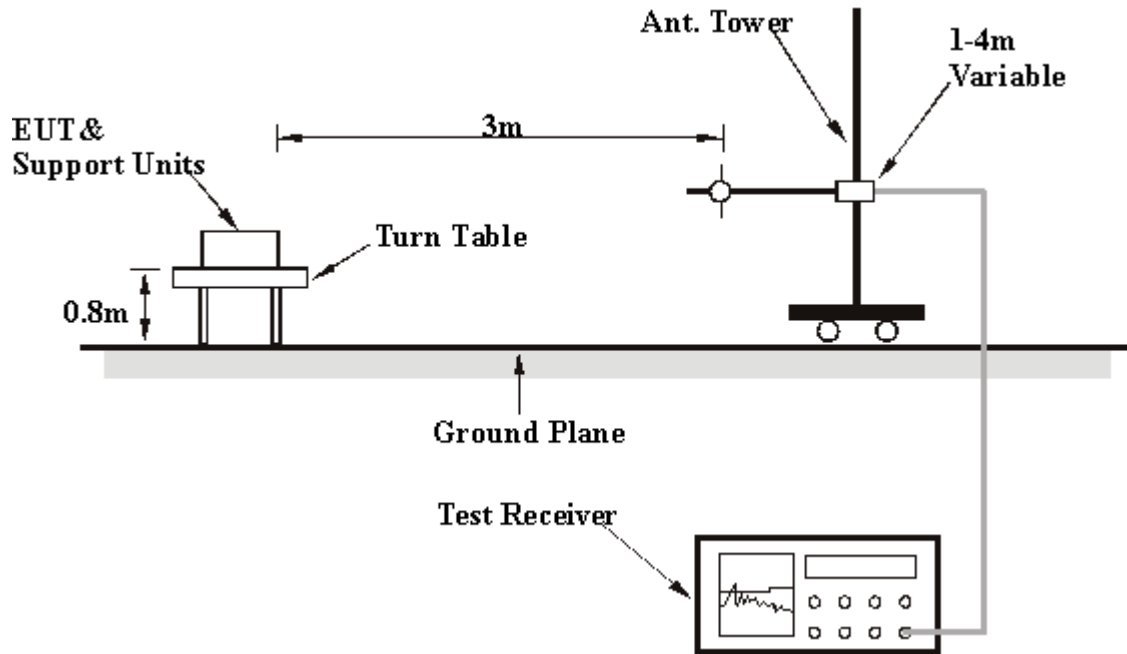

For the actual test configuration, please refer to the related item – Photographs of the Test Configuration.

4.2.6 EUT OPERATING CONDITIONS

Same as 4.1.6



4.2.7 TEST RESULTS

Below 1GHz Worst-Case Data

EUT	Notebook	MODEL	600
CHANNEL	Channel 11	FREQUENCY RANGE	Below 1000MHz
MODULATION TYPE	BPSK	TRANSFER RATE	6Mbps
INPUT POWER (SYSTEM)	120Vac, 60 Hz	DETECTOR FUNCTION	Quasi-Peak
ENVIRONMENTAL CONDITIONS	20deg. C, 61%RH, 991hPa	TESTED BY	Brad Wu

ANTENNA POLARITY & TEST DISTANCE: HORIZONTAL AT 3 M

No.	Freq. (MHz)	Emission Level (dBuV/m)	Limit (dBuV/m)	Margin (dB)	Antenna Height (m)	Table Angle (Degree)	Raw Value (dBuV)	Correction Factor (dB/m)
1	173.85	33.07 QP	43.50	-10.43	2.50 H	82	19.54	13.53
2	208.84	32.48 QP	43.50	-11.02	1.00 H	82	21.02	11.47
3	241.88	31.03 QP	46.00	-14.97	1.25 H	262	18.04	12.99
4	274.93	31.29 QP	46.00	-14.71	1.25 H	259	17.41	13.88
5	399.34	34.64 QP	46.00	-11.36	1.00 H	127	17.93	16.71
6	945.57	32.27 QP	46.00	-13.73	2.00 H	205	6.99	25.28

ANTENNA POLARITY & TEST DISTANCE: VERTICAL AT 3 M

No.	Freq. (MHz)	Emission Level (dBuV/m)	Limit (dBuV/m)	Margin (dB)	Antenna Height (m)	Table Angle (Degree)	Raw Value (dBuV)	Correction Factor (dB/m)
1	70.82	31.02 QP	40.00	-8.98	1.00 V	55	18.76	12.27
2	111.64	30.17 QP	43.50	-13.33	1.00 V	82	18.13	12.05
3	142.75	30.95 QP	43.50	-12.55	1.00 V	148	16.44	14.51
4	399.34	38.16 QP	46.00	-7.84	1.50 V	181	21.44	16.71
5	599.56	33.11 QP	46.00	-12.89	1.00 V	247	12.29	20.82
6	945.57	35.36 QP	46.00	-10.64	1.00 V	253	10.08	25.28

- REMARKS:**
1. Emission level(dBuV/m)=Raw Value(dBuV) + Correction Factor(dB/m)
 2. Correction Factor(dB/m) = Antenna Factor (dB/m) + Cable Factor (dB)
 3. The other emission levels were very low against the limit.
 4. Margin value = Emission level – Limit value

**802.11b DSSS modulation**

EUT	Notebook	MODEL	600
CHANNEL	Channel 1	FREQUENCY RANGE	1 ~ 25GHz
MODULATION TYPE	CCK	TRANSFER RATE	11Mbps
INPUT POWER (SYSTEM)	120Vac, 60 Hz	DETECTOR FUNCTION	Peak(PK) Average (AV)
ENVIRONMENTAL CONDITIONS	20deg. C, 61%RH, 991hPa	TESTED BY	Brad Wu

ANTENNA POLARITY & TEST DISTANCE: HORIZONTAL AT 3 M

No.	Freq. (MHz)	Emission Level (dBuV/m)	Limit (dBuV/m)	Margin (dB)	Antenna Height (m)	Table Angle (Degree)	Raw Value (dBuV)	Correction Factor (dB/m)
1	1500.00	43.68 PK	74.00	-30.32	1.06 H	145	14.56	29.12
2	2312.00	45.27 PK	74.00	-28.73	1.12 H	213	13.69	31.58
3	2390.00	55.10 PK	74.00	-18.90	1.09 H	319	23.23	31.87
3	2390.00	45.63 AV	54.00	-8.37	1.09 H	319	13.76	31.87
4	*2412.00	108.54 PK			1.09 H	319	76.58	31.96
4	*2412.00	101.32 AV			1.09 H	319	69.36	31.96
5	4824.00	48.62 PK	74.00	-25.38	1.05 H	147	10.79	37.83

ANTENNA POLARITY & TEST DISTANCE: VERTICAL AT 3 M

No.	Freq. (MHz)	Emission Level (dBuV/m)	Limit (dBuV/m)	Margin (dB)	Antenna Height (m)	Table Angle (Degree)	Raw Value (dBuV)	Correction Factor (dB/m)
1	1500.00	44.16 PK	74.00	-29.84	1.21 V	136	15.04	29.12
2	2312.00	46.56 PK	74.00	-27.44	1.23 V	327	14.98	31.58
2	2312.00	40.92 AV	54.00	-13.08	1.23 V	327	9.34	31.58
3	2390.00	55.98 PK	74.00	-18.02	1.32 V	255	24.11	31.87
3	2390.00	45.59 AV	54.00	-8.41	1.32 V	255	13.72	31.87
4	*2412.00	107.47 PK			1.32 V	255	75.51	31.96
4	*2412.00	99.92 AV			1.32 V	255	67.96	31.96
5	4824.00	49.87 PK	74.00	-24.13	1.25 V	192	12.04	37.83

- REMARKS:**
1. Emission level(dBuV/m)=Raw Value(dBuV) + Correction Factor(dB/m)
 2. Correction Factor(dB/m) = Antenna Factor (dB/m) + Cable Factor (dB)
 3. The other emission levels were very low against the limit.
 4. Margin value = Emission level – Limit value.
 5. The limit value is defined as per 15.247
 6. “ * “ : Fundamental frequency



EUT	Notebook	MODEL	600
CHANNEL	Channel 6	FREQUENCY RANGE	1 ~ 25GHz
MODULATION TYPE	CCK	TRANSFER RATE	11Mbps
INPUT POWER (SYSTEM)	120Vac, 60 Hz	DETECTOR FUNCTION	Peak(PK) Average (AV)
ENVIRONMENTAL CONDITIONS	20deg. C, 61%RH, 991hPa	TESTED BY	Brad Wu

ANTENNA POLARITY & TEST DISTANCE: HORIZONTAL AT 3 M

No.	Freq. (MHz)	Emission Level (dBuV/m)	Limit (dBuV/m)	Margin (dB)	Antenna Height (m)	Table Angle (Degree)	Raw Value (dBuV)	Correction Factor (dB/m)
1	1500.00	44.10 PK	74.00	-29.90	1.03 H	165	14.98	29.12
2	2336.00	49.80 PK	74.00	-24.20	1.21 H	208	18.13	31.67
2	2336.00	44.09 AV	54.00	-9.91	1.21 H	208	12.42	31.67
3	*2437.00	108.21 PK			1.28 H	320	76.15	32.06
3	*2437.00	100.70 AV			1.28 H	320	68.64	32.06
4	4874.00	49.19 PK	74.00	-24.81	1.21 H	205	11.21	37.98

ANTENNA POLARITY & TEST DISTANCE: VERTICAL AT 3 M

No.	Freq. (MHz)	Emission Level (dBuV/m)	Limit (dBuV/m)	Margin (dB)	Antenna Height (m)	Table Angle (Degree)	Raw Value (dBuV)	Correction Factor (dB/m)
1	1500.00	45.22 PK	74.00	-28.78	1.14 V	136	16.10	29.12
2	2336.00	49.16 PK	74.00	-24.84	1.05 V	124	17.49	31.67
3	*2437.00	106.53 PK			1.34 V	250	74.47	32.06
3	*2437.00	99.15 AV			1.34 V	250	67.09	32.06
4	4874.00	49.38 PK	74.00	-24.62	1.06 V	60	11.40	37.98

- REMARKS:**
1. Emission level(dBuV/m)=Raw Value(dBuV) + Correction Factor(dB/m)
 2. Correction Factor(dB/m) = Antenna Factor (dB/m) + Cable Factor (dB)
 3. The other emission levels were very low against the limit.
 4. Margin value = Emission level – Limit value.
 5. The limit value is defined as per 15.247
 6. “ * “ : Fundamental frequency



EUT	Notebook	MODEL	600
CHANNEL	Channel 11	FREQUENCY RANGE	1 ~ 25GHz
MODULATION TYPE	CCK	TRANSFER RATE	11Mbps
INPUT POWER (SYSTEM)	120Vac, 60 Hz	DETECTOR FUNCTION	Peak(PK) Average (AV)
ENVIRONMENTAL CONDITIONS	20deg. C, 61%RH, 991hPa	TESTED BY	Brad Wu

ANTENNA POLARITY & TEST DISTANCE: HORIZONTAL AT 3 M								
No.	Freq. (MHz)	Emission Level (dBuV/m)	Limit (dBuV/m)	Margin (dB)	Antenna Height (m)	Table Angle (Degree)	Raw Value (dBuV)	Correction Factor (dB/m)
1	1500.00	44.30 PK	74.00	-29.70	1.02 H	168	15.18	29.12
2	2360.00	46.31 PK	74.00	-27.69	1.06 H	135	14.55	31.76
3	*2462.00	108.21 PK			1.09 H	317	76.05	32.16
3	*2462.00	100.86 AV			1.09 H	317	68.70	32.16
4	2483.50	55.08 PK	74.00	-18.92	1.09 H	317	22.84	32.24
4	2483.50	45.56 AV	54.00	-8.44	1.09 H	317	13.32	32.24
5	4924.00	48.11 PK	74.00	-25.89	1.12 H	306	9.97	38.14

ANTENNA POLARITY & TEST DISTANCE: VERTICAL AT 3 M								
No.	Freq. (MHz)	Emission Level (dBuV/m)	Limit (dBuV/m)	Margin (dB)	Antenna Height (m)	Table Angle (Degree)	Raw Value (dBuV)	Correction Factor (dB/m)
1	1500.00	45.13 PK	74.00	-28.87	1.12 V	200	16.01	29.12
2	2360.00	47.77 PK	74.00	-26.23	1.20 V	287	16.01	31.76
2	2360.00	42.16 AV	54.00	-11.84	1.20 V	287	10.40	31.76
3	*2462.00	106.62 PK			1.27 V	245	74.46	32.16
3	*2462.00	98.77 AV			1.27 V	245	66.61	32.16
4	2483.50	54.35 PK	74.00	-19.65	1.12 V	200	22.11	32.24
4	2483.50	45.58 AV	54.00	-8.42	1.12 V	200	13.34	32.24
5	4924.00	49.86 PK	74.00	-24.14	1.13 V	213	11.72	38.14

- REMARKS:**
1. Emission level(dBuV/m)=Raw Value(dBuV) + Correction Factor(dB/m)
 2. Correction Factor(dB/m) = Antenna Factor (dB/m) + Cable Factor (dB)
 3. The other emission levels were very low against the limit.
 4. Margin value = Emission level – Limit value.
 5. The limit value is defined as per 15.247
 6. “ * “ : Fundamental frequency



802.11g OFDM modulation

EUT	Notebook	MODEL	600
CHANNEL	Channel 1	FREQUENCY RANGE	1 ~ 25GHz
MODULATION TYPE	BPSK	TRANSFER RATE	6Mbps
INPUT POWER (SYSTEM)	120Vac, 60 Hz	DETECTOR FUNCTION	Peak(PK) Average (AV)
ENVIRONMENTAL CONDITIONS	20deg. C, 61%RH, 991hPa	TESTED BY	Brad Wu

ANTENNA POLARITY & TEST DISTANCE: HORIZONTAL AT 3 M

No.	Freq. (MHz)	Emission Level (dBuV/m)	Limit (dBuV/m)	Margin (dB)	Antenna Height (m)	Table Angle (Degree)	Raw Value (dBuV)	Correction Factor (dB/m)
1	1500.00	43.93 PK	74.00	-30.07	1.18 H	206	14.81	29.12
1	1500.00	35.21 AV	54.00	-18.79	1.18 H	206	6.09	29.12
2	2312.00	44.75 PK	74.00	-29.25	1.16 H	262	13.17	31.58
2	2312.00	39.17 AV	54.00	-14.83	1.16 H	262	7.59	31.58
3	2390.00	56.65 PK	74.00	-17.35	1.11 H	265	24.78	31.87
3	2390.00	46.02 AV	54.00	-7.98	1.11 H	265	14.15	31.87
4	*2412.00	105.54 PK			1.11 H	265	73.58	31.96
4	*2412.00	95.95 AV			1.11 H	265	63.99	31.96
5	4824.00	48.69 PK	74.00	-25.31	1.12 H	165	10.86	37.83

ANTENNA POLARITY & TEST DISTANCE: VERTICAL AT 3 M

No.	Freq. (MHz)	Emission Level (dBuV/m)	Limit (dBuV/m)	Margin (dB)	Antenna Height (m)	Table Angle (Degree)	Raw Value (dBuV)	Correction Factor (dB/m)
1	1500.00	43.00 PK	74.00	-31.00	1.06 V	23	13.88	29.12
2	2312.00	44.49 PK	74.00	-29.51	1.30 V	211	12.91	31.58
2	2312.00	39.14 AV	54.00	-14.86	1.30 V	211	7.56	31.58
3	2390.00	56.47 PK	74.00	-17.53	1.32 V	321	24.60	31.87
3	2390.00	45.56 AV	54.00	-8.44	1.32 V	321	13.69	31.87
4	*2412.00	104.05 PK			1.32 V	321	72.09	31.96
4	*2412.00	93.85 AV			1.32 V	321	61.89	31.96
5	4824.00	48.35 PK	74.00	-25.65	1.10 V	212	10.52	37.83

- REMARKS:**
1. Emission level(dBuV/m)=Raw Value(dBuV) + Correction Factor(dB/m)
 2. Correction Factor(dB/m) = Antenna Factor (dB/m) + Cable Factor (dB)
 3. The other emission levels were very low against the limit.
 4. Margin value = Emission level – Limit value.
 5. The limit value is defined as per 15.247
 6. “ * “ : Fundamental frequency



EUT	Notebook	MODEL	600
CHANNEL	Channel 6	FREQUENCY RANGE	1 ~ 25GHz
MODULATION TYPE	BPSK	TRANSFER RATE	6Mbps
INPUT POWER (SYSTEM)	120Vac, 60 Hz	DETECTOR FUNCTION	Peak(PK) Average (AV)
ENVIRONMENTAL CONDITIONS	20deg. C, 61%RH, 991hPa	TESTED BY	Brad Wu

ANTENNA POLARITY & TEST DISTANCE: HORIZONTAL AT 3 M

No.	Freq. (MHz)	Emission Level (dBuV/m)	Limit (dBuV/m)	Margin (dB)	Antenna Height (m)	Table Angle (Degree)	Raw Value (dBuV)	Correction Factor (dB/m)
1	1500.00	44.23 PK	74.00	-29.77	1.05 H	211	15.11	29.12
2	2336.00	49.06 PK	74.00	-24.94	1.07 H	352	17.39	31.67
2	2336.00	43.48 AV	54.00	-10.52	1.07 H	352	11.81	31.67
3	*2437.00	104.68 PK			1.29 H	320	72.62	32.06
3	*2437.00	94.33 AV			1.29 H	320	62.27	32.06
4	4874.00	48.79 PK	74.00	-25.21	1.06 H	306	10.81	37.98

ANTENNA POLARITY & TEST DISTANCE: VERTICAL AT 3 M

No.	Freq. (MHz)	Emission Level (dBuV/m)	Limit (dBuV/m)	Margin (dB)	Antenna Height (m)	Table Angle (Degree)	Raw Value (dBuV)	Correction Factor (dB/m)
1	1500.00	43.26 PK	74.00	-30.74	1.02 V	323	14.14	29.12
2	2336.00	48.12 PK	74.00	-25.88	1.15 V	203	16.45	31.67
3	*2437.00	103.16 PK			1.08 V	338	71.10	32.06
3	*2437.00	92.86 AV			1.08 V	338	60.80	32.06
4	4874.00	47.20 PK	74.00	-26.80	1.12 V	93	9.22	37.98

- REMARKS:**
1. Emission level(dBuV/m)=Raw Value(dBuV) + Correction Factor(dB/m)
 2. Correction Factor(dB/m) = Antenna Factor (dB/m) + Cable Factor (dB)
 3. The other emission levels were very low against the limit.
 4. Margin value = Emission level – Limit value.
 5. The limit value is defined as per 15.247
 6. “ * “ : Fundamental frequency



EUT	Notebook	MODEL	600
CHANNEL	Channel 11	FREQUENCY RANGE	1 ~ 25GHz
MODULATION TYPE	BPSK	TRANSFER RATE	6Mbps
INPUT POWER (SYSTEM)	120Vac, 60 Hz	DETECTOR FUNCTION	Peak(PK) Average (AV)
ENVIRONMENTAL CONDITIONS	20deg. C, 61%RH, 991hPa	TESTED BY	Brad Wu

ANTENNA POLARITY & TEST DISTANCE: HORIZONTAL AT 3 M

No.	Freq. (MHz)	Emission Level (dBuV/m)	Limit (dBuV/m)	Margin (dB)	Antenna Height (m)	Table Angle (Degree)	Raw Value (dBuV)	Correction Factor (dB/m)
1	1500.00	45.23 PK	74.00	-28.77	1.15 H	210	16.11	29.12
2	2360.00	46.35 PK	74.00	-27.65	1.00 H	240	14.59	31.76
2	2360.00	40.51 AV	54.00	-13.49	1.00 H	240	8.75	31.76
3	*2462.00	104.16 PK			1.66 H	269	72.00	32.16
3	*2462.00	94.10 AV			1.66 H	269	61.94	32.16
4	2483.50	55.22 PK	74.00	-18.78	1.66 H	269	22.98	32.24
4	2483.50	45.55 AV	54.00	-8.45	1.66 H	269	13.31	32.24
5	4924.00	49.36 PK	74.00	-24.64	1.09 H	90	11.22	38.14

ANTENNA POLARITY & TEST DISTANCE: VERTICAL AT 3 M

No.	Freq. (MHz)	Emission Level (dBuV/m)	Limit (dBuV/m)	Margin (dB)	Antenna Height (m)	Table Angle (Degree)	Raw Value (dBuV)	Correction Factor (dB/m)
1	1500.00	44.16 PK	74.00	-29.84	1.03 V	256	15.04	29.12
2	2360.00	45.23 PK	74.00	-28.77	1.13 V	94	13.47	31.76
2	2360.00	39.88 AV	54.00	-14.12	1.13 V	94	8.12	31.76
3	*2462.00	103.86 PK			1.08 V	319	71.70	32.16
3	*2462.00	93.79 AV			1.08 V	319	61.63	32.16
4	2483.50	55.62 PK	74.00	-18.38	1.08 V	319	23.38	32.24
4	2483.50	45.67 AV	54.00	-8.33	1.08 V	319	13.43	32.24
5	4924.00	48.16 PK	74.00	-25.84	1.25 V	221	10.02	38.14

- REMARKS:**
1. Emission level(dBuV/m)=Raw Value(dBuV) + Correction Factor(dB/m)
 2. Correction Factor(dB/m) = Antenna Factor (dB/m) + Cable Factor (dB)
 3. The other emission levels were very low against the limit.
 4. Margin value = Emission level – Limit value.
 5. The limit value is defined as per 15.247
 6. “ * “ : Fundamental frequency



4.3 6dB BANDWIDTH MEASUREMENT

4.3.1 LIMITS OF 6dB BANDWIDTH MEASUREMENT

The minimum of 6dB Bandwidth Measurement is 0.5 MHz.

4.3.2 TEST INSTRUMENTS

Description & Manufacturer	Model No.	Serial No.	Calibrated Until
SPECTRUM ANALYZER	FSEK 30	100049	Aug. 12, 2005

NOTE: The calibration interval of the above test instruments is 12 months and the calibrations are traceable to NML/ROC and NIST/USA.

4.3.3 TEST PROCEDURE

The transmitter output was connected to the spectrum analyzer through an attenuator. The bandwidth of the fundamental frequency was measured by spectrum analyzer with 100kHz RBW and 100kHz VBW. The 6dB bandwidth is defined as the total spectrum the power of which is higher than peak power minus 6dB.

4.3.4 DEVIATION FROM TEST STANDARD

No deviation

4.3.5 TEST SETUP

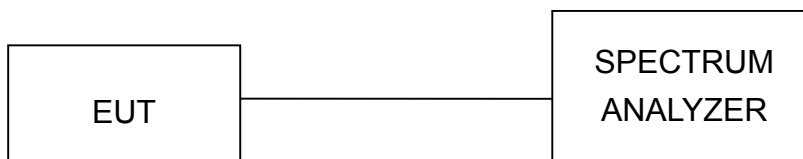

4.3.6 EUT OPERATING CONDITIONS

The software provided by client to enable the EUT under transmission condition continuously at lowest, middle and highest channel frequencies individually.



4.3.7 TEST RESULTS

802.11b DSSS modulation

EUT	Notebook	MODEL	600
MODULATION TYPE	CCK	TRANSFER RATE	11Mbps
INPUT POWER (SYSTEM)	120Vac, 60 Hz	ENVIRONMENTAL CONDITIONS	23deg. C, 61%RH, 991hPa
TESTED BY	Gary Chang		

CHANNEL	CHANNEL FREQUENCY (MHz)	6dB BANDWIDTH (MHz)	MINIMUM LIMIT (MHz)	PASS/FAIL
1	2412	9.56	0.5	PASS
6	2437	9.56	0.5	PASS
11	2462	9.60	0.5	PASS



CH1

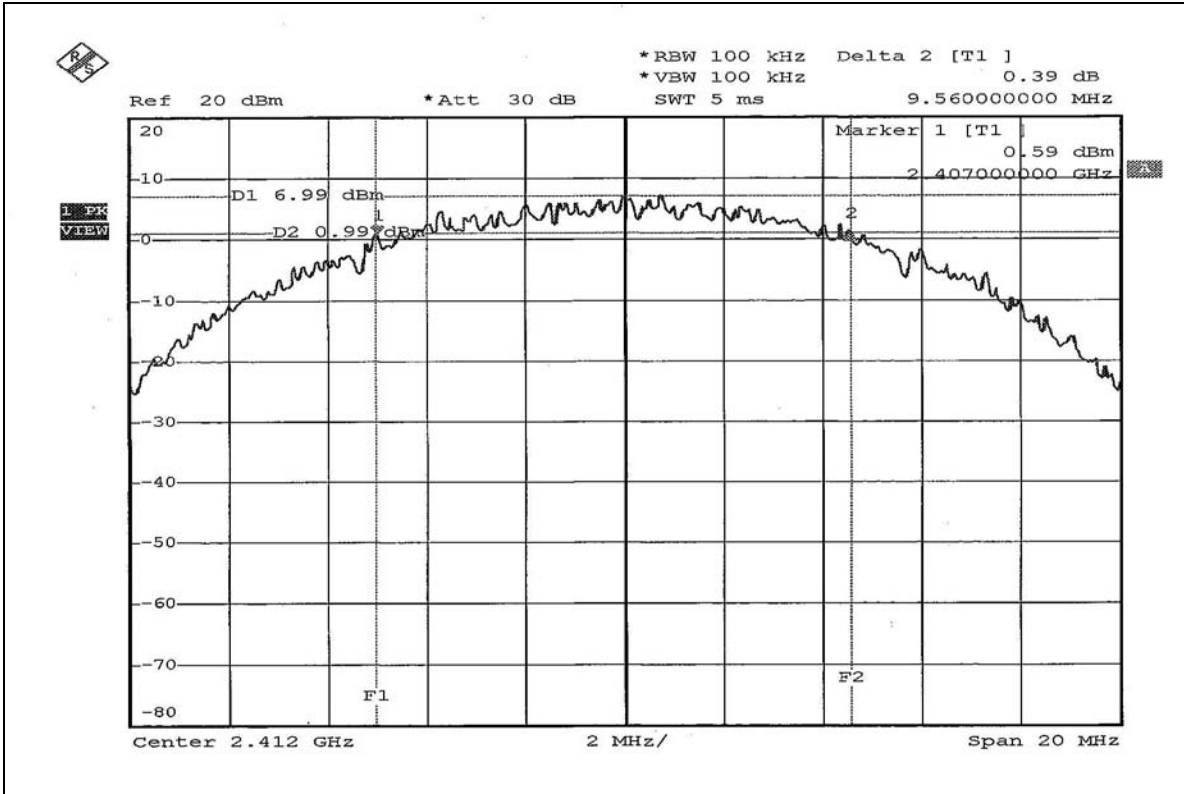

CH6

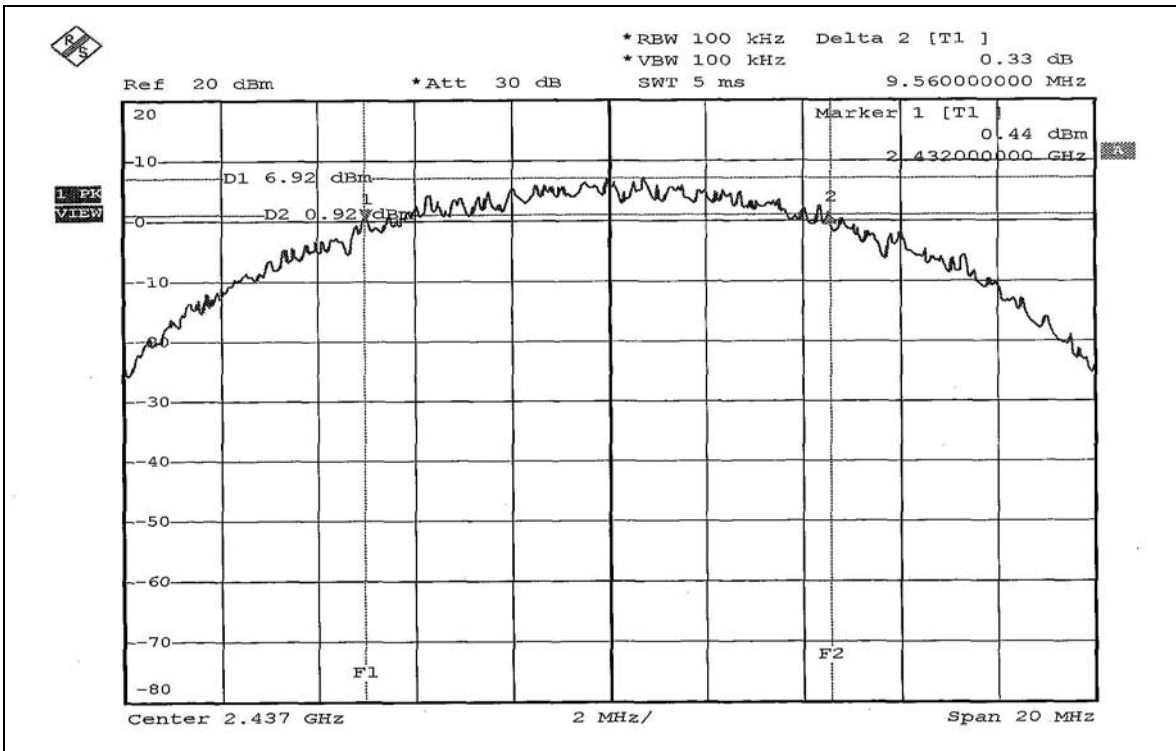



CH11

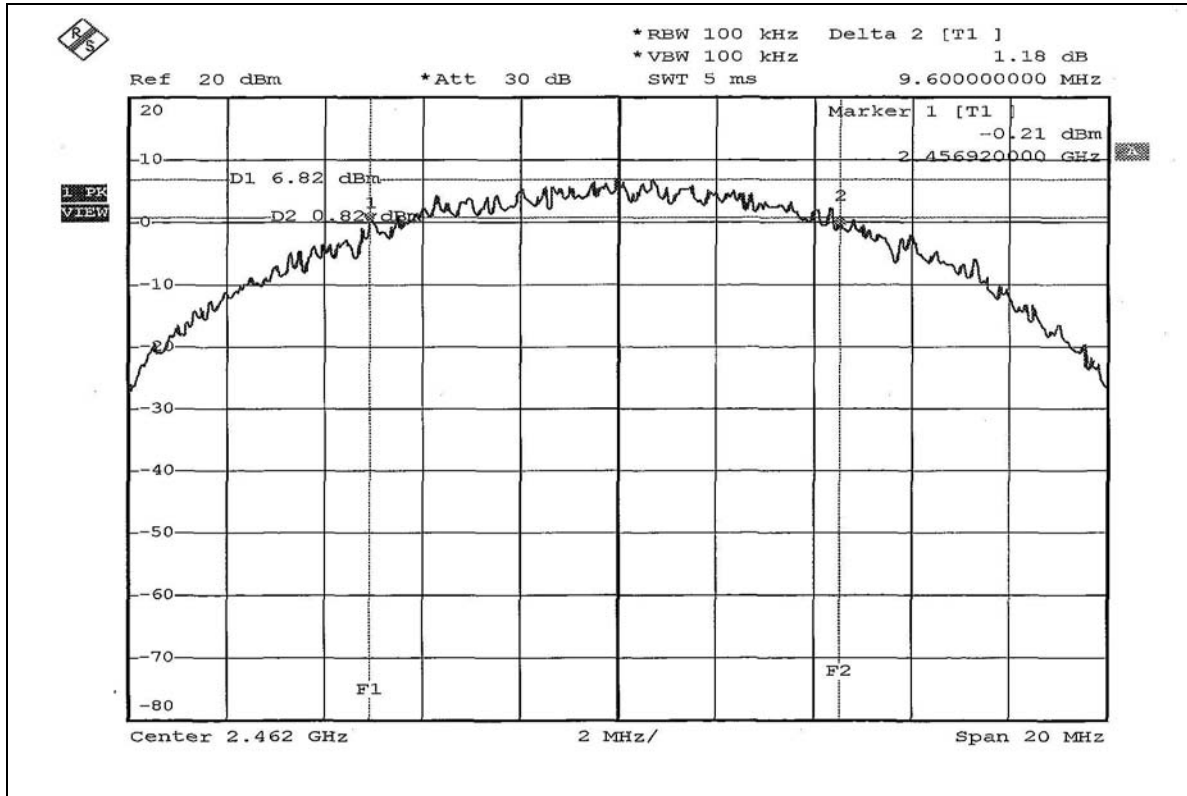



802.11g OFDM modulation

EUT	Notebook	MODEL	600
MODULATION TYPE	BPSK	TRANSFER RATE	6Mbps
INPUT POWER (SYSTEM)	120Vac, 60 Hz	ENVIRONMENTAL CONDITIONS	23deg. C, 61%RH, 991hPa
TESTED BY	Gary Chang		

CHANNEL	CHANNEL FREQUENCY (MHz)	6dB BANDWIDTH (MHz)	MINIMUM LIMIT (MHz)	PASS/FAIL
1	2412	16.36	0.5	PASS
6	2437	16.32	0.5	PASS
11	2462	15.08	0.5	PASS



CH1

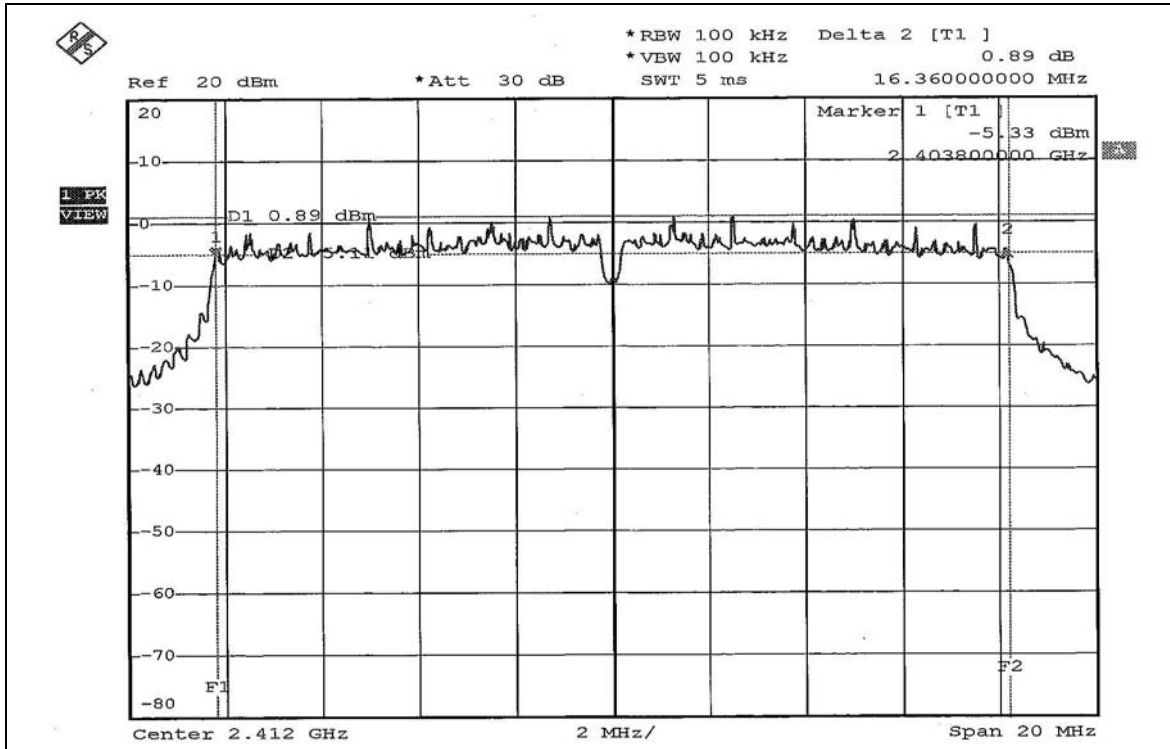

CH6

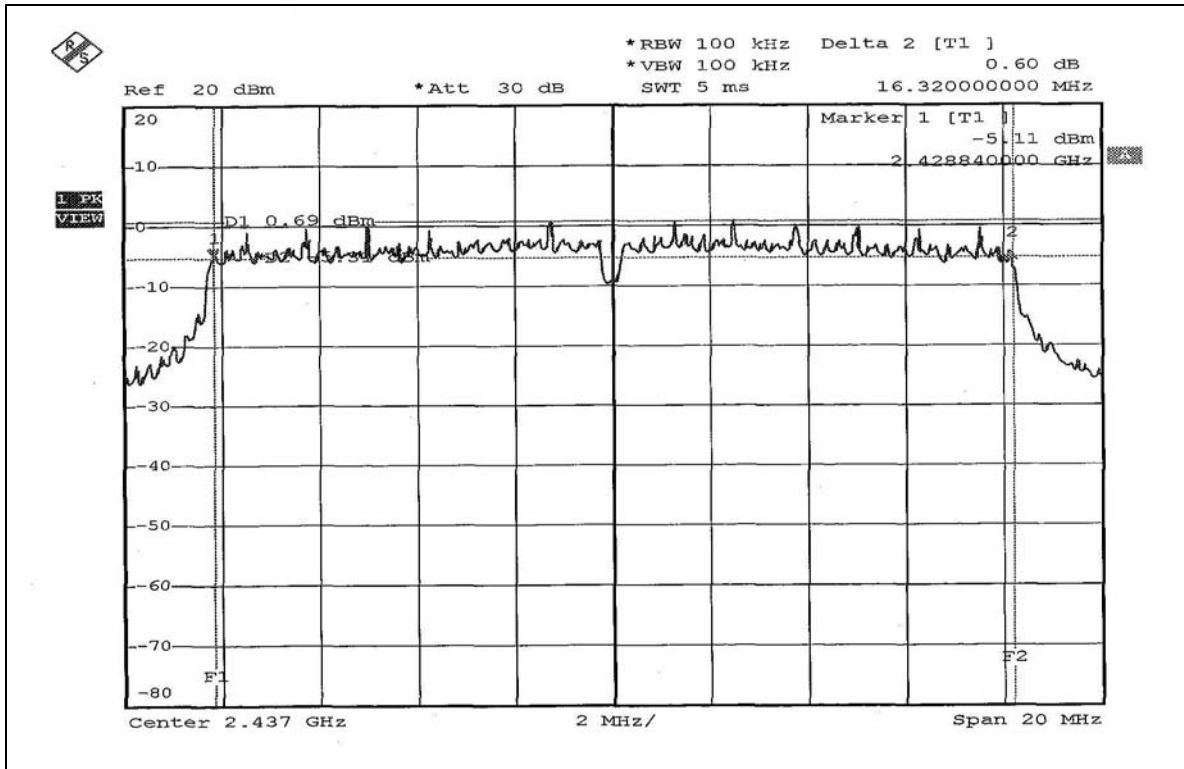



CH11

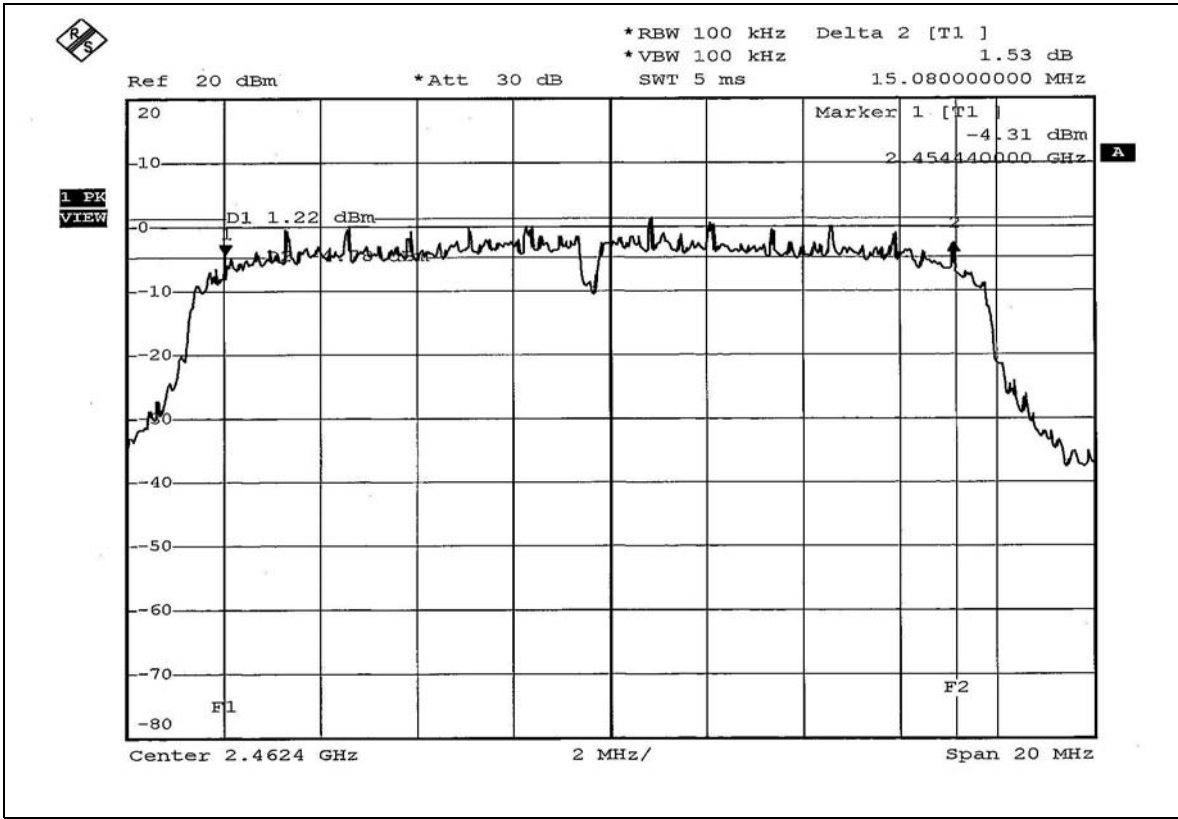



4.4 MAXIMUM PEAK OUTPUT POWER

4.4.1 LIMITS OF MAXIMUM PEAK OUTPUT POWER MEASUREMENT

The Maximum Peak Output Power Measurement is 30dBm.

4.4.2 INSTRUMENTS

Description & Manufacturer	Model No.	Serial No.	Calibrated Until
R&S SPECTRUM ANALYZER	FSEK30	100049	Aug. 12, 2005
AGILENT SIGNAL GENERATOR	E8257C	MY43320668	Dec. 06, 2005
TEKTRONIX OSCILLOSCOPE	TDS1012	C037299	Dec. 07, 2005
NARDA DETECTOR	4503A	FSCM99899	NA

NOTE:

The calibration interval of the above test instruments is 12 months and the calibrations are traceable to NML/ROC and NIST/USA.

4.4.3 TEST PROCEDURES

1. A detector was used on the output port of the EUT. An oscilloscope was used to read the response of the detector.
2. Replaced the EUT by the signal generator. The center frequency of the S.G was adjusted to the center frequency of the measured channel.
3. Adjusted the power to have the same reading on oscilloscope. Record the power level.

4.4.4 DEVIATION FROM TEST STANDARD

No deviation

4.4.5 TEST SETUP



4.4.6 EUT OPERATING CONDITIONS

Same as Item 4.3.6



4.4.7 TEST RESULTS

802.11b DSSS modulation

EUT	Notebook	MODEL	600
MODULATION TYPE	CCK	TRANSFER RATE	11Mbps
INPUT POWER (SYSTEM)	120Vac, 60Hz	ENVIRONMENTAL CONDITIONS	23deg. C, 61%RH, 991hPa
TESTED BY	Gary Chang		

CHANNEL	CHANNEL FREQUENCY (MHz)	PEAK POWER OUTPUT (mW)	PEAK POWER OUTPUT (dBm)	PEAK POWER LIMIT (dBm)	PASS/FAIL
1	2412	61.944	17.92	30	PASS
6	2437	63.826	18.05	30	PASS
11	2462	62.373	17.95	30	PASS



802.11g OFDM modulation

EUT	Notebook	MODEL	600
MODULATION TYPE	BPSK	TRANSFER RATE	6Mbps
INPUT POWER (SYSTEM)	120Vac, 60Hz	ENVIRONMENTAL CONDITIONS	23deg. C, 61%RH, 991hPa
TESTED BY	Gary Chang		

CHANNEL	CHANNEL FREQUENCY (MHz)	PEAK POWER OUTPUT (mW)	PEAK POWER OUTPUT (dBm)	PEAK POWER LIMIT (dBm)	PASS/FAIL
1	2412	50.350	17.02	30	PASS
6	2437	49.659	16.96	30	PASS
11	2462	49.317	16.93	30	PASS



4.5 POWER SPECTRAL DENSITY MEASUREMENT

4.5.1 LIMITS OF POWER SPECTRAL DENSITY MEASUREMENT

The Maximum of Power Spectral Density Measurement is 8dBm.

4.5.2 TEST INSTRUMENTS

Description & Manufacturer	Model No.	Serial No.	Calibrated Until
R&S SPECTRUM ANALYZER	FSEK30	100049	Aug. 12, 2005

NOTE:

The calibration interval of the above test instruments is 12 months and the calibrations are traceable to NML/ROC and NIST/USA.

4.5.3 TEST PROCEDURE

The transmitter output was connected to the spectrum analyzer through an attenuator, the bandwidth of the fundamental frequency was measured with the spectrum analyzer using 3kHz RBW and 30kHz VBW, set sweep time = span/3kHz. The power spectral density was measured and recorded. The sweep time is allowed to be longer than span/3kHz for a full response of the mixer in the spectrum analyzer.

4.5.4 DEVIATION FROM TEST STANDARD

No deviation

4.5.5 TEST SETUP

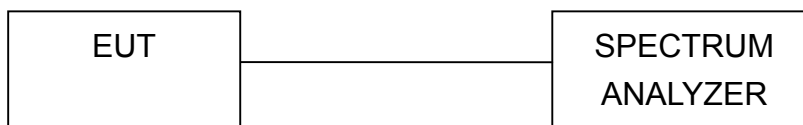

4.5.6 EUT OPERATING CONDITION

Same as Item 4.3.6



4.5.7 TEST RESULTS

802.11b DSSS modulation

EUT	Notebook	MODEL	600
MODULATION TYPE	CCK	TRANSFER RATE	11Mbps
INPUT POWER (SYSTEM)	120Vac, 60Hz	ENVIRONMENTAL CONDITIONS	23deg. C, 61%RH, 991hPa
TESTED BY	Gary Chang		

CHANNEL	CHANNEL FREQUENCY (MHz)	RF POWER LEVEL IN 3kHz BW (dBm)	MAXIMUM LIMIT (dBm)	PASS/FAIL
1	2412	-5.33	8	PASS
6	2437	-5.41	8	PASS
11	2462	-5.47	8	PASS



CH1

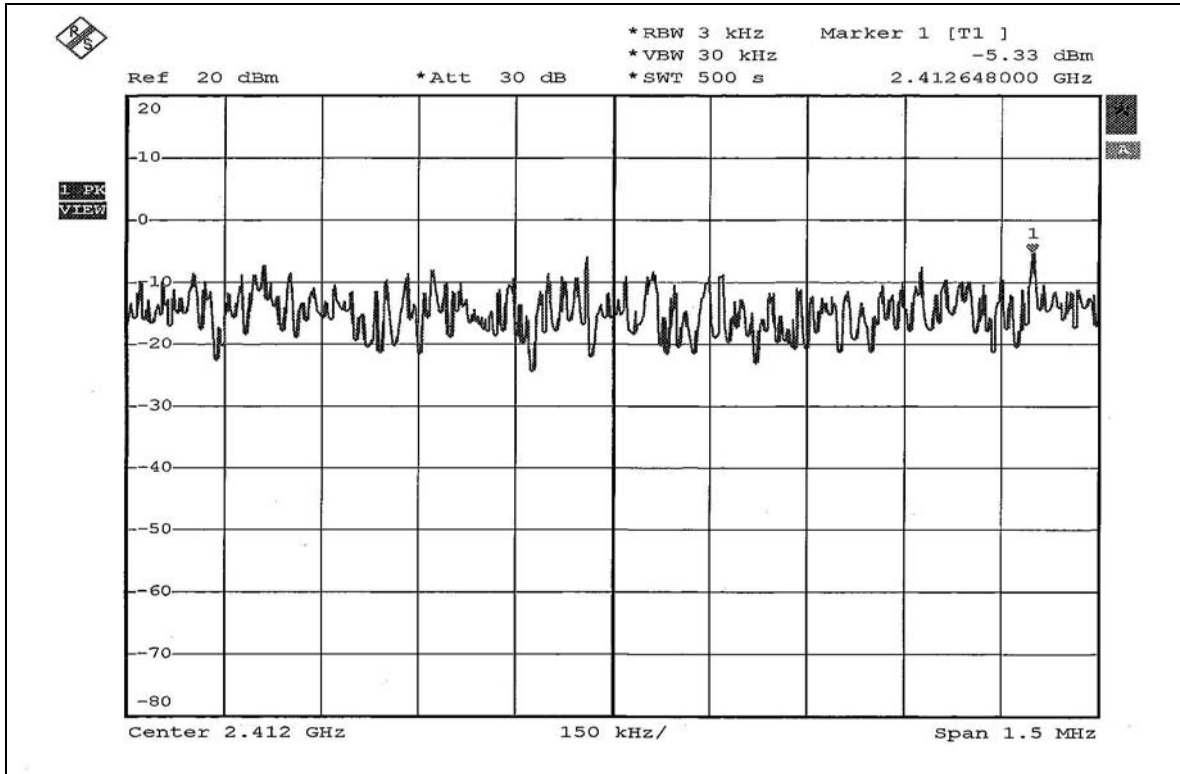

CH6

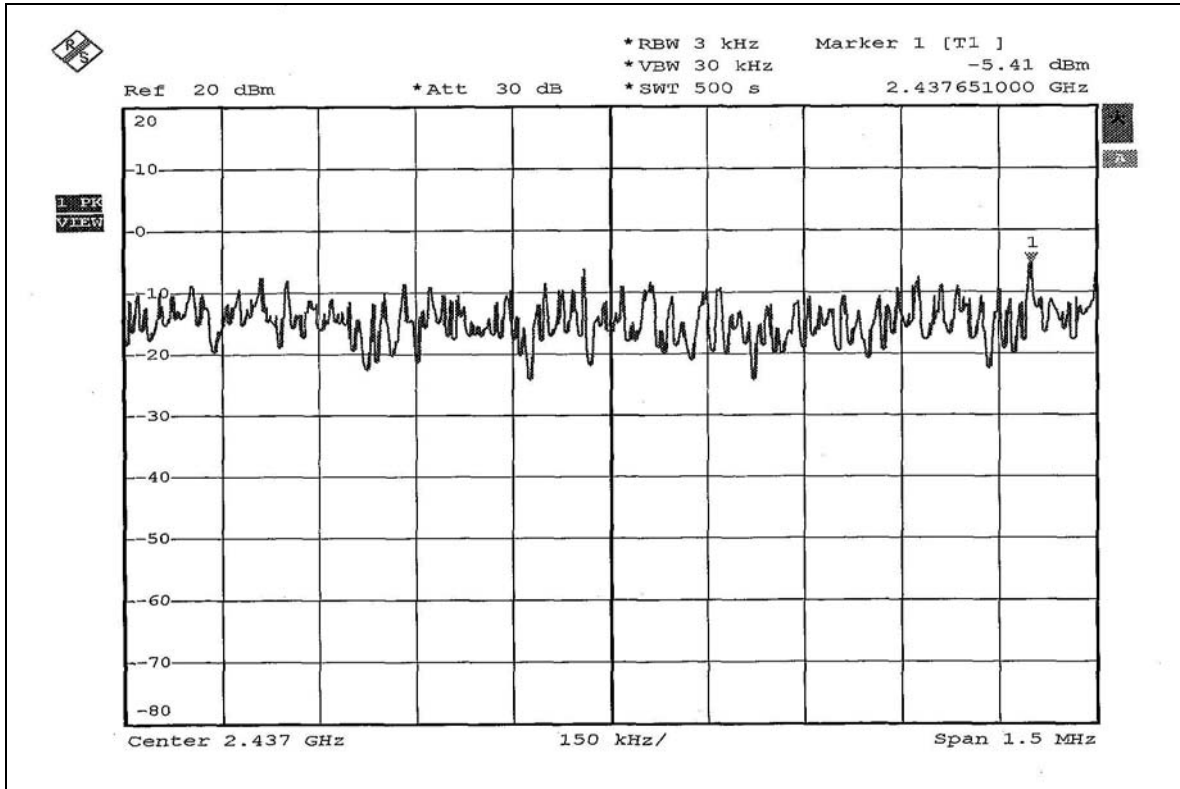



CH11

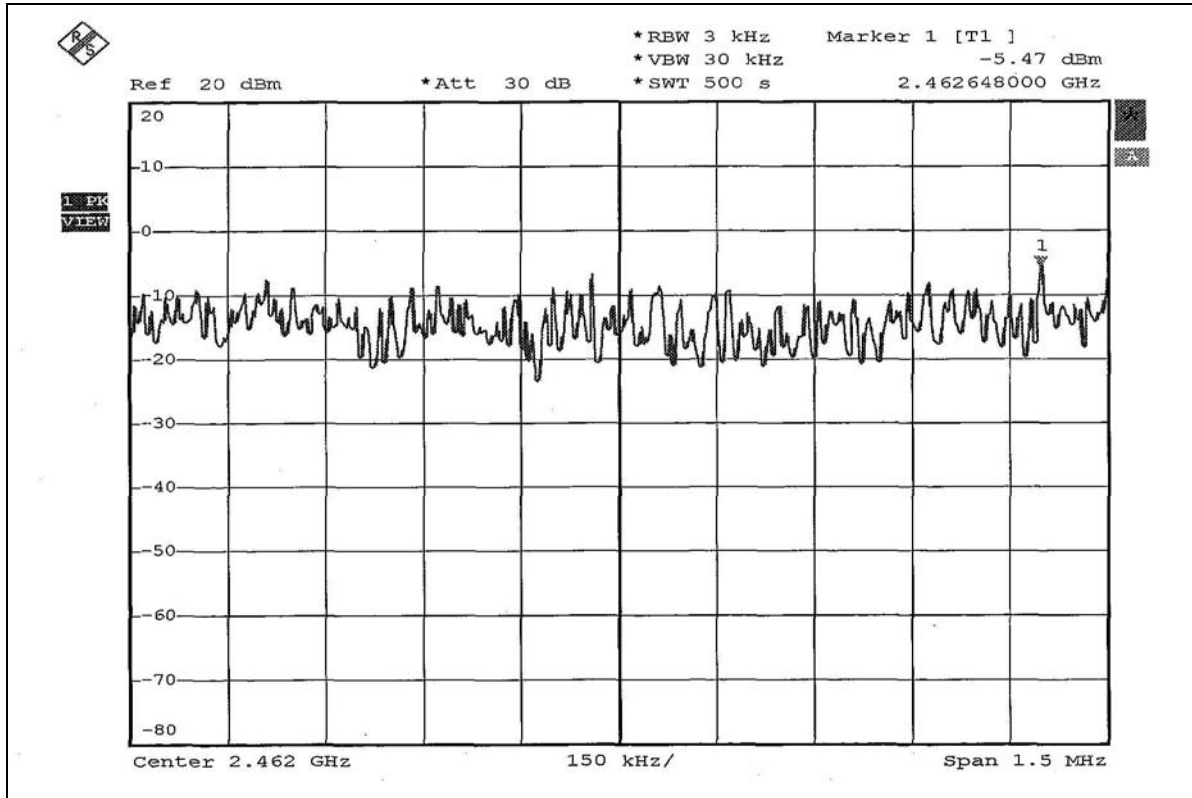

**802.11g OFDM modulation**

EUT	Notebook	MODEL	600
MODULATION TYPE	BPSK	TRANSFER RATE	6Mbps
INPUT POWER (SYSTEM)	120Vac, 60Hz	ENVIRONMENTAL CONDITIONS	23deg. C, 61%RH, 991hPa
TESTED BY	Gary Chang		

CHANNEL	CHANNEL FREQUENCY (MHz)	RF POWER LEVEL IN 3kHz BW (dBm)	MAXIMUM LIMIT (dBm)	PASS/FAIL
1	2412	-14.69	8	PASS
6	2437	-14.62	8	PASS
11	2462	-14.54	8	PASS



CH1

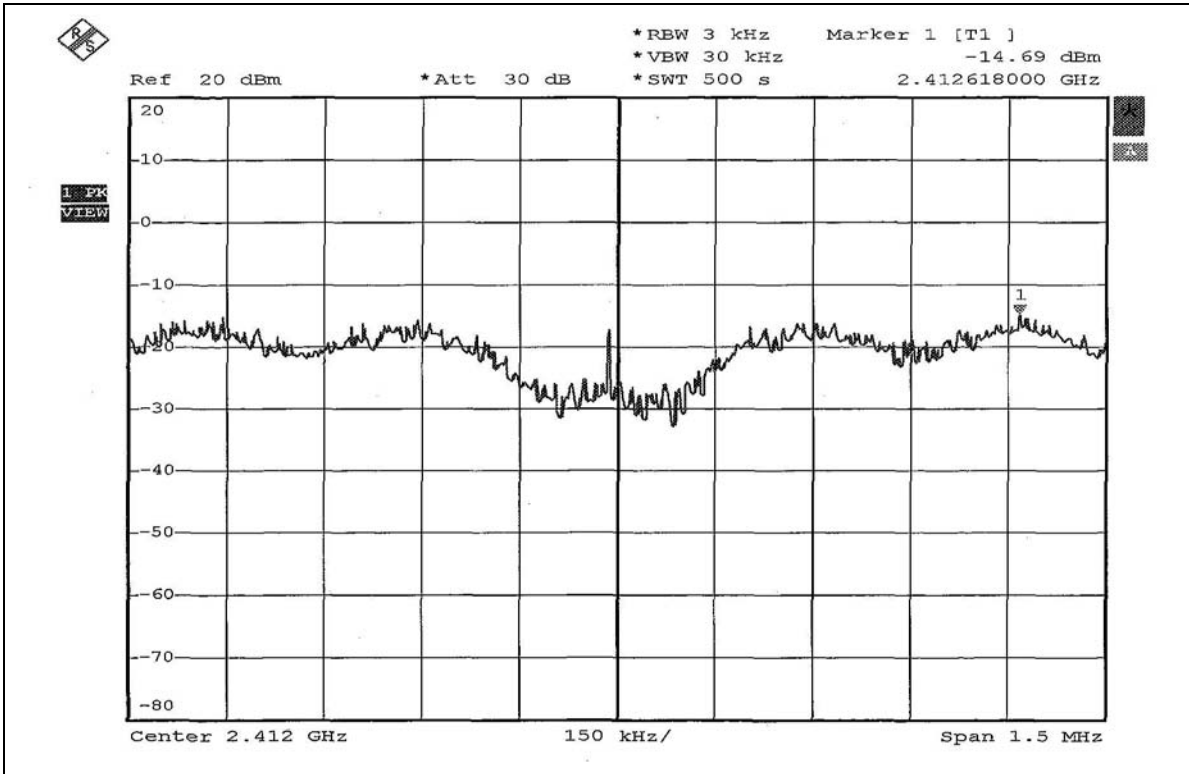

CH6

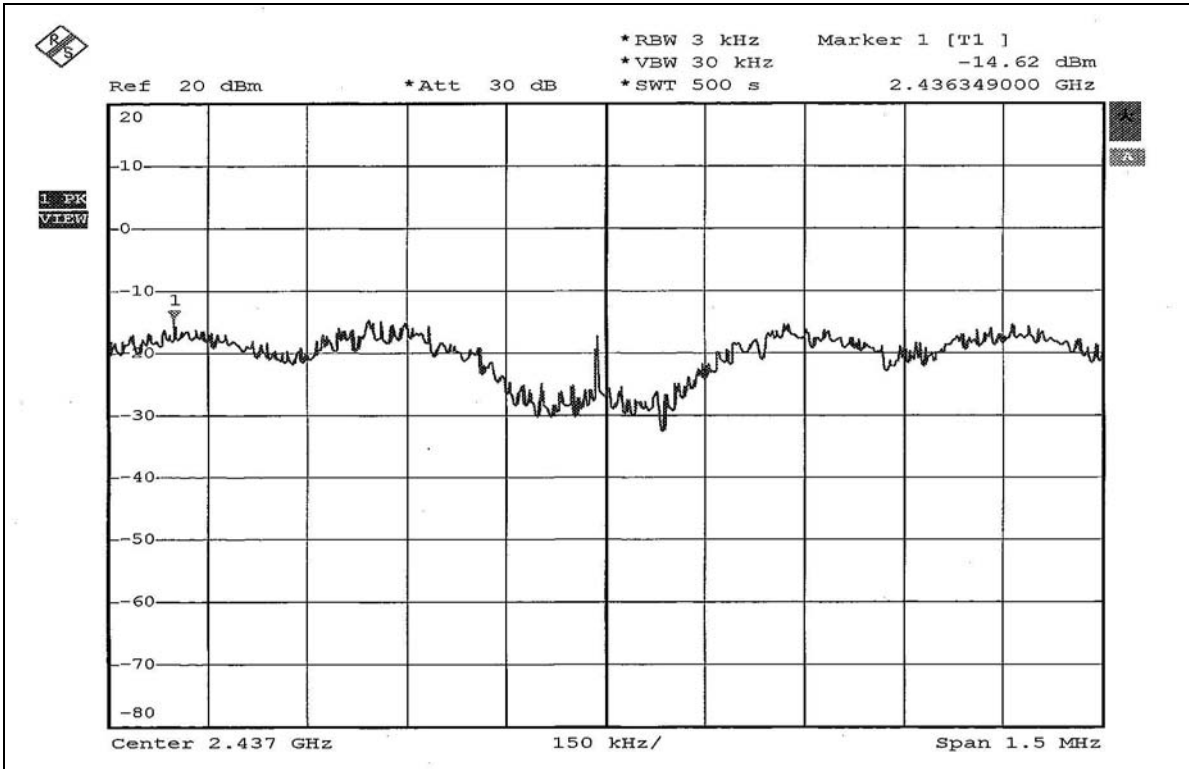



CH11

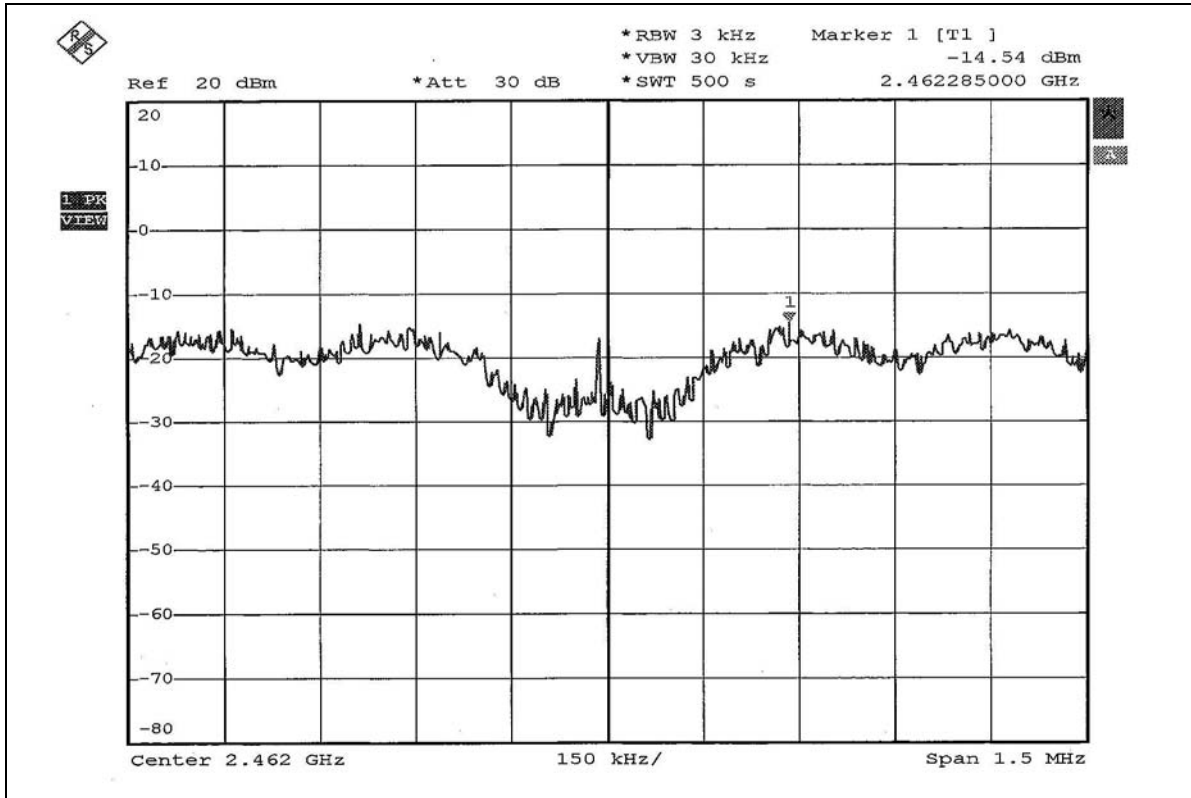



4.6 BAND EDGES MEASUREMENT

4.6.1 LIMITS OF BAND EDGES MEASUREMENT

Below -20dB of the highest emission level of operating band (in 100kHz Resolution Bandwidth).

4.6.2 TEST INSTRUMENTS

Description & Manufacturer	Model No.	Serial No.	Calibrated Until
R&S SPECTRUM ANALYZER	FSEK30	100049	Aug. 12, 2005

NOTE: The calibration interval of the above test instruments is 12 months and the calibrations are traceable to NML/ROC and NIST/USA.

4.6.3 TEST PROCEDURE

The transmitter output was connected to the spectrum analyzer via a low lose cable. Set both RBW and VBW of spectrum analyzer to 100kHz with suitable frequency span including 100 MHz bandwidth from band edge. The band edges was measured and recorded.

The spectrum plots (Peak RBW=VBW=100kHz ; Average RBW=1MHz, VBW=10Hz) are attached on the following pages.

4.6.4 DEVIATION FROM TEST STANDARD

No deviation

4.6.5 EUT OPERATING CONDITION

Same as Item 4.3.6



4.6.6 TEST RESULTS

The spectrum plots are attached on the following 12 images. D2 line indicates the highest level, and D1 line indicates the 20dB offset below D2. It shows compliance with the requirement in part 15.247(d).

802.11b DSSS modulation

NOTE 1: The band edge emission plot on page 57 shows 53.92dBc between carrier maximum power and local maximum emission in restrict band (2.3614GHz). The emission of carrier strength list in the test result of channel 1 at the item 4.2.7 is 108.54dBuV/m (Peak), so the maximum field strength in restrict band is $108.54 - 53.92 = 54.62$ dBuV/m which is under 74dBuV/m limit..

The band edge emission plot of on page 57 shows 59.40dBc between carrier maximum power and local maximum emission in restrict band (2.3880GHz). The emission of carrier strength list in the test result of channel 1 at the item 4.2.7 is 101.32dBuV/m (Average), so the maximum field strength in restrict band is $101.32 - 59.40 = 41.92$ dBuV/m which is under 54dBuV/m limit.

NOTE 2: The band edge emission plot on page 58 shows 53.56dBc between carrier maximum power and local maximum emission in restrict band (2.4866GHz). The emission of carrier strength list in the test result of channel 11 at the item 4.2.7 is 108.21dBuV/m (Peak), so the maximum field strength in restrict band is $108.21 - 53.56 = 54.65$ dBuV/m which is under 74dBuV/m limit.

The band edge emission plot on page 59 shows 59.46dBc between carrier maximum power and local maximum emission in restrict band (2.4864GHz). The emission of carrier strength list in the test result of channel 11 at the item 4.2.7 is 100.86dBuV/m (Average), so the maximum field strength in restrict band is $100.86 - 59.46 = 41.40$ dBuV/m which is under 54dBuV/m limit.



802.11g OFDM modulation

NOTE 1: The band edge emission plot on page 60 shows 50.22dBc between carrier maximum power and local maximum emission in restrict band (2.3830GHz). The emission of carrier strength list in the test result of channel 1 at the item 4.2.7 is 105.54dBuV/m (Peak), so the maximum field strength in restrict band is $105.54 - 50.22 = 55.32$ dBuV/m which is under 74dBuV/m limit.

The band edge emission plot of on page 60 shows 51.00dBc between carrier maximum power and local maximum emission in restrict band (2.3900GHz). The emission of carrier strength list in the test result of channel 1 at the item 4.2.7 is 95.95dBuV/m (Average), so the maximum field strength in restrict band is $95.95 - 51.00 = 44.95$ dBuV/m which is under 54dBuV/m limit.

NOTE 2: The band edge emission plot on page 61 shows 49.23dBc between carrier maximum power and local maximum emission in restrict band (2.4882GHz). The emission of carrier strength list in the test result of channel 11 at the item 4.2.7 is 104.16dBuV/m (Peak), so the maximum field strength in restrict band is $104.16 - 49.23 = 54.93$ dBuV/m which is under 74dBuV/m limit.

The band edge emission plot on page 62 shows 51.41dBc between carrier maximum power and local maximum emission in restrict band (2.4943GHz). The emission of carrier strength list in the test result of channel 11 at the item 4.2.7 is 94.10dBuV/m (Average), so the maximum field strength in restrict band is $94.10 - 51.41 = 42.69$ dBuV/m which is under 54dBuV/m limit.



802.11b DSSS modulation

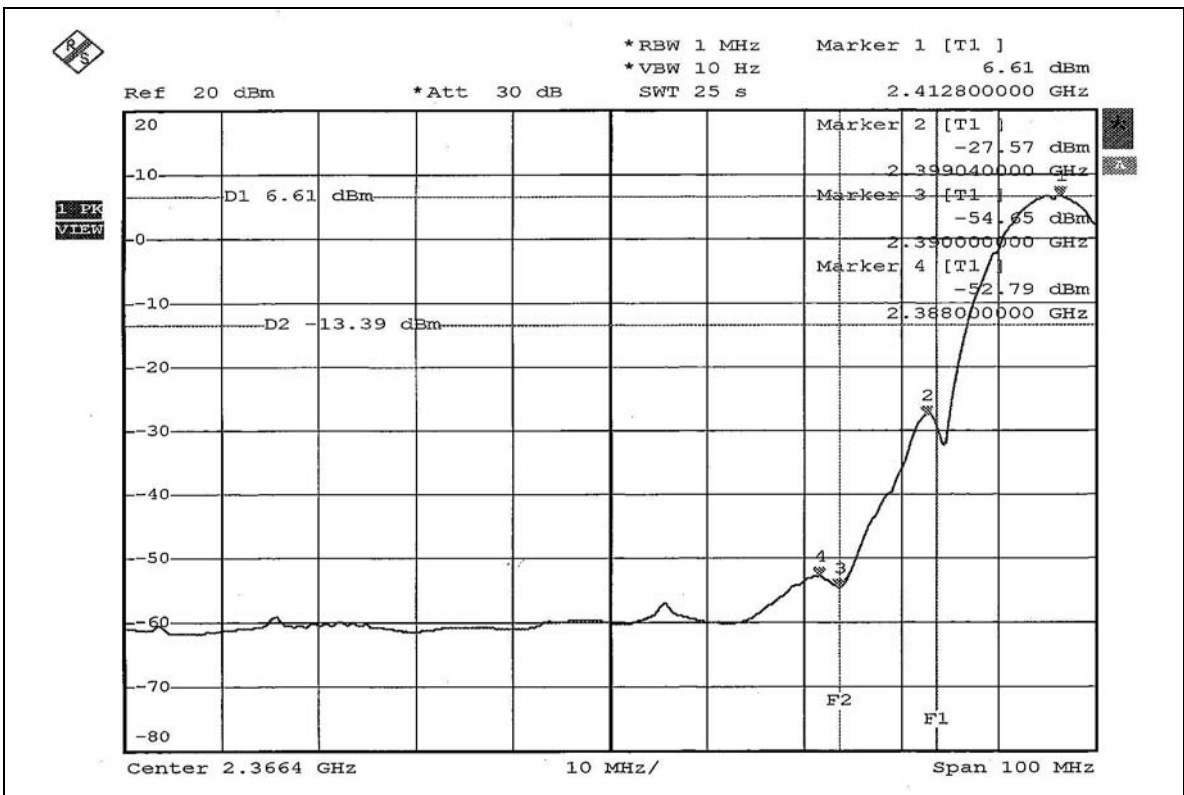
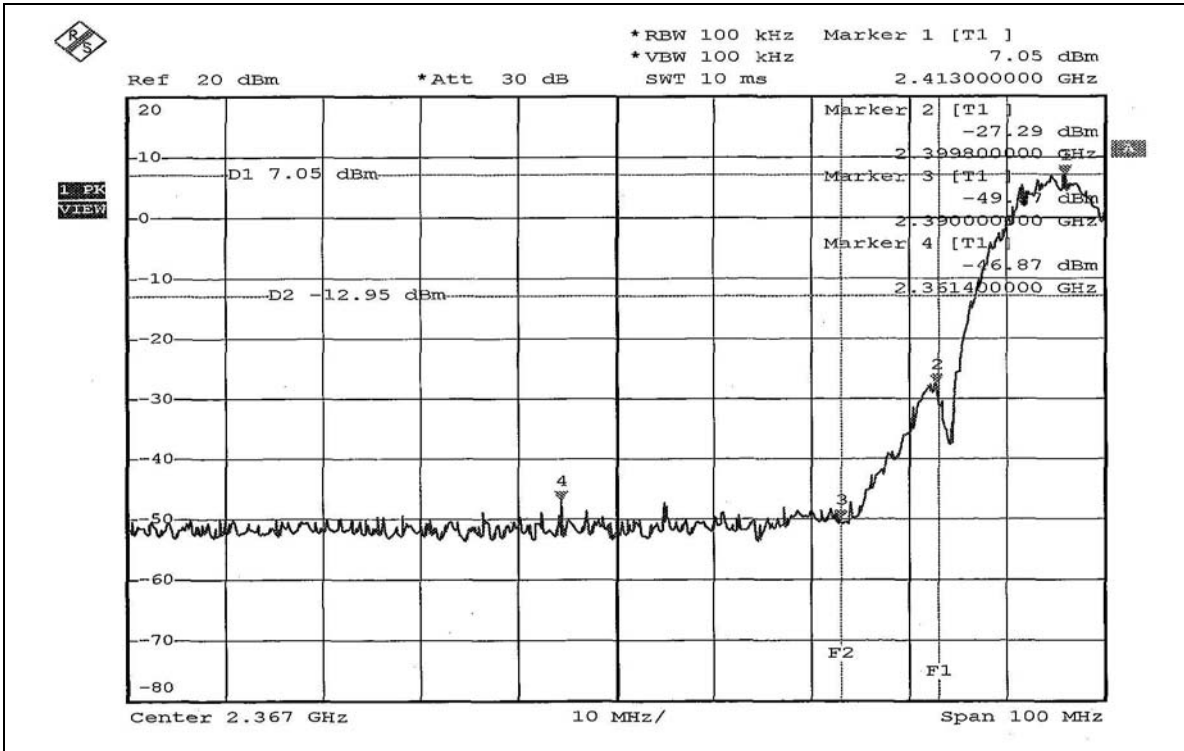

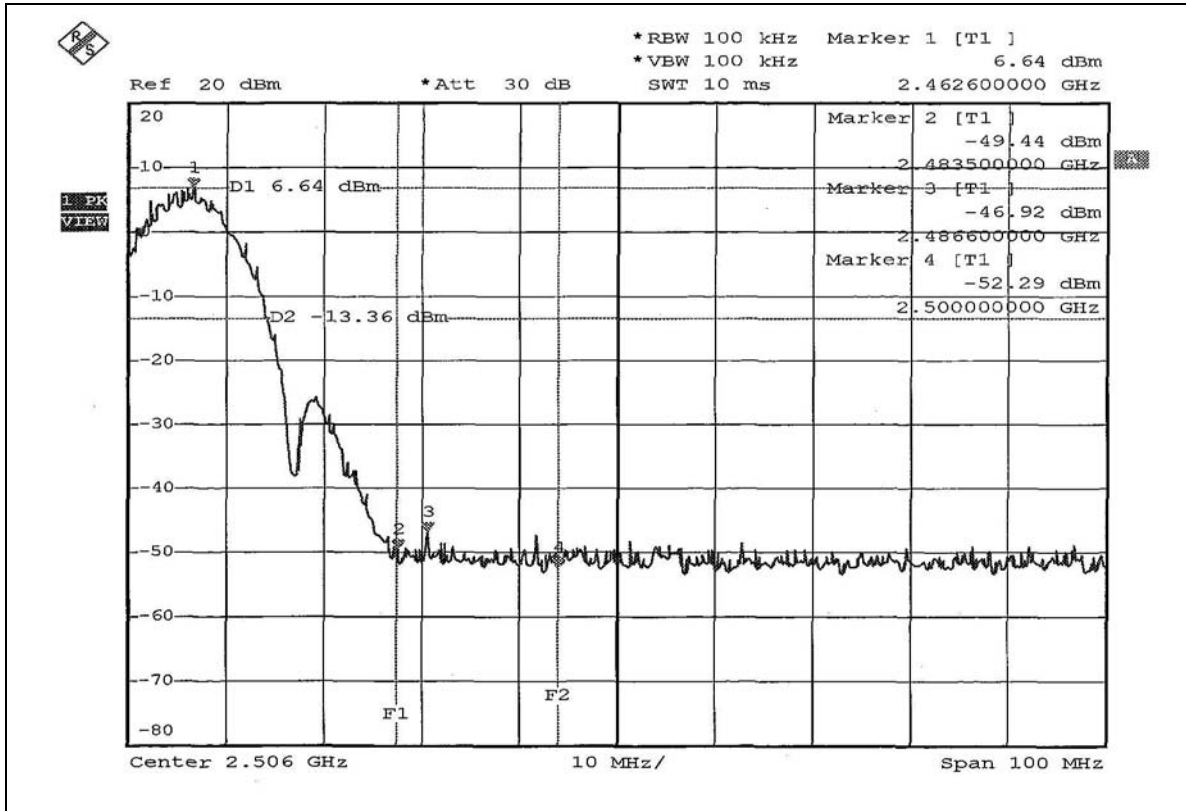
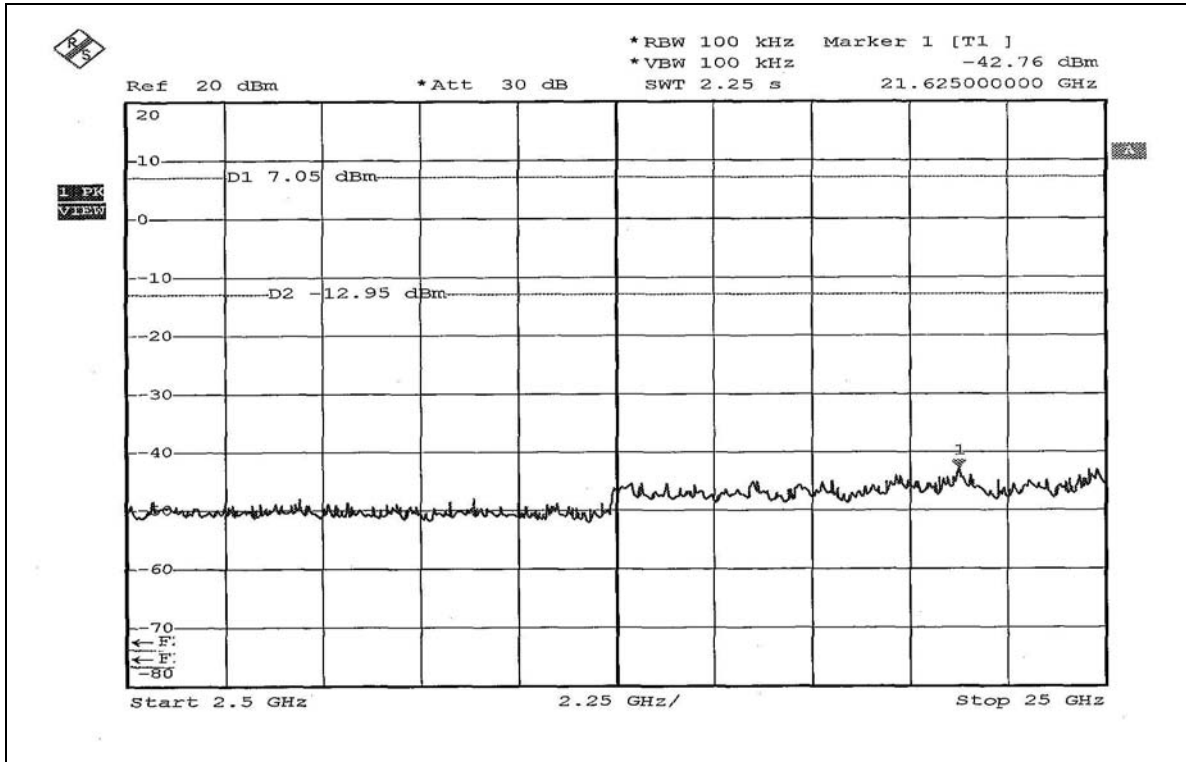

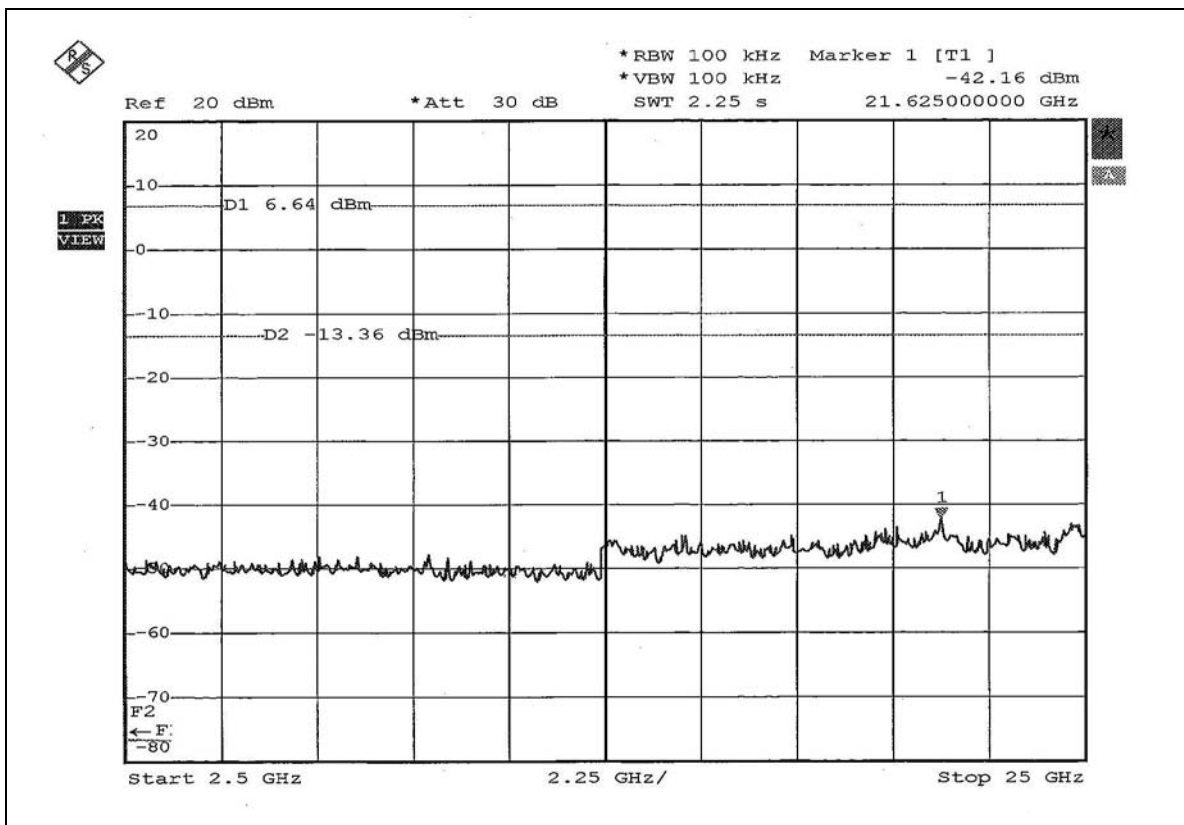
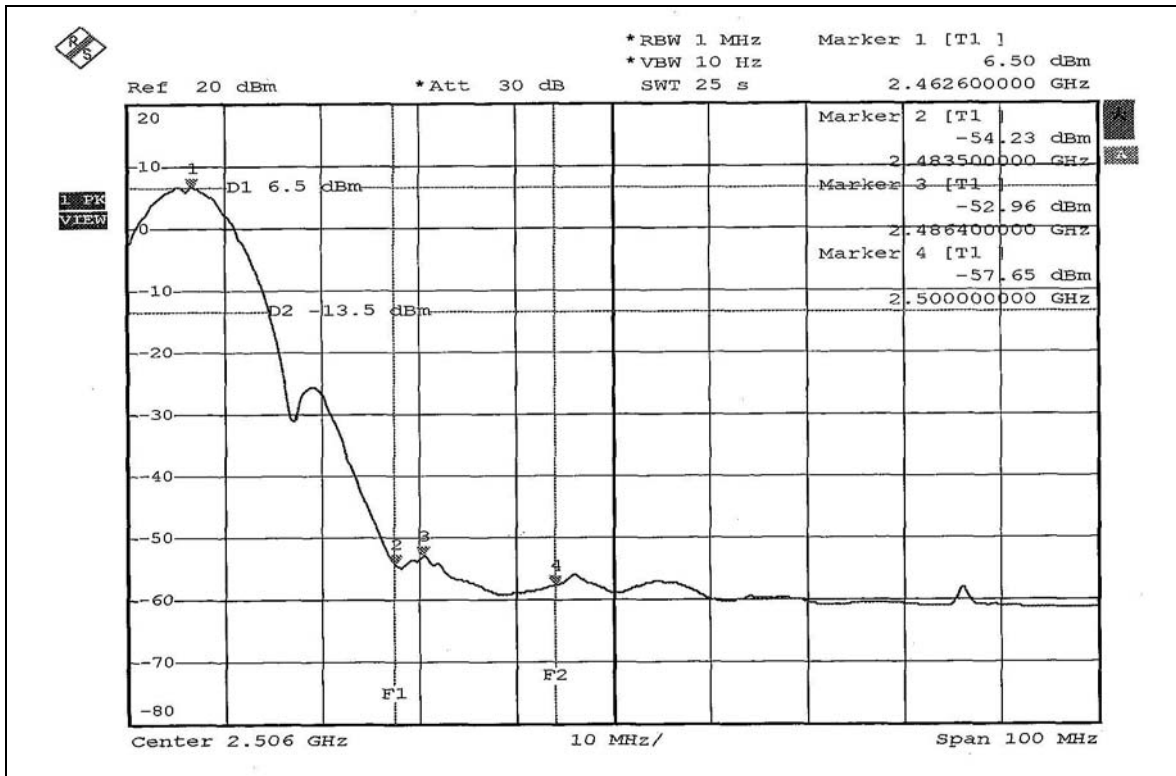



802.11g OFDM modulation

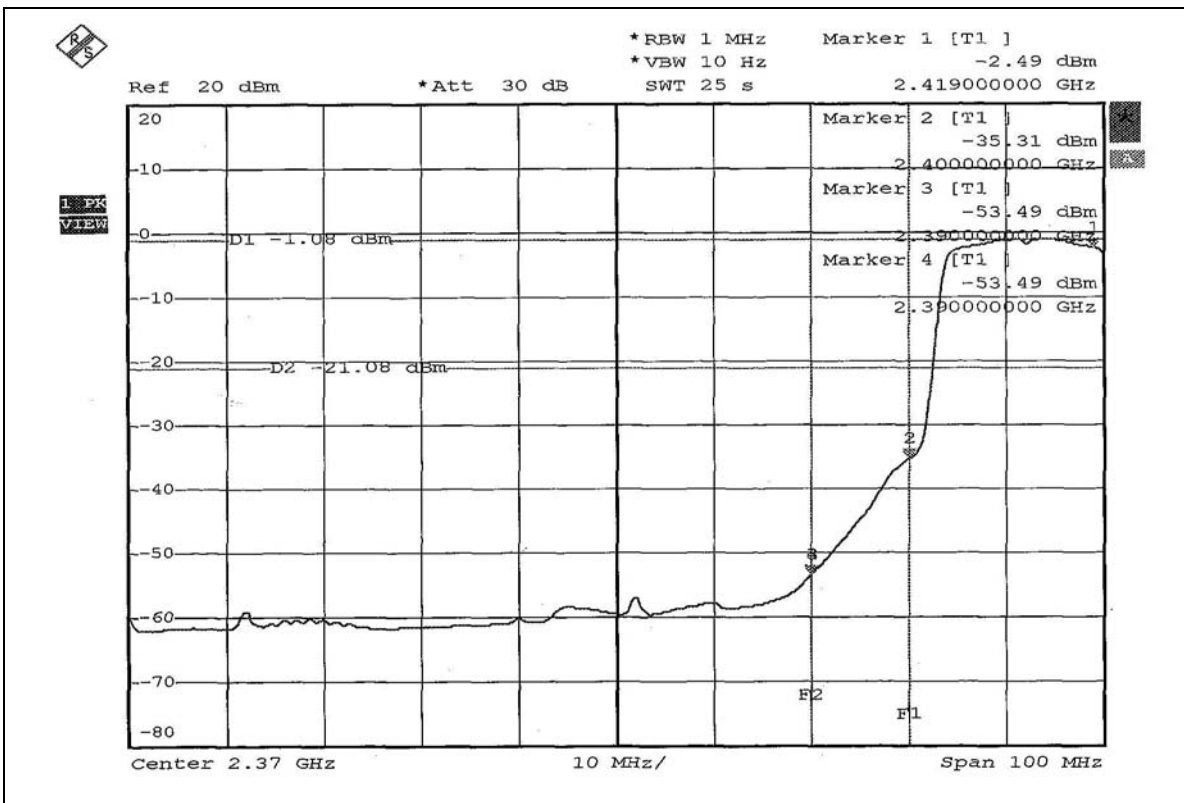
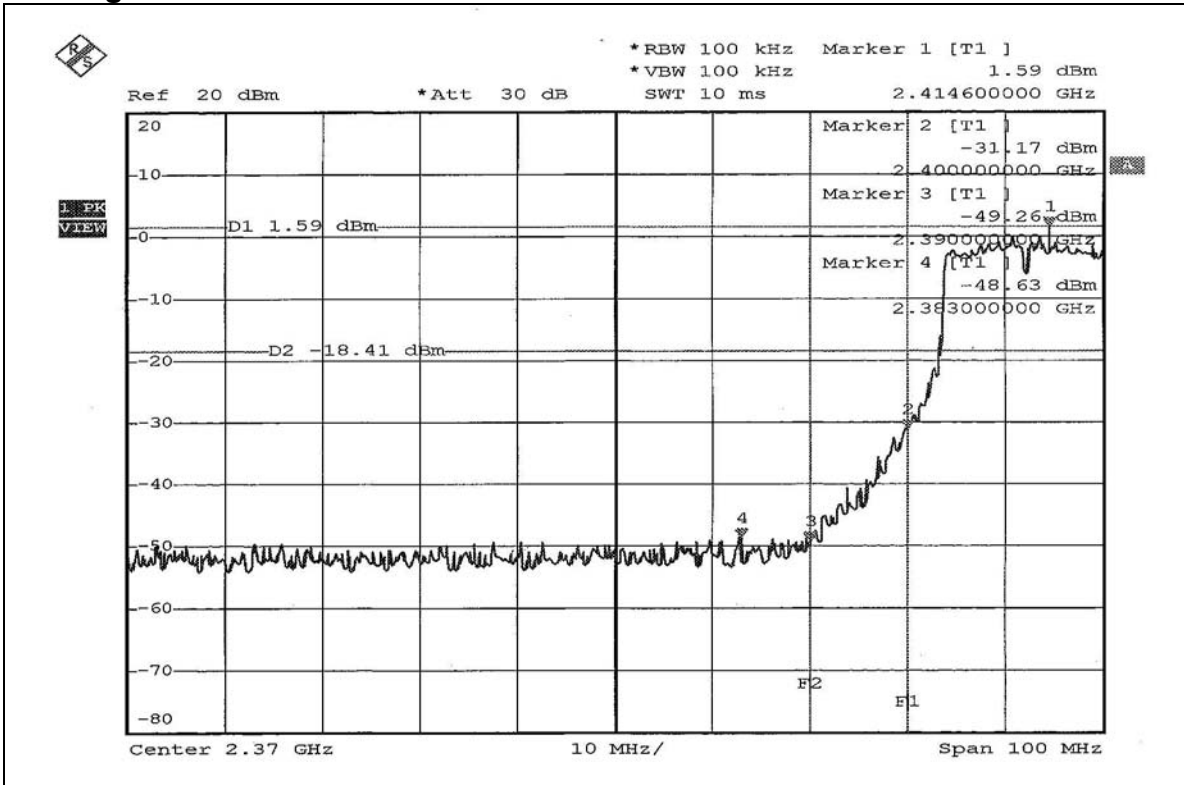

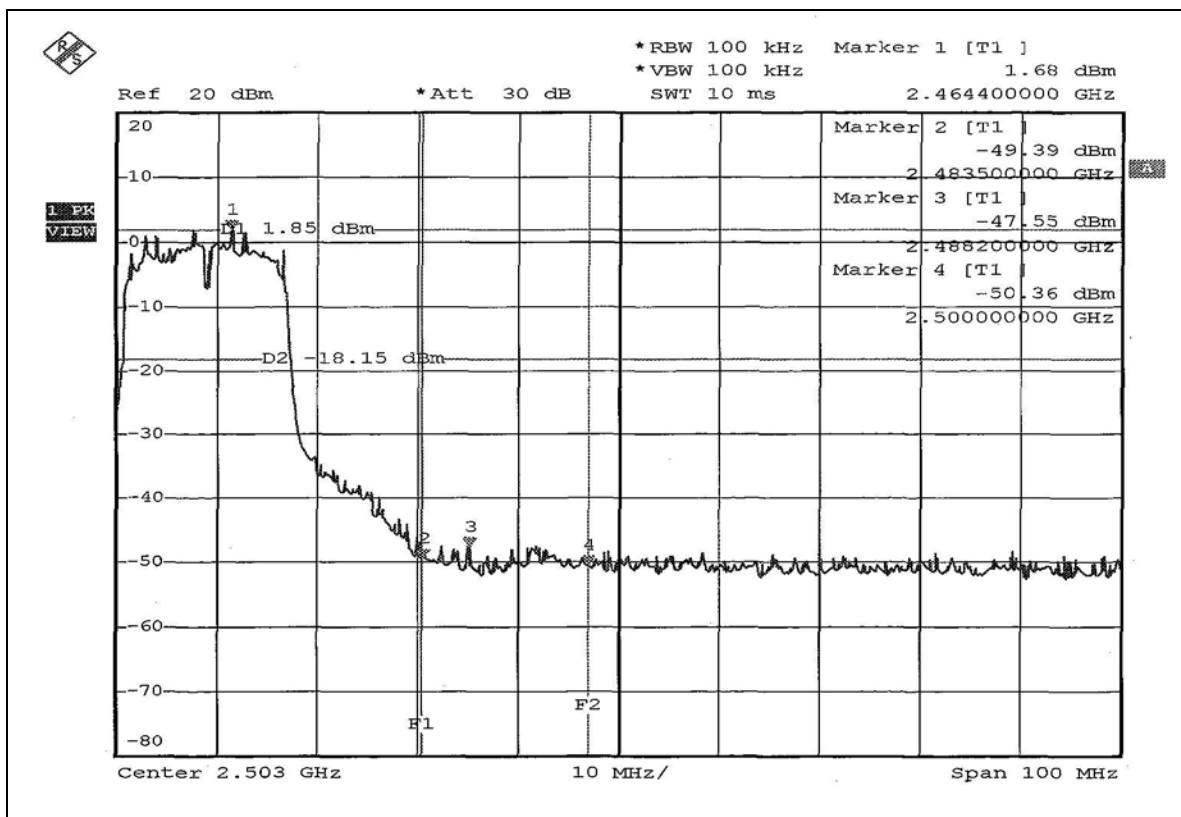
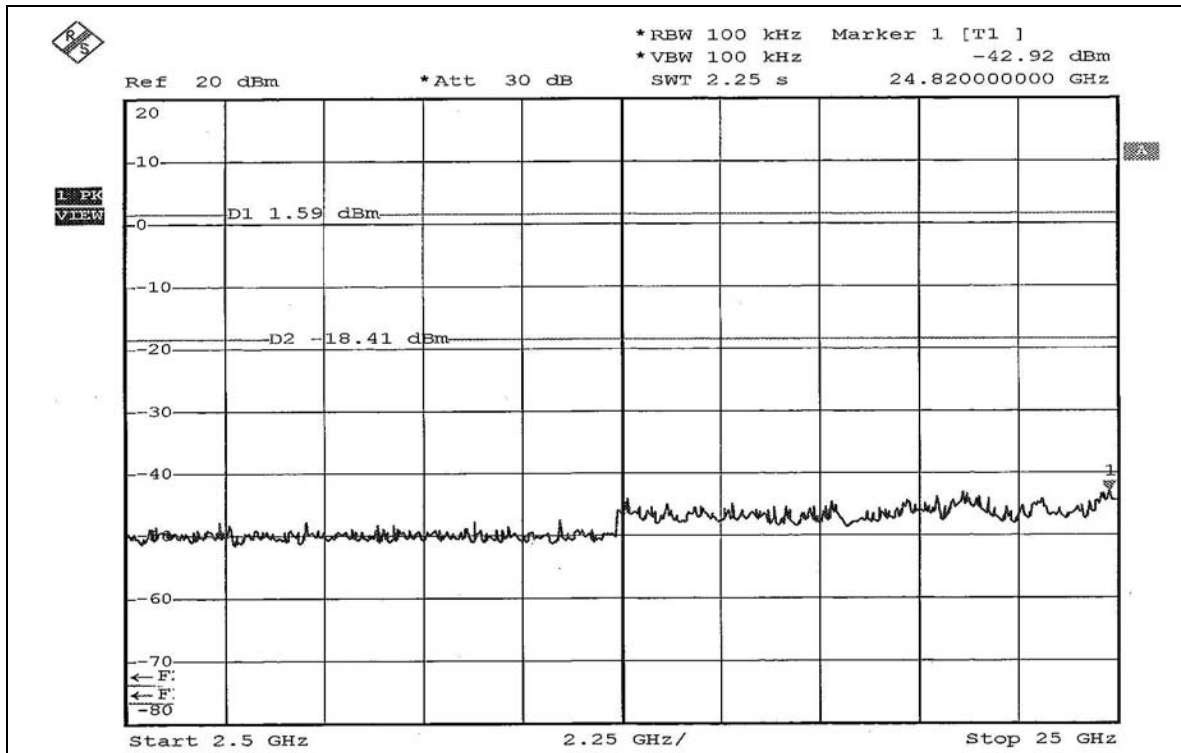

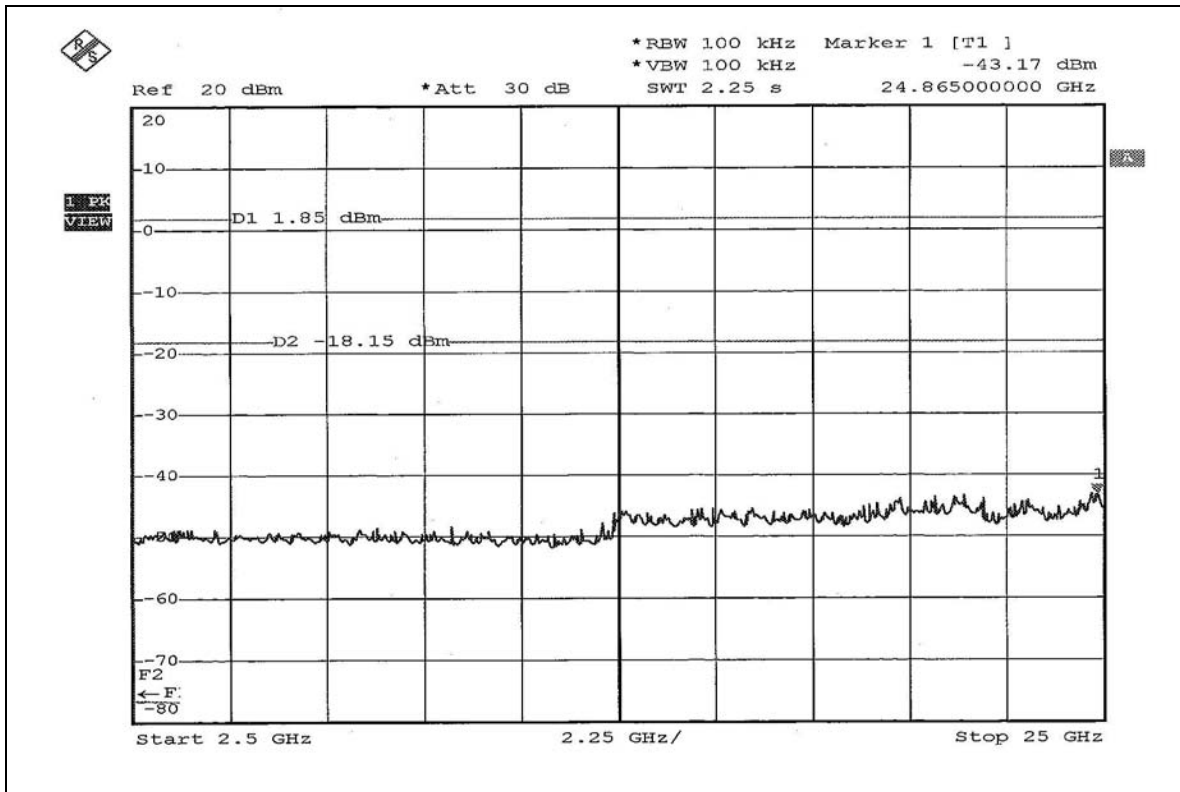
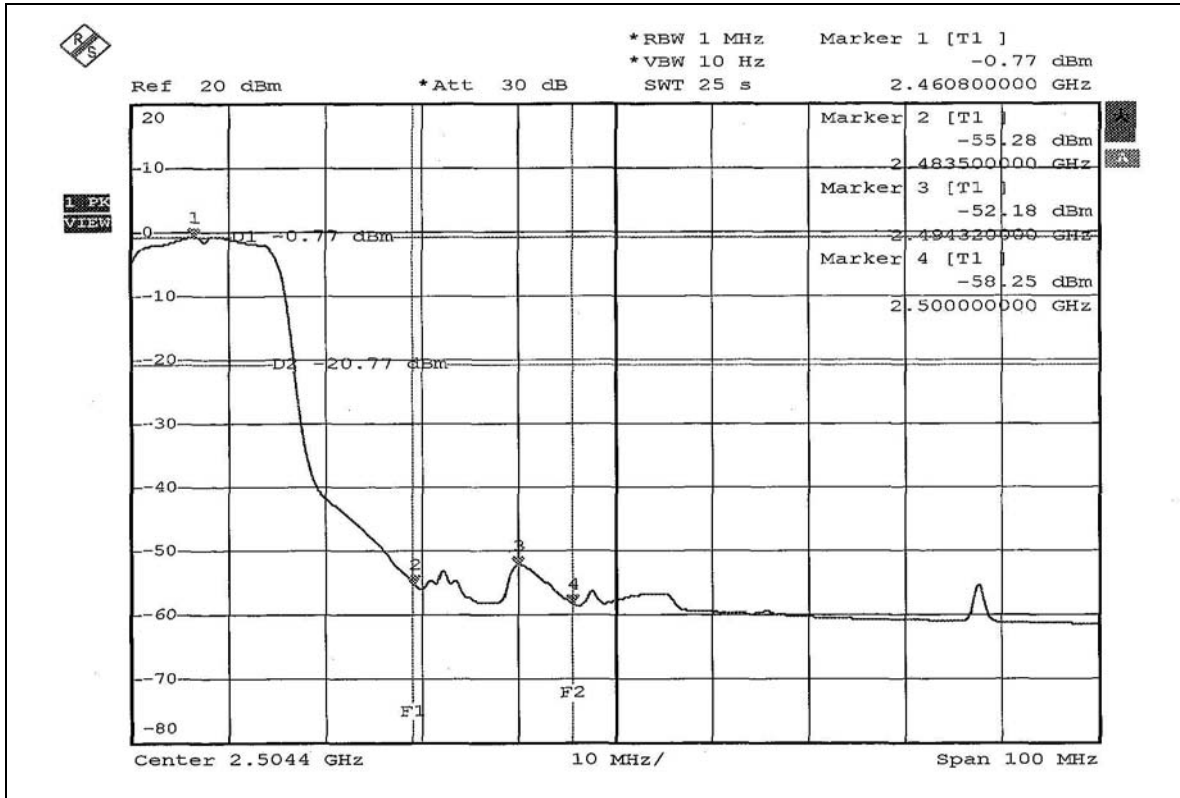



4.7 ANTENNA REQUIREMENT

4.7.1 STANDARD APPLICABLE

For intentional device, according to FCC 47 CFR Section 15.203, an intentional radiator shall be designed to ensure that no antenna other than that furnished by the responsible party shall be used with the device. And according to FCC 47 CFR Section 15.247 (b), if transmitting antennas of directional gain greater than 6dBi are used, the power shall be reduced by the amount in dB that the directional gain of the antenna exceeds 6dBi.

4.7.2 ANTENNA CONNECTED CONSTRUCTION

The antenna used in this product is PIFA antenna with UFL connector. The maximum Gain of the antenna is -3.37dBi .



5. TEST TYPES AND RESULTS (802.11a 5725~5850MHz Band)

5.1 CONDUCTED EMISSION MEASUREMENT

5.1.1 LIMITS OF CONDUCTED EMISSION MEASUREMENT

FREQUENCY OF EMISSION (MHz)	CONDUCTED LIMIT (dB μ V)	
	Quasi-peak	Average
0.15-0.5	66 to 56	56 to 46
0.5-5	56	46
5-30	60	50

- NOTE:**
1. The lower limit shall apply at the transition frequencies.
 2. The limit decreases in line with the logarithm of the frequency in the range of 0.15 to 0.50 MHz.
 3. All emanations from a class A/B digital device or system, including any network of conductors and apparatus connected thereto, shall not exceed the level of field strengths specified above.

5.1.2 TEST INSTRUMENTS

DESCRIPTION & MANUFACTURER	MODEL NO.	SERIAL NO.	CALIBRATED UNTIL
Test Receiver ROHDE & SCHWARZ	ESCS30	100291	Nov. 16, 2005
RF signal cable Woken	5D-FB	Cable-HYC01-01	Jan. 09, 2006
LISN ROHDE & SCHWARZ	ESH3-Z5	100312	Feb. 15, 2006
LISN ROHDE & SCHWARZ	ESH2-Z5	100104	Feb. 15, 2006
Software ADT	ADT_Cond_V3	NA	NA

- NOTE:**
1. The calibration interval of the above test instruments is 12 months and the calibrations are traceable to NML/ROC and NIST/USA.
 2. The test was performed in HwaYa Shielded Room 1.
 3. The VCCI Site Registration No. is C-2040.



5.1.3 TEST PROCEDURES

- a. The EUT was placed 0.4 meters from the conducting wall of the shielded room with EUT being connected to the power mains through a line impedance stabilization network (LISN). Other support units were connected to the power mains through another LISN. The two LISNs provide 50 ohm/ 50uH of coupling impedance for the measuring instrument.
- b. Both lines of the power mains connected to the EUT were checked for maximum conducted interference.
- c. The frequency range from 150kHz to 30MHz was searched. Emission levels under (Limit – 20dB) was not recorded.

5.1.4 DEVIATION FROM TEST STANDARD

No deviation

5.1.5 TEST SETUP

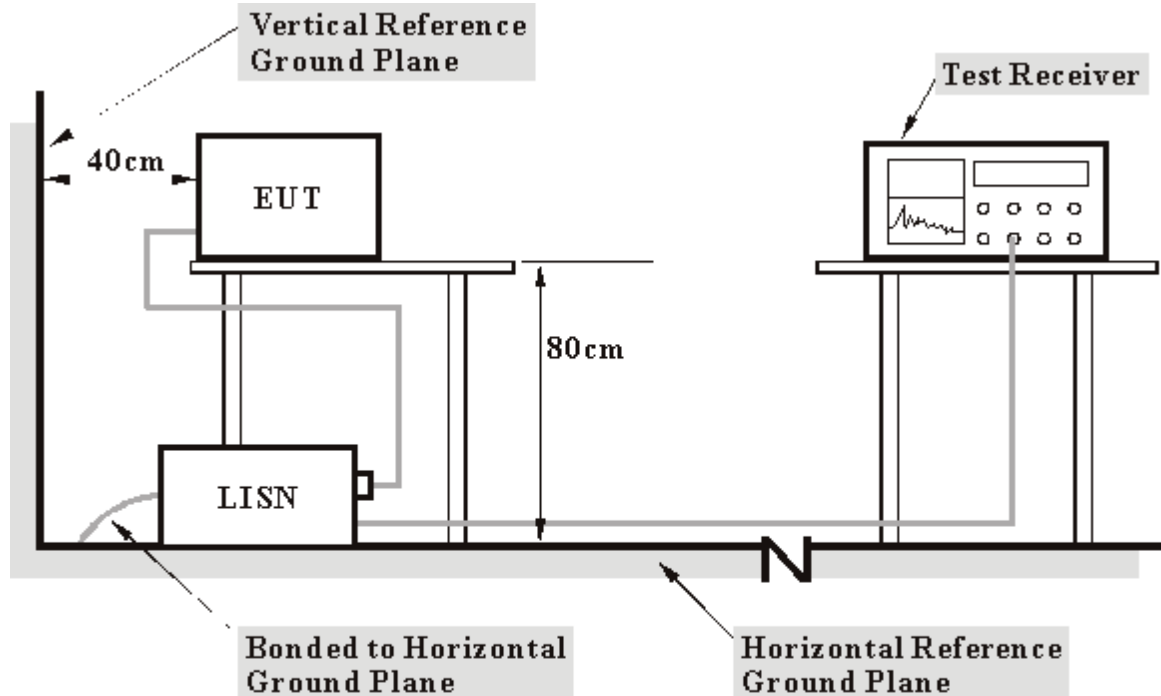

- Note:**
1. Support units were connected to second LISN.
 2. Both of LISNs (AMN) 80 cm from EUT and at the least 80 cm from other units and other metal planes support units.

For the actual test configuration, please refer to the related item – Photographs of the Test Configuration.

5.1.6 EUT OPERATING CONDITIONS

Same as 4.1.6



5.1.7 TEST RESULTS

Conducted Worst-Case Data

EUT	Notebook	MODEL	600
CHANNEL	Channel 3	6dB BANDWIDTH	9 kHz
MODULATION TYPE	BPSK	TRANSFER RATE	6Mbps
INPUT POWER (SYSTEM)	120Vac, 60 Hz	PHASE	Line (L)
ENVIRONMENTAL CONDITIONS	22deg. C, 70%RH, 991hPa	TESTED BY	Derry Tsui

No	Freq. [MHz]	Corr. Factor (dB)	Reading Value [dB (uV)]		Emission Level [dB (uV)]		Limit [dB (uV)]		Margin (dB)	
			Q.P.	AV.	Q.P.	AV.	Q.P.	AV.	Q.P.	AV.
			1	0.150	0.10	36.71	-	36.81	-	66.00
2	0.177	0.11	36.26	-	36.37	-	64.61	54.61	-28.24	-
3	0.705	0.15	27.29	-	27.44	-	56.00	46.00	-28.56	-
4	0.970	0.18	28.86	-	29.04	-	56.00	46.00	-26.96	-
5	12.734	0.53	35.10	-	35.63	-	60.00	50.00	-24.37	-
6	19.164	0.89	26.64	-	27.53	-	60.00	50.00	-32.47	-

- REMARKS:**
1. Q.P. and AV. are abbreviations of quasi-peak and average individually.
 2. "-": The Quasi-peak reading value also meets average limit and measurement with the average detector is unnecessary.
 3. The emission levels of other frequencies were very low against the limit.
 4. Margin value = Emission level - Limit value
 5. Correction factor = Insertion loss + Cable loss
 6. Emission Level = Correction Factor + Reading Value.

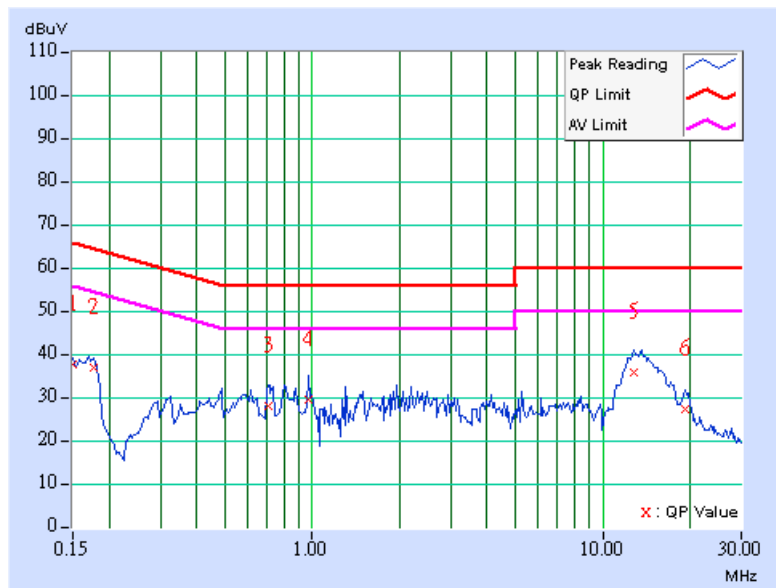



EUT	Notebook	MODEL	600
CHANNEL	Channel 3	6dB BANDWIDTH	9 kHz
MODULATION TYPE	BPSK	TRANSFER RATE	6Mbps
INPUT POWER (SYSTEM)	120Vac, 60 Hz	PHASE	Neutral (N)
ENVIRONMENTAL CONDITIONS	22deg. C, 70%RH, 991hPa	TESTED BY	Derry Tsui

No	Freq. [MHz]	Corr. Factor (dB)	Reading Value [dB (uV)]		Emission Level [dB (uV)]		Limit [dB (uV)]		Margin (dB)	
			Q.P.	AV.	Q.P.	AV.	Q.P.	AV.	Q.P.	AV.
			1	0.150	0.10	37.70	-	37.80	-	66.00
2	0.177	0.10	36.72	-	36.82	-	64.61	54.61	-27.79	-
3	0.707	0.14	26.34	-	26.48	-	56.00	46.00	-29.52	-
4	3.238	0.25	25.46	-	25.71	-	56.00	46.00	-30.29	-
5	13.402	0.46	36.27	-	36.73	-	60.00	50.00	-23.27	-
6	14.883	0.49	33.93	-	34.42	-	60.00	50.00	-25.58	-

- REMARKS:**
1. Q.P. and AV. are abbreviations of quasi-peak and average individually.
 2. "-": The Quasi-peak reading value also meets average limit and measurement with the average detector is unnecessary.
 3. The emission levels of other frequencies were very low against the limit.
 4. Margin value = Emission level - Limit value
 5. Correction factor = Insertion loss + Cable loss
 6. Emission Level = Correction Factor + Reading Value.

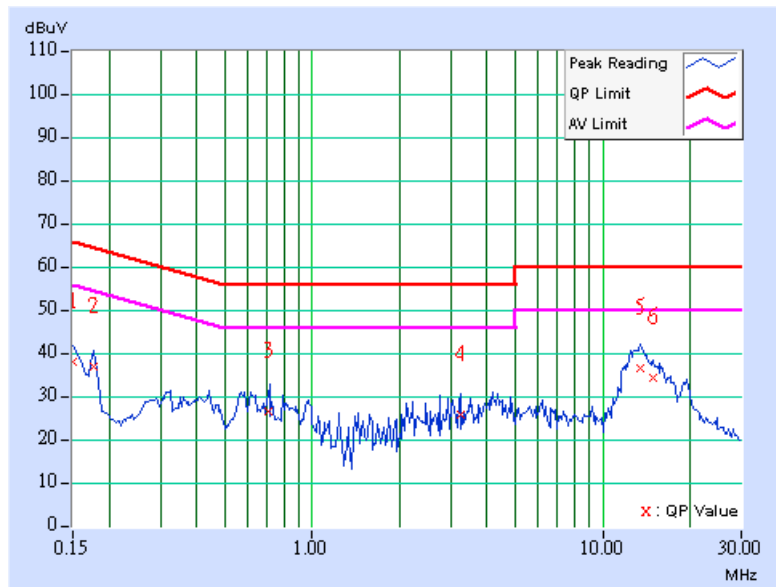



5.2 RADIATED EMISSION MEASUREMENT

5.2.1 LIMITS OF RADIATED EMISSION MEASUREMENT

Emissions radiated outside of the specified bands, shall be according to the general radiated limits in 15.209 as following:

Frequencies (MHz)	Field strength (microvolts/meter)	Measurement distance (meters)
0.009-0.490	2400/F(kHz)	300
0.490-1.705	24000/F(kHz)	30
1.705-30.0	30	30
30-88	100	3
88-216	150	3
216-960	200	3
Above 960	500	3

NOTE:

1. The lower limit shall apply at the transition frequencies.
2. Emission level (dBuV/m) = 20 log Emission level (uV/m).
3. As shown in 15.35(b), for frequencies above 1000MHz, the field strength limits are based on average detector, however, the peak field strength of any emission shall not exceed the maximum permitted average limits, specified above by more than 20dB under any condition of modulation.



5.2.2 TEST INSTRUMENTS

DESCRIPTION & MANUFACTURER	MODEL NO.	SERIAL NO.	CALIBRATED UNTIL
Test Receiver ROHDE & SCHWARZ	ESI7	838496/016	Jan. 07, 2006
Spectrum Analyzer ROHDE & SCHWARZ	FSP40	100041	Nov. 29, 2005
BILOG Antenna SCHWARZBECK	VULB9168	9168-155	Jan. 22, 2006
HORN Antenna SCHWARZBECK	BBHA 9120D	9120D-404	Jan. 05, 2006
HORN Antenna SCHWARZBECK	BBHA 9170	BBHA 9170242	Jan. 23, 2006
Preamplifier Agilent	8447D	2944A10631	Nov. 17, 2005
Preamplifier Agilent	8449B	3008A01960	Nov. 14, 2005
RF signal cable HUBER+SUHNNER	SUCOFLEX 104	219272/4	Jan. 26, 2006
RF signal cable HUBER+SUHNNER	SUCOFLEX 104	219275/4	Jan. 26, 2006
Software ADT.	ADT_Radiated_V5.14	NA	NA
Antenna Tower inn-co GmbH	MA 4000	010303	NA
Antenna Tower Controller inn-co GmbH	CO2000	019303	NA
Turn Table ADT.	TT100.	TT93021704	NA
Turn Table Controller ADT.	SC100.	SC93021704	NA

- NOTE:**
1. The calibration interval of the above test instruments is 12 months and the calibrations are traceable to NML/ROC and NIST/USA.
 2. The test was performed in HwaYa Chamber 3.
 3. The horn antenna and HP preamplifier (model: 8449B) are used only for the measurement of emission frequency above 1GHz if tested.
 4. The IC Site Registration No. is IC4924-4.



5.2.3 TEST PROCEDURES

- a. The EUT was placed on the top of a rotating table 0.8 meters above the ground at a 3 meter semi-anechoic chamber. The table was rotated 360 degrees to determine the position of the highest radiation.
- b. The EUT was set 3 meters away from the interference-receiving antenna, which was mounted on the top of a variable-height antenna tower.
- c. The antenna is a broadband antenna, and its height is varied from one meter to four meters above the ground to determine the maximum value of the field strength. Both horizontal and vertical polarizations of the antenna are set to make the measurement.
- d. For each suspected emission, the EUT was arranged to its worst case and then the antenna was tuned to heights from 1 meter to 4 meters and the rotatable table was turned from 0 degrees to 360 degrees to find the maximum reading.
- e. The test-receiver system was set to Peak Detect Function and Specified Bandwidth with Maximum Hold Mode.
- f. If the emission level of the EUT in peak mode was 10dB lower than the limit specified, then testing could be stopped and the peak values of the EUT would be reported. Otherwise the emissions that did not have 10dB margin would be re-tested one by one using peak, quasi-peak or average method as specified and then reported in a data sheet.

NOTE:

1. The resolution bandwidth and video bandwidth of test receiver/spectrum analyzer is 120kHz for Peak detection (PK) and Quasi-peak detection (QP) at frequency below 1GHz.
2. The resolution bandwidth and video bandwidth of test receiver/spectrum analyzer is 1 MHz for Peak detection at frequency above 1GHz.
3. The resolution bandwidth of test receiver/spectrum analyzer is 1 MHz and the video bandwidth is 10 Hz for Average detection (AV) at frequency above 1GHz.

5.2.4 DEVIATION FROM TEST STANDARD

No deviation

5.2.5 TEST SETUP

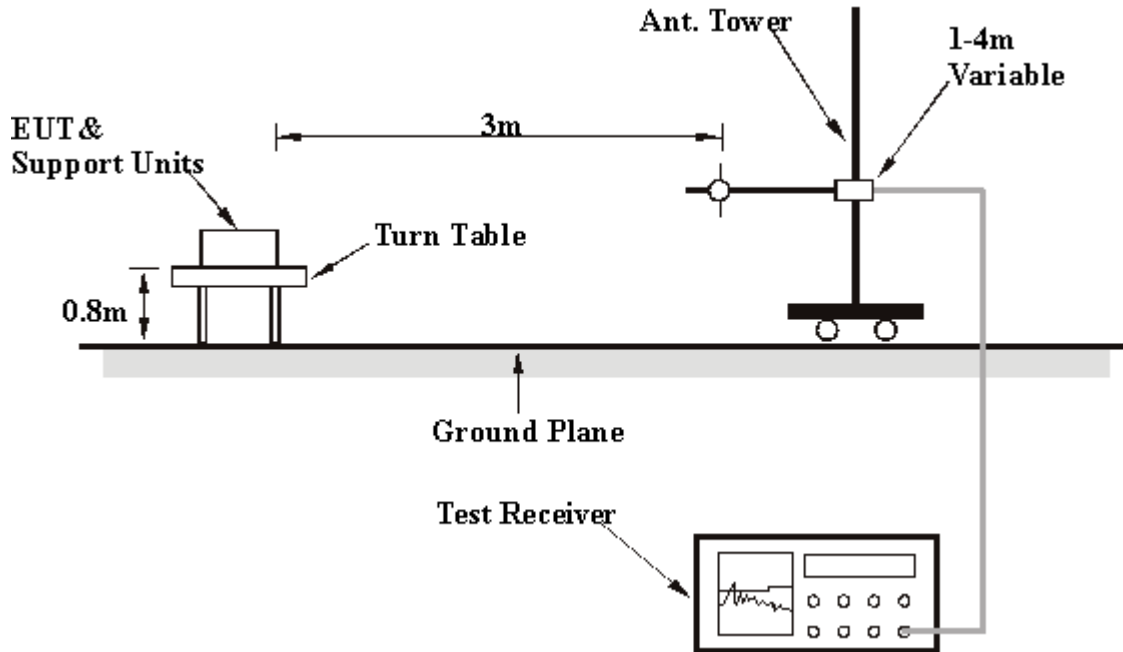

For the actual test configuration, please refer to the related item – Photographs of the Test Configuration.

5.2.6 EUT OPERATING CONDITIONS

Same as 4.1.6



5.2.7 TEST RESULTS

Below 1GHz Worst-Case Data

EUT	Notebook	MODEL	600
CHANNEL	Channel 3	FREQUENCY RANGE	Below 1000MHz
MODULATION TYPE	BPSK	TRANSFER RATE	6Mbps
INPUT POWER (SYSTEM)	120Vac, 60 Hz	DETECTOR FUNCTION	Quasi-Peak
ENVIRONMENTAL CONDITIONS	20deg. C, 61%RH, 991hPa	TESTED BY	Brad Wu

ANTENNA POLARITY & TEST DISTANCE: HORIZONTAL AT 3 M								
No.	Freq. (MHz)	Emission Level (dBuV/m)	Limit (dBuV/m)	Margin (dB)	Antenna Height (m)	Table Angle (Degree)	Raw Value (dBuV)	Correction Factor (dB/m)
1	173.85	30.44 QP	43.50	-13.06	2.00 H	88	16.91	13.53
2	208.84	30.63 QP	43.50	-12.87	2.00 H	67	19.16	11.47
3	300.20	30.43 QP	46.00	-15.57	1.00 H	265	16.01	14.41
4	366.29	29.61 QP	46.00	-16.39	1.00 H	322	13.69	15.91
5	399.34	33.11 QP	46.00	-12.89	2.00 H	331	16.40	16.71
6	599.56	32.30 QP	46.00	-13.70	3.00 H	358	11.48	20.82

ANTENNA POLARITY & TEST DISTANCE: VERTICAL AT 3 M								
No.	Freq. (MHz)	Emission Level (dBuV/m)	Limit (dBuV/m)	Margin (dB)	Antenna Height (m)	Table Angle (Degree)	Raw Value (dBuV)	Correction Factor (dB/m)
1	80.54	30.24 QP	40.00	-9.76	1.00 V	31	20.35	9.88
2	166.07	31.07 QP	43.50	-12.43	1.00 V	184	16.75	14.32
3	397.39	32.66 QP	46.00	-13.34	2.00 V	193	15.99	16.67
4	597.62	36.69 QP	46.00	-9.31	1.00 V	220	15.93	20.76
5	914.47	34.49 QP	46.00	-11.51	4.00 V	115	9.53	24.96
6	945.57	33.69 QP	46.00	-12.31	1.00 V	259	8.40	25.28

- REMARKS:**
1. Emission level(dBuV/m)=Raw Value(dBuV) + Correction Factor(dB/m)
 2. Correction Factor(dB/m) = Antenna Factor (dB/m) + Cable Factor (dB)
 3. The other emission levels were very low against the limit.
 4. Margin value = Emission level – Limit value

**802.11a OFDM modulation**

EUT	Notebook	MODEL	600
CHANNEL	Channel 1	FREQUENCY RANGE	1 ~ 40 GHz
MODULATION TYPE	BPSK	TRANSFER RATE	6Mbps
INPUT POWER (SYSTEM)	120Vac, 60 Hz	DETECTOR FUNCTION	Peak(PK) Average (AV)
ENVIRONMENTAL CONDITIONS	23deg. C, 65%RH, 991hPa	TESTED BY	Brad Wu

ANTENNA POLARITY & TEST DISTANCE: HORIZONTAL AT 3 M

No.	Freq. (MHz)	Emission Level (dBuV/m)	Limit (dBuV/m)	Margin (dB)	Antenna Height (m)	Table Angle (Degree)	Raw Value (dBuV)	Correction Factor (dB/m)
1	2136.00	43.59 PK	74.00	-30.41	1.20 H	150	12.73	30.86
1	2136.00	35.92 AV	54.00	-18.08	1.20 H	150	5.06	30.86
2	5715.00	55.23 PK	74.00	-18.77	1.30 H	0	15.80	39.43
3	5725.00	67.49 PK	74.00	-6.51	1.30 H	0	28.04	39.45
4	*5745.00	100.80 PK			1.30 H	0	61.32	39.48
4	*5745.00	90.50 AV			1.30 H	0	51.02	39.48
5	#11490.00	62.58 PK	74.00	-11.42	1.06 H	156	11.87	50.71
5	#11490.00	49.71 AV	54.00	-4.29	1.06 H	156	-1.00	50.71

ANTENNA POLARITY & TEST DISTANCE: VERTICAL AT 3 M

No.	Freq. (MHz)	Emission Level (dBuV/m)	Limit (dBuV/m)	Margin (dB)	Antenna Height (m)	Table Angle (Degree)	Raw Value (dBuV)	Correction Factor (dB/m)
1	#2136.00	44.62 PK	74.00	-29.38	1.05 V	95	13.76	30.86
1	#2136.00	39.11 AV	54.00	-14.89	1.05 V	95	8.25	30.86
2	5715.00	55.71 PK	74.00	-18.29	1.41 V	265	16.28	39.43
3	5725.00	67.97 PK	74.00	-6.03	1.41 V	265	28.52	39.45
4	*5745.00	101.28 PK			1.41 V	265	61.80	39.48
4	*5745.00	91.24 AV			1.41 V	265	51.76	39.48
5	#11490.00	62.04 PK	74.00	-11.96	1.00 V	143	11.33	50.71
5	#11490.00	49.04 AV	54.00	-4.96	1.00 V	143	-1.67	50.71

- NOTE:**
1. Emission level(dBuV/m)=Raw Value(dBuV) + Correction Factor(dB/m)
 2. Correction Factor(dB/m) = Antenna Factor (dB/m) + Cable Factor (dB)
 3. The other emission levels were very low against the limit.
 4. Margin value = Emission level – Limit value
 5. "*" : Fundamental frequency
 6. "#":The radiated frequency falling in the restricted band.
 7. The limit value is defined as per 15.247



EUT	Notebook	MODEL	600
CHANNEL	Channel 3	FREQUENCY RANGE	1 ~ 40 GHz
MODULATION TYPE	BPSK	TRANSFER RATE	6Mbps
INPUT POWER (SYSTEM)	120Vac, 60 Hz	DETECTOR FUNCTION	Peak(PK) Average (AV)
ENVIRONMENTAL CONDITIONS	23deg. C, 65%RH, 991hPa	TESTED BY	Brad Wu

ANTENNA POLARITY & TEST DISTANCE: HORIZONTAL AT 3 M

No.	Freq. (MHz)	Emission Level (dBuV/m)	Limit (dBuV/m)	Margin (dB)	Antenna Height (m)	Table Angle (Degree)	Raw Value (dBuV)	Correction Factor (dB/m)
1	2136.00	43.56 PK	74.00	-30.44	1.06 H	211	12.70	30.86
1	2136.00	35.71 AV	54.00	-18.29	1.06 H	211	4.85	30.86
2	*5785.00	100.43 PK			1.28 H	359	60.88	39.55
2	*5785.00	90.47 AV			1.28 H	359	50.92	39.55
3	#11570.00	60.87 PK	74.00	-13.13	1.03 H	192	10.22	50.65
3	#11570.00	48.99 AV	54.00	-5.01	1.03 H	192	-1.66	50.65

ANTENNA POLARITY & TEST DISTANCE: VERTICAL AT 3 M

No.	Freq. (MHz)	Emission Level (dBuV/m)	Limit (dBuV/m)	Margin (dB)	Antenna Height (m)	Table Angle (Degree)	Raw Value (dBuV)	Correction Factor (dB/m)
1	2136.00	44.10 PK	74.00	-29.90	1.09 V	163	13.24	30.86
1	2136.00	38.41 AV	54.00	-15.59	1.09 V	163	7.55	30.86
2	*5785.00	101.11 PK			1.48 V	261	61.56	39.55
2	*5785.00	91.13 AV			1.48 V	261	51.58	39.55
3	#11570.00	60.62 PK	74.00	-13.38	1.12 V	124	9.97	50.65
3	#11570.00	48.41 AV	54.00	-5.59	1.12 V	124	-2.23	50.65

- NOTE:**
1. Emission level(dBuV/m)=Raw Value(dBuV) + Correction Factor(dB/m)
 2. Correction Factor(dB/m) = Antenna Factor (dB/m) + Cable Factor (dB)
 3. The other emission levels were very low against the limit.
 4. Margin value = Emission level – Limit value
 5. "*" : Fundamental frequency
 6. "#"The radiated frequency falling in the restricted band.
 7. The limit value is defined as per 15.247



EUT	Notebook	MODEL	600
CHANNEL	Channel 5	FREQUENCY RANGE	1 ~ 40 GHz
MODULATION TYPE	BPSK	TRANSFER RATE	6Mbps
INPUT POWER (SYSTEM)	120Vac, 60 Hz	DETECTOR FUNCTION	Peak(PK) Average (AV)
ENVIRONMENTAL CONDITIONS	23deg. C, 65%RH, 991hPa	TESTED BY	Brad Wu

ANTENNA POLARITY & TEST DISTANCE: HORIZONTAL AT 3 M

No.	Freq. (MHz)	Emission Level (dBuV/m)	Limit (dBuV/m)	Margin (dB)	Antenna Height (m)	Table Angle (Degree)	Raw Value (dBuV)	Correction Factor (dB/m)
1	2136.00	43.61 PK	74.00	-30.39	1.09 H	253	12.75	30.86
1	2136.00	35.82 AV	54.00	-18.18	1.09 H	253	4.96	30.86
2	*5825.00	99.48 PK			1.13 H	0	59.90	39.58
2	*5825.00	89.47 AV			1.13 H	0	49.89	39.58
3	5850.00	57.47 PK	74.00	-16.53	1.13 H	0	17.88	39.59
4	#11610.00	61.72 PK	74.00	-12.28	1.05 H	136	11.10	50.61
4	#11610.00	48.63 AV	54.00	-5.37	1.05 H	136	-1.99	50.61

ANTENNA POLARITY & TEST DISTANCE: VERTICAL AT 3 M

No.	Freq. (MHz)	Emission Level (dBuV/m)	Limit (dBuV/m)	Margin (dB)	Antenna Height (m)	Table Angle (Degree)	Raw Value (dBuV)	Correction Factor (dB/m)
1	2136.00	43.88 PK	74.00	-30.12	1.15 V	193	13.02	30.86
1	2136.00	39.10 AV	54.00	-14.90	1.15 V	193	8.24	30.86
2	*5825.00	100.69 PK			1.40 V	260	61.11	39.58
2	*5825.00	90.80 AV			1.40 V	260	51.22	39.58
3	5850.00	58.68 PK	74.00	-15.32	1.40 V	260	19.09	39.59
4	#11610.00	61.40 PK	74.00	-12.60	1.14 V	207	10.78	50.61
4	#11610.00	48.48 AV	54.00	-5.52	1.14 V	207	-2.14	50.61

- NOTE:**
1. Emission level(dBuV/m)=Raw Value(dBuV) + Correction Factor(dB/m)
 2. Correction Factor(dB/m) = Antenna Factor (dB/m) + Cable Factor (dB)
 3. The other emission levels were very low against the limit.
 4. Margin value = Emission level – Limit value
 5. "*" : Fundamental frequency
 6. "#"The radiated frequency falling in the restricted band.
 7. The limit value is defined as per 15.247



5.3 6dB BANDWIDTH MEASUREMENT

5.3.1 LIMITS OF 6dB BANDWIDTH MEASUREMENT

The minimum of 6dB Bandwidth Measurement is 0.5 MHz.

5.3.2 TEST INSTRUMENTS

Description & Manufacturer	Model No.	Serial No.	Calibrated Until
R&S SPECTRUM ANALYZER	FSEK30	100049	Aug. 12, 2005

NOTES: The calibration interval of the above test instruments is 12 months and the calibrations are traceable to NML/ROC and NIST/USA.

5.3.3 TEST PROCEDURE

The transmitter output was connected to the spectrum analyzer through an attenuator. The bandwidth of the fundamental frequency was measured by spectrum analyzer with 100kHz RBW and 100kHz VBW. The 6dB bandwidth is defined as the total spectrum the power of which is higher than peak power minus 6dB.

5.3.4 DEVIATION FROM TEST STANDARD

No deviation

5.3.5 TEST SETUP

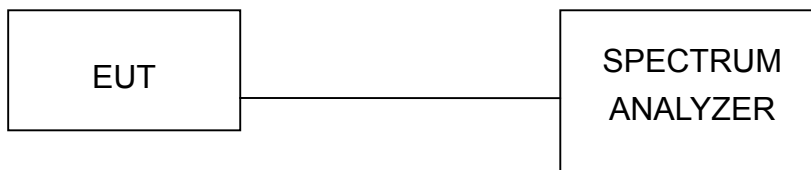

5.3.6 EUT OPERATING CONDITIONS

The software provided by client to enable the EUT under transmission condition continuously at lowest, middle and highest channel frequencies individually.



5.3.7 TEST RESULTS

802.11a OFDM modulation

EUT	Notebook	MODEL	600
MODULATION TYPE	BPSK	TRANSFER RATE	6Mbps
INPUT POWER (SYSTEM)	120Vac, 60 Hz	ENVIRONMENTAL CONDITIONS	23deg. C, 61%RH, 991 hPa
TESTED BY	Gary Chang		

CHANNEL	CHANNEL FREQUENCY (MHz)	6dB BANDWIDTH (MHz)	MINIMUM LIMIT (MHz)	PASS/FAIL
1	5745	16.32	0.5	PASS
3	5785	16.28	0.5	PASS
5	5825	16.32	0.5	PASS



CH 1

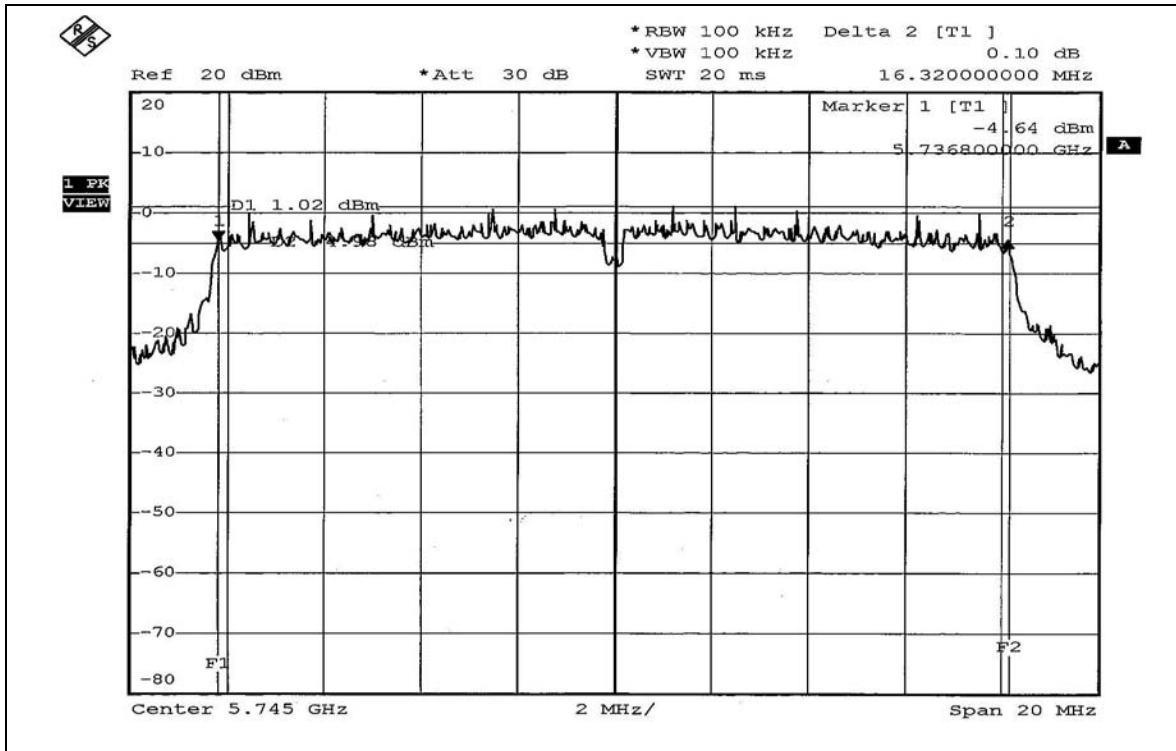

CH 3

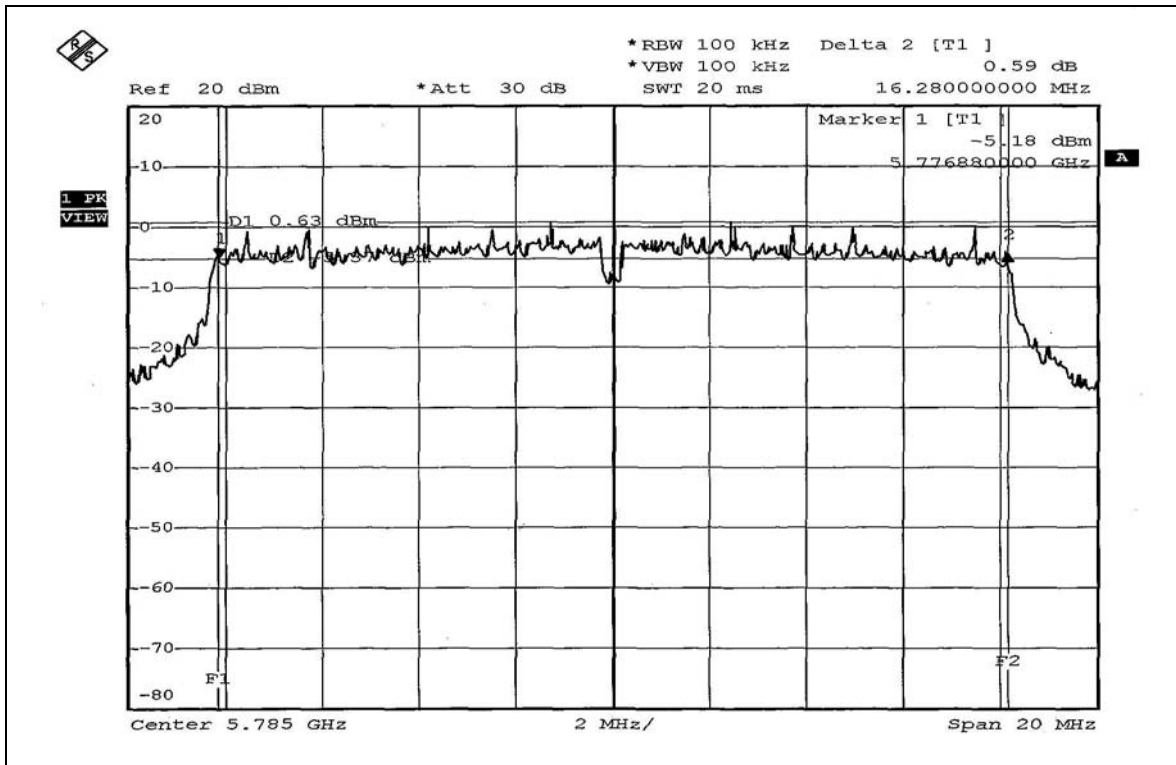



CH 5

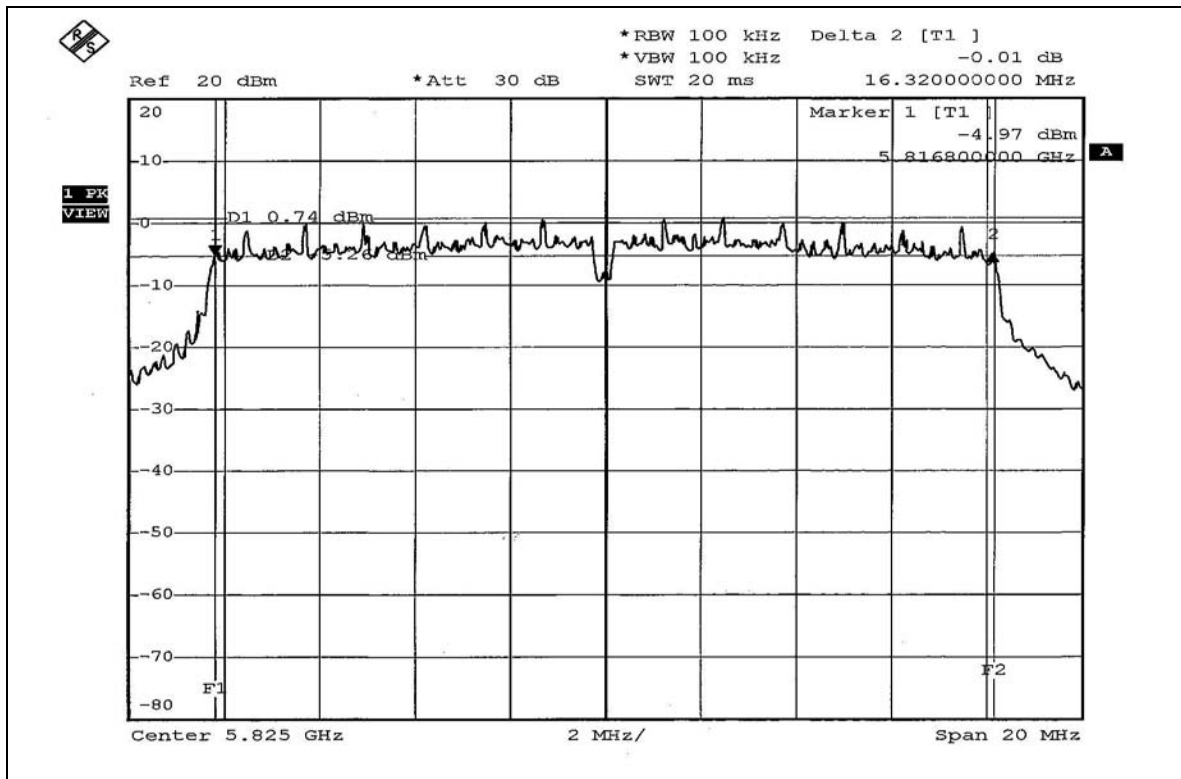



5.4 MAXIMUM PEAK OUTPUT POWER

5.4.1 LIMITS OF MAXIMUM PEAK OUTPUT POWER MEASUREMENT

The Maximum Peak Output Power Measurement is 30dBm.

5.4.2 INSTRUMENTS

Description & Manufacturer	Model No.	Serial No.	Calibrated Until
R&S SPECTRUM ANALYZER	FSEK30	100049	Aug. 12, 2005
AGILENT SIGNAL GENERATOR	E8257C	MY43320668	Dec. 06, 2005
TEKTRONIX OSCILLOSCOPE	TDS1012	C037299	Dec. 07, 2005
NARDA DETECTOR	4503A	FSCM99899	NA

NOTE:

The calibration interval of the above test instruments is 12 months and the calibrations are traceable to NML/ROC and NIST/USA.

5.4.3 TEST PROCEDURES

1. A detector was used on the output port of the EUT. An oscilloscope was used to read the response of the detector.
2. Replaced the EUT by the signal generator. The center frequency of the S.G was adjusted to the center frequency of the measured channel.
3. Adjusted the power to have the same reading on oscilloscope. Record the power level.

5.4.4 DEVIATION FROM TEST STANDARD

No deviation

5.4.5 TEST SETUP



5.4.6 EUT OPERATING CONDITIONS

Same as Item 5.3.6



5.4.7 TEST RESULTS

802.11a OFDM modulation

EUT	Notebook	MODEL	600
MODULATION TYPE	BPSK	TRANSFER RATE	6Mbps
INPUT POWER (SYSTEM)	120Vac, 60 Hz	ENVIRONMENTAL CONDITIONS	23deg. C, 61%RH, 991 hPa
TESTED BY	Gary Chang		

CHANNEL	CHANNEL FREQUENCY (MHz)	PEAK POWER OUTPUT (mW)	PEAK POWER OUTPUT (dBm)	PEAK POWER LIMIT (dBm)	PASS/FAIL
1	5745	40.365	16.06	30	PASS
3	5785	39.994	16.02	30	PASS
5	5825	39.902	16.01	30	PASS



5.5 POWER SPECTRAL DENSITY MEASUREMENT

5.5.1 LIMITS OF POWER SPECTRAL DENSITY MEASUREMENT

The Maximum of Power Spectral Density Measurement is 8dBm.

5.5.2 TEST INSTRUMENTS

Description & Manufacturer	Model No.	Serial No.	Calibrated Until
R&S SPECTRUM ANALYZER	FSEK30	100049	Aug. 12, 2005

NOTES:

The calibration interval of the above test instruments is 12 months and the calibrations are traceable to NML/ROC and NIST/USA.

5.5.3 TEST PROCEDURE

The transmitter output was connected to the spectrum analyzer through an attenuator, the bandwidth of the fundamental frequency was measured with the spectrum analyzer using 3 kHz RBW and 30 kHz VBW, set sweep time = span/3 kHz. The power spectral density was measured and recorded.

The sweep time is allowed to be longer than span/3 kHz for a full response of the mixer in the spectrum analyzer.

5.5.4 DEVIATION FROM TEST STANDARD

No deviation

5.5.5 TEST SETUP

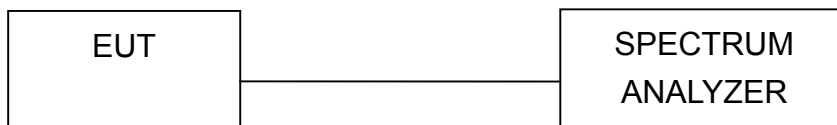

5.5.6 EUT OPERATING CONDITION

Same as Item 5.3.6



5.5.7 TEST RESULTS

802.11a OFDM modulation

EUT	Notebook	MODEL	600
MODULATION TYPE	BPSK	TRANSFER RATE	6Mbps
INPUT POWER (SYSTEM)	120Vac, 60 Hz	ENVIRONMENTAL CONDITIONS	23deg. C, 61%RH, 991 hPa
TESTED BY	Gary Chang		

CHANNEL	CHANNEL FREQUENCY (MHz)	RF POWER LEVEL IN 3 kHz BW (dBm)	MAXIMUM LIMIT (dBm)	PASS/FAIL
1	5745	-14.10	8	PASS
3	5785	-14.17	8	PASS
5	5825	-14.24	8	PASS



CH1

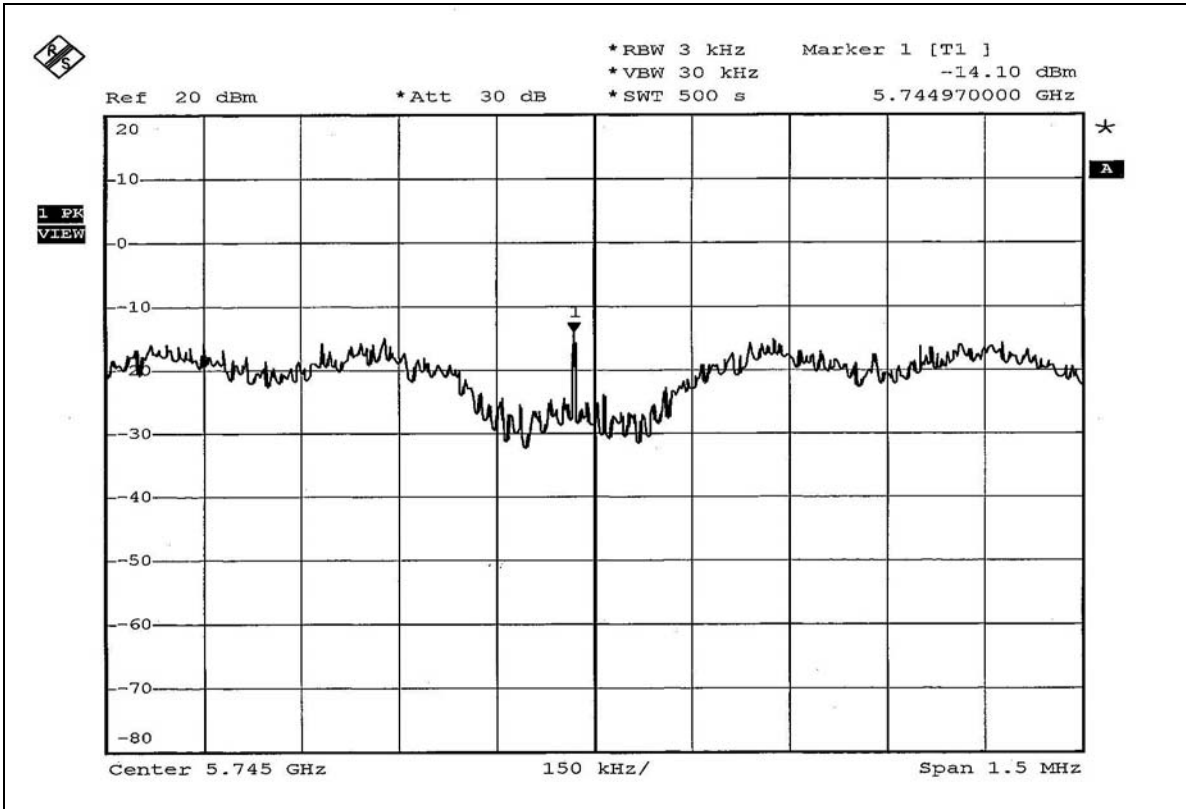

CH3

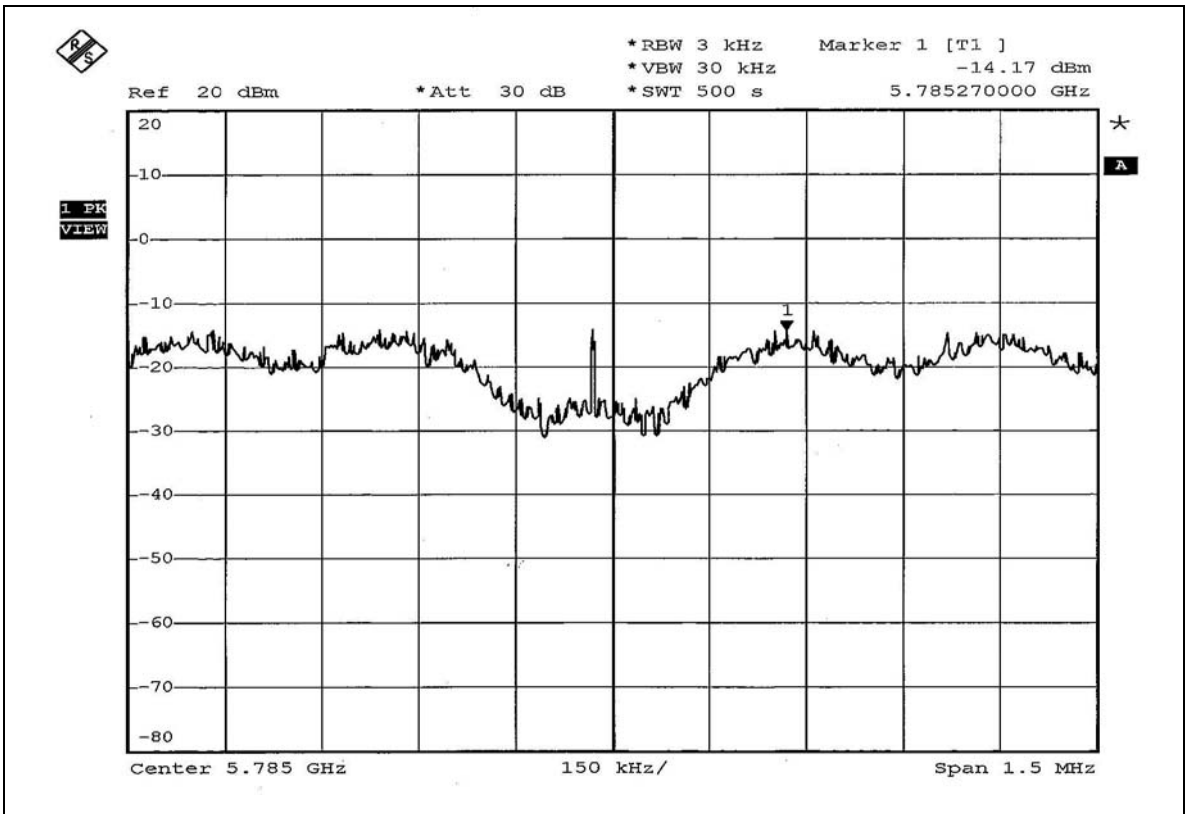



CH5

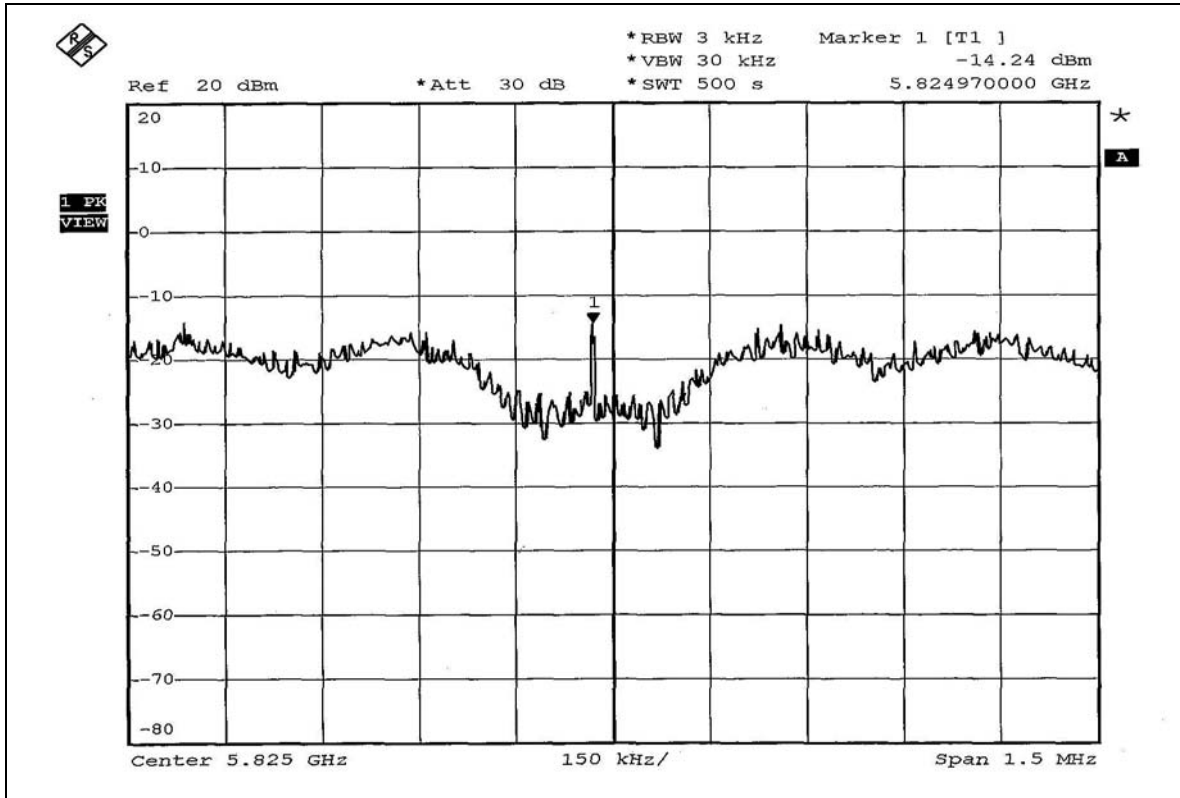

5.6 BAND EDGES MEASUREMENT

5.6.1 LIMITS OF BAND EDGES MEASUREMENT

Below -20dB of the highest emission level of operating band (in 100kHz Resolution Bandwidth).

5.6.2 TEST INSTRUMENTS

Description & Manufacturer	Model No.	Serial No.	Calibrated Until
R&S SPECTRUM ANALYZER	FSEK30	100049	Aug. 12, 2005

NOTES:

The calibration interval of the above test instruments is 12 months and the calibrations are traceable to NML/ROC and NIST/USA.

5.6.3 TEST PROCEDURE

The transmitter output was connected to the spectrum analyzer via a low lose cable. Set both RBW and VBW of spectrum analyzer to 100 kHz with suitable frequency span including 100 MHz bandwidth from band edge. The band edges was measured and recorded.

5.6.4 DEVIATION FROM TEST STANDARD

No deviation



5.6.5 EUT OPERATING CONDITION

Same as Item 5.3.6

5.6.6 TEST RESULTS

The spectrum plots are attached on the following pages. D2 line indicates the highest level, D1 line indicates the 20dB offset below D2. It shows compliance with the requirement in part 15.247(d).



802.11a OFDM modulation

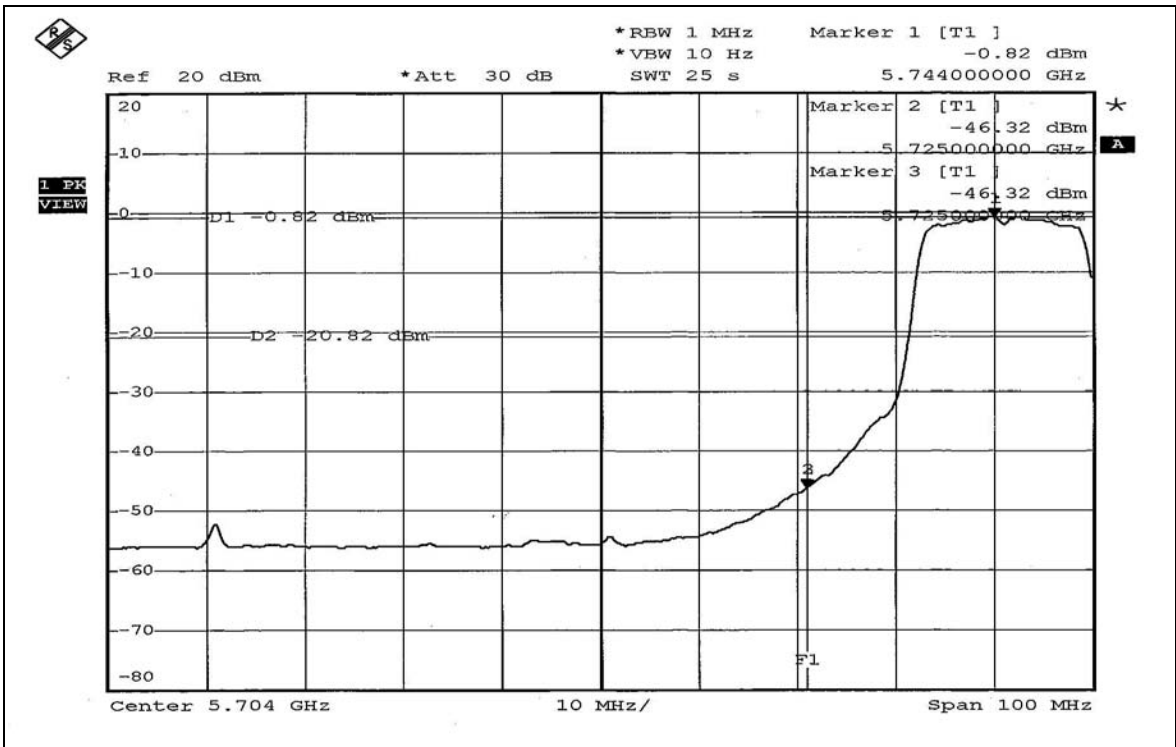
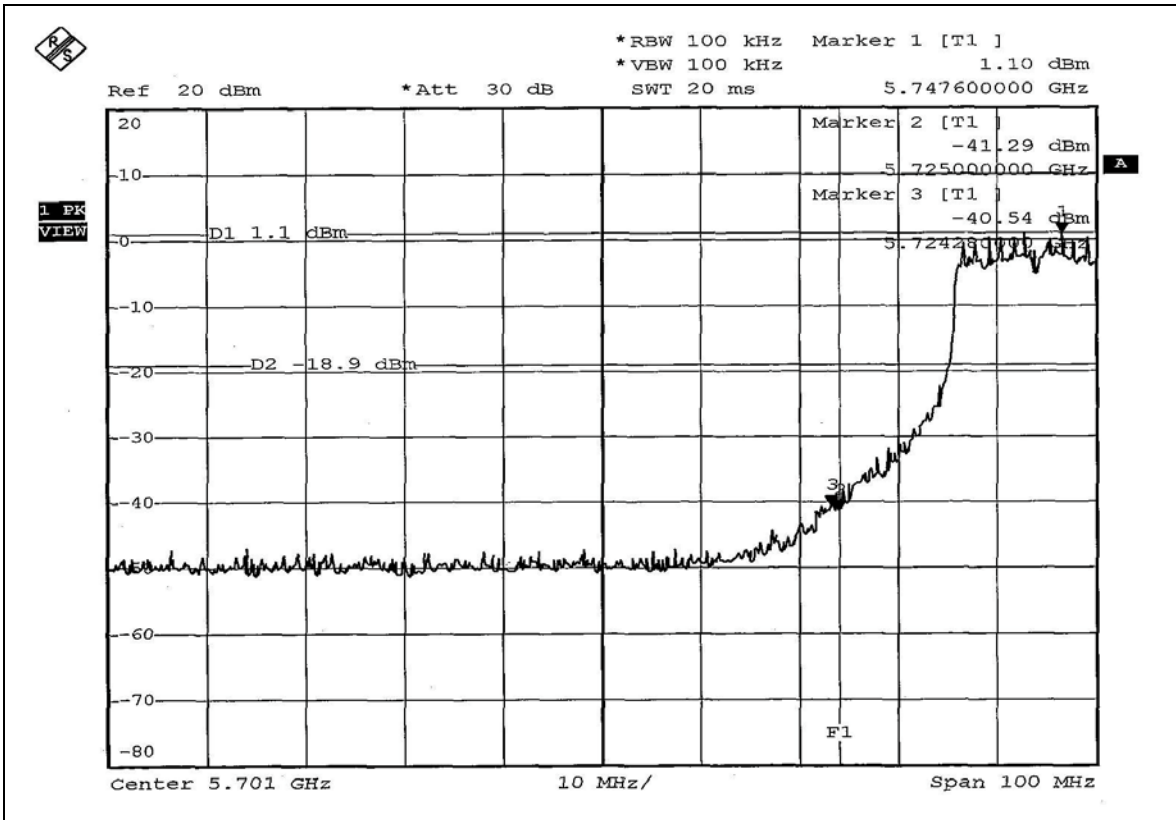

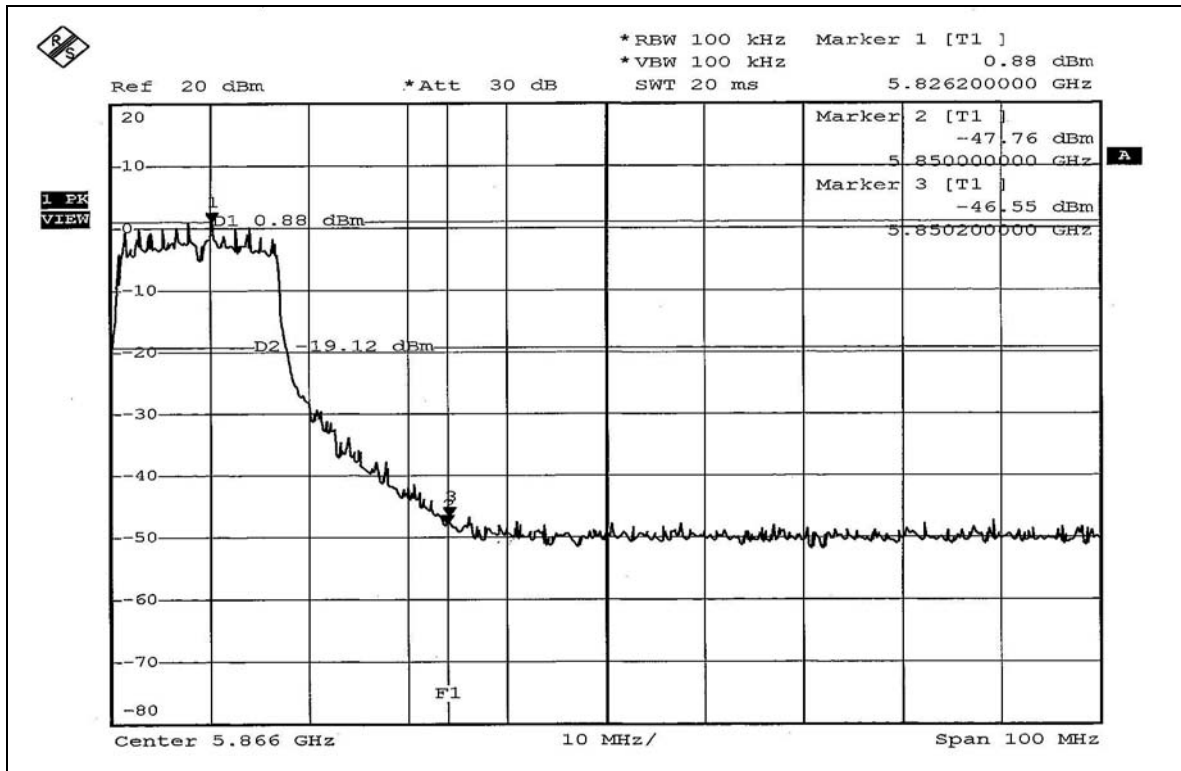
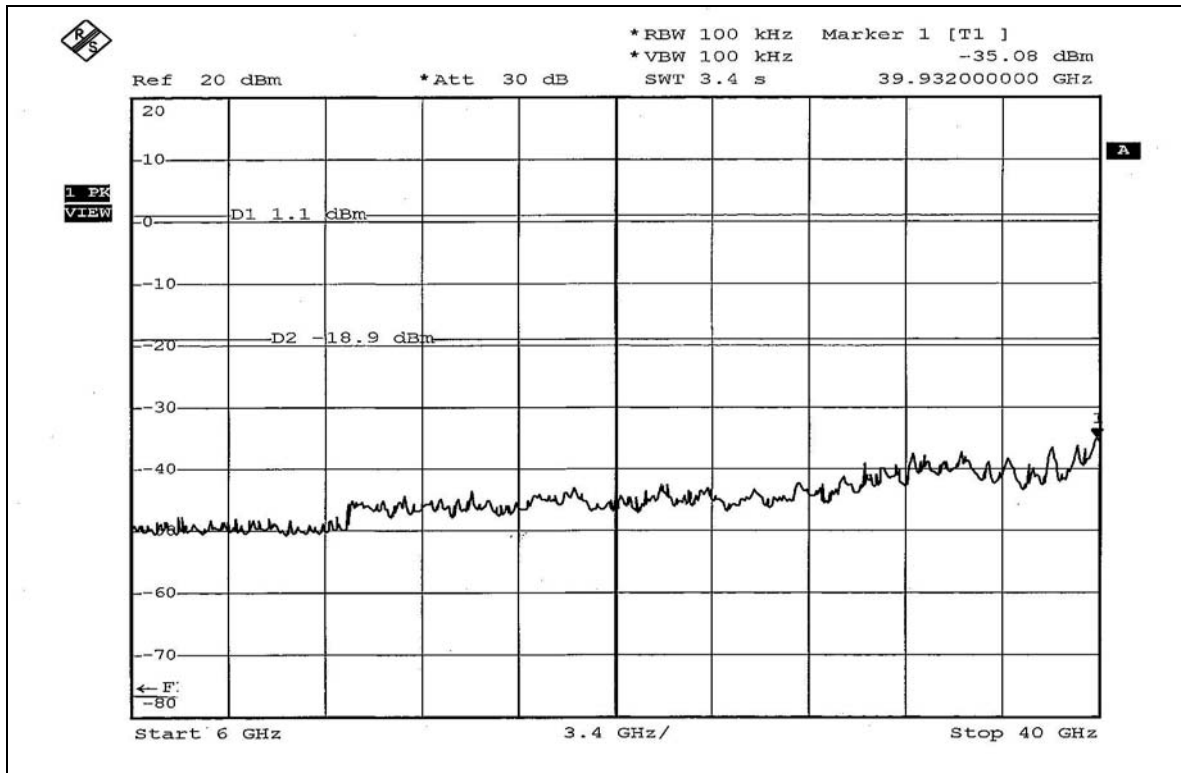

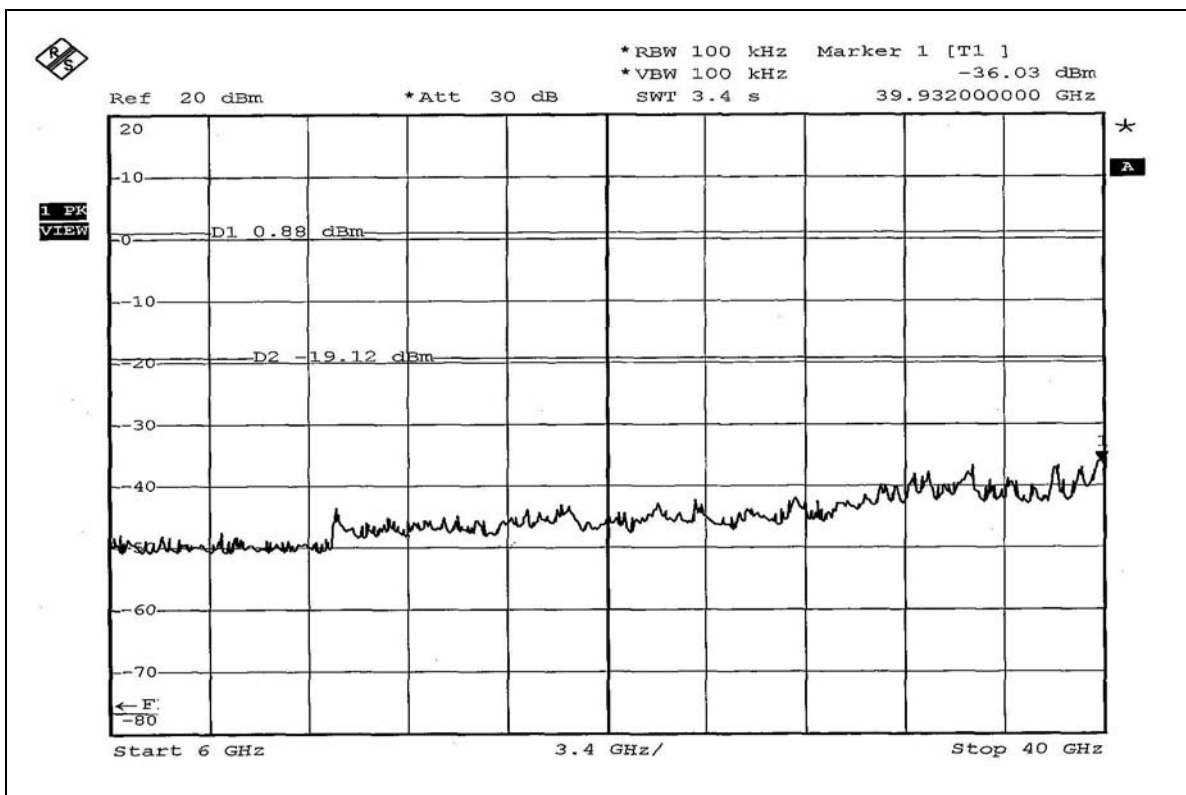
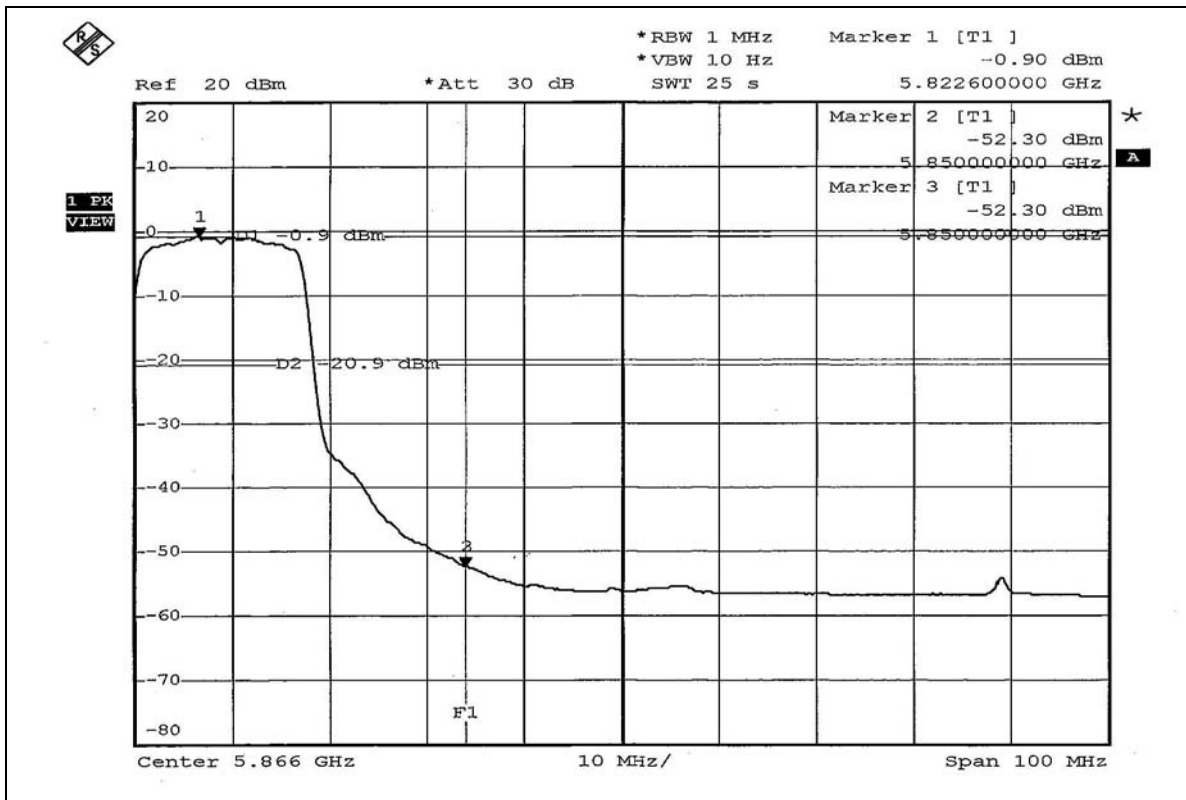



5.7 ANTENNA REQUIREMENT

5.7.1 STANDARD APPLICABLE

For intentional device, according to FCC 47 CFR Section 15.203, an intentional radiator shall be designed to ensure that no antenna other than that furnished by the responsible party shall be used with the device.

And according to FCC 47 CFR Section 15.247(a), if transmitting antennas of directional gain greater than 6dBi are used, the power shall be reduced by the amount in dB that the directional gain of the antenna exceeds 6dBi.

5.7.2 ANTENNA CONNECTED CONSTRUCTION

The antenna used in this product is PIFA antenna with UFL antenna connector. The maximum Gain of the antenna is -4.39dBi .

6. PHOTOGRAPHS OF THE TEST CONFIGURATION

CONDUCTED EMISSION TEST



RADIATED EMISSION TEST

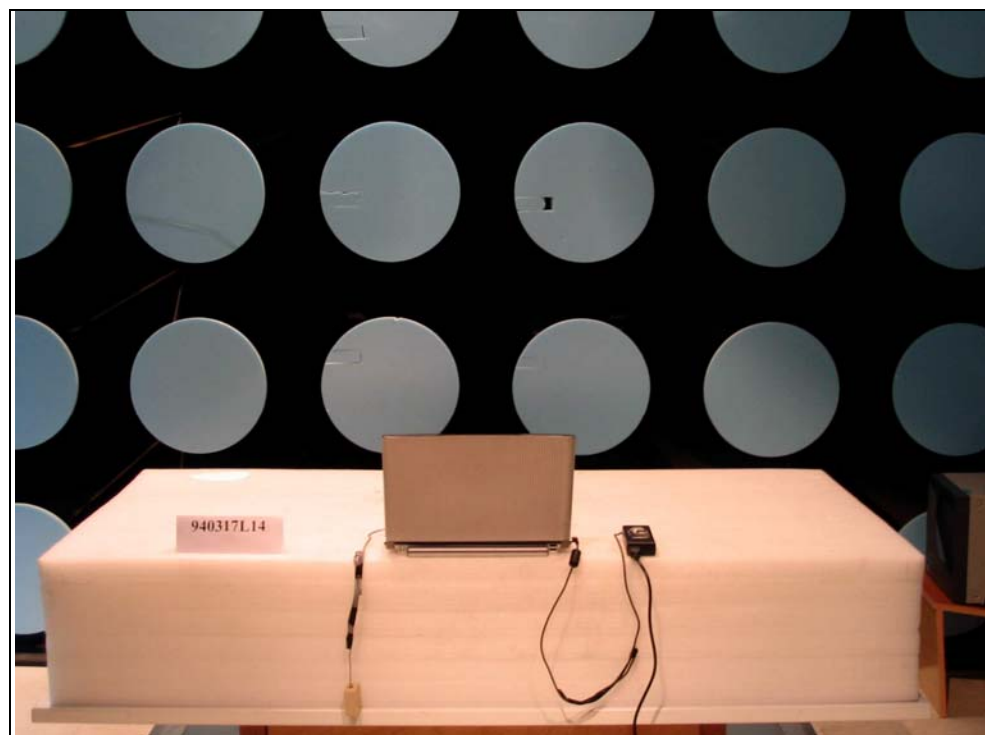
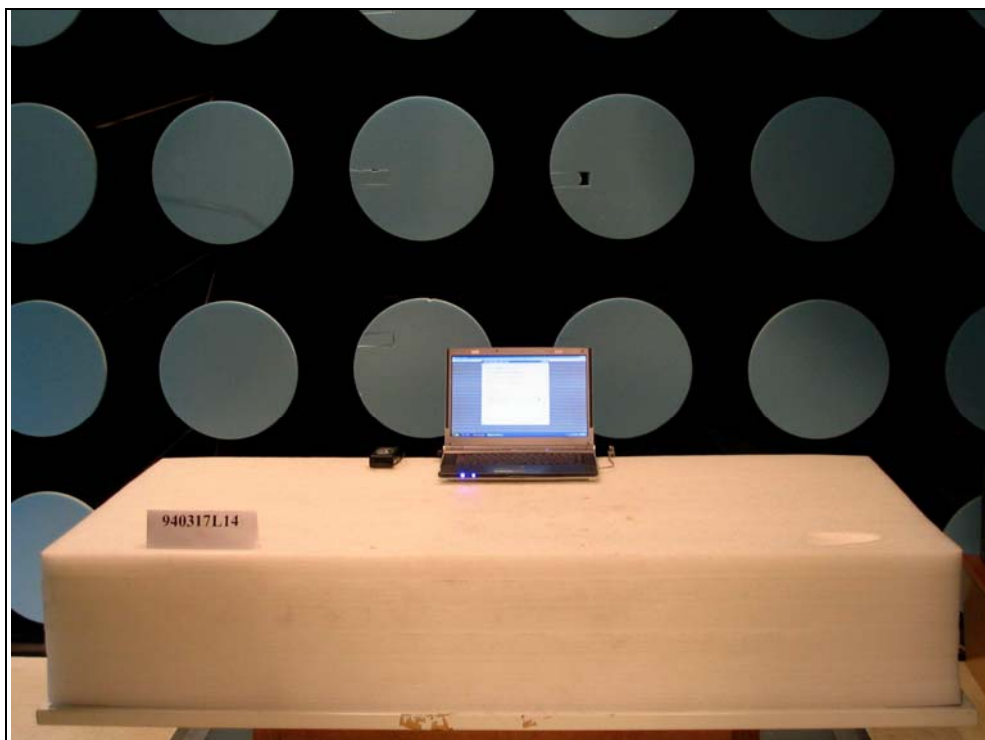



7. INFORMATION ON THE TESTING LABORATORIES

We, ADT Corp., were founded in 1988 to provide our best service in EMC, Radio, Telecom and Safety consultation. Our laboratories are accredited and approved by the following approval agencies according to ISO/IEC 17025.

USA	FCC, NVLAP, UL, A2LA
Germany	TUV Rheinland
Japan	VCCI
Norway	NEMKO
Canada	INDUSTRY CANADA , CSA
R.O.C.	CNLA, BSMI, DGT
Netherlands	Telefication
Singapore	PSB , GOST-ASIA(MOU)
Russia	CERTIS(MOU)

Copies of accreditation certificates of our laboratories obtained from approval agencies can be downloaded from our web site:

www.adt.com.tw/index.5/phtml. If you have any comments, please feel free to contact us at the following:

Linko EMC/RF Lab:

Tel: 886-2-26052180

Fax: 886-2-26052943

Hsin Chu EMC/RF Lab:

Tel: 886-3-5935343

Fax: 886-3-5935342

Hwa Ya EMC/RF/Safety Telecom Lab:

Tel: 886-3-3183232

Fax: 886-3-3185050

Linko RF Lab.

Tel: 886-3-3270910

Fax: 886-3-3270892

Web Site: www.adt.com.tw

The address and road map of all our labs can be found in our web site also