



**FCC CFR47 PART 15 SUBPART E
CERTIFICATION**

TEST REPORT

FOR

TRUE MIMO ACCESS POINT

MODEL NUMBER: AGN1202AP

FCC ID: SA3-AGN1202AP0000

REPORT NUMBER: 04U2821-3

ISSUE DATE:

Prepared for

**AIRGO NETWORKS INC
900 ARASTRADERO ROAD
PALO ALTO, CA 94304, USA**

Prepared by

**COMPLIANCE CERTIFICATION SERVICES
561F MONTEREY ROAD,
MORGAN HILL, CA 95037, USA
TEL: (408) 463-0885
FAX: (408) 463-0888**



TABLE OF CONTENTS

1. TEST RESULT CERTIFICATION	3
2. EUT DESCRIPTION	4
3. TEST METHODOLOGY	5
4. FACILITIES AND ACCREDITATION	5
5. CALIBRATION AND UNCERTAINTY	6
5.1. <i>MEASURING INSTRUMENT CALIBRATION</i>	6
5.2. <i>MEASUREMENT UNCERTAINTY</i>	6
5.3. <i>TEST AND MEASUREMENT EQUIPMENT</i>	7
6. SETUP OF EQUIPMENT UNDER TEST	8
7. APPLICABLE LIMITS AND TEST RESULTS	10
7.1. <i>EMISSION BANDWIDTH</i>	10
7.2. <i>PEAK POWER</i>	14
7.3. <i>MAXIMUM PERMISSIBLE EXPOSURE</i>	19
7.4. <i>AVERAGE POWER</i>	22
7.5. <i>PEAK POWER SPECTRAL DENSITY</i>	23
7.6. <i>PEAK EXCURSION</i>	28
7.7. <i>CONDUCTED SPURIOUS EMISSIONS</i>	32
7.8. <i>RADIATED EMISSIONS</i>	40
7.8.1. <i>TRANSMITTER RADIATED SPURIOUS EMISSIONS</i>	40
7.8.2. <i>TRANSMITTER RADIATED EMISSIONS ABOVE 1 GHZ</i>	43
7.8.3. <i>WORST-CASE RADIATED EMISSIONS BELOW 1 GHz</i>	52
7.9. <i>POWERLINE CONDUCTED EMISSIONS</i>	56
8. SETUP PHOTOS	60

1. TEST RESULT CERTIFICATION

COMPANY NAME: AIRGO NETWORKS INC
900 ARASTRADERO ROAD
PALO ALTO CA 94304 U.S.A.

EUT DESCRIPTION: True MIMO Access Point

MODEL: AGN1202AP

DATE TESTED: July 7, 2004 to July 23, 2004

APPLICABLE STANDARDS	
STANDARD	TEST RESULTS
FCC PART 15 SUBPART E	NO NON-COMPLIANCE NOTED



Compliance Certification Services, Inc. tested the above equipment in accordance with the requirements set forth in the above standards. The test results show that the equipment tested is capable of demonstrating compliance with the requirements as documented in this report.

Note: This document reports conditions under which testing was conducted and results of tests performed. This document may not be altered or revised in any way unless done so by Compliance Certification Services and all revisions are duly noted in the revisions section. Any alteration of this document not carried out by Compliance Certification Services will constitute fraud and shall nullify the document.

Note: The 5.2 GHz band is applicable to this report; other bands of operation (2.4 and 5.8 GHz) are documented in a separate report.

Approved & Released For CCS By:

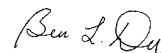
Tested By:



MIKE HECKROTTE
EMC MANAGER
COMPLIANCE CERTIFICATION SERVICES

BEN DU
EMC ENGINEER
COMPLIANCE CERTIFICATION SERVICES

2. EUT DESCRIPTION

The EUT is an 802.11a/b/g Access Point employs two transmitters and three receivers on each of two radio cards.

The transmitter has a maximum peak conducted output power as follows:

5150 to 5250 MHz Authorized Band

Frequency Band (MHz)	Mode	Output Power (dBm)	Output Power (mW)
5180 - 5250	802.11a	13.22	20.99

5250 to 5350 MHz Authorized Band

Frequency Band (MHz)	Mode	Output Power (dBm)	Output Power (mW)
5250 - 5320	802.11a	17.93	62.09

The radio utilizes five identical external dipole antennas for diversity, each with a maximum gain of 3dBi.

3. TEST METHODOLOGY

The tests documented in this report were performed in accordance with ANSI C63.4/2001, FCC CFR 47 Part 2 and FCC CFR 47 Part 15.

4. FACILITIES AND ACCREDITATION

The test sites and measurement facilities used to collect data are located at 561F Monterey Road, Morgan Hill, California, USA. The sites are constructed in conformance with the requirements of ANSI C63.4, ANSI C63.7 and CISPR Publication 22. All receiving equipment conforms to CISPR Publication 16-1, "Radio Interference Measuring Apparatus and Measurement Methods."

CCS is accredited by NVLAP, Laboratory Code 200065-0. The full scope of accreditation can be viewed at <http://www.ccsemc.com>.



No part of this report may be used to claim or imply product endorsement by NVLAP or any agency of the US Government.

5. CALIBRATION AND UNCERTAINTY

5.1. MEASURING INSTRUMENT CALIBRATION

The measuring equipment utilized to perform the tests documented in this report has been calibrated in accordance with the manufacturer's recommendations, and is traceable to recognized national standards.

5.2. MEASUREMENT UNCERTAINTY

Where relevant, the following measurement uncertainty levels have been estimated for tests performed on the apparatus:

PARAMETER	UNCERTAINTY
Radiated Emission, 30 to 200 MHz	+/- 3.3 dB
Radiated Emission, 200 to 1000 MHz	+4.5 / -2.9 dB
Radiated Emission, 1000 to 2000 MHz	+4.5 / -2.9 dB
Power Line Conducted Emission	+/- 2.9 dB

Uncertainty figures are valid to a confidence level of 95%.

5.3. TEST AND MEASUREMENT EQUIPMENT

The following test and measurement equipment was utilized for the tests documented in this report:

TEST EQUIPMENT LIST				
Description	Manufacturer	Model	Serial Number	Cal Due
EMI Receiver, 9 kHz ~ 2.9 GHz	HP	8542E	3942A00286	11/21/2004
RF Filter Section	HP	85420E	3705A00256	11/21/2004
30MHz--- 2Ghz	Sunol Sciences	JB1 Antenna	A121003	12/22/2004
LISN, 10 kHz ~ 30 MHz	FCC	50/250-25-2	114	10/13/2004
ite A Line Stabilizer / Conditione	Triplite	LC-1800a	A0051681	CNR
EMI Test Receiver	R & S	ESHS 20	827129/006	7/17/2005
AC Power Source, 10KVA	ACS	AFC-10K-AFC-2	J1568	CNR
Spectrum Analyzer	Agilent	E4446A	MY43360112	1/13/2005
AC Power Source, 8KVA	APC	AFP2-8KVA	J5061	CNR
Peak Power Meter	Agilent	E4416A	GB41291160	11/7/2004
Antenna, Horn 1 ~ 18 GHz	EMCO	3115	6717	2/4/2005
Amplifier 1-26GHz	MITEQ	NSP2600-SP	924342	4/25/2005
10dB Attenuator	WEINSCHEL	56-10	K6159	N/A
Band reject filter	Microtronics	BRC13190	1	N/A
PreAmplifier 26-40 GHz	MITEQ	NSP4000-SP2	924343	6/1/2004
Antenna, Horn 26 ~ 40 GHz	ARA	MWH-2640/B	1029	12/3/2004

6. SETUP OF EQUIPMENT UNDER TEST

SUPPORT EQUIPMENT

PERIPHERAL SUPPORT EQUIPMENT LIST				
Description	Manufacturer	Model	Serial Number	FCC ID
Laptop PC	Sony	PCG-5312	28315730 3303321	AK8JPN-35452-M5-E

I/O CABLES

I/O CABLE LIST						
Cable No.	Port	# of Identical Ports	Connector Type	Cable Type	Cable Length	Remarks
1	AC	2	US115	UNSHIELDED	2m	NO
2	DC	2	DC	UNSHIELDED	2m	NO
3	Serial	1	9 Pin	UNSHIELDED	2m	To PC USB Port
4	Ethernet	1	RJ 45	UNSHIELDED	2m	To PC RJ45 Port

TEST SETUP

The EUT was controlled by the laptop via Ethernet cable. The test software exercised the radio card during tests.

SETUP DIAGRAM FOR TESTS

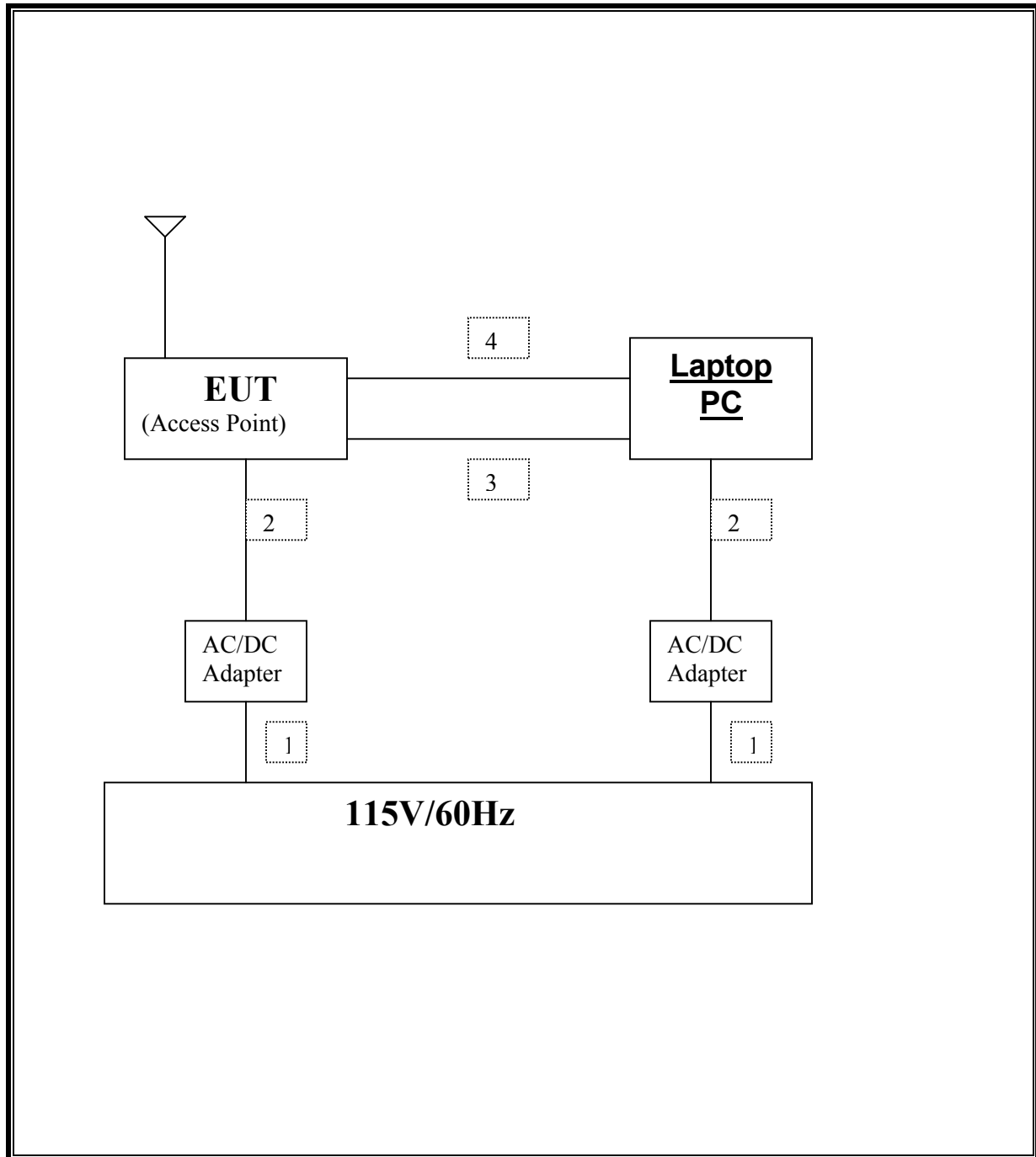

7. APPLICABLE LIMITS AND TEST RESULTS

7.1. EMISSION BANDWIDTH

LIMIT

§15.403 (c) Emission bandwidth. For purposes of this subpart the emission bandwidth shall be determined by measuring the width of the signal between two points, one below the carrier center frequency and one above the carrier center frequency, that are 26 dB down relative to the maximum level of the modulated carrier. Determination of the emissions bandwidth is based on the use of measurement instrumentation employing a peak detector function with an instrument resolutions bandwidth approximately equal to 1.0 percent of the emission bandwidth of the device under measurement.

TEST PROCEDURE

The transmitter output is connected to a spectrum analyzer. The RBW is set to 1% to 3% of the 26 dB bandwidth. The VBW is set to 3 times the RBW. The sweep time is coupled.

RESULTS

No non-compliance noted:

802.11a Mode

Channel	Frequency (MHz)	B (MHz)	10 Log B (dB)
Low	5180	18.80	12.74
Middle	5260	18.19	12.60
High	5320	18.65	12.71

26 dB EMISSION BANDWIDTH (802.11a MODE)

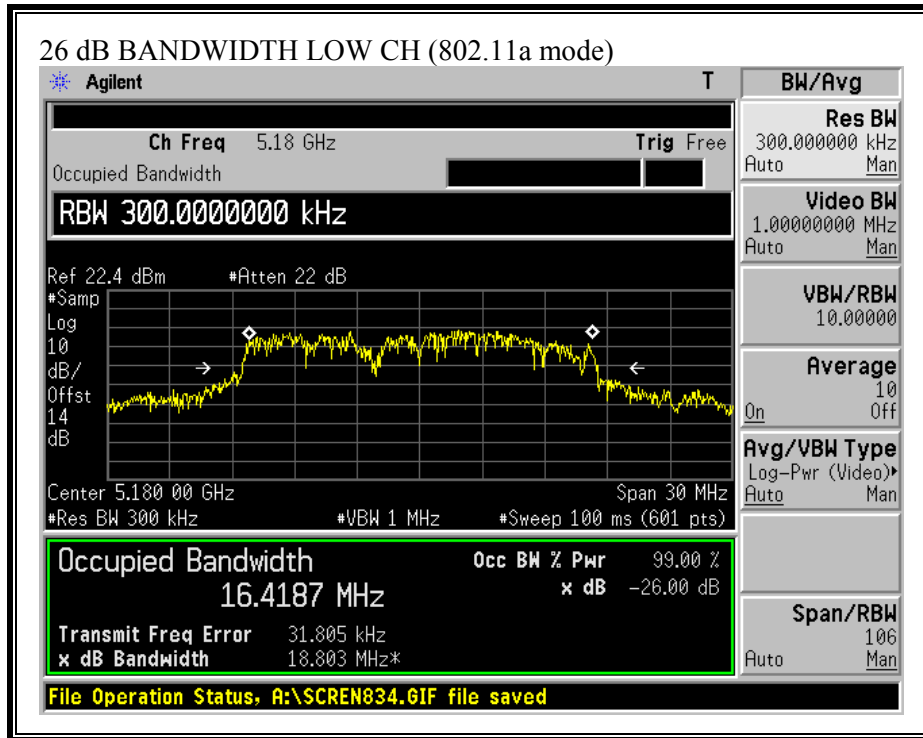

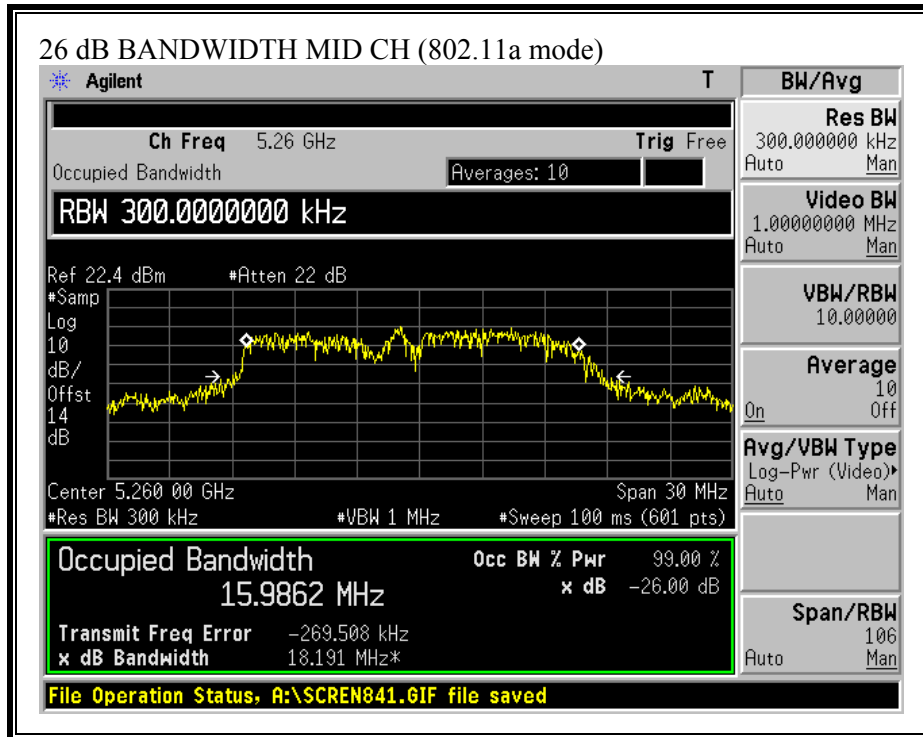

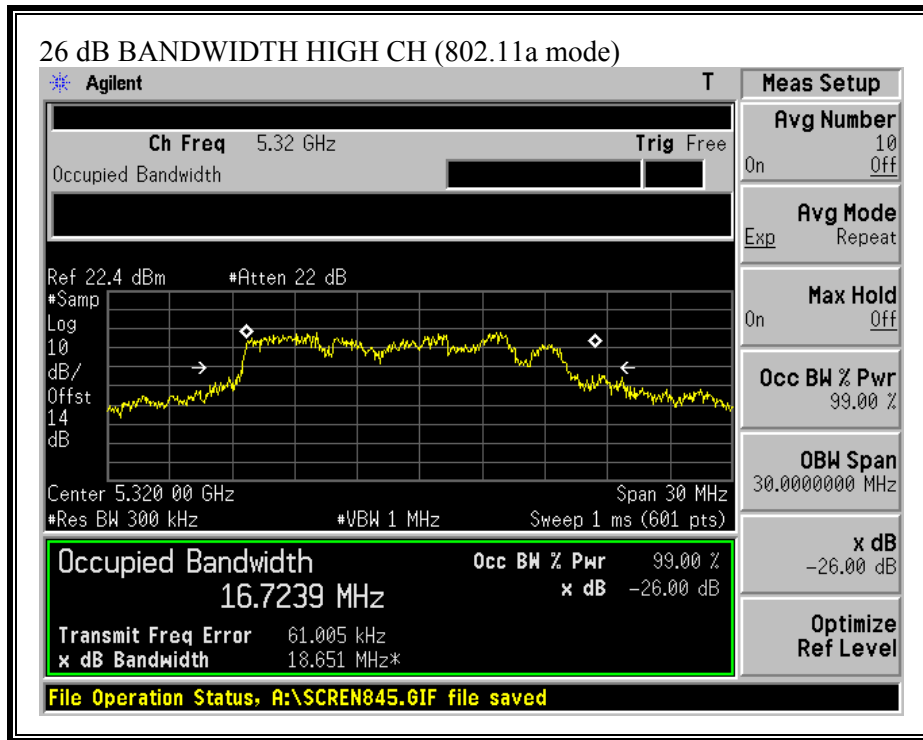

7.2. PEAK POWER

LIMIT

§15.407 (a) (1) For the band 5.15-5.25 GHz, the peak transmit power over the frequency band of operation shall not exceed the lesser of 50 mW (17 dBm) or $4 \text{ dBm} + 10 \log B$, where B is the 26-dB emission bandwidth in MHz. In addition, the peak power spectral density shall not exceed 4 dBm in any 1-MHz band. If transmitting antennas of directional gain greater than 6 dBi are used, both the peak transmit power and the peak power spectral density shall be reduced by the amount in dB that the directional gain of the antenna exceeds 6 dBi.

§15.407 (a) (1) For the band 5.25-5.35 GHz, the peak transmit power over the frequency band of operation shall not exceed the lesser of 250 mW (24 dBm) or $11 \text{ dBm} + 10 \log B$, where B is the 26-dB emission bandwidth in MHz. In addition, the peak power spectral density shall not exceed 11 dBm in any 1-MHz band. If transmitting antennas of directional gain greater than 6 dBi are used, both the peak transmit power and the peak power spectral density shall be reduced by the amount in dB that the directional gain of the antenna exceeds 6 dBi.

TEST PROCEDURE

The test is performed in accordance with FCC Public Notice: APPENDIX A Guidelines for Assessing Unlicensed National Information Infrastructure (U-NII) Devices – Part 15, Subpart E, August 2002.

The transmitter output operates continuously therefore Method # 1 is used.

LIMITS AND RESULTS

No non-compliance noted:

Limit in 5150 to 5250 MHz Band

Mode	Frequency (MHz)	Fixed Limit (dBm)	B (MHz)	4 + 10 Log B Limit (dBm)	Antenna Gain (dBi)	Limit (dBm)
802.11a	5180	17	18.803	16.74	3.00	16.74

Limit in 5250 to 5350 MHz Band

Mode	Frequency (MHz)	Fixed Limit (dBm)	B (MHz)	11 + 10 Log B Limit (dBm)	Antenna Gain (dBi)	Limit (dBm)
802.11a	5260	24	18.191	23.60	3.00	23.60
802.11a	5320	24	18.651	23.71	3.00	23.71

802.11a mode Results

Channel	Frequency (MHz)	Power (dBm)	Limit (dBm)	Margin (dB)
Low	5180	13.22	16.74	-3.52
Middle	5260	16.40	23.60	-7.20
High	5320	17.93	23.71	-5.78

PEAK POWER (NORMAL MODE)

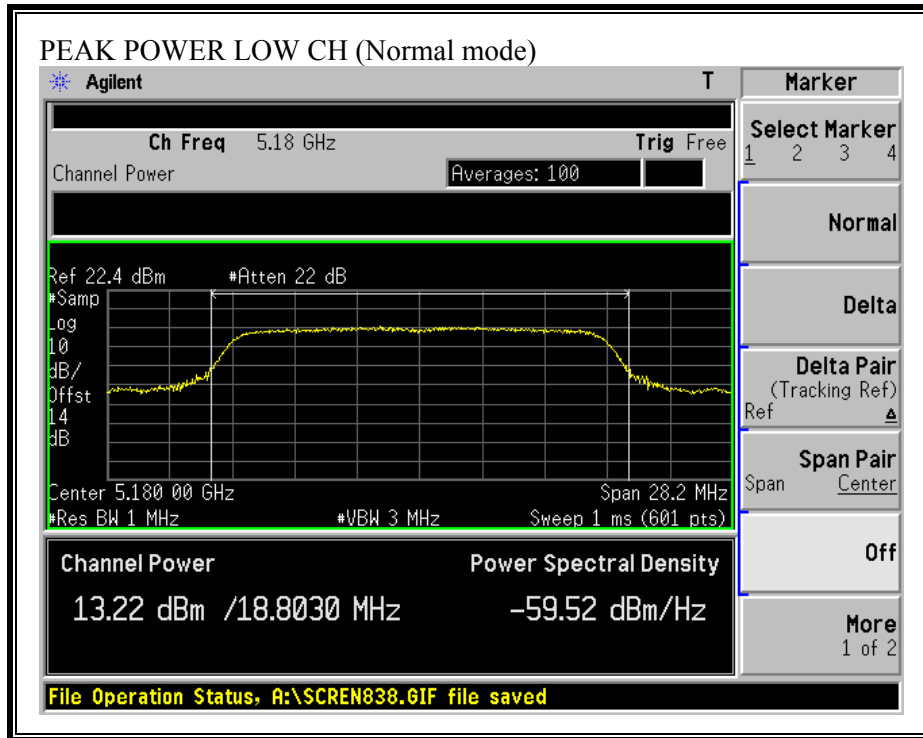

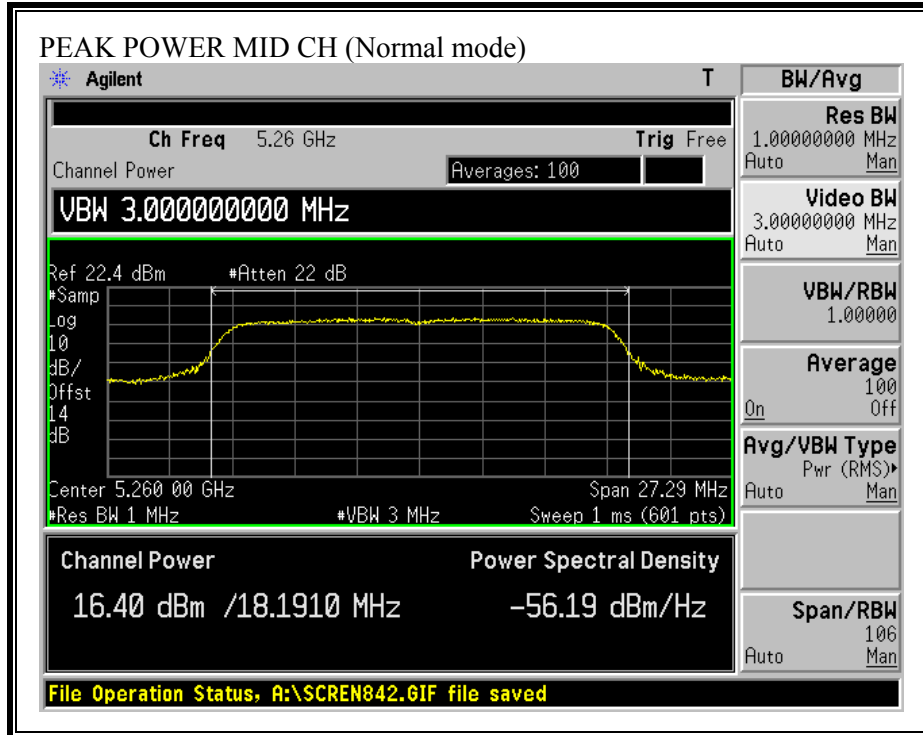

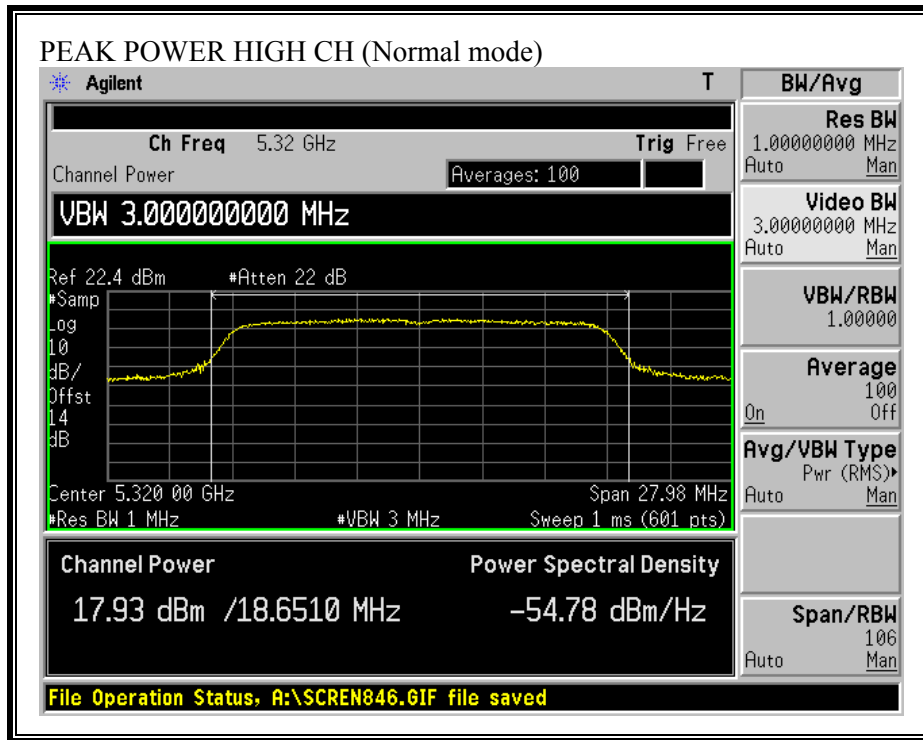

7.3. MAXIMUM PERMISSIBLE EXPOSURE

LIMITS

§1.1310 The criteria listed in Table 1 shall be used to evaluate the environmental impact of human exposure to radio-frequency (RF) radiation as specified in §1.1307(b), except in the case of portable devices which shall be evaluated according to the provisions of §2.1093 of this chapter.

TABLE 1—LIMITS FOR MAXIMUM PERMISSIBLE EXPOSURE (MPE)

Frequency range (MHz)	Electric field strength (V/m)	Magnetic field strength (A/m)	Power density (mW/cm ²)	Averaging time (minutes)
(A) Limits for Occupational/Controlled Exposures				
0.3–3.0	614	1.63	*(100)	6
3.0–30	1842/f	4.89/f	*(900/f ²)	6
30–300	61.4	0.163	1.0	6
300–1500	f/300	6
1500–100,000	5	6
(B) Limits for General Population/Uncontrolled Exposure				
0.3–1.34	614	1.63	*(100)	30
1.34–30	824/f	2.19/f	*(180/f ²)	30

TABLE 1—LIMITS FOR MAXIMUM PERMISSIBLE EXPOSURE (MPE)—Continued

Frequency range (MHz)	Electric field strength (V/m)	Magnetic field strength (A/m)	Power density (mW/cm ²)	Averaging time (minutes)
30–300	27.5	0.073	0.2	30
300–1500	f/1500	30
1500–100,000	1.0	30

f = frequency in MHz

* = Plane-wave equivalent power density

NOTE 1 TO TABLE 1: Occupational/controlled limits apply in situations in which persons are exposed as a consequence of their employment provided those persons are fully aware of the potential for exposure and can exercise control over their exposure. Limits for occupational/controlled exposure also apply in situations when an individual is transient through a location where occupational/controlled limits apply provided he or she is made aware of the potential for exposure.

NOTE 2 TO TABLE 1: General population/uncontrolled exposures apply in situations in which the general public may be exposed, or in which persons that are exposed as a consequence of their employment may not be fully aware of the potential for exposure or can not exercise control over their exposure.

CALCULATIONS

Given

$$E = \sqrt{(30 * P * G) / d}$$

and

$$S = E^2 / 3770$$

where

E = Field Strength in Volts/meter

P = Power in Watts

G = Numeric antenna gain

d = Distance in meters

S = Power Density in milliwatts/square centimeter

Combining equations and rearranging the terms to express the distance as a function of the remaining variables yields:

$$d = \sqrt{((30 * P * G) / (3770 * S))}$$

Changing to units of Power to mW and Distance to cm, using:

$$P \text{ (mW)} = P \text{ (W)} / 1000 \text{ and}$$

$$d \text{ (cm)} = 100 * d \text{ (m)}$$

yields

$$d = 100 * \sqrt{((30 * (P / 1000) * G) / (3770 * S))}$$

$$d = 0.282 * \sqrt{(P * G / S)}$$

where

d = distance in cm

P = Power in mW

G = Numeric antenna gain

S = Power Density in mW/cm²

Substituting the logarithmic form of power and gain using:

$$P \text{ (mW)} = 10^{(P \text{ (dBm)} / 10)} \text{ and}$$

$$G \text{ (numeric)} = 10^{(G \text{ (dBi)} / 10)}$$

yields

$$d = 0.282 * 10^{((P + G) / 20)} / \sqrt{S} \quad \text{Equation (1)}$$

where

d = MPE distance in cm

P = Power in dBm

G = Antenna Gain in dBi

S = Power Density Limit in mW/cm²

Equation (1) and the measured peak power is used to calculate the MPE distance.

LIMITS

From §1.1310 Table 1 (B), $S = 1.0 \text{ mW/cm}^2$

RESULTS

No non-compliance noted:

Mode	Power Density Limit (mW/cm²)	Output Power (dBm)	Antenna Gain (dBi)	MPE Distance (cm)
802.11a	1.0	17.93	3.00	3.14

NOTE: For mobile or fixed location transmitters, the minimum separation distance is 20 cm, even if calculations indicate that the MPE distance would be less.

7.4. AVERAGE POWER

AVERAGE POWER LIMIT

None; for reporting purposes only.

TEST PROCEDURE

The transmitter output is connected to a power meter.

RESULTS

No non-compliance noted:

The cable assembly insertion loss of 15.8dB (including 10 dB pad and 5.8 dB cable) was entered as an offset in the power meter to allow for direct reading of power.

802.11a Mode

Channel	Frequency (MHz)	Average Power (dBm)
Low	5180	13.70
Middle	5260	16.57
High	5320	16.90

7.5. PEAK POWER SPECTRAL DENSITY

LIMIT

§15.407 (a) (1) For the band 5.15-5.25 GHz, the peak transmit power over the frequency band of operation shall not exceed the lesser of 50 mW (17 dBm) or $4 \text{ dBm} + 10 \log B$, where B is the 26-dB emission bandwidth in MHz. In addition, the peak power spectral density shall not exceed 4 dBm in any 1-MHz band. If transmitting antennas of directional gain greater than 6 dBi are used, both the peak transmit power and the peak power spectral density shall be reduced by the amount in dB that the directional gain of the antenna exceeds 6 dBi.

§15.407 (a) (1) For the band 5.25-5.35 GHz, the peak transmit power over the frequency band of operation shall not exceed the lesser of 250 mW (24 dBm) or $11 \text{ dBm} + 10 \log B$, where B is the 26-dB emission bandwidth in MHz. In addition, the peak power spectral density shall not exceed 11 dBm in any 1-MHz band. If transmitting antennas of directional gain greater than 6 dBi are used, both the peak transmit power and the peak power spectral density shall be reduced by the amount in dB that the directional gain of the antenna exceeds 6 dBi.

The maximum antenna gain = 3dBi, therefore there is no reduction due to antenna gain.

TEST PROCEDURE

The test is performed in accordance with FCC Public Notice: APPENDIX A Guidelines for Assessing Unlicensed National Information Infrastructure (U-NII) Devices – Part 15, Subpart E, August 2002. PPSD method #2 was used.

RESULTS

No non-compliance noted:

802.11a Mode

Channel	Frequency (MHz)	PPSD (dBm)	Limit (dBm)	Margin (dB)
Low	5180	2.96	4.00	-1.04
Middle	5260	6.27	11.00	-4.74
High	5320	7.71	11.00	-3.29

PEAK POWER SPECTRAL DENSITY (802.11a MODE)

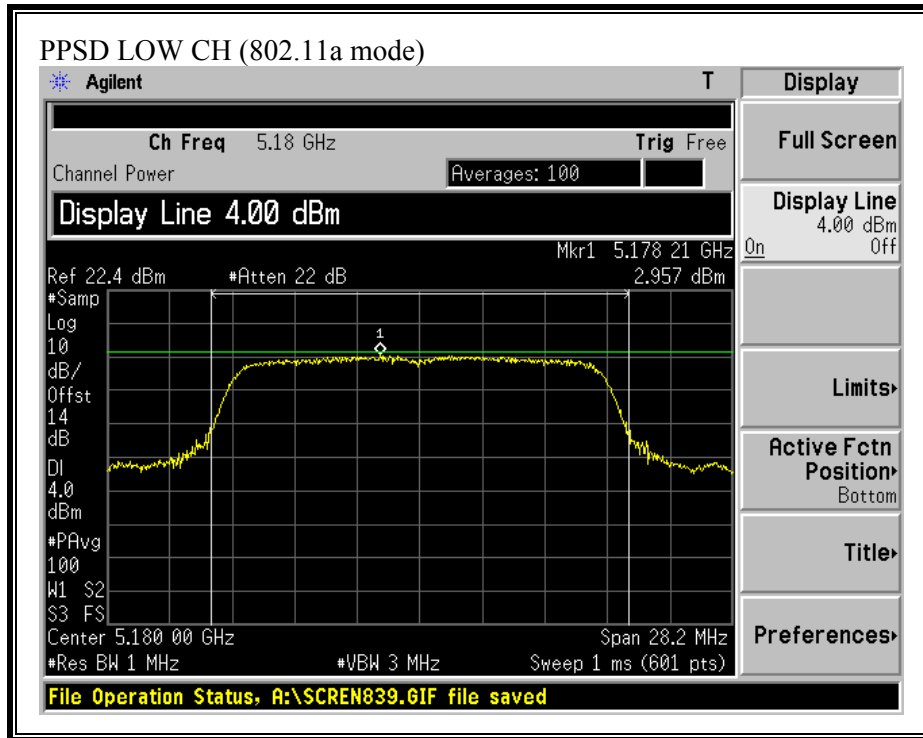

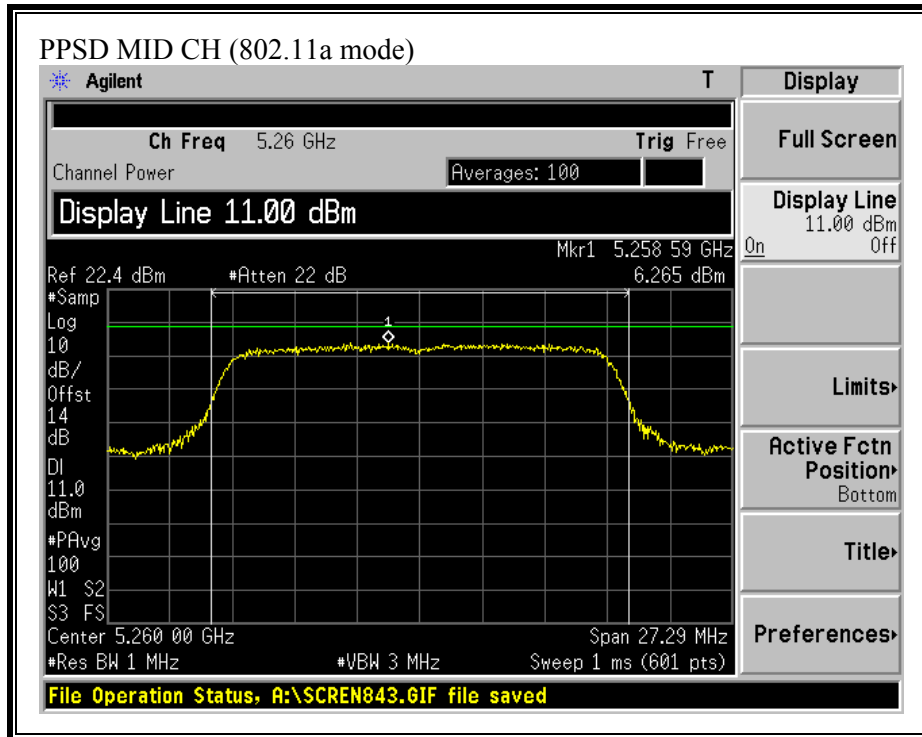

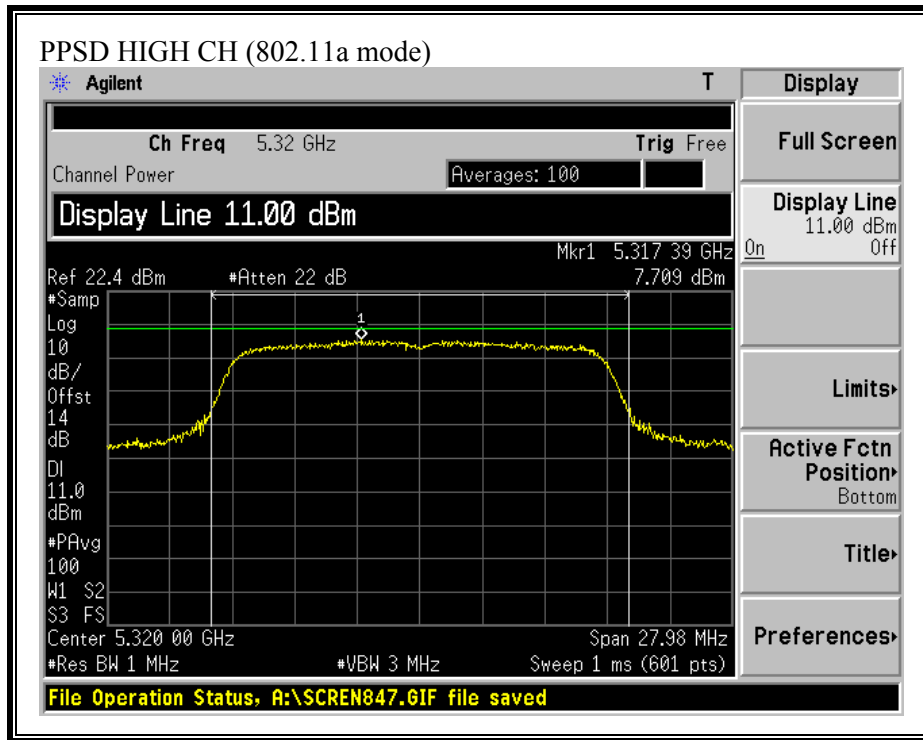

7.6. PEAK EXCURSION

LIMIT

§15.407 (a) (6) The ratio of the peak excursion of the modulation envelope (measured using a peak hold function) to the peak transmit power (measured as specified above) shall not exceed 13 dB across any 1 MHz bandwidth or the emission bandwidth whichever is less.

TEST PROCEDURE

The test is performed in accordance with FCC Public Notice: APPENDIX A Guidelines for Assessing Unlicensed National Information Infrastructure (U-NII) Devices – Part 15, Subpart E, August 2002.

Since Method # 1 was used for peak power measurements, Method # 1 settings are used for the second PPSD trace.

RESULTS

No non-compliance noted:

802.11a Mode

Channel	Frequency (MHz)	Peak Excursion (dB)	Limit (dB)	Margin (dB)
Low	5180	9.93	13	-3.07
Middle	5260	11.78	13	-1.22
High	5320	7.80	13	-5.20

PEAK EXCURSION (802.11a MODE)

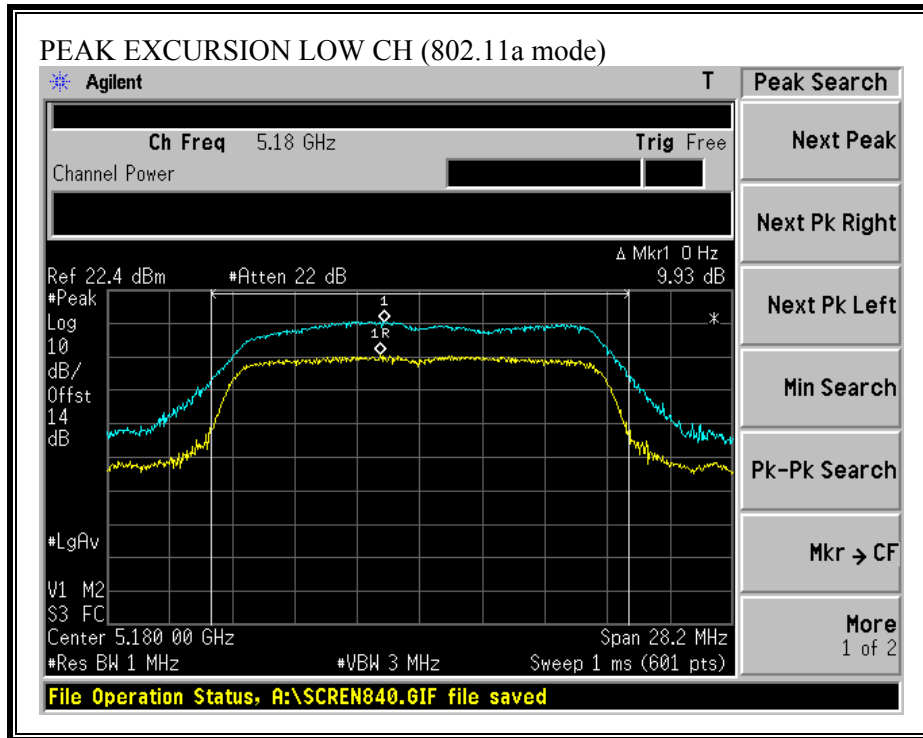

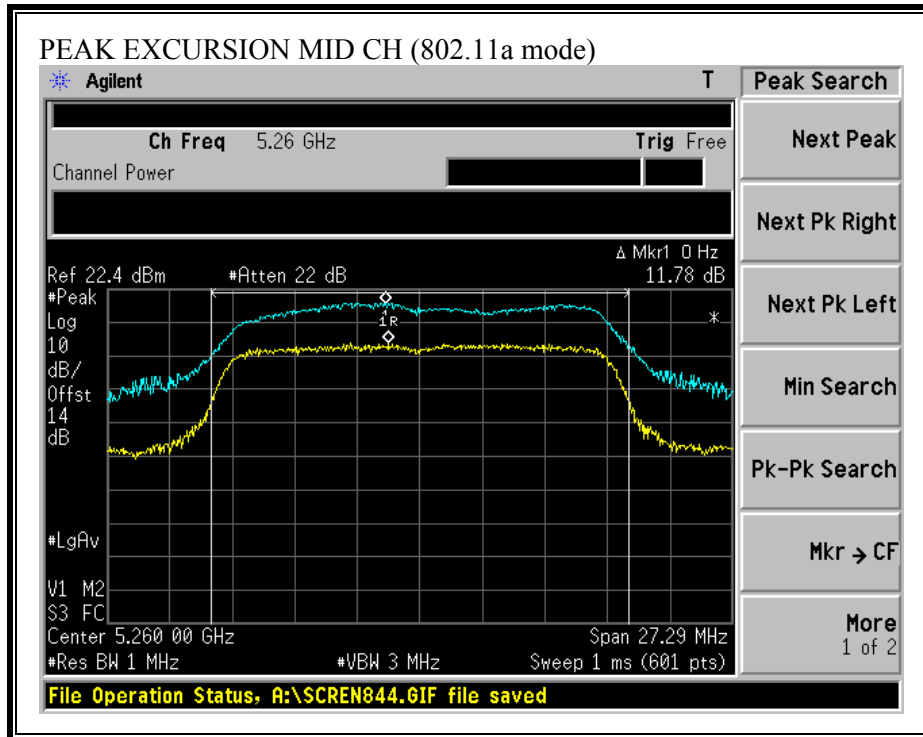

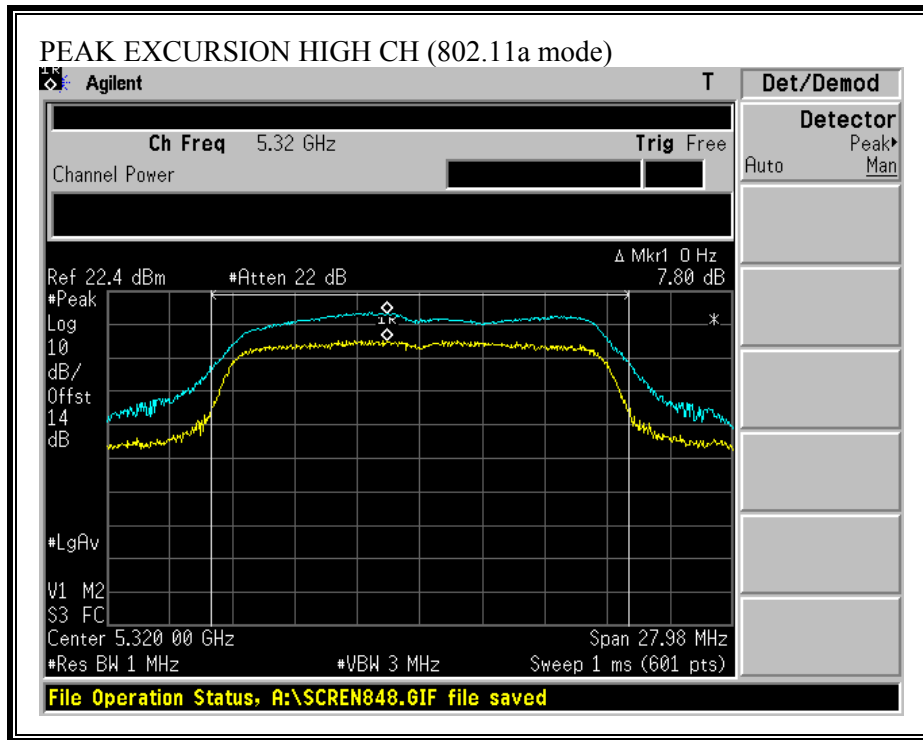

7.7. CONDUCTED SPURIOUS EMISSIONS

LIMITS

§15.407 (b) (1 & 2) For transmitters operating in the 5.15-5.35 GHz band: all emissions outside of the 5.15-5.35 GHz band shall not exceed an EIRP of -27dBm / MHz.

TEST PROCEDURE

Conducted RF measurements of the transmitter output are made to confirm that the EUT antenna port conducted emissions meet the specified limit and to identify any spurious signals that require further investigation or measurements on the radiated emissions site.

The transmitter output is connected to the spectrum analyzer. The resolution bandwidth is set to 1 MHz. The video bandwidth is set to 1 MHz. Peak detection measurements are compared to the average EIRP limit, adjusted for the maximum antenna gain. If necessary, additional average detection measurements are made.

Measurements are made over the 30 MHz to 40 GHz range with the transmitter set to the lowest, middle, and highest channels.

RESULTS

No non-compliance noted:

SPURIOUS EMISSIONS (802.11a MODE)

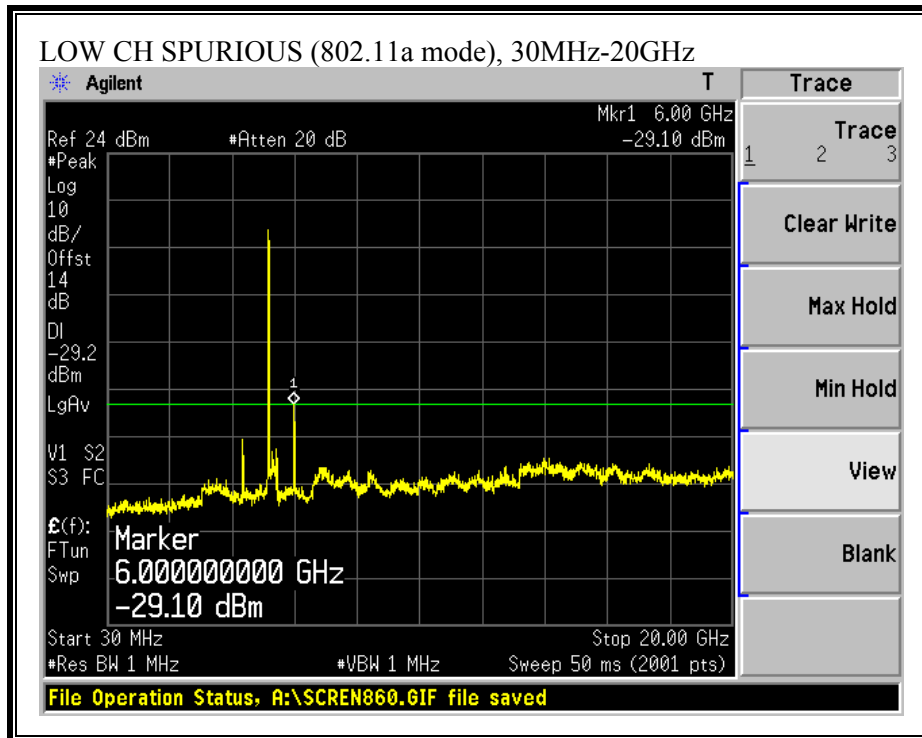

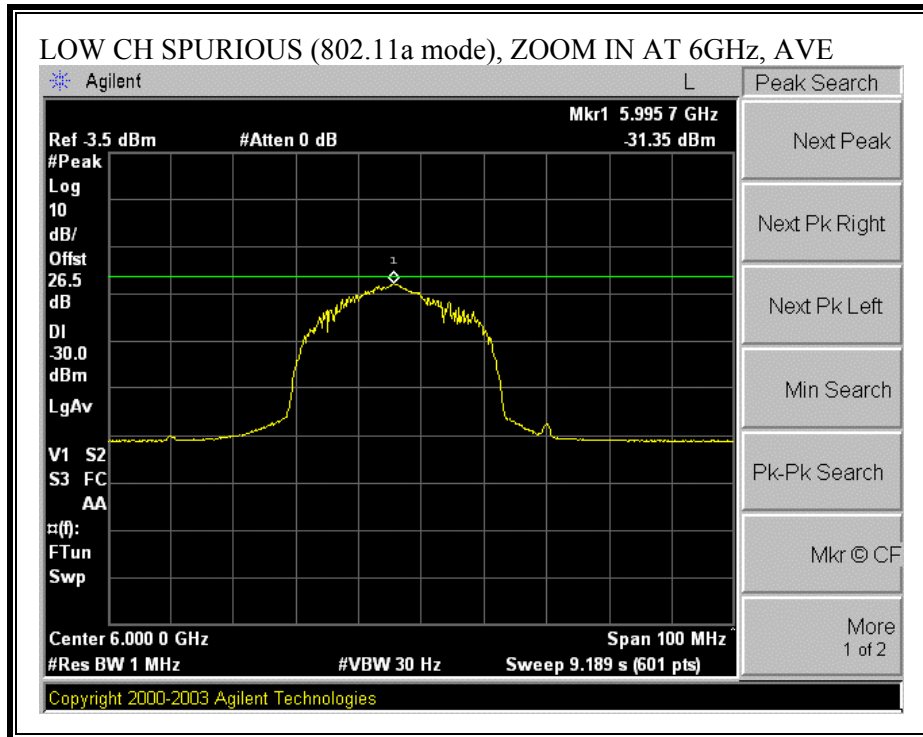

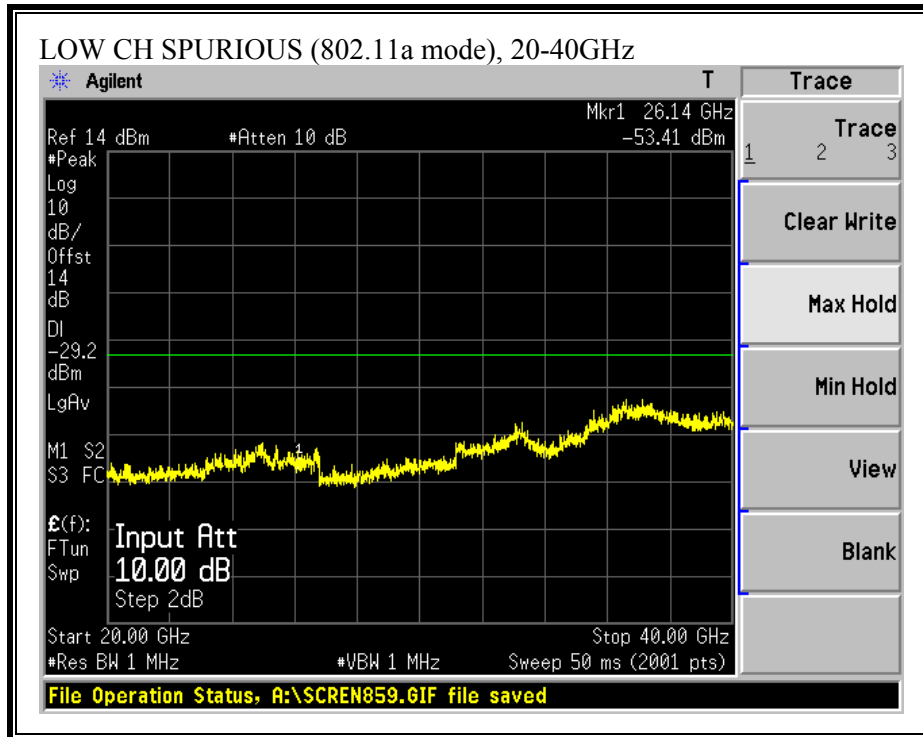

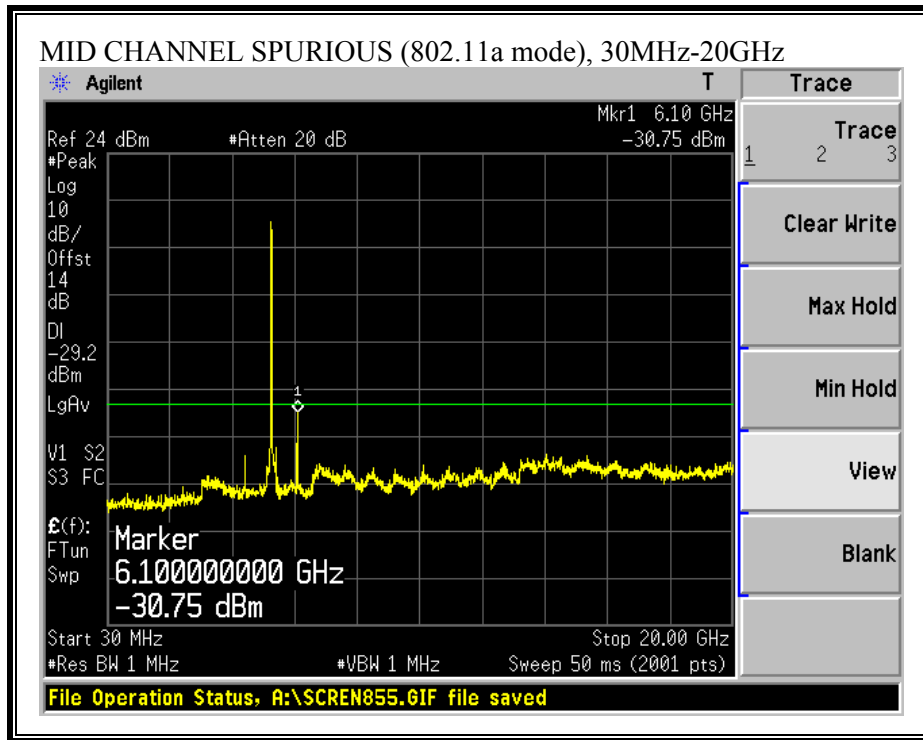

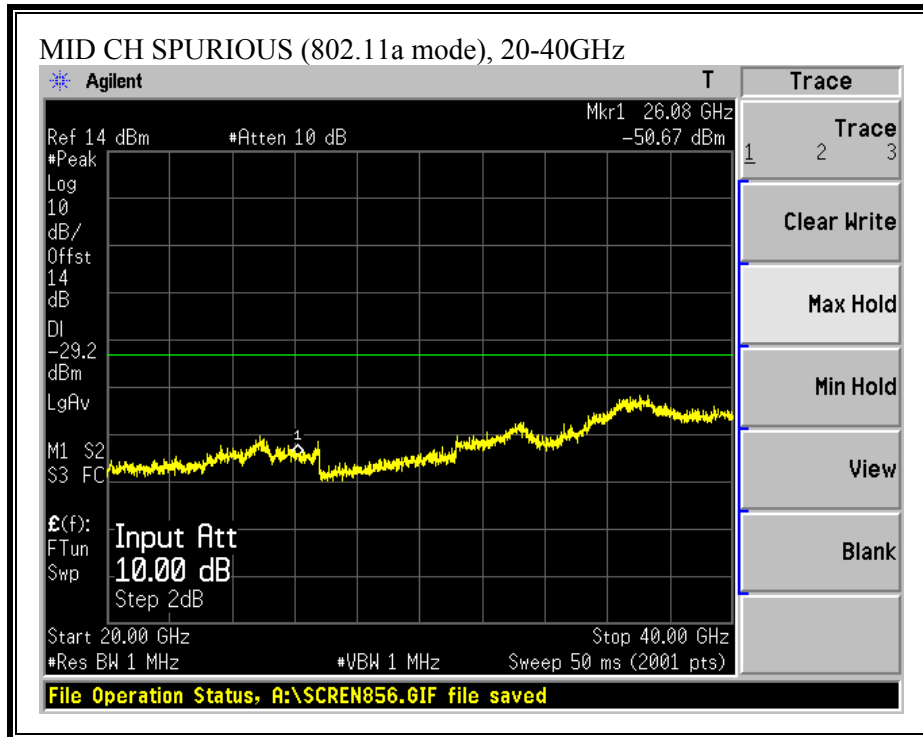

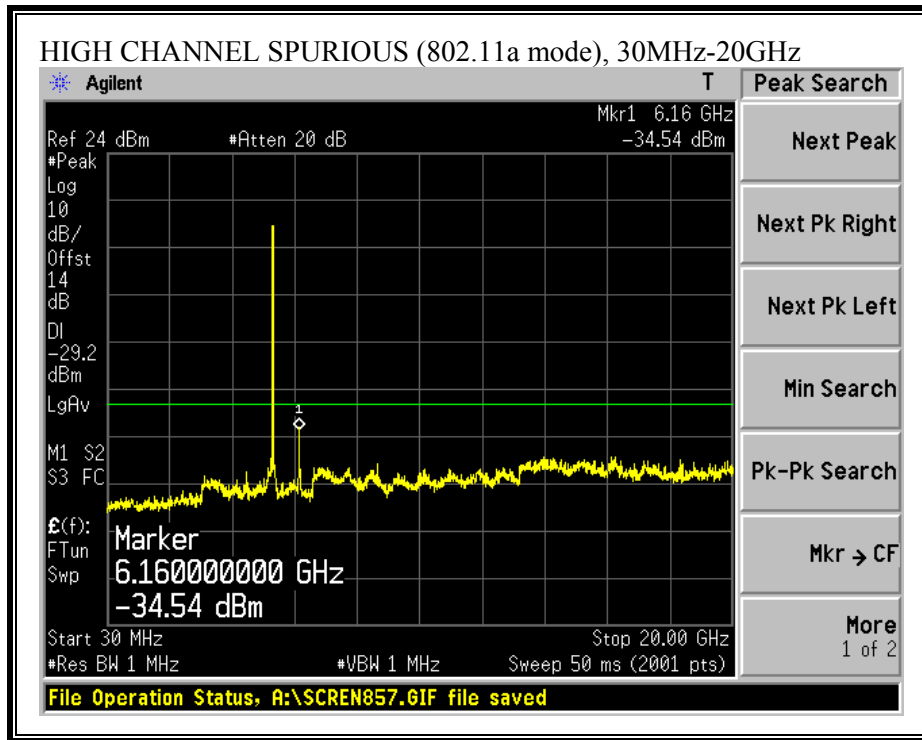

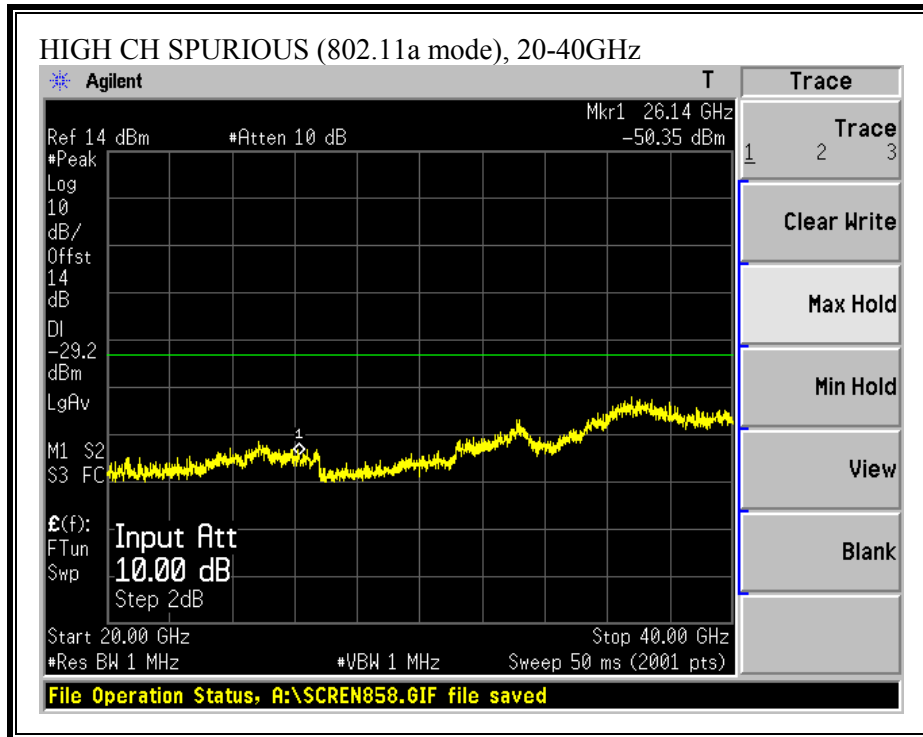

7.8. RADIATED EMISSIONS

7.8.1. TRANSMITTER RADIATED SPURIOUS EMISSIONS

LIMITS

§15.205 (a) Except as shown in paragraph (d) of this section, only spurious emissions are permitted in any of the frequency bands listed below:

MHz	MHz	MHz	GHz
0.090 - 0.110	16.42 - 16.423	399.9 - 410	4.5 - 5.15
¹ 0.495 - 0.505	16.69475 - 16.69525	608 - 614	5.35 - 5.46
2.1735 - 2.1905	16.80425 - 16.80475	960 - 1240	7.25 - 7.75
4.125 - 4.128	25.5 - 25.67	1300 - 1427	8.025 - 8.5
4.17725 - 4.17775	37.5 - 38.25	1435 - 1626.5	9.0 - 9.2
4.20725 - 4.20775	73 - 74.6	1645.5 - 1646.5	9.3 - 9.5
6.215 - 6.218	74.8 - 75.2	1660 - 1710	10.6 - 12.7
6.26775 - 6.26825	108 - 121.94	1718.8 - 1722.2	13.25 - 13.4
6.31175 - 6.31225	123 - 138	2200 - 2300	14.47 - 14.5
8.291 - 8.294	149.9 - 150.05	2310 - 2390	15.35 - 16.2
8.362 - 8.366	156.52475 - 156.52525	2483.5 - 2500	17.7 - 21.4
8.37625 - 8.38675	156.7 - 156.9	2655 - 2900	22.01 - 23.12
8.41425 - 8.41475	162.0125 - 167.17	3260 - 3267	23.6 - 24.0
12.29 - 12.293	167.72 - 173.2	3332 - 3339	31.2 - 31.8
12.51975 - 12.52025	240 - 285	3345.8 - 3358	36.43 - 36.5
12.57675 - 12.57725	322 - 335.4	3600 - 4400	(²)
13.36 - 13.41			

¹ Until February 1, 1999, this restricted band shall be 0.490-0.510 MHz.

² Above 38.6

§15.205 (b) Except as provided in paragraphs (d) and (e), the field strength of emissions appearing within these frequency bands shall not exceed the limits shown in Section 15.209. At frequencies equal to or less than 1000 MHz, compliance with the limits in Section 15.209 shall be demonstrated using measurement instrumentation employing a CISPR quasi-peak detector. Above 1000 MHz, compliance with the emission limits in Section 15.209 shall be demonstrated based on the average value of the measured emissions. The provisions in Section 15.35 apply to these measurements.

§15.209 (a) Except as provided elsewhere in this Subpart, the emissions from an intentional radiator shall not exceed the field strength levels specified in the following table:

Frequency (MHz)	Field Strength (microvolts/meter)	Measurement Distance (meters)
30 - 88	100 **	3
88 - 216	150 **	3
216 - 960	200 **	3
Above 960	500	3

** Except as provided in paragraph (g), fundamental emissions from intentional radiators operating under this Section shall not be located in the frequency bands 54-72 MHz, 76-88 MHz, 174-216 MHz or 470-806 MHz. However, operation within these frequency bands is permitted under other sections of this Part, e.g., Sections 15.231 and 15.241.

§15.209 (b) In the emission table above, the tighter limit applies at the band edges.

TEST PROCEDURE

The EUT is placed on a non-conducting table 80 cm above the ground plane. The antenna to EUT distance is 3 meters. The EUT is configured in accordance with ANSI C63.4. The EUT is set to transmit in a continuous mode.

For measurements below 1 GHz the resolution bandwidth is set to 100 kHz for peak detection measurements or 120 kHz for quasi-peak detection measurements. Peak detection is used unless otherwise noted as quasi-peak.

For measurements above 1 GHz the resolution bandwidth is set to 1 MHz, then the video bandwidth is set to 1 MHz for peak measurements and 10 Hz for average measurements.

The spectrum from 30 MHz to 40 GHz is investigated with the transmitter set to the lowest, middle, and highest channels.

The frequency range of interest is monitored at a fixed antenna height and EUT azimuth. The EUT is rotated through 360 degrees to maximize emissions received. The antenna is scanned from 1 to 4 meters above the ground plane to further maximize the emission. Measurements are made with the antenna polarized in both the vertical and the horizontal positions.

RESULTS

No non-compliance noted:

7.8.2. TRANSMITTER RADIATED EMISSIONS ABOVE 1 GHZ

RESTRICTED BANDEDGE (802.11a MODE, LOW CHANNEL, HORIZONTAL)

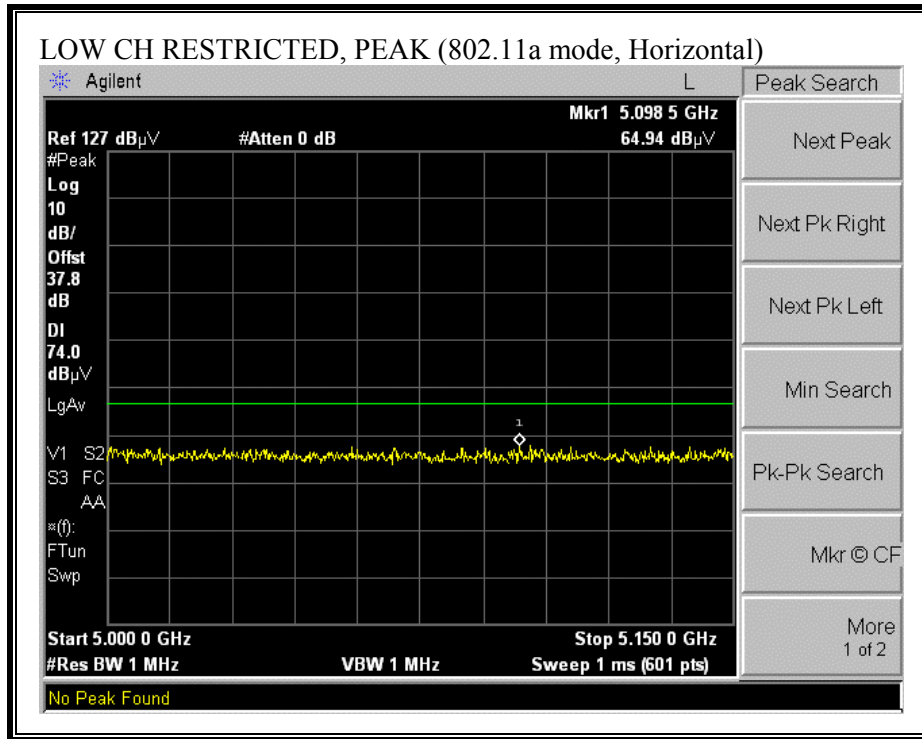

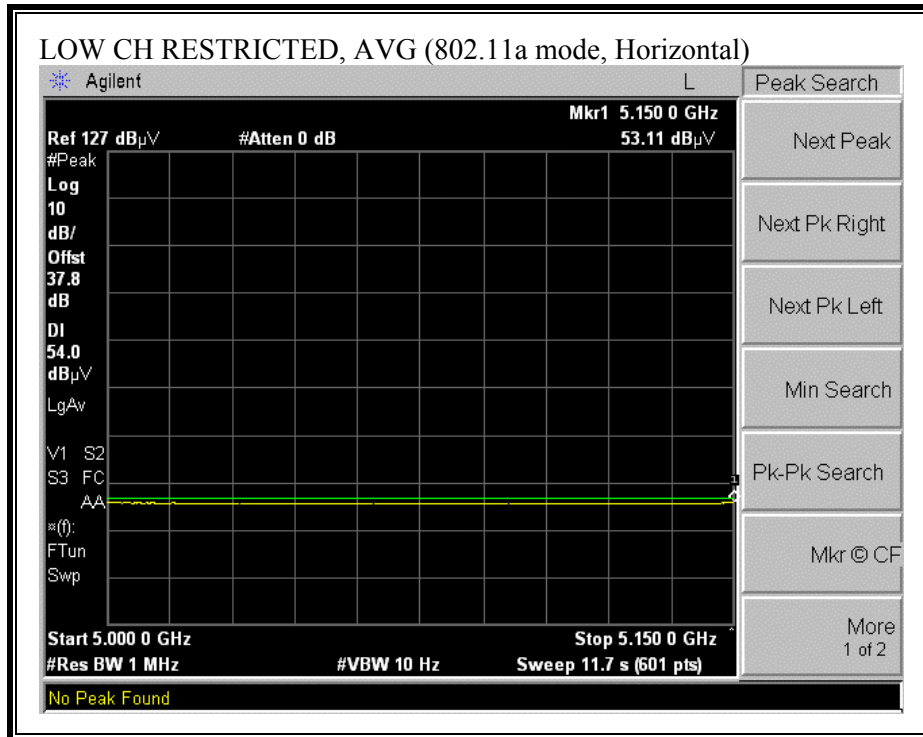

RESTRICTED BANDEDGE (802.11a MODE, LOW CHANNEL, VERTICAL)

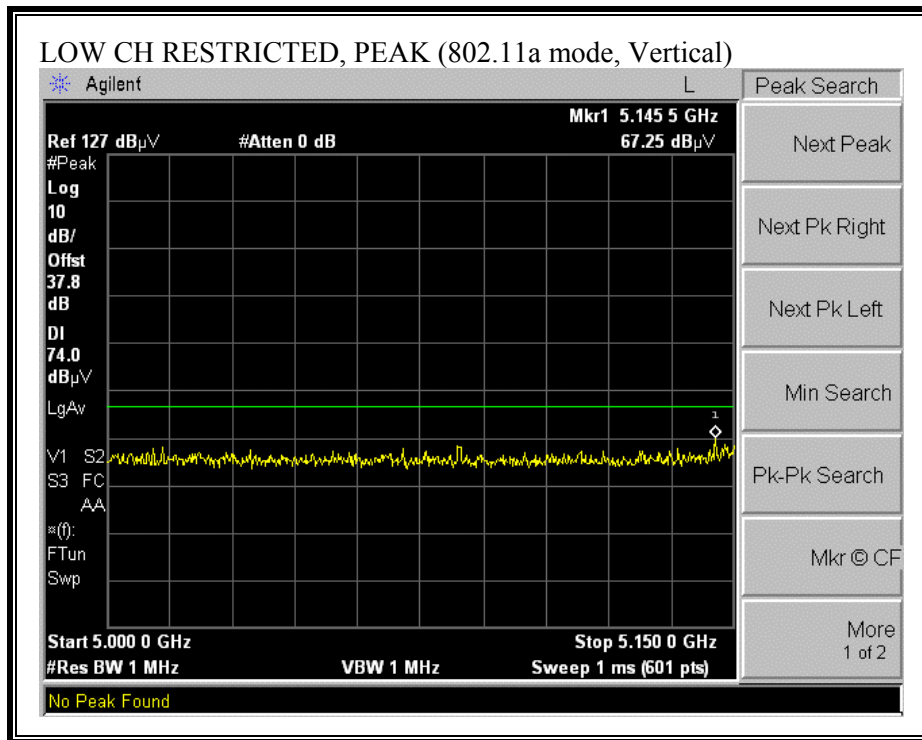

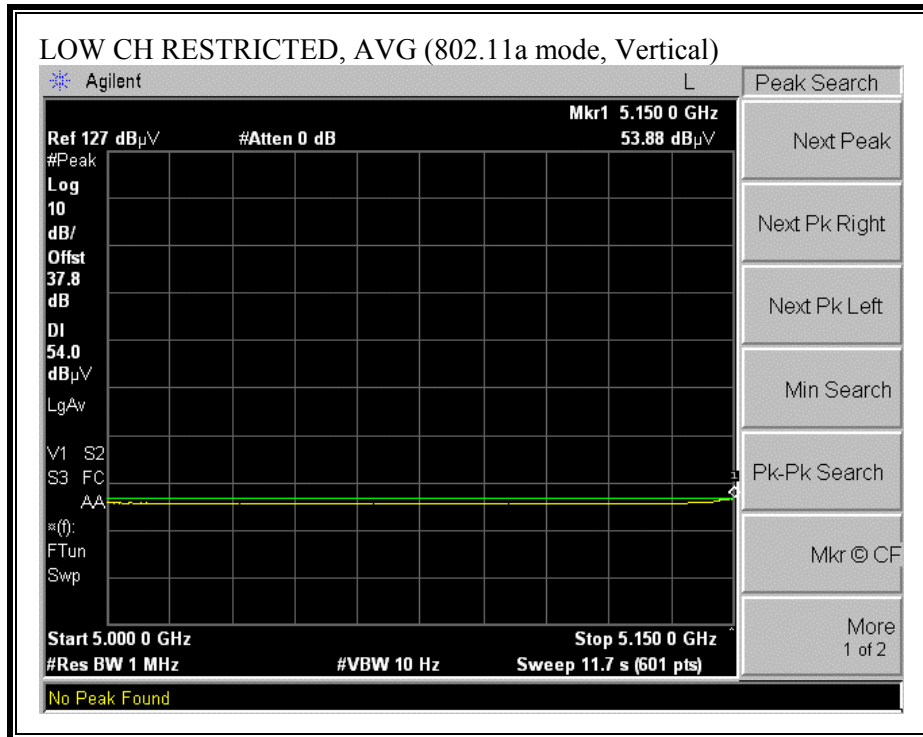

RESTRICTED BANDEDGE (802.11a MODE, HIGH CHANNEL, HORIZONTAL)

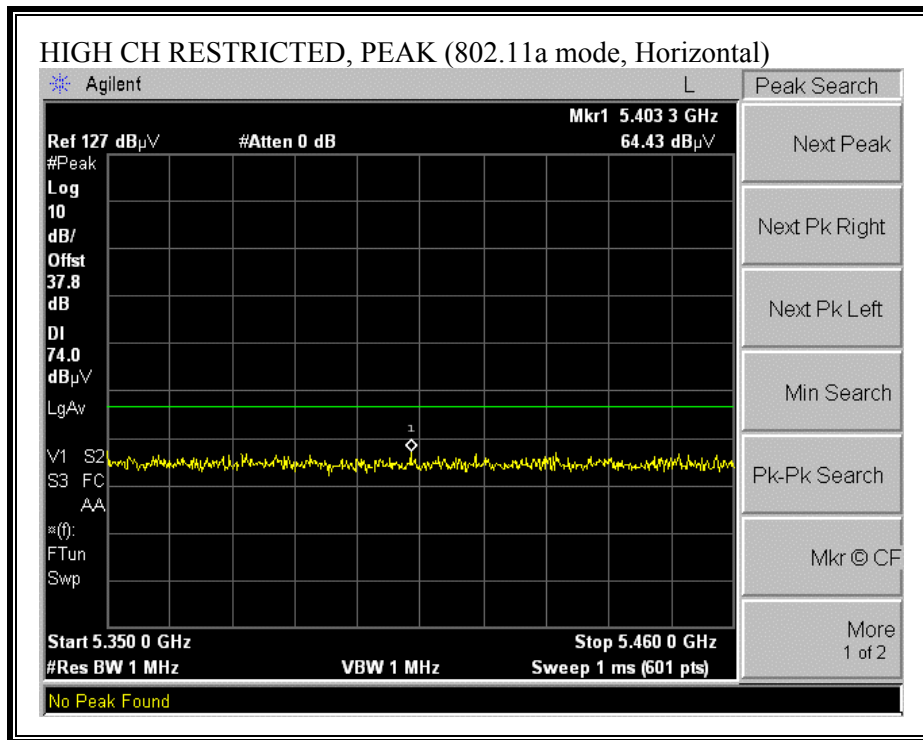

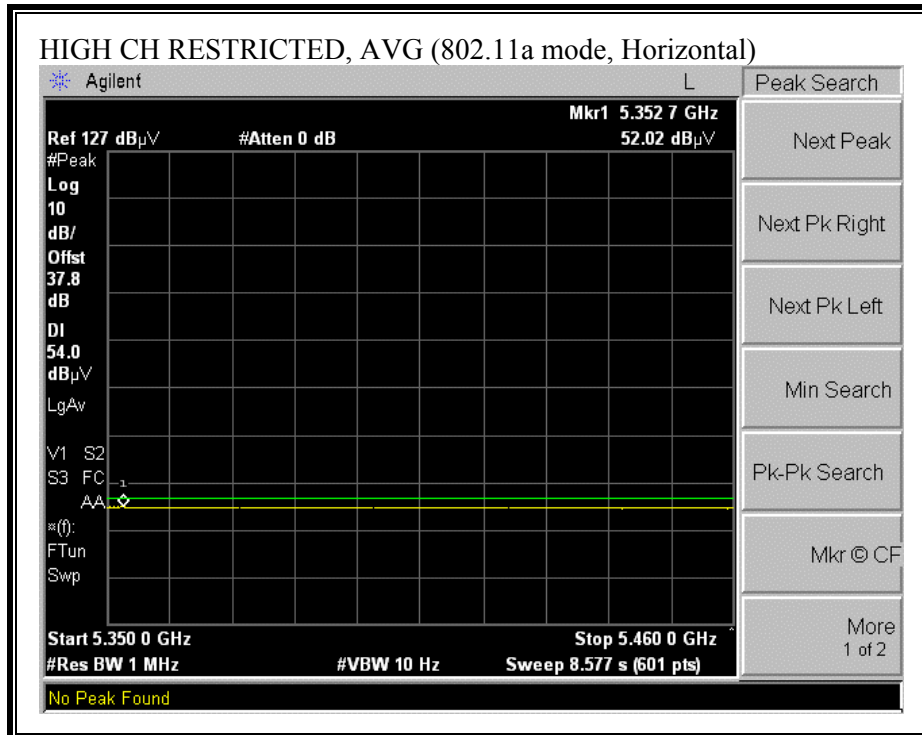

RESTRICTED BANDEDGE (802.11a MODE, HIGH CHANNEL, VERTICAL)

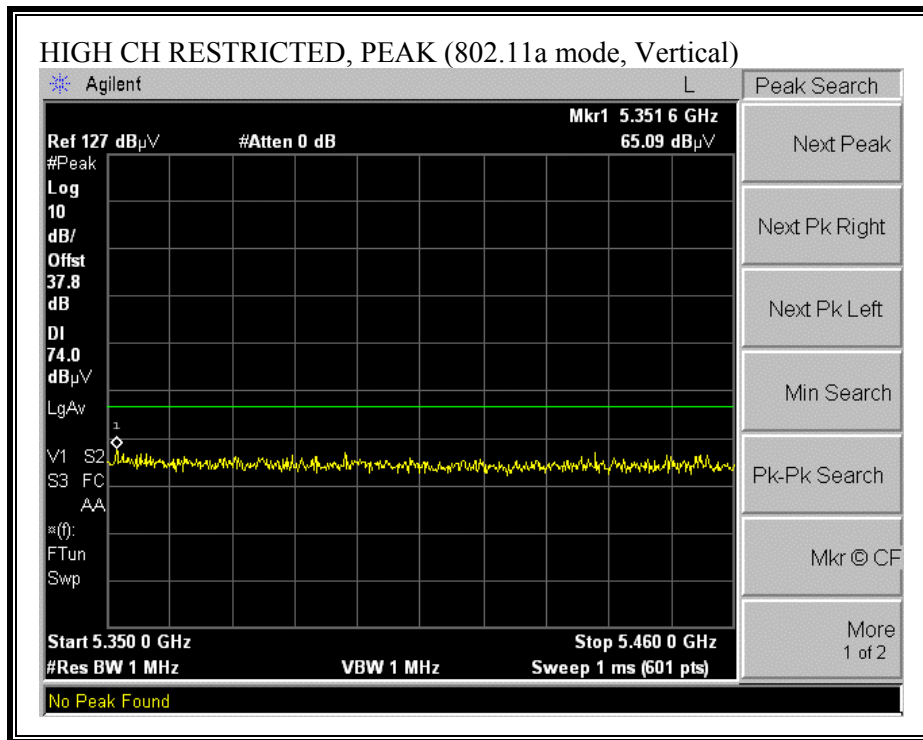

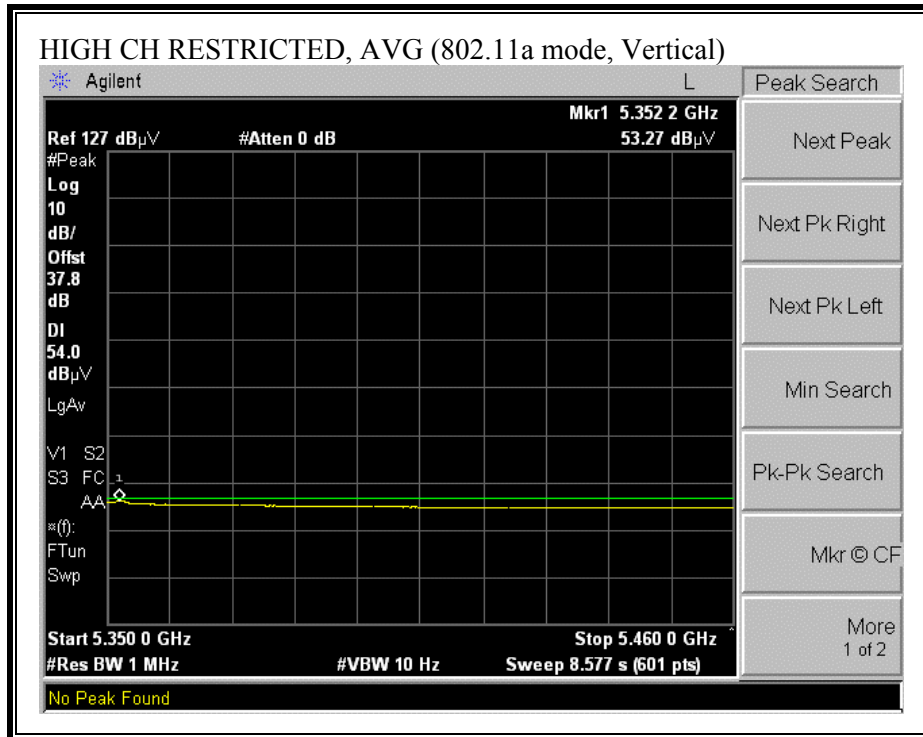

HARMONICS AND SPURIOUS EMISSIONS (802.11a MODE)

07/13/04 **High Frequency Measurement**
 Compliance Certification Services, Morgan Hill Open Field Site

Test Engr: Ben Du
 Project #:
 Company: Airgo Networks
 EUT Descrip.: 802.11abg MIMO AP
 EUT M/N: 1200AP/WS112
 Test Target: FCC 15.247, IC RSS-210
 Mode Oper: B Mode

Test Equipment:

EMCO Horn 1-18GHz: T120; S/N: 29310 @3m
 Spectrum Analyzer: HP 8593EM Analyzer
 Pre-amplifier 1-26GHz: T63 Miteq 646456
 Pre-amplifier 26-40GHz:
 Horn > 18GHz:

Hi Frequency Cables: (2 ft) (2~3 ft) (4~6 ft) (12 ft)

Limit: FCC 15.205

Peak Measurements: 1 MHz Resolution Bandwidth, 1MHz Video Bandwidth
 Average Measurements: 1 MHz Resolution Bandwidth, 10Hz Video Bandwidth

f GHz	Dist feet	Read Pk dBuV	Read Avg. dBuV	AF dB/m	CL dB	Amp dB	D Corr dB	HPF	Peak dBuV/m	Avg dBuV/m	Pk Lim dBuV/m	Avg Lim dBuV/m	Pk Mar dB	Avg Mar dB	Notes
UNI WS111															
Low Channel															
10.360	9.8	41.9	28.8	37.6	4.7	-33.4	0.0	1.0	51.8	38.7	74.0	54.0	-22.2	-15.3	V
10.360	9.8	41.6	28.6	37.6	4.7	-33.4	0.0	1.0	51.5	38.5	74.0	54.0	-22.5	-15.5	H
Mid Channel															
10.520	9.8	42.7	28.0	37.7	4.8	-33.5	0.0	1.0	52.7	38.0	74.0	54.0	-21.3	-16.0	V
10.520	9.8	40.2	28.2	37.7	4.8	-33.5	0.0	1.0	50.2	38.2	74.0	54.0	-23.8	-15.8	H
High Channel															
10.640	9.8	41.9	28.7	37.8	4.8	-33.5	0.0	1.0	52.0	38.8	74.0	54.0	-22.0	-15.2	V
10.640	9.8	41.9	28.7	37.8	4.8	-33.5	0.0	1.0	52.0	38.8	74.0	54.0	-22.0	-15.2	H

f Measurement Frequency Amp Preamp Gain Avg Lim Average Field Strength Limit
 Dist Distance to Antenna D Corr Distance Correct to 3 meters Pk Lim Peak Field Strength Limit
 Read Analyzer Reading Avg Average Field Strength @ 3 m Avg Mar Margin vs. Average Limit
 AF Antenna Factor Peak Calculated Peak Field Strength Pk Mar Margin vs. Peak Limit
 CL Cable Loss HPF High Pass Filter

7.8.3. WORST-CASE RADIATED EMISSIONS BELOW 1 GHz

SPURIOUS EMISSIONS 30 TO 1000 MHz (WORST-CASE CONFIGURATION, HORIZONTAL)

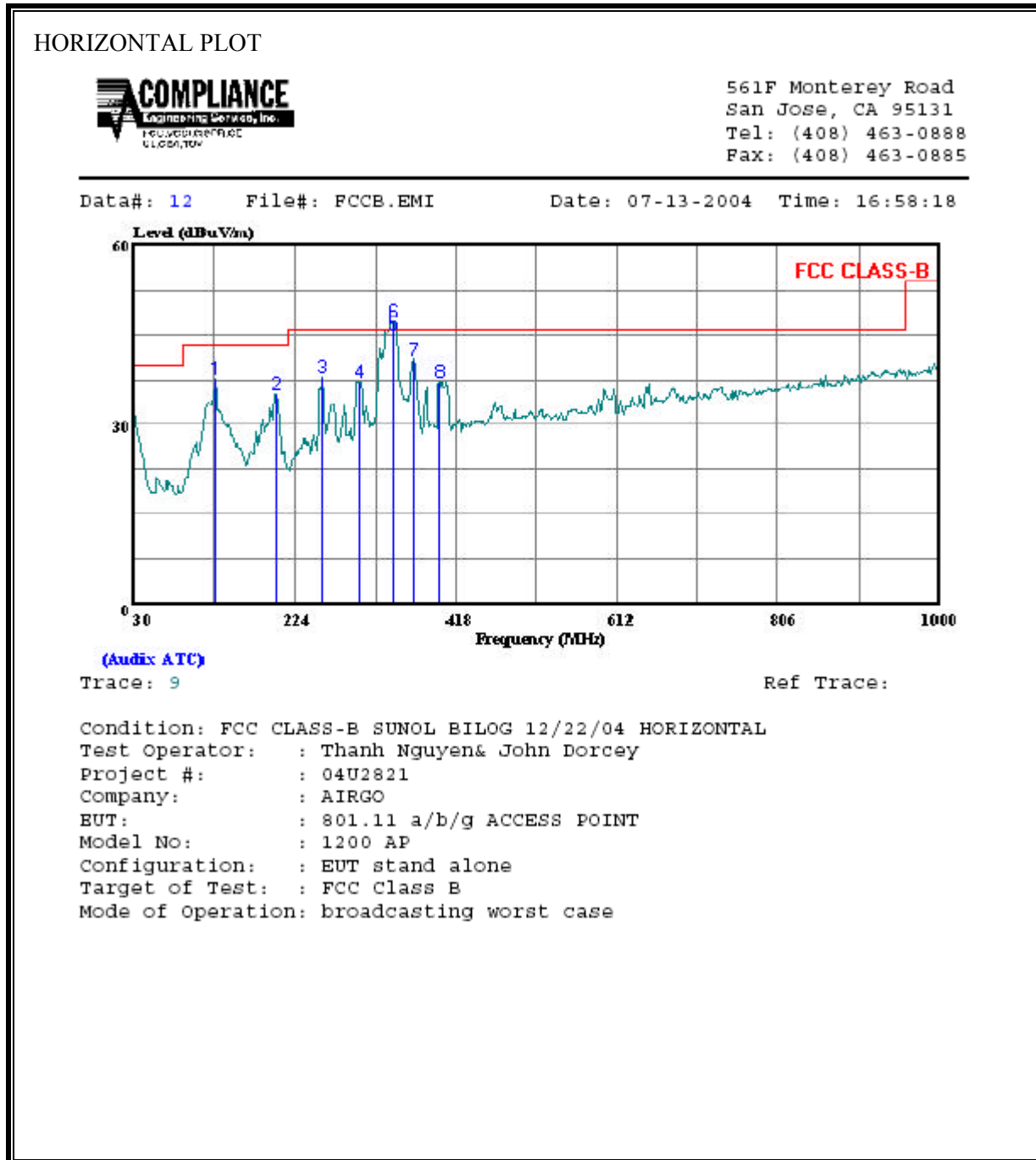

HORIZONTAL DATA

	Freq	Remark	Read Level	Factor	Level	Limit Line	Over Limit
	MHz		dBuV	dB	dBuV/m	dBuV/m	dB
1	128.940	Peak	22.01	15.53	37.54	43.50	-5.96
2	201.690	Peak	21.35	13.78	35.13	43.50	-8.37
3	256.980	Peak	23.52	14.45	37.97	46.00	-8.03
4	302.570	Peak	21.18	15.97	37.15	46.00	-8.85
5	342.340	QP	28.60	16.70	45.30	46.00	-0.70
6 *	342.340	Peak	30.65	16.71	47.36	46.00	1.36
7	367.560	Peak	23.33	17.40	40.73	46.00	-5.27
8	399.570	Peak	18.84	18.21	37.05	46.00	-8.95

SPURIOUS EMISSIONS 30 TO 1000 MHz (WORST-CASE CONFIGURATION, VERTICAL)

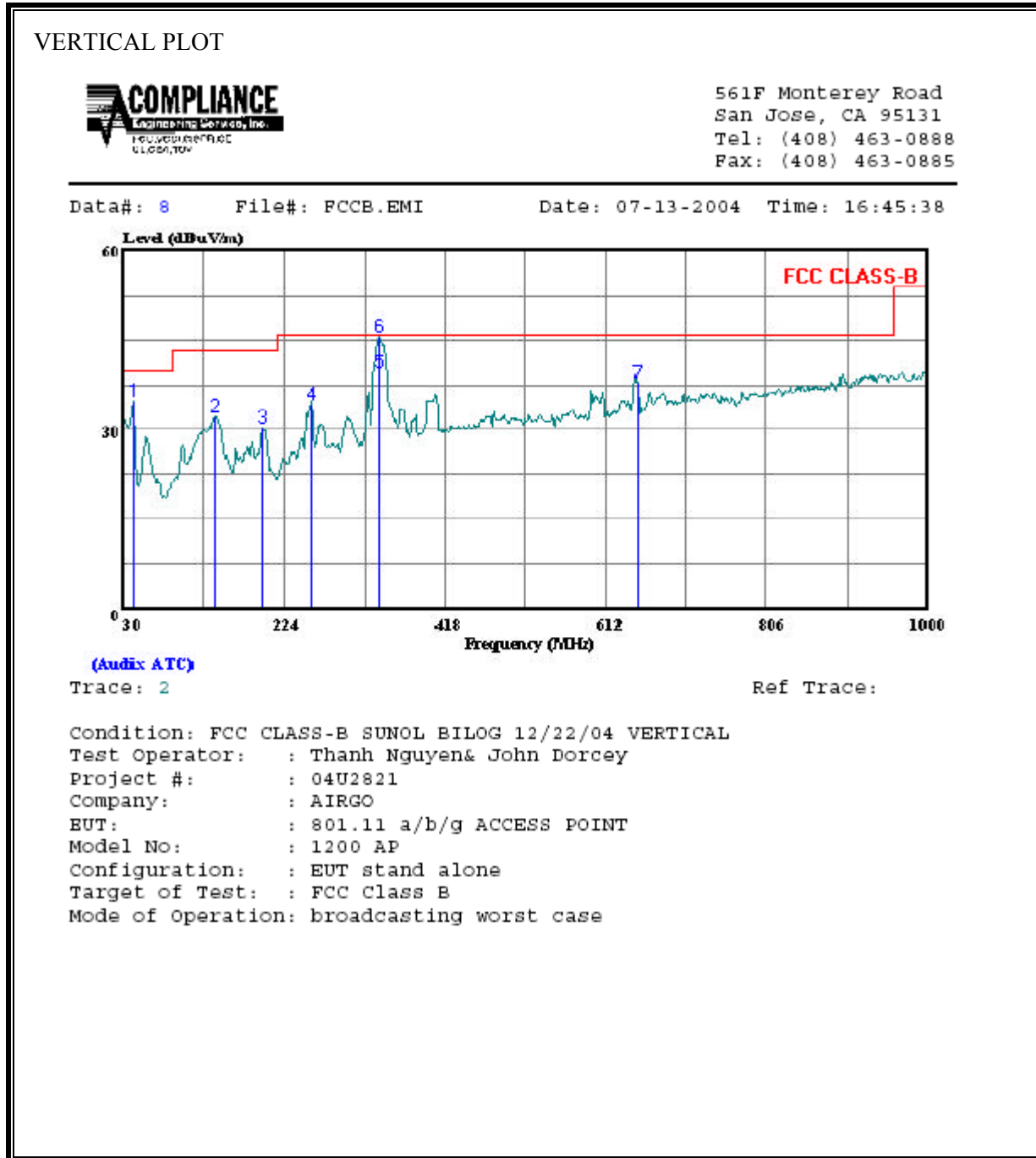

VERTICAL DATA

	Freq	Remark	Read Level	Factor	Level	Limit Line	Over Limit
	MHz		dBuV	dB	dBuV/m	dBuV/m	dB
1	41.640	Peak	18.94	15.74	34.68	40.00	-5.32
2	140.580	Peak	17.08	15.23	32.31	43.50	-11.19
3	196.840	Peak	17.03	13.36	30.39	43.50	-13.11
4	256.010	Peak	19.96	14.41	34.37	46.00	-11.63
5	337.490	QP	23.15	16.60	39.75	46.00	-6.25
6	337.490	Peak	29.07	16.61	45.68	46.00	-0.32
7	649.830	Peak	15.00	22.94	37.94	46.00	-8.06

7.9. POWERLINE CONDUCTED EMISSIONS

LIMIT

§15.207 (a) Except as shown in paragraphs (b) and (c) of this section, for an intentional radiator that is designed to be connected to the public utility (AC) power line, the radio frequency voltage that is conducted back onto the AC power line on any frequency or frequencies within the band 150 kHz to 30 MHz shall not exceed the limits in the following table, as measured using a 50 μ H/50 ohms line impedance stabilization network (LISN). Compliance with the provisions of this paragraph shall be based on the measurement of the radio frequency voltage between each power line and ground at the power terminal.

The lower limit applies at the boundary between the frequency ranges.

Frequency of Emission (MHz)	Conducted Limit (dBuV)	
	Quasi-peak	Average
0.15-0.5	66 to 56*	56 to 46*
0.5-5	56	46
5-30	60	50

* Decreases with the logarithm of the frequency.

TEST PROCEDURE

The EUT is placed on a non-conducting table 40 cm from the vertical ground plane and 80 cm above the horizontal ground plane. The EUT is configured in accordance with ANSI C63.4.

The resolution bandwidth is set to 9 kHz for both peak detection and quasi-peak detection measurements. Peak detection is used unless otherwise noted as quasi-peak.

Line conducted data is recorded for both NEUTRAL and HOT lines.

RESULTS

No non-compliance noted:

6 WORST EMISSIONS

CONDUCTED EMISSIONS DATA (115VAC 60Hz)									
Freq.	Reading			Closs	Limit	EN B	Margin		Remark
(MHz)	PK (dBuV)	QP (dBuV)	AV (dBuV)	(dB)	QP	AV	QP (dB)	AV (dB)	L1 / L2
0.71	49.22	--	34.76	0.00	56.00	46.00	-6.78	-11.24	L1
5.74	49.46	--	28.93	0.00	60.00	50.00	-10.54	-21.07	L1
0.42	48.72	--	39.05	0.00	58.37	48.37	-9.65	-9.32	L1
0.71	48.64	--	33.92	0.00	56.00	46.00	-7.36	-12.08	L2
0.42	48.55	--	38.97	0.00	58.37	48.37	-9.82	-9.40	L2
4.77	48.86	--	23.52	0.00	56.00	46.00	-7.14	-22.48	L2
6 Worst Data									

LINE 1 RESULTS

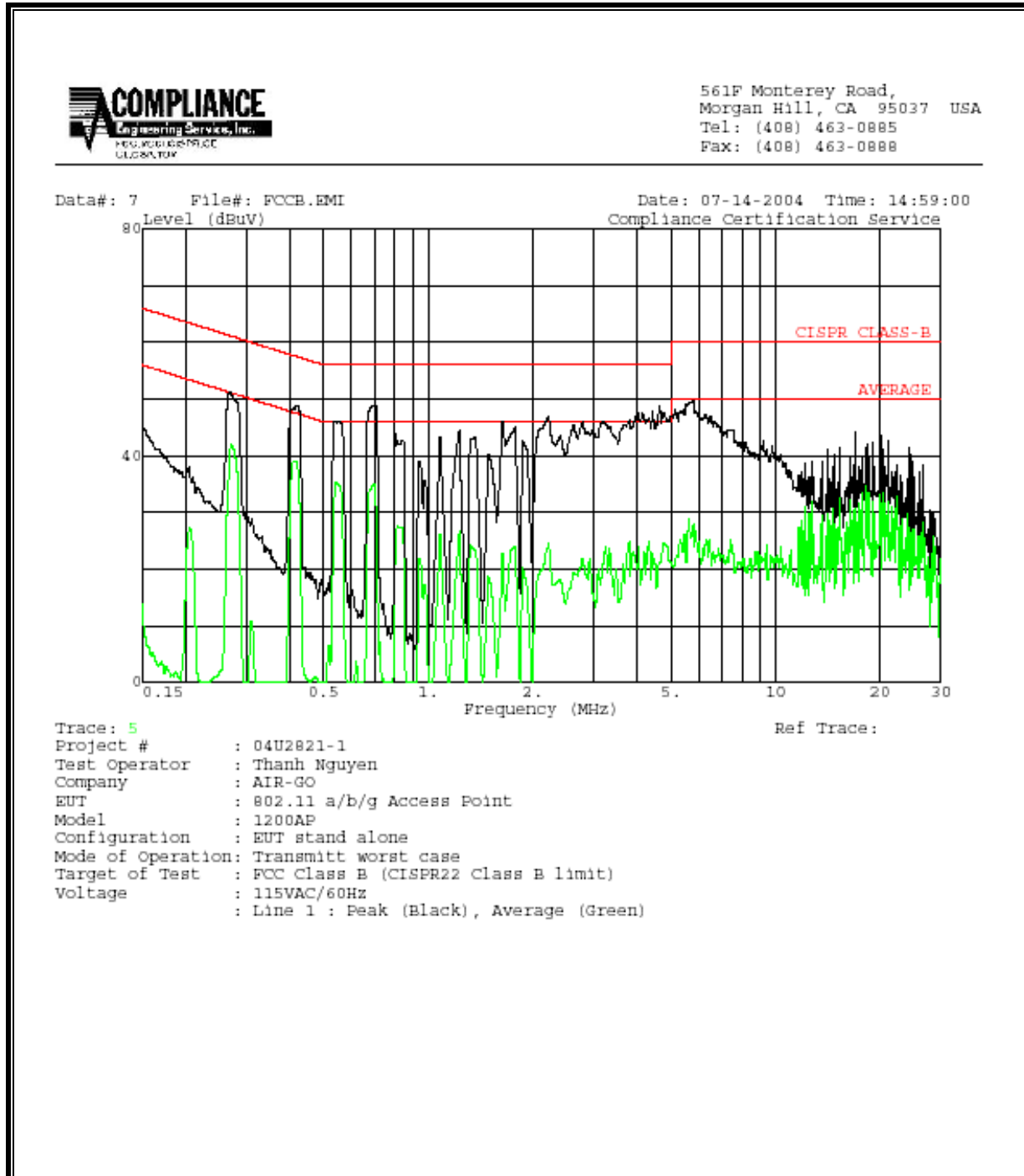

LINE 2 RESULTS

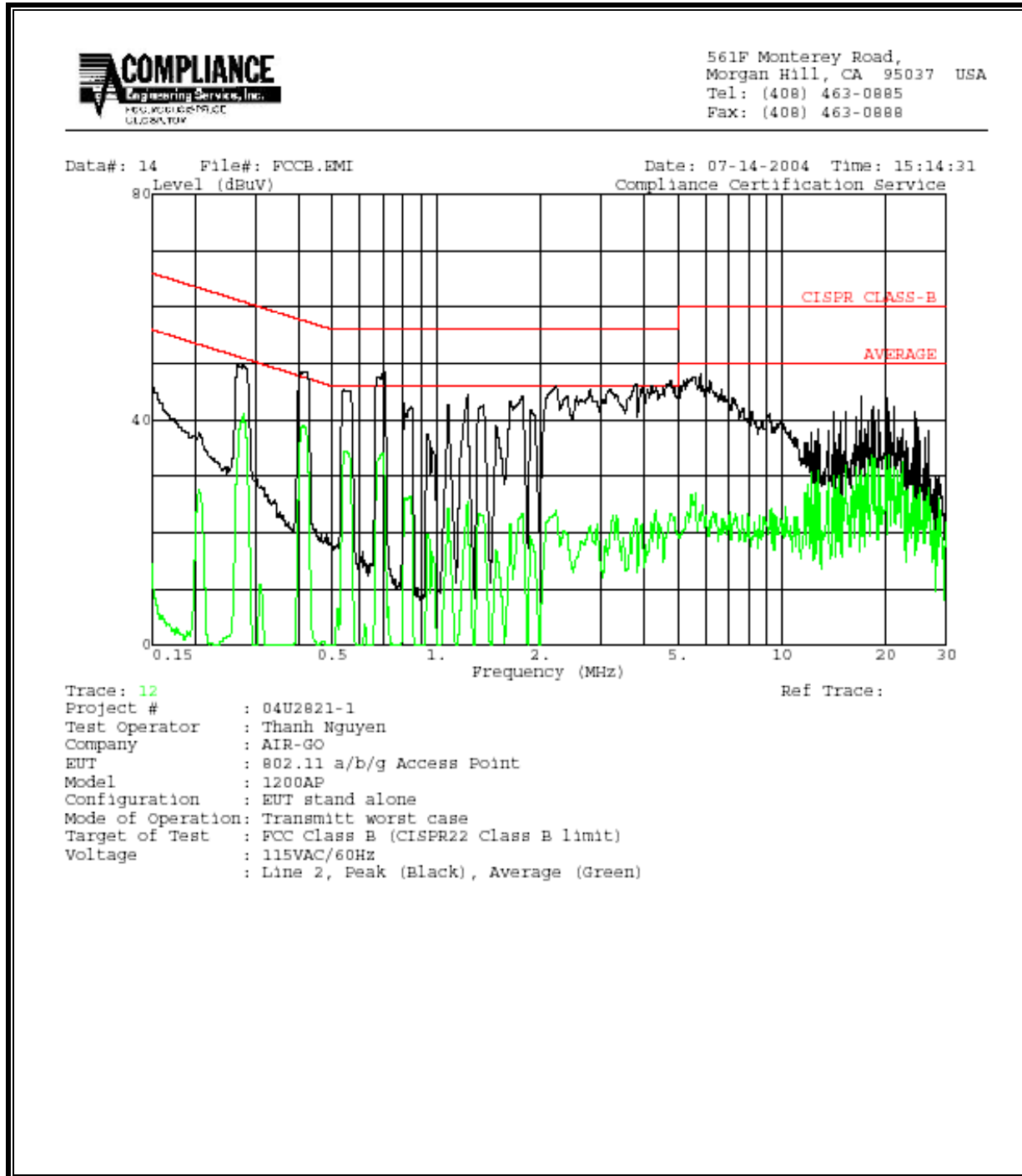

8. SETUP PHOTOS

ANTENNA PORT CONDUCTED RF MEASUREMENT SETUP

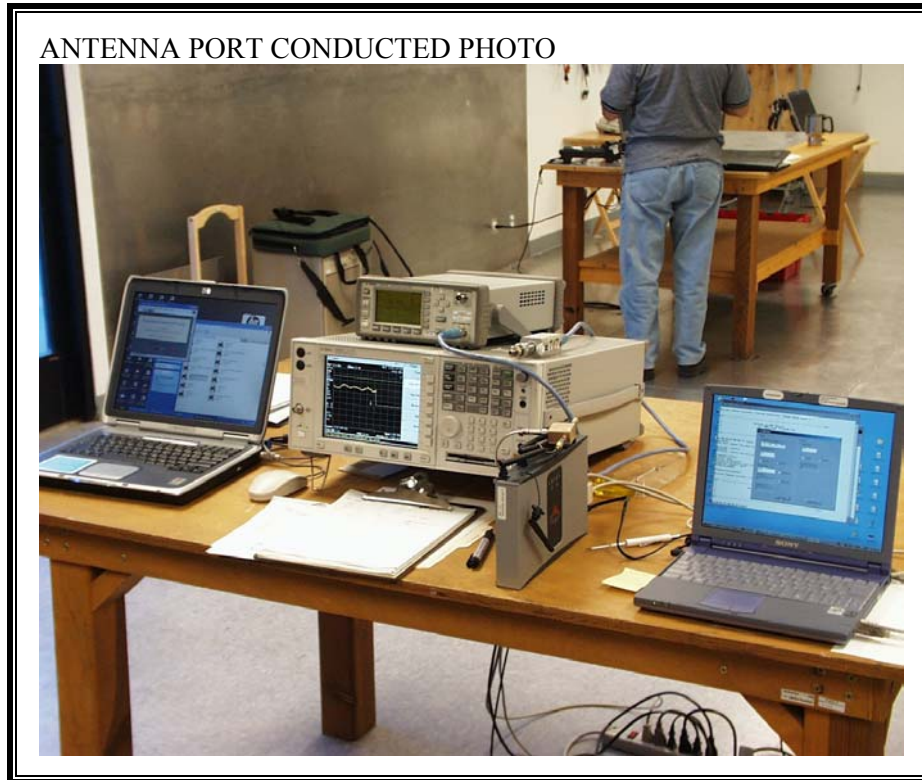

RADIATED RF MEASUREMENT SETUP

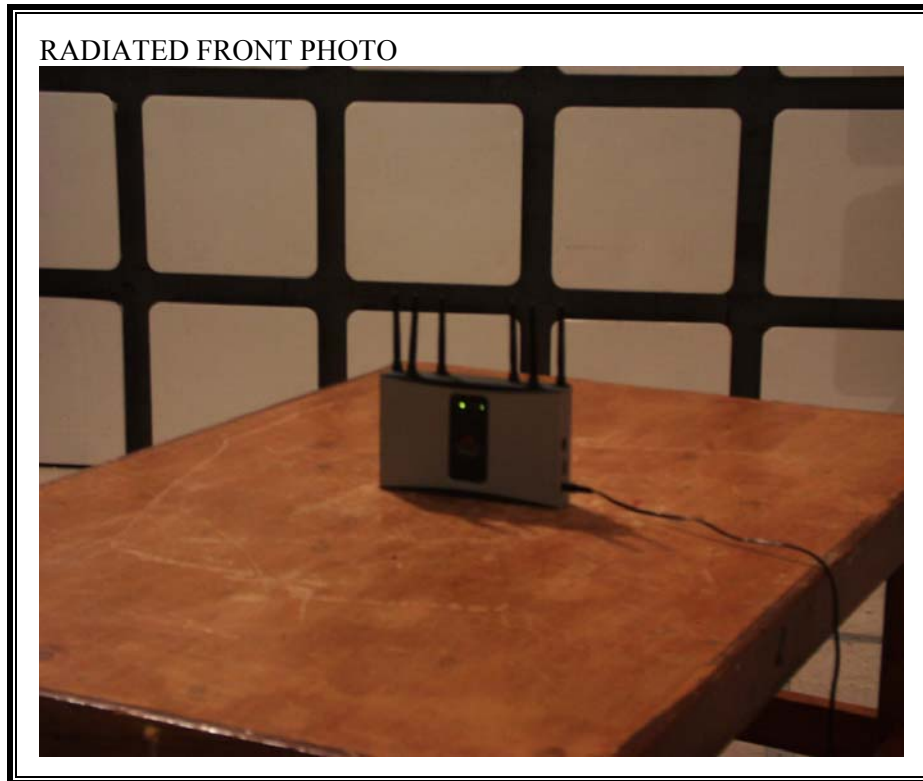

RADIATED BACK PHOTO



POWERLINE CONDUCTED EMISSIONS MEASUREMENT SETUP





END OF REPORT