



**FCC CFR47 PART 15 SUBPART C
CERTIFICATION**

TEST REPORT

FOR

TRUE MIMO ACCESS POINT

MODEL NUMBER: AGN1202AP

FCC ID: SA3-AGN1202AP0000

REPORT NUMBER: 04U2821-1

ISSUE DATE: JULY 27, 2004

Prepared for

**AIRGO NETWORKS INC.
900 ARASTRADERO ROAD
PALO ALTO, CA 94304, USA**

Prepared by

**COMPLIANCE CERTIFICATION SERVICES
561F MONTEREY ROAD,
MORGAN HILL, CA 95037, USA
TEL: (408) 463-0885
FAX: (408) 463-0888**



TABLE OF CONTENTS

1. TEST RESULT CERTIFICATION	3
2. EUT DESCRIPTION	4
3. TEST METHODOLOGY	5
4. FACILITIES AND ACCREDITATION	5
5. CALIBRATION AND UNCERTAINTY	6
5.1. <i>MEASURING INSTRUMENT CALIBRATION</i>	6
5.2. <i>MEASUREMENT UNCERTAINTY</i>	6
5.3. <i>TEST AND MEASUREMENT EQUIPMENT</i>	7
6. SETUP OF EQUIPMENT UNDER TEST	8
7. APPLICABLE LIMITS AND TEST RESULTS	10
7.1. <i>6 dB BANDWIDTH</i>	10
7.2. <i>99% BANDWIDTH</i>	21
7.3. <i>PEAK OUTPUT POWER</i>	32
7.4. <i>MAXIMUM PERMISSIBLE EXPOSURE</i>	44
7.5. <i>AVERAGE POWER</i>	47
7.6. <i>PEAK POWER SPECTRAL DENSITY</i>	49
7.7. <i>CONDUCTED SPURIOUS EMISSIONS</i>	60
7.8. <i>RADIATED EMISSIONS</i>	79
7.8.1. <i>TRANSMITTER RADIATED SPURIOUS EMISSIONS</i>	79
7.8.2. <i>TRANSMITTER RADIATED EMISSIONS ABOVE 1 GHZ</i>	82
7.8.3. <i>WORST-CASE RADIATED EMISSIONS BELOW 1 GHz</i>	101
7.9. <i>POWERLINE CONDUCTED EMISSIONS</i>	105
8. SETUP PHOTOS	109

1. TEST RESULT CERTIFICATION

COMPANY NAME: AIRGO NETWORKS INC
900 ARASTRADERO ROAD
PALO ALTO, CA 94304 U.S.A.

EUT DESCRIPTION: True MIMO Access Point

MODEL: AGN1202AP

DATE TESTED: JULY 7, 2004 to JULY 23, 2004

APPLICABLE STANDARDS	
STANDARD	TEST RESULTS
FCC PART 15 SUBPART C	NO NON-COMPLIANCE NOTED

Compliance Certification Services, Inc. tested the above equipment in accordance with the requirements set forth in the above standards. The test results show that the equipment tested is capable of demonstrating compliance with the requirements as documented in this report.

Note: This document reports conditions under which testing was conducted and results of tests performed. This document may not be altered or revised in any way unless done so by Compliance Certification Services and all revisions are duly noted in the revisions section. Any alteration of this document not carried out by Compliance Certification Services will constitute fraud and shall nullify the document.

Note: The 2.4 and 5.8 GHz bands are applicable to this report; another band of operation (5.2 GHz) is documented in a separate report.

Approved & Released For CCS By:

Tested By:

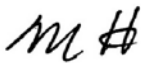

MICHAEL HECKROTTE
EMC MANAGER
COMPLIANCE CERTIFICATION SERVICES

THANH NGUYEN
EMC TECHNICIAN
COMPLIANCE CERTIFICATION SERVICES

2. EUT DESCRIPTION

The EUT is an 802.11a/b/g Access Point employs two transmitters and three receivers on each of two radio cards.

The transmitter has a maximum peak conducted output power as follows:

Frequency Band (MHz)	Mode	Output Power (dBm)	Output Power (mW)
2412 - 2462	802.11b	23.51	224.39
2412 - 2462	802.11g	25.13	325.84
5745 - 5805	802.11a	25.28	337.29

The radio utilizes five identical external dipole antennas for diversity, each with a maximum gain of 2dBi in 2.4GHz band and 3dBi in 5.8GHz band.

3. TEST METHODOLOGY

The tests documented in this report were performed in accordance with ANSI C63.4/2001, FCC CFR 47 Part 2 and FCC CFR 47 Part 15.

4. FACILITIES AND ACCREDITATION

The test sites and measurement facilities used to collect data are located at 561F Monterey Road, Morgan Hill, California, USA. The sites are constructed in conformance with the requirements of ANSI C63.4, ANSI C63.7 and CISPR Publication 22. All receiving equipment conforms to CISPR Publication 16-1, "Radio Interference Measuring Apparatus and Measurement Methods."

CCS is accredited by NVLAP, Laboratory Code 200065-0. The full scope of accreditation can be viewed at <http://www.ccsemc.com>.



No part of this report may be used to claim or imply product endorsement by NVLAP or any agency of the US Government.

5. CALIBRATION AND UNCERTAINTY

5.1. MEASURING INSTRUMENT CALIBRATION

The measuring equipment utilized to perform the tests documented in this report has been calibrated in accordance with the manufacturer's recommendations, and is traceable to recognized national standards.

5.2. MEASUREMENT UNCERTAINTY

Where relevant, the following measurement uncertainty levels have been estimated for tests performed on the apparatus:

PARAMETER	UNCERTAINTY
Radiated Emission, 30 to 200 MHz	+/- 3.3 dB
Radiated Emission, 200 to 1000 MHz	+4.5 / -2.9 dB
Radiated Emission, 1000 to 2000 MHz	+4.5 / -2.9 dB
Power Line Conducted Emission	+/- 2.9 dB

Uncertainty figures are valid to a confidence level of 95%.

5.3. TEST AND MEASUREMENT EQUIPMENT

The following test and measurement equipment were utilized for the tests documented in this report:

TEST EQUIPMENT LIST				
Description	Manufacturer	Model	Serial Number	Cal Due
Peak Power Meter	Agilent	E4416A	GB41291160	11/7/2004
Peak / Average Power Sensor	Agilent	E9327A	US40440755	11/7/2004
EMI Test Receiver	R & S	ESIB40	100192	11/21/2004
Antenna, Horn 1 ~ 18 GHz	EMCO	3117	29301	12/26/2004
Preamplifier, 1 ~ 26 GHz	Miteq	NSP10023988	646456	6/10/2005
EMI Receiver, 9 kHz ~ 2.9 GHz	HP	8542E	3942A00286	11/21/2004
RF Filter Section	HP	85420E	3705A00256	11/21/2004
30MHz---- 2Ghz	Sunol Sciences	JB1 Antenna	A121003	12/22/2004
Antenna, Horn 26 ~ 40 GHz	ARA	MWH-2640/B	1029	38324
Spectrum Analyzer	Agilent	E4446A	MY43360112	1/13/2005
EMI Test Receiver	R & S	ESHS 20	827129/006	7/17/2004
LISN, 10 kHz ~ 30 MHz	FCC	50/250-25-2	114	10/13/2004
LISN, 10 kHz ~ 30 MHz	Solar	8012-50-R-24-BNC	8379443	10/13/2004
AC Power Source, 10KVA	ACS	AFC-10K-AFC-2	J1568	CNR
Site A Line Stabilizer / Conditioner	Tripplite	LC-1800a	A0051681	CNR
PreAmplifier 26-40 GHz	MITEQ	NSP4000-SP2	924343	38139

6. SETUP OF EQUIPMENT UNDER TEST

SUPPORT EQUIPMENT

PERIPHERAL SUPPORT EQUIPMENT LIST				
Description	Manufacturer	Model	Serial Number	FCC ID
Laptop PC	Sony	PCG-5312	28315730 3303321	AK8JPN-35452-M5-E

I/O CABLES

I/O CABLE LIST						
Cable No.	Port	# of Identical Ports	Connector Type	Cable Type	Cable Length	Remarks
1	AC	2	US115	UNSHIELDED	2m	NO
2	DC	2	DC	UNSHIELDED	2m	NO
3	Serial	1	9 Pin	UNSHIELDED	2m	To PC USB Port
4	Ethernet	1	RJ 45	UNSHIELDED	2m	To PC RJ45 Port

TEST SETUP

The EUT was controlled by the laptop via Ethernet cable. The test software exercised the radio card during tests.

SETUP DIAGRAM FOR TESTS

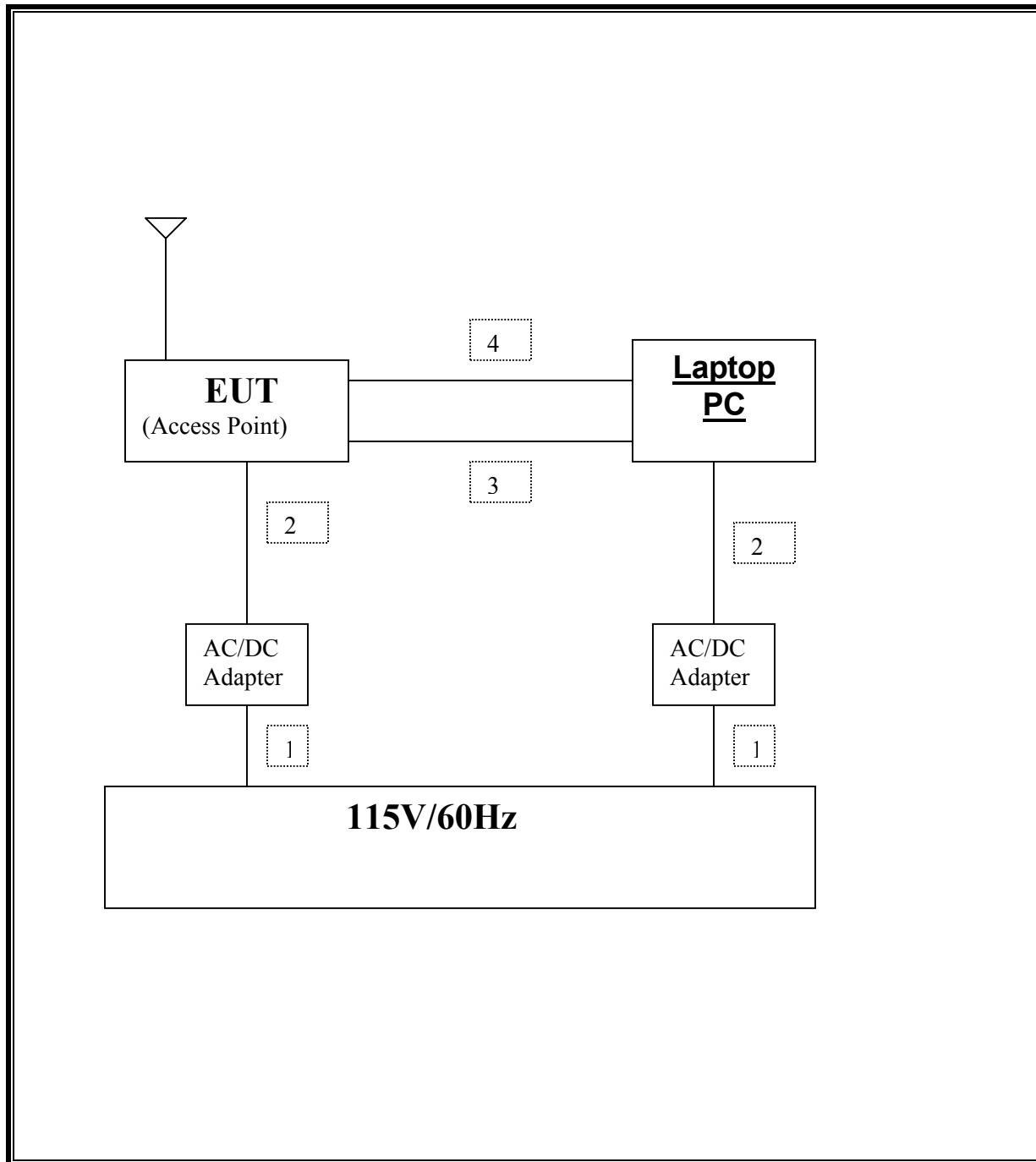

7. APPLICABLE LIMITS AND TEST RESULTS

7.1. 6 dB BANDWIDTH

LIMIT

§15.247 (a) (2) For direct sequence systems, the minimum 6 dB bandwidth shall be at least 500 kHz.

TEST PROCEDURE

The transmitter output is connected to a spectrum analyzer. The RBW is set to 100 kHz and the VBW is set to 300 kHz. The sweep time is coupled.

2.4 GHz BAND RESULTS

No non-compliance noted:

802.11b Mode

Channel	Frequency (MHz)	6 dB Bandwidth (kHz)	Minimum Limit (kHz)	Margin (kHz)
Low	2412	8580	500	8080
Middle	2437	9000	500	8500
High	2462	9500	500	9000

802.11g Mode

Channel	Frequency (MHz)	6 dB Bandwidth (kHz)	Minimum Limit (kHz)	Margin (kHz)
Low	2412	15330	500	14830
Middle	2437	15200	500	14700
High	2462	15330	500	14830

5.8 GHz BAND RESULTS

No non-compliance noted:

802.11a Mode

Channel	Frequency (MHz)	6 dB Bandwidth (kHz)	Minimum Limit (kHz)	Margin (kHz)
Low	5745	15750	500	15250
Middle	5785	15830	500	15330
High	5805	15670	500	15170

6 DB BANDWIDTH (802.11b MODE)

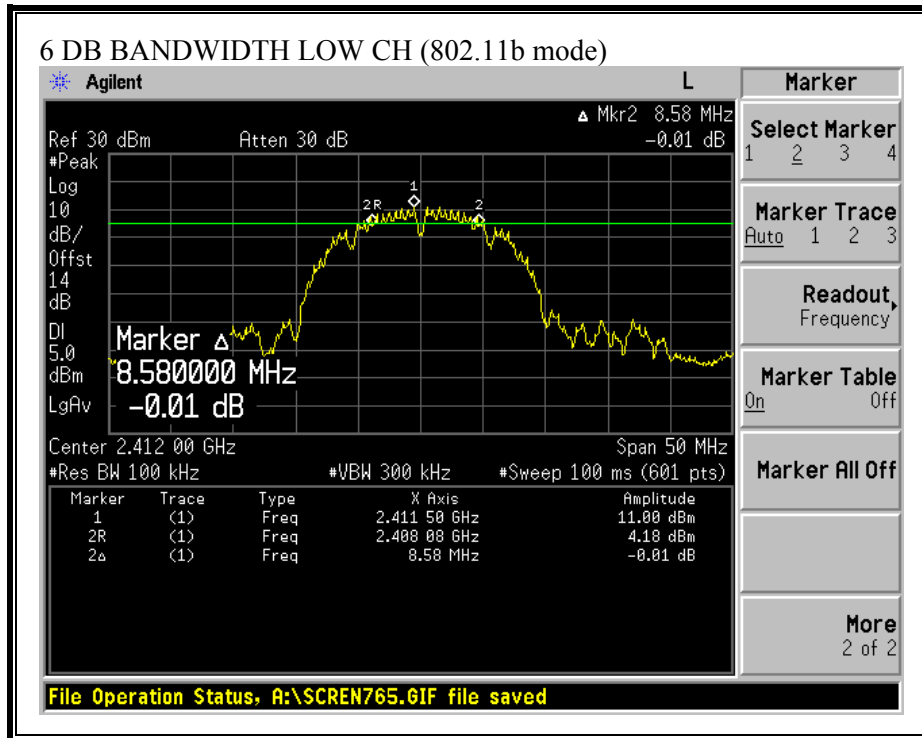

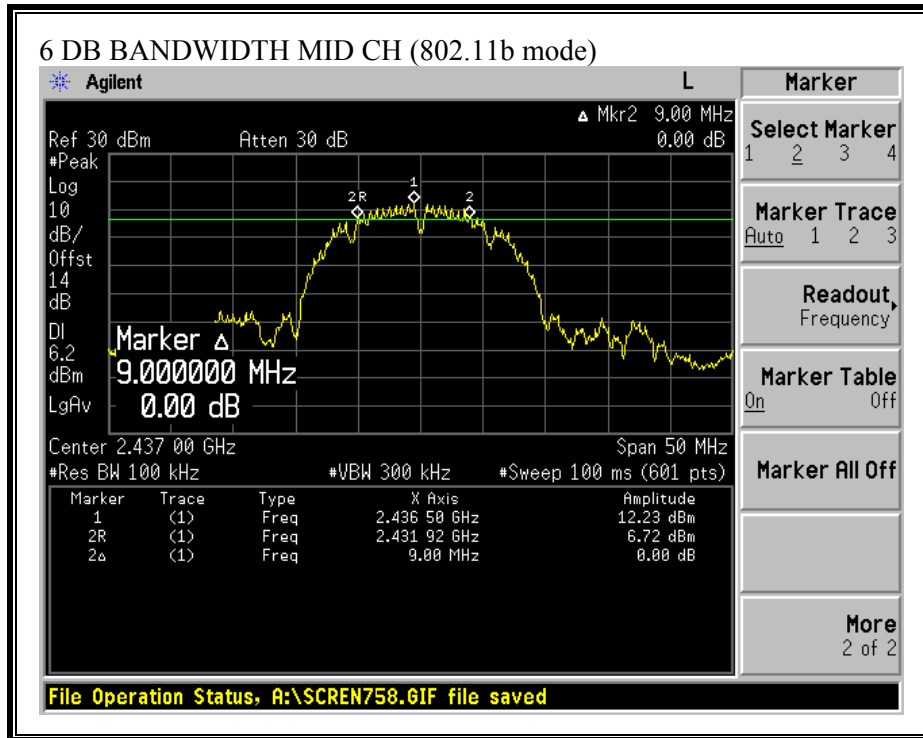

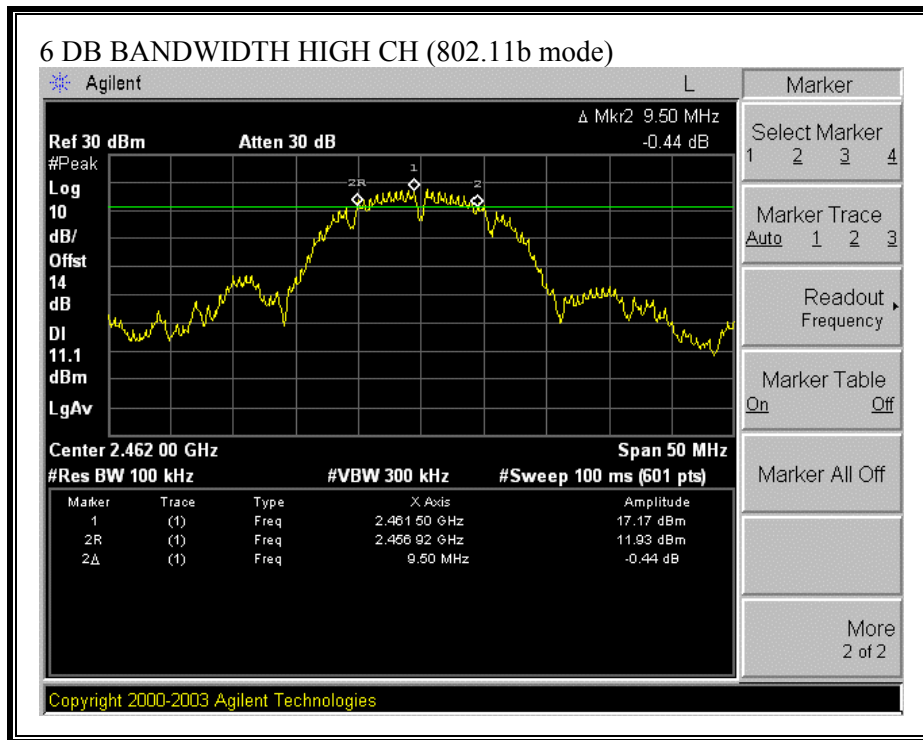

6 DB BANDWIDTH (802.11g MODE)

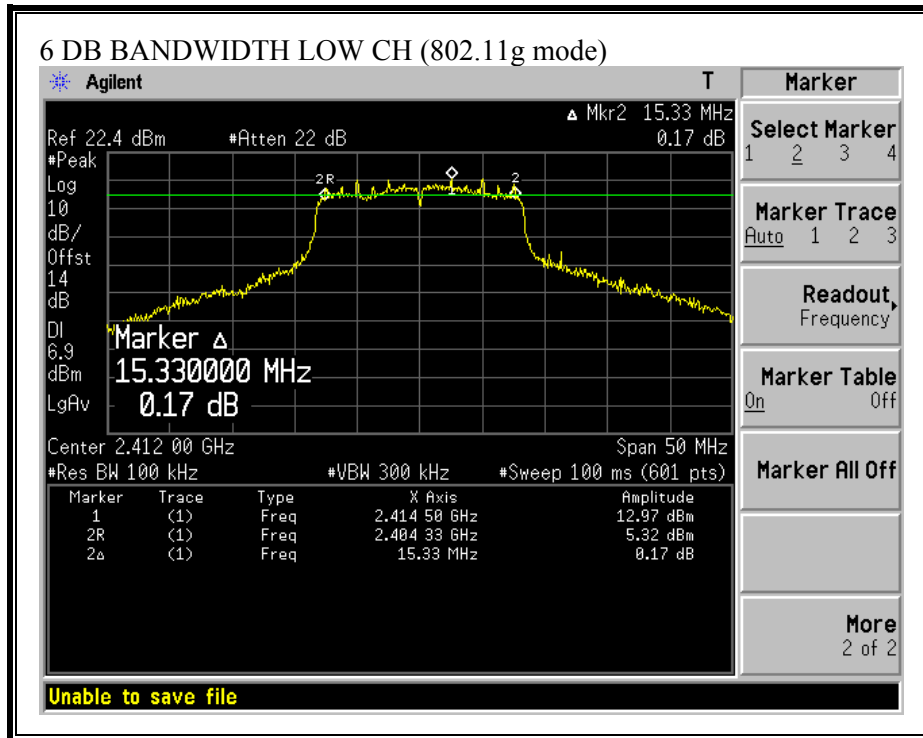

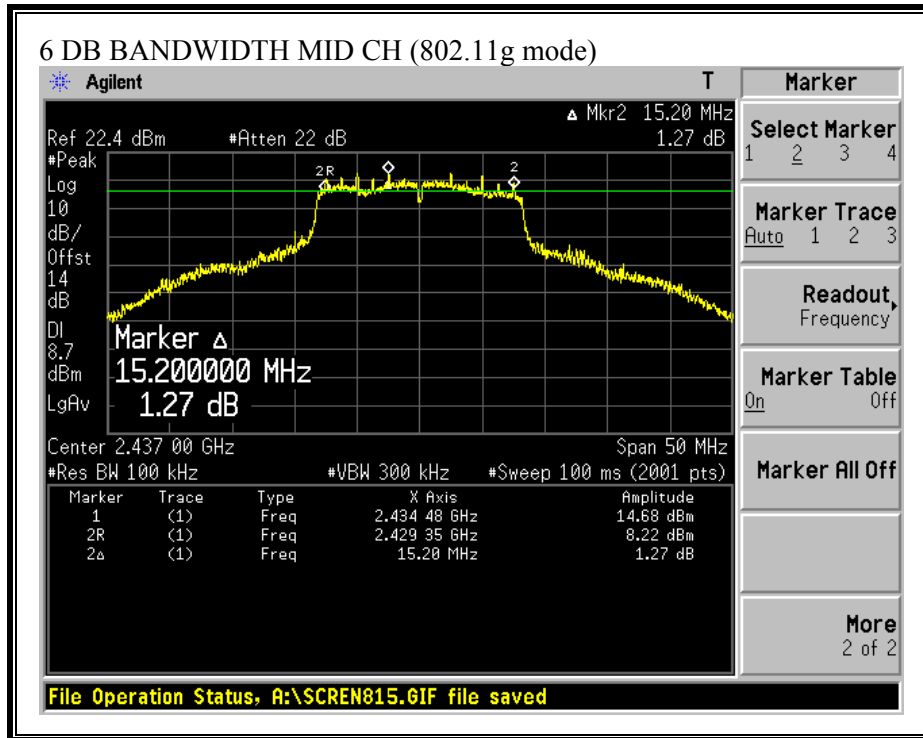

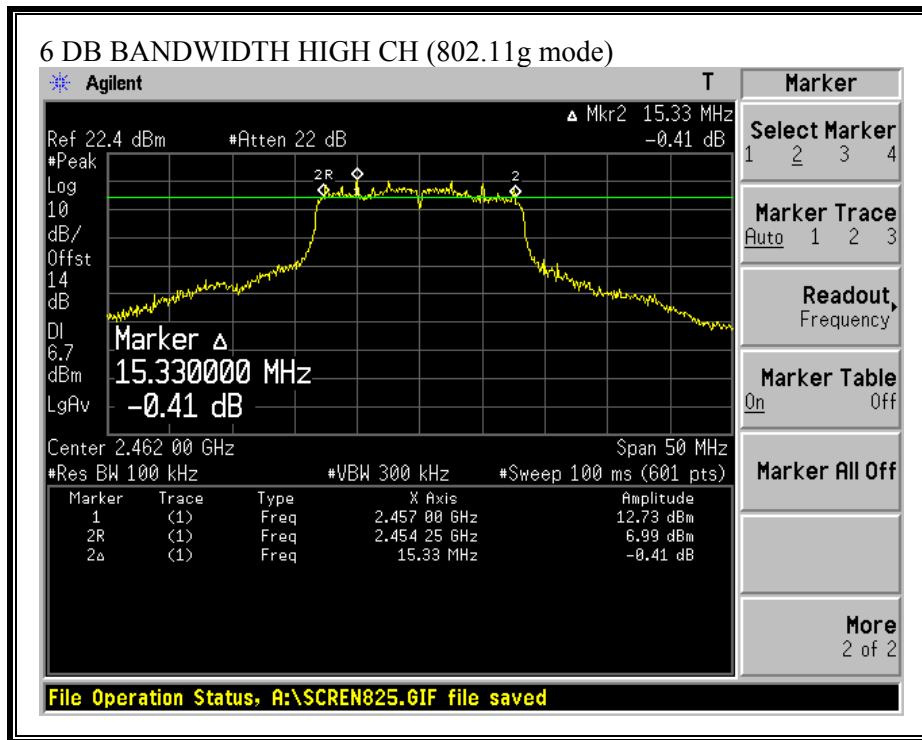

6 DB BANDWIDTH (802.11a MODE)

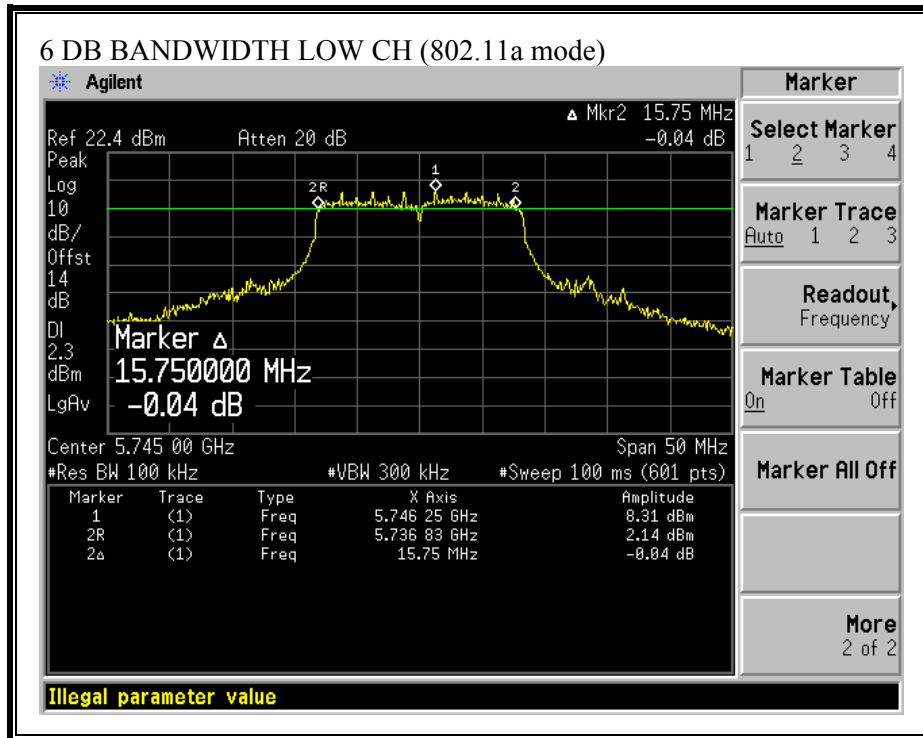

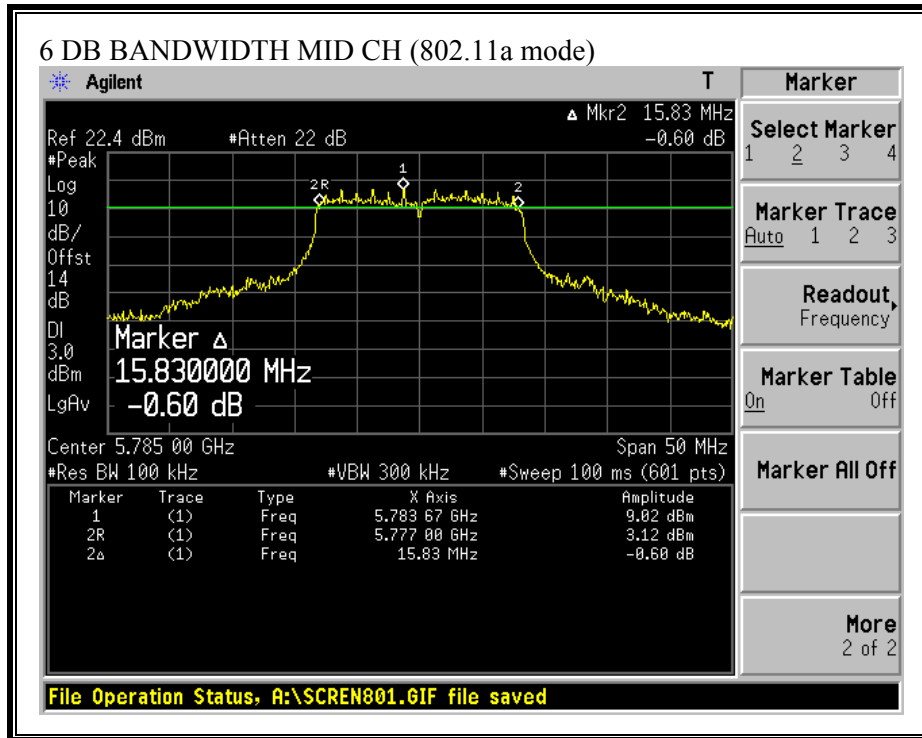

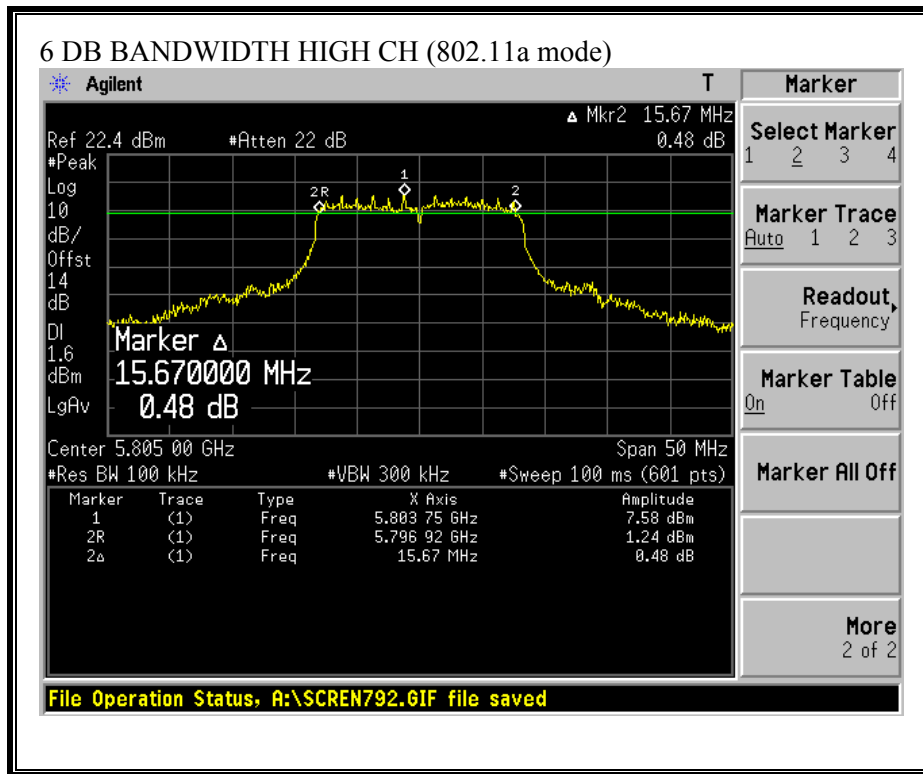

7.2. 99% BANDWIDTH

LIMIT

None: for reporting purposes only.

TEST PROCEDURE

The transmitter output is connected to the spectrum analyzer. The RBW is set to 1% to 3% of the 99 % bandwidth. The VBW is set to 3 times the RBW. The sweep time is coupled. The spectrum analyzer internal 99% bandwidth function is utilized.

2.4 GHz BAND RESULTS

No non-compliance noted:

802.11b Mode

Channel	Frequency (MHz)	99% Bandwidth (MHz)
Low	2412	14.3830
Middle	2437	14.6018
High	2462	15.0072

802.11g Mode

Channel	Frequency (MHz)	99% Bandwidth (MHz)
Low	2412	16.3246
Middle	2437	16.4114
High	2462	16.2537

5.8 GHz BAND RESULTS

No non-compliance noted:

802.11a Mode

Channel	Frequency (MHz)	99% Bandwidth (MHz)
Low	5745	16.5055
Middle	5785	16.4615
High	5805	16.5980

99% BANDWIDTH (802.11b MODE)

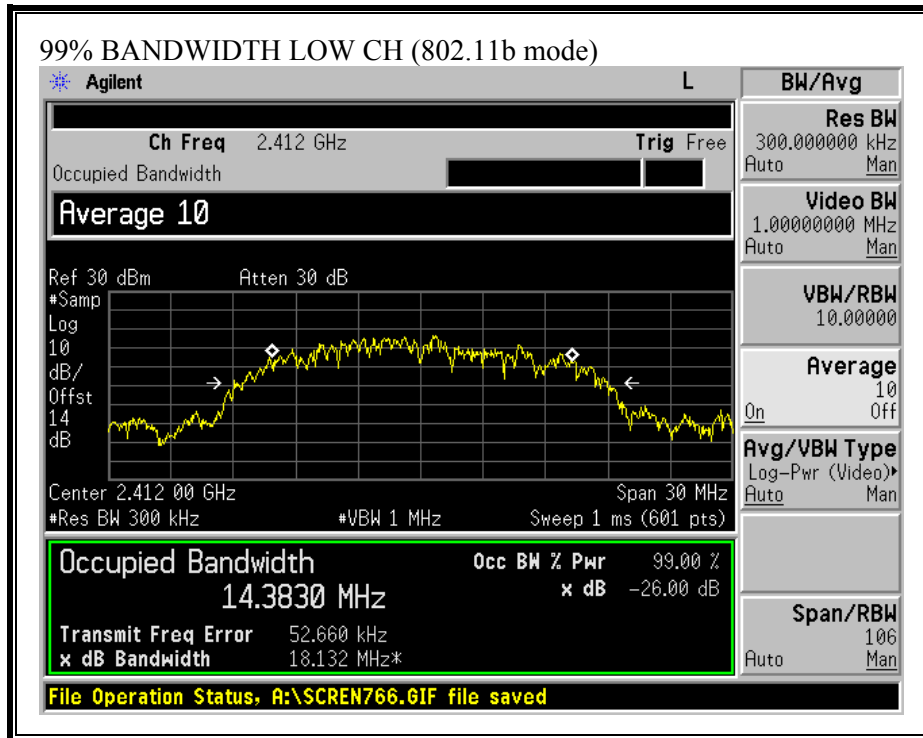

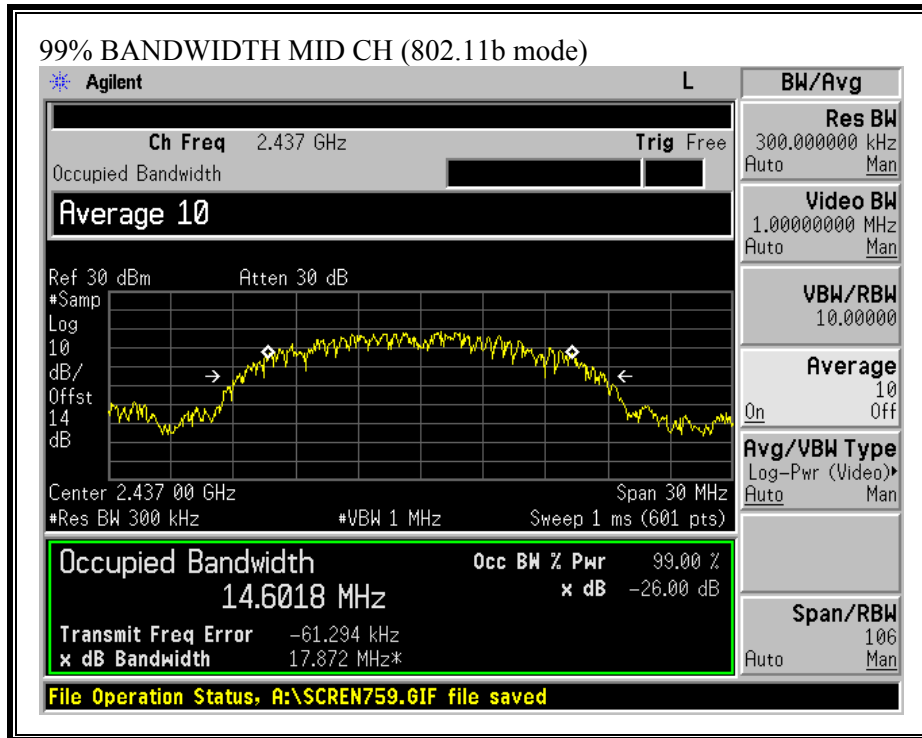

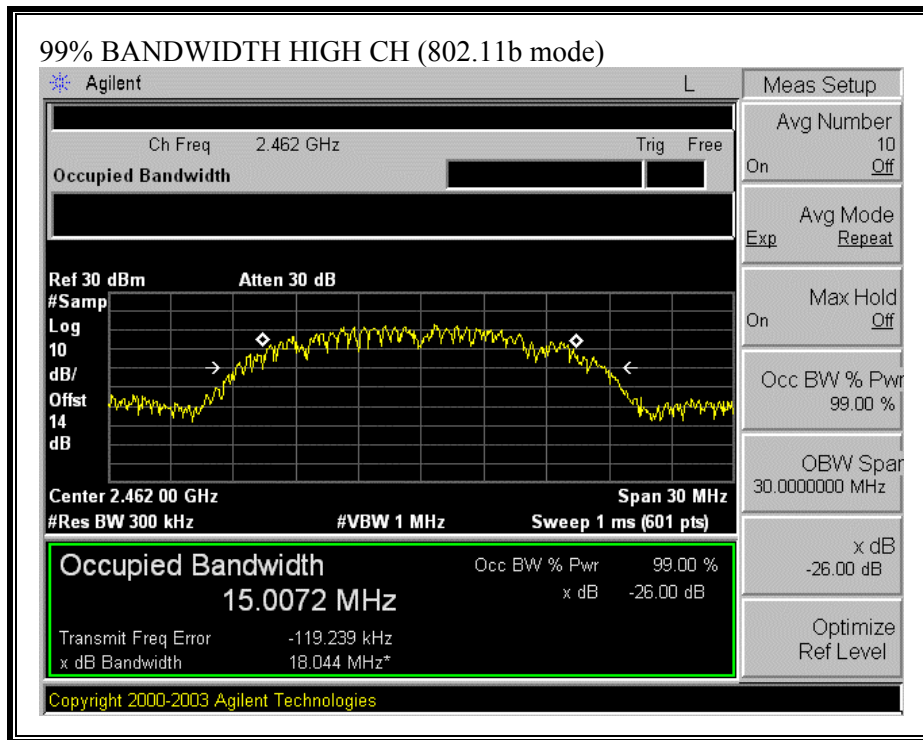

99% BANDWIDTH (802.11g MODE)

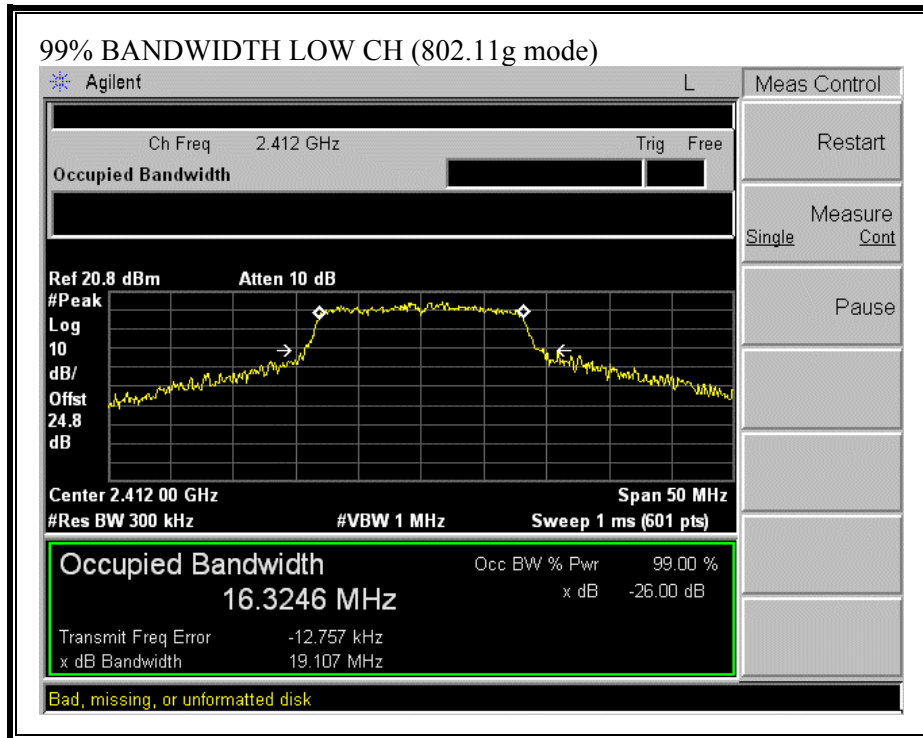

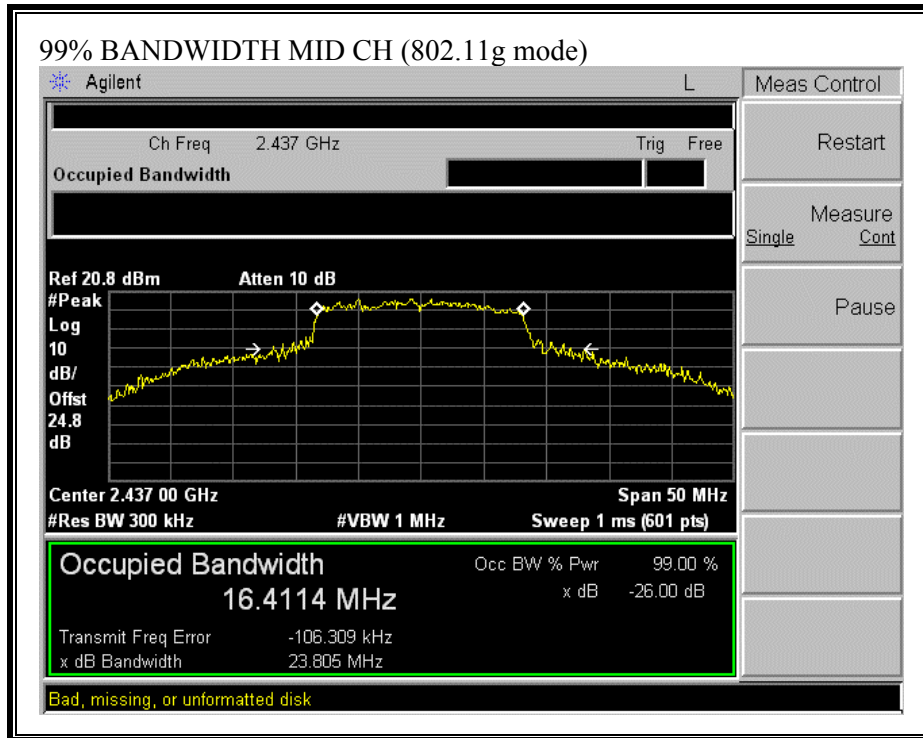

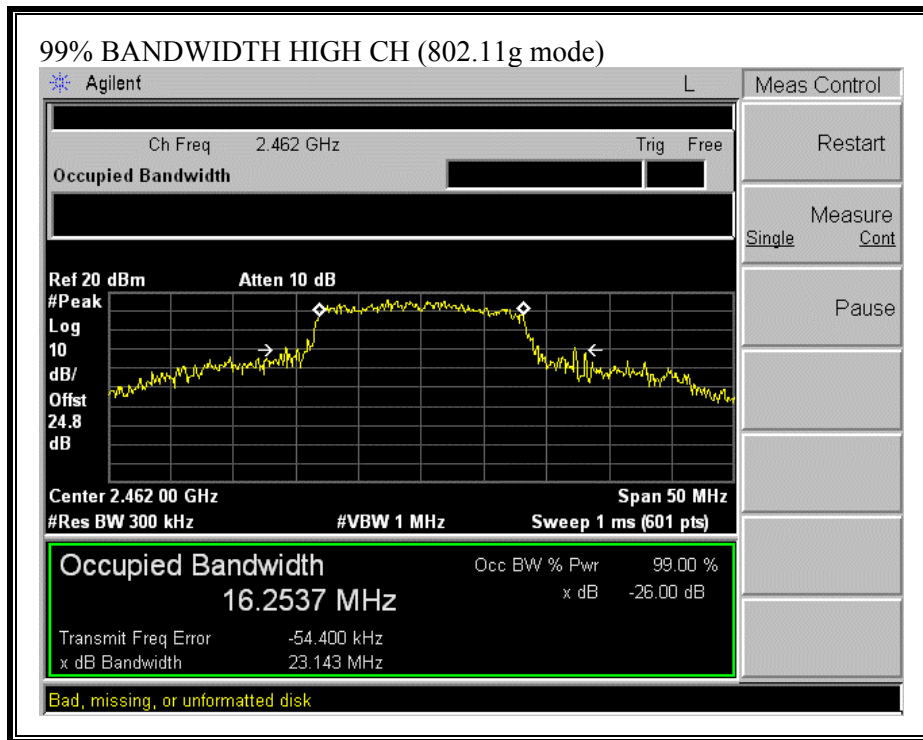

99% BANDWIDTH (802.11a MODE)

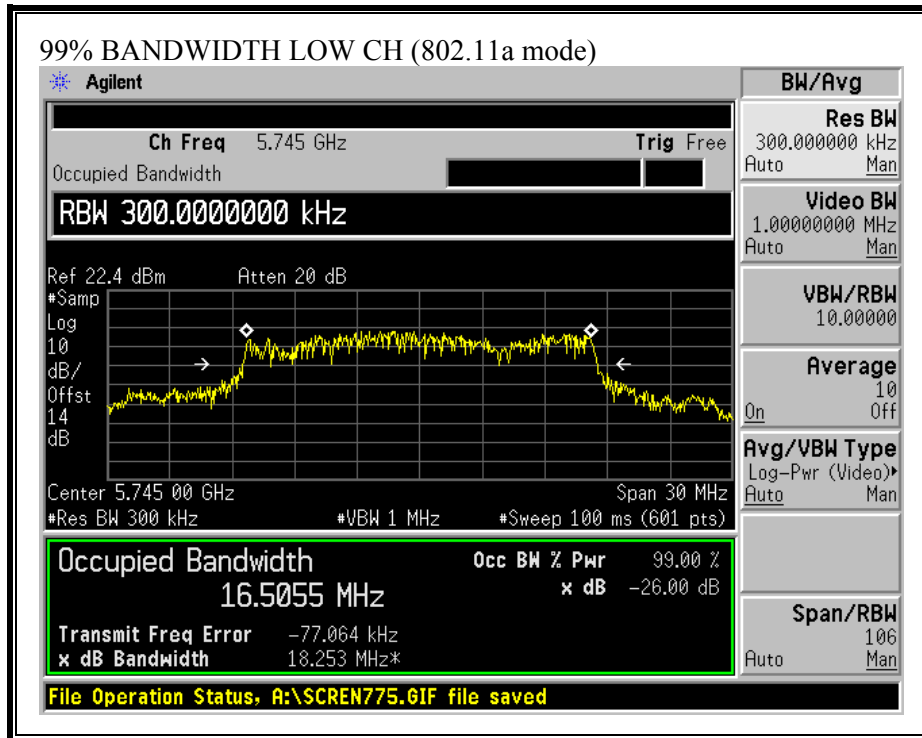

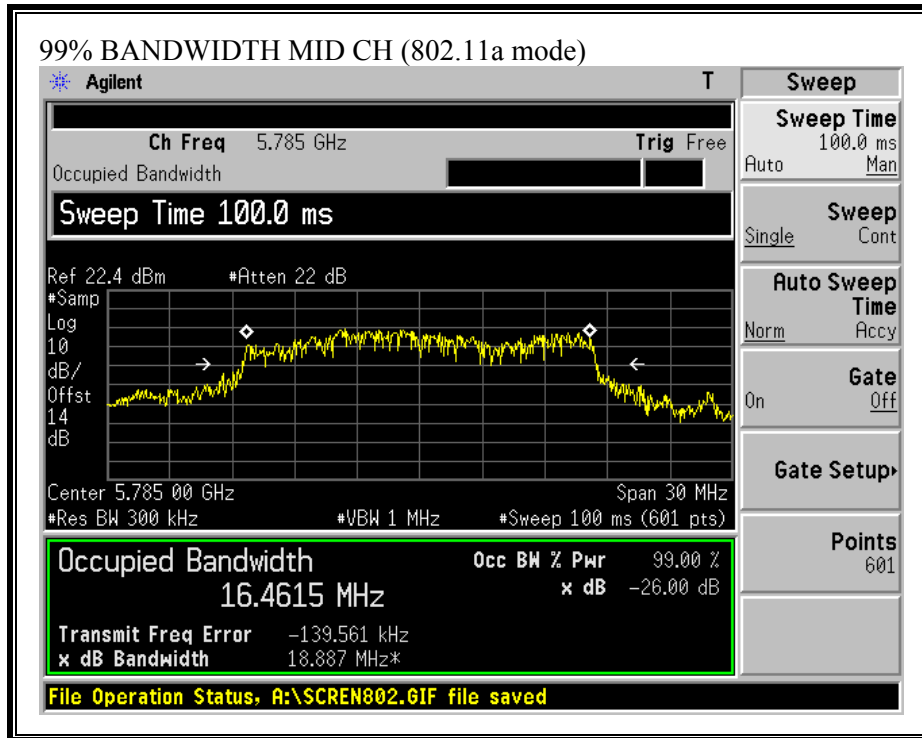

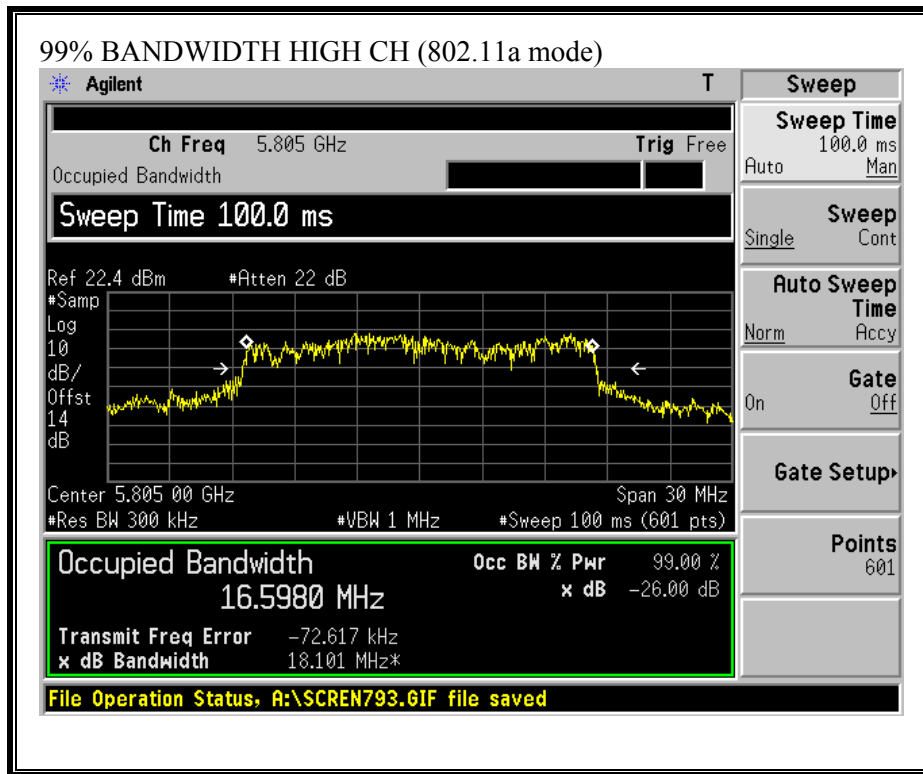

7.3. PEAK OUTPUT POWER

PEAK POWER LIMIT

§15.247 (b) The maximum peak output power of the intentional radiator shall not exceed the following:

§15.247 (b) (3) For systems using digital modulation in the 902-928 MHz, 2400-2483.5 MHz , and 5725-5850 MHz bands: 1 watt.

§15.247 (b) (4) Except as shown in paragraphs (b)(3) (i), (ii) and (iii) of this section, if transmitting antennas of directional gain greater than 6 dBi are used the peak output power from the intentional radiator shall be reduced below the stated values in paragraphs (b)(1) or (b)(2) of this section, as appropriate, by the amount in dB that the directional gain of the antenna exceeds 6 dBi.

The maximum antenna gain is 3 dBi, therefore the limit is 30 dBm.

TEST PROCEDURE

The transmitter output is connected to a spectrum analyzer and the analyzer's internal channel power integration function is used to integrate the power over a bandwidth greater than or equal to the 99% bandwidth.

2.4 GHZ BAND RESULTS

No non-compliance noted:

802.11b Mode

Channel	Frequency (MHz)	Peak Power (dBm)	Limit (dBm)	Margin (dB)
Low	2412	22.33	30	-7.67
Middle	2437	23.51	30	-6.49
High	2462	22.33	30	-7.67

802.11g Mode

Channel	Frequency (MHz)	Peak Power (dBm)	Limit (dBm)	Margin (dB)
Low	2412	25.13	30	-4.87
Middle	2437	24.70	30	-5.30
High	2462	24.75	30	-5.25

5.8 GHZ BAND RESULTS

No non-compliance noted:

802.11a Mode

Channel	Frequency (MHz)	Peak Power (dBm)	Limit (dBm)	Margin (dB)
Low	5745	24.89	30	-5.11
Middle	5785	25.28	30	-4.72
High	5805	23.85	30	-6.15

OUTPUT POWER (802.11b MODE)

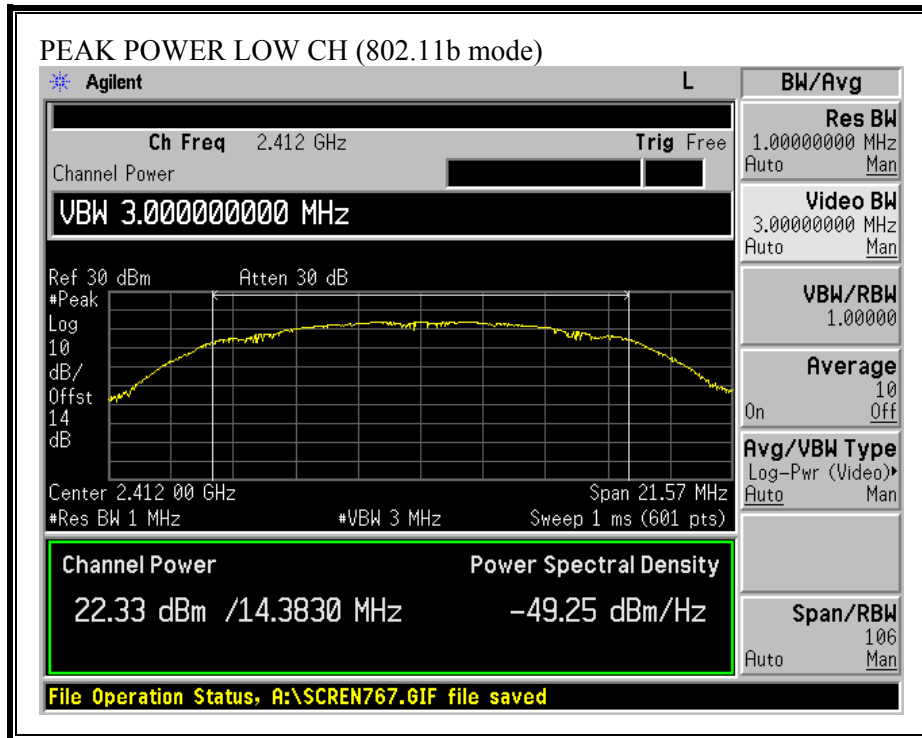

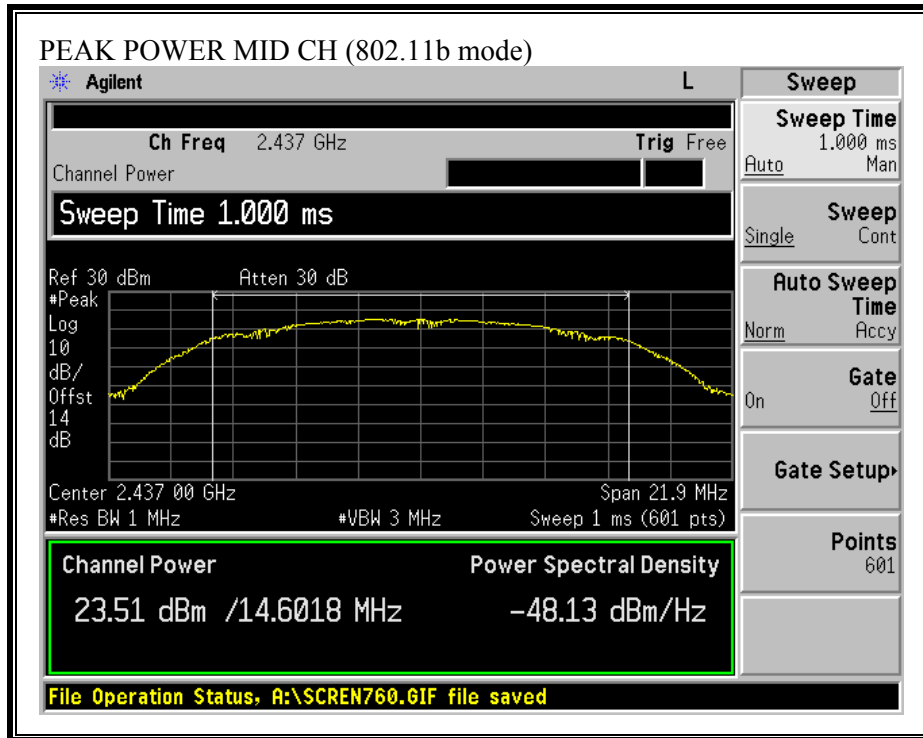

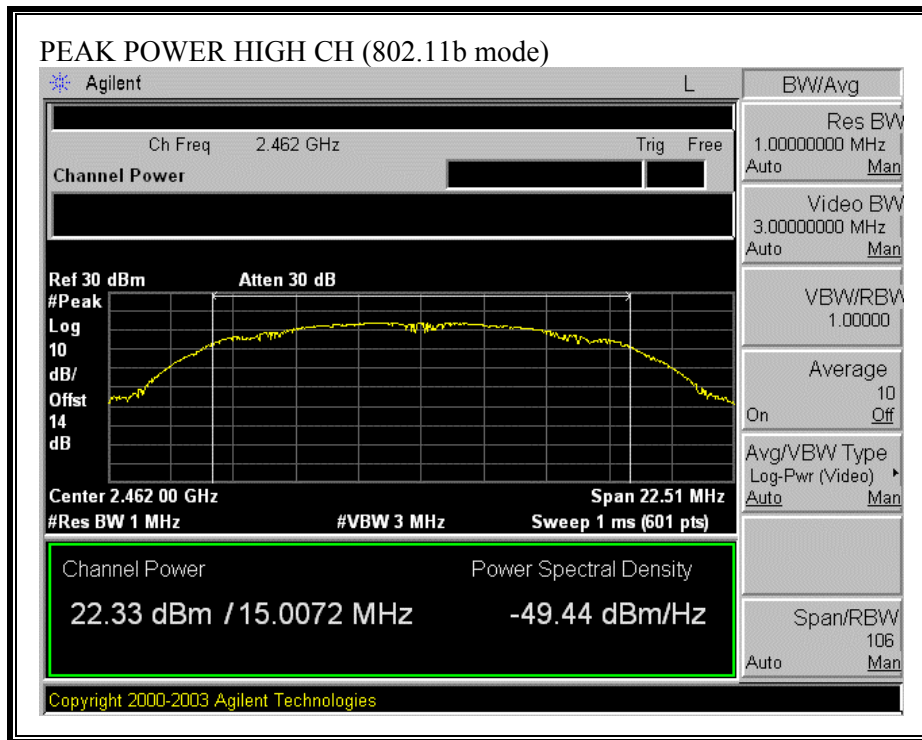

OUTPUT POWER (802.11g MODE)

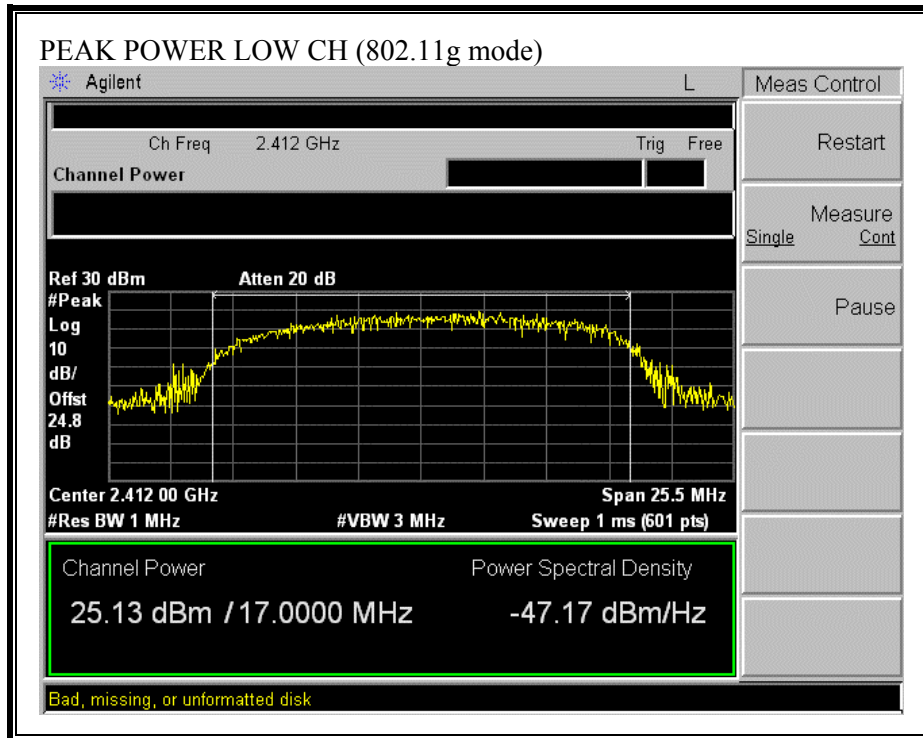

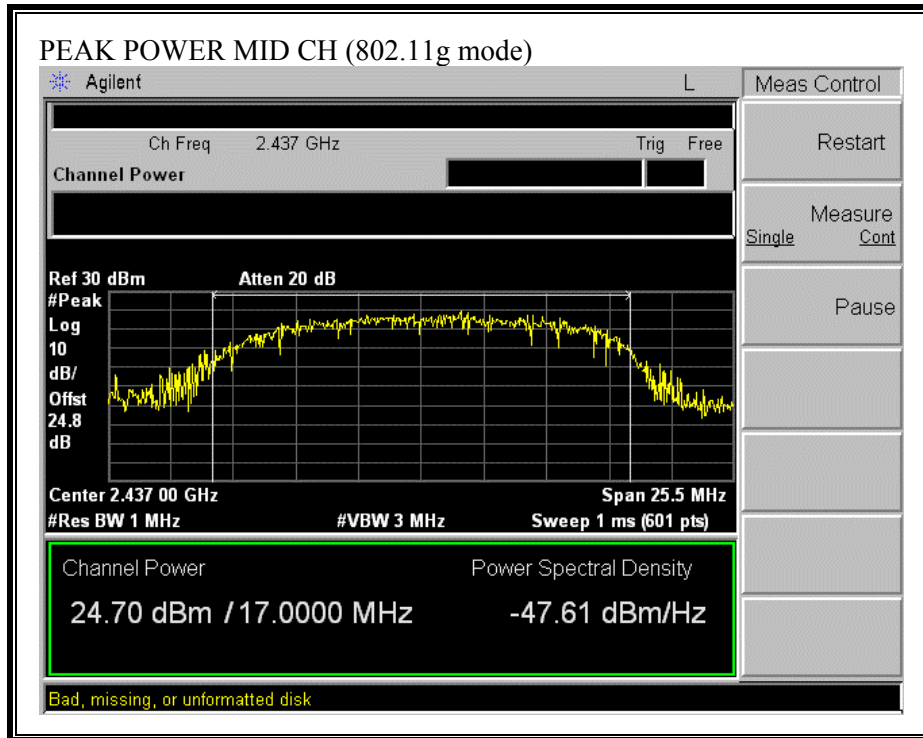

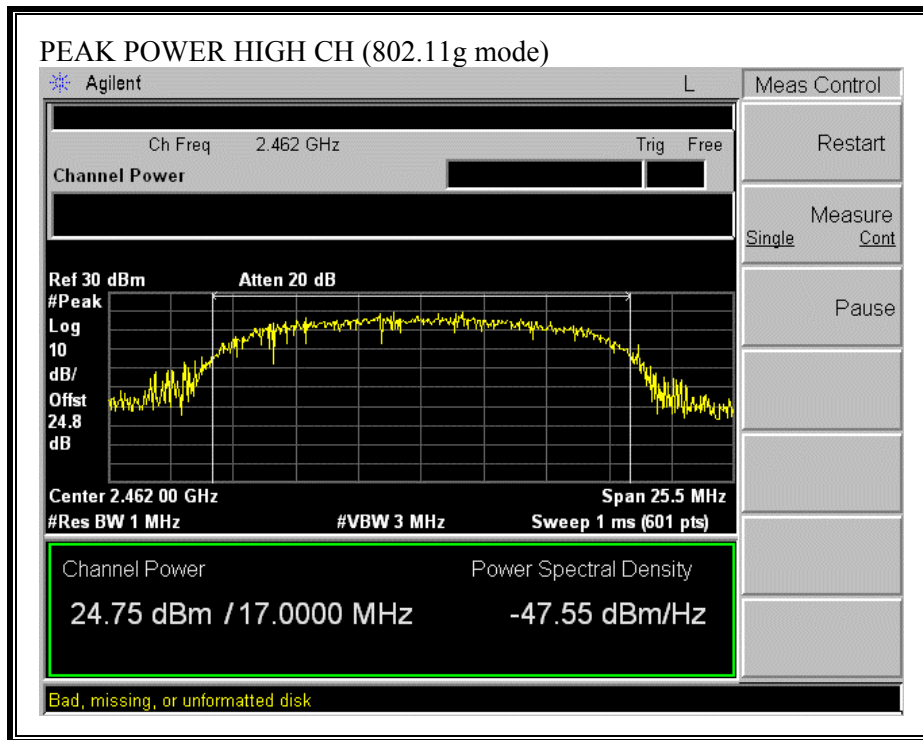

OUTPUT POWER (802.11a MODE)

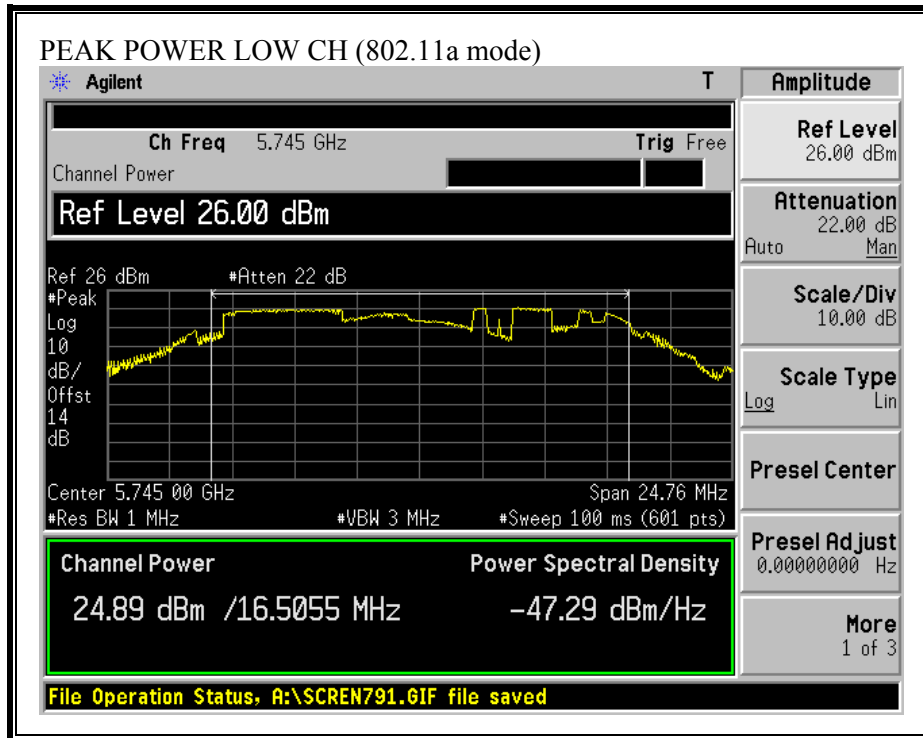

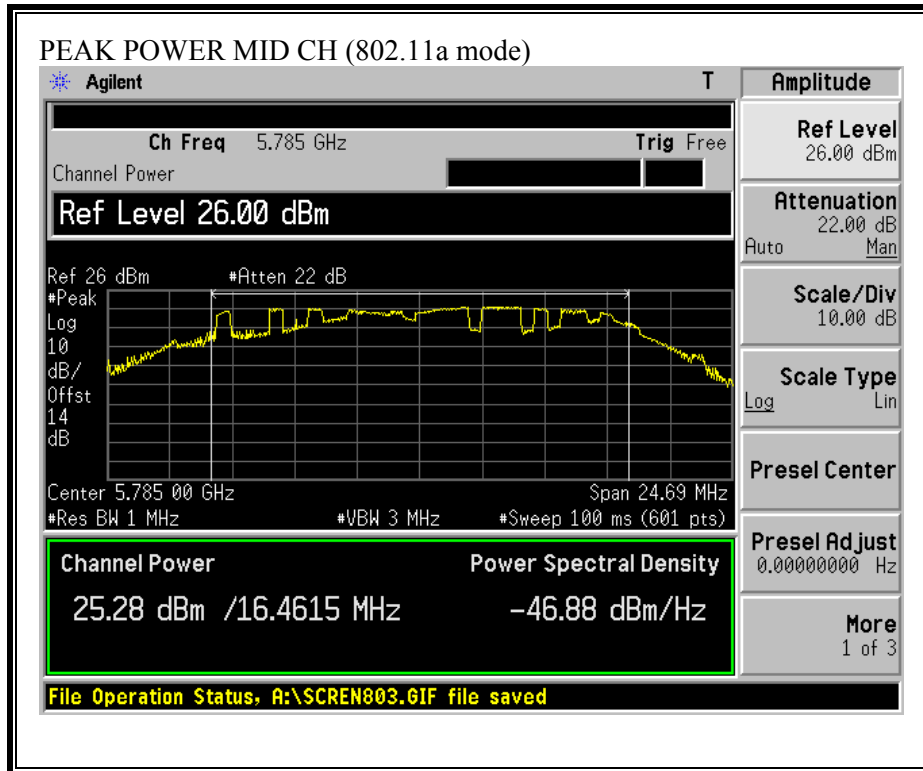

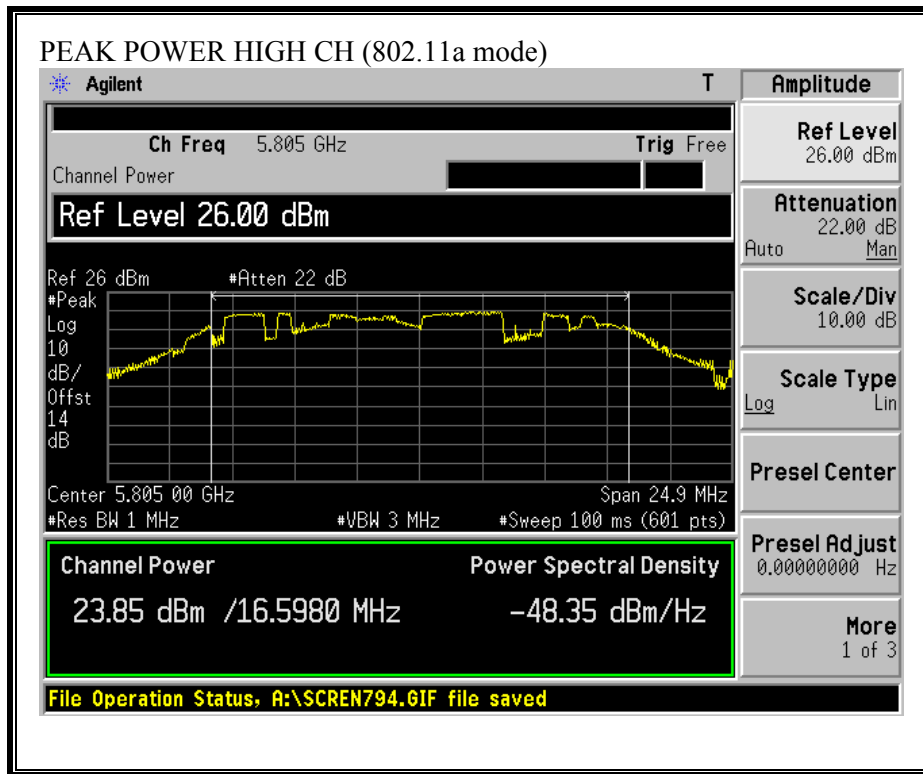

7.4. MAXIMUM PERMISSIBLE EXPOSURE

LIMITS

§1.1310 The criteria listed in Table 1 shall be used to evaluate the environmental impact of human exposure to radio-frequency (RF) radiation as specified in §1.1307(b), except in the case of portable devices which shall be evaluated according to the provisions of §2.1093 of this chapter.

TABLE 1—LIMITS FOR MAXIMUM PERMISSIBLE EXPOSURE (MPE)

Frequency range (MHz)	Electric field strength (V/m)	Magnetic field strength (A/m)	Power density (mW/cm ²)	Averaging time (minutes)
(A) Limits for Occupational/Controlled Exposures				
0.3–3.0	614	1.63	*(100)	6
3.0–30	1842/f	4.89/f	*(900/f ²)	6
30–300	61.4	0.163	1.0	6
300–1500	f/300	6
1500–100,000	5	6
(B) Limits for General Population/Uncontrolled Exposure				
0.3–1.34	614	1.63	*(100)	30
1.34–30	824/f	2.19/f	*(180/f ²)	30

TABLE 1—LIMITS FOR MAXIMUM PERMISSIBLE EXPOSURE (MPE)—Continued

Frequency range (MHz)	Electric field strength (V/m)	Magnetic field strength (A/m)	Power density (mW/cm ²)	Averaging time (minutes)
30–300	27.5	0.073	0.2	30
300–1500	f/1500	30
1500–100,000	1.0	30

f = frequency in MHz

* = Plane-wave equivalent power density

NOTE 1 TO TABLE 1: Occupational/controlled limits apply in situations in which persons are exposed as a consequence of their employment provided those persons are fully aware of the potential for exposure and can exercise control over their exposure. Limits for occupational/controlled exposure also apply in situations when an individual is transient through a location where occupational/controlled limits apply provided he or she is made aware of the potential for exposure.

NOTE 2 TO TABLE 1: General population/uncontrolled exposures apply in situations in which the general public may be exposed, or in which persons that are exposed as a consequence of their employment may not be fully aware of the potential for exposure or can not exercise control over their exposure.

CALCULATIONS

Given

$$E = \sqrt{(30 * P * G) / d}$$

and

$$S = E^2 / 3770$$

where

E = Field Strength in Volts/meter

P = Power in Watts

G = Numeric antenna gain

d = Distance in meters

S = Power Density in milliwatts/square centimeter

Combining equations and rearranging the terms to express the distance as a function of the remaining variables yields:

$$d = \sqrt{((30 * P * G) / (3770 * S))}$$

Changing to units of Power to mW and Distance to cm, using:

$$P \text{ (mW)} = P \text{ (W)} / 1000 \text{ and}$$

$$d \text{ (cm)} = 100 * d \text{ (m)}$$

yields

$$d = 100 * \sqrt{((30 * (P / 1000) * G) / (3770 * S))}$$

$$d = 0.282 * \sqrt{(P * G / S)}$$

where

d = distance in cm

P = Power in mW

G = Numeric antenna gain

S = Power Density in mW/cm²

Substituting the logarithmic form of power and gain using:

$$P \text{ (mW)} = 10^{(P \text{ (dBm)} / 10)} \text{ and}$$

$$G \text{ (numeric)} = 10^{(G \text{ (dBi)} / 10)}$$

yields

$$d = 0.282 * 10^{((P + G) / 20)} / \sqrt{S} \quad \text{Equation (1)}$$

where

d = MPE distance in cm

P = Power in dBm

G = Antenna Gain in dBi

S = Power Density Limit in mW/cm²

Equation (1) and the measured peak power is used to calculate the MPE distance.

LIMITS

From §1.1310 Table 1 (B), $S = 1.0 \text{ mW/cm}^2$

2.4 GHz BAND RESULTS

No non-compliance noted:

Mode	Power Density Limit (mW/cm²)	Output Power (dBm)	Antenna Gain (dBi)	MPE Distance (cm)
802.11b	1.0	23.51	2.00	5.32
802.11g	1.0	25.13	2.00	6.41

5.8 GHz BAND RESULTS

No non-compliance noted:

Mode	Power Density Limit (mW/cm²)	Output Power (dBm)	Antenna Gain (dBi)	MPE Distance (cm)
802.11a	1.0	25.28	3.00	7.32

NOTE: For mobile or fixed location transmitters, the minimum separation distance is 20 cm, even if calculations indicate that the MPE distance would be less.

7.5. AVERAGE POWER

AVERAGE POWER LIMIT

None; for reporting purposes only.

TEST PROCEDURE

The transmitter output is connected to a power meter.

2.4 GHZ BAND RESULTS

No non-compliance noted:

The cable assembly insertion loss of 11.1 dB (including 10 dB pad and 1.1 dB cable) was entered as an offset in the power meter to allow for direct reading of power.

802.11b Mode

Channel	Frequency (MHz)	Average Power (dBm)
Low	2412	20.84
Middle	2437	20.72
High	2462	19.37

802.11g Mode

Channel	Frequency (MHz)	Average Power (dBm)
Low	2412	20.20
Middle	2437	19.90
High	2462	20.10

5.8 GHZ BAND RESULTS

No non-compliance noted:

The cable assembly insertion loss of 12.2 dB (including 10 dB pad and 2.2 dB cable) was entered as an offset in the power meter to allow for direct reading of power.

802.11a Mode

Channel	Frequency (MHz)	Average Power (dBm)
Low	5745	19.75
Middle	5785	18.63
High	5805	17.10

7.6. PEAK POWER SPECTRAL DENSITY

LIMIT

§15.247 (d) For direct sequence systems, the peak power spectral density conducted from the intentional radiator to the antenna shall not be greater than 8 dBm in any 3 kHz band during any time interval of continuous transmission.

TEST PROCEDURE

The transmitter output is connected to a spectrum analyzer, the maximum level in a 3 kHz bandwidth is measured with the spectrum analyzer using RBW = 3 kHz and VBW > 3 kHz, sweep time = span / 3 kHz, and video averaging is turned off. The PPSD is the highest level found across the emission in any 3 kHz band.

2.4 GHz BAND RESULTS

No non-compliance noted:

802.11b Mode

Channel	Frequency (MHz)	PPSD (dBm)	Limit (dBm)	Margin (dB)
Low	2412	5.19	8	-2.81
Middle	2437	-0.31	8	-8.31
High	2462	3.32	8	-4.68

802.11g Mode

Channel	Frequency (MHz)	PPSD (dBm)	Limit (dBm)	Margin (dB)
Low	2412	-4.67	8	-12.67
Middle	2437	-0.94	8	-8.94
High	2462	-2.02	8	-10.02

5.8 GHz BAND RESULTS

No non-compliance noted:

802.11a Mode

Channel	Frequency (MHz)	PPSD (dBm)	Limit (dBm)	Margin (dB)
Low	5745	-6.22	8	-14.22
Middle	5785	-3.09	8	-11.09
High	5805	-5.91	8	-13.91

PEAK POWER SPECTRAL DENSITY (802.11b MODE)

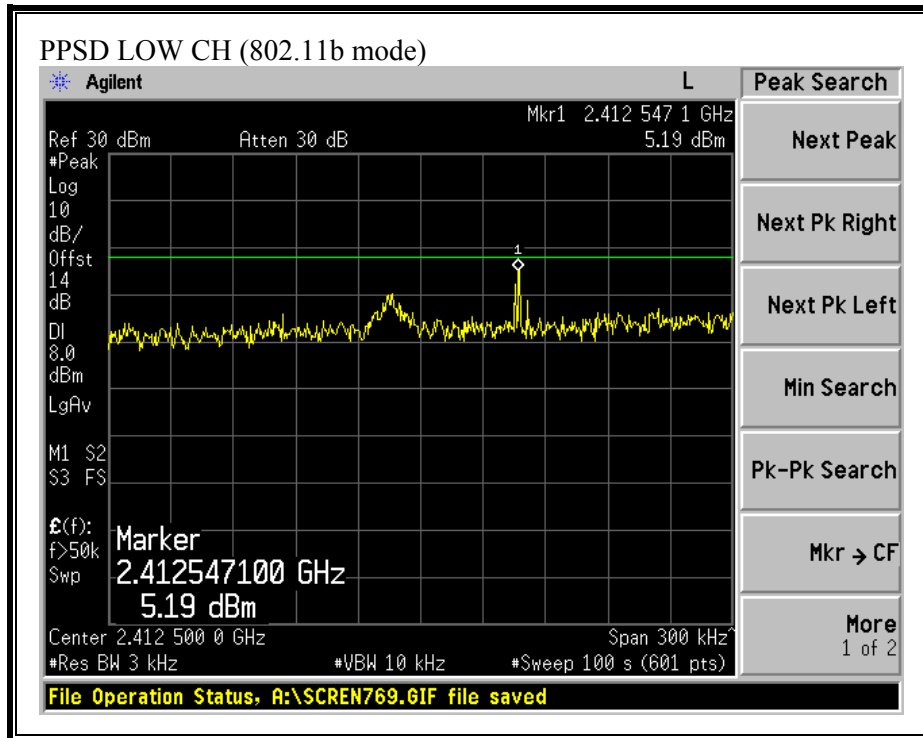

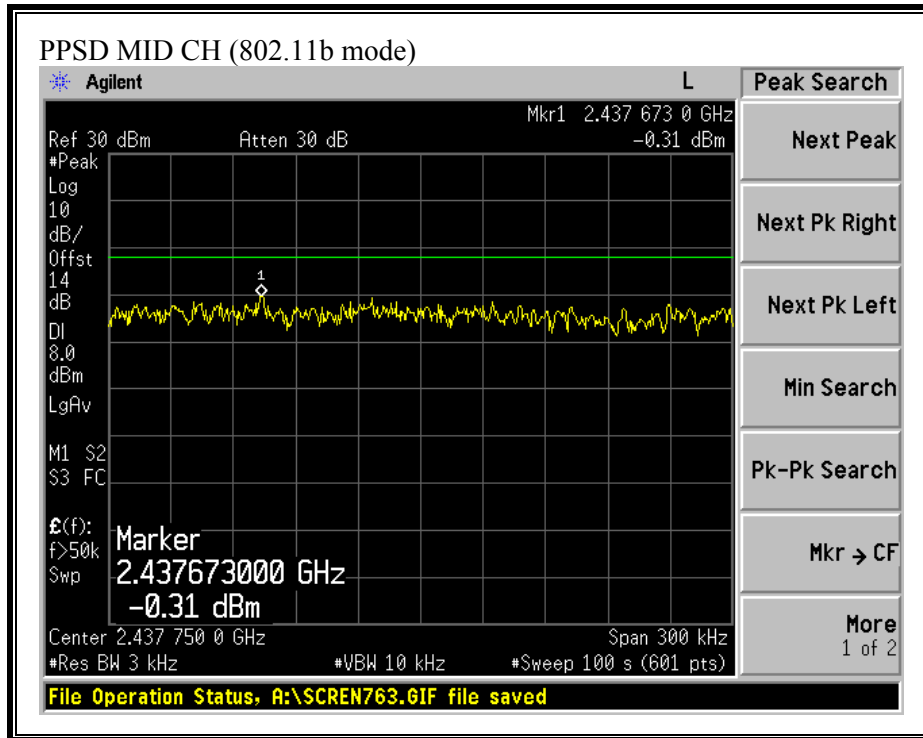

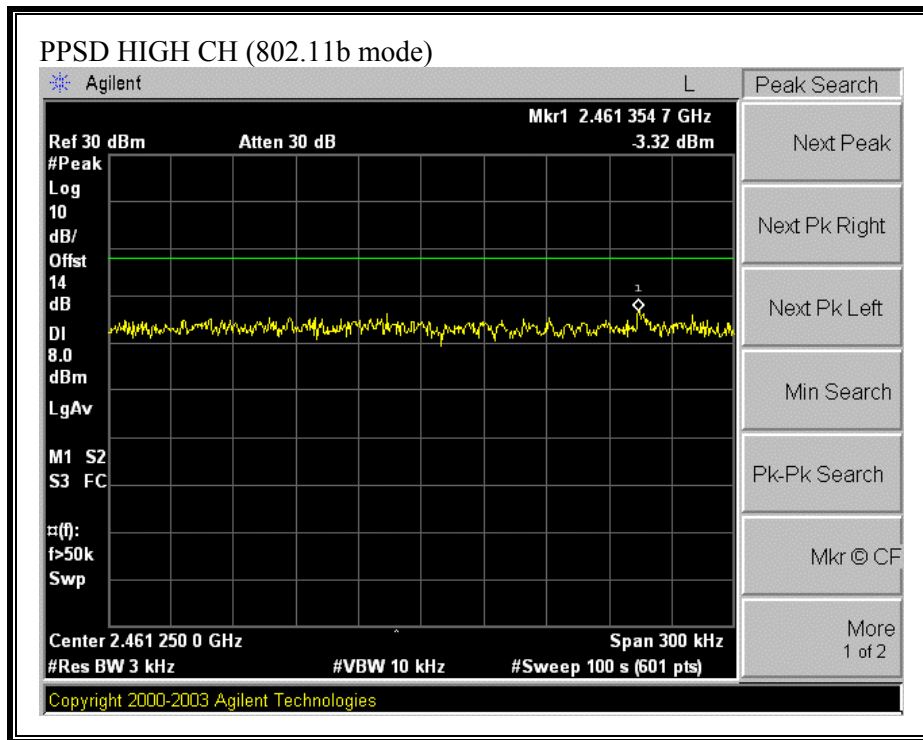

PEAK POWER SPECTRAL DENSITY (802.11g MODE)

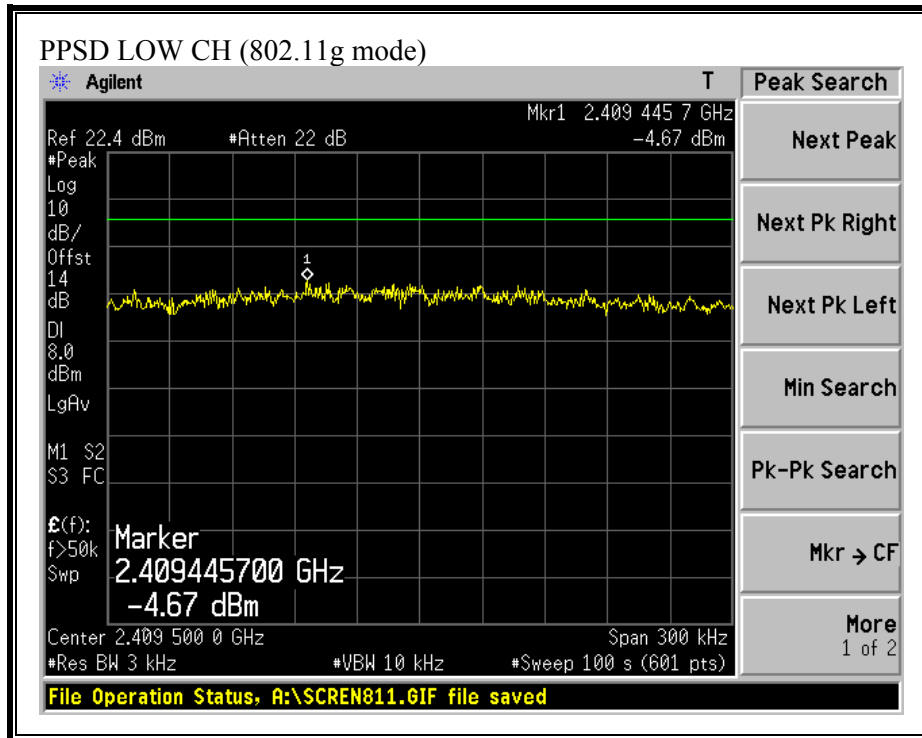

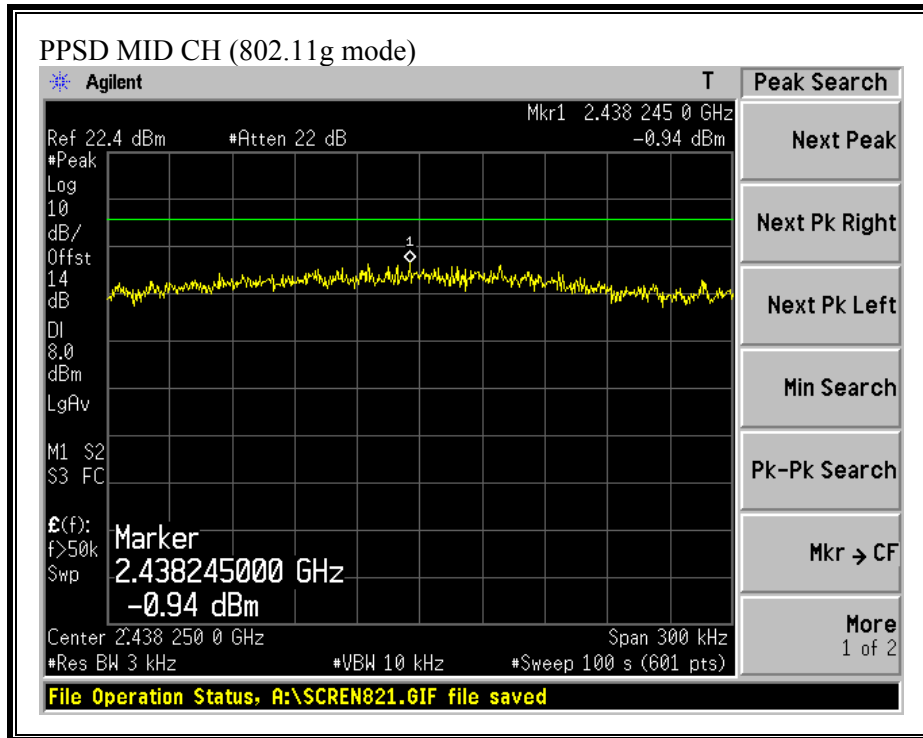

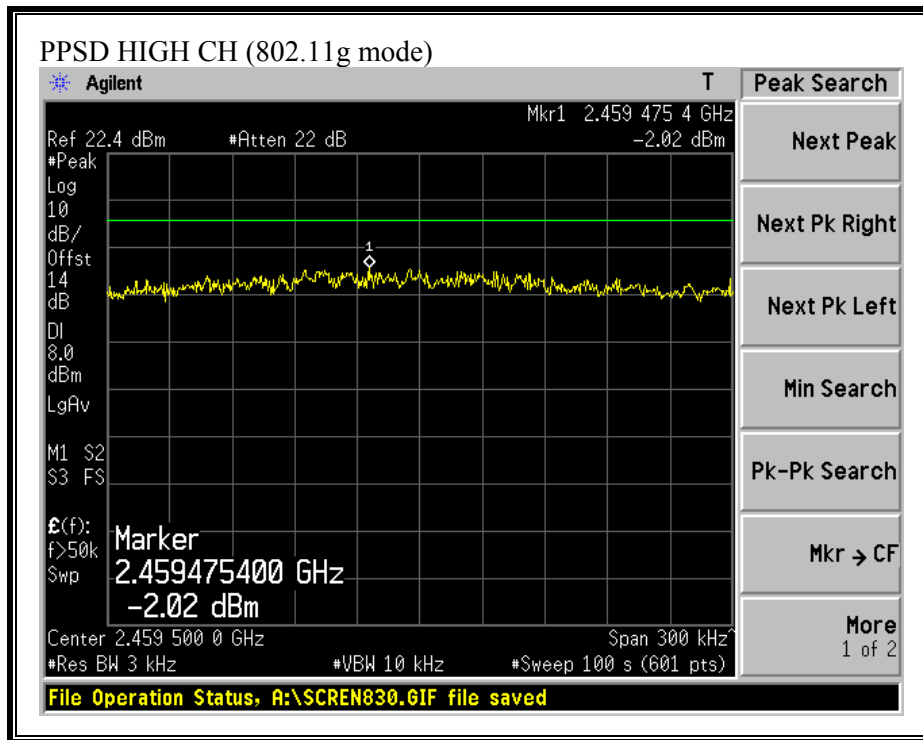

PEAK POWER SPECTRAL DENSITY (802.11a MODE)

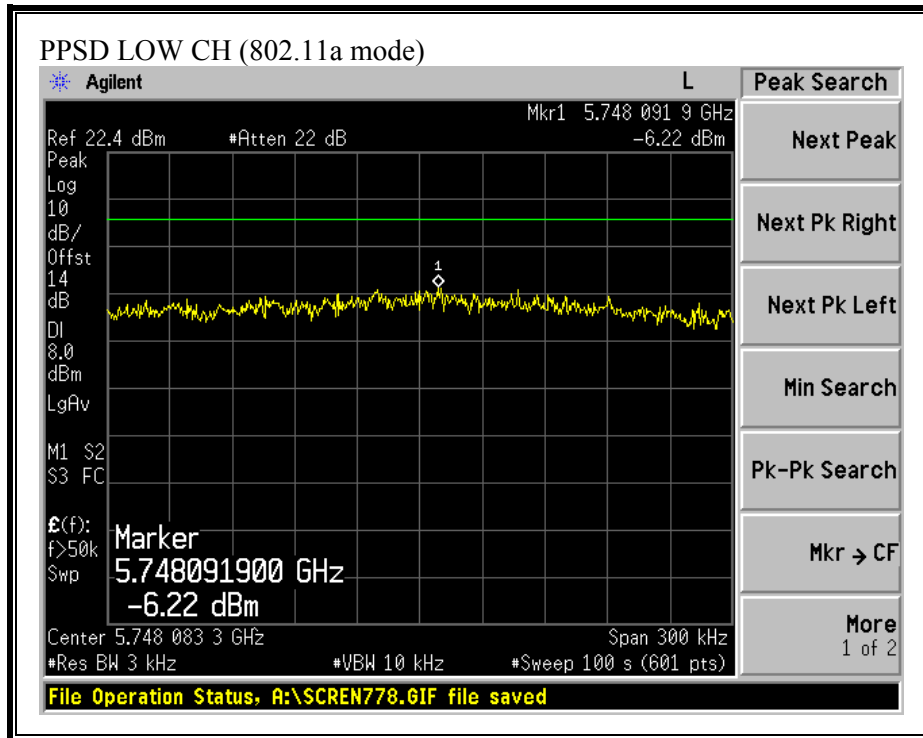

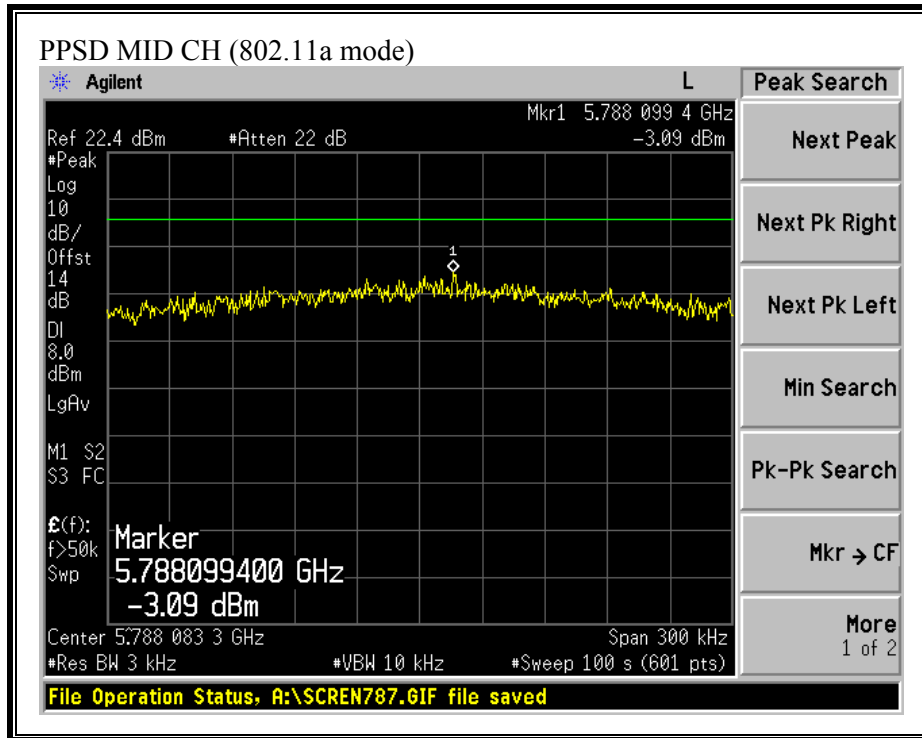

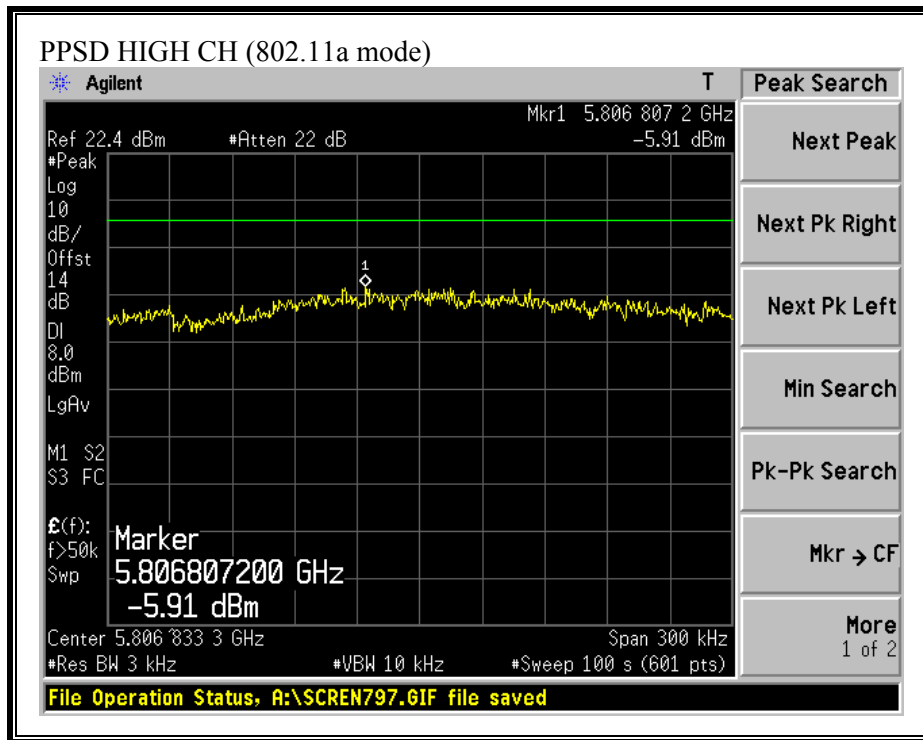

7.7. CONDUCTED SPURIOUS EMISSIONS

LIMITS

§15.247 (c) In any 100 kHz bandwidth outside the frequency band in which the spread spectrum intentional radiator is operating, the radio frequency power that is produced by the intentional radiator shall be at least 20 dB below that in the 100 kHz bandwidth within the band that contains the highest level of the desired power, based on either an RF conducted or a radiated measurement. Attenuation below the general limits specified in §15.209(a) is not required. In addition, radiated emissions, which fall in the restricted bands, as defined in §15.205(a), must also comply with the radiated emission limits specified in §15.209(a) (see §15.205(c)).

TEST PROCEDURE

The transmitter output is connected to a spectrum analyzer. The resolution bandwidth is set to 100 kHz. The video bandwidth is set to 100 kHz.

The spectrum from 30 MHz to 26 GHz is investigated with the transmitter set to the lowest, middle, and highest channels in the 2.4 GHz band.

The spectrum from 30 MHz to 40 GHz is investigated with the transmitter set to the lowest, middle, and highest channels in the 5.8 GHz band.

RESULTS

No non-compliance noted:

SPURIOUS EMISSIONS, LOW CHANNEL (802.11b MODE)

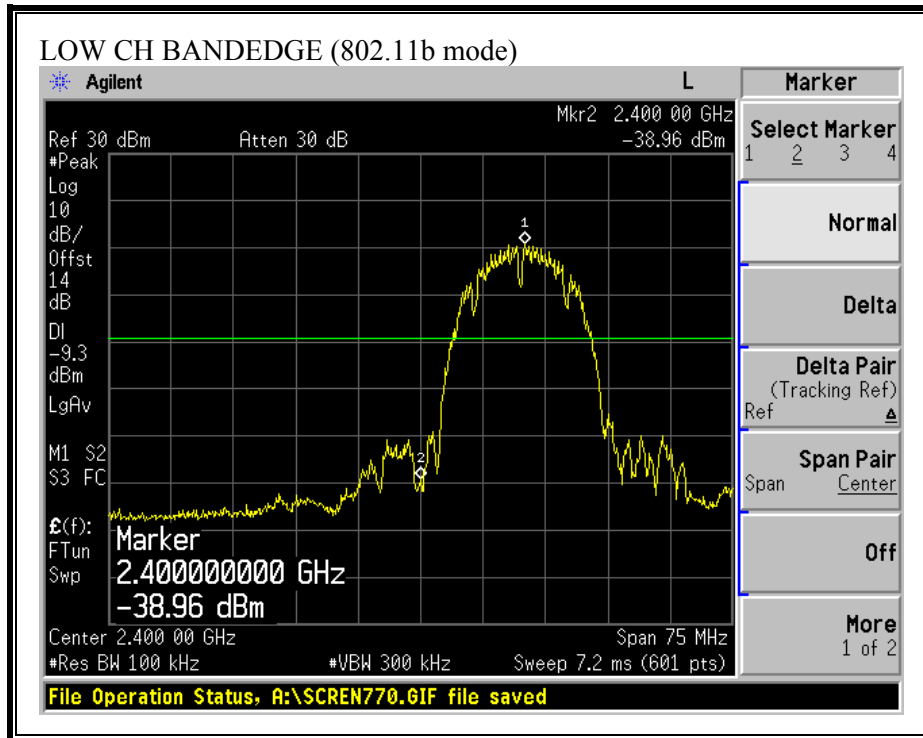

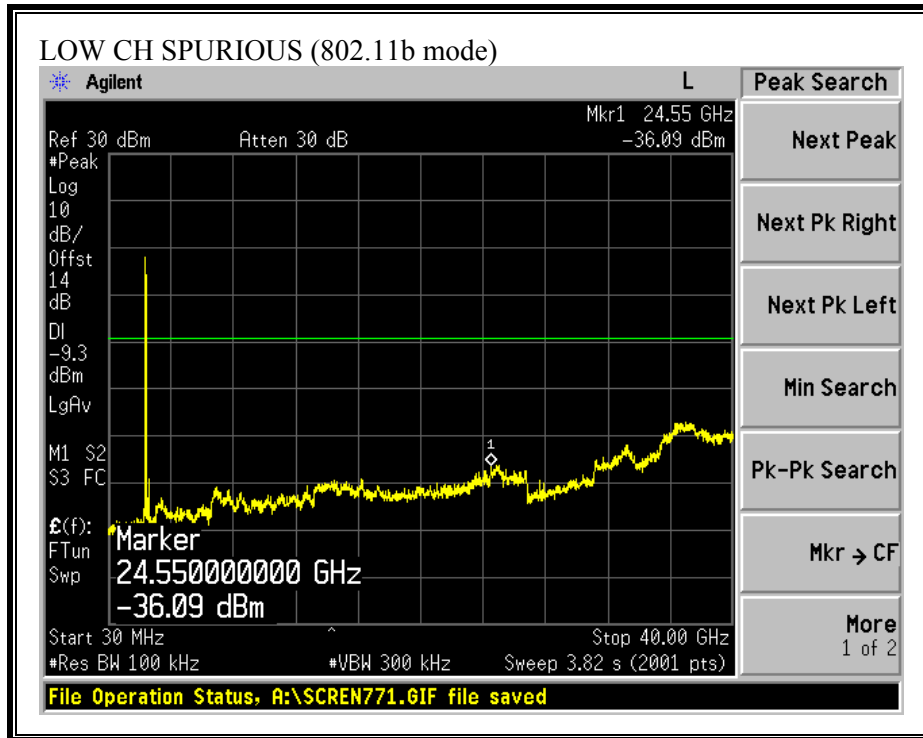

SPURIOUS EMISSIONS, MID CHANNEL (802.11b MODE)

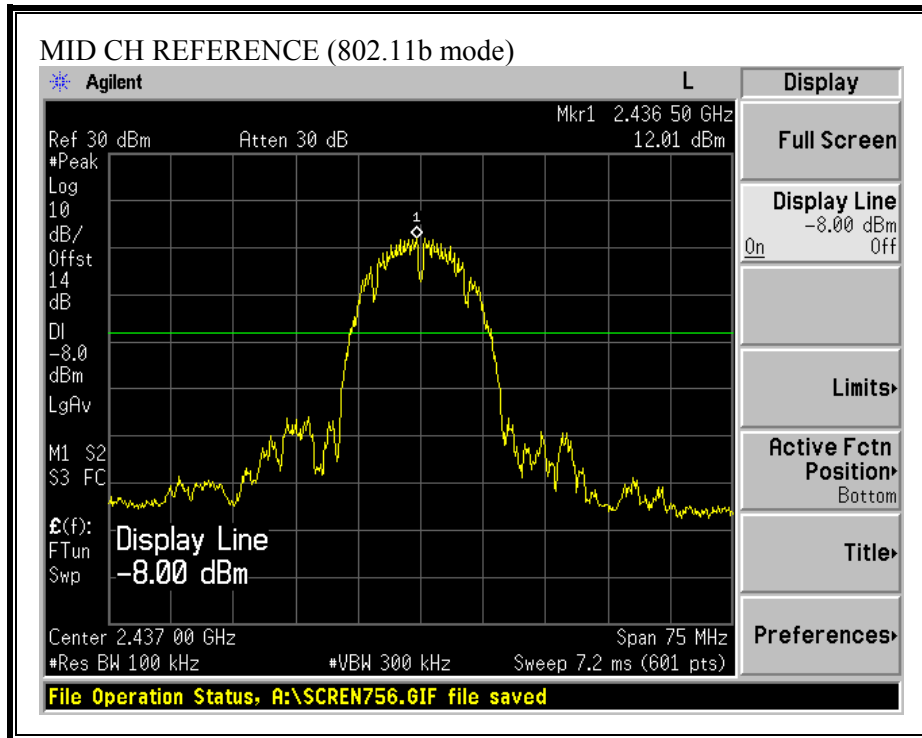

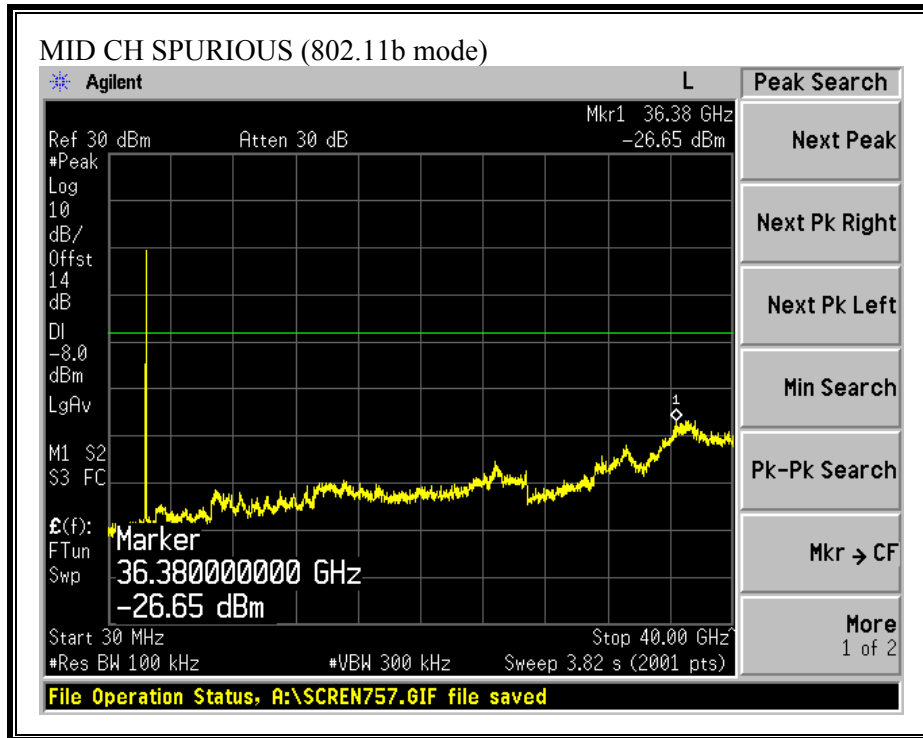

SPURIOUS EMISSIONS, HIGH CHANNEL (802.11b MODE)

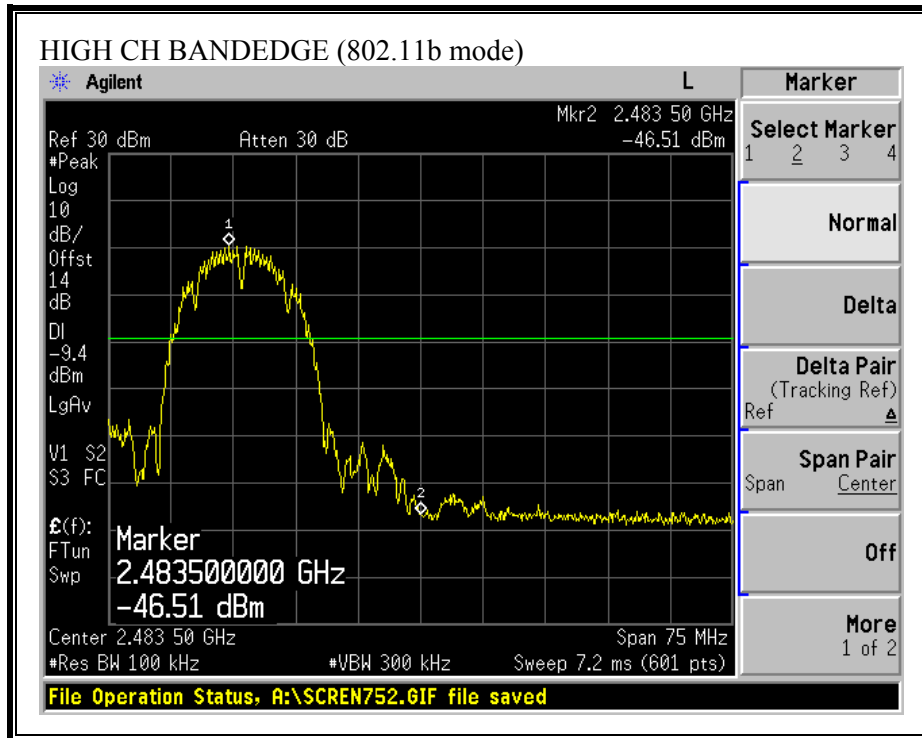

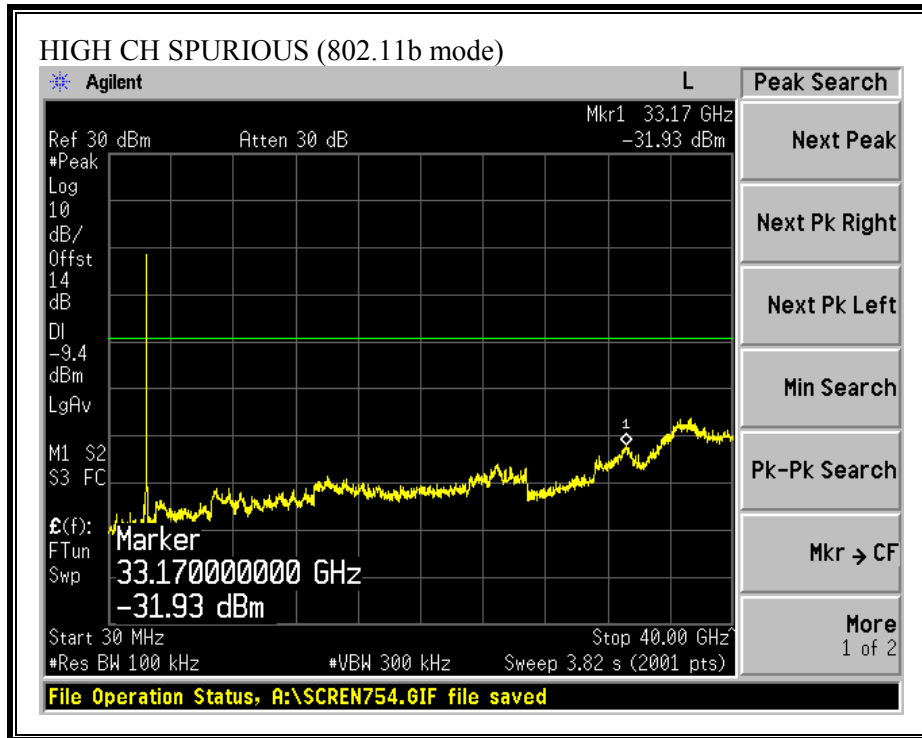

SPURIOUS EMISSIONS, LOW CHANNEL (802.11g MODE)

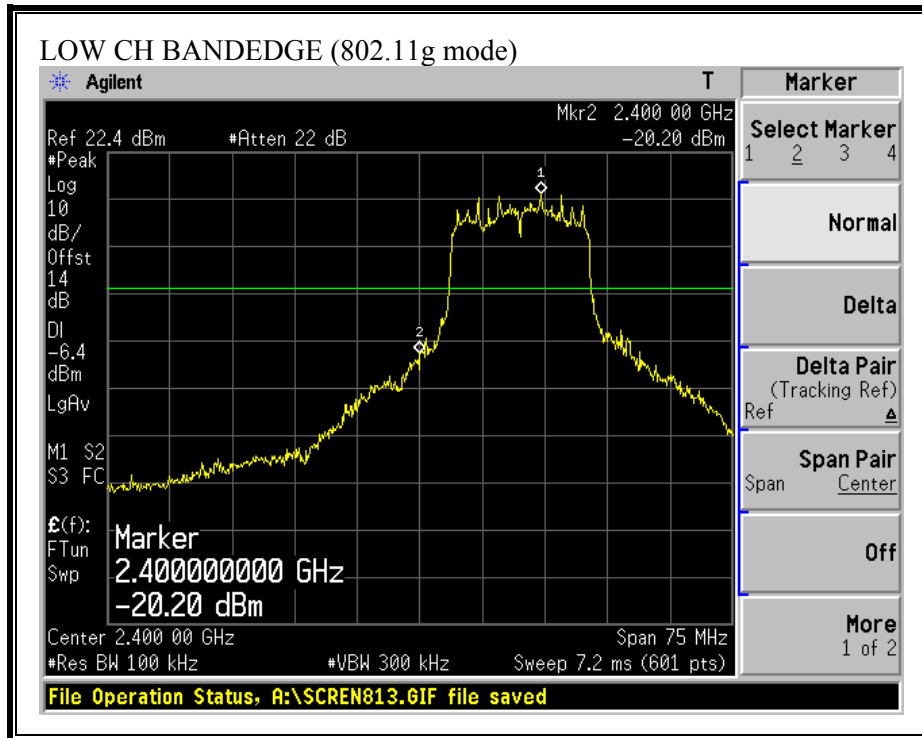

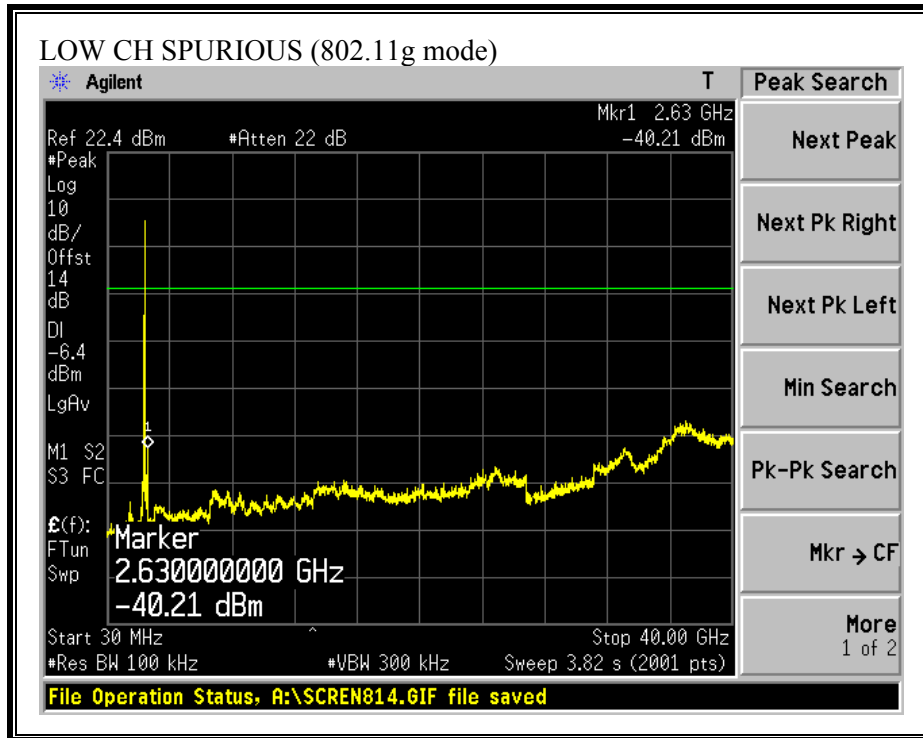

SPURIOUS EMISSIONS, MID CHANNEL (802.11g MODE)

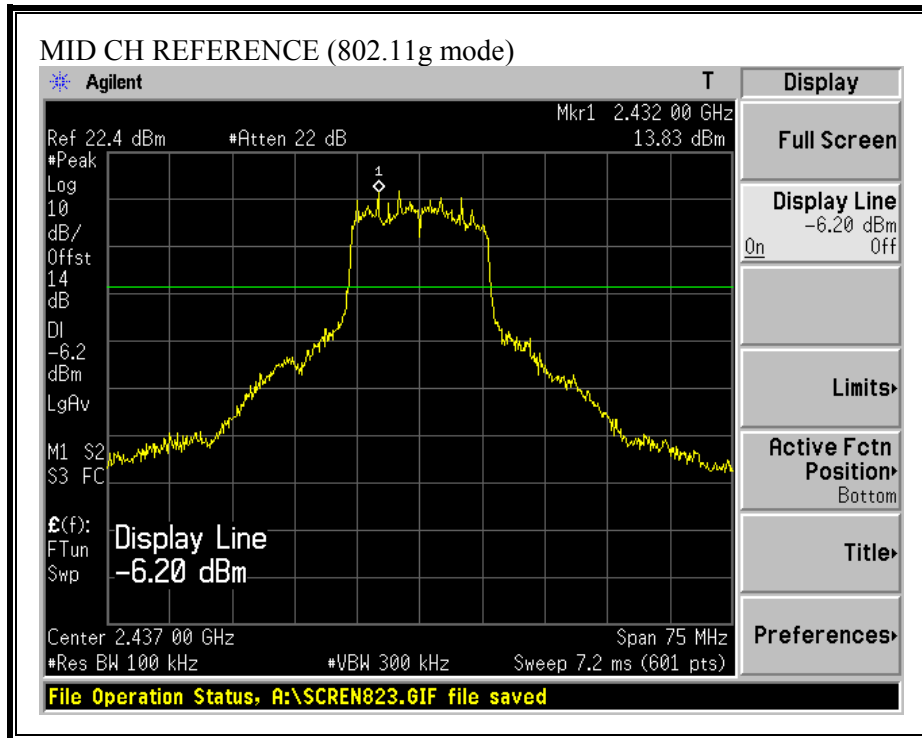

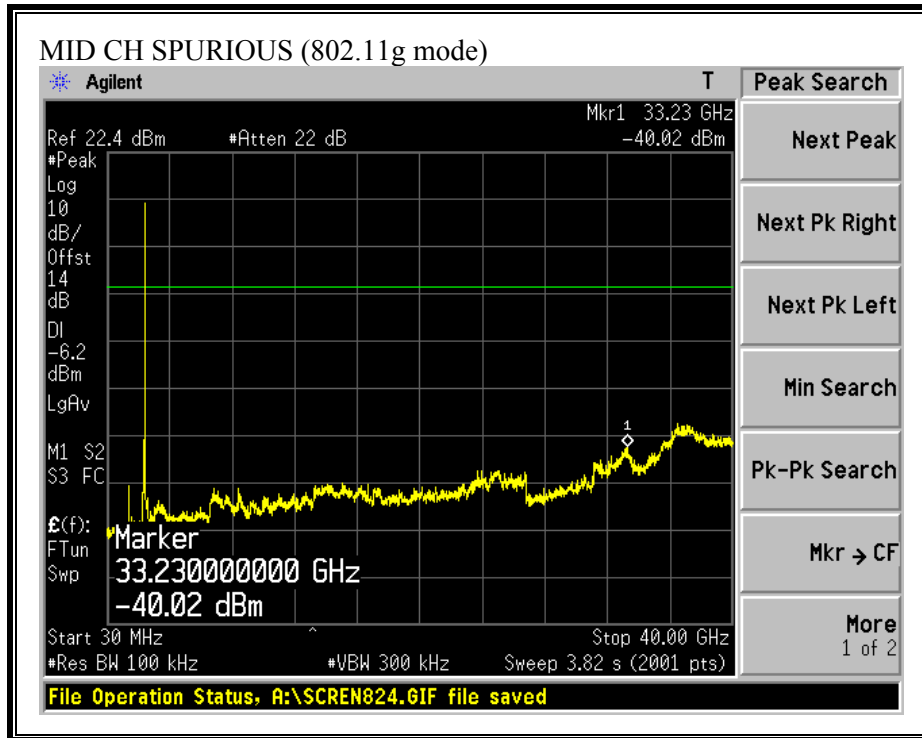

SPURIOUS EMISSIONS, HIGH CHANNEL (802.11g MODE)

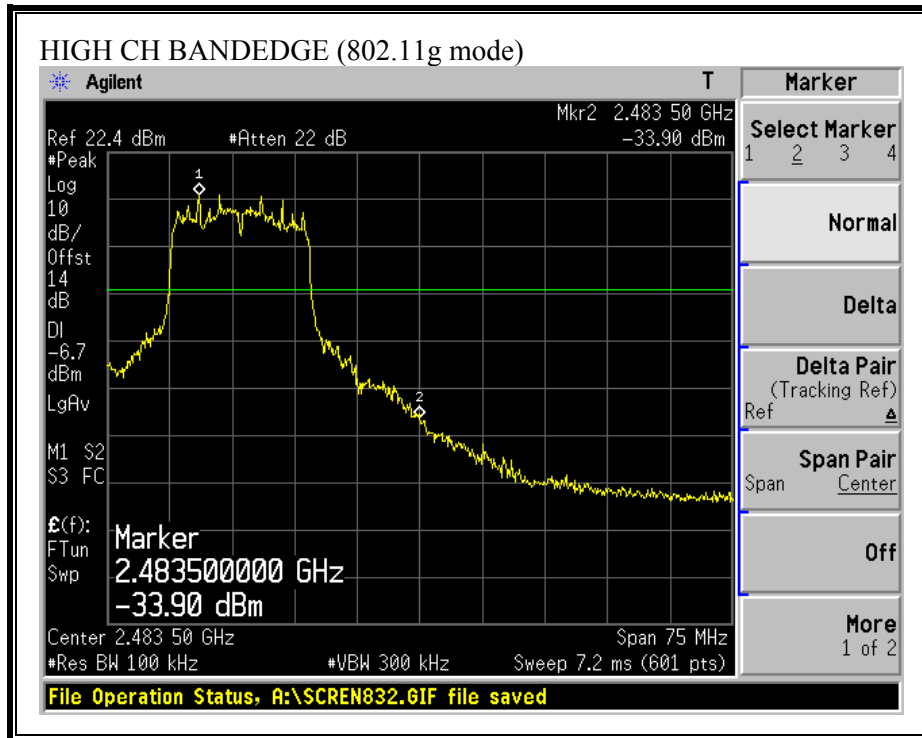

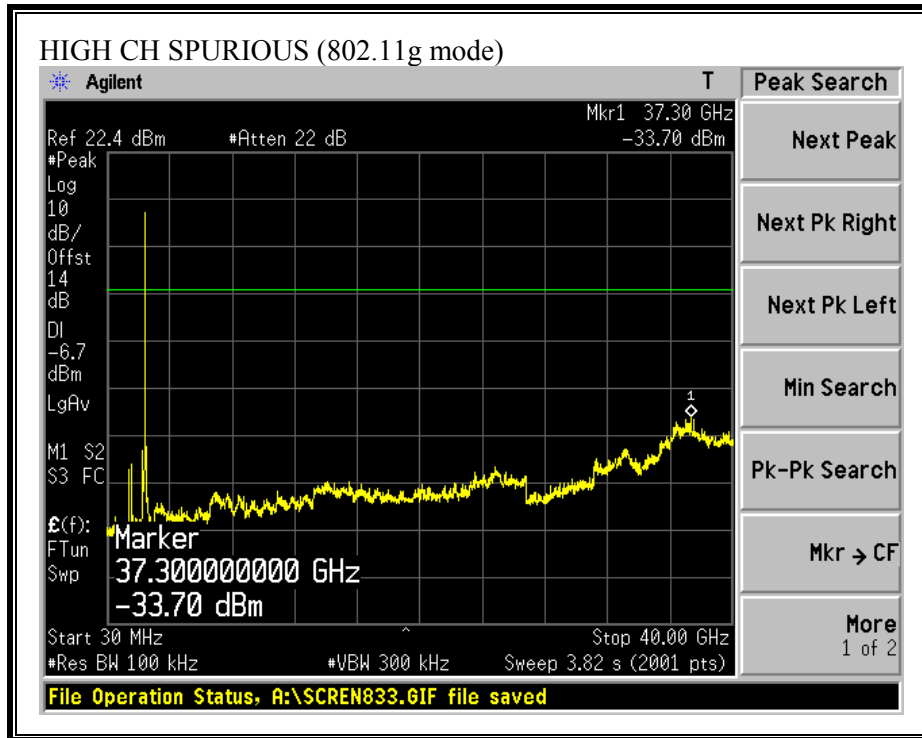

SPURIOUS EMISSIONS, LOW CHANNEL (802.11a MODE)

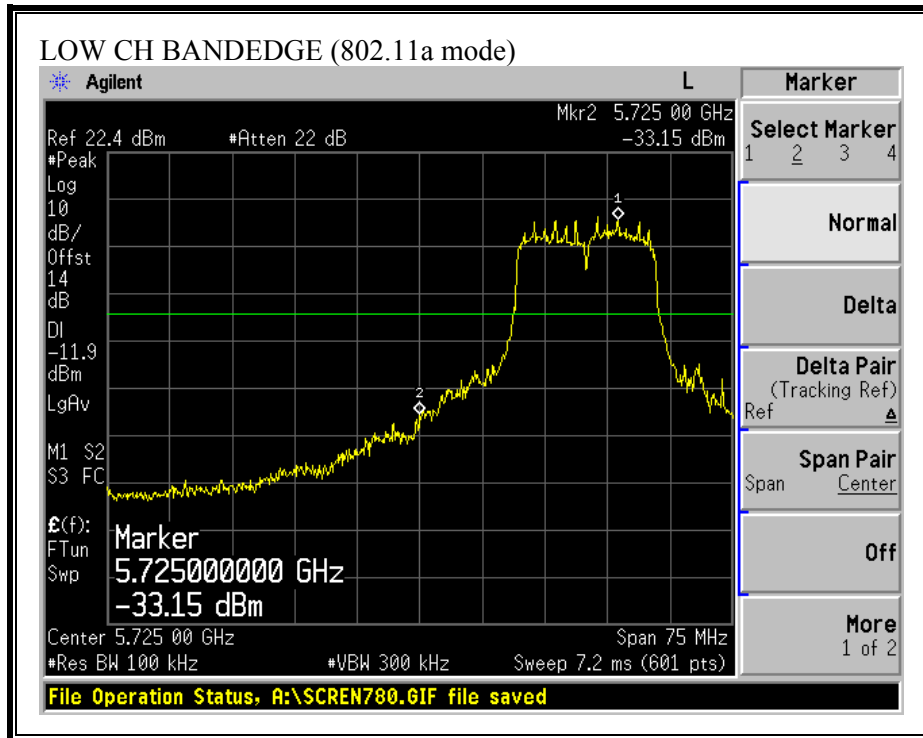

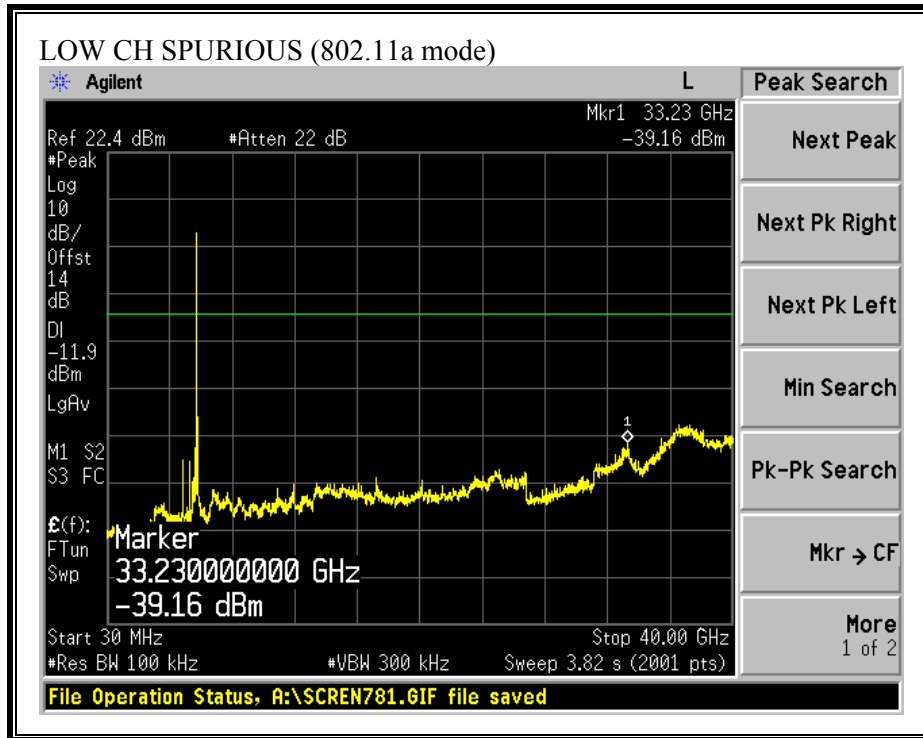

SPURIOUS EMISSIONS, MID CHANNEL (802.11a MODE)

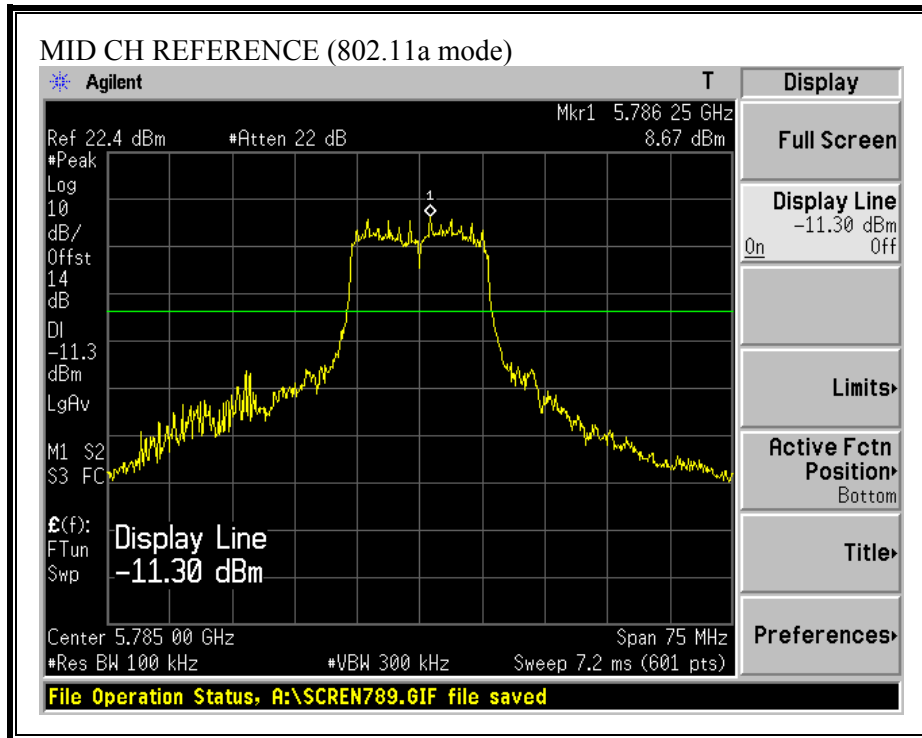

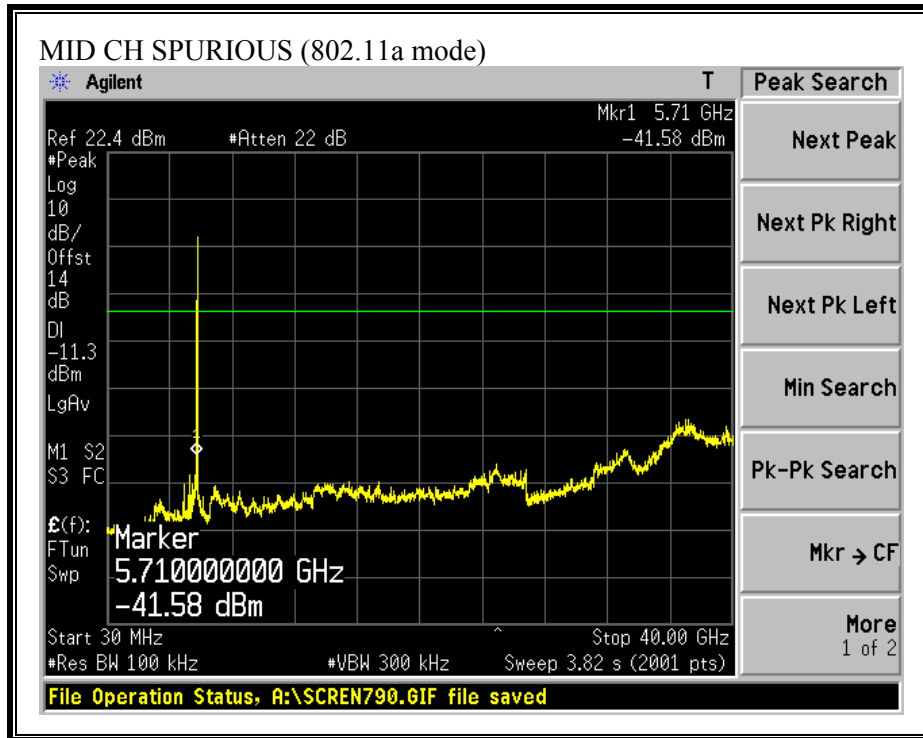

SPURIOUS EMISSIONS, HIGH CHANNEL (802.11a MODE)

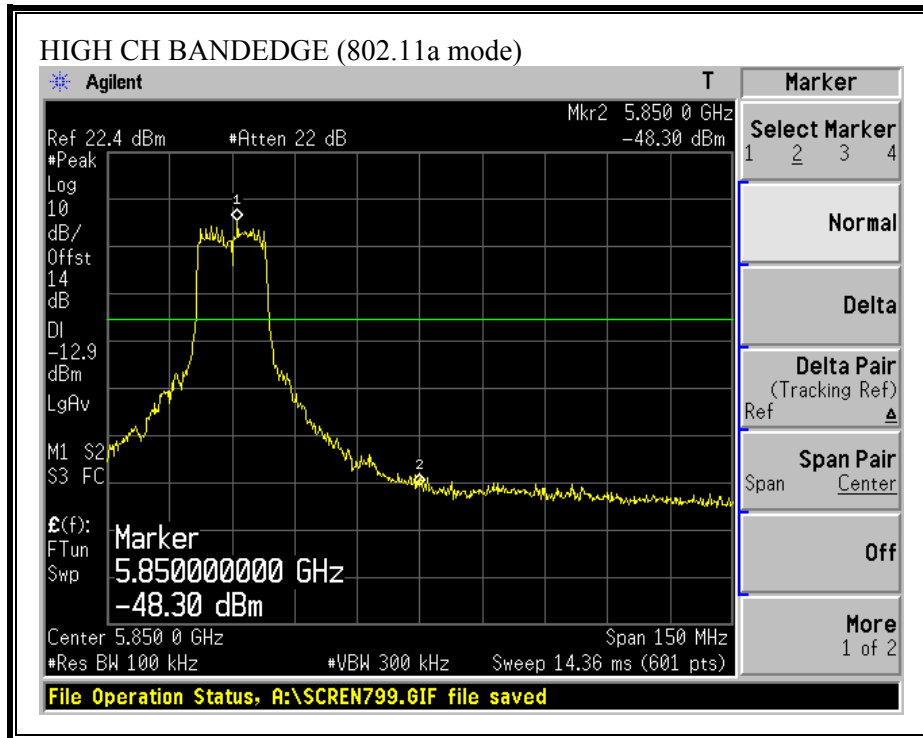

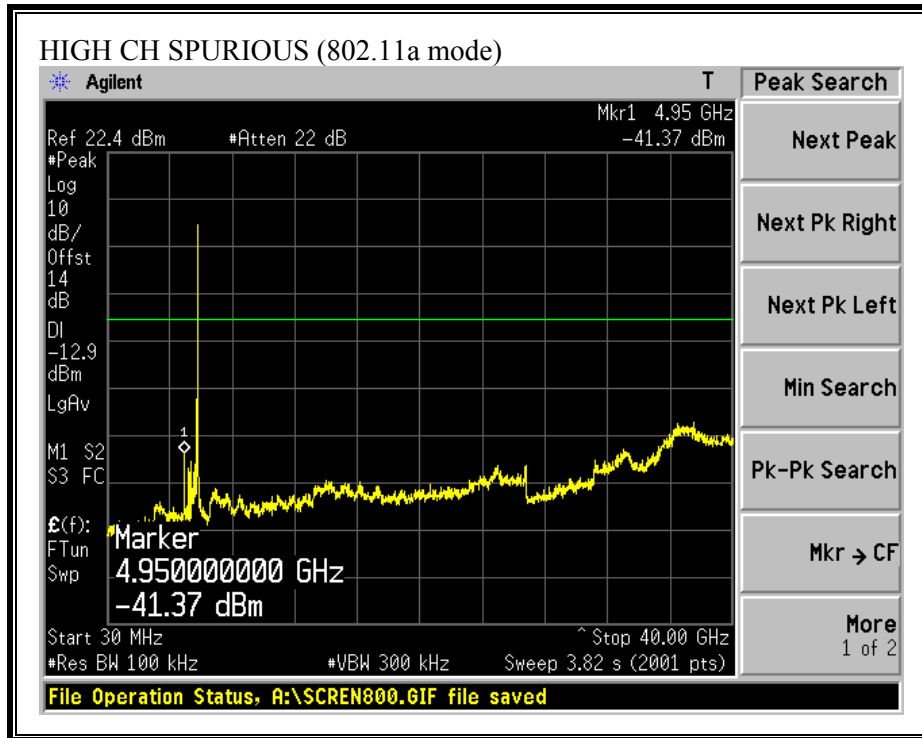

7.8. RADIATED EMISSIONS

7.8.1. TRANSMITTER RADIATED SPURIOUS EMISSIONS

LIMITS

§15.205 (a) Except as shown in paragraph (d) of this section, only spurious emissions are permitted in any of the frequency bands listed below:

MHz	MHz	MHz	GHz
0.090 - 0.110	16.42 - 16.423	399.9 - 410	4.5 - 5.15
¹ 0.495 - 0.505	16.69475 - 16.69525	608 - 614	5.35 - 5.46
2.1735 - 2.1905	16.80425 - 16.80475	960 - 1240	7.25 - 7.75
4.125 - 4.128	25.5 - 25.67	1300 - 1427	8.025 - 8.5
4.17725 - 4.17775	37.5 - 38.25	1435 - 1626.5	9.0 - 9.2
4.20725 - 4.20775	73 - 74.6	1645.5 - 1646.5	9.3 - 9.5
6.215 - 6.218	74.8 - 75.2	1660 - 1710	10.6 - 12.7
6.26775 - 6.26825	108 - 121.94	1718.8 - 1722.2	13.25 - 13.4
6.31175 - 6.31225	123 - 138	2200 - 2300	14.47 - 14.5
8.291 - 8.294	149.9 - 150.05	2310 - 2390	15.35 - 16.2
8.362 - 8.366	156.52475 - 156.52525	2483.5 - 2500	17.7 - 21.4
8.37625 - 8.38675	156.7 - 156.9	2655 - 2900	22.01 - 23.12
8.41425 - 8.41475	162.0125 - 167.17	3260 - 3267	23.6 - 24.0
12.29 - 12.293	167.72 - 173.2	3332 - 3339	31.2 - 31.8
12.51975 - 12.52025	240 - 285	3345.8 - 3358	36.43 - 36.5
12.57675 - 12.57725	322 - 335.4	3600 - 4400	(²)
13.36 - 13.41			

¹ Until February 1, 1999, this restricted band shall be 0.490-0.510 MHz.

² Above 38.6

§15.205 (b) Except as provided in paragraphs (d) and (e), the field strength of emissions appearing within these frequency bands shall not exceed the limits shown in Section 15.209. At frequencies equal to or less than 1000 MHz, compliance with the limits in Section 15.209 shall be demonstrated using measurement instrumentation employing a CISPR quasi-peak detector. Above 1000 MHz, compliance with the emission limits in Section 15.209 shall be demonstrated based on the average value of the measured emissions. The provisions in Section 15.35 apply to these measurements.

§15.209 (a) Except as provided elsewhere in this Subpart, the emissions from an intentional radiator shall not exceed the field strength levels specified in the following table:

Frequency (MHz)	Field Strength (microvolts/meter)	Measurement Distance (meters)
30 - 88	100 **	3
88 - 216	150 **	3
216 - 960	200 **	3
Above 960	500	3

** Except as provided in paragraph (g), fundamental emissions from intentional radiators operating under this Section shall not be located in the frequency bands 54-72 MHz, 76-88 MHz, 174-216 MHz or 470-806 MHz. However, operation within these frequency bands is permitted under other sections of this Part, e.g., Sections 15.231 and 15.241.

§15.209 (b) In the emission table above, the tighter limit applies at the band edges.

TEST PROCEDURE

The EUT is placed on a non-conducting table 80 cm above the ground plane. The antenna to EUT distance is 3 meters. The EUT is configured in accordance with ANSI C63.4. The EUT is set to transmit in a continuous mode.

For measurements below 1 GHz the resolution bandwidth is set to 100 kHz for peak detection measurements or 120 kHz for quasi-peak detection measurements. Peak detection is used unless otherwise noted as quasi-peak.

For measurements above 1 GHz the resolution bandwidth is set to 1 MHz, then the video bandwidth is set to 1 MHz for peak measurements and 10 Hz for average measurements.

The spectrum from 30 MHz to 26 GHz is investigated with the transmitter set to the lowest, middle, and highest channels of the 2.4 GHz band.

The spectrum from 30 MHz to 40 GHz is investigated with the transmitter set to the lowest, middle, and highest channels of the 5.8 GHz band.

The frequency range of interest is monitored at a fixed antenna height and EUT azimuth. The EUT is rotated through 360 degrees to maximize emissions received. The antenna is scanned from 1 to 4 meters above the ground plane to further maximize the emission. Measurements are made with the antenna polarized in both the vertical and the horizontal positions.

RESULTS

No non-compliance noted:

7.8.2. TRANSMITTER RADIATED EMISSIONS ABOVE 1 GHZ

RESTRICTED BANDEDGE (b MODE, LOW CHANNEL, HORIZONTAL)

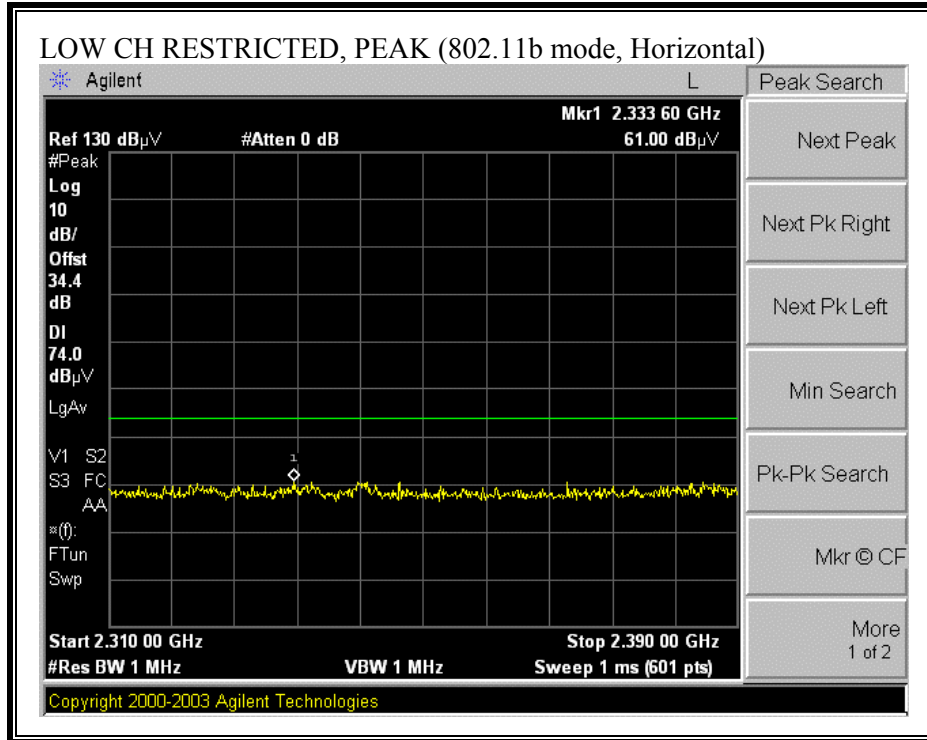

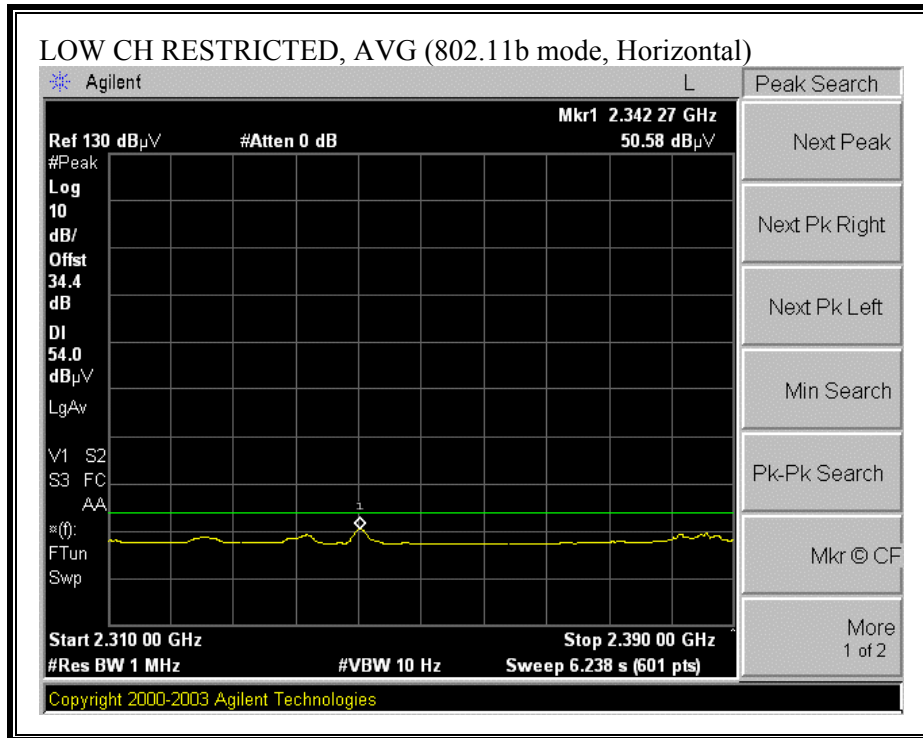

RESTRICTED BANDEDGE (b MODE, LOW CHANNEL, VERTICAL)

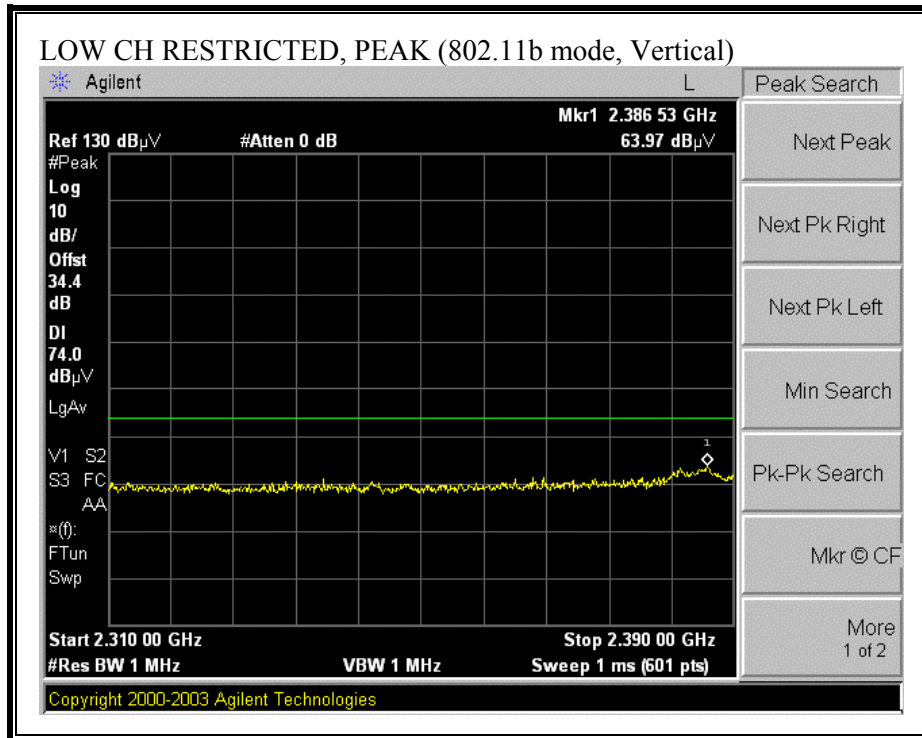

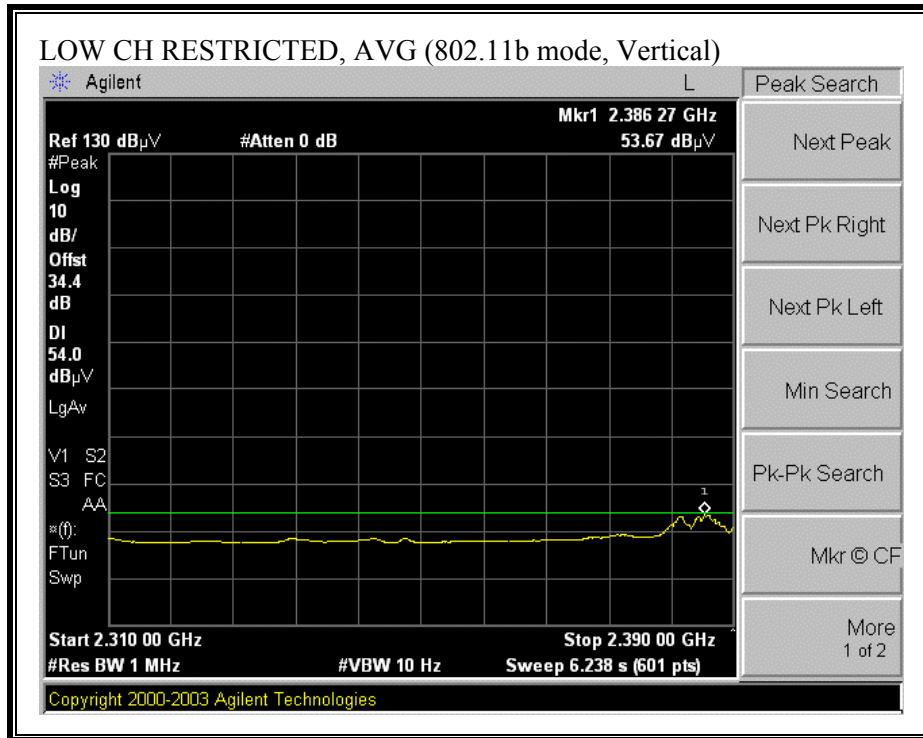

RESTRICTED BANDEDGE (b MODE, HIGH CHANNEL, HORIZONTAL)

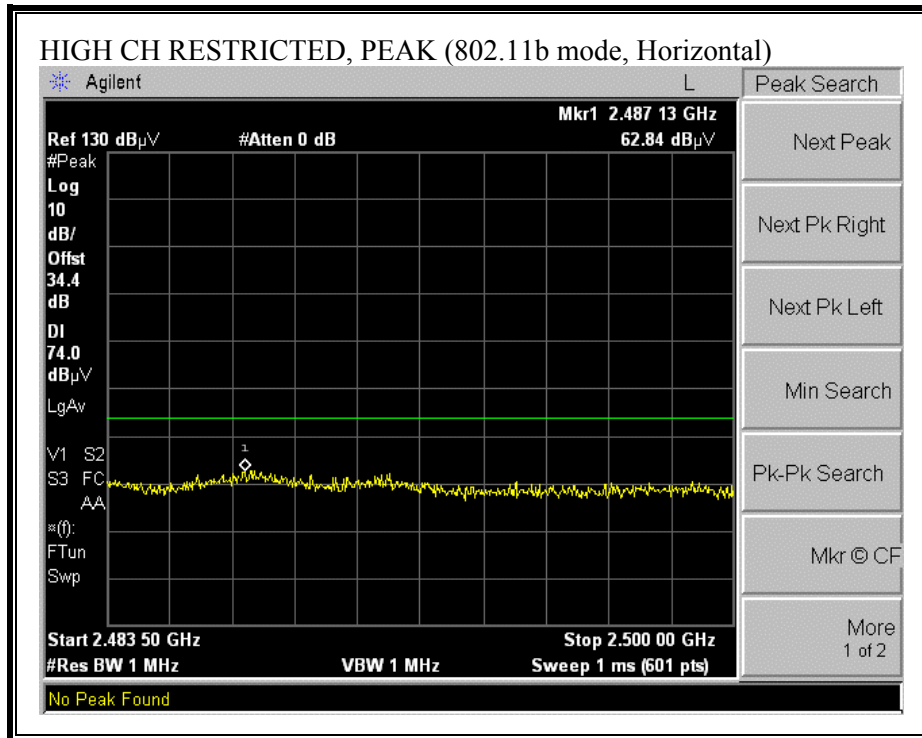

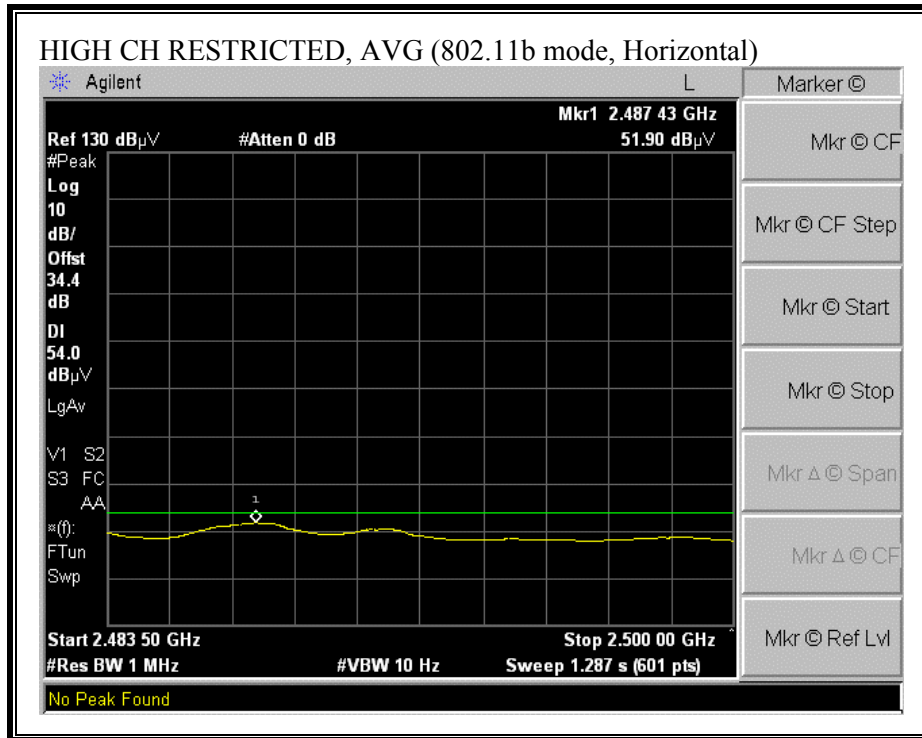

RESTRICTED BANDEDGE (b MODE, HIGH CHANNEL, VERTICAL)

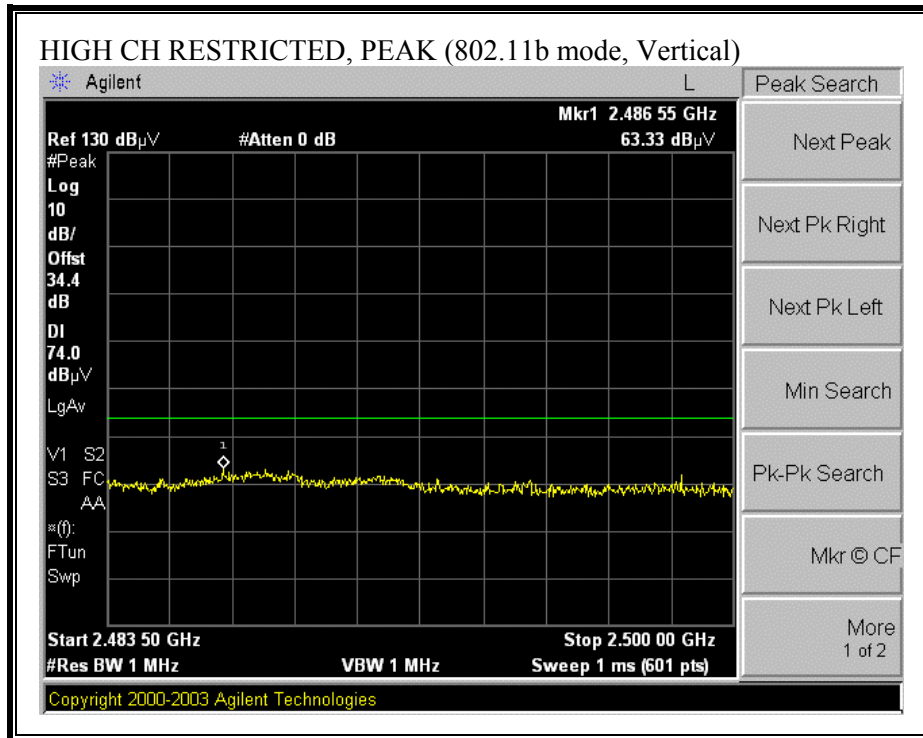

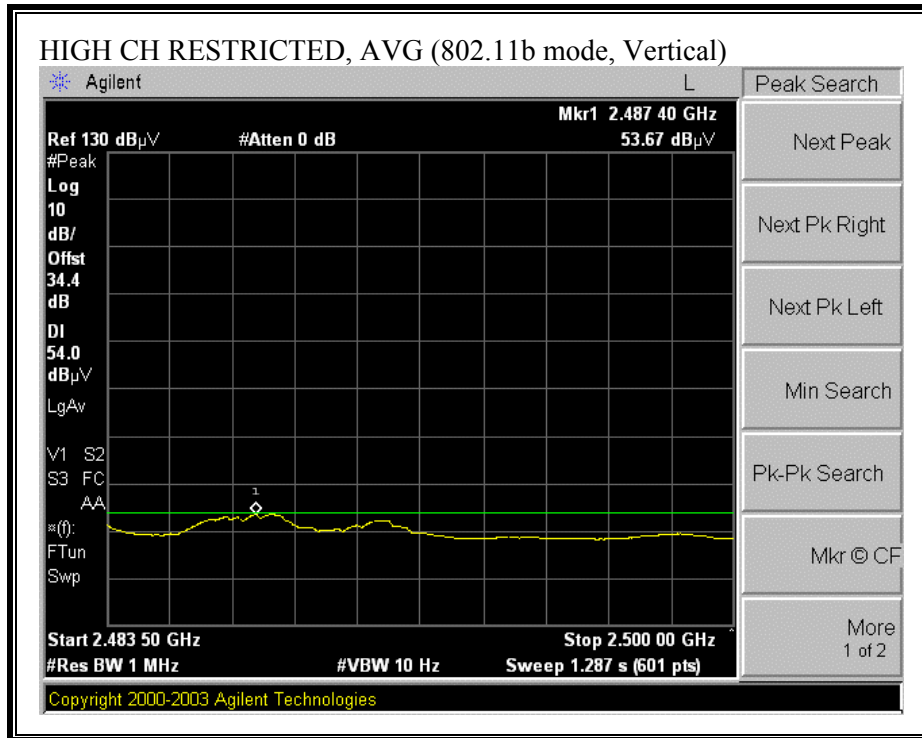

HARMONICS AND SPURIOUS EMISSIONS (b MODE)

02/09/04 High Frequency Measurement Compliance Certification Services, Morgan Hill Open Field Site																
Test Engr: Project #: Company: Airgo Networks EUT Descrip.: 802.11abg MIMO AP EUT M/N: 1200AP/WS112 Test Target: FCC 15.247, IC RSS-210 Mode Oper: B Mode																
Test Equipment:																
EMCO Horn 1-18GHz		Spectrum Analyzer			Pre-amplifier 1-26GHz			Pre-amplifier 26-40GHz			Horn > 18GHz					
T120; S/N: 29310 @3m		HP 8593EM Analyzer			T63 Miteq 646456											
Hi Frequency Cables: <input type="checkbox"/> (2 ft) <input checked="" type="checkbox"/> (2 ~ 3 ft) <input type="checkbox"/> (4 ~ 6 ft) <input checked="" type="checkbox"/> (12 ft)																
Peak Measurements: 1 MHz Resolution Bandwidth 1MHz Video Bandwidth																
Average Measurements: 1 MHz Resolution Bandwidth 10Hz Video Bandwidth																
f GHz	Dist feet	Read Pk dBuV	Read Avg. dBuV	AF dB/m	CL dB	Amp dB	D Corr dB	HPF	Peak dBuV/m	Avg dBuV/m	Pk Lim dBuV/m	Avg Lim dBuV/m	Pk Mar dB	Avg Mar dB	Notes	
B Mode WS112																
Low Channel																
4.824	9.8	45.4	37.5	33.7	3.2	-35.3	0.0	1.0	47.9	40.0	74.0	54.0	-26.1	-14.0	V	
4.824	9.8	40.8	28.3	33.7	3.2	-35.3	0.0	1.0	43.3	30.8	74.0	54.0	-30.7	-23.2	H	
Mid Channel																
4.874	9.8	47.3	33.1	33.7	3.2	-35.3	0.0	1.0	49.8	35.7	74.0	54.0	-24.2	-18.3	V	
4.874	9.8	40.4	29.6	33.7	3.2	-35.3	0.0	1.0	43.0	32.2	74.0	54.0	-31.0	-21.8	H	
High Channel																
4.924	9.8	45.3	39.0	33.8	3.2	-35.3	0.0	1.0	47.9	41.6	74.0	54.0	-26.1	-12.4	V	
4.924	9.8	41.3	30.1	33.8	3.2	-35.3	0.0	1.0	43.9	32.7	74.0	54.0	-30.1	-21.3	H	
G Mode WS111																
Low Channel																
4.824	9.8	47.7	30.0	33.7	3.2	-35.3	0.0	1.0	50.3	32.5	74.0	54.0	-23.7	-21.5	V	
4.824	9.8	41.7	29.4	33.7	3.2	-35.3	0.0	1.0	44.2	31.9	74.0	54.0	-29.8	-22.1	H	
Mid Channel																
4.874	9.8	46.0	32.1	33.7	3.2	-35.3	0.0	1.0	48.6	34.7	74.0	54.0	-25.4	-19.3	V	
4.874	9.8	41.2	26.9	33.7	3.2	-35.3	0.0	1.0	43.8	29.5	74.0	54.0	-30.2	-24.5	H	
High Channel																
4.924	9.8	43.5	30.5	33.8	3.2	-35.3	0.0	1.0	46.1	33.1	74.0	54.0	-27.9	-20.9	V	
4.924	9.8	37.4	27.1	33.8	3.2	-35.3	0.0	1.0	40.0	29.7	74.0	54.0	-34.0	-24.3	H	
f	Measurement Frequency					Amp	Preamp Gain					Avg Lim	Average Field Strength Limit			
Dist	Distance to Antenna					D Corr	Distance Correct to 3 meters					Pk Lim	Peak Field Strength Limit			
Read	Analyzer Reading					Avg	Average Field Strength @ 3 m					Avg Mar	Margin vs. Average Limit			
AF	Antenna Factor					Peak	Calculated Peak Field Strength					Pk Mar	Margin vs. Peak Limit			
CL	Cable Loss					HPF	High Pass Filter									

RESTRICTED BANDEDGE (g MODE, LOW CHANNEL, HORIZONTAL)

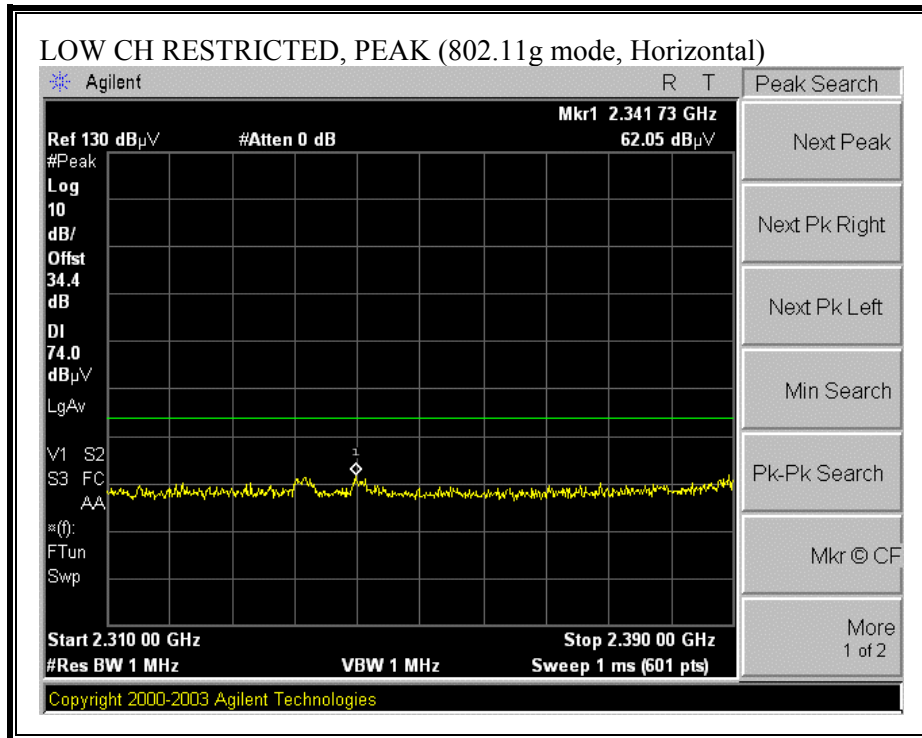

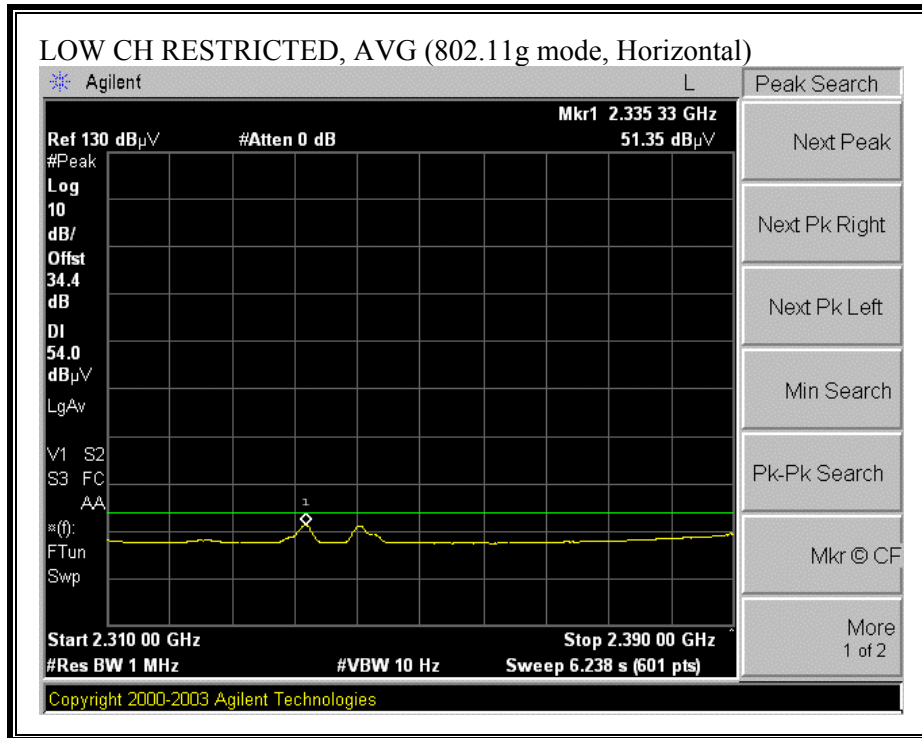

RESTRICTED BANDEDGE (g MODE, LOW CHANNEL, VERTICAL)

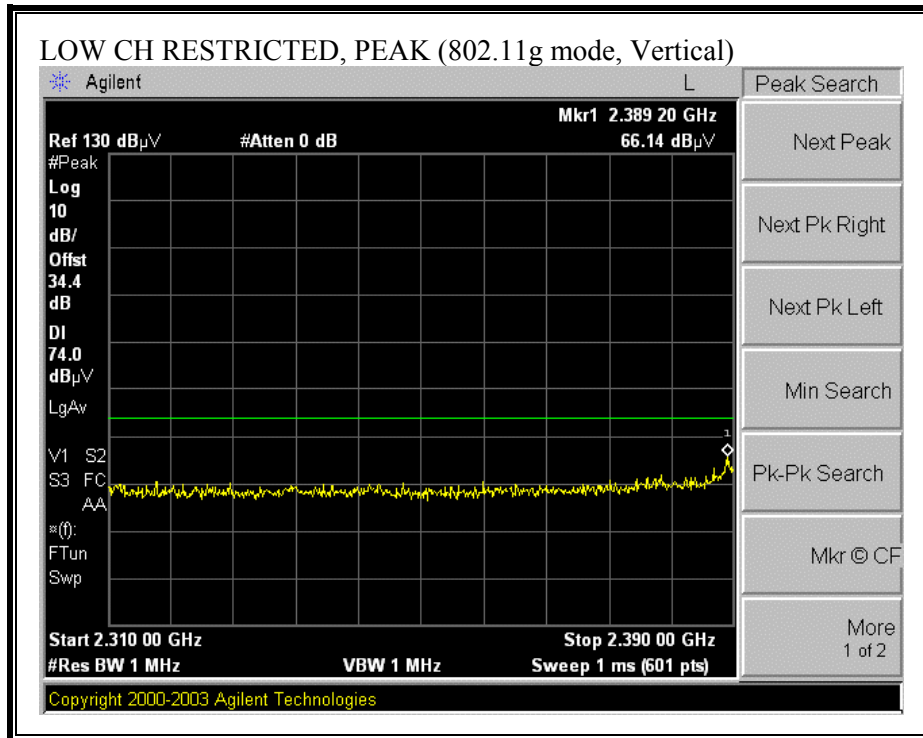

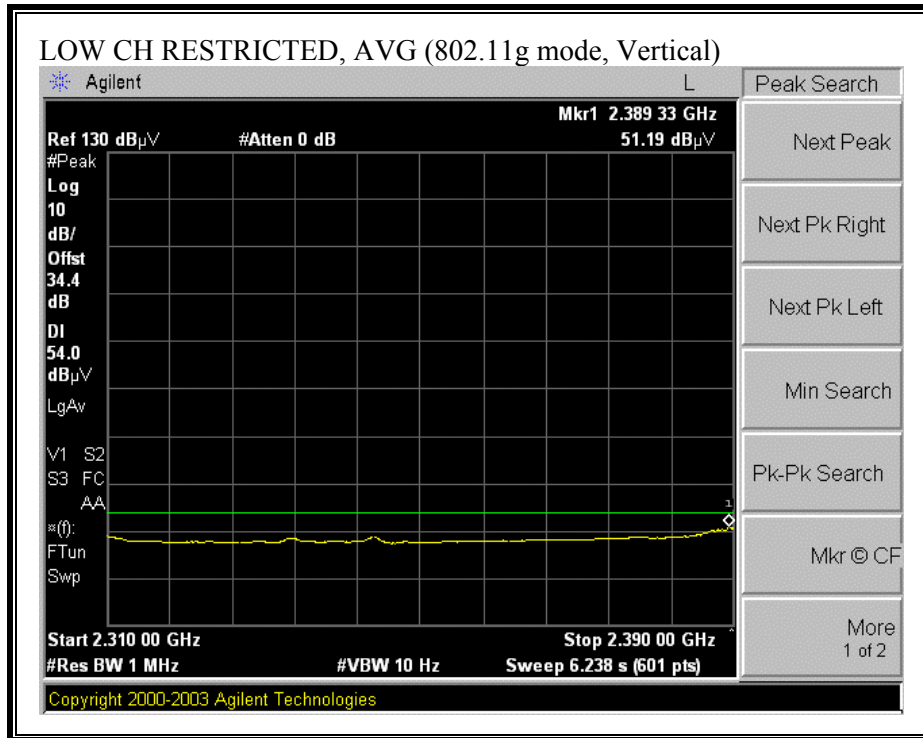

RESTRICTED BANDEDGE (g MODE, HIGH CHANNEL, HORIZONTAL)

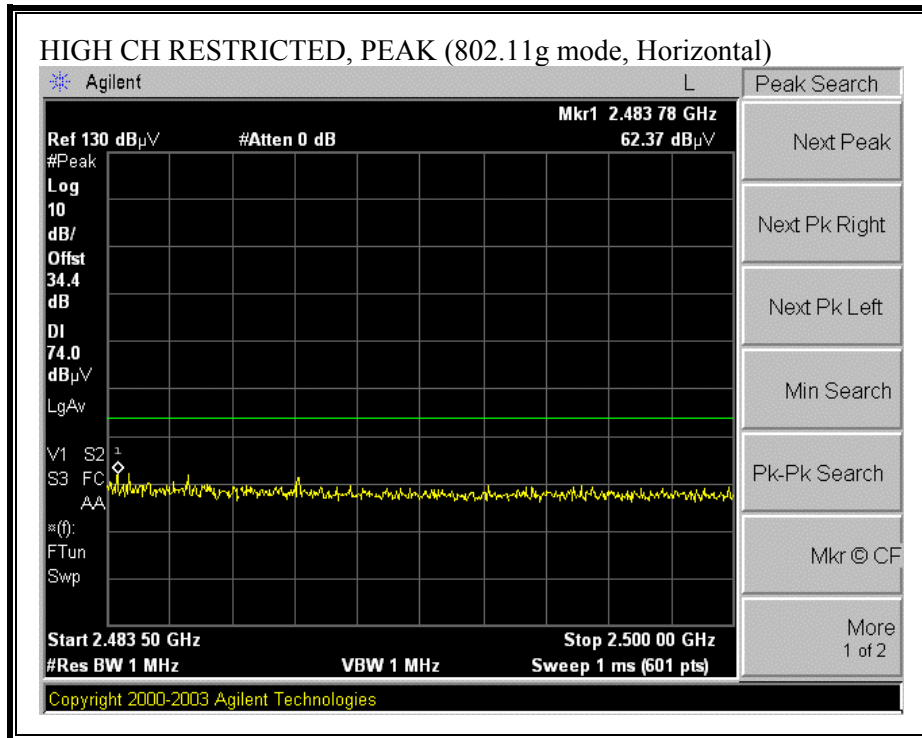

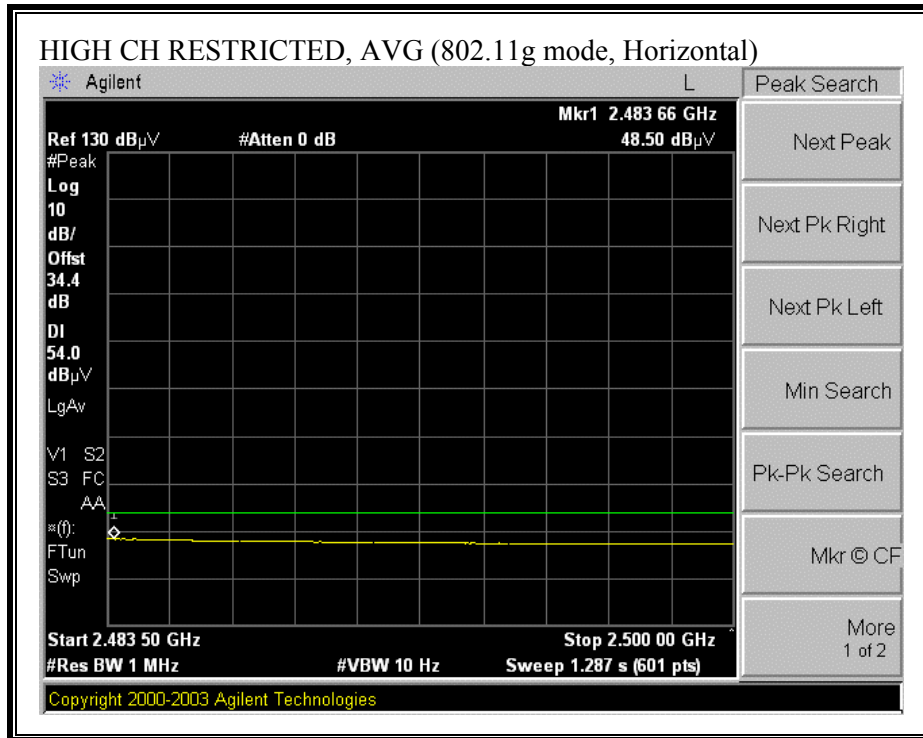

RESTRICTED BANDEDGE (g MODE, HIGH CHANNEL, VERTICAL)

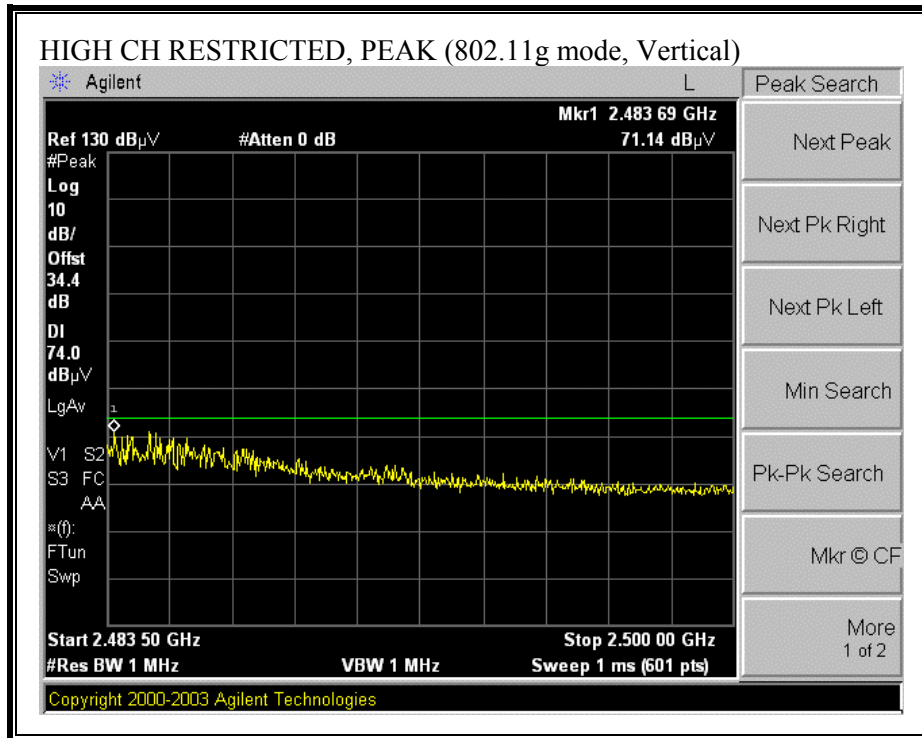

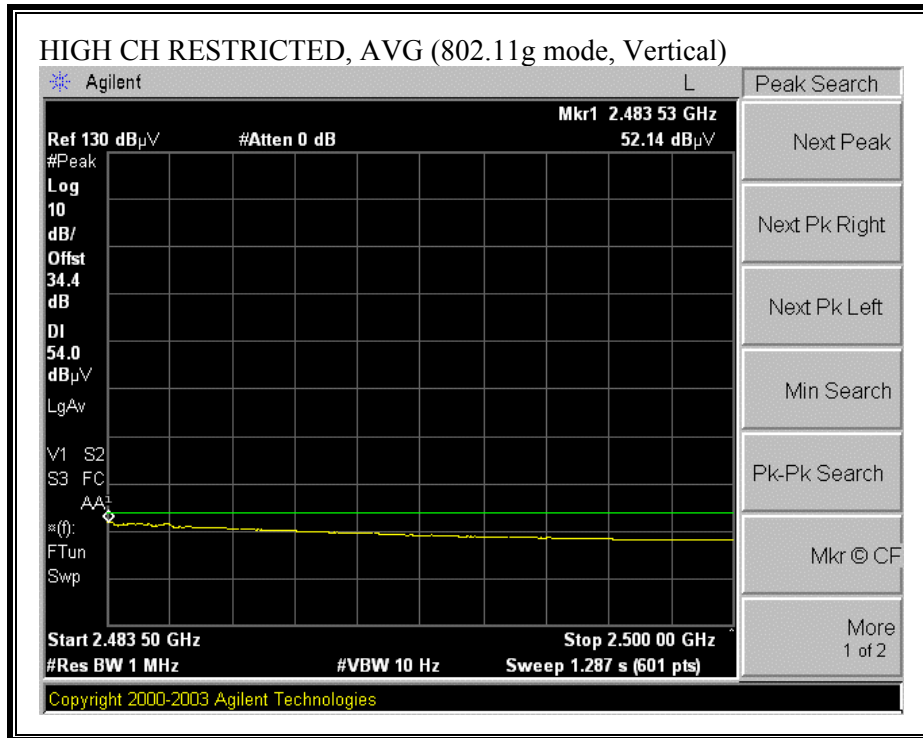

HARMONICS AND SPURIOUS EMISSIONS (g MODE)

02/09/04 High Frequency Measurement Compliance Certification Services, Morgan Hill Open Field Site																
Test Engr: Project #: Company: Airgo Networks EUT Descr.: 802.11abg MMO AP EUT M/N: 1200AP/WS112 Test Target: FCC 15.247, IC RSS-210 Mode Oper: B Mode																
Test Equipment:																
EMCO Horn 1-18GHz		Spectrum Analyzer			Pre-amplifier 1-26GHz			Pre-amplifier 26-40GHz			Horn > 18GHz					
T120; S/N: 29310 @3m		HP 8593EM Analyzer			T63 Miteq 646456											
Hi Frequency Cables: <input type="checkbox"/> (2 ft) <input checked="" type="checkbox"/> (2 ~ 3 ft) <input type="checkbox"/> (4 ~ 6 ft) <input checked="" type="checkbox"/> (12 ft)																
Peak Measurements: 1 MHz Resolution Bandwidth 1MHz Video Bandwidth																
Average Measurements: 1 MHz Resolution Bandwidth 10Hz Video Bandwidth																
f GHz	Dist feet	Read Pk dBuV	Read Avg. dBuV	AF dB/m	CL dB	Amp dB	D Corr dB	HPF	Peak dBuV/m	Avg dBuV/m	Pk Lim dBuV/m	Avg Lim dBuV/m	Pk Mar dB	Avg Mar dB	Notes	
B Mode WS112																
Low Channel																
4.824	9.8	45.4	37.5	33.7	3.2	-35.3	0.0	1.0	47.9	40.0	74.0	54.0	-26.1	-14.0	V	
4.824	9.8	40.8	28.3	33.7	3.2	-35.3	0.0	1.0	43.3	30.8	74.0	54.0	-30.7	-23.2	H	
Mid Channel																
4.874	9.8	47.3	33.1	33.7	3.2	-35.3	0.0	1.0	49.8	35.7	74.0	54.0	-24.2	-18.3	V	
4.874	9.8	40.4	29.6	33.7	3.2	-35.3	0.0	1.0	43.0	32.2	74.0	54.0	-31.0	-21.8	H	
High Channel																
4.924	9.8	45.3	39.0	33.8	3.2	-35.3	0.0	1.0	47.9	41.6	74.0	54.0	-26.1	-12.4	V	
4.924	9.8	41.3	30.1	33.8	3.2	-35.3	0.0	1.0	43.9	32.7	74.0	54.0	-30.1	-21.3	H	
G Mode WS111																
Low Channel																
4.824	9.8	47.7	30.0	33.7	3.2	-35.3	0.0	1.0	50.3	32.5	74.0	54.0	-23.7	-21.5	V	
4.824	9.8	41.7	29.4	33.7	3.2	-35.3	0.0	1.0	44.2	31.9	74.0	54.0	-29.8	-22.1	H	
Mid Channel																
4.874	9.8	46.0	32.1	33.7	3.2	-35.3	0.0	1.0	48.6	34.7	74.0	54.0	-25.4	-19.3	V	
4.874	9.8	41.2	26.9	33.7	3.2	-35.3	0.0	1.0	43.8	29.5	74.0	54.0	-30.2	-24.5	H	
High Channel																
4.924	9.8	43.5	30.5	33.8	3.2	-35.3	0.0	1.0	46.1	33.1	74.0	54.0	-27.9	-20.9	V	
4.924	9.8	37.4	27.1	33.8	3.2	-35.3	0.0	1.0	40.0	29.7	74.0	54.0	-34.0	-24.3	H	
f	Measurement Frequency					Amp	Preamp Gain					Avg Lim	Average Field Strength Limit			
Dist	Distance to Antenna					D Corr	Distance Correct to 3 meters					Pk Lim	Peak Field Strength Limit			
Read	Analyzer Reading					Avg	Average Field Strength @ 3 m					Avg Mar	Margin vs. Average Limit			
AF	Antenna Factor					Peak	Calculated Peak Field Strength					Pk Mar	Margin vs. Peak Limit			
CL	Cable Loss					HPF	High Pass Filter									

HARMONICS AND SPURIOUS EMISSIONS (a MODE)

02/09/04 **High Frequency Measurement**
 Compliance Certification Services, Morgan Hill Open Field Site

Test Engr:
Project #:
Company: Airgo Networks
EUT Descrip.: 802.11abg MMO AP
EUT M/N: 1200AP/WS112
Test Target: FCC 15.247, IC RSS-210
Mode Oper: B Mode

Test Equipment:

EMCO Horn 1-18GHz	Spectrum Analyzer	Pre-amplifier 1-26GHz	Pre-amplifier 26-40GHz	Horn > 18GHz
T120; S/N: 29310 @3m	HP 8593EM Analyzer	T63 Miteq 646456		

Hi Frequency Cables
 (2 ft) (2 ~ 3 ft) (4 ~ 6 ft) (12 ft)

Peak Measurements:
 1 MHz Resolution Bandwidth
 1MHz Video Bandwidth

Average Measurements:
 1 MHz Resolution Bandwidth
 10Hz Video Bandwidth

f GHz	Dist feet	Read Pk dBuV	Read Avg. dBuV	AF dB/m	CL dB	Amp dB	D Corr dB	HPF	Peak dBuV/m	Avg dBuV/m	Pk Lim dBuV/m	Avg Lim dBuV/m	Pk Mar dB	Avg Mar dB	Notes
DTS WS112															
Low Channel															
11.490	9.8	42.6	29.6	38.5	5.1	-34.2	0.0	1.0	53.0	40.0	74.0	54.0	-21.0	-14.0	V
11.490	9.8	41.5	29.5	38.5	5.1	-34.2	0.0	1.0	51.9	39.9	74.0	54.0	-22.1	-14.1	H
Mid Channel															
11.570	9.8	43.1	29.8	38.6	5.1	-34.3	0.0	1.0	53.5	40.2	74.0	54.0	-20.5	-13.8	V
11.570	9.8	43.1	29.6	38.6	5.1	-34.3	0.0	1.0	53.5	40.0	74.0	54.0	-20.5	-14.0	H
High Channel															
11.610	9.8	43.1	29.8	38.6	5.1	-34.3	0.0	1.0	53.5	40.2	74.0	54.0	-20.5	-13.8	V
11.610	9.8	41.6	29.9	38.6	5.1	-34.3	0.0	1.0	51.9	40.3	74.0	54.0	-22.1	-13.7	H
UNI WS111															
Low Channel															
10.360	9.8	41.9	28.8	37.6	4.7	-33.4	0.0	1.0	51.8	38.7	74.0	54.0	-22.2	-15.3	V
10.360	9.8	41.6	28.6	37.6	4.7	-33.4	0.0	1.0	51.5	38.5	74.0	54.0	-22.5	-15.5	H
Mid Channel															
10.520	9.8	42.7	28.0	37.7	4.8	-33.5	0.0	1.0	52.7	38.0	74.0	54.0	-21.3	-16.0	V
10.520	9.8	40.2	28.2	37.7	4.8	-33.5	0.0	1.0	50.2	38.2	74.0	54.0	-23.8	-15.8	H
High Channel															
10.640	9.8	41.9	28.7	37.8	4.8	-33.5	0.0	1.0	52.0	38.8	74.0	54.0	-22.0	-15.2	V
10.640	9.8	41.9	28.7	37.8	4.8	-33.5	0.0	1.0	52.0	38.8	74.0	54.0	-22.0	-15.2	H

f	Measurement Frequency	Amp	Preamp Gain	Avg Lim	Average Field Strength Limit
Dist	Distance to Antenna	D Corr	Distance Correct to 3 meters	Pk Lim	Peak Field Strength Limit
Read	Analyzer Reading	Avg	Average Field Strength @ 3 m	Avg Mar	Margin vs. Average Limit
AF	Antenna Factor	Peak	Calculated Peak Field Strength	Pk Mar	Margin vs. Peak Limit
CL	Cable Loss	HPF	High Pass Filter		

7.8.3. WORST-CASE RADIATED EMISSIONS BELOW 1 GHz

SPURIOUS EMISSIONS 30 TO 1000 MHz (WORST-CASE CONFIGURATION, HORIZONTAL)

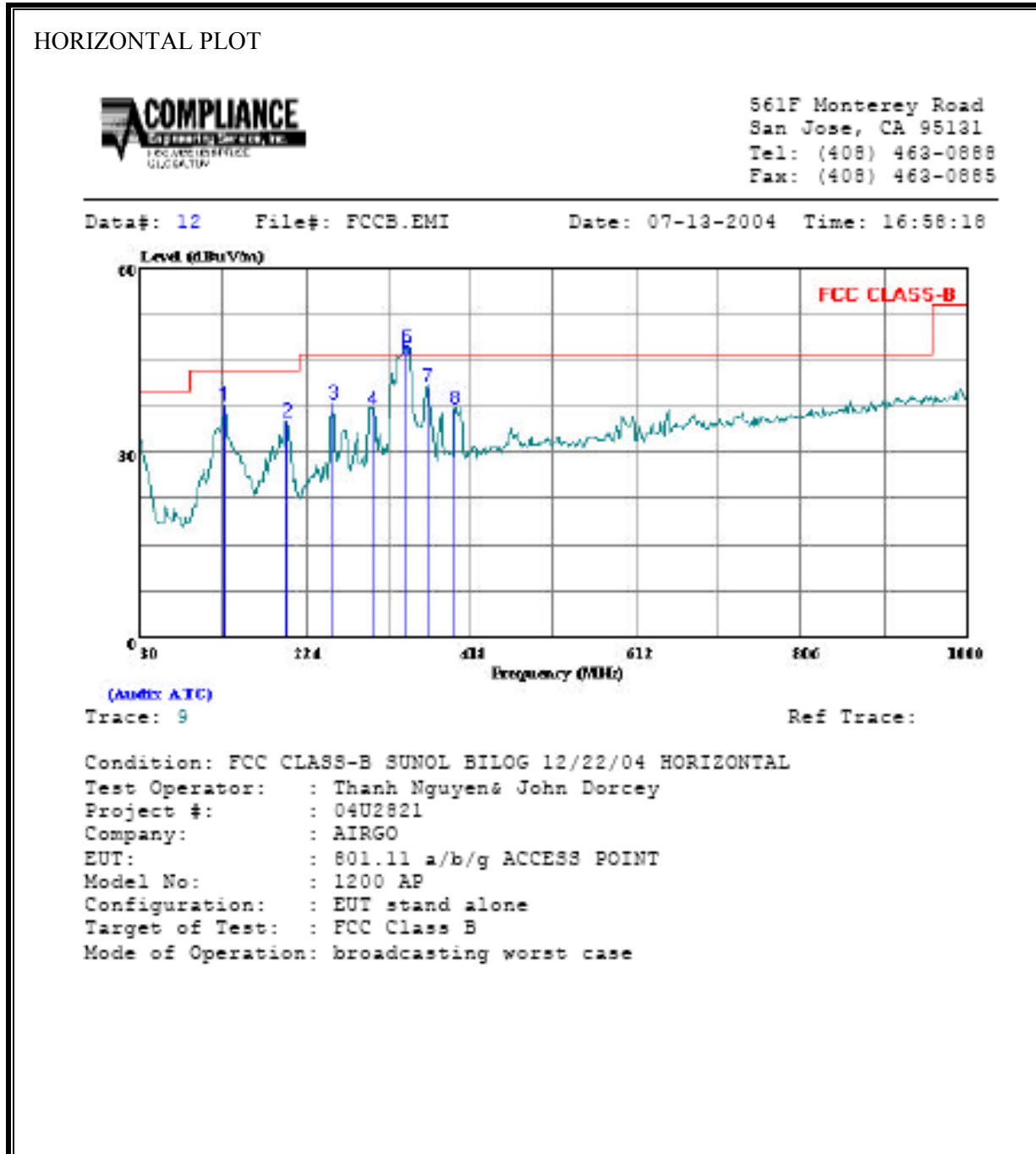

HORIZONTAL DATA

	Freq	Remark	Read Level	Factor	Level	Limit Line	Over Limit
	MHz		dBuV	dB	dBuV/m	dBuV/m	dB
1	128.940	Peak	22.01	15.53	37.54	43.50	-5.96
2	201.690	Peak	21.35	13.78	35.13	43.50	-8.37
3	256.980	Peak	23.52	14.45	37.97	46.00	-8.03
4	302.570	Peak	21.18	15.97	37.15	46.00	-8.85
5	342.340	QP	28.60	16.70	45.30	46.00	-0.70
6 *	342.340	Peak	30.65	16.71	47.36	46.00	1.36
7	367.560	Peak	23.33	17.40	40.73	46.00	-5.27
8	399.570	Peak	18.84	18.21	37.05	46.00	-8.95

SPURIOUS EMISSIONS 30 TO 1000 MHz (WORST-CASE CONFIGURATION, VERTICAL)

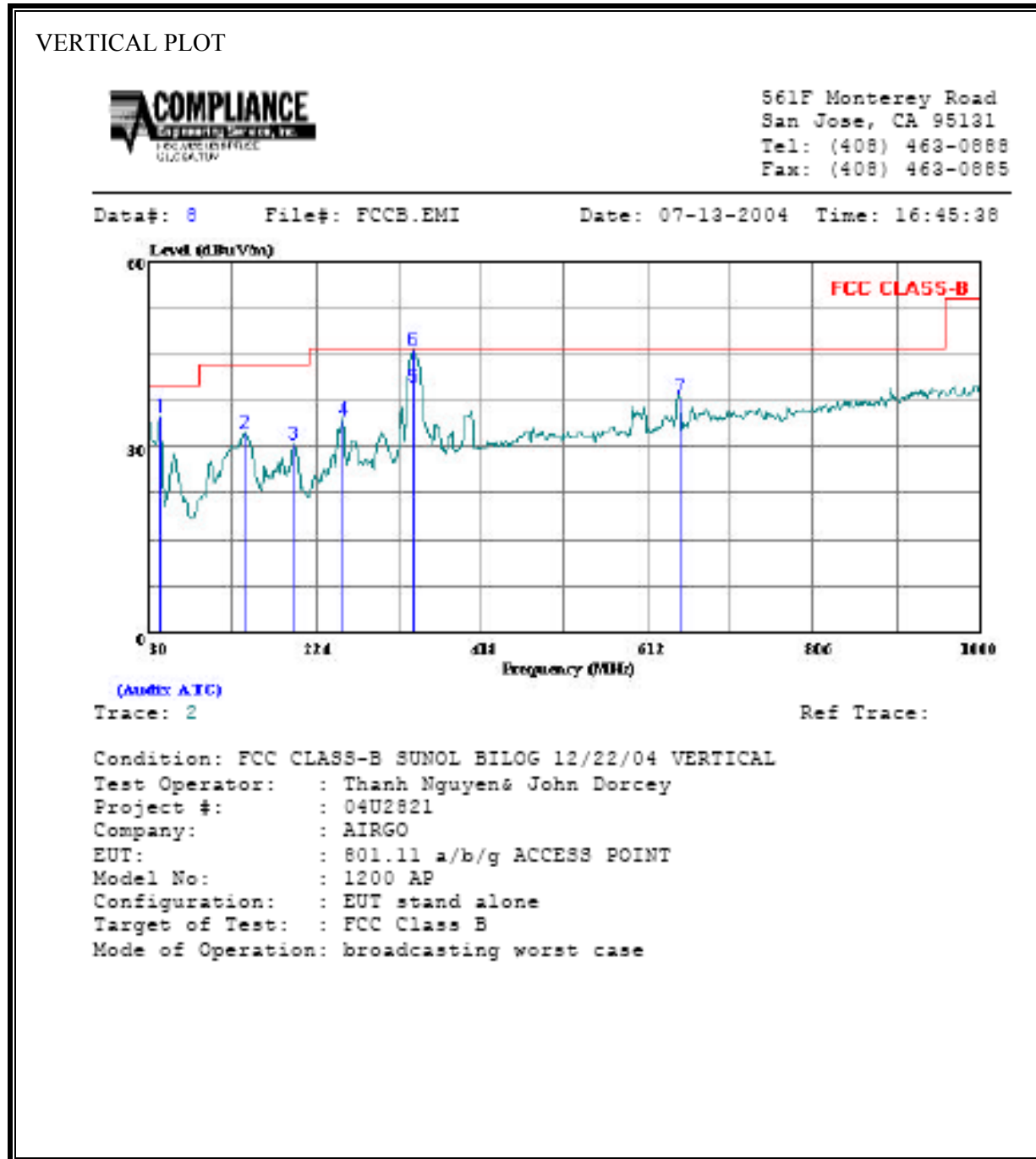

VERTICAL DATA

	Freq	Remark	Read Level	Factor	Level	Limit Line	Over Limit
	MHz		dBuV	dB	dBuV/m	dBuV/m	dB
1	41.640	Peak	18.94	15.74	34.68	40.00	-5.32
2	140.580	Peak	17.08	15.23	32.31	43.50	-11.19
3	196.840	Peak	17.03	13.36	30.39	43.50	-13.11
4	256.010	Peak	19.96	14.41	34.37	46.00	-11.63
5	337.490	QP	23.15	16.60	39.75	46.00	-6.25
6	337.490	Peak	29.07	16.61	45.68	46.00	-0.32
7	649.830	Peak	15.00	22.94	37.94	46.00	-8.06

7.9. POWERLINE CONDUCTED EMISSIONS

LIMIT

§15.207 (a) Except as shown in paragraphs (b) and (c) of this section, for an intentional radiator that is designed to be connected to the public utility (AC) power line, the radio frequency voltage that is conducted back onto the AC power line on any frequency or frequencies within the band 150 kHz to 30 MHz shall not exceed the limits in the following table, as measured using a 50 μ H/50 ohms line impedance stabilization network (LISN). Compliance with the provisions of this paragraph shall be based on the measurement of the radio frequency voltage between each power line and ground at the power terminal.

The lower limit applies at the boundary between the frequency ranges.

Frequency of Emission (MHz)	Conducted Limit (dBuV)	
	Quasi-peak	Average
0.15-0.5	66 to 56*	56 to 46*
0.5-5	56	46
5-30	60	50

*Decreases with the logarithm of the frequency.

TEST PROCEDURE

The EUT is placed on a non-conducting table 40 cm from the vertical ground plane and 80 cm above the horizontal ground plane. The EUT is configured in accordance with ANSI C63.4.

The resolution bandwidth is set to 9 kHz for both peak detection and quasi-peak detection measurements. Peak detection is used unless otherwise noted as quasi-peak.

Line conducted data is recorded for both NEUTRAL and HOT lines.

RESULTS

No non-compliance noted:

6 WORST EMISSIONS

CONDUCTED EMISSIONS DATA (115VAC 60Hz)									
Freq.	Reading			Closs	Limit	EN B	Margin		Remark
(MHz)	PK (dBuV)	QP (dBuV)	AV (dBuV)	(dB)	QP	AV	QP (dB)	AV (dB)	L1 / L2
0.71	49.22	--	34.76	0.00	56.00	46.00	-6.78	-11.24	L1
5.74	49.46	--	28.93	0.00	60.00	50.00	-10.54	-21.07	L1
0.42	48.72	--	39.05	0.00	58.37	48.37	-9.65	-9.32	L1
0.71	48.64	--	33.92	0.00	56.00	46.00	-7.36	-12.08	L2
0.42	48.55	--	38.97	0.00	58.37	48.37	-9.82	-9.40	L2
4.77	48.86	--	23.52	0.00	56.00	46.00	-7.14	-22.48	L2
6 Worst Data									

LINE 1 RESULTS

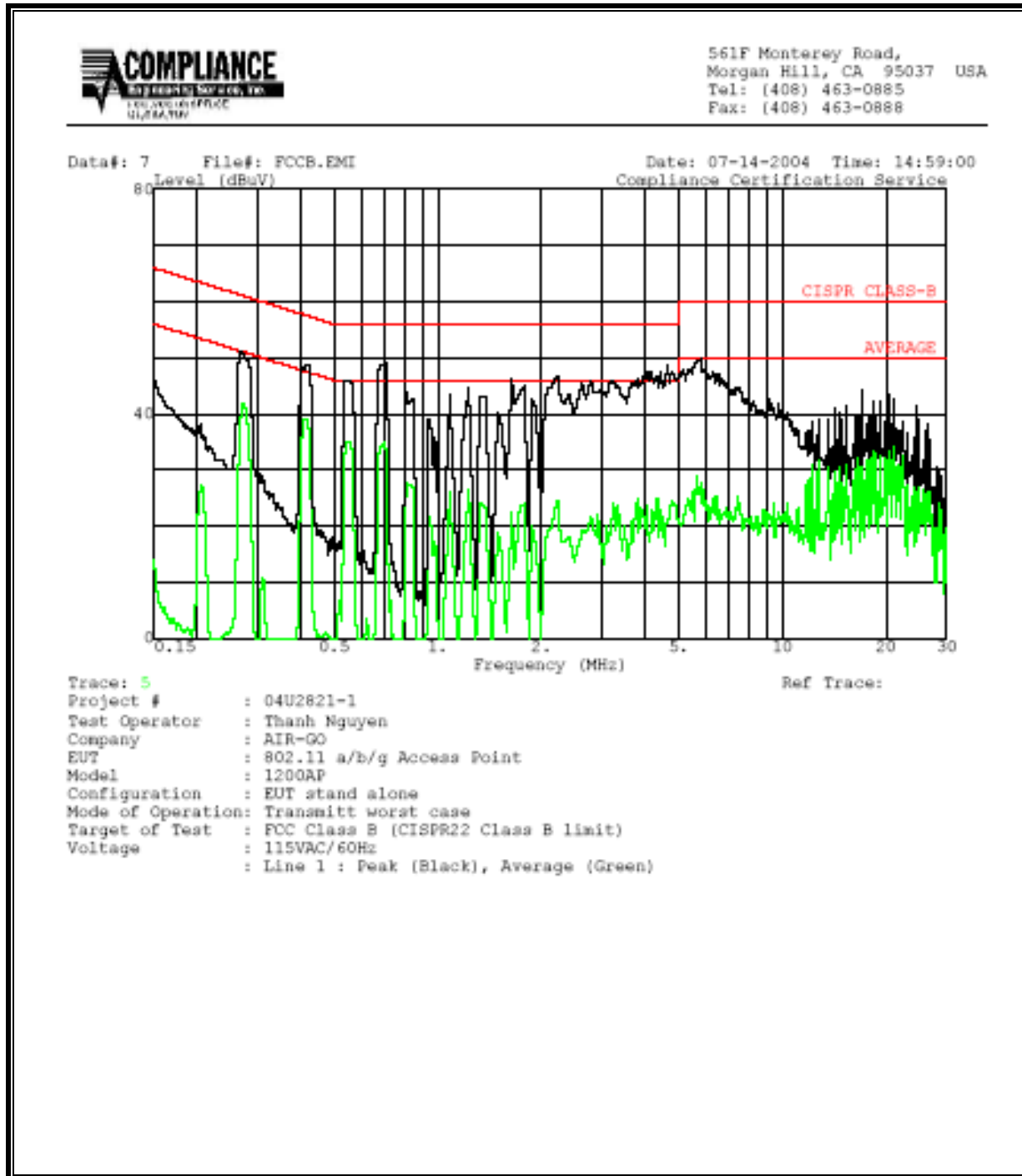

LINE 2 RESULTS

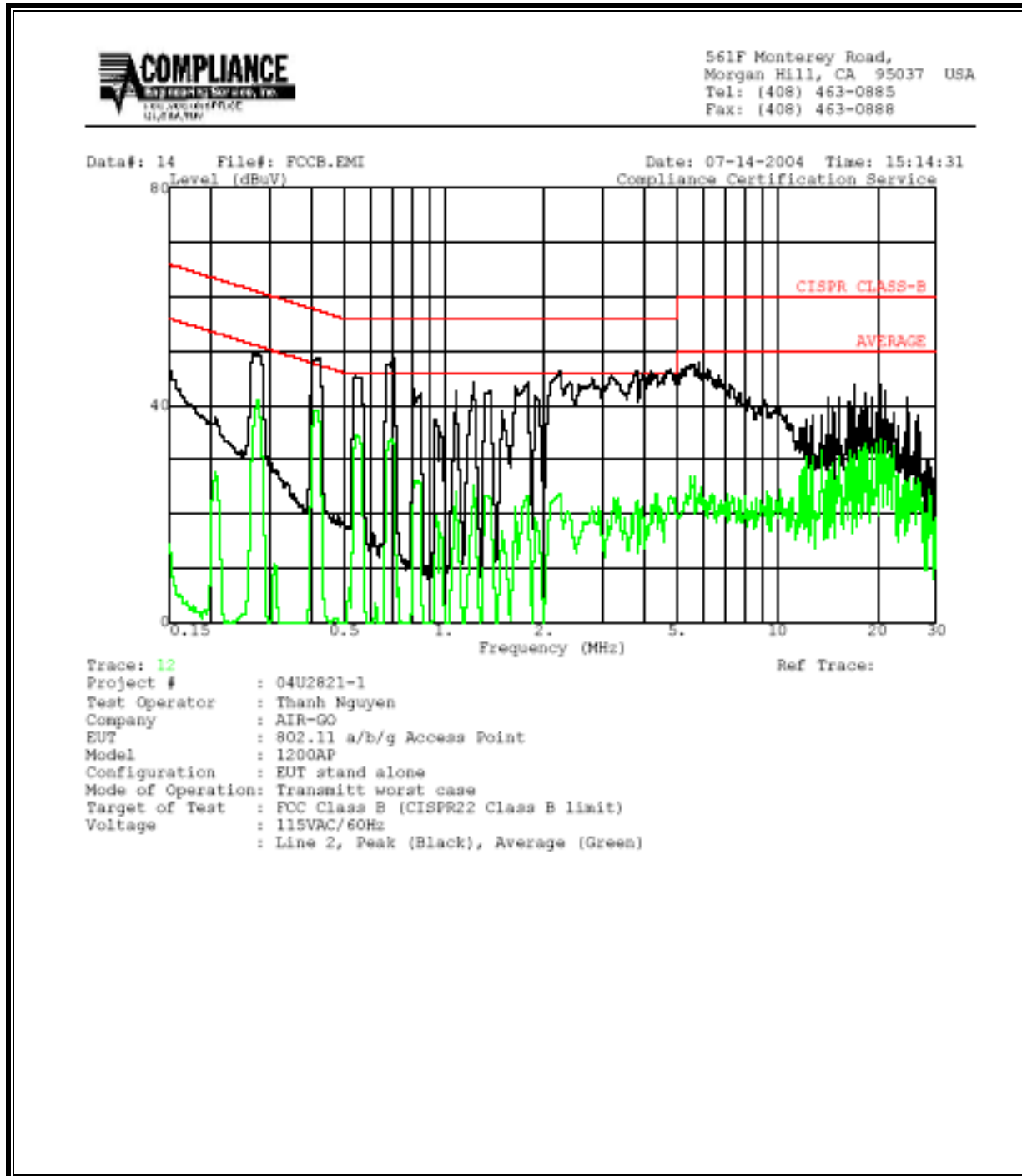

8. SETUP PHOTOS

ANTENNA PORT CONDUCTED RF MEASUREMENT SETUP

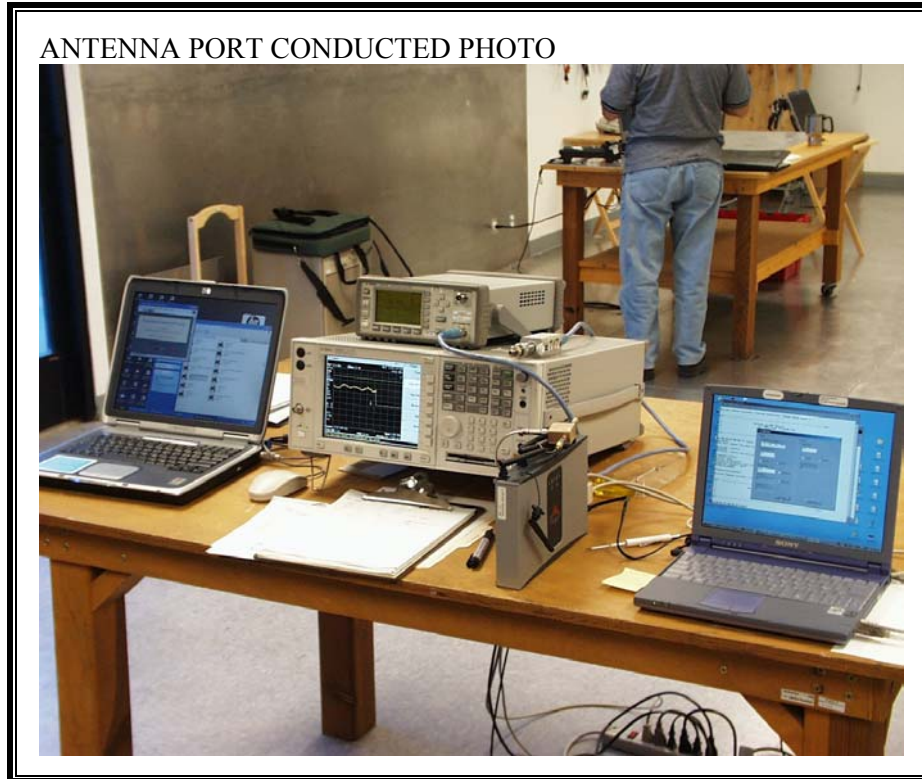

RADIATED RF MEASUREMENT SETUP





POWERLINE CONDUCTED EMISSIONS MEASUREMENT SETUP





END OF REPORT