



FCC TEST REPORT (15.407)

REPORT NO.: RF980105L17-1

MODEL NO.: TEW-664UB

RECEIVED: Nov. 11, 2008

TESTED: Dec. 24, 2008 ~ Jan. 13, 2009

ISSUED: Feb. 02, 2009

APPLICANT: TRENDware International Inc

ADDRESS: 20675 Manhattan Place, Torrance, CA 90501,
USA

ISSUED BY: Bureau Veritas Consumer Products Services
(H.K.) Ltd., Taoyuan Branch

LAB ADDRESS: No. 47, 14th Ling, Chia Pau Tsuen, Lin Kou
Hsiang, Taipei Hsien 244, Taiwan, R.O.C.

TEST LOCATION: No. 19, Hwa Ya 2nd Rd, Wen Hwa Tsuen, Kwei
Shan Hsiang, Taoyuan Hsien 333, Taiwan,
R.O.C.

This test report consists of 99 pages in total. It may be duplicated completely for legal use with the approval of the applicant. It should not be reproduced except in full, without the written approval of our laboratory. The client should not use it to claim product endorsement by TAF or any government agencies. The test results in the report only apply to the tested sample.





TABLE OF CONTENTS

1.	CERTIFICATION.....	4
2.	SUMMARY OF TEST RESULTS	5
2.1	MEASUREMENT UNCERTAINTY	5
3.	GENERAL INFORMATION.....	6
3.1	GENERAL DESCRIPTION OF EUT	6
3.2	DESCRIPTION OF TEST MODES	8
3.2.1	CONFIGURATION OF SYSTEM UNDER TEST	8
3.2.2	TEST MODE APPLICABILITY AND TESTED CHANNEL DETAIL	9
3.3	GENERAL DESCRIPTION OF APPLIED STANDARDS	11
3.4	DESCRIPTION OF SUPPORT UNITS	11
4.	TEST TYPES AND RESULTS	12
4.1	RADIATED EMISSION MEASUREMENT	12
4.1.1	LIMITS OF RADIATED EMISSION MEASUREMENT	12
4.1.2	LIMITS OF UNWANTED EMISSION OUT OF THE RESTRICTED BANDS	12
4.1.3	TEST INSTRUMENTS.....	13
4.1.4	TEST PROCEDURES	14
4.1.5	DEVIATION FROM TEST STANDARD.....	14
4.1.6	TEST SETUP	15
4.1.7	EUT OPERATING CONDITION.....	15
4.1.8	TEST RESULTS	16
4.2	CONDUCTED EMISSION MEASUREMENT	25
4.2.1	LIMITS OF CONDUCTED EMISSION MEASUREMENT	25
4.2.2	TEST INSTRUMENTS.....	25
4.2.3	TEST PROCEDURES	26
4.2.4	DEVIATION FROM TEST STANDARD.....	26
4.2.5	TEST SETUP	27
4.2.6	EUT OPERATING CONDITIONS	27
4.2.7	TEST RESULTS	28
4.3	PEAK TRANSMIT POWER MEASUREMENT	30
4.3.1	LIMITS OF PEAK TRANSMIT POWER MEASUREMENT	30
4.3.2	TEST INSTRUMENTS.....	30
4.3.3	TEST PROCEDURE.....	30
4.3.4	DEVIATION FROM TEST STANDARD.....	31
4.3.5	TEST SETUP	31
4.3.6	EUT OPERATING CONDITIONS	31
4.3.7	TEST RESULTS	32
4.4	PEAK POWER EXCURSION MEASUREMENT	45
4.4.1	LIMITS OF PEAK POWER EXCURSION MEASUREMENT	45
4.4.2	TEST INSTRUMENTS.....	45
4.4.3	TEST PROCEDURE.....	45
4.4.4	DEVIATION FROM TEST STANDARD.....	46
4.4.5	TEST SETUP	46
4.4.6	EUT OPERATING CONDITIONS	46
4.4.7	TEST RESULTS	47



A D T

4.5	PEAK POWER SPECTRAL DENSITY MEASUREMENT	66
4.5.1	LIMITS OF PEAK POWER SPECTRAL DENSITY MEASUREMENT	66
4.5.2	TEST INSTRUMENTS.....	66
4.5.3	TEST PROCEDURES	66
4.5.4	DEVIATION FROM TEST STANDARD.....	67
4.5.5	TEST SETUP	67
4.5.6	EUT OPERATING CONDITIONS	67
4.5.7	TEST RESULTS	68
4.6	FREQUENCY STABILITY.....	79
4.6.1	LIMITS OF FREQUENCY STABILITY MEASUREMENT	79
4.6.2	TEST INSTRUMENTS.....	79
4.6.3	TEST PROCEDURE.....	79
4.6.4	DEVIATION FROM TEST STANDARD.....	80
4.6.5	TEST SETUP	80
4.6.6	EUT OPERATING CONDITION.....	80
4.6.7	TEST RESULTS	81
4.7	BAND EDGES MEASUREMENT	82
4.7.1	TEST INSTRUMENTS.....	82
4.7.2	TEST PROCEDURE.....	83
4.7.3	EUT OPERATING CONDITION.....	83
4.7.4	TEST RESULTS	84
4.8	ANTENNA REQUIREMENT	96
4.8.1	STANDARD APPLICABLE.....	96
4.8.2	ANTENNA CONNECTED CONSTRUCTION	96
5.	PHOTOGRAPHS OF THE TEST CONFIGURATION	97
6.	INFORMATION ON THE TESTING LABORATORIES	98
7.	APPENDIX A - MODIFICATIONS RECORDERS FOR ENGINEERING CHANGES TO THE EUT BY THE LAB.....	99



1. CERTIFICATION

PRODUCT: 802.11n dual band USB adapter

MODEL: TEW-664UB

BRAND: TRENDnet

APPLICANT: TRENDware International Inc

TEST SAMPLE: ENGINEERING SAMPLE

TESTED: Dec. 24, 2008 ~ Jan. 13, 2009

STANDARDS: FCC Part 15, Subpart E (Section 15.407)

ANSI C63.4-2003

The above equipment (Model: TEW-664UB) has been tested by **Bureau Veritas Consumer Products Services (H.K.) Ltd., Taoyuan Branch**, and found compliance with the requirement of the above standards. The test record, data evaluation & Equipment Under Test (EUT) configurations represented herein are true and accurate accounts of the measurements of the sample's EMC characteristics under the conditions specified in this report.

PREPARED BY : Polly Chien , **DATE** : Feb. 02, 2009
Polly Chien / Specialist

TECHNICAL ACCEPTANCE : Long Chen , **DATE** : Feb. 02, 2009
Responsible for RF Long Chen / Senior Engineer

APPROVED BY : Gary Chang , **DATE** : Feb. 02, 2009
Gary Chang / Assistant Manager

2. SUMMARY OF TEST RESULTS

The EUT has been tested according to the following specifications:

APPLIED STANDARD: FCC PART 15, SUBPART E (SECTION 15.407)			
STANDARD SECTION	TEST TYPE AND LIMIT	RESULT	REMARK
15.407(b)(5)	AC Power Conducted Emission	PASS	Meet the requirement of limit. Minimum passing margin is -14.11dB at 0.173MHz.
15.407(b)(1/2/3) (b)(5)	Electric Field Strength Spurious Emissions, 30MHz ~ 40000MHz	PASS	Meet the requirement of limit. Minimum passing margin is -1.16dB at 10360.00MHz.
15.407(a)(1/2/3)	Peak Transmit Power	PASS	Meet the requirement of limit.
15.407(a)(6)	Peak Power Excursion	PASS	Meet the requirement of limit.
15.407(a)(1/2/3)	Peak Power Spectral Density	PASS	Meet the requirement of limit.
15.407(g)	Frequency Stability	PASS	Meet the requirement of limit.

2.1 MEASUREMENT UNCERTAINTY

Where relevant, the following measurement uncertainty levels have been estimated for tests performed on the EUT as specified in CISPR 16-4-2:

MEASUREMENT	FREQUENCY	UNCERTAINTY
Conducted emissions	9kHz~30MHz	2.44 dB
Radiated emissions	30MHz ~ 200MHz	2.93 dB
	200MHz ~1000MHz	2.95 dB
	1GHz ~ 18GHz	2.26 dB
	18GHz ~ 40GHz	1.94 dB

This uncertainty represents an expanded uncertainty expressed at approximately the 95% confidence level using a coverage factor of $k = 2$.



3. GENERAL INFORMATION

3.1 GENERAL DESCRIPTION OF EUT

EUT	802.11n dual band USB adapter
MODEL NO.	TEW-664UB
FCC ID	S9ZTEW664UB
POWER SUPPLY	5.0Vdc from host equipment
MODULATION TYPE	CCK, DQPSK, DBPSK for DSSS 64QAM, 16QAM, QPSK, BPSK for OFDM
MODULATION TECHNOLOGY	DSSS, OFDM
TRANSFER RATE	802.11b: 11.0/ 5.5/ 2.0/ 1.0Mbps 802.11g: 54.0/ 48.0/ 36.0/ 24.0/ 18.0/ 12.0/ 9.0/ 6.0Mbps 802.11a: 54.0/ 48.0/ 36.0/ 24.0/ 18.0/ 12.0/ 9.0/ 6.0Mbps Draft 802.11n: up to 300.0Mbps
FREQUENCY RANGE	2.4GHz: 2400.0 ~ 2483.5MHz 5.0GHz: 5150.0 ~ 5250.0MHz, 5725.0 ~ 5825.0MHz
NUMBER OF CHANNEL	2.4GHz: 11 for 802.11b, 802.11g, draft 802.11n (20MHz) 7 for draft 802.11n (40MHz) 5.0GHz: 9 for 802.11a, draft 802.11n (20MHz) 4 for draft 802.11n (40MHz)
OUTPUT POWER	387.900mW for 2400.0 ~ 2483.5MHz 36.611mW for 5150.0 ~ 5250.0MHz 256.766mW for 5725.0 ~ 5825.0MHz
ANTENNA TYPE	2.4GHz: Printed antenna with -0.07dBi gain 5.0GHz: Printed antenna with 3.07dBi gain
DATA CABLE	NA
I/O PORTS	USB
ASSOCIATED DEVICES	NA



NOTE:

1. The EUT is a 802.11n dual band USB adapter. The functions of EUT listed as below:

	TEST STANDARD	REFERENCE REPORT
WLAN 802.11b/g, draft 802.11n	FCC Part 15, Subpart C (Section 15.247)	RF980105L17
WLAN 802.11a, draft 802.11n (5725~5825 MHz)		
WLAN 802.11a, draft 802.11n (5150~ 5250MHz)	FCC Part 15, Subpart E (Section 15.407)	RF980105L17-1

2. The frequency bands used in this EUT are listed as follows:

Frequency Band (MHz)	2400~2483.5	5150~5250	5725~5825
802.11b	√		
802.11g	√		
802.11a		√	√
Draft 802.11n (20MHz)	√	√	√
Draft 802.11n (40MHz)	√	√	√

3. The EUT incorporates a MIMO function. Physically, the EUT provides two completed transmitters and two receivers.

MODULATION MODE	TX FUNCTION
802.11b	2TX
802.11g	2TX
802.11a	2TX
Draft 802.11n (20MHz)	2TX
Draft 802.11n (40MHz)	2TX

4. The above EUT information was declared by manufacturer and for more detailed features description, please refer to the manufacturer's specifications or user's manual.

3.2 DESCRIPTION OF TEST MODES

4 channels are provided for 802.11a, draft 802.11n (20MHz):

CHANNEL	FREQUENCY	CHANNEL	FREQUENCY
36	5180MHz	44	5220MHz
40	5200MHz	48	5240MHz

2 channels are provided for draft 802.11n (40MHz):

CHANNEL	FREQUENCY	CHANNEL	FREQUENCY
38	5190MHz	46	5230MHz

3.2.1 CONFIGURATION OF SYSTEM UNDER TEST

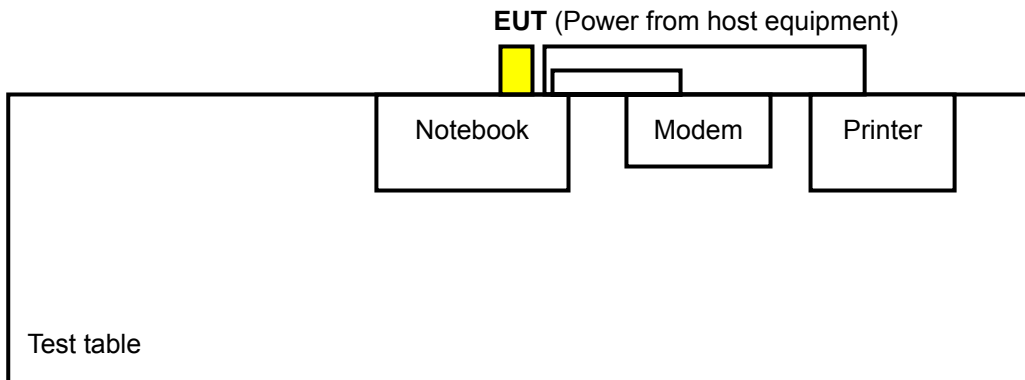



3.2.2 TEST MODE APPLICABILITY AND TESTED CHANNEL DETAIL

EUT CONFIGURE MODE	APPLICABLE TO				DESCRIPTION
	RE≥1G	RE<1G	PLC	APCM	
-	√	√	√	√	-

Where **RE≥1G**: Radiated Emission above 1GHz **RE<1G**: Radiated Emission below 1GHz
PLC: Power Line Conducted Emission **APCM**: Antenna Port Conducted Measurement

RADIATED EMISSION TEST (ABOVE 1GHz):

- Pre-Scan has been conducted to determine the worst-case mode from all possible combinations between available modulations, data rates and antenna ports (if EUT with antenna diversity architecture).
- Following channel(s) was (were) selected for the final test as listed below.

EUT CONFIGURE MODE	MODE	AVAILABLE CHANNEL	TESTED CHANNEL	MODULATION TECHNOLOGY	MODULATION TYPE	DATA RATE (Mbps)
-	802.11a	36 to 48	36, 40, 48	OFDM	BPSK	6.0
-	Draft 802.11n (20MHz)	36 to 48	36, 40, 48	OFDM	BPSK	7.2
-	Draft 802.11n (40MHz)	38 to 46	38, 46	OFDM	BPSK	15.0

RADIATED EMISSION TEST (BELOW 1GHz):

- Pre-Scan has been conducted to determine the worst-case mode from all possible combinations between available modulations, data rates and antenna ports (if EUT with antenna diversity architecture).
- Following channel(s) was (were) selected for the final test as listed below.

EUT CONFIGURE MODE	MODE	AVAILABLE CHANNEL	TESTED CHANNEL	MODULATION TECHNOLOGY	MODULATION TYPE	DATA RATE (Mbps)
-	802.11a	36 to 48	40	OFDM	BPSK	6.0

POWER LINE CONDUCTED EMISSION TEST:

- Pre-Scan has been conducted to determine the worst-case mode from all possible combinations between available modulations, data rates and antenna ports (if EUT with antenna diversity architecture).
- Following channel(s) was (were) selected for the final test as listed below.

EUT CONFIGURE MODE	MODE	AVAILABLE CHANNEL	TESTED CHANNEL	MODULATION TECHNOLOGY	MODULATION TYPE	DATA RATE (Mbps)
-	802.11a	36 to 48	40	OFDM	BPSK	6.0

BANDEDGE MEASUREMENT:

- Pre-Scan has been conducted to determine the worst-case mode from all possible combinations between available modulations, data rates and antenna ports (if EUT with antenna diversity architecture).
- Following channel(s) was (were) selected for the final test as listed below.

EUT CONFIGURE MODE	MODE	AVAILABLE CHANNEL	TESTED CHANNEL	MODULATION TECHNOLOGY	MODULATION TYPE	DATA RATE (Mbps)
-	802.11a	36 to 48	36, 48	OFDM	BPSK	6.0
-	Draft 802.11n (20MHz)	36 to 48	36, 48	OFDM	BPSK	7.2
-	Draft 802.11n (40MHz)	38 to 46	38, 46	OFDM	BPSK	15.0

ANTENNA PORT CONDUCTED MEASUREMENT:

- Pre-Scan has been conducted to determine the worst-case mode from all possible combinations between available modulations, data rates and antenna ports (if EUT with antenna diversity architecture).
- Following channel(s) was (were) selected for the final test as listed below.

EUT CONFIGURE MODE	MODE	AVAILABLE CHANNEL	TESTED CHANNEL	MODULATION TECHNOLOGY	MODULATION TYPE	DATA RATE (Mbps)
-	802.11a	36 to 48	36, 40, 48	OFDM	BPSK	6.0
-	Draft 802.11n (20MHz)	36 to 48	36, 40, 48	OFDM	BPSK	7.2
-	Draft 802.11n (40MHz)	38 to 46	38, 46	OFDM	BPSK	15.0

3.3 GENERAL DESCRIPTION OF APPLIED STANDARDS

The EUT is a RF Product. According to the specifications of the manufacturer, it must comply with the requirements of the following standards:

FCC Part 15, Subpart E (15.407)
ANSI C63.4-2003

All test items have been performed and recorded as per the above standards.

NOTE: The EUT is also considered as a kind of computer peripheral, because the connection to computer is necessary for typical use. It has been verified to comply with the requirements of FCC Part 15, Subpart B, Class B (DoC). The test report has been issued separately.

3.4 DESCRIPTION OF SUPPORT UNITS

The EUT has been tested as an independent unit together with other necessary accessories or support units. The following support units or accessories were used to form a representative test configuration during the tests.

NO.	PRODUCT	BRAND	MODEL NO.	SERIAL NO.	FCC ID
1	NOTEBOOK	DELL	PP05L	16484462992	E2K24CLNS
2	PRINTER	EPSON	LQ-300+	DCGY054011	FCC DoC Approved
3	MODEM	ACEEX	1414V/3	0401008253	IFAXDM1414

NO.	SIGNAL CABLE DESCRIPTION OF THE ABOVE SUPPORT UNITS
1	NA
2	1.8m braid shielded wire, DB25 connector, w/o core.
3	1.2m braid shielded wire, DB25 & DB9 connector, w/o core.

NOTE: All power cords of the above support units are non shielded (1.8m).

4. TEST TYPES AND RESULTS

4.1 RADIATED EMISSION MEASUREMENT

4.1.1 LIMITS OF RADIATED EMISSION MEASUREMENT

Emissions radiated outside of the specified bands, shall be according to the general radiated limits in 15.209 as following:

FREQUENCIES (MHz)	FIELD STRENGTH (microvolts/meter)	MEASUREMENT DISTANCE (meters)
0.009 ~ 0.490	2400/F(kHz)	300
0.490 ~ 1.705	24000/F(kHz)	30
1.705 ~ 30.0	30	30
30 ~ 88	100	3
88 ~ 216	150	3
216 ~ 960	200	3
Above 960	500	3

NOTE:

1. The lower limit shall apply at the transition frequencies.
2. Emission level (dBuV/m) = 20 log Emission level (uV/m).
3. As shown in 15.35(b), for frequencies above 1000MHz, the field strength limits are based on average detector, however, the peak field strength of any emission shall not exceed the maximum permitted average limits, specified above by more than 20dB under any condition of modulation.

4.1.2 LIMITS OF UNWANTED EMISSION OUT OF THE RESTRICTED BANDS

FREQUENCIES (MHz)	EIRP LIMIT (dBm)	EQUIVALENT FIELD STRENGTH AT 3m (dBµV/m) *NOTE 3
	PK	PK
5150 ~ 5250	-27	68.3

NOTE: The following formula is used to convert the equipment isotropic radiated power (eirp) to field strength:

$$E = \frac{1000000\sqrt{30P}}{3} \mu\text{V/m, where P is the eirp (Watts).}$$

4.1.3 TEST INSTRUMENTS

DESCRIPTION & MANUFACTURER	MODEL NO.	SERIAL NO.	DATE OF CALIBRATION	DUE DATE OF CALIBRATION
Test Receiver ROHDE & SCHWARZ	ESIB7	100212	May 28, 2008	May 27, 2009
Spectrum Analyzer ROHDE & SCHWARZ	FSP40	100269	Aug. 08, 2008	Aug. 07, 2009
BILOG Antenna SCHWARZBECK	VULB9168	9168-156	Apr. 25, 2008	Apr. 24, 2009
HORN Antenna SCHWARZBECK	BBHA 9120 D	9120D-563	Aug. 06, 2008	Aug. 05, 2009
HORN Antenna SCHWARZBECK	BBHA 9170	BBHA9170148	Jul. 03, 2008	Jul. 02, 2009
Preamplifier Agilent	8449B	3008A01911	Sep. 10, 2008	Sep. 09, 2009
Preamplifier Agilent	8447D	2944A10638	Dec. 26, 2008	Dec. 25, 2009
RF signal cable HUBER+SUHNNER	SUCOFLEX 104	218190/4 231241/4	May 20, 2008	May 19, 2009
RF signal cable Worken	8D-FB	Cable-HYCH9-01	Aug. 09, 2008	Aug. 08, 2009
Software	ADT_Radiated_ V7.6.15.9.2	NA	NA	NA
Antenna Tower EMCO	2070/2080	512.835.4684	NA	NA
Turn Table EMCO	2087-2.03	NA	NA	NA
Antenna Tower & Turn Table Controller EMCO	2090	NA	NA	NA
26GHz ~ 40GHz Amplifier	EM26400	07026401	Aug. 27, 2008	Aug. 26, 2009

- NOTE:**
1. The calibration interval of the above test instruments is 12 months and the calibrations are traceable to NML/ROC and NIST/USA.
 2. The test was performed in HwaYa Chamber 9.
 3. The horn antenna and HP preamplifier (model: 8449B) are used only for the measurement of emission frequency above 1GHz if tested.
 4. The FCC Site Registration No. is 460141.
 5. The IC Site Registration No. is IC 7450F-4.

4.1.4 TEST PROCEDURES

- a. The EUT was placed on the top of a rotating table 0.8 meters above the ground at a 3 meter semi-anechoic chamber. The table was rotated 360 degrees to determine the position of the highest radiation.
- b. The EUT was set 3 meters away from the interference-receiving antenna, which was mounted on the top of a variable-height antenna tower.
- c. The antenna is a broadband antenna, and its height is varied from one meter to four meters above the ground to determine the maximum value of the field strength. Both horizontal and vertical polarizations of the antenna are set to make the measurement.
- d. For each suspected emission, the EUT was arranged to its worst case and then the antenna was tuned to heights from 1 meter to 4 meters and the rotatable table was turned from 0 degrees to 360 degrees to find the maximum reading.
- e. The test-receiver system was set to Peak Detect Function and Specified Bandwidth with Maximum Hold Mode.
- f. If the emission level of the EUT in peak mode was 10dB lower than the limit specified, then testing could be stopped and the peak values of the EUT would be reported. Otherwise the emissions that did not have 10dB margin would be re-tested one by one using peak, quasi-peak or average method as specified and then reported in a data sheet.

NOTE:

1. The resolution bandwidth and video bandwidth of test receiver/spectrum analyzer is 120kHz for Peak detection (PK) and Quasi-peak detection (QP) at frequency below 1GHz.
2. The resolution bandwidth of test receiver/spectrum analyzer is 1MHz and video bandwidth is 3MHz for Peak detection at frequency above 1GHz.
3. The resolution bandwidth of test receiver/spectrum analyzer is 1MHz and the video bandwidth is 10Hz for Average detection (AV) at frequency above 1GHz.
4. All modes of operation were investigated and the worst-case emissions are reported.

4.1.5 DEVIATION FROM TEST STANDARD

No deviation.

4.1.6 TEST SETUP

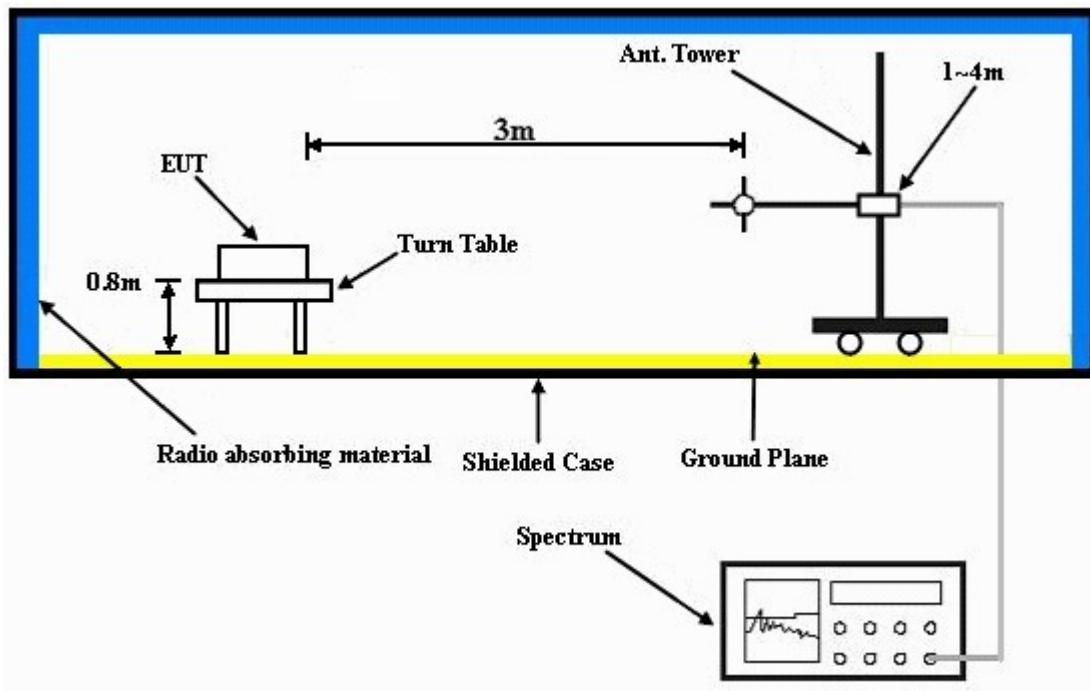

For the actual test configuration, please refer to the attached file (Test Setup Photo).

4.1.7 EUT OPERATING CONDITION

- a. Plugged EUT into the notebook system and placed on the testing table.
- b. The notebook system ran a test program (provided by manufacturer) to enable EUT under transmission condition continuously at specific channel frequency.
- c. The necessary accessories enable the EUT in full functions.

4.1.8 TEST RESULTS

802.11a OFDM MODULATION

EUT TEST CONDITION		MEASUREMENT DETAIL	
CHANNEL	Channel 36	FREQUENCY RANGE	1 ~ 40GHz
INPUT POWER (SYSTEM)	120Vac, 60 Hz	DETECTOR FUNCTION	Peak (PK) Average (AV)
ENVIRONMENTAL CONDITIONS	24deg. C, 64%RH 1000hPa	TESTED BY	Match Tsui

ANTENNA POLARITY & TEST DISTANCE: HORIZONTAL AT 3 M								
NO.	FREQ. (MHz)	EMISSION LEVEL (dBuV/m)	LIMIT (dBuV/m)	MARGIN (dB)	ANTENNA HEIGHT (m)	TABLE ANGLE (Degree)	RAW VALUE (dBuV)	CORRECTION FACTOR (dB/m)
1	4144.00	58.62 PK	74.00	-15.38	1.02 H	270	21.03	37.59
2	4144.00	51.69 AV	54.00	-2.31	1.02 H	270	14.10	37.59
3	5150.00	62.87 PK	74.00	-11.13	1.16 H	254	23.12	39.75
4	5150.00	44.91 AV	54.00	-9.09	1.16 H	254	5.16	39.75
5	*5180.00	107.52 PK			1.47 H	252	67.77	39.75
6	*5180.00	97.39 AV			1.47 H	252	57.64	39.75
7	#6216.00	60.59 PK	68.30	-7.71	1.00 H	228	18.65	41.94
8	#10360.00	62.95 PK	68.30	-5.35	1.36 H	244	12.30	50.65
ANTENNA POLARITY & TEST DISTANCE: VERTICAL AT 3 M								
NO.	FREQ. (MHz)	EMISSION LEVEL (dBuV/m)	LIMIT (dBuV/m)	MARGIN (dB)	ANTENNA HEIGHT (m)	TABLE ANGLE (Degree)	RAW VALUE (dBuV)	CORRECTION FACTOR (dB/m)
1	4144.00	53.19 PK	74.00	-20.81	1.00 V	288	15.60	37.59
2	4144.00	46.85 AV	54.00	-7.15	1.00 V	288	9.26	37.59
3	5150.00	57.01 PK	74.00	-16.99	1.39 V	360	17.26	39.75
4	5150.00	43.06 AV	54.00	-10.94	1.39 V	360	3.31	39.75
5	*5180.00	106.06 PK			1.36 V	360	66.31	39.75
6	*5180.00	95.72 AV			1.36 V	360	55.97	39.75
7	#10360.00	67.14 PK	68.30	-1.16	1.11 V	192	16.49	50.65

- REMARKS:**
1. Emission level (dBuV/m) = Raw Value (dBuV) + Correction Factor (dB/m).
 2. Correction Factor (dB/m) = Antenna Factor (dB/m) + Cable Factor (dB).
 3. The other emission levels were very low against the limit.
 4. Margin value = Emission level – Limit value.
 5. “ * “: Fundamental frequency.
 6. “#”:The radiated frequency is out the restricted band.



A D T

EUT TEST CONDITION		MEASUREMENT DETAIL	
CHANNEL	Channel 40	FREQUENCY RANGE	1 ~ 40GHz
INPUT POWER (SYSTEM)	120Vac, 60 Hz	DETECTOR FUNCTION	Peak (PK) Average (AV)
ENVIRONMENTAL CONDITIONS	24deg. C, 64%RH 1000hPa	TESTED BY	Match Tsui

ANTENNA POLARITY & TEST DISTANCE: HORIZONTAL AT 3 M								
NO.	FREQ. (MHz)	EMISSION LEVEL (dBuV/m)	LIMIT (dBuV/m)	MARGIN (dB)	ANTENNA HEIGHT (m)	TABLE ANGLE (Degree)	RAW VALUE (dBuV)	CORRECTION FACTOR (dB/m)
1	4160.00	55.42 PK	74.00	-18.58	1.00 H	279	17.82	37.60
2	4160.00	49.73 AV	54.00	-4.27	1.00 H	279	12.13	37.60
3	*5200.00	107.97 PK			1.00 H	197	68.22	39.75
4	*5200.00	98.01 AV			1.00 H	197	58.26	39.75
5	#10400.00	61.43 PK	68.30	-6.87	1.18 H	159	10.68	50.75
ANTENNA POLARITY & TEST DISTANCE: VERTICAL AT 3 M								
NO.	FREQ. (MHz)	EMISSION LEVEL (dBuV/m)	LIMIT (dBuV/m)	MARGIN (dB)	ANTENNA HEIGHT (m)	TABLE ANGLE (Degree)	RAW VALUE (dBuV)	CORRECTION FACTOR (dB/m)
1	4160.00	52.90 PK	74.00	-21.10	1.08 V	360	15.30	37.60
2	4160.00	48.32 AV	54.00	-5.68	1.08 V	360	10.72	37.60
3	*5200.00	107.16 PK			1.36 V	4	67.41	39.75
4	*5200.00	97.32 AV			1.36 V	4	57.57	39.75
5	#10400.00	67.02 PK	68.30	-1.28	1.23 V	199	16.27	50.75

- REMARKS:**
1. Emission level (dBuV/m) = Raw Value (dBuV) + Correction Factor (dB/m).
 2. Correction Factor (dB/m) = Antenna Factor (dB/m) + Cable Factor (dB).
 3. The other emission levels were very low against the limit.
 4. Margin value = Emission level – Limit value.
 5. “ * “: Fundamental frequency.
 6. “#”:The radiated frequency is out the restricted band.



A D T

EUT TEST CONDITION		MEASUREMENT DETAIL	
CHANNEL	Channel 48	FREQUENCY RANGE	1 ~ 40GHz
INPUT POWER (SYSTEM)	120Vac, 60 Hz	DETECTOR FUNCTION	Peak (PK) Average (AV)
ENVIRONMENTAL CONDITIONS	24deg. C, 64%RH 1000hPa	TESTED BY	Match Tsui

ANTENNA POLARITY & TEST DISTANCE: HORIZONTAL AT 3 M								
NO.	FREQ. (MHz)	EMISSION LEVEL (dBuV/m)	LIMIT (dBuV/m)	MARGIN (dB)	ANTENNA HEIGHT (m)	TABLE ANGLE (Degree)	RAW VALUE (dBuV)	CORRECTION FACTOR (dB/m)
1	4192.00	53.44 PK	74.00	-20.56	1.00 H	270	15.82	37.62
2	4192.00	49.15 AV	54.00	-4.85	1.00 H	270	11.53	37.62
3	*5240.00	107.12 PK			1.00 H	162	67.28	39.84
4	*5240.00	97.32 AV			1.00 H	162	57.48	39.84
5	5350.00	49.79 PK	74.00	-24.21	1.00 H	162	9.74	40.05
6	5350.00	36.55 AV	54.00	-17.45	1.00 H	162	-3.49	40.05
7	#10480.00	60.54 PK	68.30	-7.76	1.39 H	159	9.66	50.88
ANTENNA POLARITY & TEST DISTANCE: VERTICAL AT 3 M								
NO.	FREQ. (MHz)	EMISSION LEVEL (dBuV/m)	LIMIT (dBuV/m)	MARGIN (dB)	ANTENNA HEIGHT (m)	TABLE ANGLE (Degree)	RAW VALUE (dBuV)	CORRECTION FACTOR (dB/m)
1	4192.00	52.09 PK	74.00	-21.91	1.03 V	352	14.47	37.62
2	4192.00	48.49 AV	54.00	-5.51	1.03 V	352	10.87	37.62
3	*5240.00	106.01 PK			1.46 V	360	66.17	39.84
4	*5240.00	95.91 AV			1.46 V	360	56.07	39.84
5	5350.00	49.00 PK	74.00	-25.00	1.46 V	360	8.95	40.05
6	5350.00	36.55 AV	54.00	-17.45	1.46 V	360	-3.49	40.05
7	#10480.00	67.02 PK	68.30	-1.28	1.54 V	196	16.14	50.88

- REMARKS:**
1. Emission level (dBuV/m) = Raw Value (dBuV) + Correction Factor (dB/m).
 2. Correction Factor (dB/m) = Antenna Factor (dB/m) + Cable Factor (dB).
 3. The other emission levels were very low against the limit.
 4. Margin value = Emission level – Limit value.
 5. “ * “: Fundamental frequency.
 6. "#":The radiated frequency is out the restricted band.



A D T

DRAFT 802.11n (20MHz) OFDM MODULATION

EUT TEST CONDITION		MEASUREMENT DETAIL	
CHANNEL	Channel 36	FREQUENCY RANGE	1 ~ 40GHz
INPUT POWER (SYSTEM)	120Vac, 60 Hz	DETECTOR FUNCTION	Peak (PK) Average (AV)
ENVIRONMENTAL CONDITIONS	24deg. C, 64%RH 1000hPa	TESTED BY	Match Tsui

ANTENNA POLARITY & TEST DISTANCE: HORIZONTAL AT 3 M								
NO.	FREQ. (MHz)	EMISSION LEVEL (dBuV/m)	LIMIT (dBuV/m)	MARGIN (dB)	ANTENNA HEIGHT (m)	TABLE ANGLE (Degree)	RAW VALUE (dBuV)	CORRECTION FACTOR (dB/m)
1	4144.00	47.39 PK	74.00	-26.61	1.26 H	0	9.80	37.59
2	4144.00	41.23 AV	54.00	-12.77	1.26 H	0	3.64	37.59
3	5150.00	53.90 PK	74.00	-20.10	1.17 H	6	14.15	39.75
4	5150.00	41.21 AV	54.00	-12.79	1.17 H	6	1.46	39.75
5	*5180.00	106.20 PK			1.17 H	6	66.45	39.75
6	*5180.00	96.36 AV			1.17 H	6	56.61	39.75
7	#10360.00	61.52 PK	68.30	-6.78	1.32 H	334	10.87	50.65
ANTENNA POLARITY & TEST DISTANCE: VERTICAL AT 3 M								
NO.	FREQ. (MHz)	EMISSION LEVEL (dBuV/m)	LIMIT (dBuV/m)	MARGIN (dB)	ANTENNA HEIGHT (m)	TABLE ANGLE (Degree)	RAW VALUE (dBuV)	CORRECTION FACTOR (dB/m)
1	4144.00	49.78 PK	74.00	-24.22	1.29 V	360	12.19	37.59
2	4144.00	44.81 AV	54.00	-9.19	1.29 V	360	7.22	37.59
3	5150.00	53.93 PK	74.00	-20.07	1.16 V	360	14.18	39.75
4	5150.00	40.94 AV	54.00	-13.06	1.16 V	360	1.19	39.75
5	*5180.00	105.80 PK			1.16 V	360	66.05	39.75
6	*5180.00	95.76 AV			1.16 V	360	56.01	39.75
7	#10360.00	67.03 PK	68.30	-1.27	1.34 V	17	16.38	50.65

- REMARKS:**
1. Emission level (dBuV/m) = Raw Value (dBuV) + Correction Factor (dB/m).
 2. Correction Factor (dB/m) = Antenna Factor (dB/m) + Cable Factor (dB).
 3. The other emission levels were very low against the limit.
 4. Margin value = Emission level – Limit value.
 5. “ * “: Fundamental frequency.
 6. “#”:The radiated frequency is out the restricted band.

EUT TEST CONDITION		MEASUREMENT DETAIL	
CHANNEL	Channel 40	FREQUENCY RANGE	1 ~ 40GHz
INPUT POWER (SYSTEM)	120Vac, 60 Hz	DETECTOR FUNCTION	Peak (PK) Average (AV)
ENVIRONMENTAL CONDITIONS	24deg. C, 64%RH 1000hPa	TESTED BY	Match Tsui

ANTENNA POLARITY & TEST DISTANCE: HORIZONTAL AT 3 M								
NO.	FREQ. (MHz)	EMISSION LEVEL (dBuV/m)	LIMIT (dBuV/m)	MARGIN (dB)	ANTENNA HEIGHT (m)	TABLE ANGLE (Degree)	RAW VALUE (dBuV)	CORRECTION FACTOR (dB/m)
1	4160.00	48.74 PK	74.00	-25.26	1.18 H	47	11.14	37.60
2	4160.00	41.66 AV	54.00	-12.34	1.18 H	47	4.06	37.60
3	*5200.00	107.05 PK			1.09 H	6	67.30	39.75
4	*5200.00	96.65 AV			1.09 H	6	56.90	39.75
5	#10400.00	59.55 PK	68.30	-8.75	1.15 H	346	8.80	50.75
ANTENNA POLARITY & TEST DISTANCE: VERTICAL AT 3 M								
NO.	FREQ. (MHz)	EMISSION LEVEL (dBuV/m)	LIMIT (dBuV/m)	MARGIN (dB)	ANTENNA HEIGHT (m)	TABLE ANGLE (Degree)	RAW VALUE (dBuV)	CORRECTION FACTOR (dB/m)
1	4160.00	49.68 PK	74.00	-24.32	1.35 V	21	12.08	37.60
2	4160.00	44.48 AV	54.00	-9.52	1.35 V	21	6.88	37.60
3	*5200.00	105.60 PK			1.15 V	360	65.85	39.75
4	*5200.00	95.00 AV			1.15 V	360	55.25	39.75
5	#10400.00	66.87 PK	68.30	-1.43	1.34 V	14	16.12	50.75

- REMARKS:**
1. Emission level (dBuV/m) = Raw Value (dBuV) + Correction Factor (dB/m).
 2. Correction Factor (dB/m) = Antenna Factor (dB/m) + Cable Factor (dB).
 3. The other emission levels were very low against the limit.
 4. Margin value = Emission level – Limit value.
 5. “ * “: Fundamental frequency.
 6. “#”:The radiated frequency is out the restricted band.



A D T

EUT TEST CONDITION		MEASUREMENT DETAIL	
CHANNEL	Channel 48	FREQUENCY RANGE	1 ~ 40GHz
INPUT POWER (SYSTEM)	120Vac, 60 Hz	DETECTOR FUNCTION	Peak (PK) Average (AV)
ENVIRONMENTAL CONDITIONS	24deg. C, 64%RH 1000hPa	TESTED BY	Match Tsui

ANTENNA POLARITY & TEST DISTANCE: HORIZONTAL AT 3 M								
NO.	FREQ. (MHz)	EMISSION LEVEL (dBuV/m)	LIMIT (dBuV/m)	MARGIN (dB)	ANTENNA HEIGHT (m)	TABLE ANGLE (Degree)	RAW VALUE (dBuV)	CORRECTION FACTOR (dB/m)
1	4192.00	48.14 PK	74.00	-25.86	1.22 H	32	10.52	37.62
2	4192.00	40.83 AV	54.00	-13.17	1.22 H	32	3.21	37.62
3	*5240.00	107.51 PK			1.06 H	360	67.67	39.84
4	*5240.00	97.33 AV			1.06 H	360	57.49	39.84
5	5350.00	50.12 PK	74.00	-23.87	1.14 H	360	10.08	40.05
6	5350.00	36.26 AV	54.00	-17.74	1.14 H	360	-3.79	40.05
7	#10480.00	58.63 PK	68.30	-9.67	1.00 H	238	7.75	50.88
ANTENNA POLARITY & TEST DISTANCE: VERTICAL AT 3 M								
NO.	FREQ. (MHz)	EMISSION LEVEL (dBuV/m)	LIMIT (dBuV/m)	MARGIN (dB)	ANTENNA HEIGHT (m)	TABLE ANGLE (Degree)	RAW VALUE (dBuV)	CORRECTION FACTOR (dB/m)
1	4192.00	48.90 PK	74.00	-25.10	1.28 V	0	11.28	37.62
2	4192.00	42.28 AV	54.00	-11.72	1.28 V	0	4.66	37.62
3	*5240.00	105.71 PK			1.00 V	360	65.87	39.84
4	*5240.00	95.15 AV			1.00 V	360	55.31	39.84
5	5350.00	50.67 PK	74.00	-23.33	1.14 V	360	10.62	40.05
6	5350.00	37.26 AV	54.00	-16.74	1.14 V	360	-2.79	40.05
7	#10480.00	66.15 PK	68.30	-2.15	1.41 V	360	15.27	50.88

- REMARKS:**
1. Emission level (dBuV/m) = Raw Value (dBuV) + Correction Factor (dB/m).
 2. Correction Factor (dB/m) = Antenna Factor (dB/m) + Cable Factor (dB).
 3. The other emission levels were very low against the limit.
 4. Margin value = Emission level – Limit value.
 5. “ * “: Fundamental frequency.
 6. “#”:The radiated frequency is out the restricted band.



A D T

DRAFT 802.11n (40MHz) OFDM MODULATION

EUT TEST CONDITION		MEASUREMENT DETAIL	
CHANNEL	Channel 38	FREQUENCY RANGE	1 ~ 40GHz
INPUT POWER (SYSTEM)	120Vac, 60 Hz	DETECTOR FUNCTION	Peak (PK) Average (AV)
ENVIRONMENTAL CONDITIONS	24deg. C, 64%RH 1000hPa	TESTED BY	Match Tsui

ANTENNA POLARITY & TEST DISTANCE: HORIZONTAL AT 3 M								
NO.	FREQ. (MHz)	EMISSION LEVEL (dBuV/m)	LIMIT (dBuV/m)	MARGIN (dB)	ANTENNA HEIGHT (m)	TABLE ANGLE (Degree)	RAW VALUE (dBuV)	CORRECTION FACTOR (dB/m)
1	4152.00	50.12 PK	74.00	-23.88	1.22 H	337	12.53	37.59
2	4152.00	44.40 AV	54.00	-9.60	1.22 H	337	6.81	37.59
3	5150.00	58.94 PK	74.00	-15.06	1.00 H	15	19.19	39.75
4	5150.00	43.46 AV	54.00	-10.54	1.00 H	15	3.71	39.75
5	*5190.00	102.04 PK			1.00 H	4	62.29	39.75
6	*5190.00	91.78 AV			1.00 H	4	52.03	39.75
7	#6228.00	56.81 PK	68.30	-11.49	1.03 H	76	14.81	42.00
8	#10380.00	58.84 PK	68.30	-9.46	1.01 H	345	8.14	50.70
ANTENNA POLARITY & TEST DISTANCE: VERTICAL AT 3 M								
NO.	FREQ. (MHz)	EMISSION LEVEL (dBuV/m)	LIMIT (dBuV/m)	MARGIN (dB)	ANTENNA HEIGHT (m)	TABLE ANGLE (Degree)	RAW VALUE (dBuV)	CORRECTION FACTOR (dB/m)
1	4152.00	49.29 PK	74.00	-24.71	1.56 V	6	11.70	37.59
2	4152.00	42.91 AV	54.00	-11.09	1.56 V	6	5.32	37.59
3	5150.00	57.22 PK	74.00	-16.78	1.05 V	186	17.47	39.75
4	5150.00	39.84 AV	54.00	-14.16	1.05 V	186	0.09	39.75
5	*5190.00	100.65 PK			1.05 V	18	60.90	39.75
6	*5190.00	90.34 AV			1.05 V	18	50.59	39.75
7	#6228.00	52.45 PK	68.30	-15.85	1.49 V	32	10.45	42.00
8	#10380.00	65.27 PK	68.30	-3.03	1.56 V	360	14.57	50.70

- REMARKS:**
1. Emission level (dBuV/m) = Raw Value (dBuV) + Correction Factor (dB/m).
 2. Correction Factor (dB/m) = Antenna Factor (dB/m) + Cable Factor (dB).
 3. The other emission levels were very low against the limit.
 4. Margin value = Emission level – Limit value.
 5. “ * “: Fundamental frequency.
 6. “#“: The radiated frequency is out the restricted band.



A D T

EUT TEST CONDITION		MEASUREMENT DETAIL	
CHANNEL	Channel 46	FREQUENCY RANGE	1 ~ 40GHz
INPUT POWER (SYSTEM)	120Vac, 60 Hz	DETECTOR FUNCTION	Peak (PK) Average (AV)
ENVIRONMENTAL CONDITIONS	24deg. C, 64%RH 1000hPa	TESTED BY	Match Tsui

ANTENNA POLARITY & TEST DISTANCE: HORIZONTAL AT 3 M								
NO.	FREQ. (MHz)	EMISSION LEVEL (dBuV/m)	LIMIT (dBuV/m)	MARGIN (dB)	ANTENNA HEIGHT (m)	TABLE ANGLE (Degree)	RAW VALUE (dBuV)	CORRECTION FACTOR (dB/m)
1	4184.00	49.04 PK	74.00	-24.96	1.05 H	349	11.42	37.62
2	4184.00	43.59 AV	54.00	-10.41	1.05 H	349	5.97	37.62
3	*5230.00	103.49 PK			1.17 H	360	63.67	39.82
4	*5230.00	93.21 AV			1.17 H	360	53.39	39.82
5	5350.00	48.66 PK	74.00	-25.34	1.17 H	360	8.61	40.05
6	5350.00	36.29 AV	54.00	-17.71	1.17 H	360	-3.76	40.05
7	#10460.00	58.56 PK	68.30	-9.74	1.00 H	176	7.71	50.85
ANTENNA POLARITY & TEST DISTANCE: VERTICAL AT 3 M								
NO.	FREQ. (MHz)	EMISSION LEVEL (dBuV/m)	LIMIT (dBuV/m)	MARGIN (dB)	ANTENNA HEIGHT (m)	TABLE ANGLE (Degree)	RAW VALUE (dBuV)	CORRECTION FACTOR (dB/m)
1	4184.00	49.41 PK	74.00	-24.59	1.20 V	188	11.79	37.62
2	4184.00	43.68 AV	54.00	-10.32	1.20 V	188	6.06	37.62
3	*5230.00	101.03 PK			1.05 V	187	61.21	39.82
4	*5230.00	90.64 AV			1.05 V	187	50.82	39.82
5	5350.00	49.78 PK	74.00	-24.22	1.05 V	187	9.73	40.05
6	5350.00	36.62 AV	54.00	-17.38	1.05 V	187	-3.43	40.05
7	#10460.00	62.46 PK	68.30	-5.84	1.42 V	16	11.61	50.85

- REMARKS:**
1. Emission level (dBuV/m) = Raw Value (dBuV) + Correction Factor (dB/m).
 2. Correction Factor (dB/m) = Antenna Factor (dB/m) + Cable Factor (dB).
 3. The other emission levels were very low against the limit.
 4. Margin value = Emission level – Limit value.
 5. “ * “: Fundamental frequency.
 6. “#“: The radiated frequency is out the restricted band.



A D T

BELOW 1GHz WORST-CASE DATA : 802.11a OFDM MODULATION

EUT TEST CONDITION		MEASUREMENT DETAIL	
CHANNEL	Channel 40	FREQUENCY RANGE	Below 1000MHz
INPUT POWER (SYSTEM)	120Vac, 60 Hz	DETECTOR FUNCTION	Quasi-Peak
ENVIRONMENTAL CONDITIONS	20deg. C, 70%RH 999hPa	TESTED BY	Lori Chiu

ANTENNA POLARITY & TEST DISTANCE: HORIZONTAL AT 3 M								
NO.	FREQ. (MHz)	EMISSION LEVEL (dBuV/m)	LIMIT (dBuV/m)	MARGIN (dB)	ANTENNA HEIGHT (m)	TABLE ANGLE (Degree)	RAW VALUE (dBuV)	CORRECTION FACTOR (dB/m)
1	360.43	31.04 QP	46.00	-14.96	1.00 H	10	15.95	15.10
2	479.03	33.55 QP	46.00	-12.45	2.00 H	265	14.95	18.60
3	599.58	38.93 QP	46.00	-7.07	1.25 H	265	17.03	21.90
4	720.12	38.39 QP	46.00	-7.61	1.25 H	34	15.17	23.22
5	799.84	34.47 QP	46.00	-11.53	1.00 H	247	9.16	25.32
6	840.67	39.49 QP	46.00	-6.51	1.00 H	10	13.92	25.57
ANTENNA POLARITY & TEST DISTANCE: VERTICAL AT 3 M								
NO.	FREQ. (MHz)	EMISSION LEVEL (dBuV/m)	LIMIT (dBuV/m)	MARGIN (dB)	ANTENNA HEIGHT (m)	TABLE ANGLE (Degree)	RAW VALUE (dBuV)	CORRECTION FACTOR (dB/m)
1	33.79	29.46 QP	40.00	-10.54	1.00 V	256	17.30	12.16
2	97.95	28.78 QP	43.50	-14.72	1.25 V	19	19.48	9.31
3	599.58	30.90 QP	46.00	-15.10	2.00 V	319	9.00	21.90
4	720.12	31.88 QP	46.00	-14.12	2.00 V	298	8.66	23.22
5	799.84	30.64 QP	46.00	-15.36	1.50 V	247	5.33	25.32
6	840.67	34.84 QP	46.00	-11.16	1.00 V	298	9.27	25.57
7	904.83	31.12 QP	46.00	-14.88	1.50 V	262	4.97	26.15
8	908.72	33.24 QP	46.00	-12.76	1.50 V	322	7.06	26.18
9	945.66	33.82 QP	46.00	-12.18	1.25 V	265	7.36	26.46

- REMARKS:**
1. Emission level (dBuV/m) = Raw Value (dBuV) + Correction Factor (dB/m).
 2. Correction Factor (dB/m) = Antenna Factor (dB/m) + Cable Factor (dB).
 3. The other emission levels were very low against the limit.
 4. Margin value = Emission level – Limit value.

4.2 CONDUCTED EMISSION MEASUREMENT

4.2.1 LIMITS OF CONDUCTED EMISSION MEASUREMENT

FREQUENCY OF EMISSION (MHz)	CONDUCTED LIMIT (dB μ V)	
	Quasi-peak	Average
0.15 ~ 0.5	66 to 56	56 to 46
0.5 ~ 5	56	46
5 ~ 30	60	50

- NOTE:**
1. The lower limit shall apply at the transition frequencies.
 2. The limit decreases in line with the logarithm of the frequency in the range of 0.15 to 0.50MHz.
 3. All emanations from a class A/B digital device or system, including any network of conductors and apparatus connected thereto, shall not exceed the level of field strengths specified above.

4.2.2 TEST INSTRUMENTS

DESCRIPTION & MANUFACTURER	MODEL NO.	SERIAL NO.	DATE OF CALIBRATION	DUE DATE OF CALIBRATION
Test Receiver ROHDE & SCHWARZ	ESCS30	100291	Nov. 19, 2008	Nov. 18, 2009
RF signal cable Woken	5D-FB	Cable-HYC01-01	Dec. 31, 2008	Dec. 30, 2009
LISN ROHDE & SCHWARZ	ESH3-Z5	100312	Jun. 13, 2008	Jun. 12, 2009
LISN ROHDE & SCHWARZ	ESH2-Z5	100104	Dec. 04, 2008	Dec. 03, 2009
Software ADT	ADT_Cond_ V7.3.6	NA	NA	NA

- NOTE:**
1. The calibration interval of the above test instruments is 12 months and the calibrations are traceable to NML/ROC and NIST/USA.
 2. The test was performed in HwaYa Shielded Room 1.
 3. The VCCI Site Registration No. is C-2040.

4.2.3 TEST PROCEDURES

- a. The EUT was placed 0.4 meters from the conducting wall of the shielded room with EUT being connected to the power mains through a line impedance stabilization network (LISN). Other support units were connected to the power mains through another LISN. The two LISNs provide 50 ohm/ 50uH of coupling impedance for the measuring instrument.
- b. Both lines of the power mains connected to the EUT were checked for maximum conducted interference.
- c. The frequency range from 150kHz to 30MHz was searched. Emission levels under (Limit - 20dB) was not recorded.

4.2.4 DEVIATION FROM TEST STANDARD

No deviation.

4.2.5 TEST SETUP

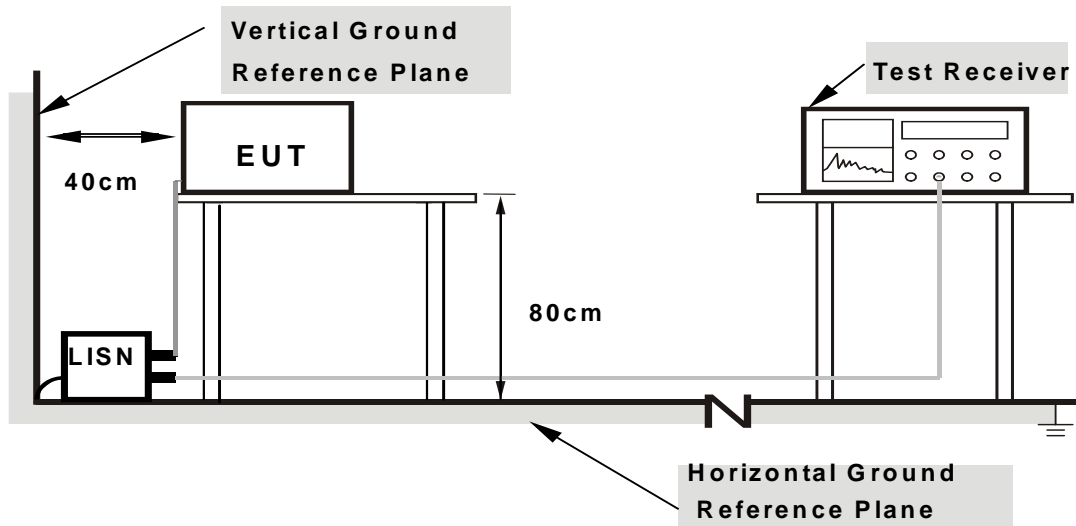

Note: 1.Support units were connected to second LISN.

2.Both of LISNs (AMN) are 80 cm from EUT and at least 80 from other units and other metal planes

For the actual test configuration, please refer to the attached file (Test Setup Photo).

4.2.6 EUT OPERATING CONDITIONS

Same as 4.1.6.

4.2.7 TEST RESULTS

CONDUCTED WORST-CASE DATA : 802.11a OFDM MODULATION

EUT TEST CONDITION		MEASUREMENT DETAIL	
CHANNEL	Channel 40	PHASE	Line 1
MODULATION TYPE	BPSK	INPUT POWER	120Vac, 60Hz
TRANSFER RATE	6Mbps	6dB BANDWIDTH	9kHz
ENVIRONMENTAL CONDITIONS	22deg. C, 65%RH, 1021hPa	TESTED BY	Antony Lee

No	Freq. [MHz]	Corr. Factor (dB)	Reading Value		Emission Level		Limit		Margin	
			[dB (uV)]		[dB (uV)]		[dB (uV)]		(dB)	
			Q.P.	AV.	Q.P.	AV.	Q.P.	AV.	Q.P.	AV.
1	0.172	0.13	49.94	-	50.07	-	64.86	54.86	-14.79	-
2	0.232	0.13	42.19	-	42.32	-	62.38	52.38	-20.06	-
3	0.287	0.13	39.33	-	39.46	-	60.62	50.62	-21.15	-
4	1.844	0.22	35.95	-	36.17	-	56.00	46.00	-19.83	-
5	3.684	0.37	39.18	-	39.55	-	56.00	46.00	-16.45	-
6	10.247	0.63	34.14	-	34.77	-	60.00	50.00	-25.23	-

- REMARKS:**
1. Q.P. and AV. are abbreviations of quasi-peak and average individually.
 2. "-": The Quasi-peak reading value also meets average limit and measurement with the average detector is unnecessary.
 3. The emission levels of other frequencies were very low against the limit.
 4. Margin value = Emission level - Limit value
 5. Correction factor = Insertion loss + Cable loss
 6. Emission Level = Correction Factor + Reading Value.

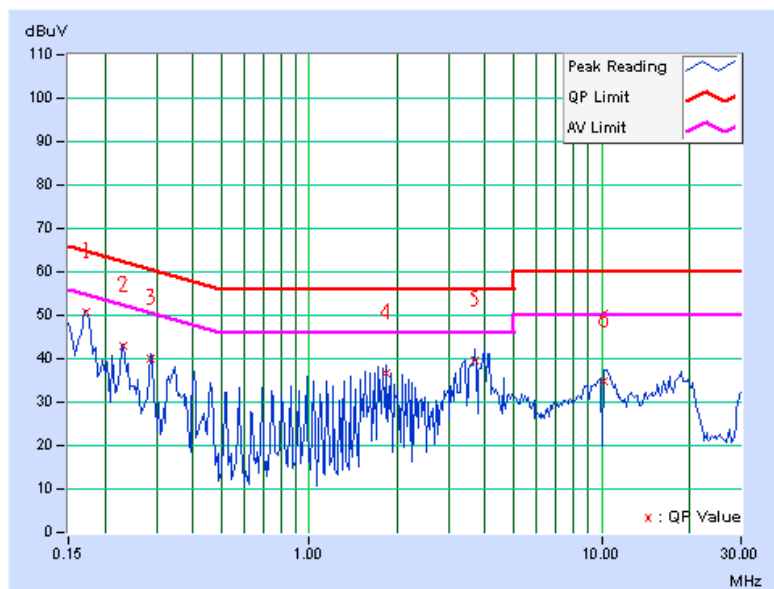



EUT TEST CONDITION		MEASUREMENT DETAIL	
CHANNEL	Channel 40	PHASE	Line 2
MODULATION TYPE	BPSK	INPUT POWER	120Vac, 60Hz
TRANSFER RATE	6Mbps	6dB BANDWIDTH	9kHz
ENVIRONMENTAL CONDITIONS	22deg. C, 65%RH, 1021hPa	TESTED BY	Antony Lee

No	Freq. [MHz]	Corr. Factor (dB)	Reading Value		Emission Level		Limit		Margin	
			[dB (uV)]		[dB (uV)]		[dB (uV)]		(dB)	
			Q.P.	AV.	Q.P.	AV.	Q.P.	AV.	Q.P.	AV.
1	0.173	0.14	50.54	-	50.68	-	64.79	54.79	-14.11	-
2	0.228	0.15	42.71	-	42.86	-	62.52	52.52	-19.66	-
3	0.287	0.15	37.69	-	37.84	-	60.62	50.62	-22.77	-
4	1.727	0.24	35.49	-	35.73	-	56.00	46.00	-20.27	-
5	3.855	0.41	38.88	-	39.29	-	56.00	46.00	-16.71	-
6	10.426	0.63	33.92	-	34.55	-	60.00	50.00	-25.45	-

- REMARKS:**
1. Q.P. and AV. are abbreviations of quasi-peak and average individually.
 2. "-": The Quasi-peak reading value also meets average limit and measurement with the average detector is unnecessary.
 3. The emission levels of other frequencies were very low against the limit.
 4. Margin value = Emission level - Limit value
 5. Correction factor = Insertion loss + Cable loss
 6. Emission Level = Correction Factor + Reading Value.

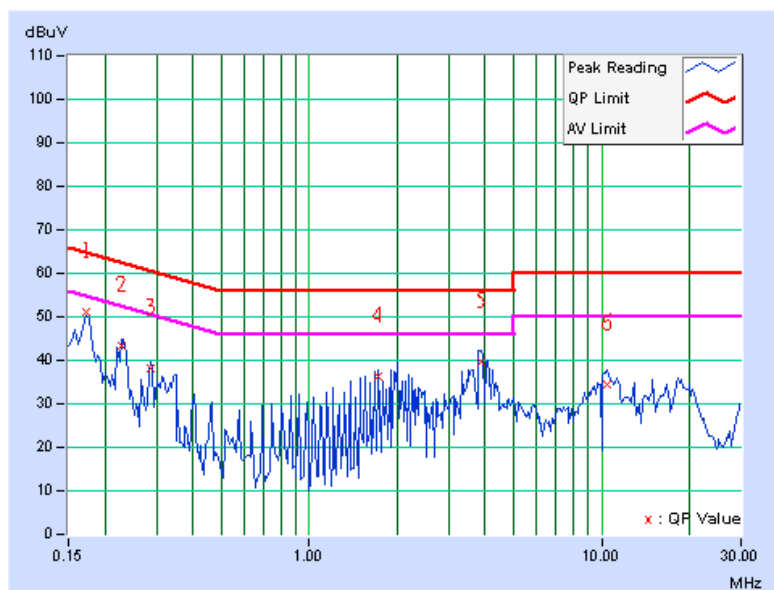

4.3 PEAK TRANSMIT POWER MEASUREMENT

4.3.1 LIMITS OF PEAK TRANSMIT POWER MEASUREMENT

FREQUENCY BAND	LIMIT
5.15 ~ 5.25GHz	The lesser of 50mW (17dBm) or 4dBm + 10logB

NOTE: Where B is the 26dB emission bandwidth in MHz.

4.3.2 TEST INSTRUMENTS

DESCRIPTION & MANUFACTURER	MODEL NO.	SERIAL NO.	DATE OF CALIBRATION	CALIBRATED UNTIL
High Speed Peak Power Meter	ML2495A	0824012	Aug. 04, 2008	Aug. 03, 2009
Power Sensor	MA2444B	0738138	Aug. 04, 2008	Aug. 03, 2009

NOTE:

1. The calibration interval of the above test instruments is 12 months and the calibrations are traceable to NML/ROC and NIST/USA.
2. Measurement Bandwidth of ML2495A is 65MHz greater than 26dB bandwidth of emission.

4.3.3 TEST PROCEDURE

A power sensor was used on the output port of the EUT. A power meter was used to read the response of the power sensor. Record the power level.

4.3.4 DEVIATION FROM TEST STANDARD

No deviation.

4.3.5 TEST SETUP

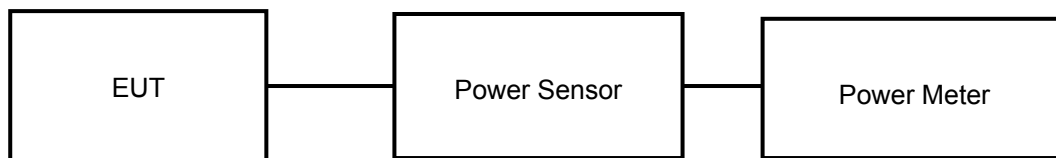

4.3.6 EUT OPERATING CONDITIONS

The software provided by client to enable the EUT under transmission condition continuously at specific channel frequencies individually.

4.3.7 TEST RESULTS

PEAK POWER OUTPUT: 802.11a OFDM MODULATION

MODULATION TYPE	BPSK	TRANSFER RATE	6.0Mbps
INPUT POWER	120Vac, 60Hz	ENVIRONMENTAL CONDITIONS	24 deg.C, 64 %RH, 1021hPa
TESTED BY	Match Tsui		

CHAN.	CHAN. FREQ. (MHz)	PEAK POWER OUTPUT (dBm)		TOTAL PEAK POWER (mW)	TOTAL PEAK POWER (dBm)	PEAK POWER LIMIT (dBm)	PASS / FAIL
		CHAIN 0	CHAIN 1				
36	5180	12.52	12.53	35.771	15.54	17	PASS
40	5200	12.54	12.71	36.611	15.64	17	PASS
48	5240	12.05	12.22	32.705	15.15	17	PASS

DRAFT 802.11n (20MHz) OFDM MODULATION

MODULATION TYPE	BPSK	TRANSFER RATE	7.2Mbps
INPUT POWER	120Vac, 60Hz	ENVIRONMENTAL CONDITIONS	24 deg.C, 64 %RH, 1021hPa
TESTED BY	Match Tsui		

CHAN.	CHAN. FREQ. (MHz)	PEAK POWER OUTPUT (dBm)		TOTAL PEAK POWER (mW)	TOTAL PEAK POWER (dBm)	PEAK POWER LIMIT (dBm)	PASS / FAIL
		CHAIN 0	CHAIN 1				
36	5180	12.53	12.54	35.853	15.55	17	PASS
40	5200	12.54	12.55	35.936	15.56	17	PASS
48	5240	12.32	12.73	35.811	15.54	17	PASS



A D T

DRAFT 802.11n (40MHz) OFDM MODULATION

MODULATION TYPE	BPSK	TRANSFER RATE	15.0Mbps
INPUT POWER	120Vac, 60Hz	ENVIRONMENTAL CONDITIONS	24 deg.C, 64 %RH, 1021hPa
TESTED BY	Match Tsui		

CHAN.	CHAN. FREQ. (MHz)	PEAK POWER OUTPUT (dBm)		TOTAL PEAK POWER (mW)	TOTAL PEAK POWER (dBm)	PEAK POWER LIMIT (dBm)	PASS / FAIL
		CHAIN 0	CHAIN 1				
38	5190	12.53	12.54	35.853	15.55	17	PASS
46	5230	12.51	12.61	36.063	15.57	17	PASS



A D T

26dB OCCUPIED BANDWIDTH: 802.11a OFDM MODULATION

MODULATION TYPE	BPSK	TRANSFER RATE	6.0Mbps
INPUT POWER	120Vac, 60Hz	ENVIRONMENTAL CONDITIONS	24 deg.C, 64 %RH, 1021hPa
TESTED BY	Match Tsui		

CHANNEL	CHANNEL FREQUENCY (MHz)	26dBc OCCUPIED BANDWIDTH (MHz)		PASS / FAIL
		CHAIN 0	CHAIN 1	
36	5180	20.63	20.51	PASS
40	5200	20.77	20.48	PASS
48	5240	20.81	20.64	PASS



A D T

FOR CHAIN 0: CH 36

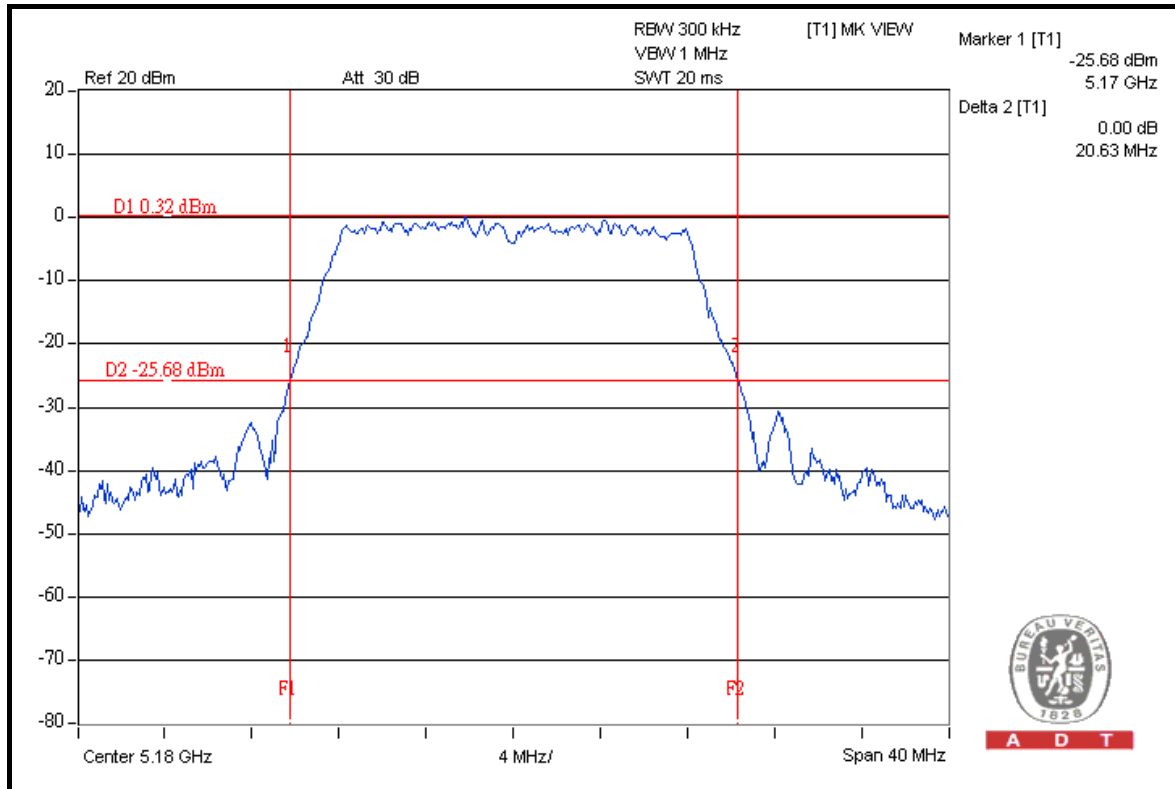

CH 40

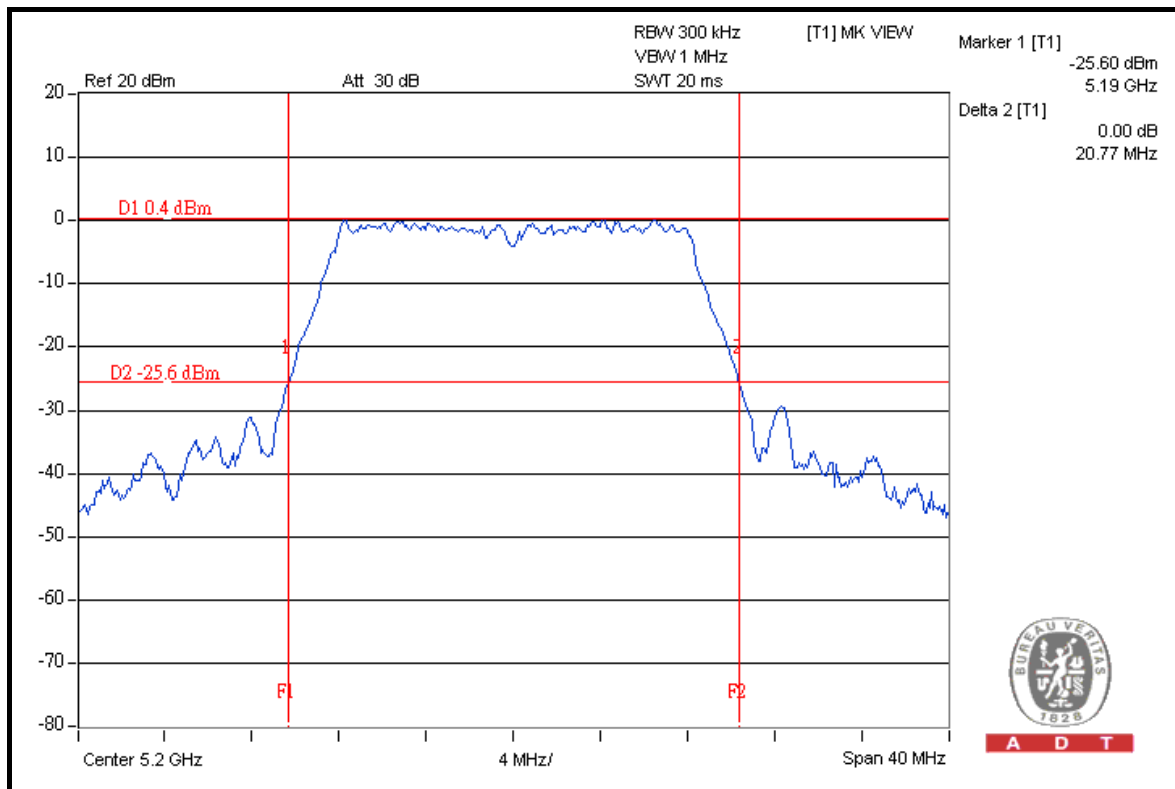



A D T

CH 48

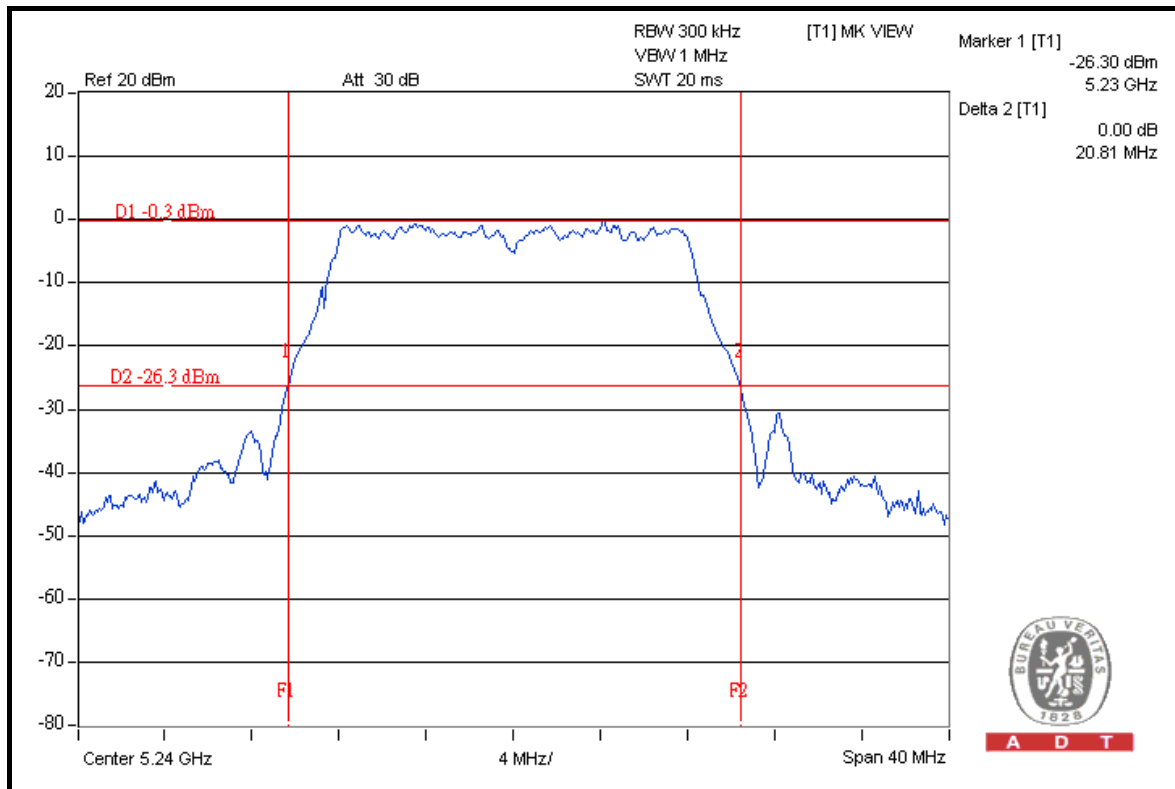

A D T

FOR CHAIN 1: CH 36

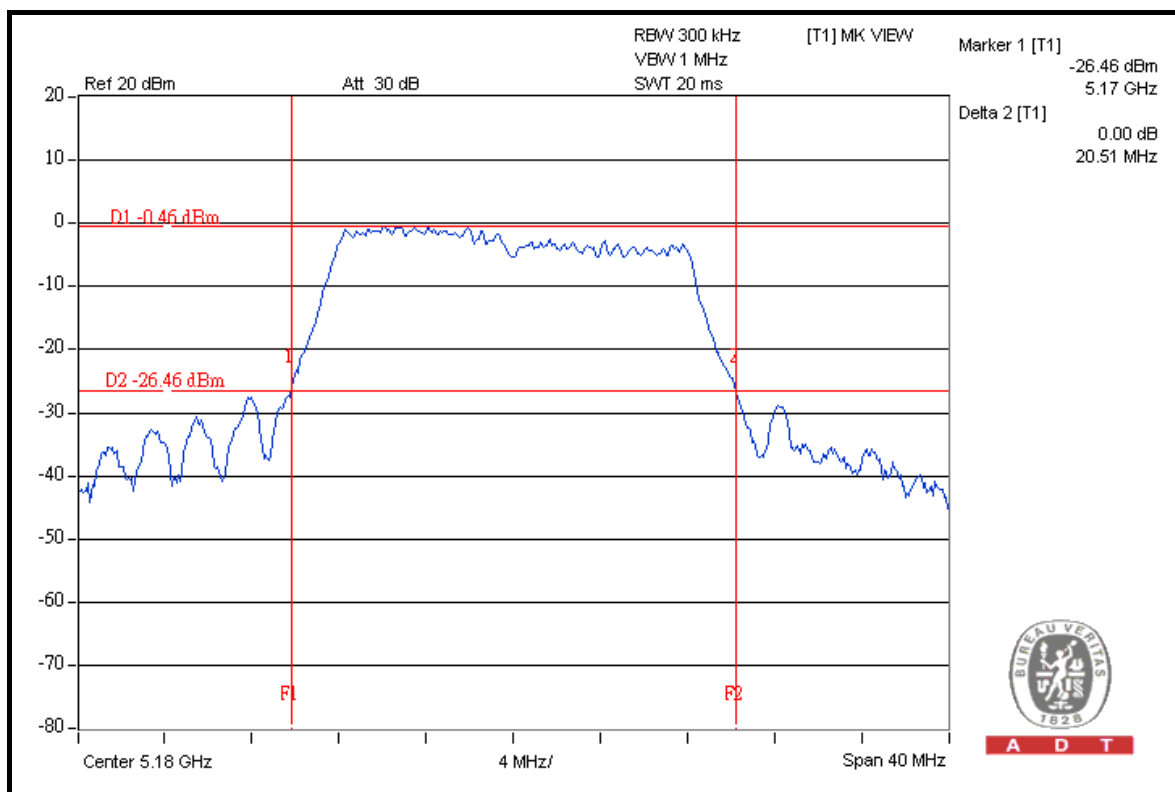

A D T

CH 40



A D T

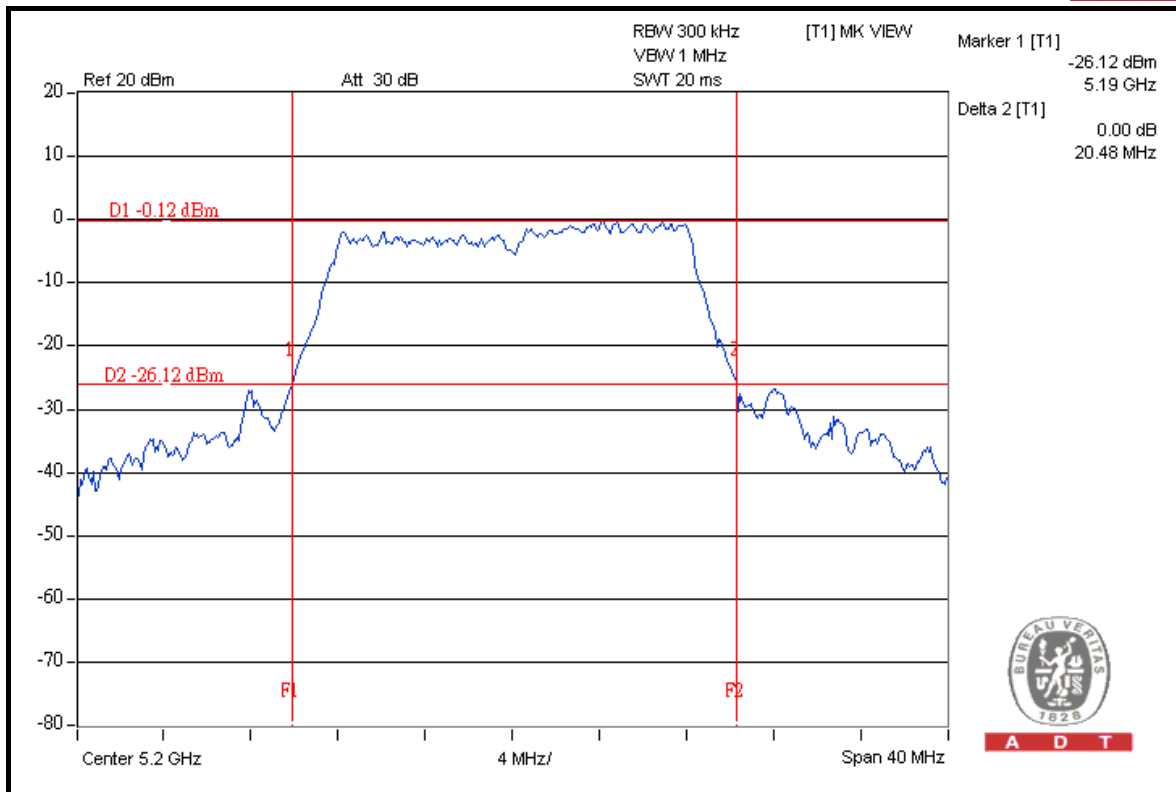

CH 48

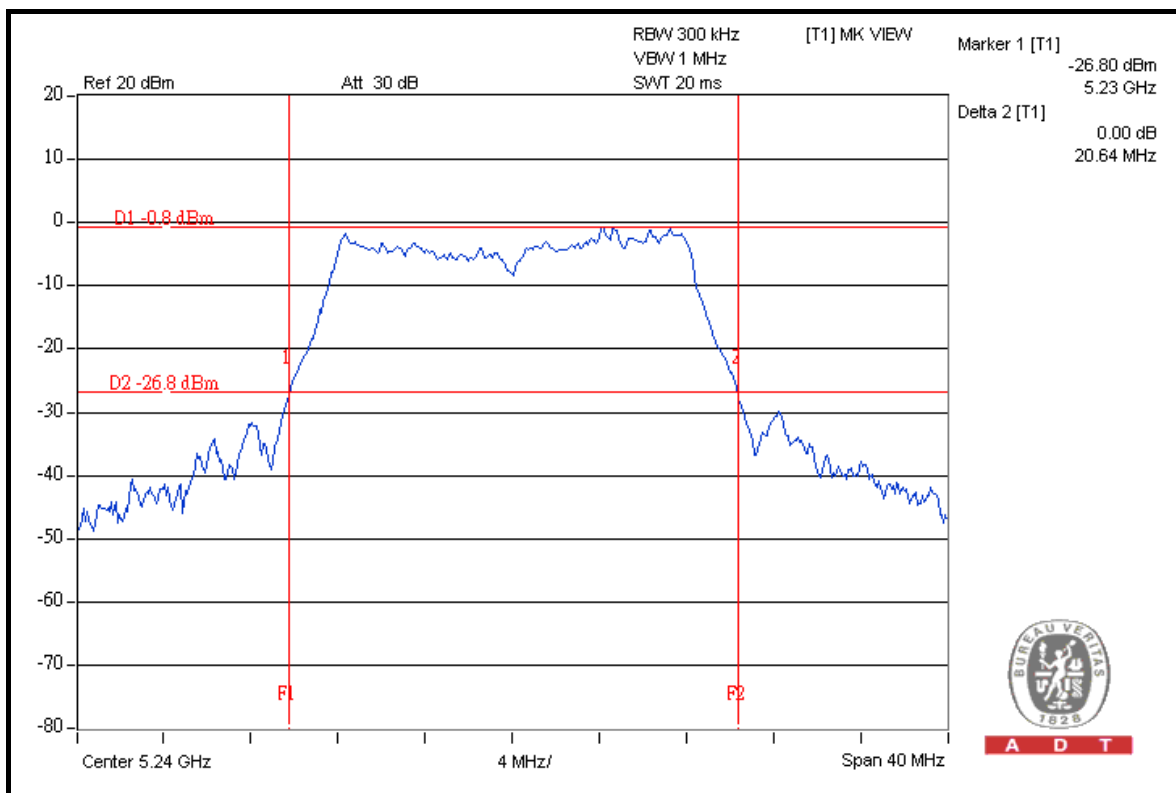



A D T

DRAFT 802.11n (20MHz) OFDM MODULATION

MODULATION TYPE	BPSK	TRANSFER RATE	7.2Mbps
INPUT POWER	120Vac, 60Hz	ENVIRONMENTAL CONDITIONS	24 deg.C, 64 %RH, 1021hPa
TESTED BY	Match Tsui		

CHANNEL	CHANNEL FREQUENCY (MHz)	26dBc OCCUPIED BANDWIDTH (MHz)		PASS / FAIL
		CHAIN 0	CHAIN 1	
36	5180	20.70	20.67	PASS
40	5200	20.78	20.55	PASS
48	5240	20.80	20.90	PASS



A D T

FOR CHAIN 0: CH 36

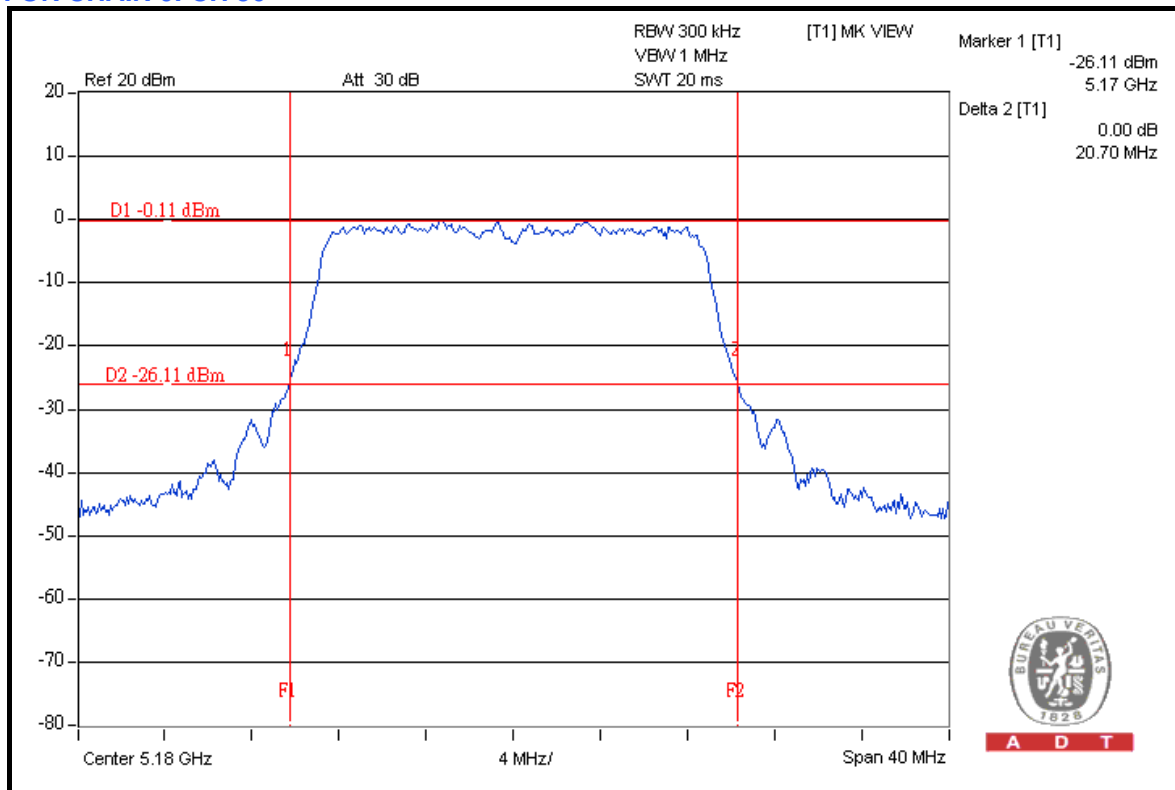

CH 40

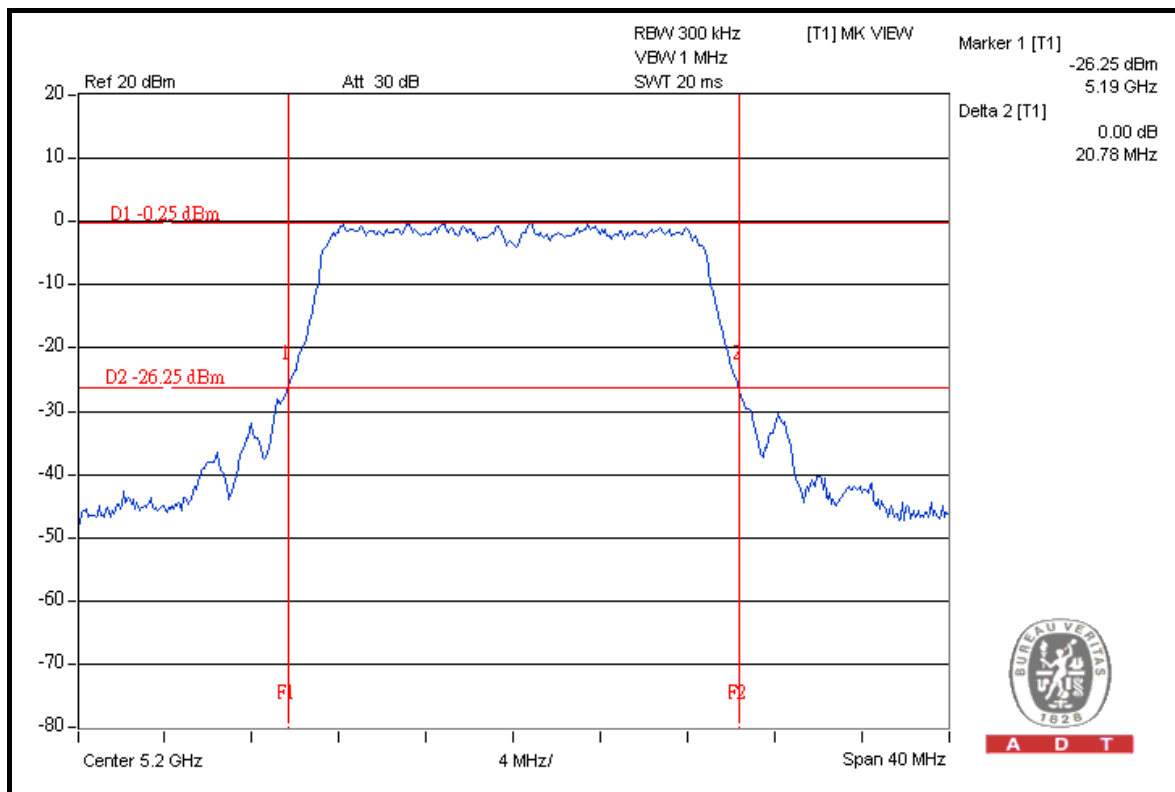



A D T

CH 48

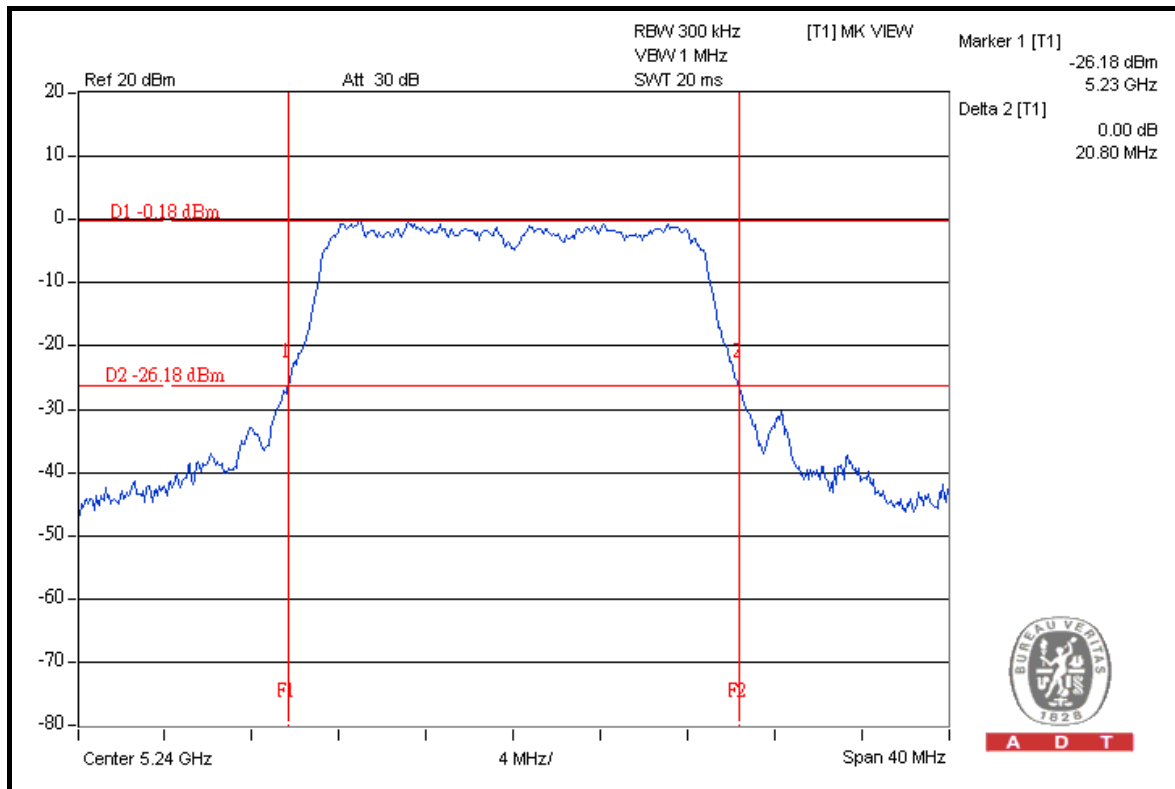

FOR CHAIN 1: CH 36

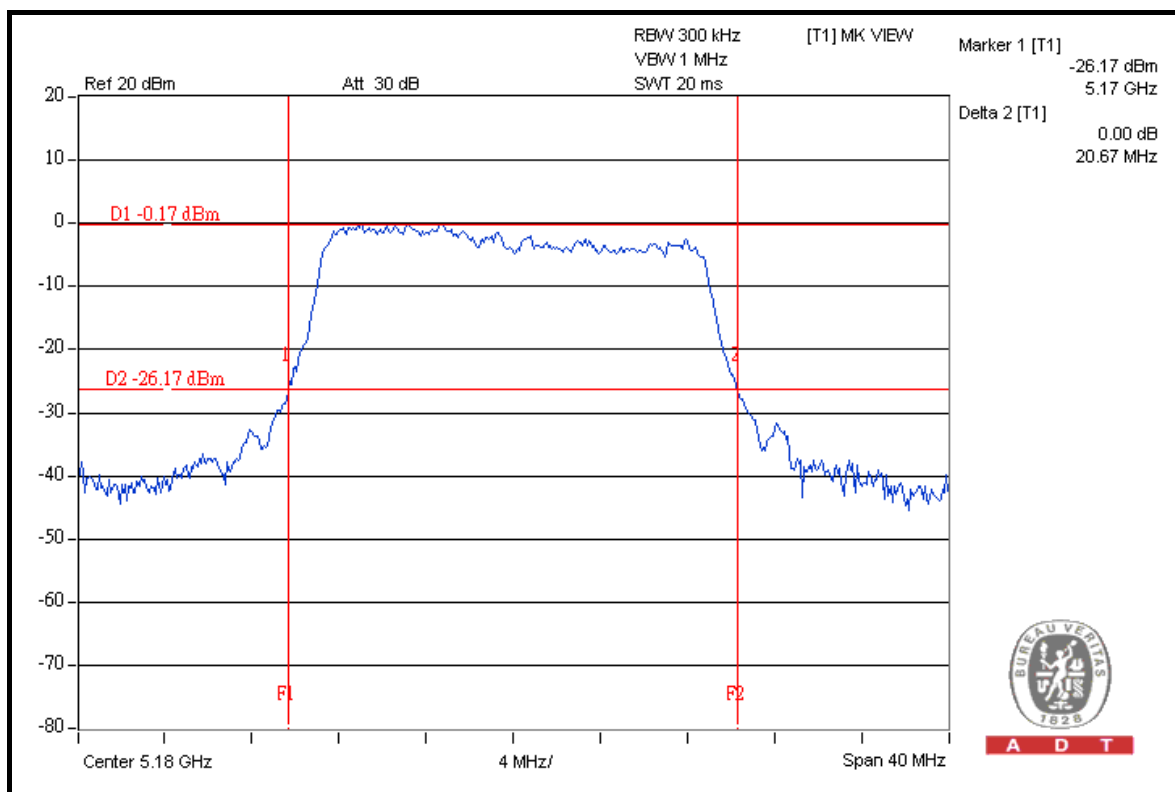

CH 40



A D T

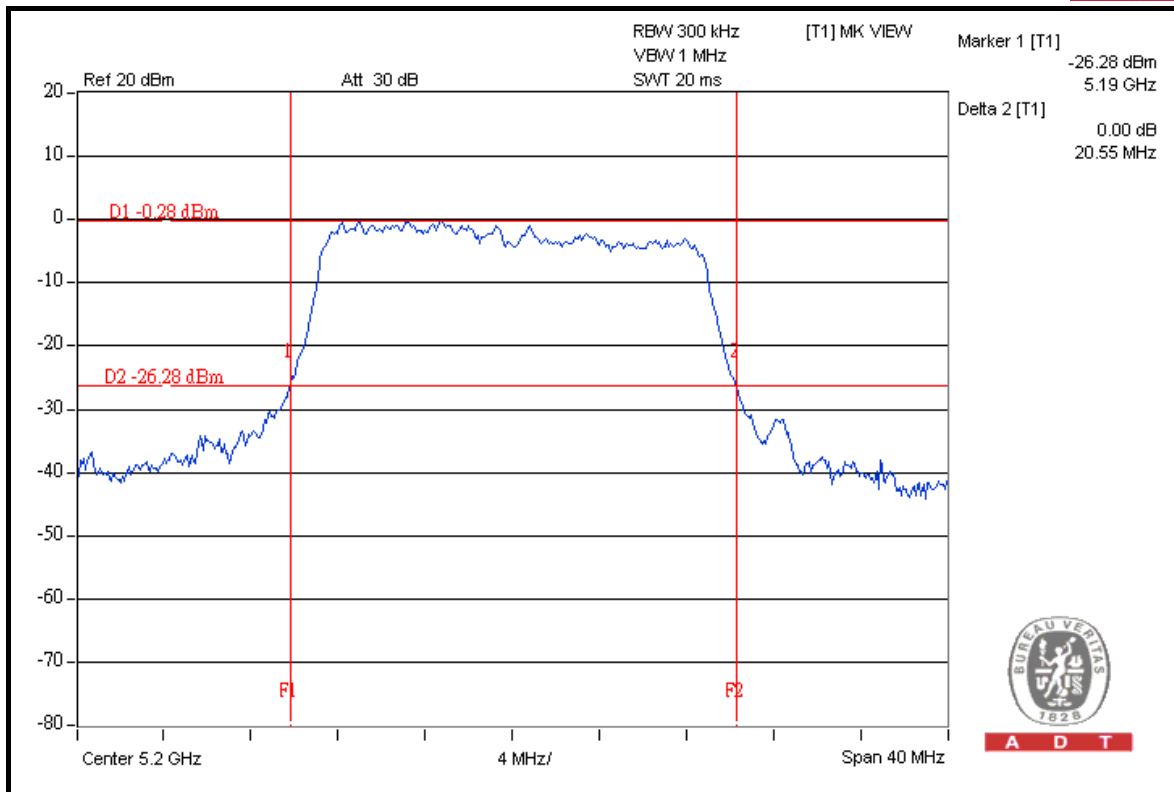

CH 48

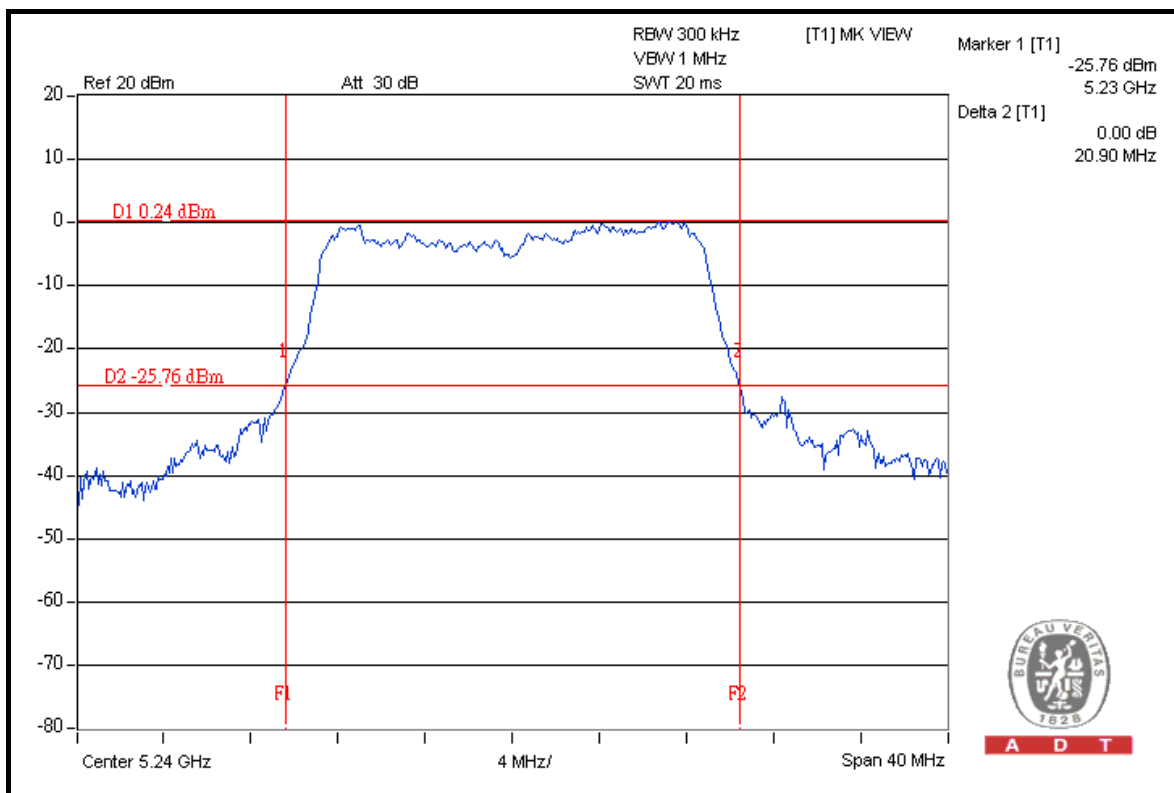

DRAFT 802.11n (40MHz) OFDM MODULATION



A D T

MODULATION TYPE	BPSK	TRANSFER RATE	15.0Mbps
INPUT POWER	120Vac, 60Hz	ENVIRONMENTAL CONDITIONS	24 deg.C, 64 %RH, 1021hPa
TESTED BY	Match Tsui		

CHANNEL	CHANNEL FREQUENCY (MHz)	26dBc OCCUPIED BANDWIDTH (MHz)		PASS / FAIL
		CHAIN 0	CHAIN 1	
38	5190	40.88	40.55	PASS
46	5230	41.02	41.18	PASS



A D T

FOR CHAIN 0: CH 38

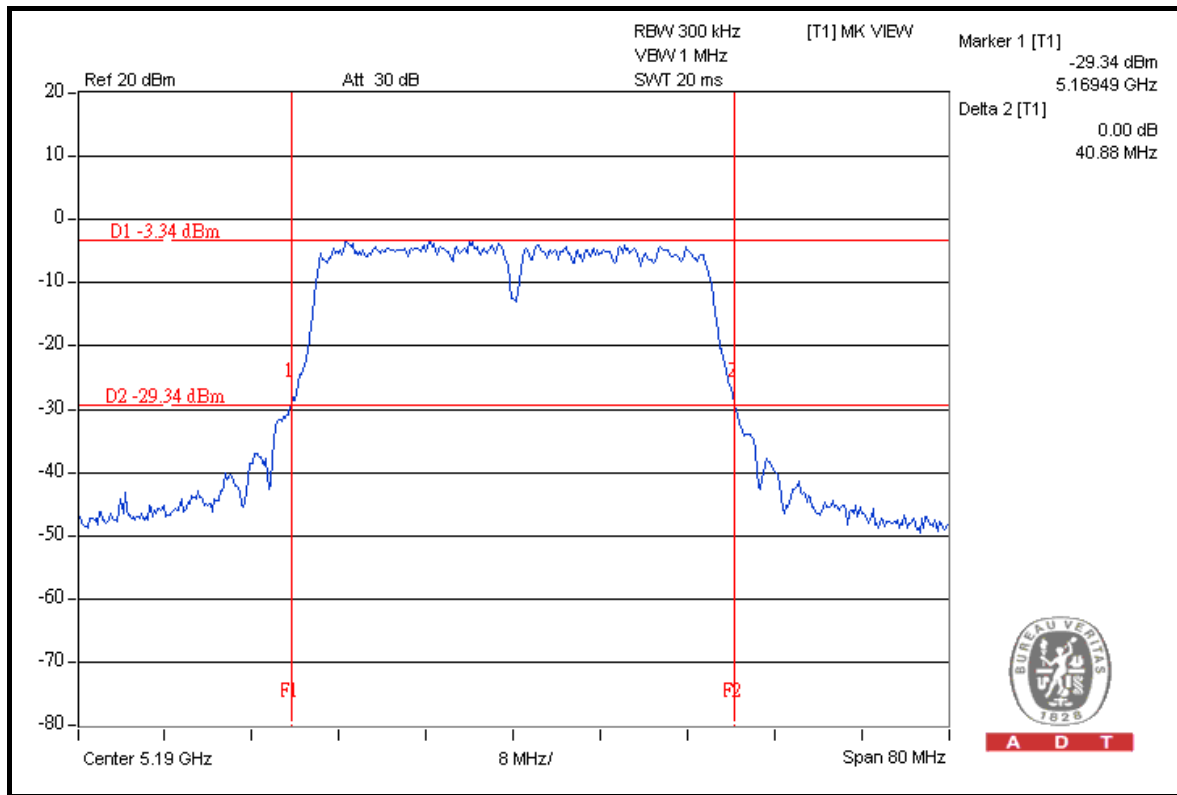

CH 46

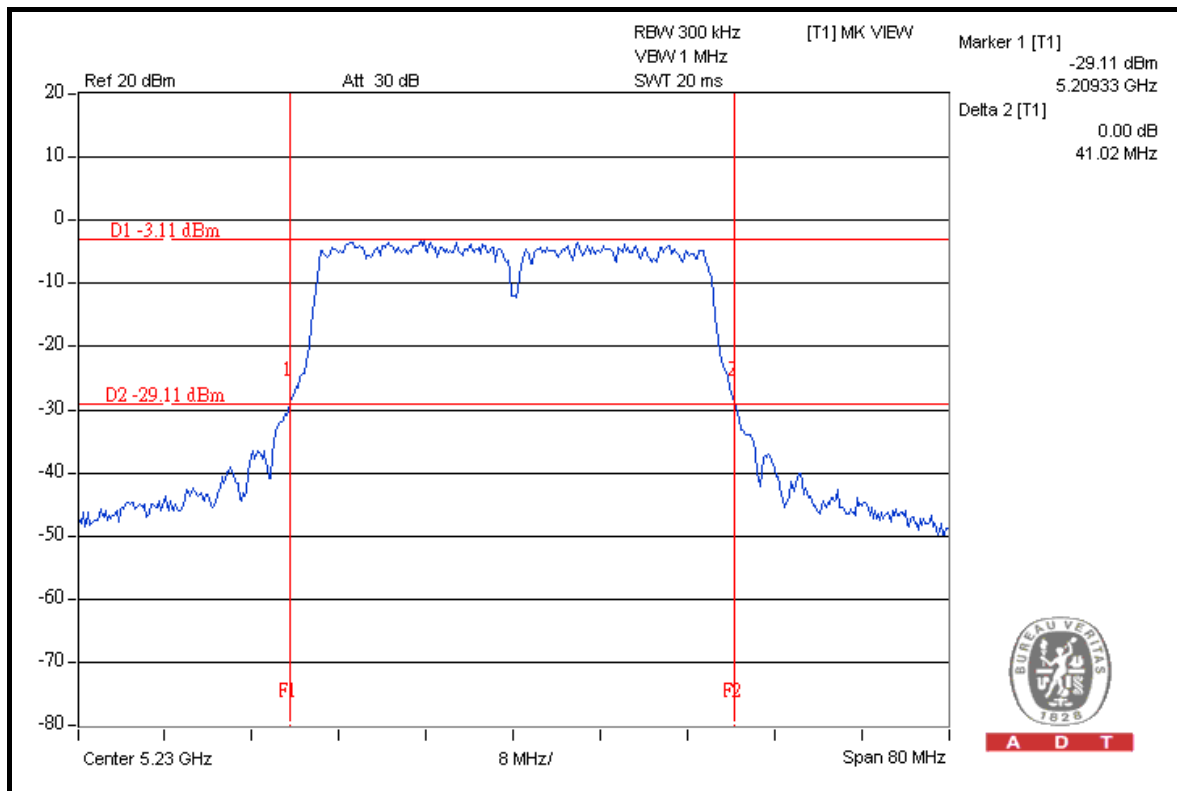



A D T

FOR CHAIN 1: CH 38

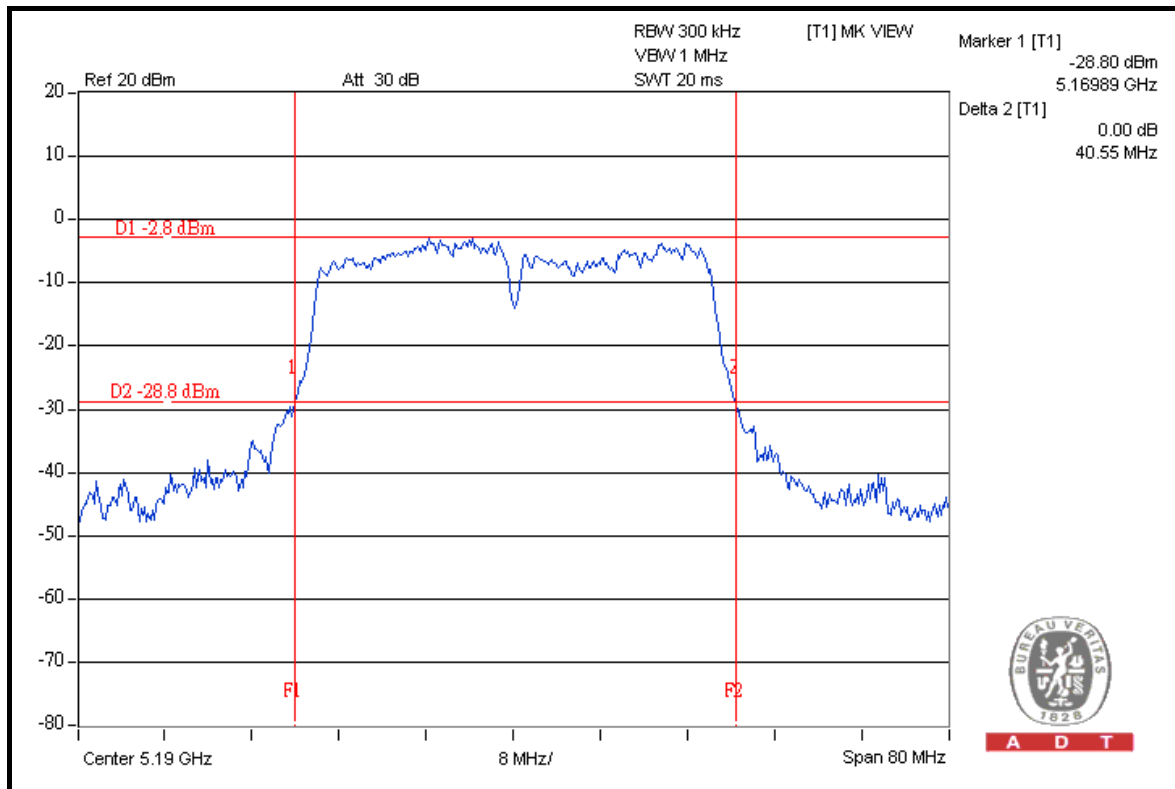

CH 46

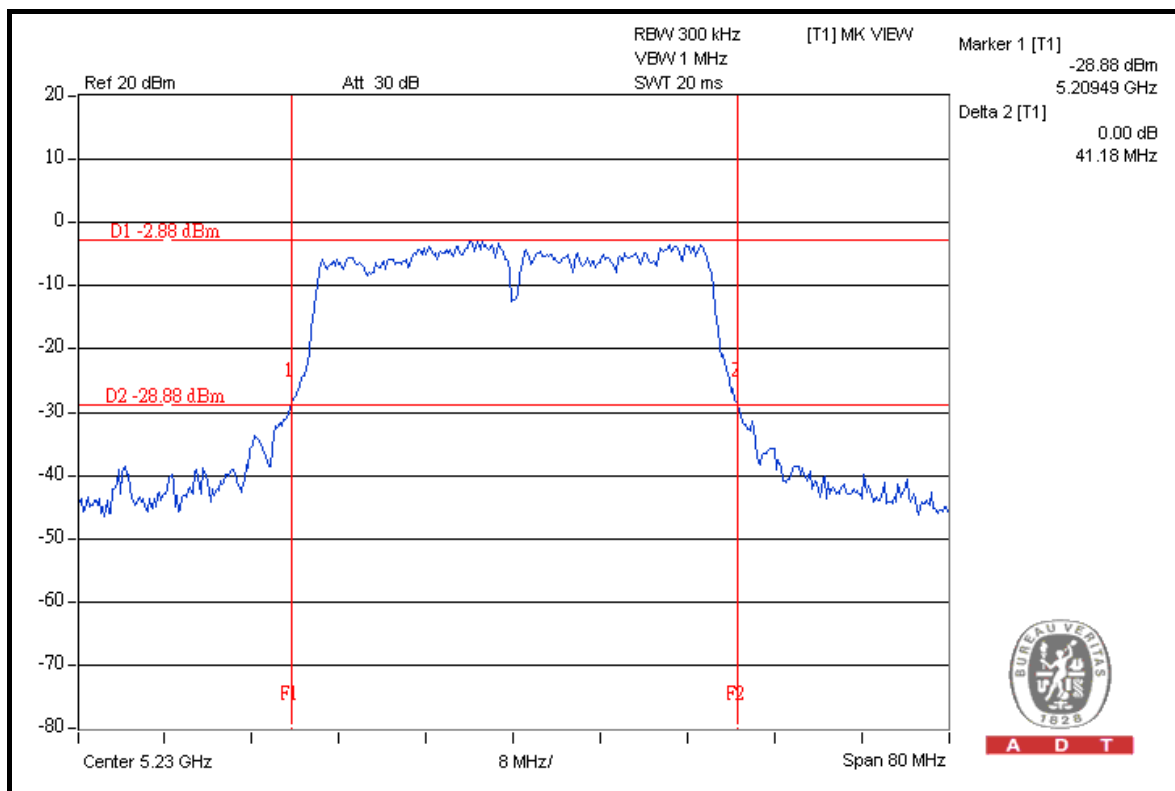

4.4 PEAK POWER EXCURSION MEASUREMENT

4.4.1 LIMITS OF PEAK POWER EXCURSION MEASUREMENT

FREQUENCY BAND	LIMIT
5.15 ~ 5.25GHz	13dB

4.4.2 TEST INSTRUMENTS

DESCRIPTION & MANUFACTURER	MODEL NO.	SERIAL NO.	DATE OF CALIBRATION	CALIBRATED UNTIL
R&S SPECTRUM ANALYZER	FSP40	100041	Apr. 22, 2008	Apr. 21, 2009

NOTE: The calibration interval of the above test instruments is 12 months and the calibrations are traceable to NML/ROC and NIST/USA.

4.4.3 TEST PROCEDURE

- a. The transmitter output was connected to the spectrum analyzer.
- b. Set the spectrum bandwidth span to view the entire spectrum.
- c. Using peak detector and Max-hold function for Trace 1 (RB = 1MHz, VB = 3MHz) and 2 (RB = 1MHz, VB = 300kHz).
- d. The differences between Trace1 and Trace 2 in any 1MHz band at f1 to f2 range were recorded and showed to another trace.

4.4.4 DEVIATION FROM TEST STANDARD

No deviation.

4.4.5 TEST SETUP

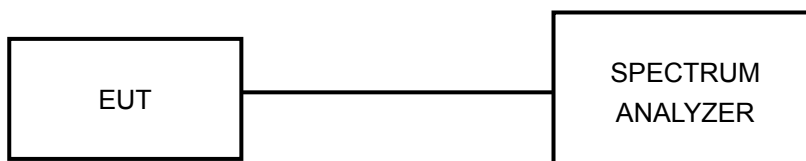

4.4.6 EUT OPERATING CONDITIONS

The software provided by client to enable the EUT under transmission condition continuously at specific channel frequencies individually.

4.4.7 TEST RESULTS

802.11a OFDM MODULATION

MODULATION TYPE	BPSK	TRANSFER RATE	6.0Mbps
INPUT POWER	120Vac, 60Hz	ENVIRONMENTAL CONDITIONS	24 deg.C, 64 %RH, 1021hPa
TESTED BY	Match Tsui		

CHANNEL	CHANNEL FREQUENCY (MHz)	PEAK POWER EXCURSION (dB)		PEAK to AVERAGE EXCURSION LIMIT (dB)	PASS/FAIL
		CHAIN 0	CHAIN 1		
36	5180	7.91	7.35	13	PASS
40	5200	7.57	7.22	13	PASS
48	5240	7.91	6.31	13	PASS



A D T

FOR CHAIN 0: CH 36

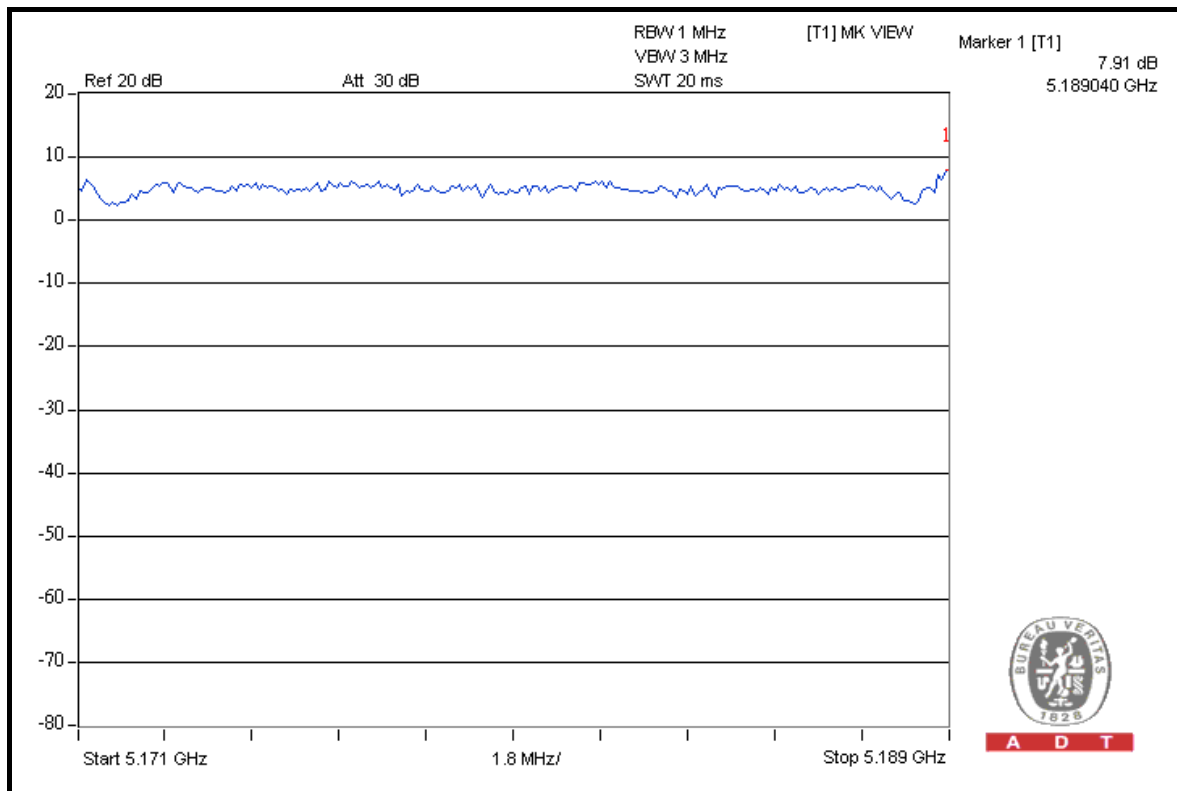
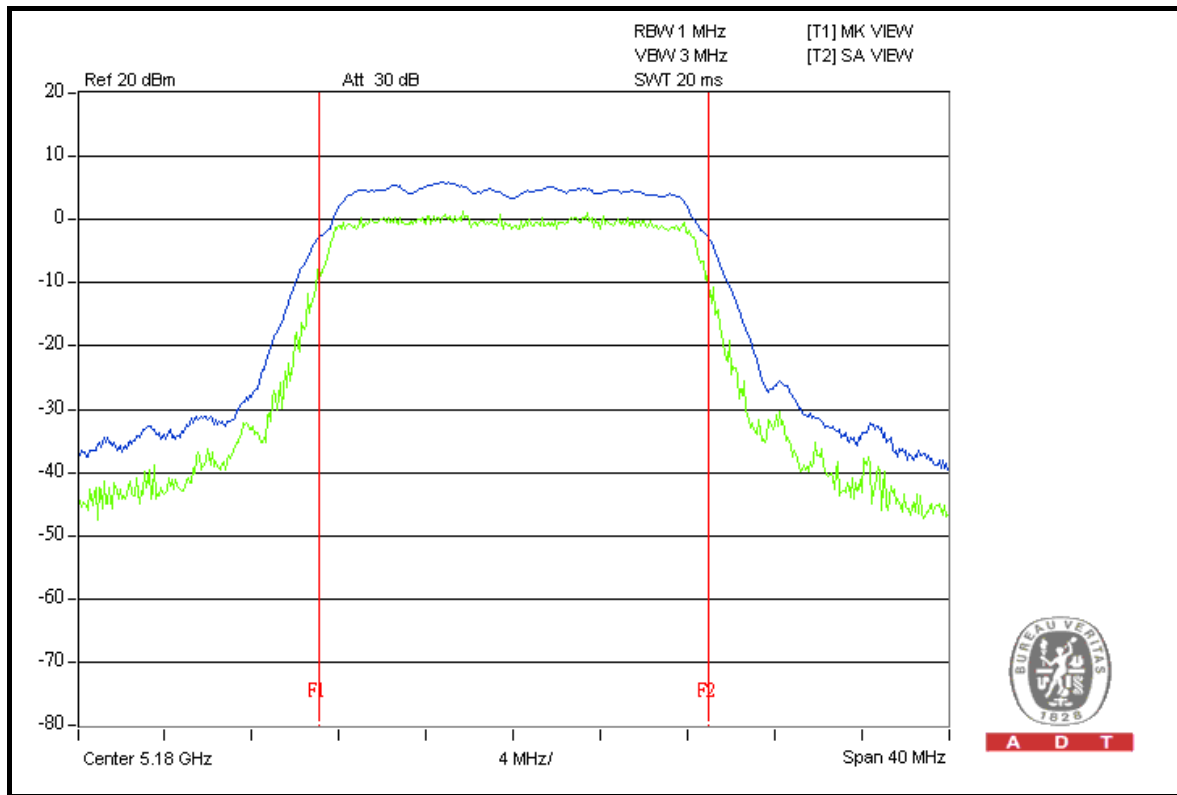



A D T

CH 40

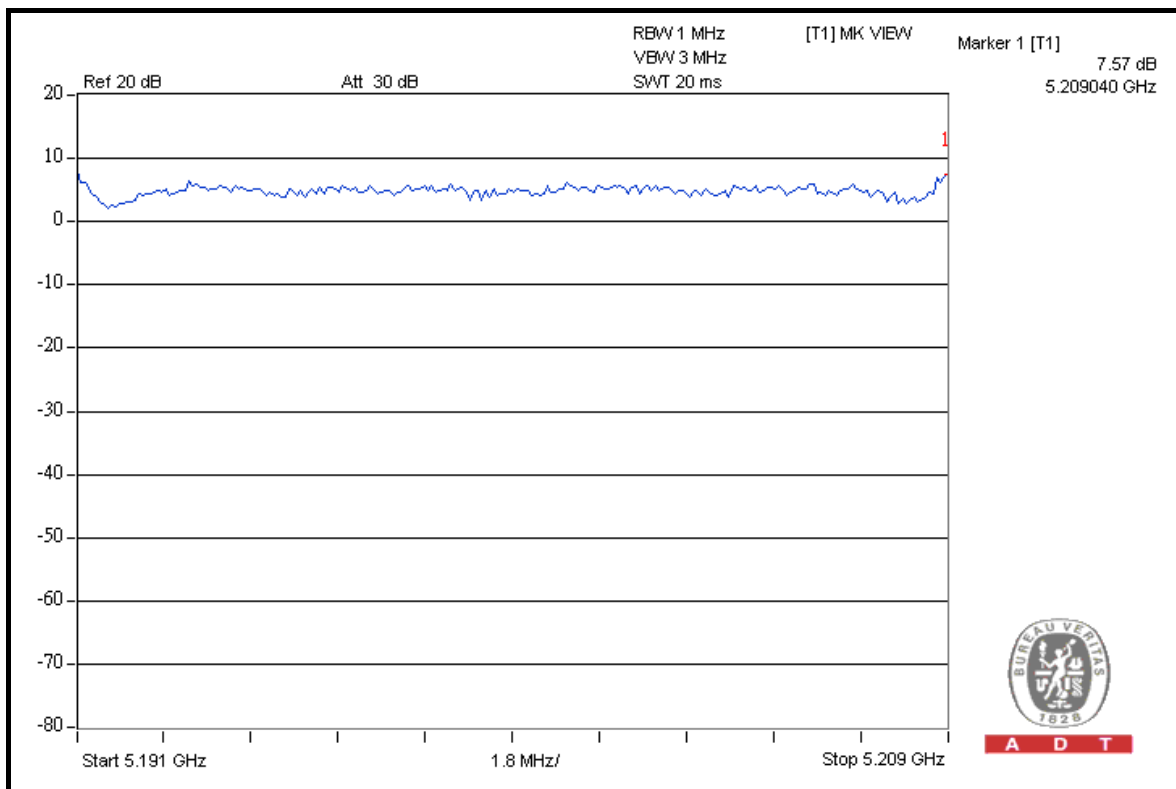
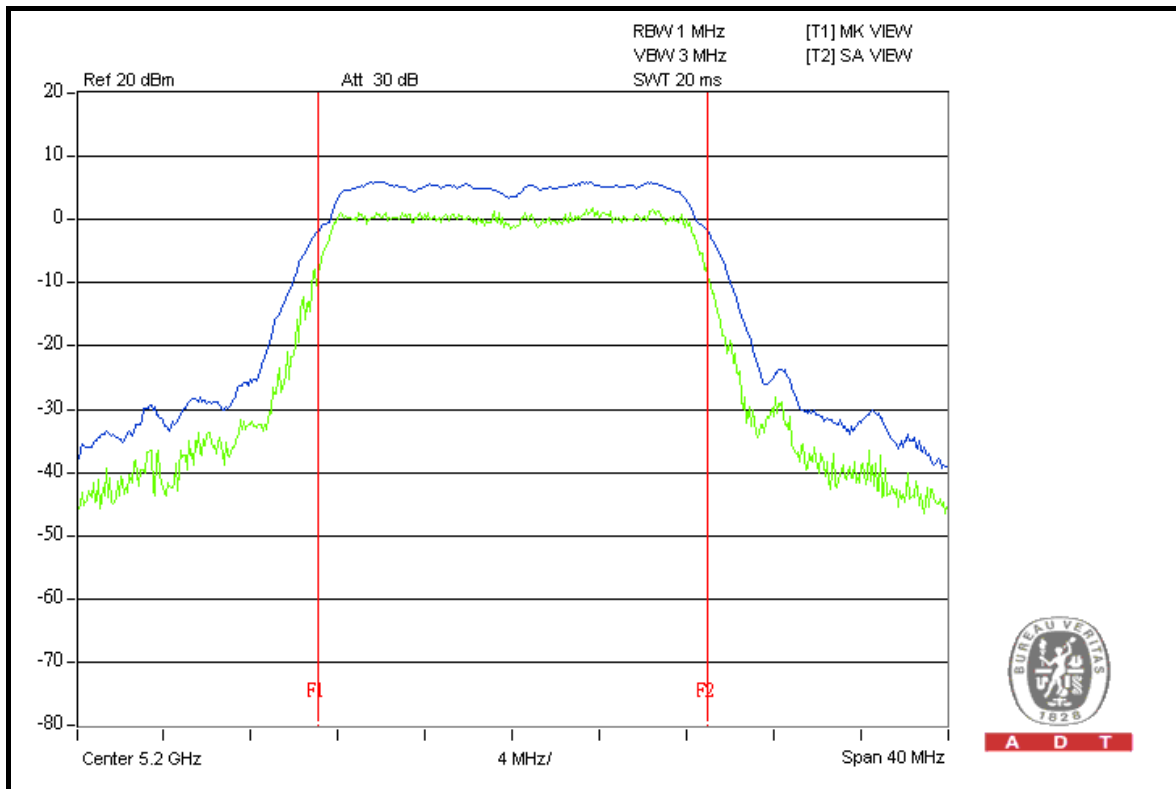



A D T

CH 48

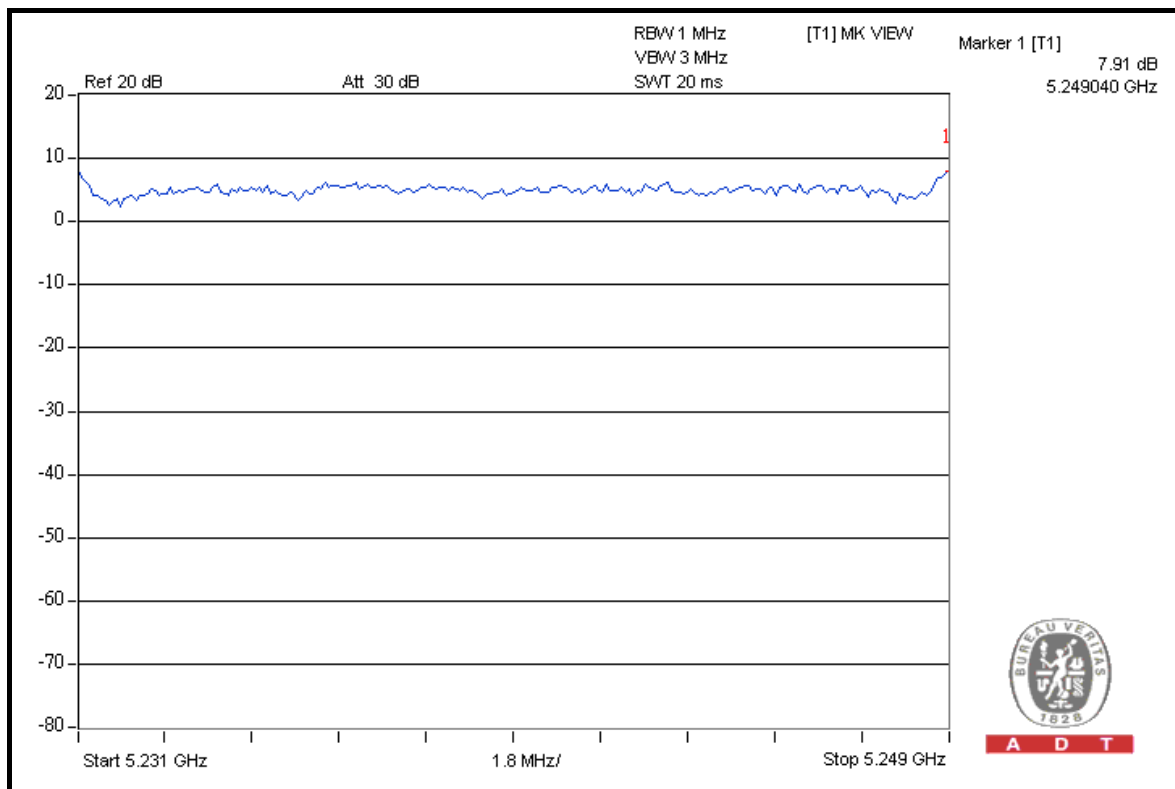
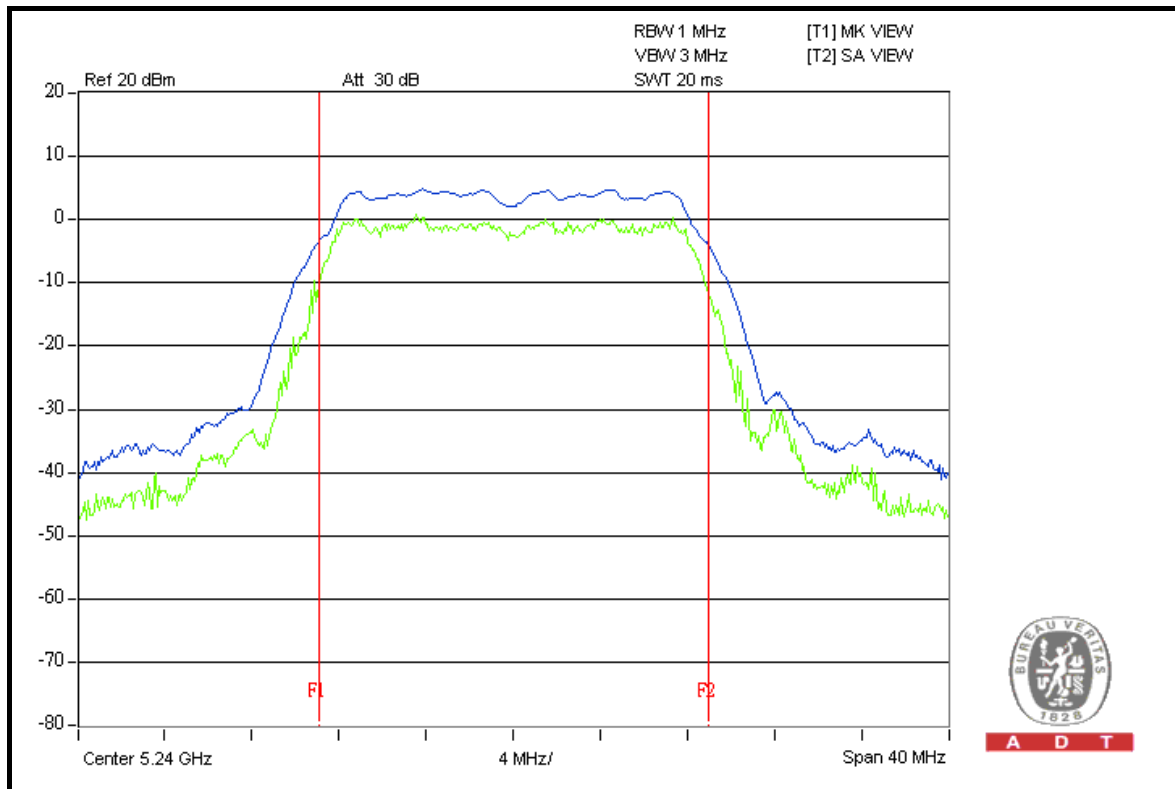



A D T

FOR CHAIN 1: CH 36

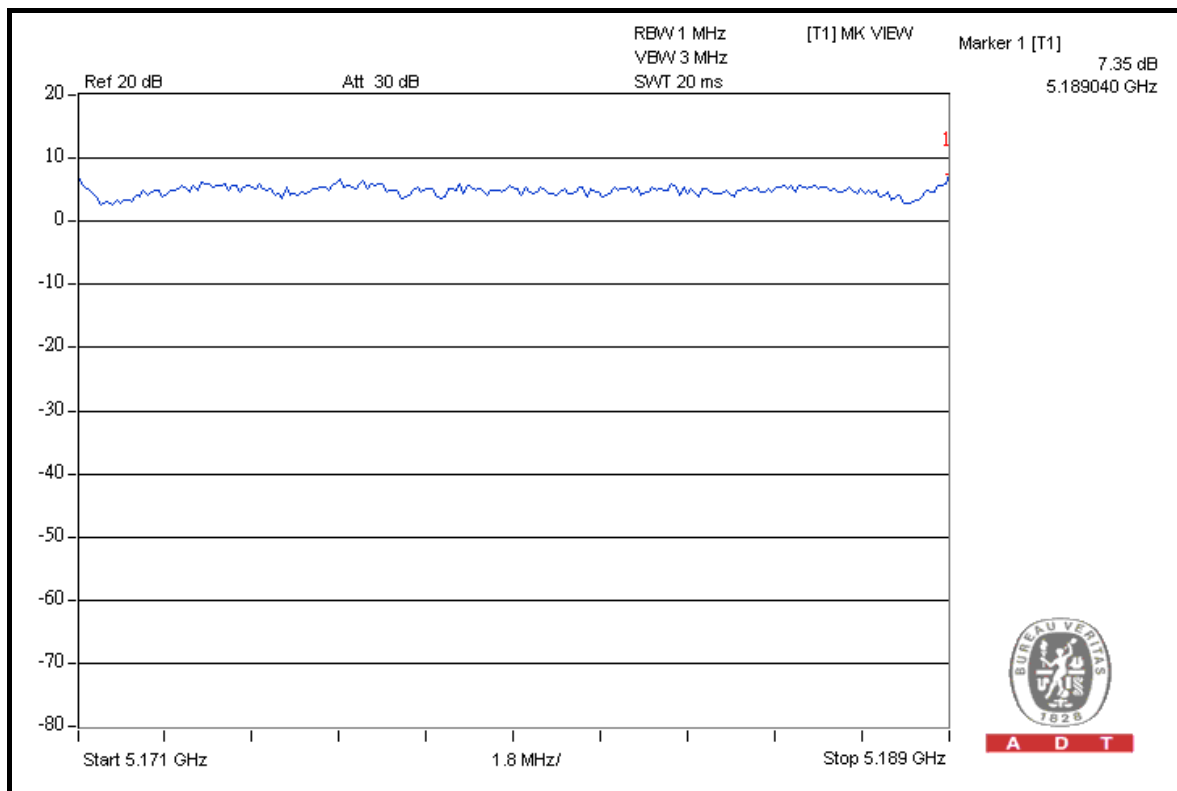
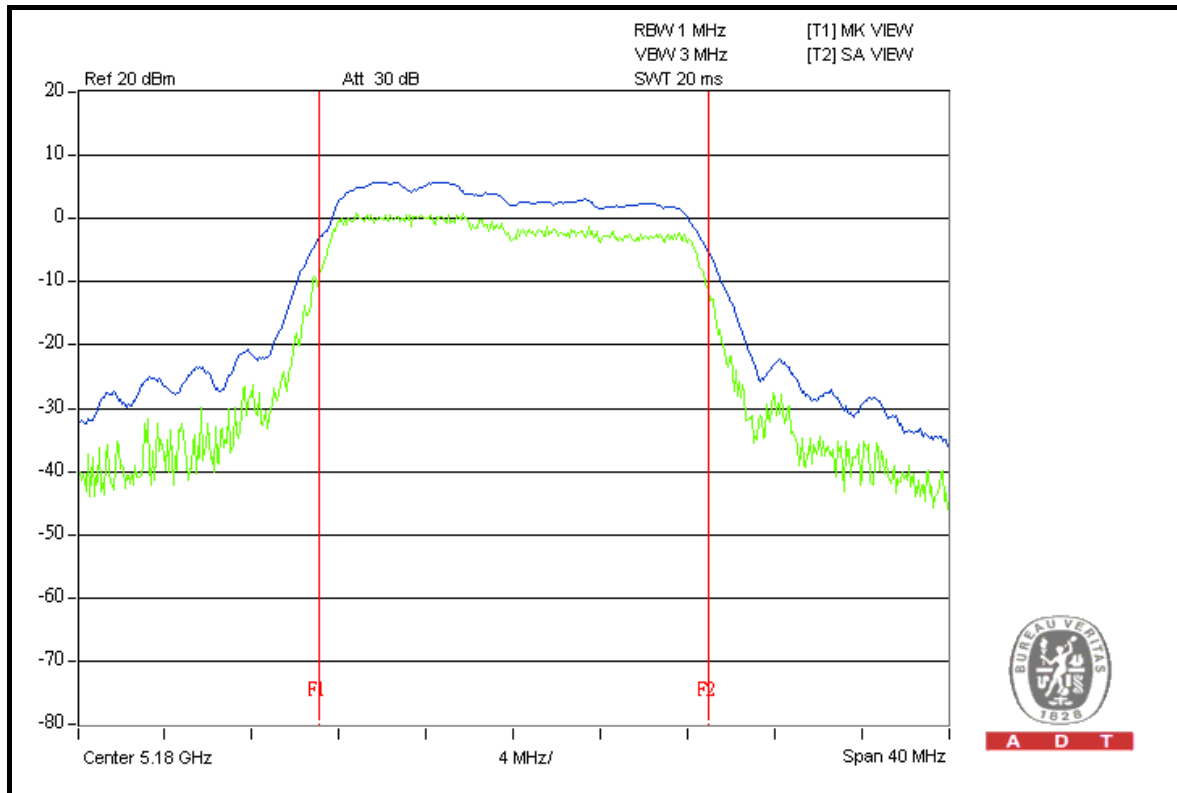



A D T

CH 40

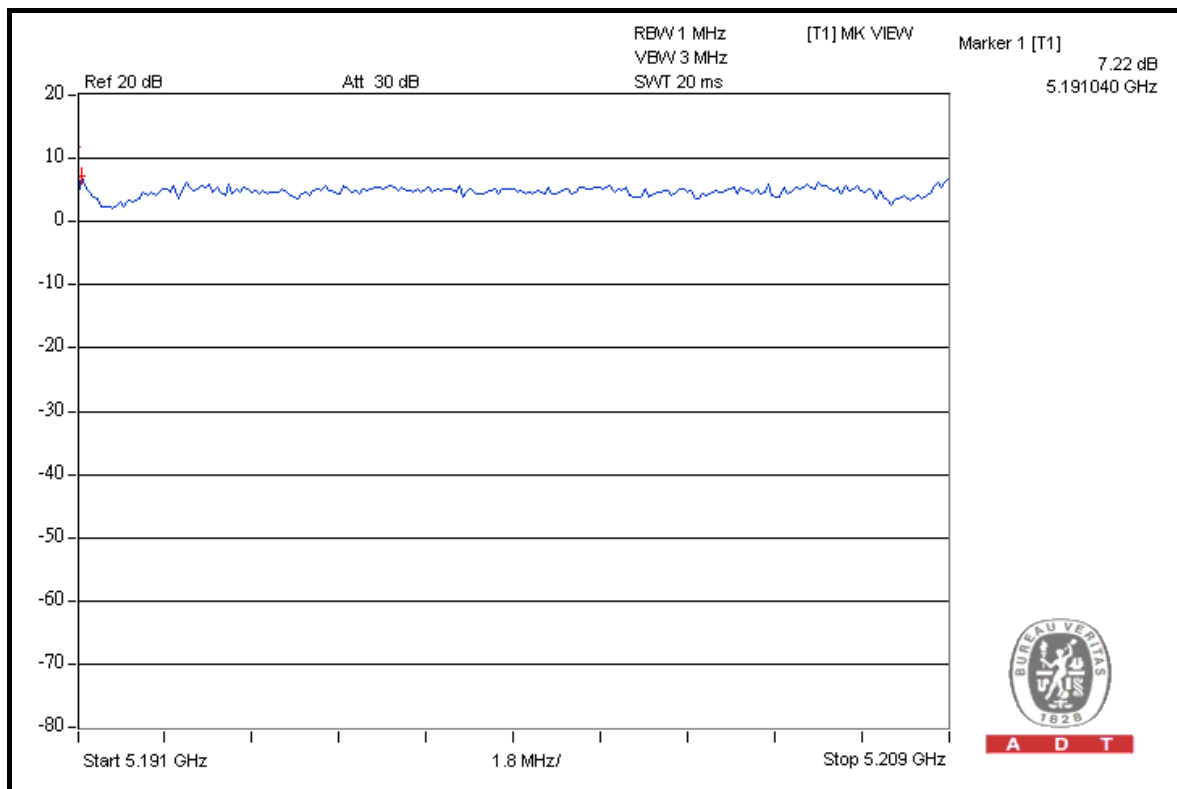
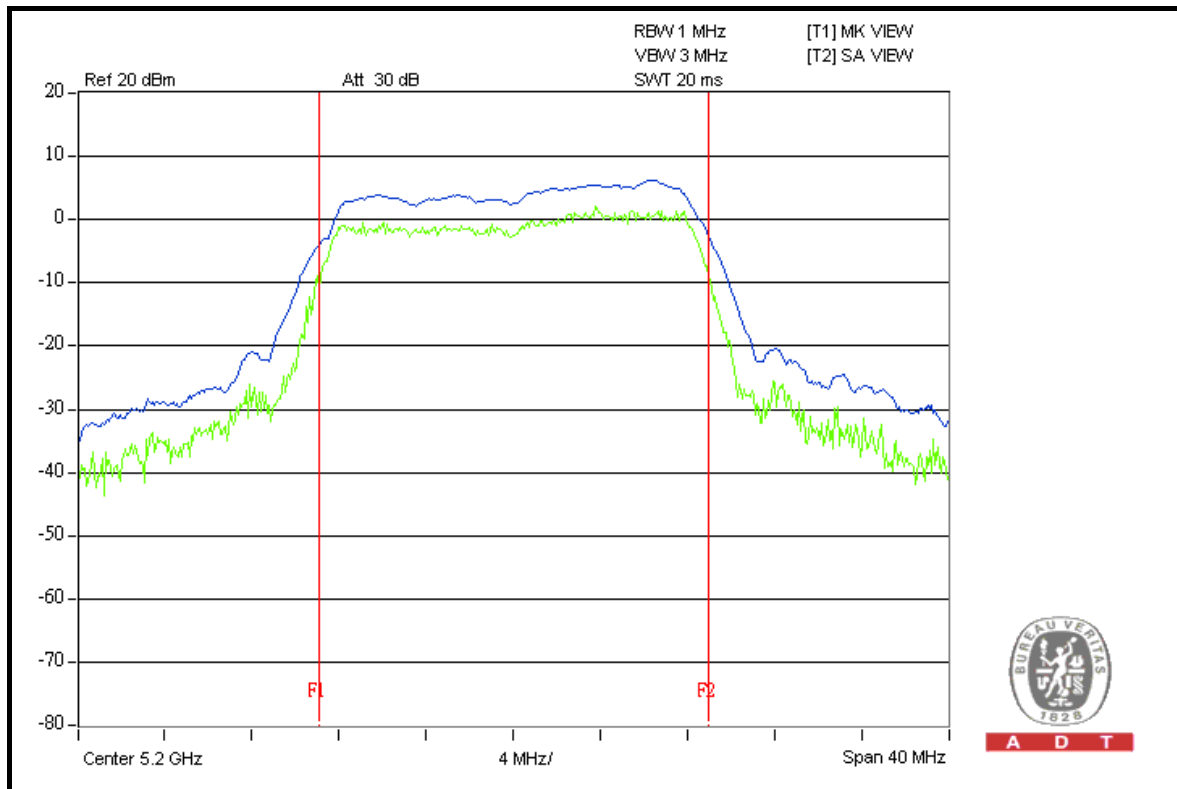



A D T

CH 48

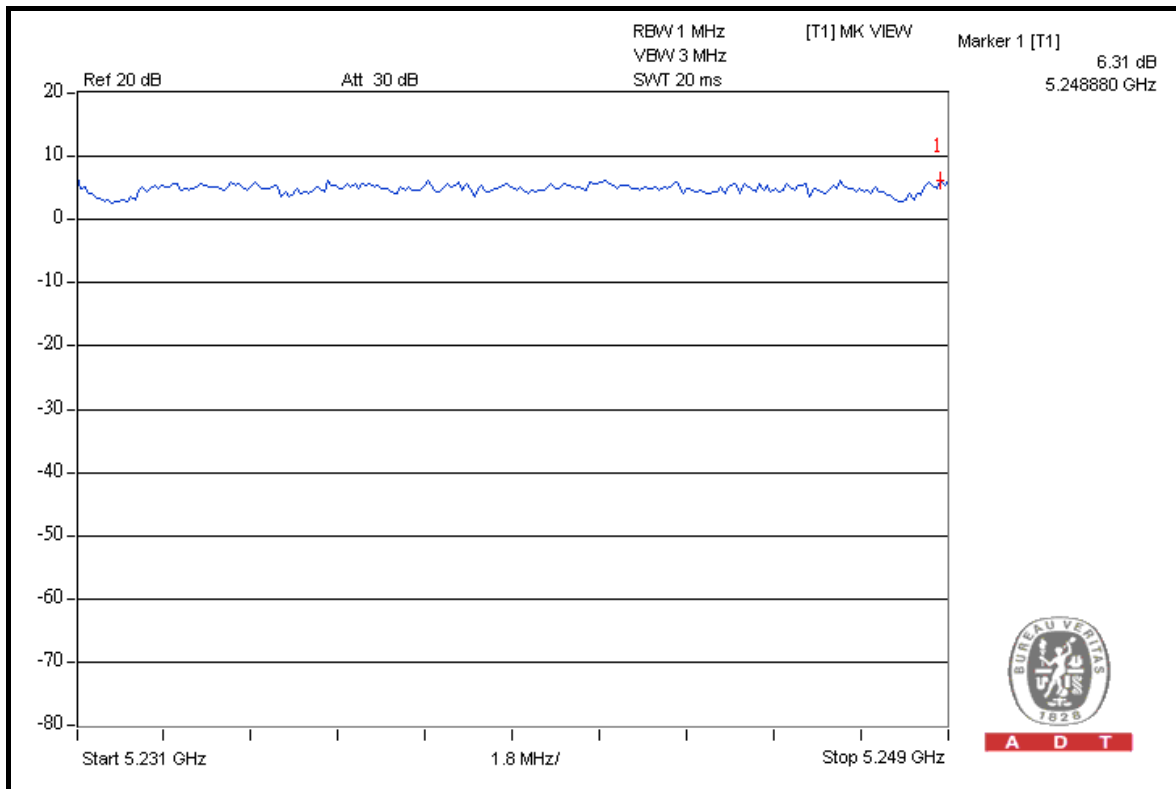
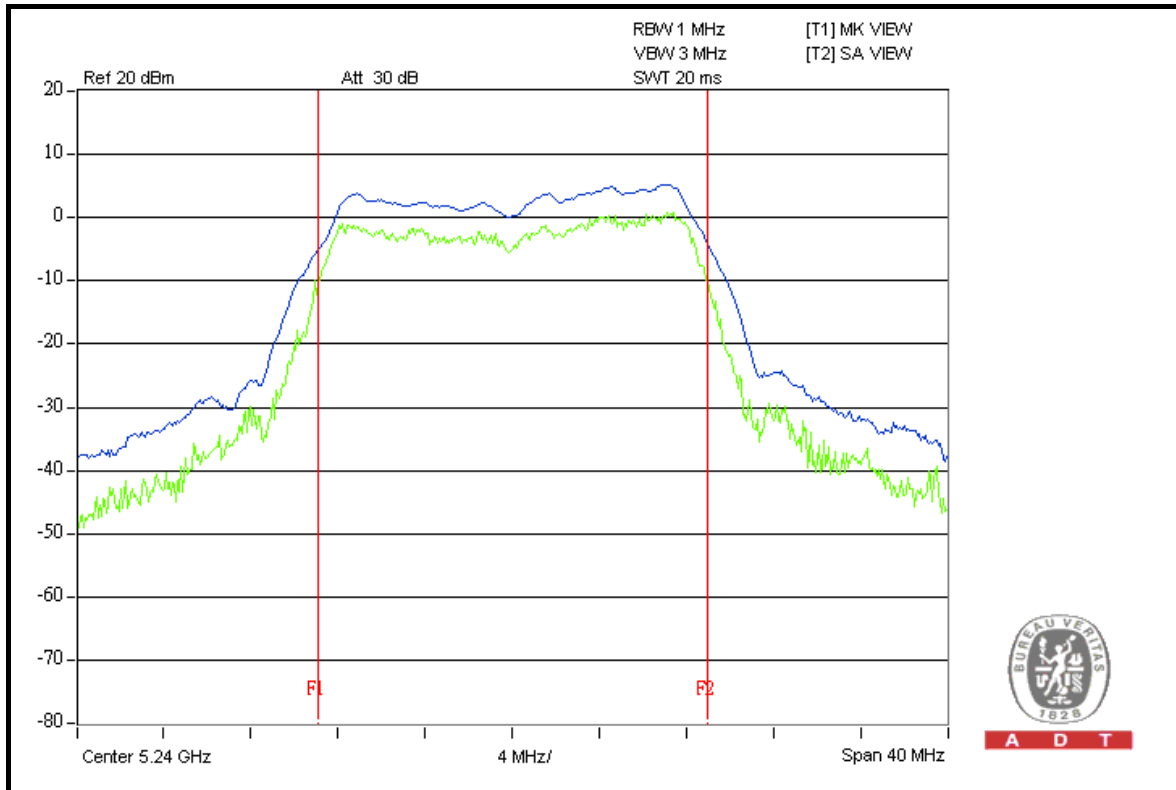



A D T

DRAFT 802.11n (20MHz) OFDM MODULATION

MODULATION TYPE	BPSK	TRANSFER RATE	7.2Mbps
INPUT POWER	120Vac, 60Hz	ENVIRONMENTAL CONDITIONS	24 deg.C, 64 %RH, 1021hPa
TESTED BY	Match Tsui		

CHANNEL	CHANNEL FREQUENCY (MHz)	PEAK POWER EXCURSION (dB)		PEAK to AVERAGE EXCURSION LIMIT (dB)	PASS/FAIL
		CHAIN 0	CHAIN 1		
36	5180	6.71	6.46	13	PASS
40	5200	6.26	6.50	13	PASS
48	5240	6.31	6.36	13	PASS



A D T

FOR CHAIN 0: CH 36

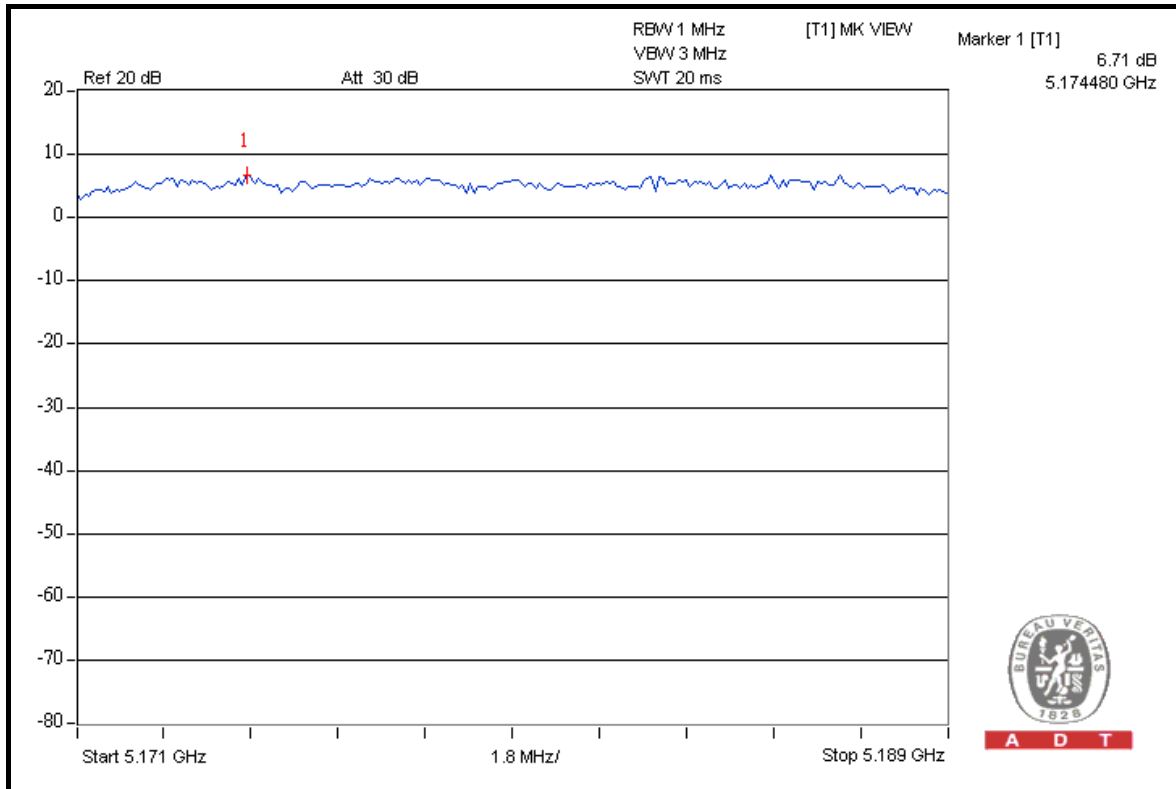
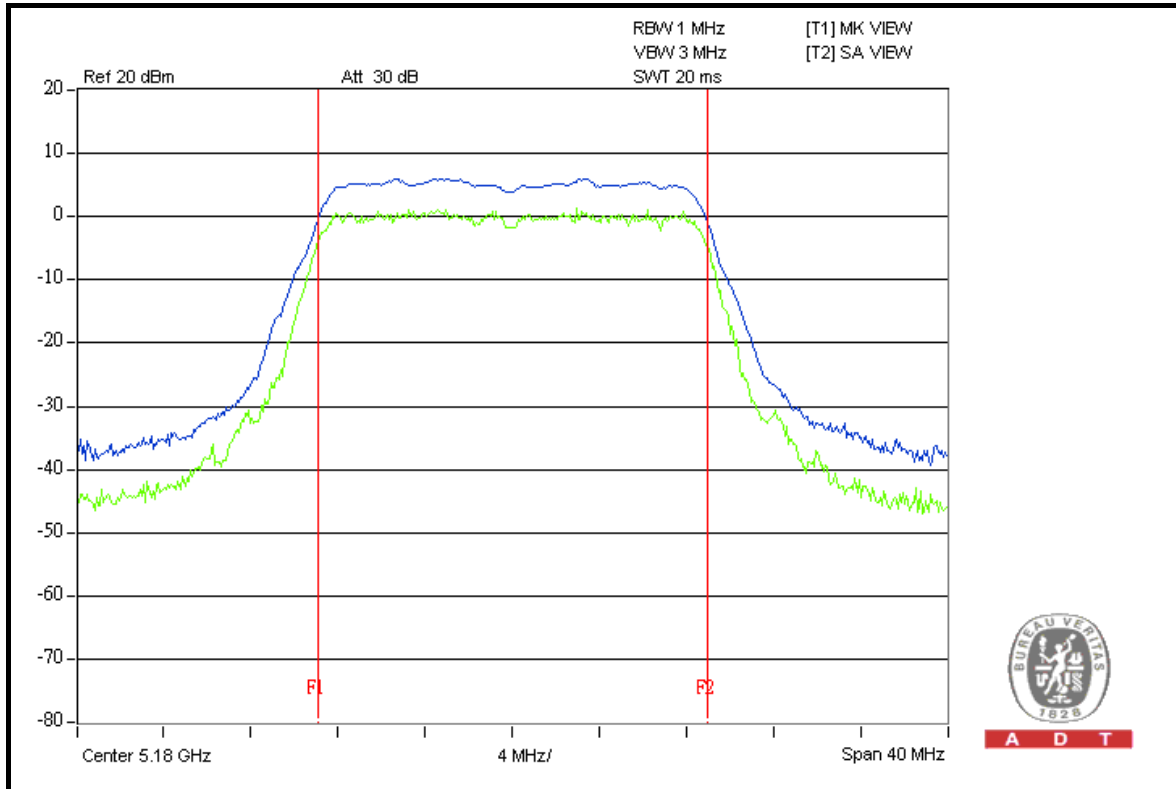



A D T

CH 40

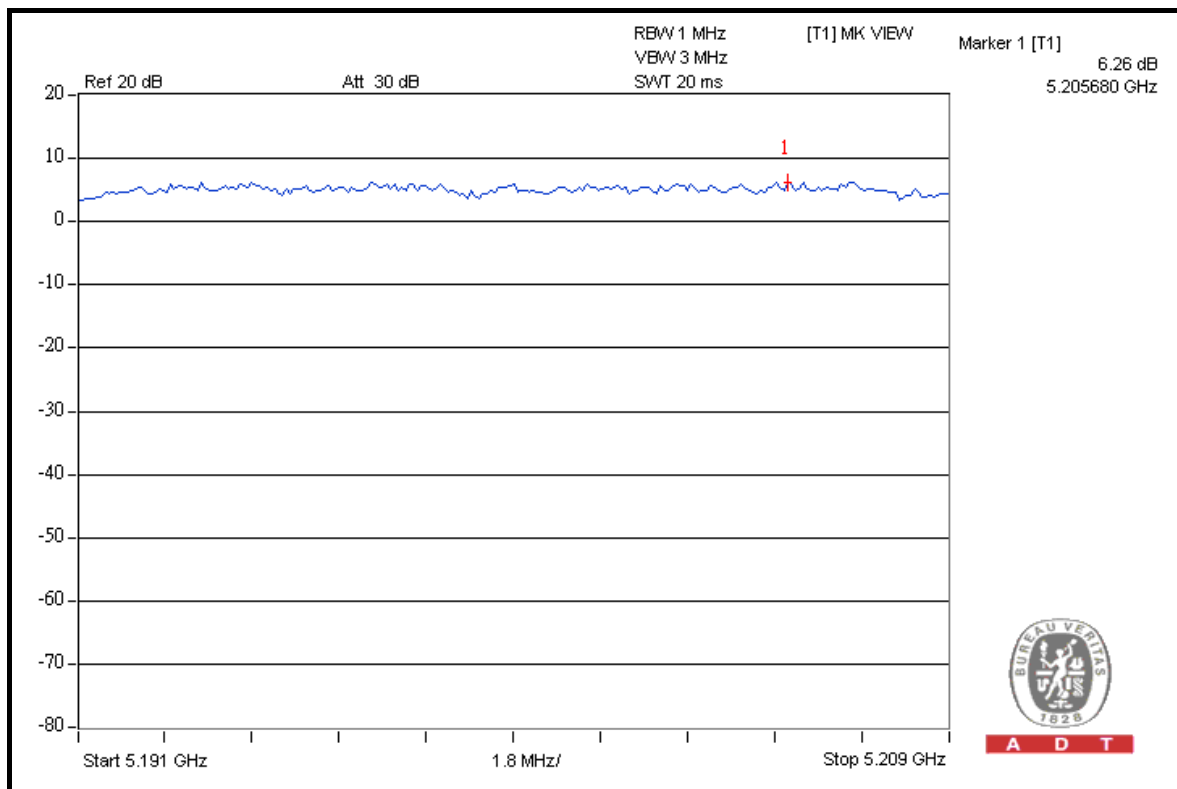
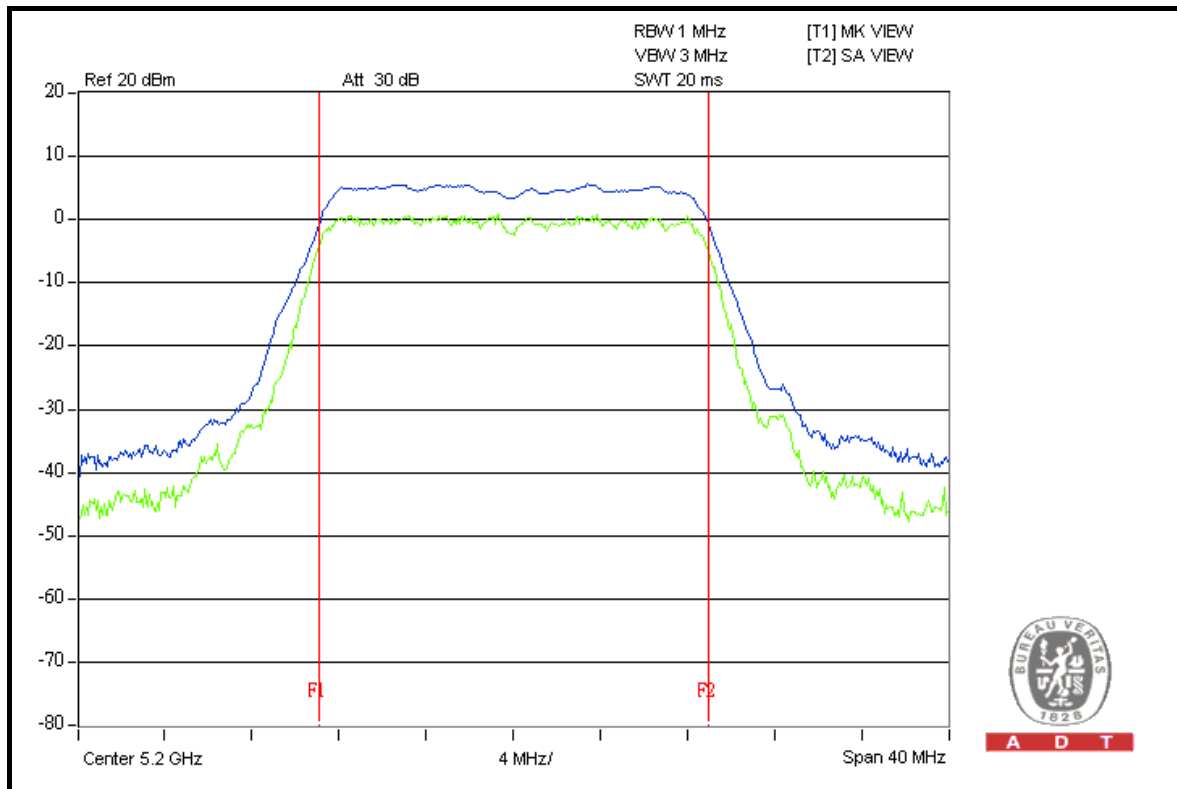



A D T

CH 48

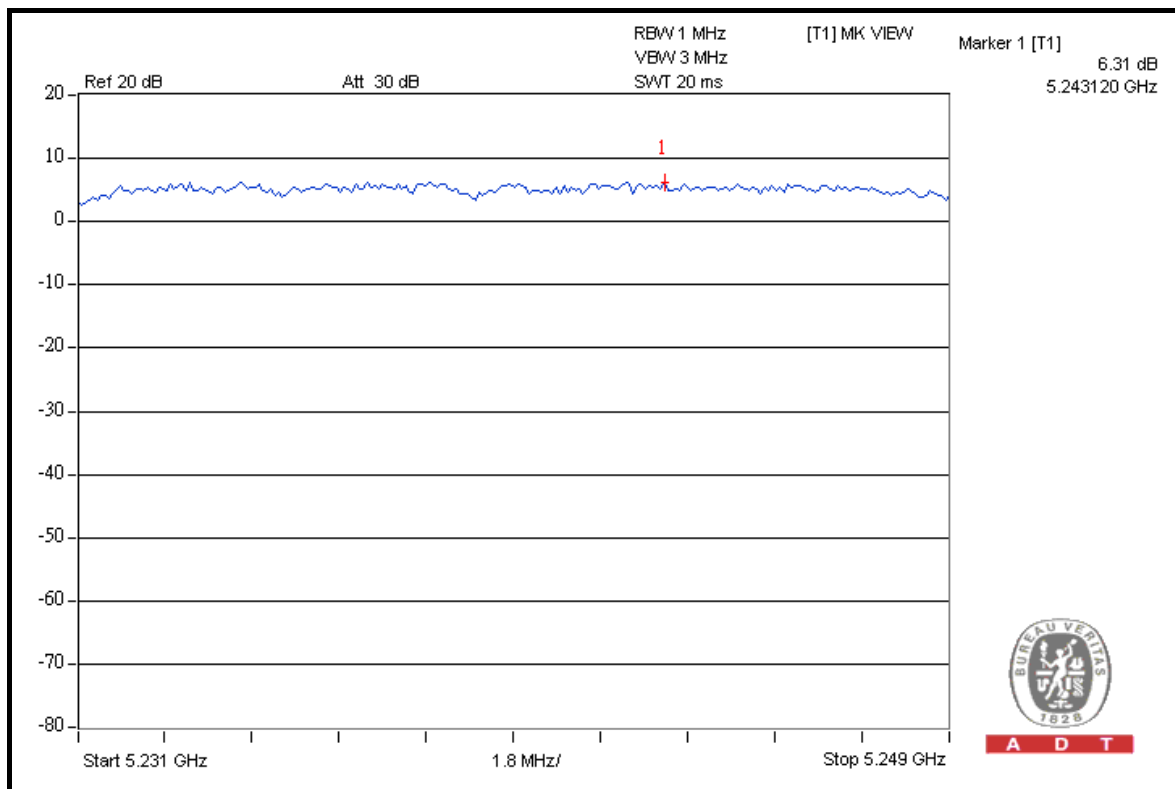
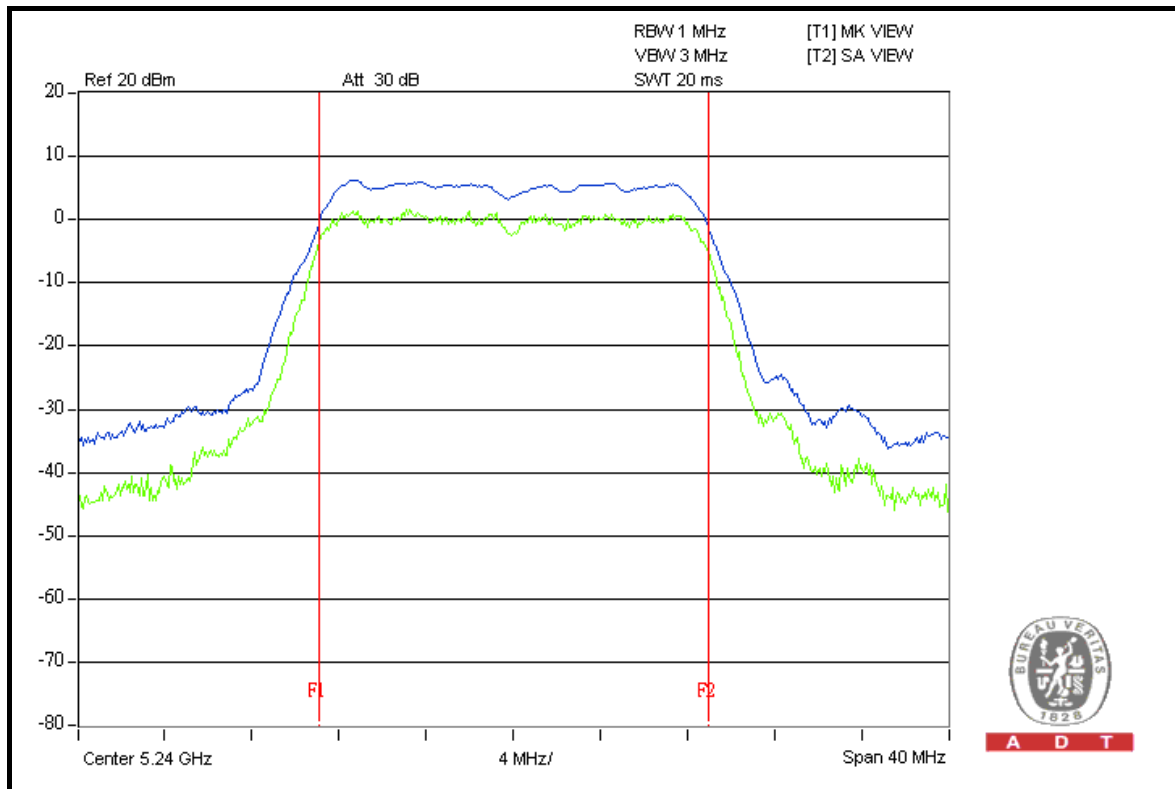

FOR CHAIN 1: CH 36



A D T

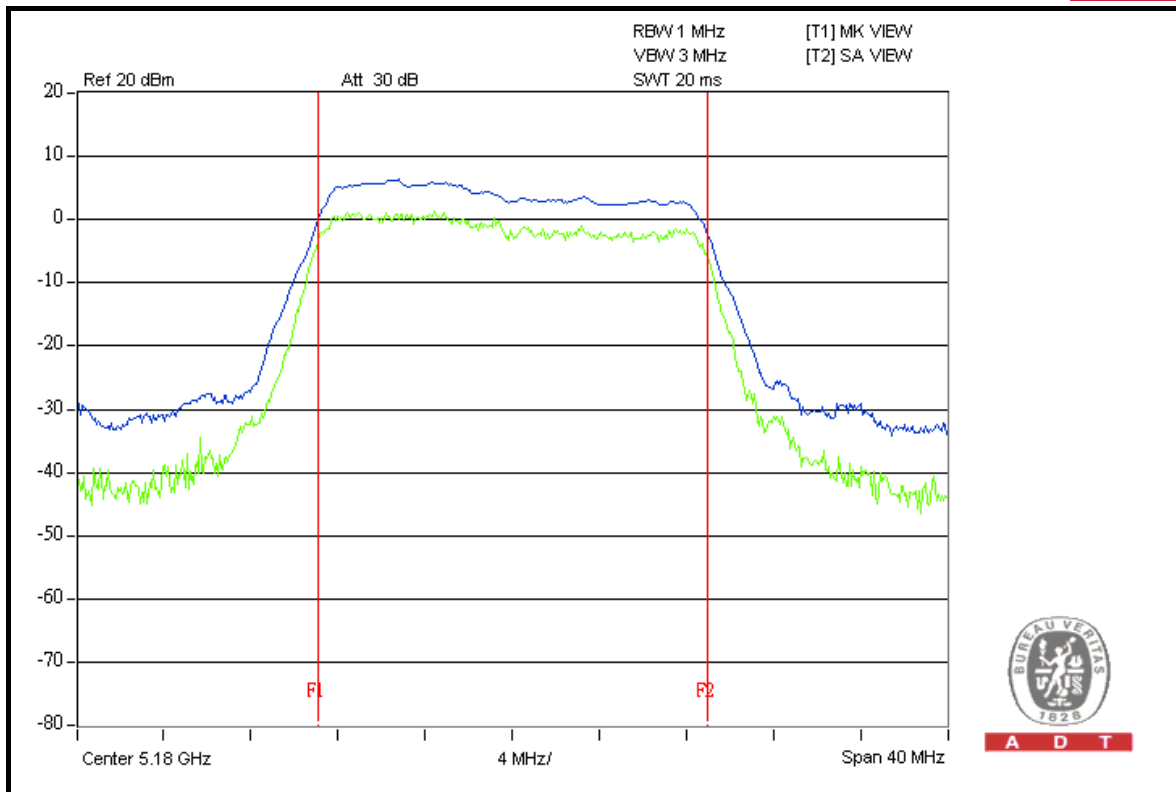

A D T

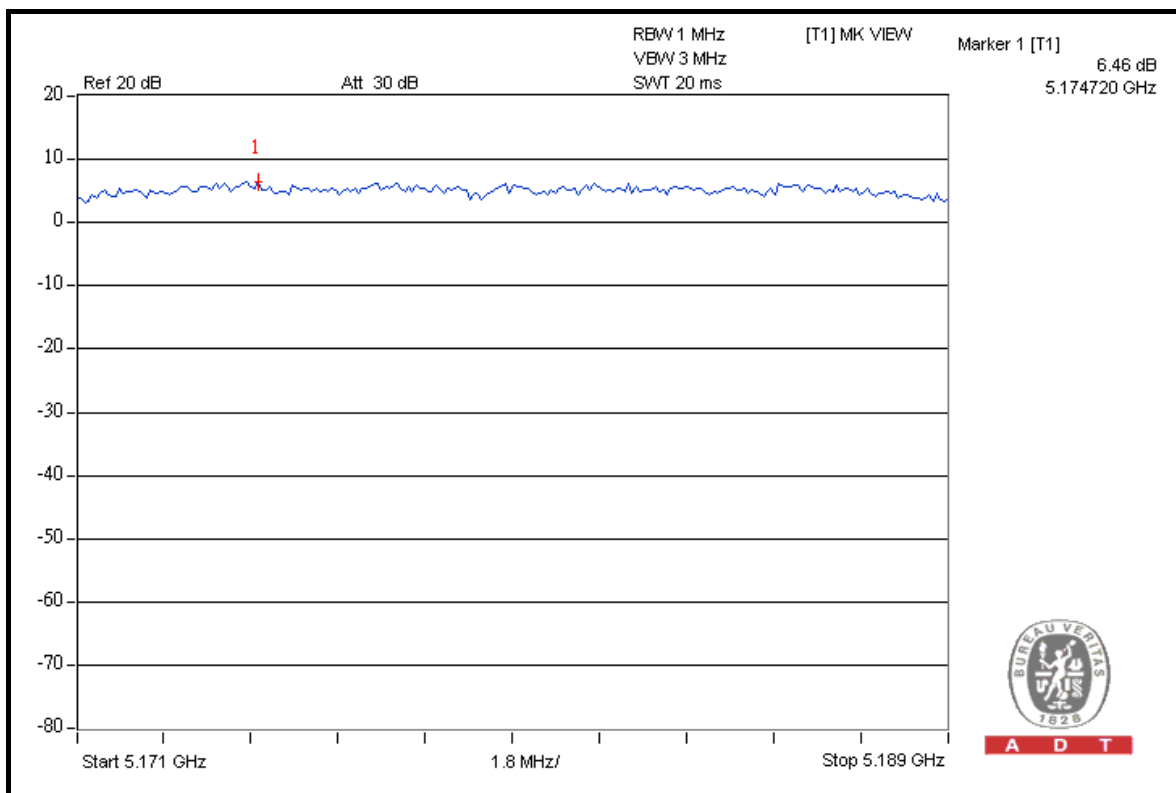

A D T

CH 40



A D T

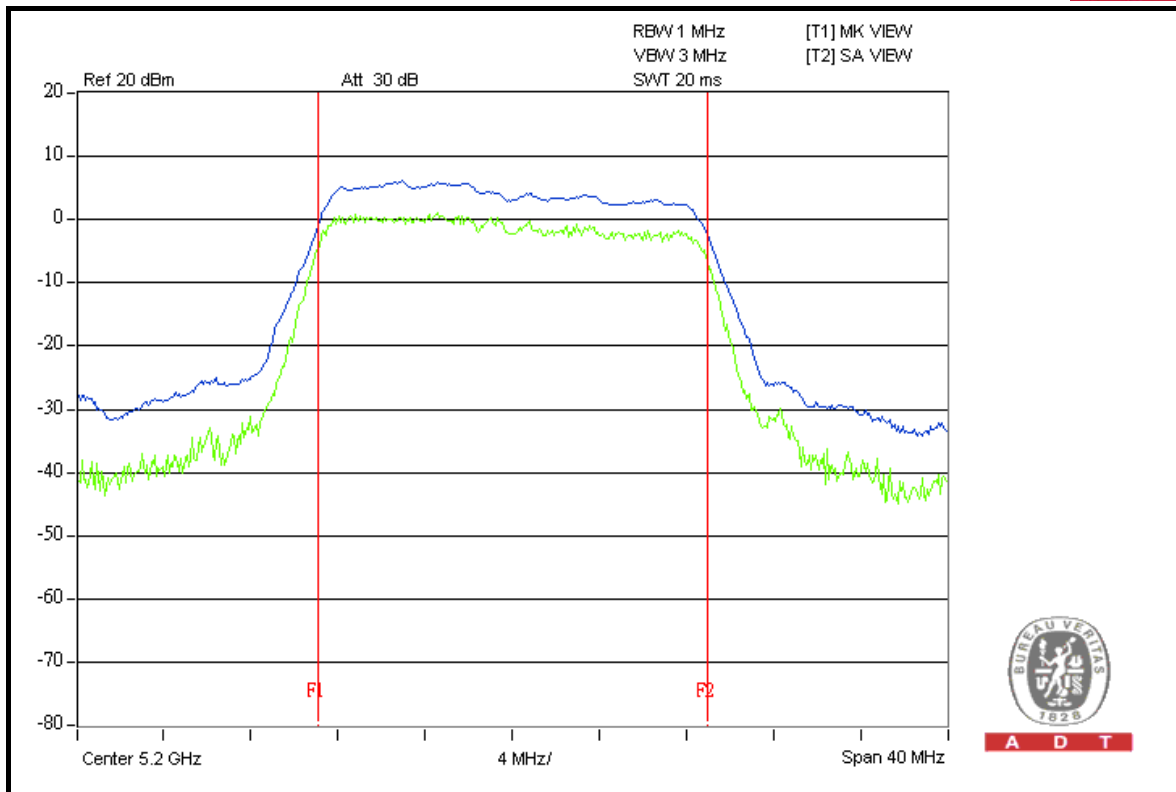

A D T

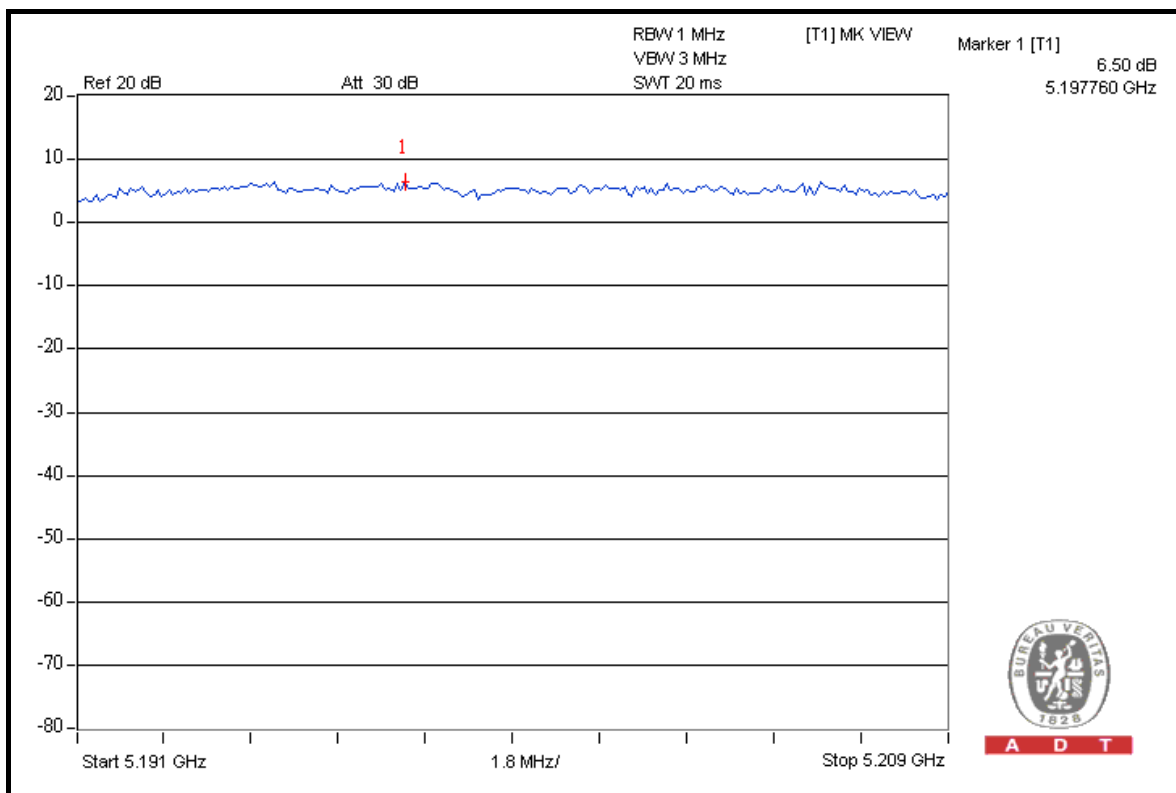

A D T

CH 48



A D T

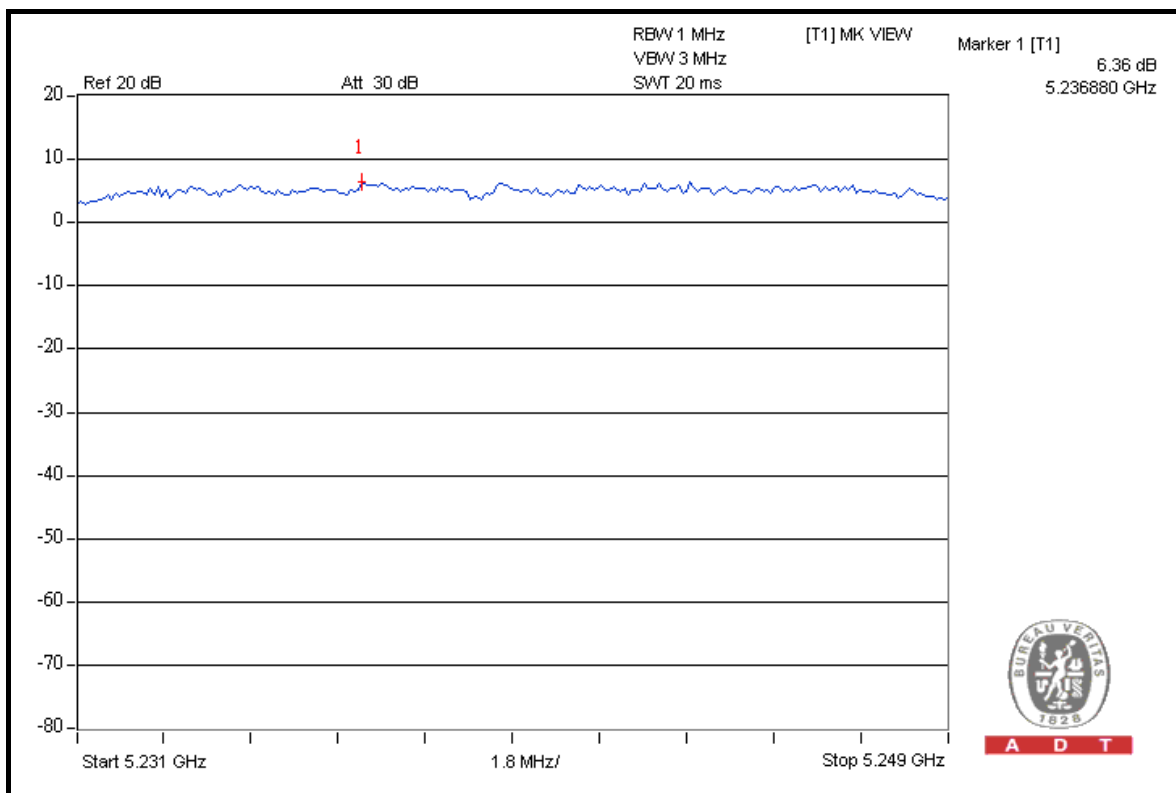
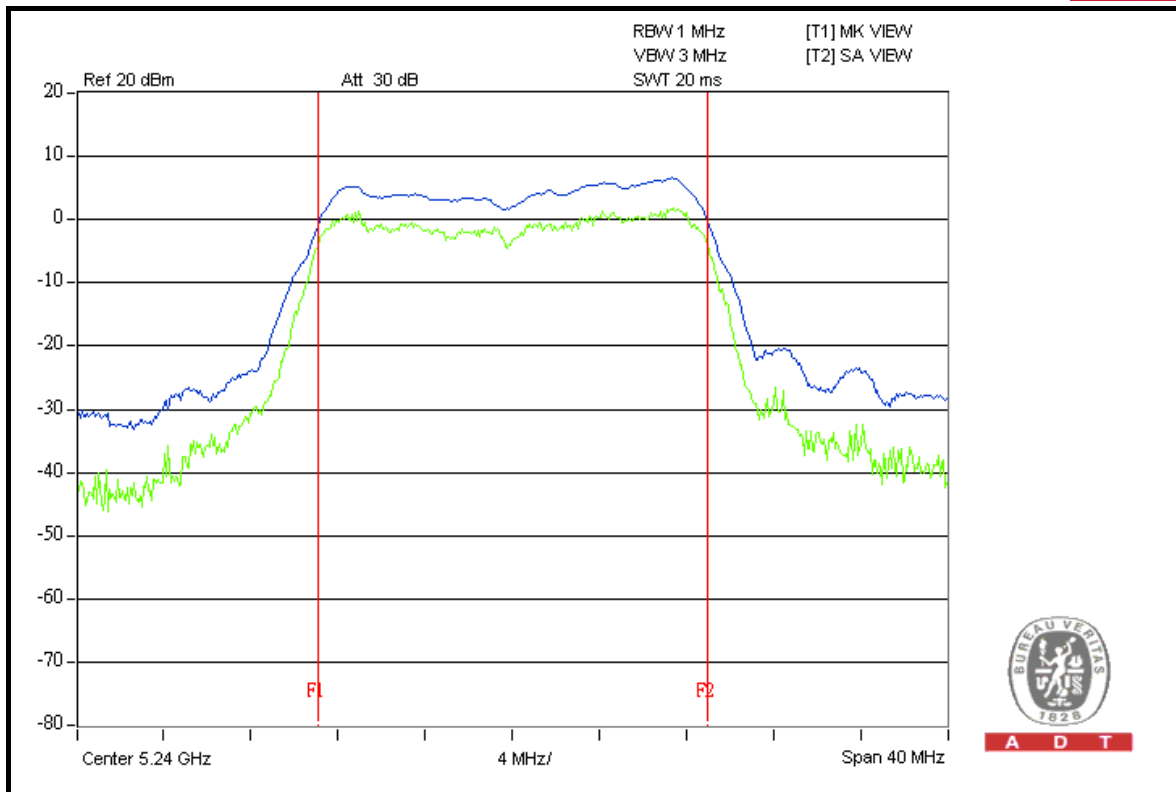

DRAFT 802.11n (40MHz) OFDM MODULATION



A D T

MODULATION TYPE	BPSK	TRANSFER RATE	15.0Mbps
INPUT POWER	120Vac, 60Hz	ENVIRONMENTAL CONDITIONS	24 deg.C, 64 %RH, 1021hPa
TESTED BY	Match Tsui		

CHANNEL	CHANNEL FREQUENCY (MHz)	PEAK POWER EXCURSION (dB)		PEAK to AVERAGE EXCURSION LIMIT (dB)	PASS/FAIL
		CHAIN 0	CHAIN 1		
38	5190	6.33	6.56	13	PASS
46	5230	7.12	6.80	13	PASS



A D T

FOR CHAIN 0: CH 38

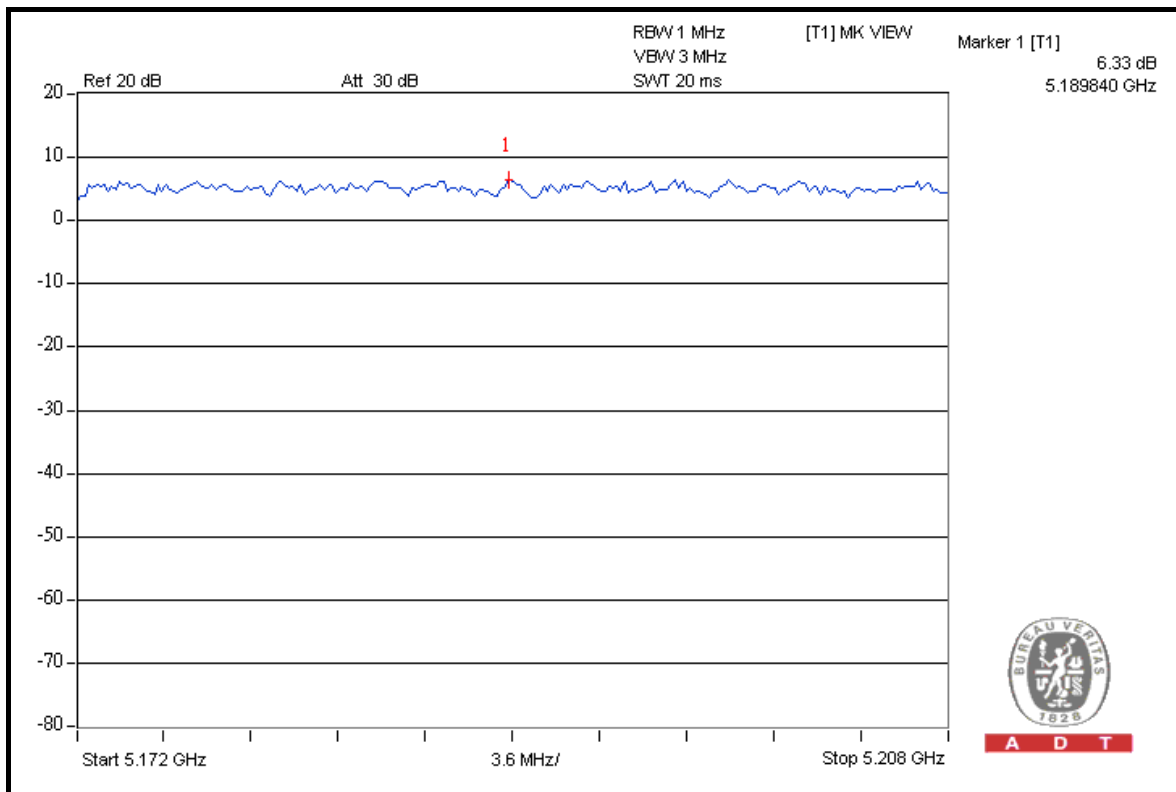
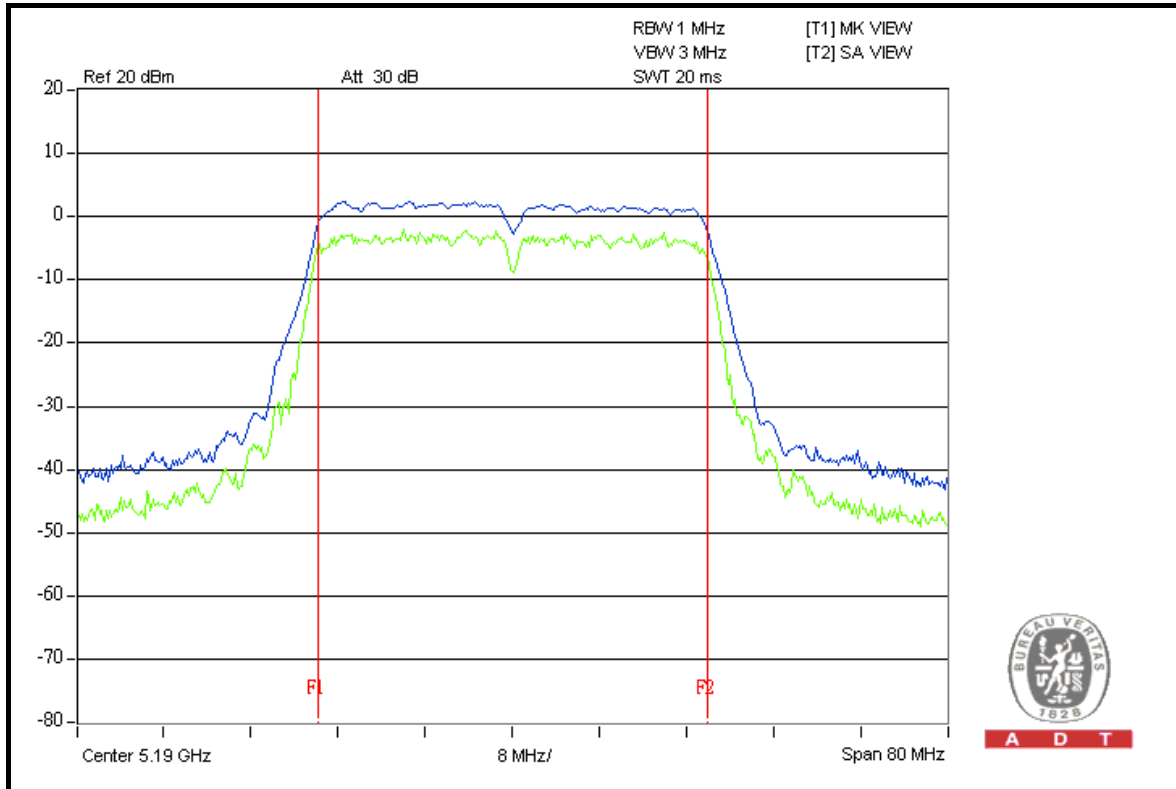



A D T

CH 46

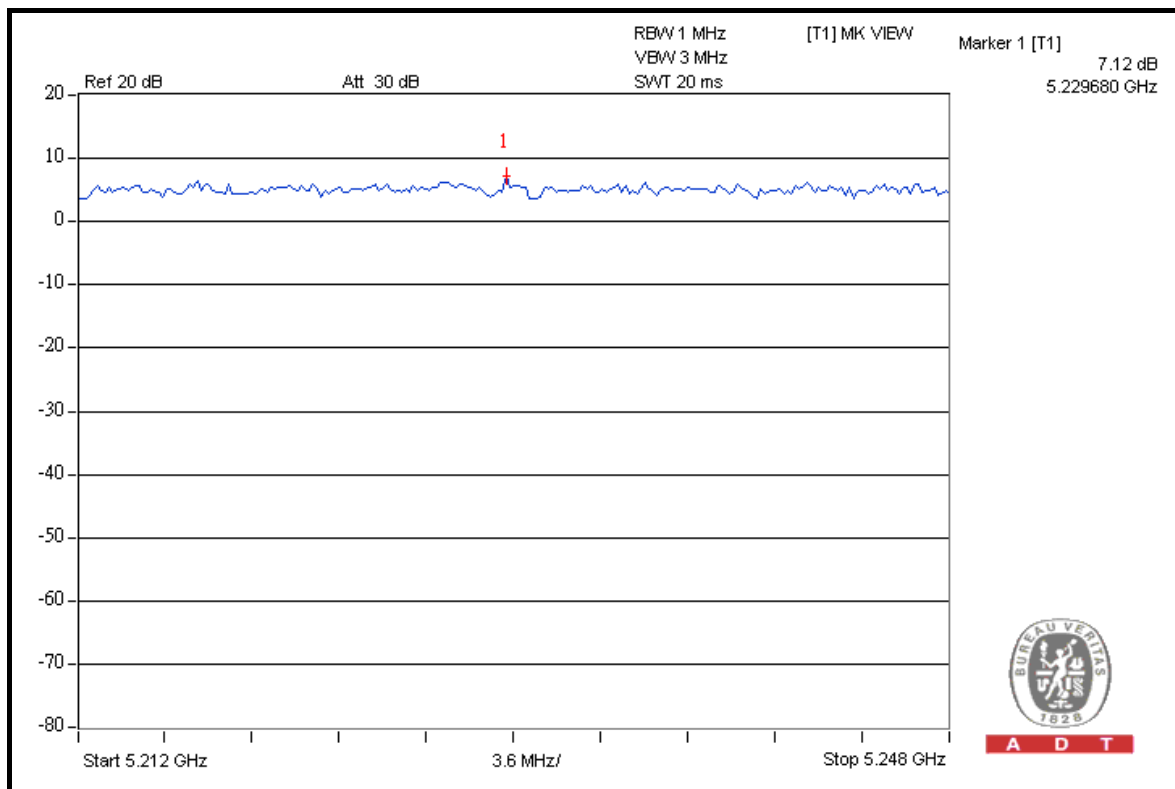
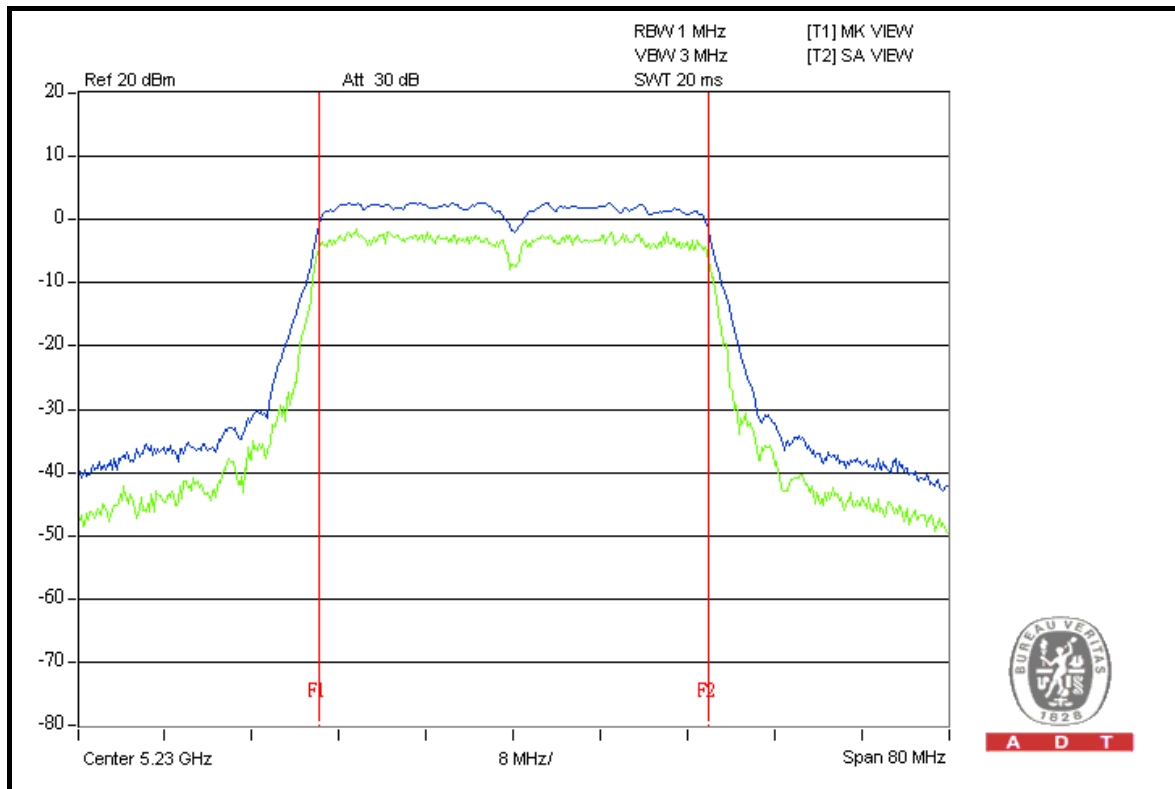

FOR CHAIN 1: CH 38



A D T

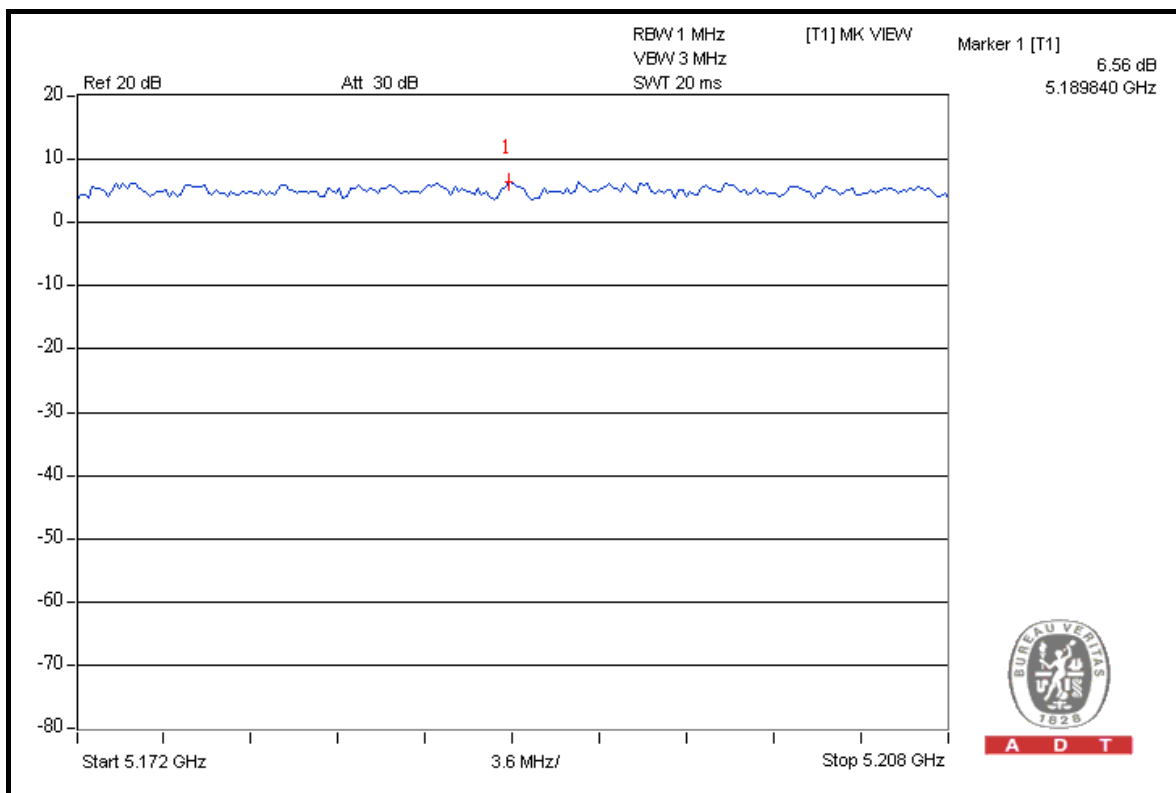
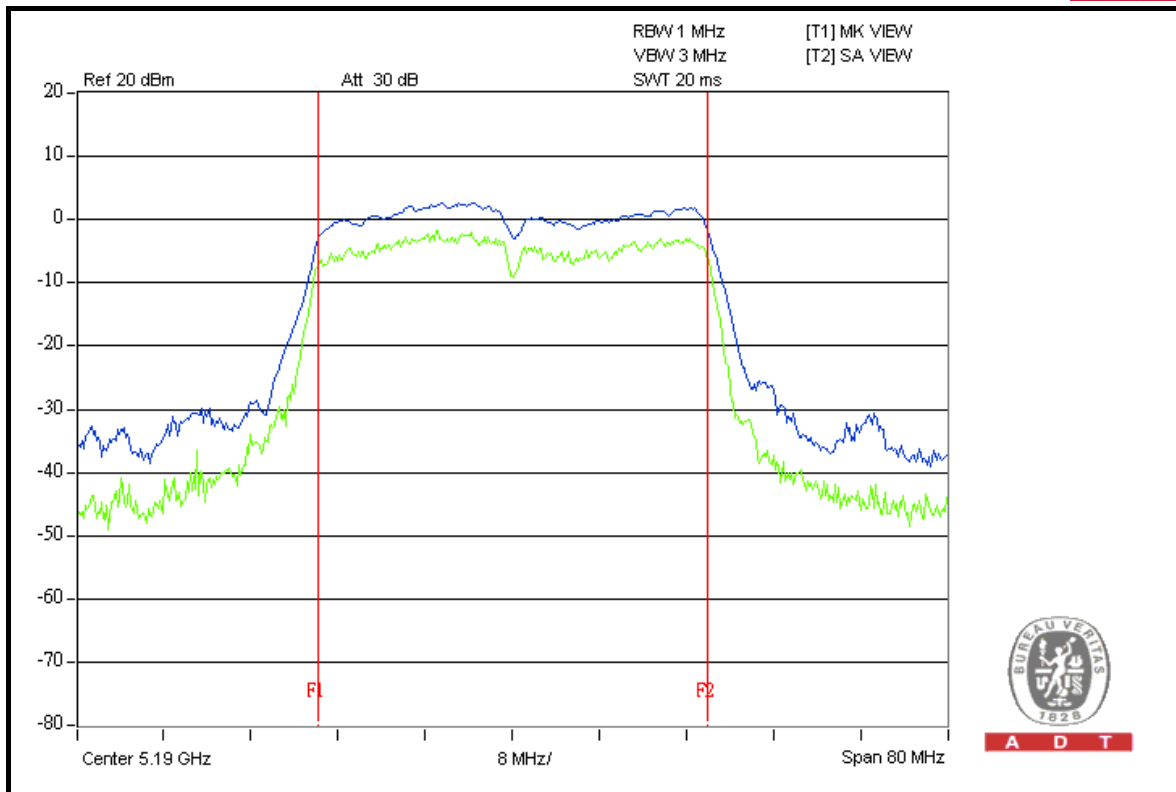

CH 46



A D T

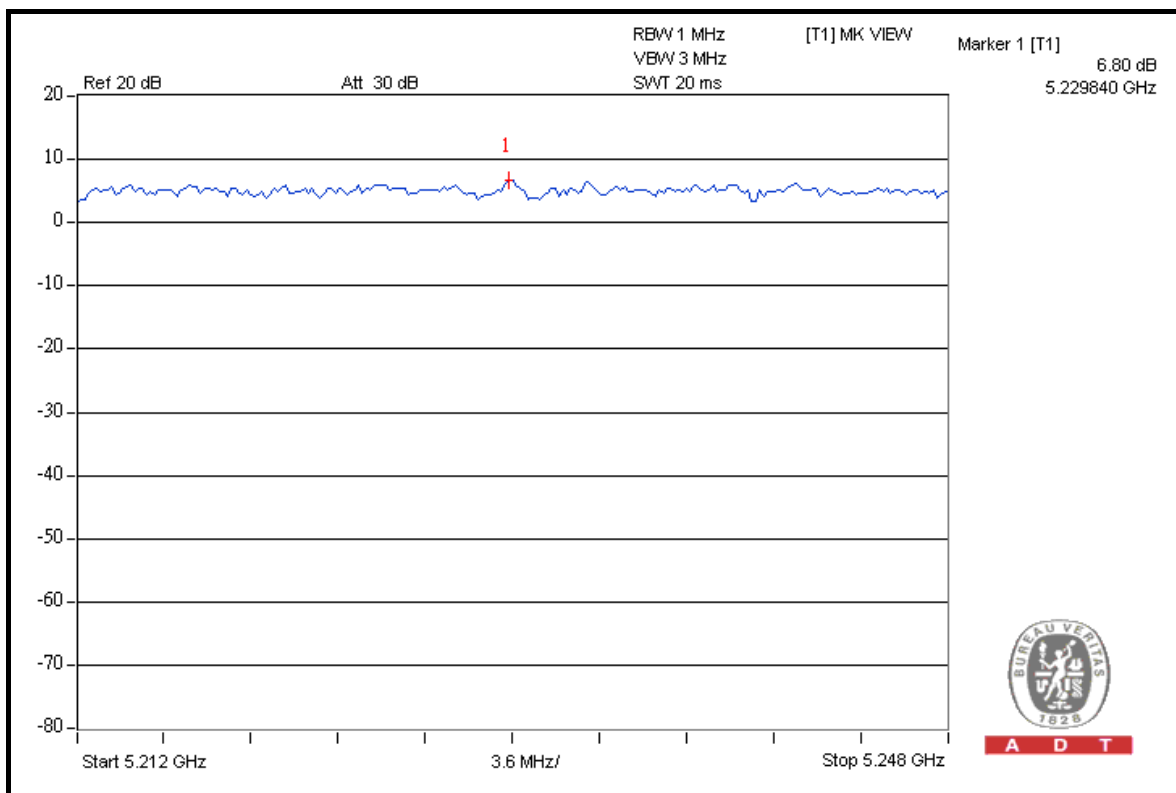
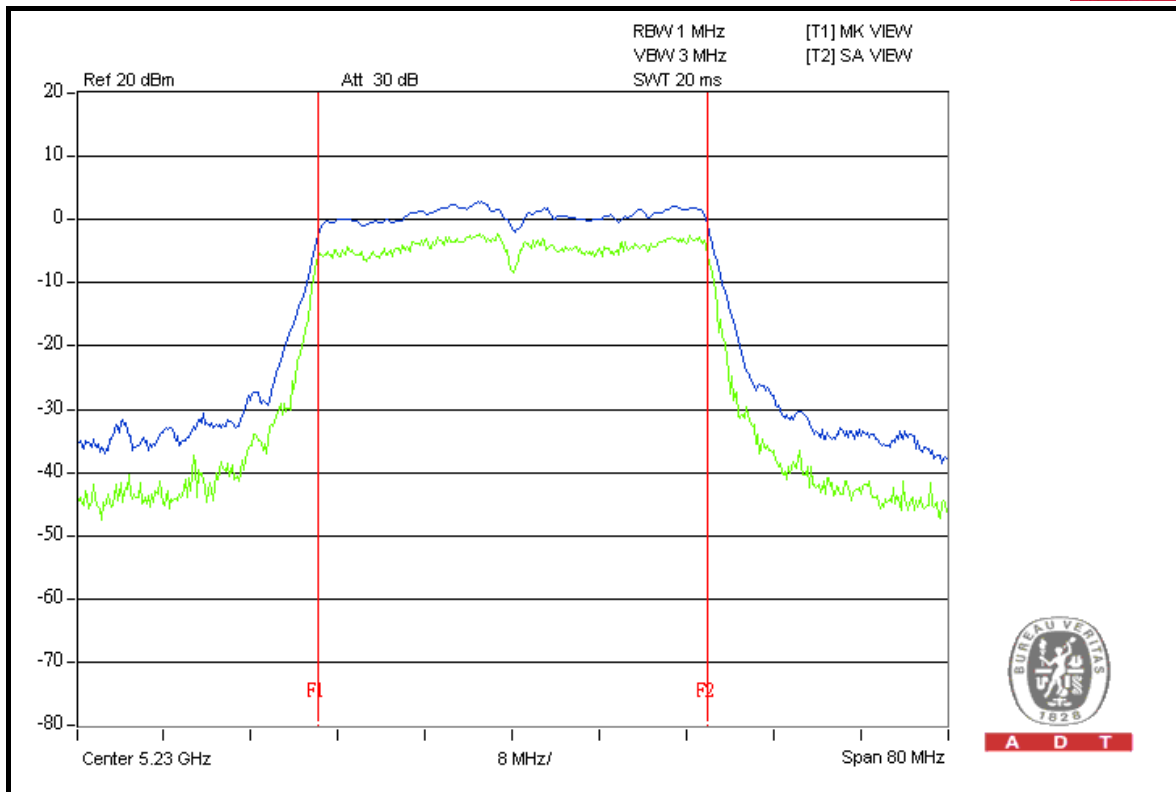

4.5 PEAK POWER SPECTRAL DENSITY MEASUREMENT

4.5.1 LIMITS OF PEAK POWER SPECTRAL DENSITY MEASUREMENT

FREQUENCY BAND	LIMIT
5.15 ~ 5.25GHz	4dBm

4.5.2 TEST INSTRUMENTS

DESCRIPTION & MANUFACTURER	MODEL NO.	SERIAL NO.	DATE OF CALIBRATION	CALIBRATED UNTIL
R&S SPECTRUM ANALYZER	FSP40	100041	Apr. 22, 2008	Apr. 21, 2009

NOTE: The calibration interval of the above test instruments is 12 months and the calibrations are traceable to NML/ROC and NIST/USA.

4.5.3 TEST PROCEDURES

- a. The transmitter output was connected to the spectrum analyzer.
- b. Set RBW = 1MHz, VBW = 3MHz. The PPSD is the highest level found across the emission in any 1MHz band.

4.5.4 DEVIATION FROM TEST STANDARD

No deviation.

4.5.5 TEST SETUP

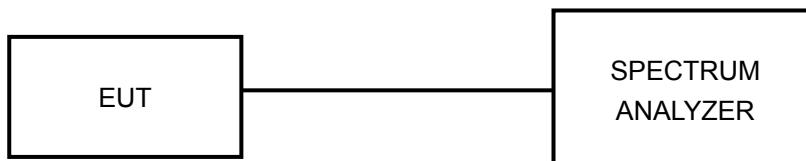

4.5.6 EUT OPERATING CONDITIONS

Same as 5.3.6.

4.5.7 TEST RESULTS

802.11a OFDM MODULATION

MODULATION TYPE	BPSK	TRANSFER RATE	6.0Mbps
INPUT POWER	120Vac, 60Hz	ENVIRONMENTAL CONDITIONS	24 deg.C, 64 %RH, 1021hPa
TESTED BY	Match Tsui		

CHAN.	CHAN. FREQ. (MHz)	RF POWER LEVEL IN 1MHz BW (dBm)		TOTAL POWER DENSITY (mW)	TOTAL POWER DENSITY (dBm)	MAX. LIMIT (dBm)	PASS / FAIL
		CHAIN 0	CHAIN 1				
36	5180	-4.61	-4.18	0.728	-1.38	4	PASS
40	5200	-4.76	-3.84	0.747	-1.27	4	PASS
48	5240	-5.09	-4.62	0.655	-1.84	4	PASS



A D T

FOR CHAIN 0: CH 36

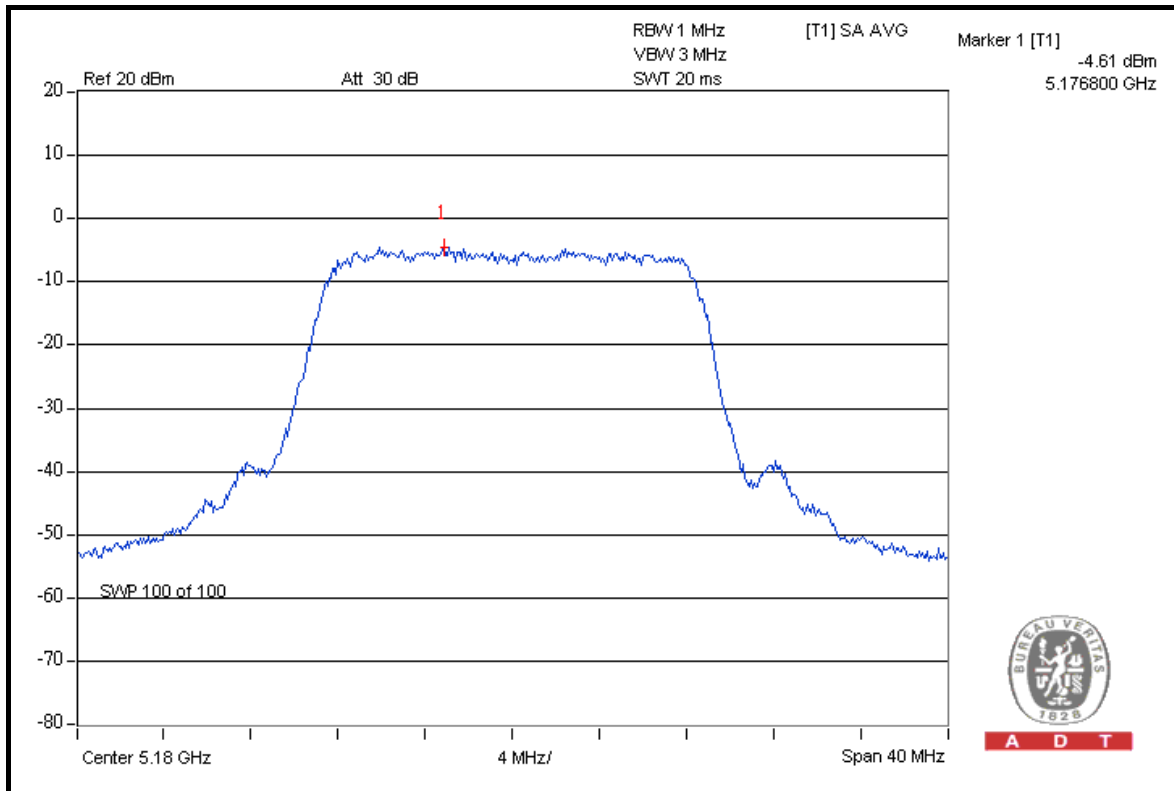

A D T

CH 40

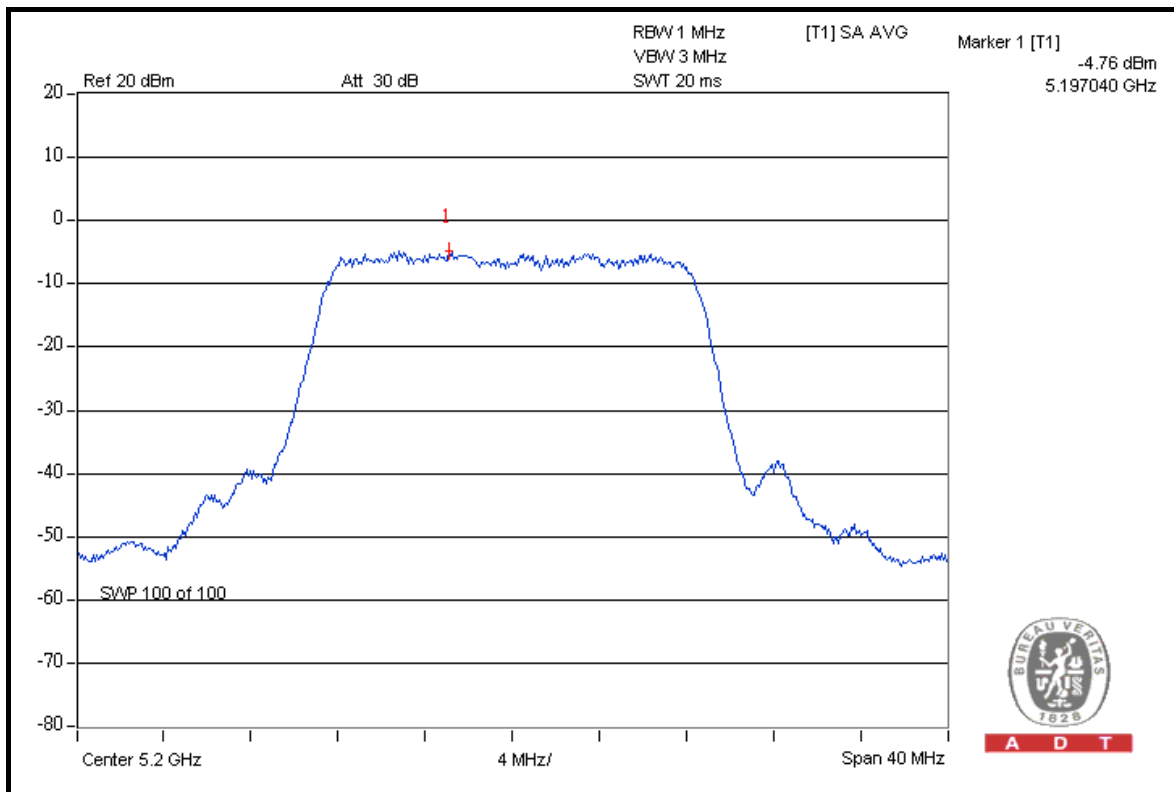

A D T



A D T

CH 48

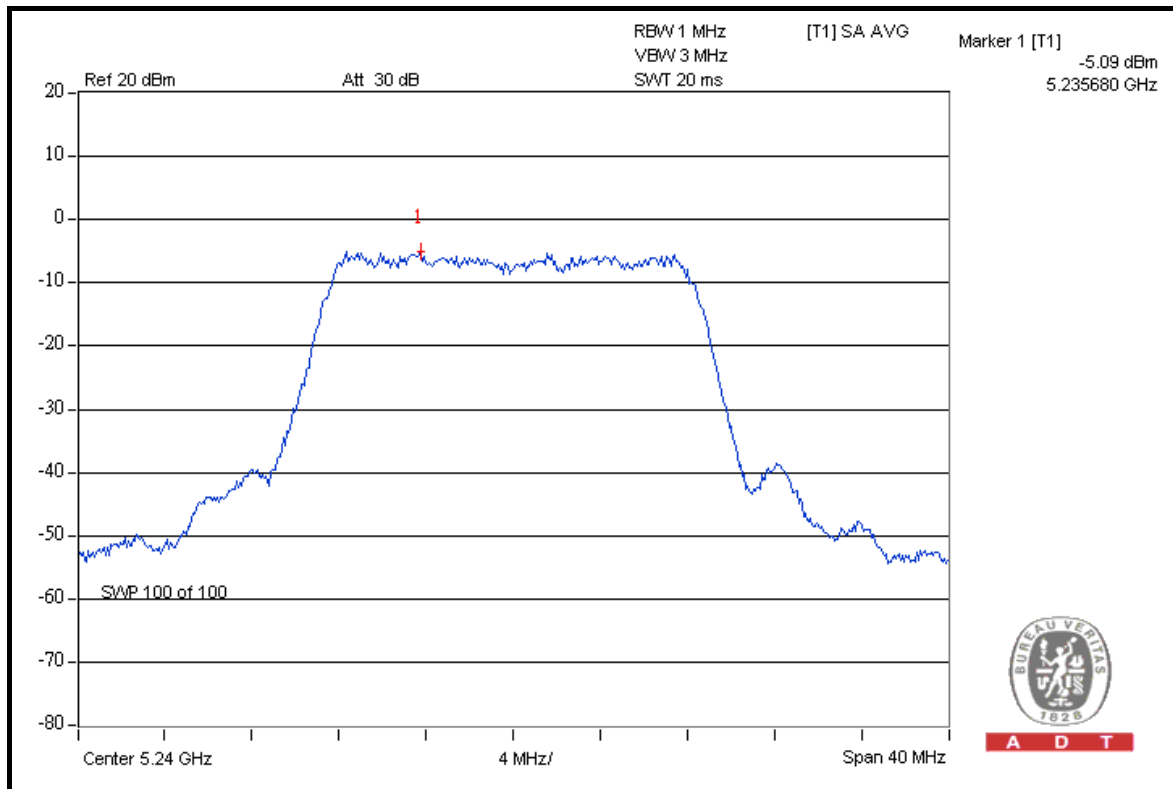

FOR CHAIN 1: CH 36

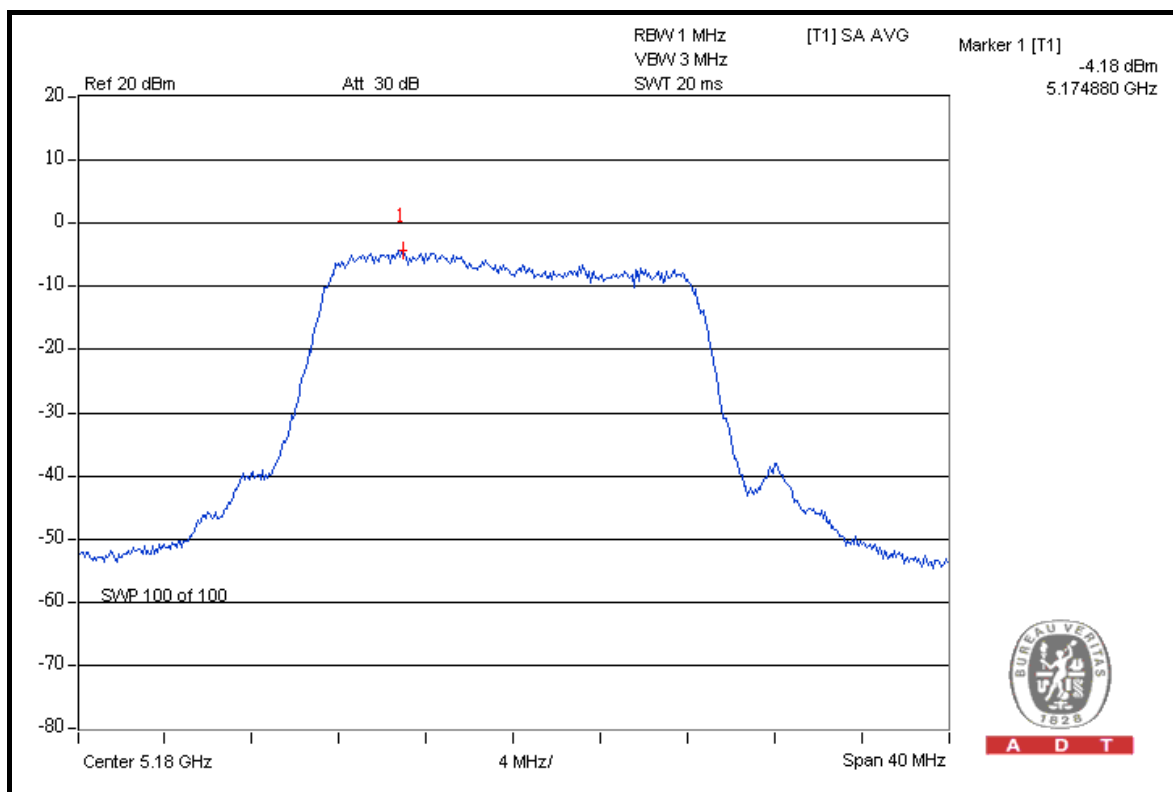

CH 40



A D T

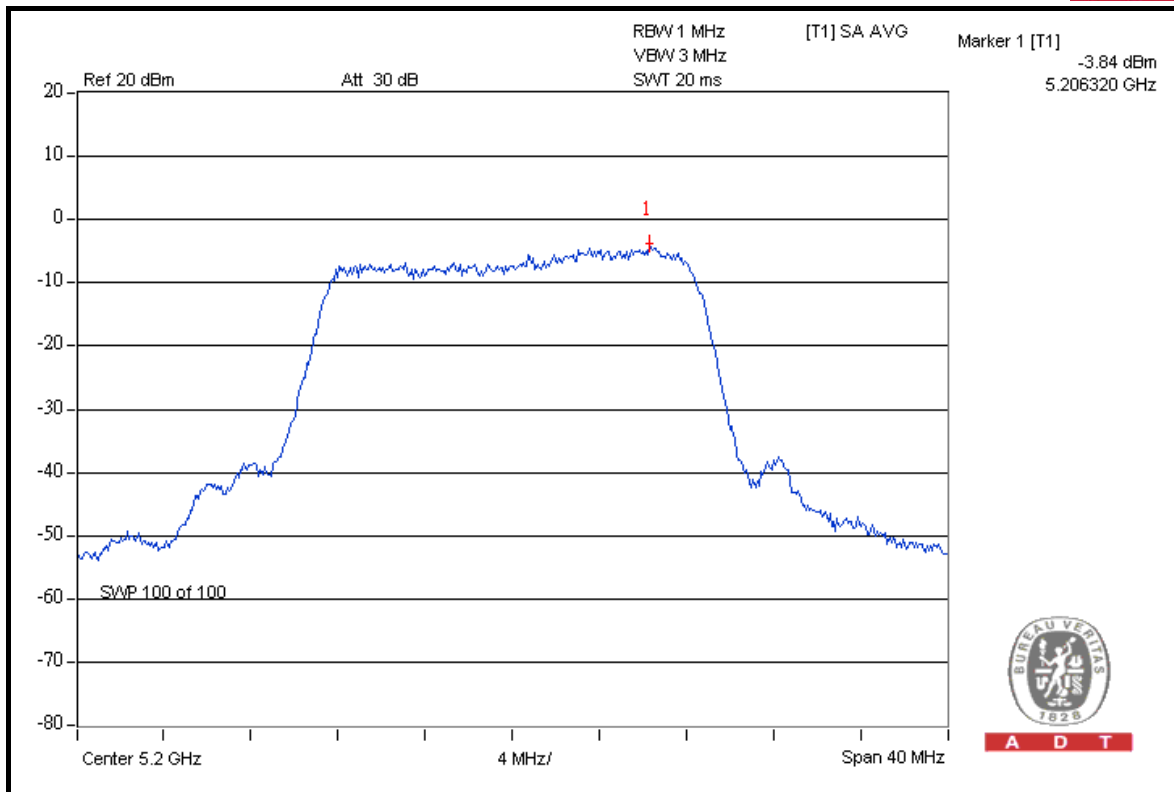

CH 48

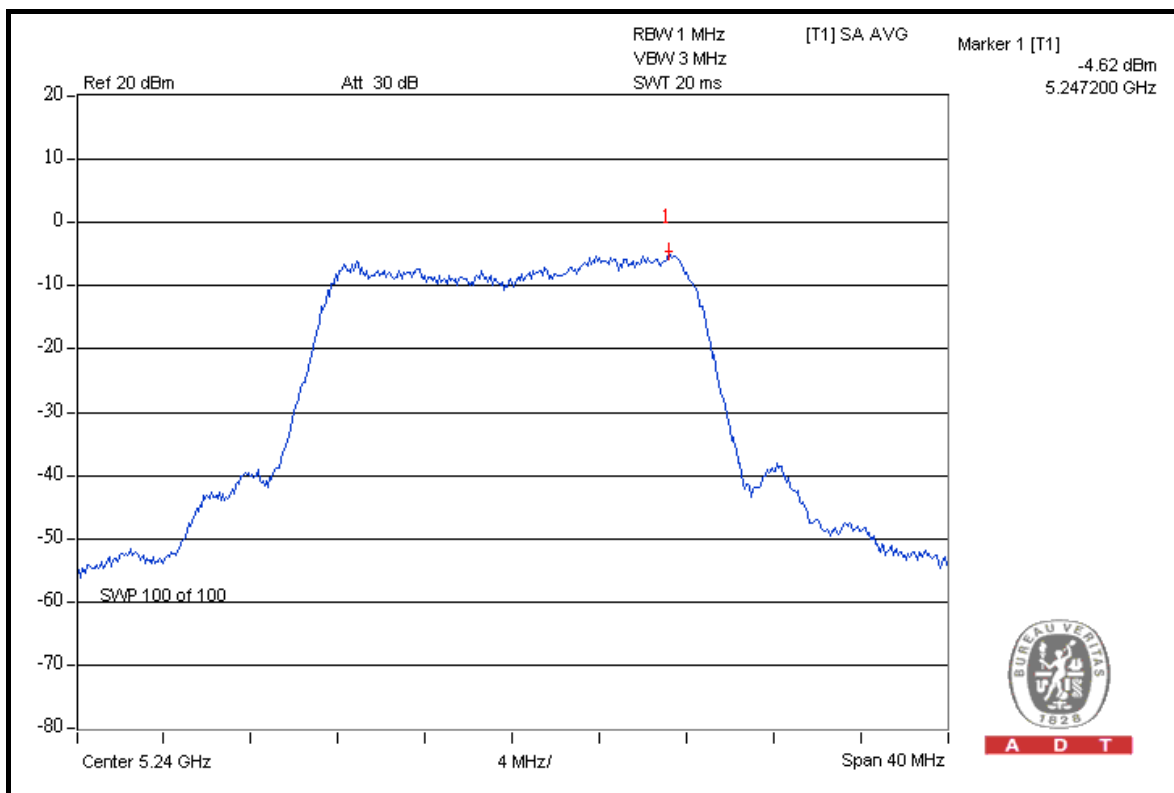

DRAFT 802.11n (20MHz) OFDM MODULATION



A D T

MODULATION TYPE	BPSK	TRANSFER RATE	7.2Mbps
INPUT POWER	120Vac, 60Hz	ENVIRONMENTAL CONDITIONS	24 deg.C, 64 %RH, 1021hPa
TESTED BY	Match Tsui		

CHAN.	CHAN. FREQ. (MHz)	RF POWER LEVEL IN 1MHz BW (dBm)		TOTAL POWER DENSITY (mW)	TOTAL POWER DENSITY (dBm)	MAX. LIMIT (dBm)	PASS / FAIL
		CHAIN 0	CHAIN 1				
36	5180	-4.39	-4.26	0.739	-1.31	4	PASS
40	5200	-4.58	-4.34	0.709	-1.49	4	PASS
48	5240	-4.53	-3.86	0.764	-1.17	4	PASS



A D T

FOR CHAIN 0: CH 36

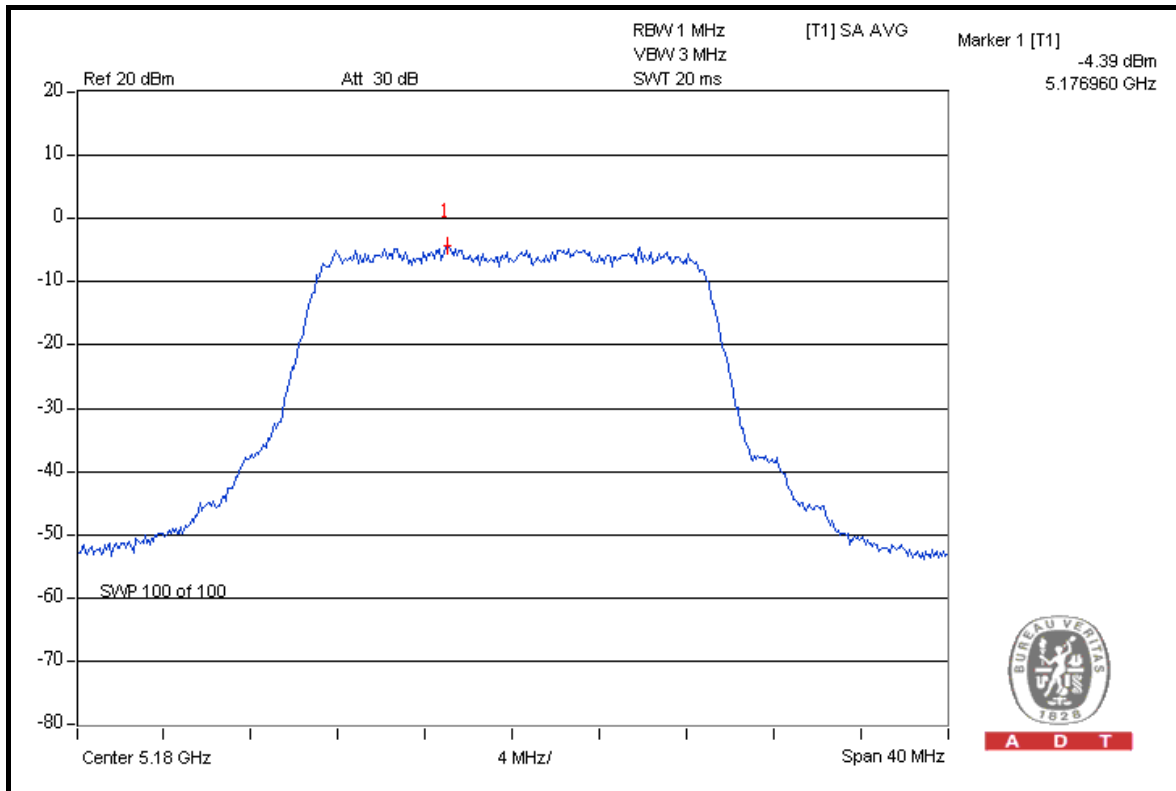

CH 40

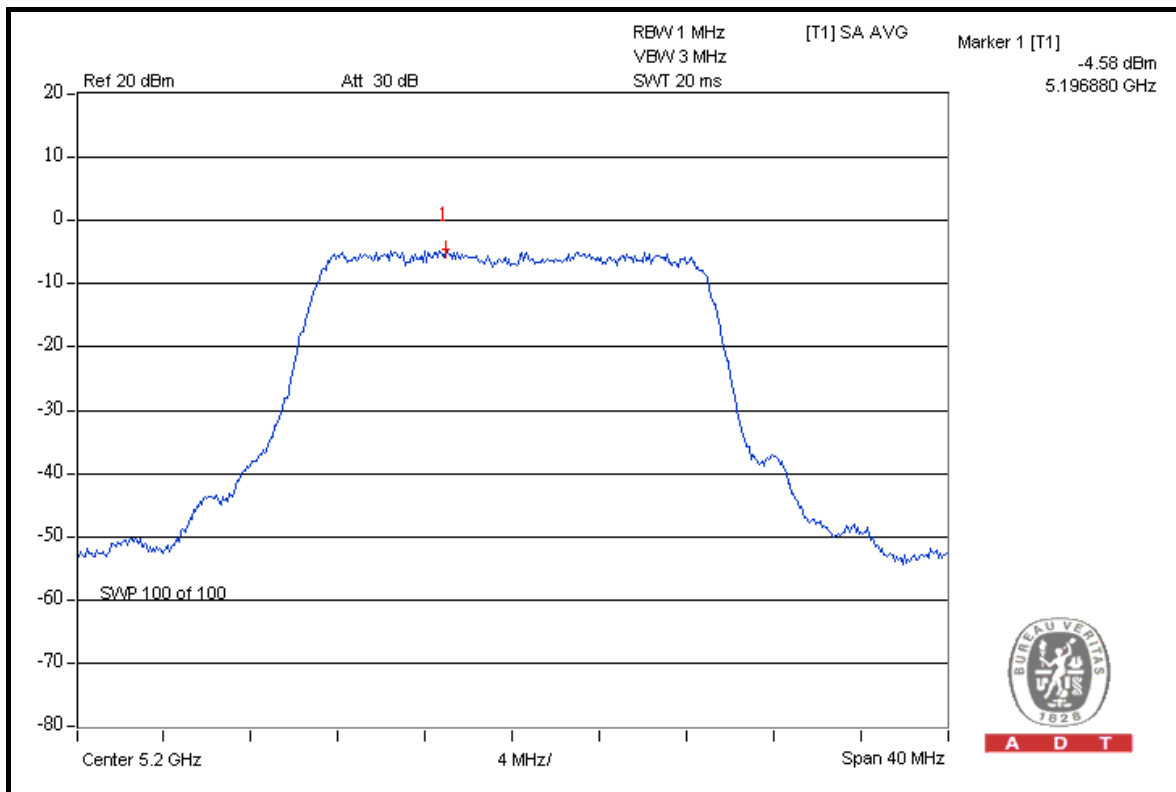



A D T

CH 48

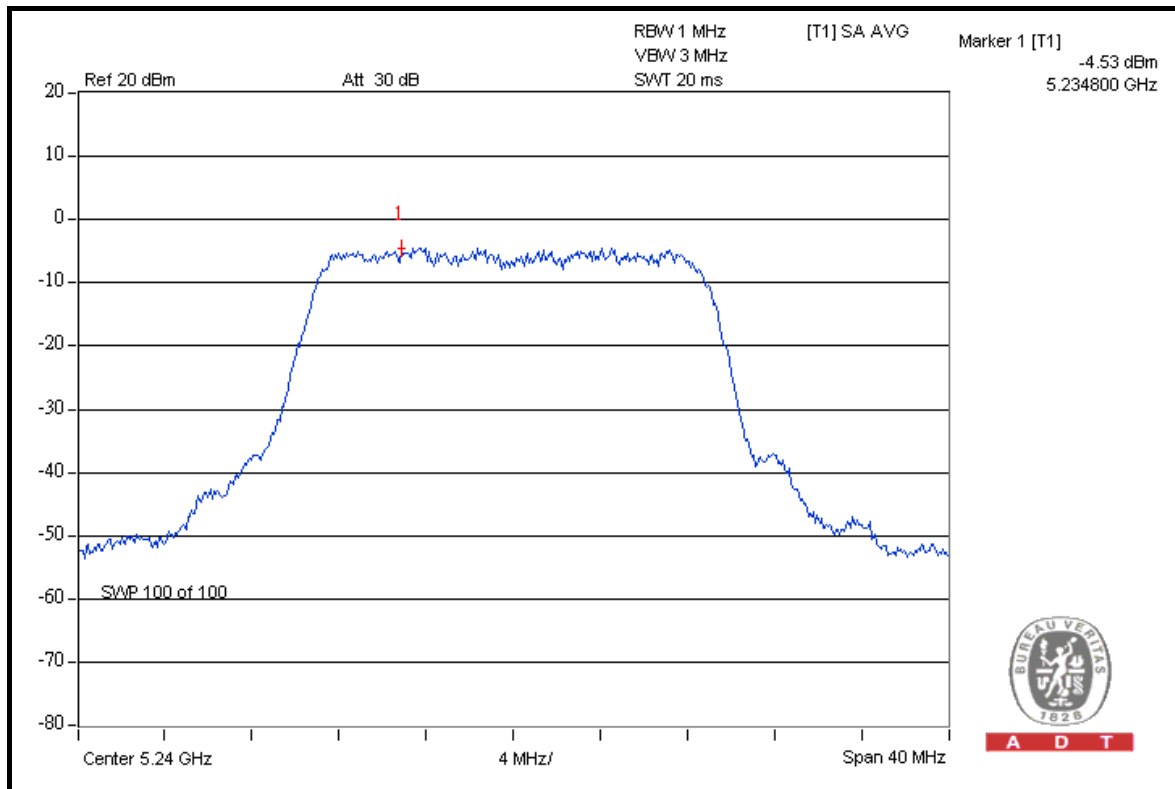

FOR CHAIN 1: CH 36

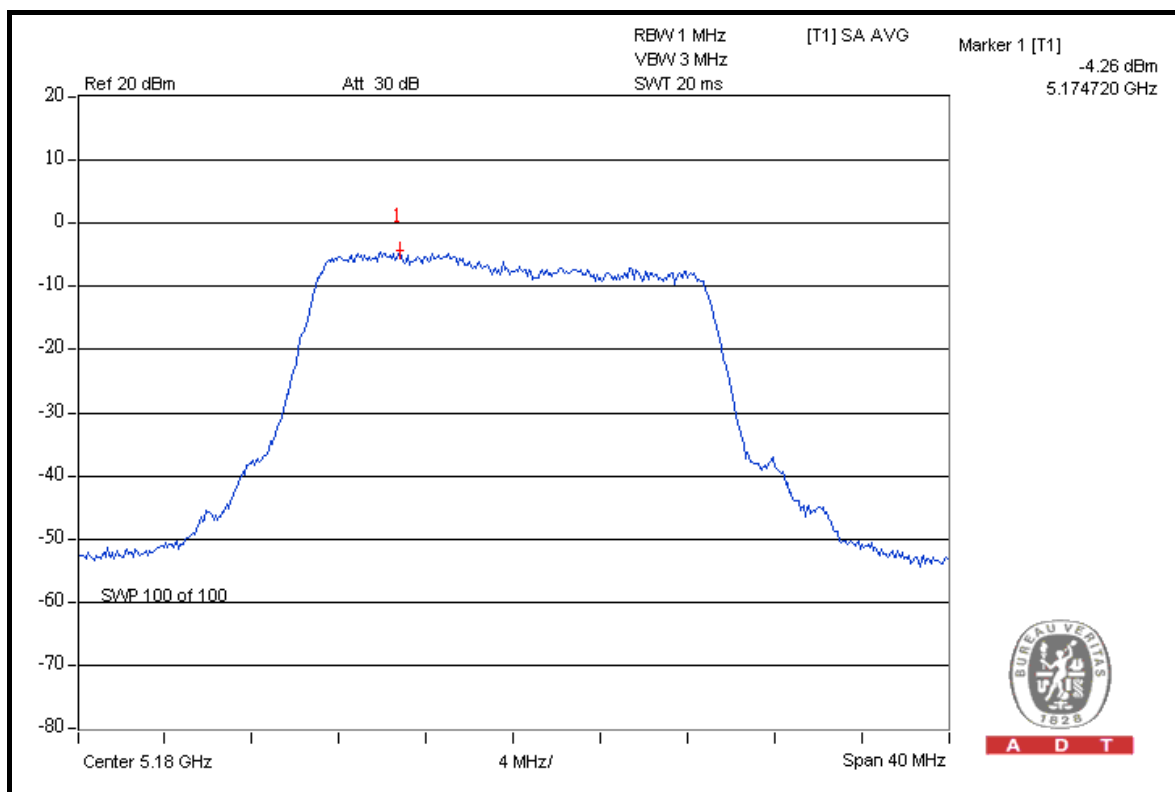

CH 40



A D T

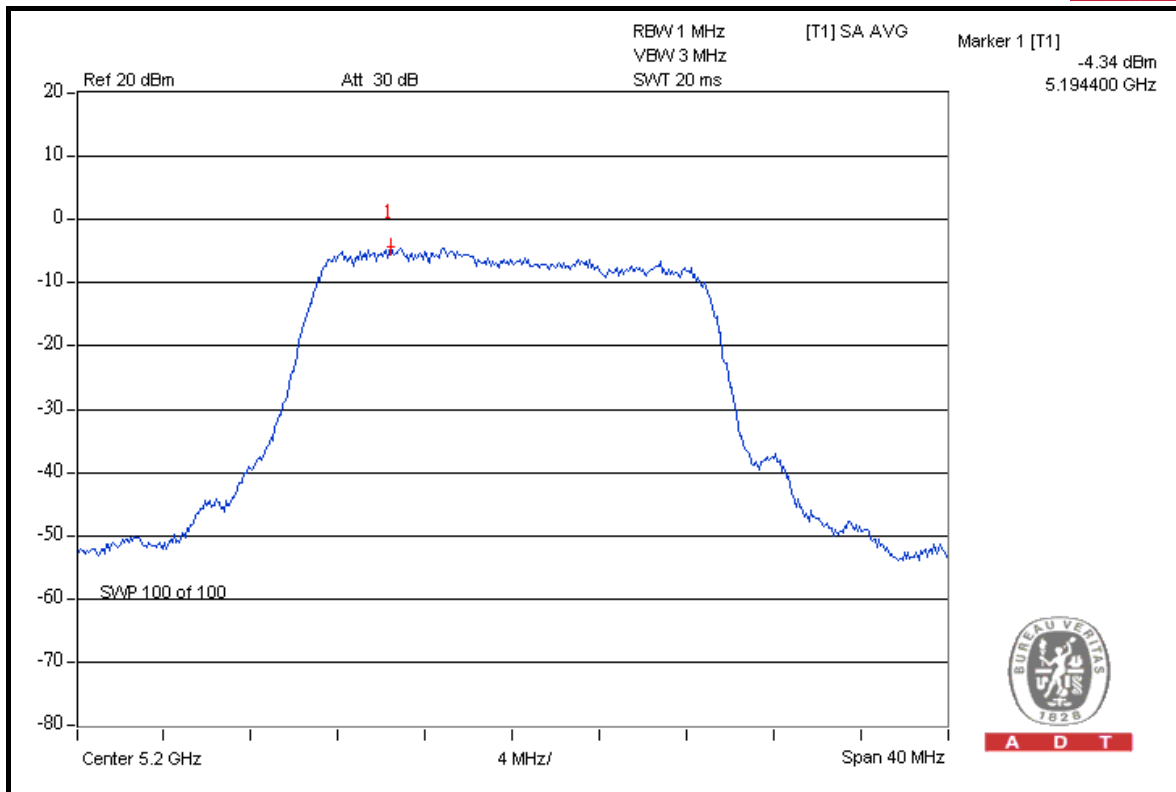

CH 48

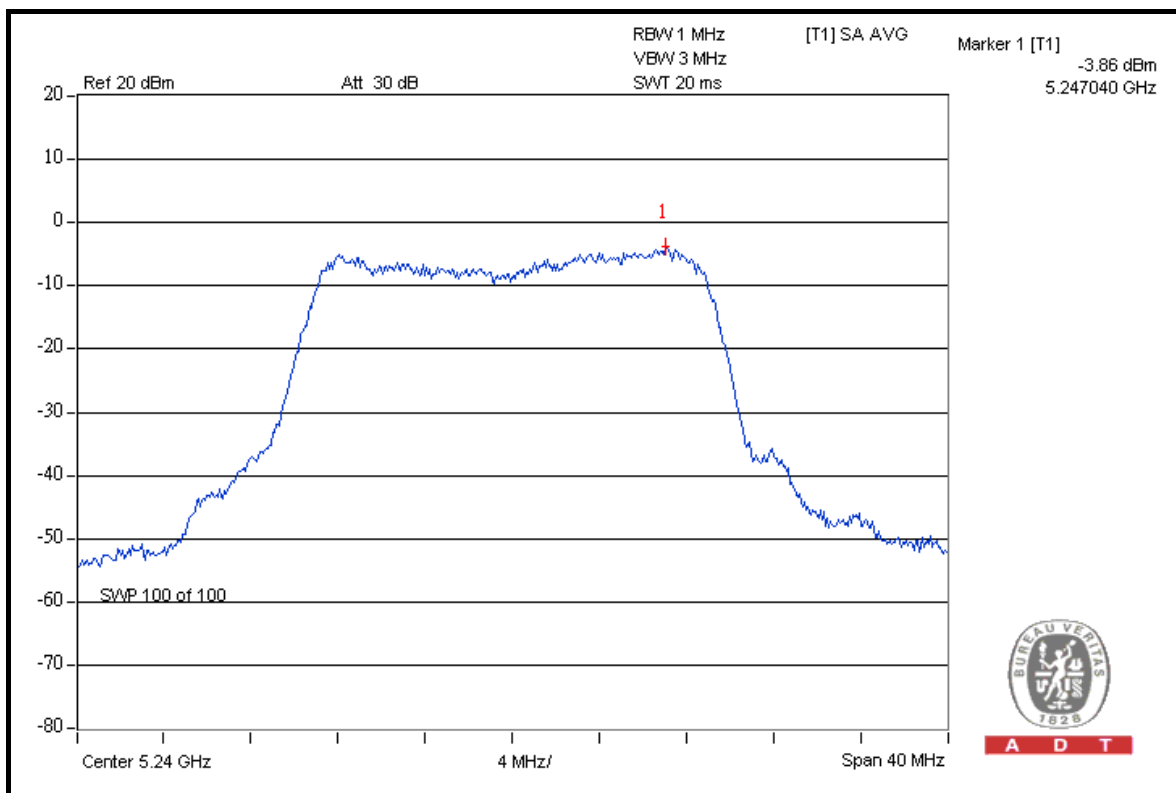



A D T

DRAFT 802.11n (40MHz) OFDM MODULATION

MODULATION TYPE	BPSK	TRANSFER RATE	15.0Mbps
INPUT POWER	120Vac, 60Hz	ENVIRONMENTAL CONDITIONS	24 deg.C, 64 %RH, 1021hPa
TESTED BY	Match Tsui		

CHAN.	CHAN. FREQ. (MHz)	RF POWER LEVEL IN 1MHz BW (dBm)		TOTAL POWER DENSITY (mW)	TOTAL POWER DENSITY (dBm)	MAX. LIMIT (dBm)	PASS / FAIL
		CHAIN 0	CHAIN 1				
38	5190	-7.91	-7.64	0.334	-4.76	4	PASS
46	5230	-7.66	-7.38	0.354	-4.51	4	PASS



A D T

FOR CHAIN 0: CH 38

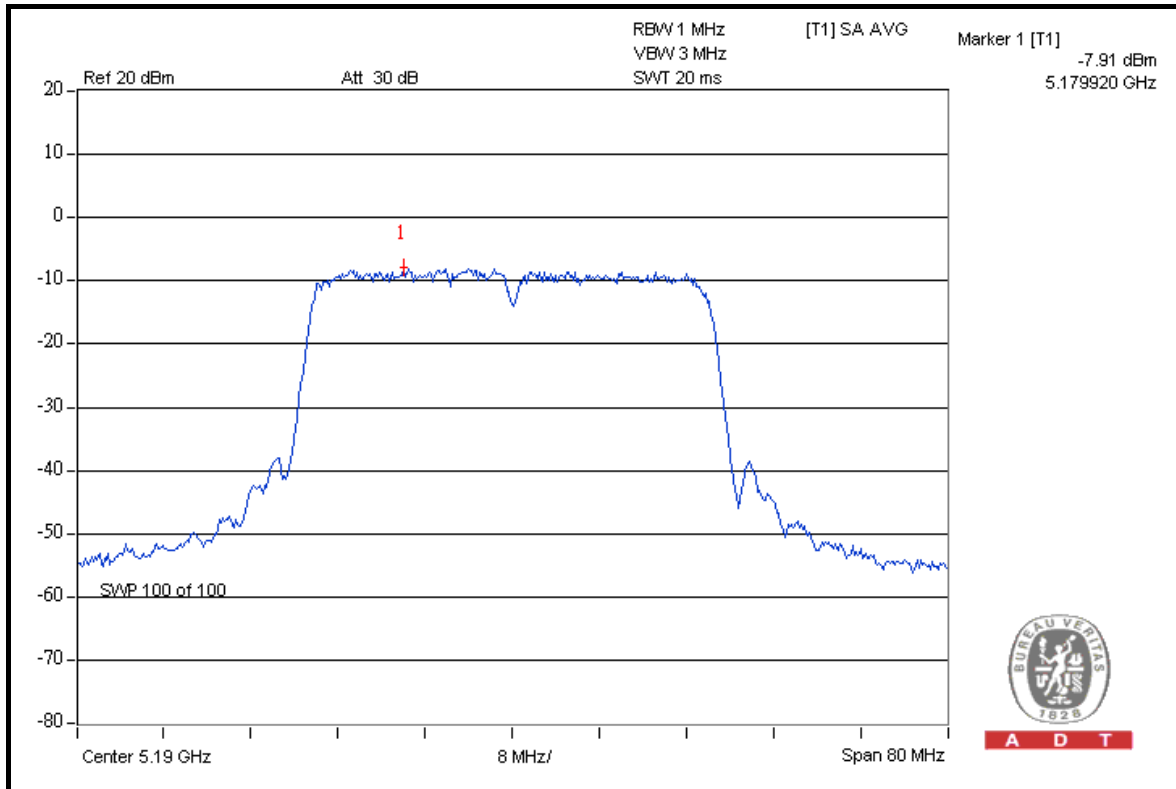

A D T

CH 46

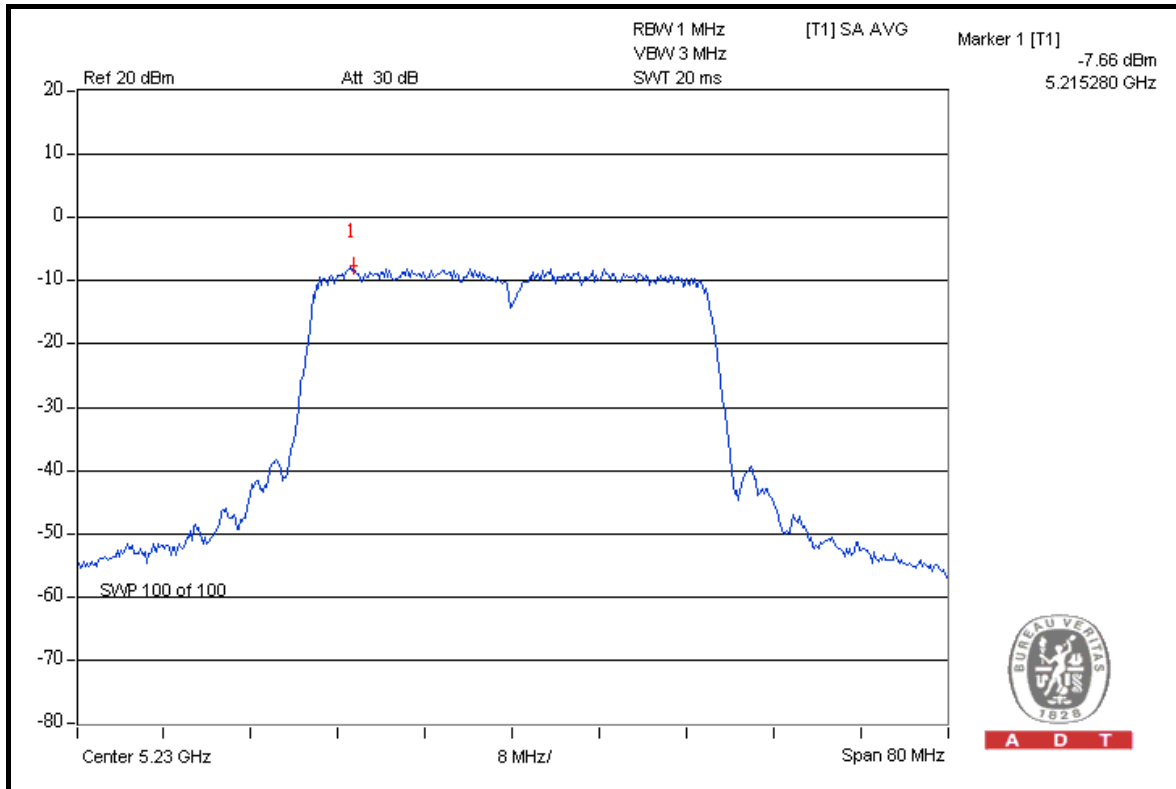

A D T



A D T

FOR CHAIN 1: CH 38

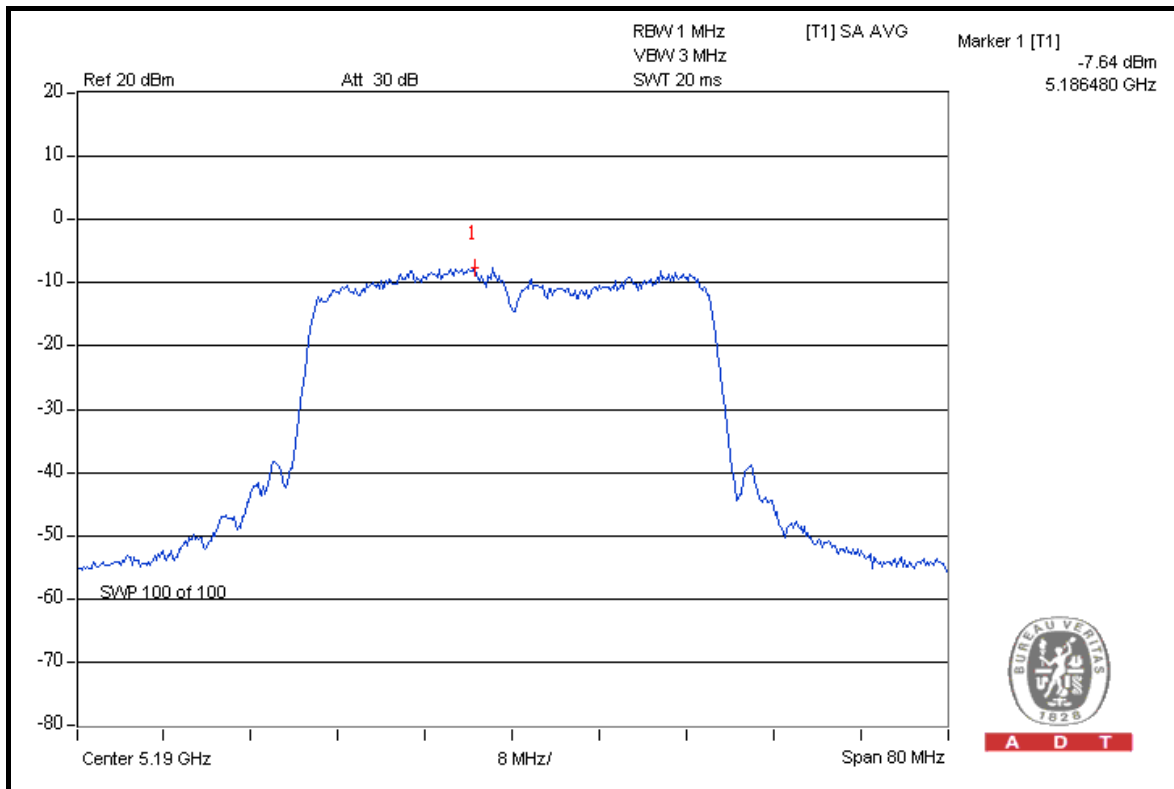

A D T

CH 46

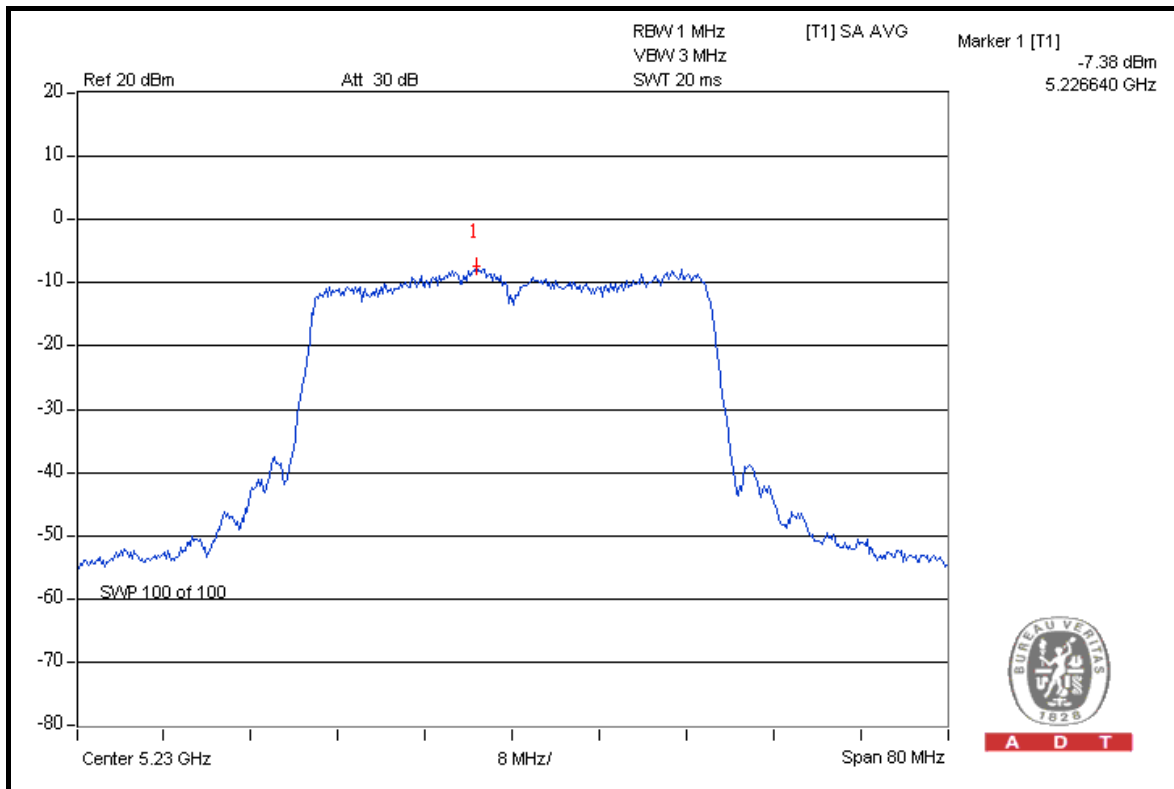

A D T



4.6 FREQUENCY STABILITY

4.6.1 LIMITS OF FREQUENCY STABILITY MEASUREMENT

The frequency tolerance of the carrier signal shall be maintained within +/- 0.02% of the operating frequency over a temperature variation of -30 degrees to 50 degrees C at normal supply voltage, and for a variation in the primary supply voltage from 85% to 115% of the rated supply voltage at a temperature of 20 degrees C.

4.6.2 TEST INSTRUMENTS

DESCRIPTION & MANUFACTURER	MODEL NO.	SERIAL NO.	DATE OF CALIBRATION	CALIBRATED UNTIL
ANRITSU SPECTRUM ANALYZER	FSP40	100041	Apr. 22, 2008	Apr. 21, 2009
WIT STANDARD TEMPERATURE AND HUMIDITY CHAMBER	TH-4S-C	W981030	Jun. 28, 2008	Jun. 27, 2009

NOTE: The calibration interval of the above test instruments is 12 months and the calibrations are traceable to NML/ROC and NIST/USA.

4.6.3 TEST PROCEDURE

- a. The EUT was placed inside the environmental test chamber and powered by nominal DC voltage.
- b. Turn the EUT on and couple its output to a spectrum analyzer.
- c. Turn the EUT off and set the chamber to the highest temperature specified.
- d. Allow sufficient time (approximately 30 min) for the temperature of the chamber to stabilize, turn the EUT on and measure the operating frequency after 2, 5, and 10 minutes.
- e. Repeat step 2 and 3 with the temperature chamber set to the lowest temperature.
- f. The test chamber was allowed to stabilize at +20 degree C for a minimum of 30 minutes. The supply voltage was then adjusted on the EUT from 85% to 115% and the frequency record.

4.6.4 DEVIATION FROM TEST STANDARD

No deviation.

4.6.5 TEST SETUP

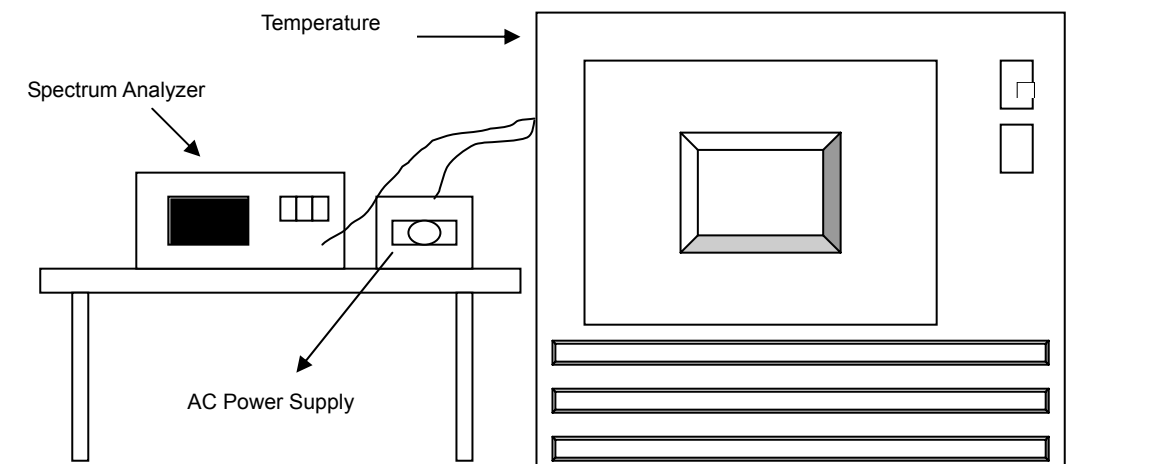

4.6.6 EUT OPERATING CONDITION

Same as Item 4.1.6.

4.6.7 TEST RESULTS

OPERATING FREQUENCY: 5200MHz						LIMIT: ± 0.01%			
TEMP. (°C)	POWER SUPPLY (Vac)	0 MINUTE		2 MINUTE		5 MINUTE		10 MINUTE	
		(MHz)	(%)	(MHz)	(%)	(MHz)	(%)	(MHz)	(%)
50	126.5	5199.998905	-0.0000211	5199.998940	-0.0000204	5199.998974	-0.0000197	5199.998779	-0.0000235
	110.0	5199.983542	-0.0003165	5199.983602	-0.0003153	5199.983672	-0.0003140	5199.983847	-0.0003106
	93.5	5199.986645	-0.0002568	5199.986584	-0.0002580	5199.986400	-0.0002615	5199.986309	-0.0002633
40	126.5	5199.978766	-0.0004083	5199.978826	-0.0004072	5199.978760	-0.0004085	5199.978575	-0.0004120
	110.0	5199.985188	-0.0002848	5199.985222	-0.0002842	5199.985406	-0.0002807	5199.985361	-0.0002815
	93.5	5199.996807	-0.0000614	5199.996605	-0.0000653	5199.996590	-0.0000656	5199.996666	-0.0000641
30	126.5	5199.980142	-0.0003819	5199.980054	-0.0003836	5199.979846	-0.0003876	5199.979732	-0.0003898
	110.0	5199.986356	-0.0002624	5199.986480	-0.0002600	5199.986553	-0.0002586	5199.986506	-0.0002595
	93.5	5200.004450	0.0000856	5200.004328	0.0000832	5200.004524	0.0000870	5200.004783	0.0000920
20	126.5	5199.986799	-0.0002539	5199.986768	-0.0002545	5199.986714	-0.0002555	5199.986829	-0.0002533
	110.0	5199.987476	-0.0002408	5199.987357	-0.0002431	5199.987187	-0.0002464	5199.987159	-0.0002469
	93.5	5200.011645	0.0002239	5200.011498	0.0002211	5200.011721	0.0002254	5200.011606	0.0002232
10	126.5	5199.994627	-0.0001033	5199.994871	-0.0000986	5199.994816	-0.0000997	5199.994872	-0.0000986
	110.0	5200.002785	0.0000536	5200.002973	0.0000572	5200.002742	0.0000527	5200.002519	0.0000484
	93.5	5200.017874	0.0003437	5200.018092	0.0003479	5200.018050	0.0003471	5200.018244	0.0003508
0	126.5	5199.997525	-0.0000476	5199.997543	-0.0000472	5199.997710	-0.0000440	5199.997857	-0.0000412
	110.0	5200.010104	0.0001943	5200.009931	0.0001910	5200.010176	0.0001957	5200.010311	0.0001983
	93.5	5200.024155	0.0004645	5200.024126	0.0004640	5200.023937	0.0004603	5200.023679	0.0004554
-10	126.5	5200.009861	0.0001896	5200.009913	0.0001906	5200.009826	0.0001890	5200.009948	0.0001913
	110.0	5200.016093	0.0003095	5200.016163	0.0003108	5200.016007	0.0003078	5200.016029	0.0003083
	93.5	5200.030891	0.0005941	5200.030864	0.0005935	5200.030925	0.0005947	5200.030611	0.0005887
-20	126.5	5200.015584	0.0002997	5200.015580	0.0002996	5200.015258	0.0002934	5200.014961	0.0002877
	110.0	5200.020513	0.0003945	5200.020545	0.0003951	5200.020701	0.0003981	5200.020855	0.0004011
	93.5	5200.035312	0.0006791	5200.035366	0.0006801	5200.035545	0.0006836	5200.035662	0.0006858
-30	126.5	5200.020845	0.0004009	5200.020729	0.0003986	5200.020633	0.0003968	5200.020418	0.0003927
	110.0	5200.034872	0.0006706	5200.034792	0.0006691	5200.034716	0.0006676	5200.034713	0.0006676
	93.5	5200.037483	0.0007208	5200.037440	0.0007200	5200.037507	0.0007213	5200.037245	0.0007163

4.7 BAND EDGES MEASUREMENT

4.7.1 TEST INSTRUMENTS

DESCRIPTION & MANUFACTURER	MODEL NO.	SERIAL NO.	DATE OF CALIBRATION	DUE DATE OF CALIBRATION
Test Receiver ROHDE & SCHWARZ	ESIB7	100212	May 28, 2008	May 27, 2009
Spectrum Analyzer ROHDE & SCHWARZ	FSP40	100269	Aug. 08, 2008	Aug. 07, 2009
BILOG Antenna SCHWARZBECK	VULB9168	9168-156	Apr. 25, 2008	Apr. 24, 2009
HORN Antenna SCHWARZBECK	BBHA 9120 D	9120D-563	Aug. 06, 2008	Aug. 05, 2009
HORN Antenna SCHWARZBECK	BBHA 9170	BBHA9170148	Jul. 03, 2008	Jul. 02, 2009
Preamplifier Agilent	8449B	3008A01911	Sep. 10, 2008	Sep. 09, 2009
Preamplifier Agilent	8447D	2944A10638	Dec. 26, 2008	Dec. 25, 2009
RF signal cable HUBER+SUHNNER	SUCOFLEX 104	218190/4 231241/4	May 20, 2008	May 19, 2009
RF signal cable Worken	8D-FB	Cable-HYCH9-01	Aug. 09, 2008	Aug. 08, 2009
Software	ADT_Radiated_ V7.6.15.9.2	NA	NA	NA
Antenna Tower EMCO	2070/2080	512.835.4684	NA	NA
Turn Table EMCO	2087-2.03	NA	NA	NA
Antenna Tower & Turn Table Controller EMCO	2090	NA	NA	NA
26GHz ~ 40GHz Amplifier	EM26400	07026401	Aug. 27, 2008	Aug. 26, 2009

- NOTE:**
1. The calibration interval of the above test instruments is 12 months and the calibrations are traceable to NML/ROC and NIST/USA.
 2. The test was performed in HwaYa Chamber 9.
 3. The horn antenna and HP preamplifier (model: 8449B) are used only for the measurement of emission frequency above 1GHz if tested.
 4. The FCC Site Registration No. is 460141.
 5. The IC Site Registration No. is IC 7450F-4.

4.7.2 TEST PROCEDURE

- a. The EUT was placed on the top of a rotating table 0.8 meters above the ground at a 3 meter semi-anechoic chamber. The table was rotated 360 degrees to determine the position of the highest radiation.
- b. The EUT was set 3 meters away from the interference-receiving antenna, which was mounted on the top of a variable-height antenna tower.
- c. The antenna is a broadband antenna, and its height is varied from one meter to four meters above the ground to determine the maximum value of the field strength. Both horizontal and vertical polarizations of the antenna are set to make the measurement.
- d. For each suspected emission, the EUT was arranged to its worst case and then the antenna was tuned to heights from 1 meter to 4 meters and the rotatable table was turned from 0 degrees to 360 degrees to find the maximum reading.
- e. Set both RBW and VBW of spectrum analyzer to 1MHz and 3MHz with suitable frequency span including 100MHz bandwidth from band edge. The band edges was measured and recorded.

NOTE: The resolution bandwidth of test receiver/spectrum analyzer is 1MHz and the video bandwidth is 10Hz for Average detection (AV) at frequency above 1GHz

4.7.3 EUT OPERATING CONDITION

The software provided by client to enable the EUT under transmission condition continuously at specific channel frequencies individually.

4.7.4 TEST RESULTS

For signals in the restricted bands above and below the 5.15 to 5.25GHz allocated band a measurement was made of the amplitude of the spurious emissions with respect to the intentional signals. The relative amplitude, in dBc, was applied to the average and peak field strength of the intentional signal made on the OATS to calculate the field strength of the unintentional signals.

The spectrum plots (Peak RBW = 1MHz, VBW = 3MHz) are attached on the following pages.

802.11a OFDM MODULATION

Channel 36 (5180MHz)

The band edge emission plot on the next page shows 43.65dBc between carrier maximum power and local maximum emission in restrict band. The emission of carrier strength list in the test result of channel 36 is 107.52dBuV/m (Peak), so the maximum field strength in restrict band is $107.52 - 43.65 = 63.87$ dBuV/m which is under 74dBuV/m limit.

The band edge emission plot on the next page shows 48.12dBc between carrier maximum power and local maximum emission in restrict band. The emission of carrier strength list in the test result of channel 36 is 97.39dBuV/m (Average), so the maximum field strength in restrict band is $97.39 - 48.12 = 49.27$ dBuV/m which is under 54dBuV/m limit.

Channel 48 (5240MHz)

The band edge emission plot on the next second page shows 46.58dBc between carrier maximum power and local maximum emission in restrict band. The emission of carrier strength list in the test result of channel 48 is 107.12dBuV/m (Peak), so the maximum field strength in restrict band is $107.12 - 46.58 = 60.54$ dBuV/m which is under 74dBuV/m limit.

The band edge emission plot on the next third page shows 49.85dBc between carrier maximum power and local maximum emission in restrict band. The emission of carrier strength list in the test result of channel 48 is 97.32dBuV/m (Average), so the maximum field strength in restrict band is $97.32 - 49.85 = 47.47$ dBuV/m which is under 54dBuV/m limit.



A D T

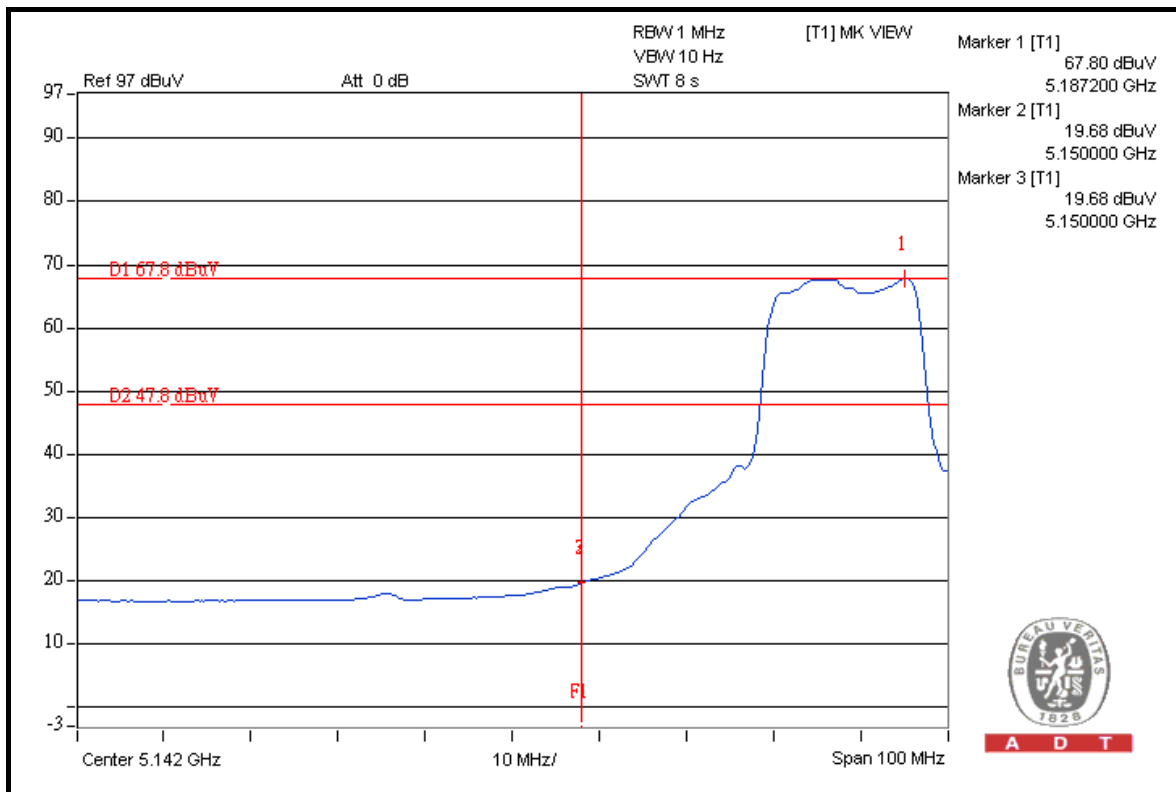
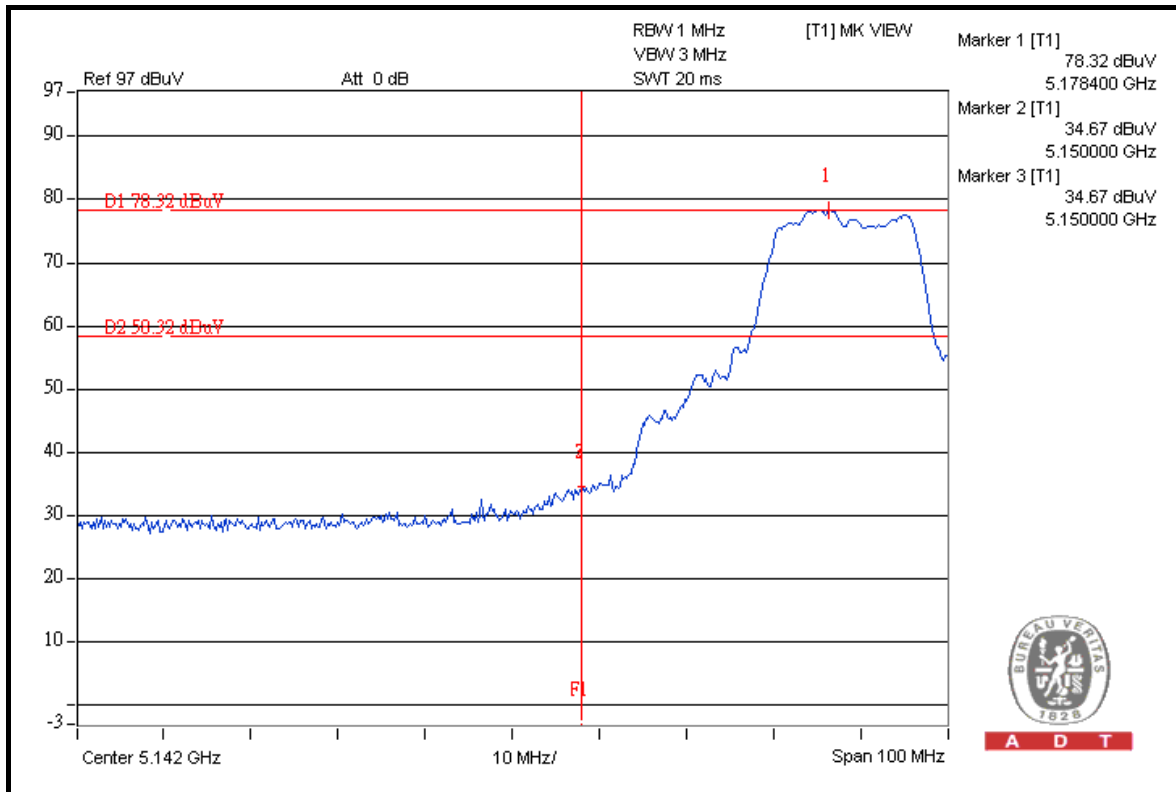



A D T

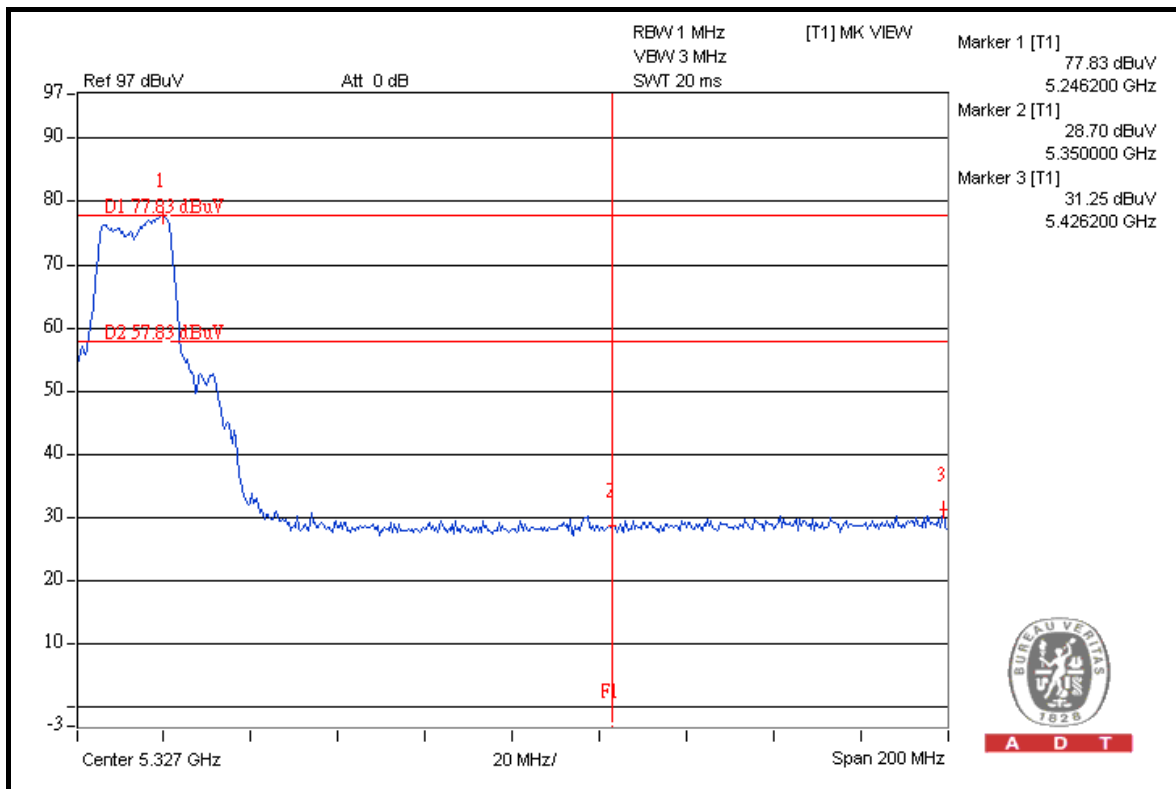
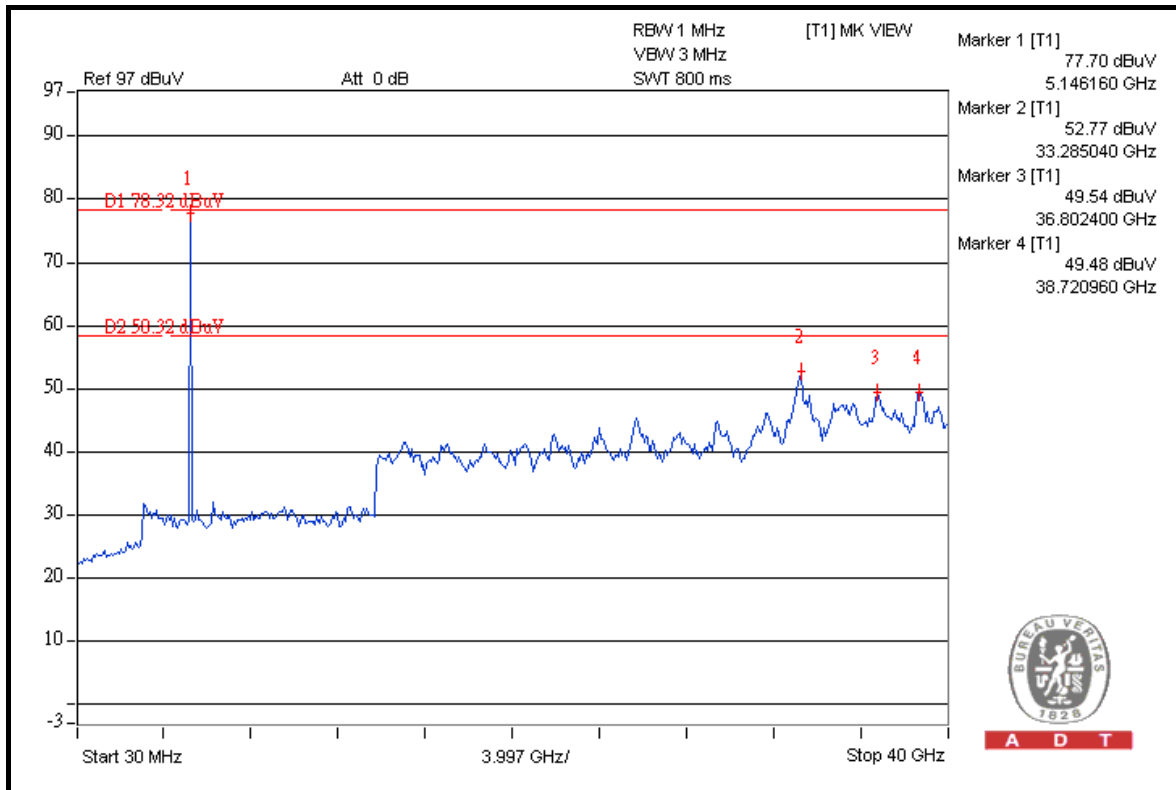



A D T

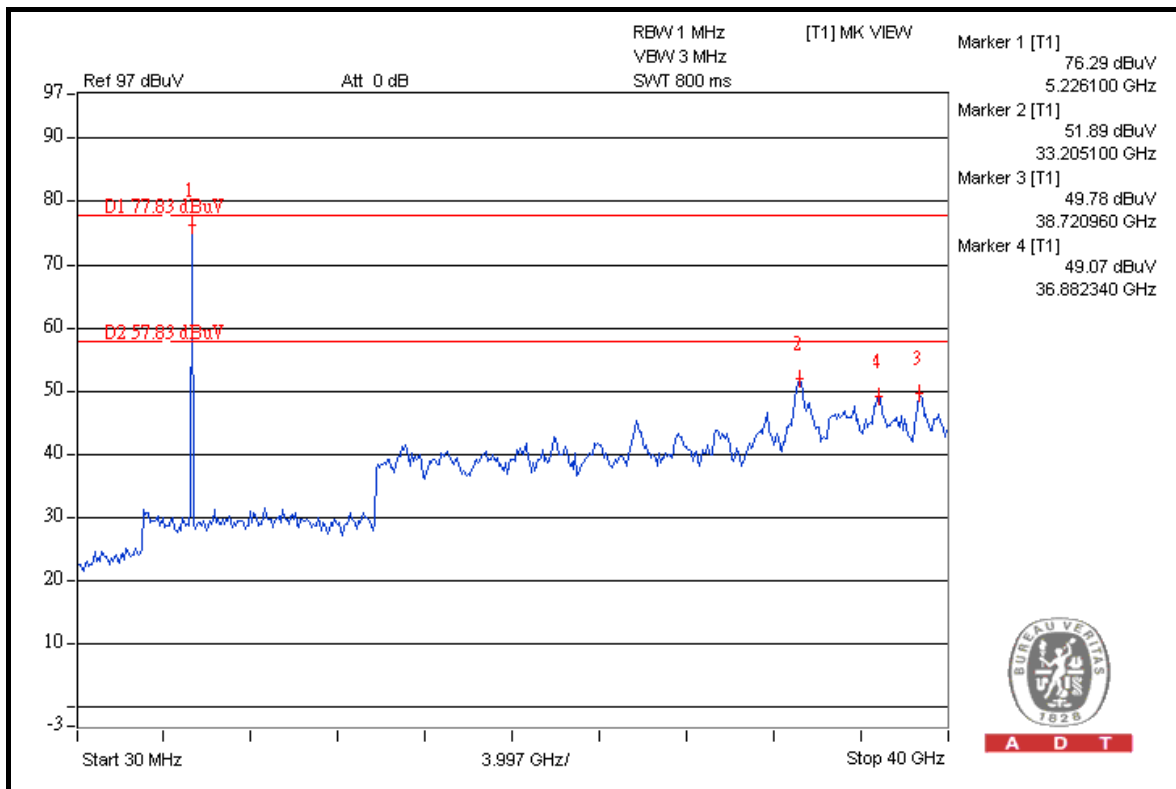
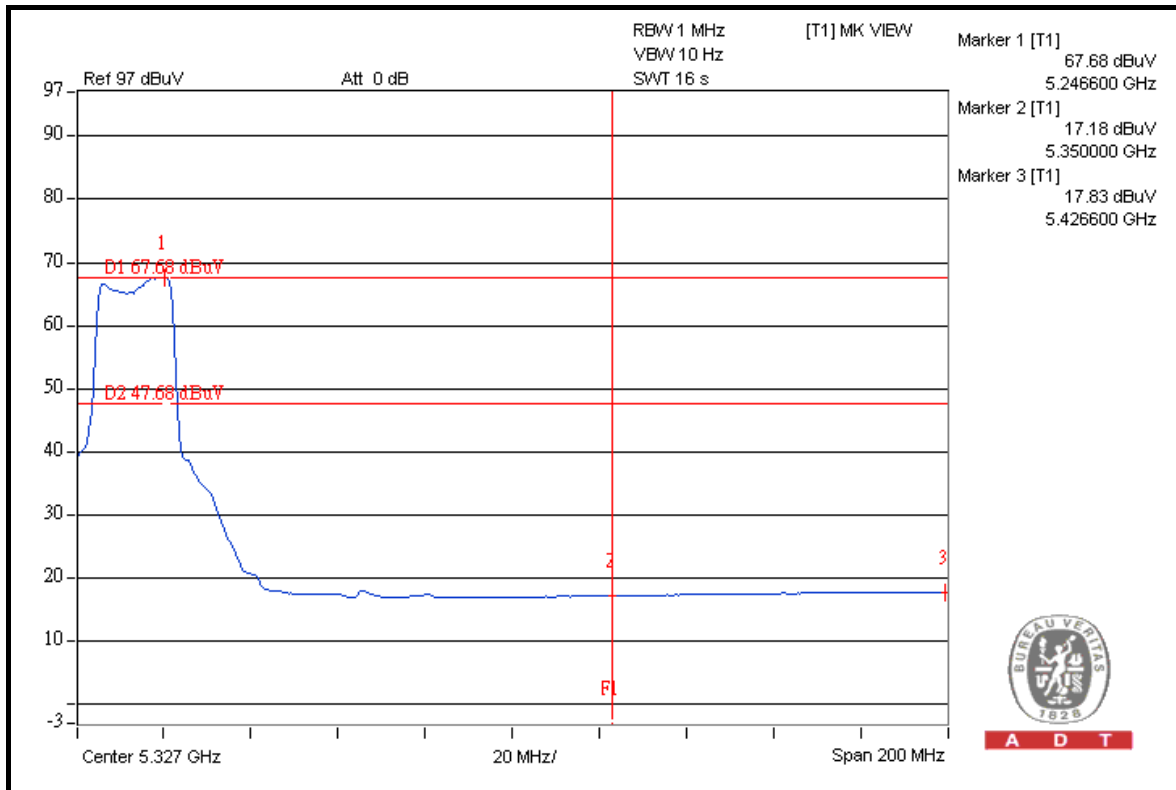

DRAFT 802.11n (20MHz) OFDM MODULATION

Channel 36 (5180MHz)

The band edge emission plot on the next page shows 42.37dBc between carrier maximum power and local maximum emission in restrict band. The emission of carrier strength list in the test result of channel 36 is 106.20dBuV/m (Peak), so the maximum field strength in restrict band is $106.20 - 42.37 = 63.83$ dBuV/m which is under 74dBuV/m limit.

The band edge emission plot on the next page shows 48.57dBc between carrier maximum power and local maximum emission in restrict band. The emission of carrier strength list in the test result of channel 36 is 96.36dBuV/m (Average), so the maximum field strength in restrict band is $96.36 - 48.57 = 47.79$ dBuV/m which is under 54dBuV/m limit.

Channel 48 (5240MHz)

The band edge emission plot on the next second page shows 46.60dBc between carrier maximum power and local maximum emission in restrict band. The emission of carrier strength list in the test result of channel 48 is 107.51dBuV/m (Peak), so the maximum field strength in restrict band is $107.51 - 46.60 = 60.91$ dBuV/m which is under 74dBuV/m limit.

The band edge emission plot on the next third page shows 49.64dBc between carrier maximum power and local maximum emission in restrict band. The emission of carrier strength list in the test result of channel 48 is 97.33dBuV/m (Average), so the maximum field strength in restrict band is $97.33 - 49.64 = 47.69$ dBuV/m which is under 54dBuV/m limit.



A D T

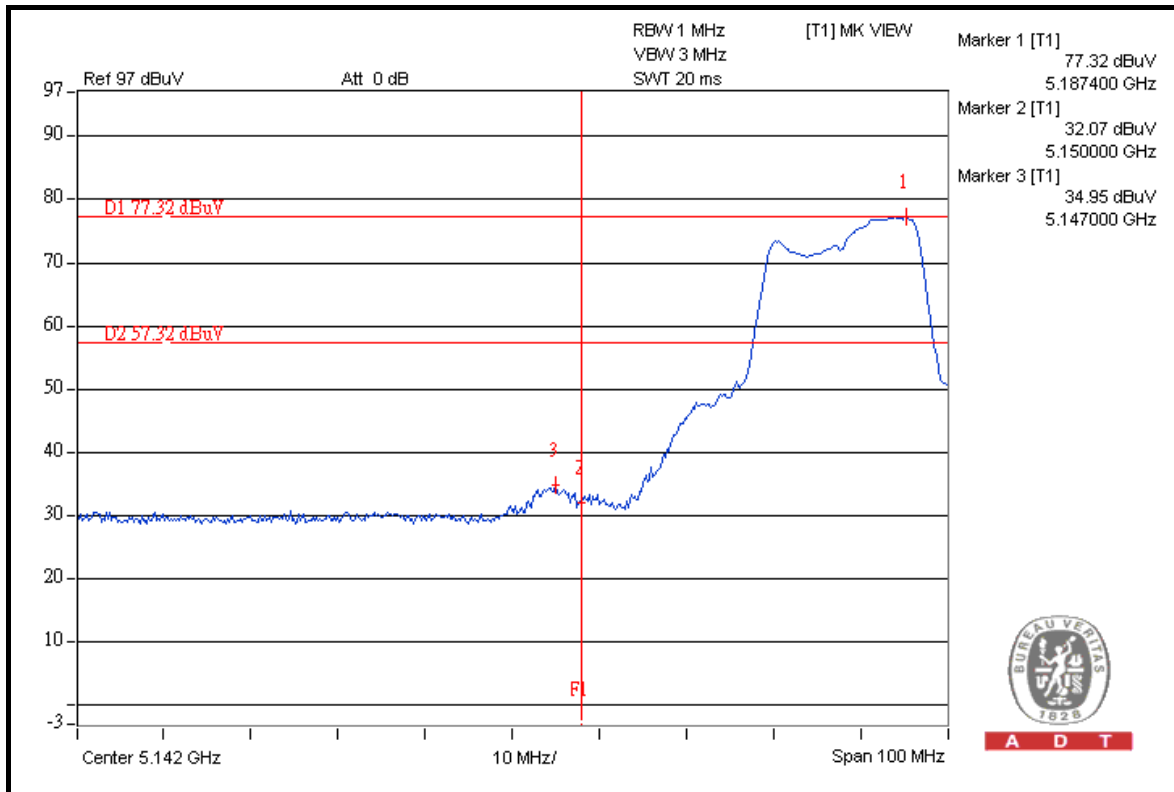

A D T

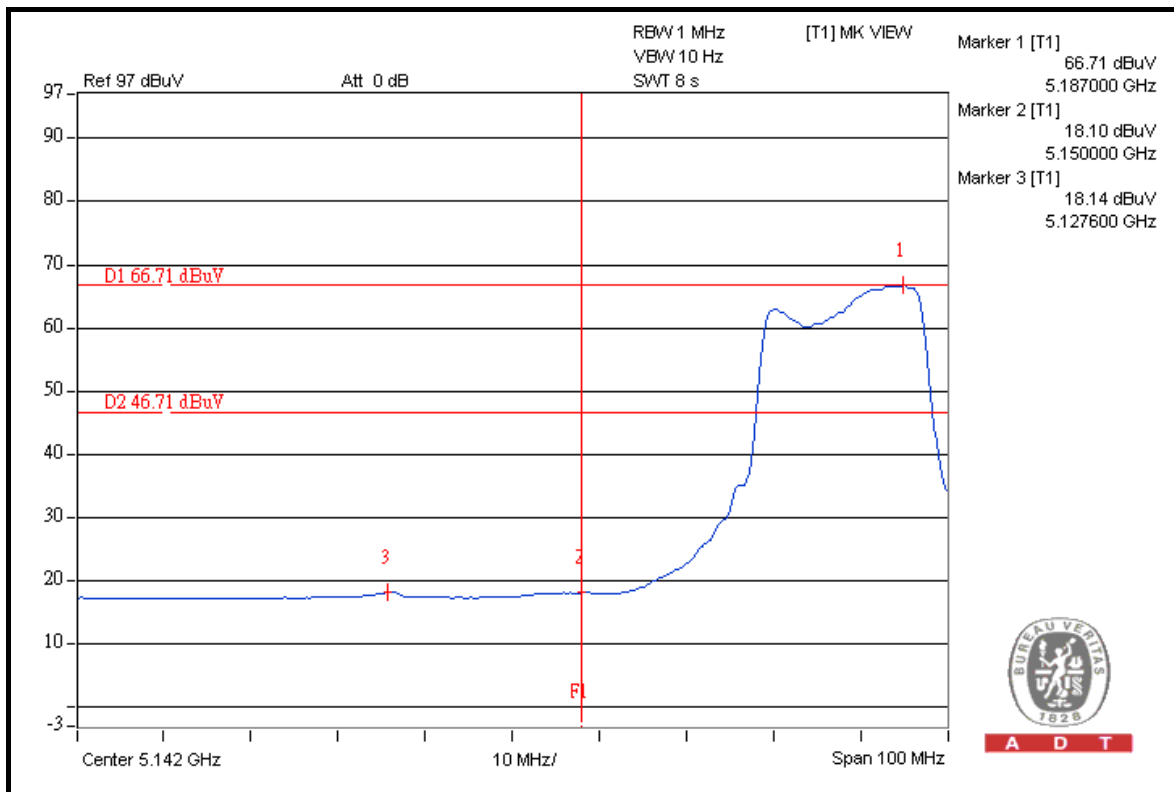

A D T



A D T

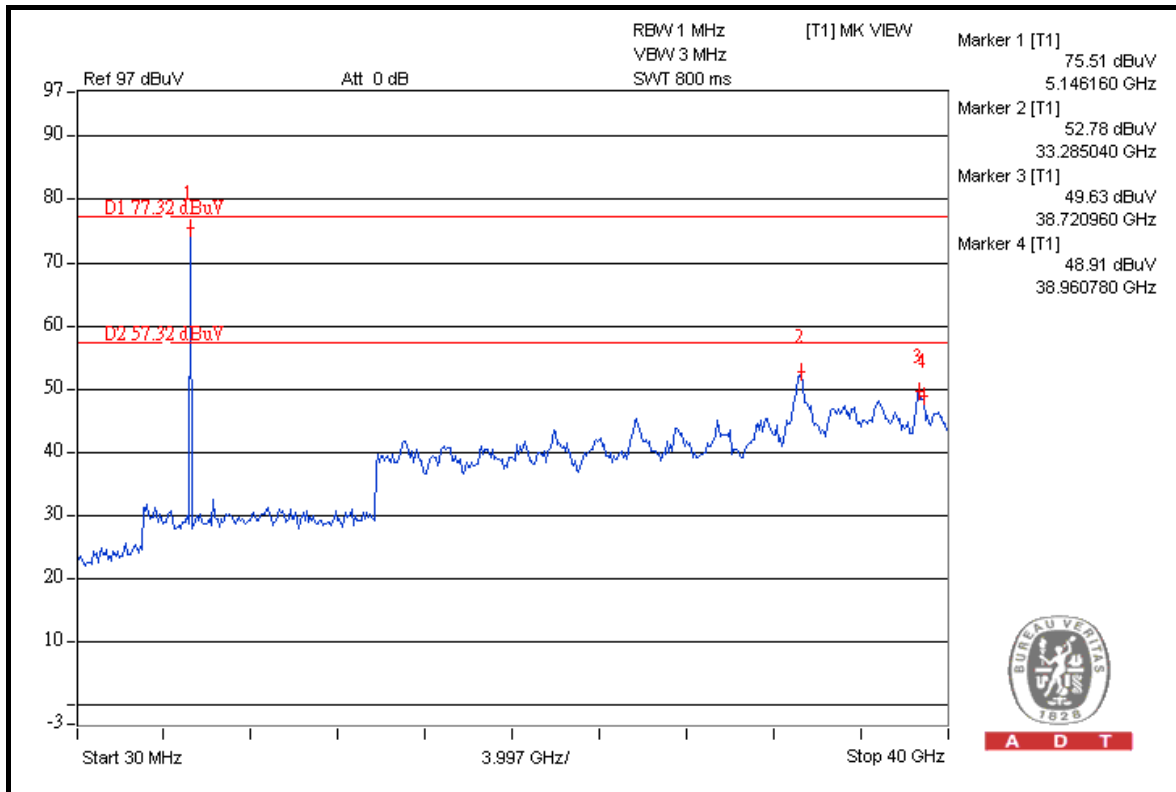

A D T

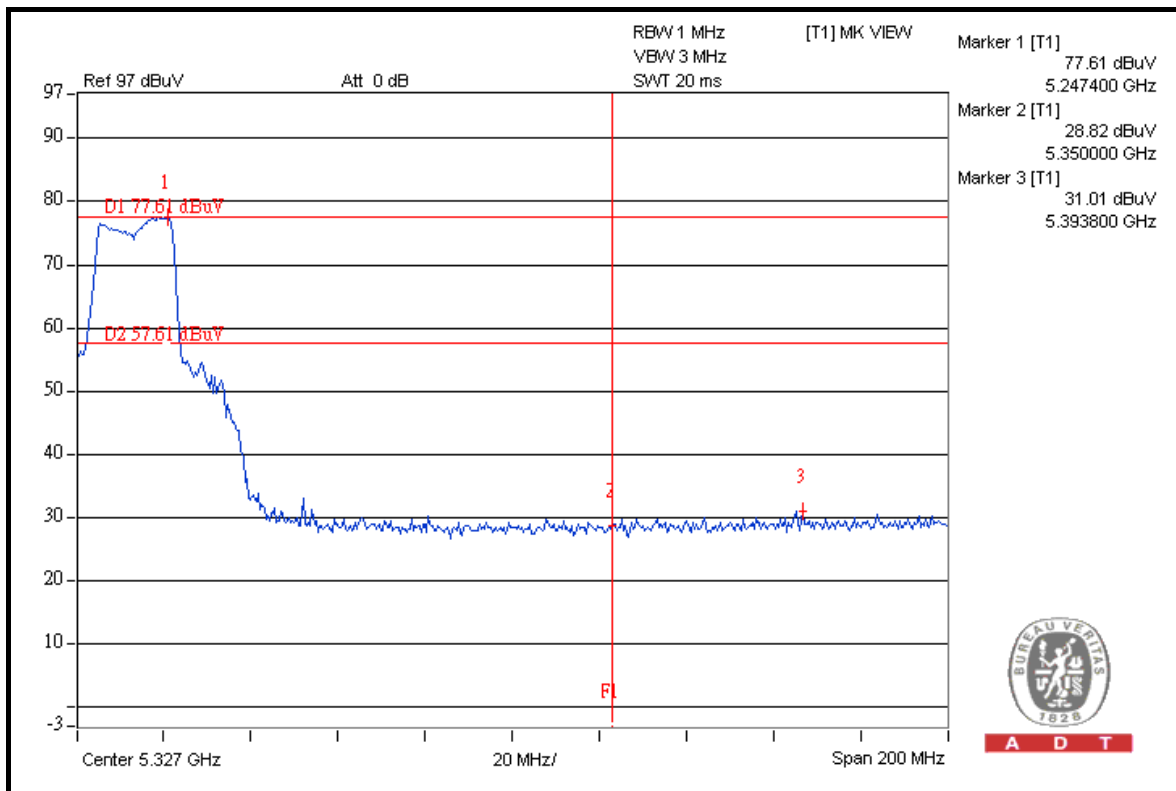

A D T



A D T

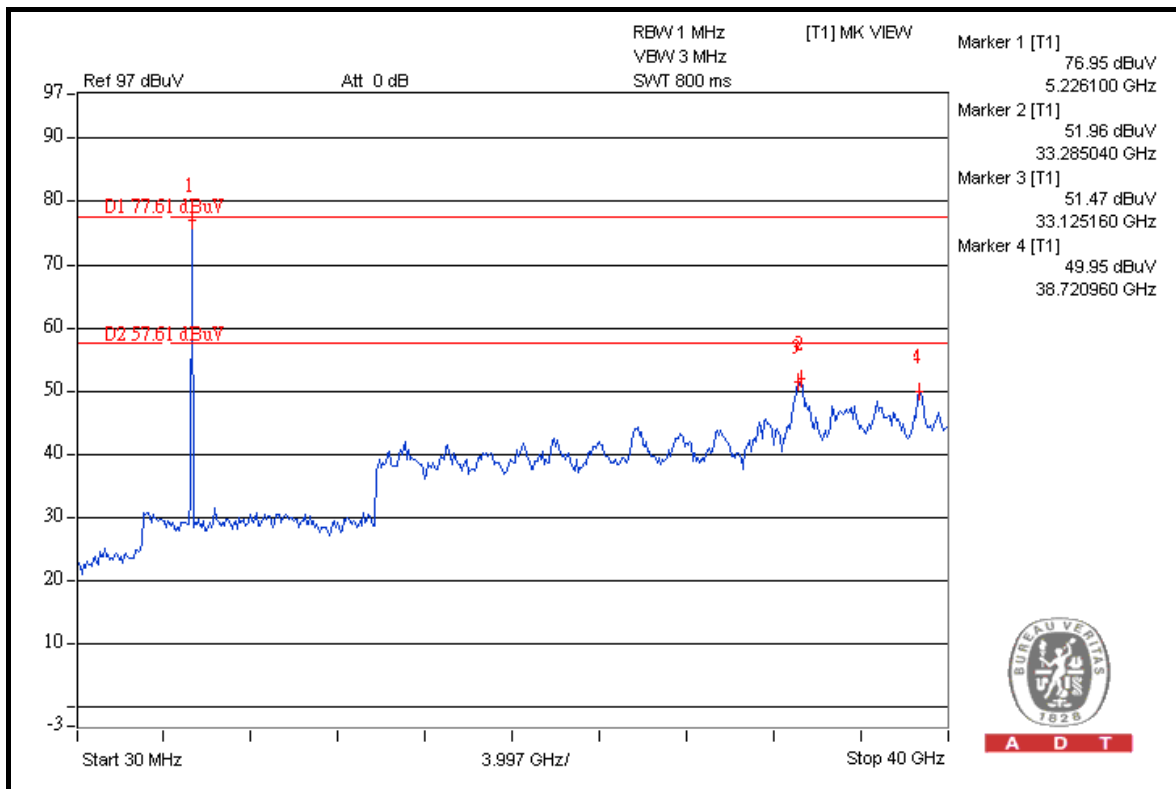
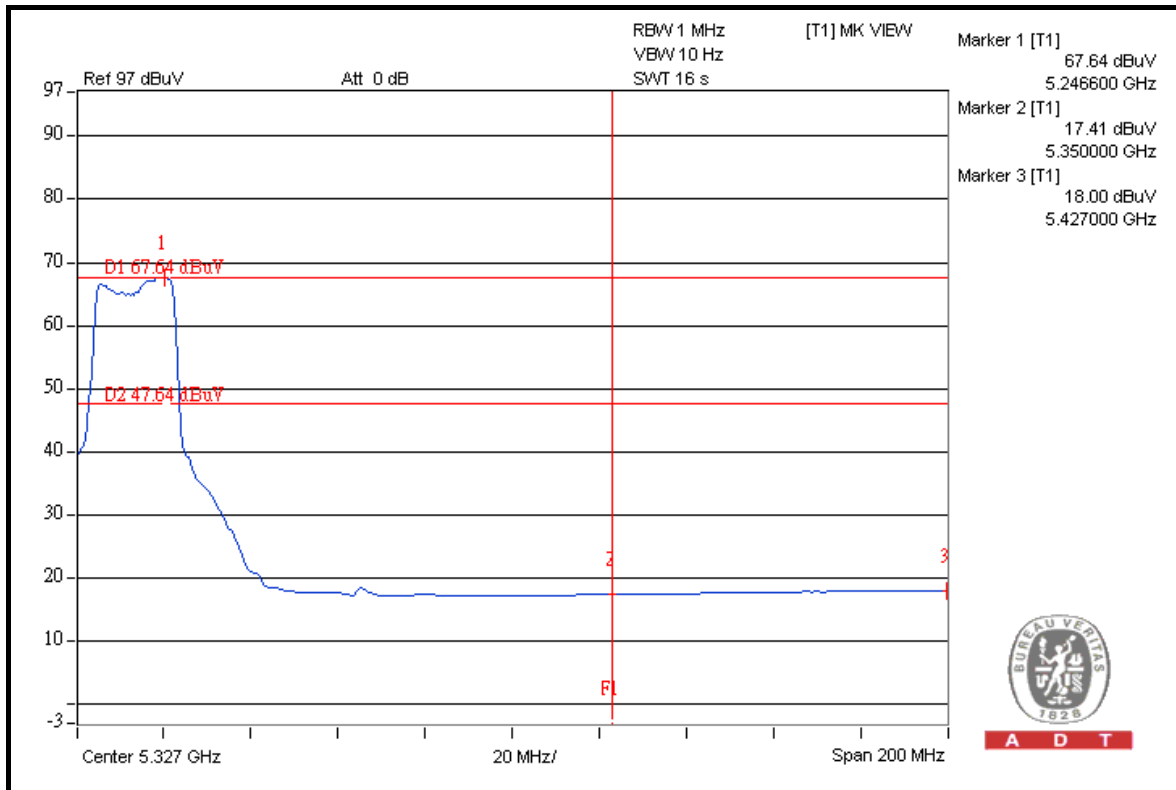

DRAFT 802.11n (40MHz) OFDM MODULATION

Channel 38 (5190MHz)

The band edge emission plot on the next page shows 37.96dBc between carrier maximum power and local maximum emission in restrict band. The emission of carrier strength list in the test result of channel 38 is 102.04dBuV/m (Peak), so the maximum field strength in restrict band is $102.04 - 37.96 = 64.08$ dBuV/m which is under 74dBuV/m limit.

The band edge emission plot on the next page shows 42.09dBc between carrier maximum power and local maximum emission in restrict band. The emission of carrier strength list in the test result of channel 38 is 91.78dBuV/m (Average), so the maximum field strength in restrict band is $91.78 - 42.09 = 49.69$ dBuV/m which is under 54dBuV/m limit.

Channel 46 (5230MHz)

The band edge emission plot on the next second page shows 42.83dBc between carrier maximum power and local maximum emission in restrict band. The emission of carrier strength list in the test result of channel 46 is 103.49dBuV/m (Peak), so the maximum field strength in restrict band is $103.49 - 42.83 = 60.66$ dBuV/m which is under 74dBuV/m limit.

The band edge emission plot on the next third page shows 45.60dBc between carrier maximum power and local maximum emission in restrict band. The emission of carrier strength list in the test result of channel 46 is 93.21dBuV/m (Average), so the maximum field strength in restrict band is $93.21 - 45.60 = 47.61$ dBuV/m which is under 54dBuV/m limit.



A D T

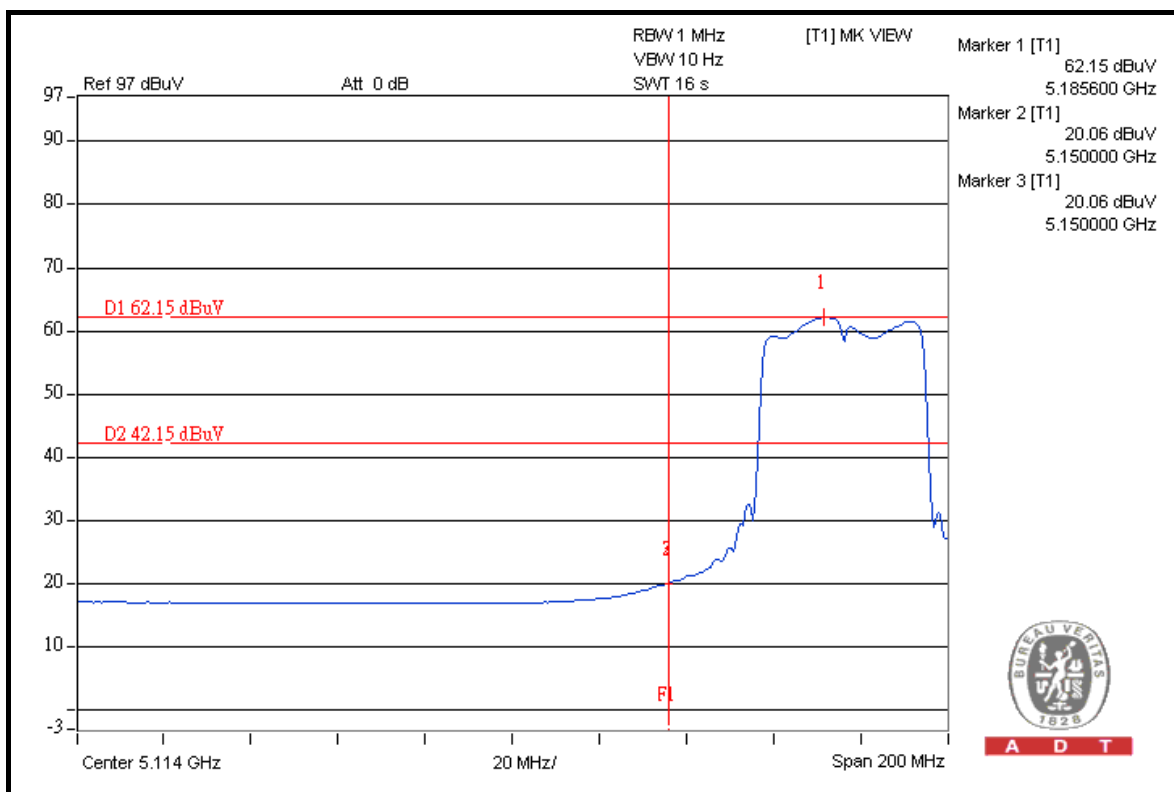
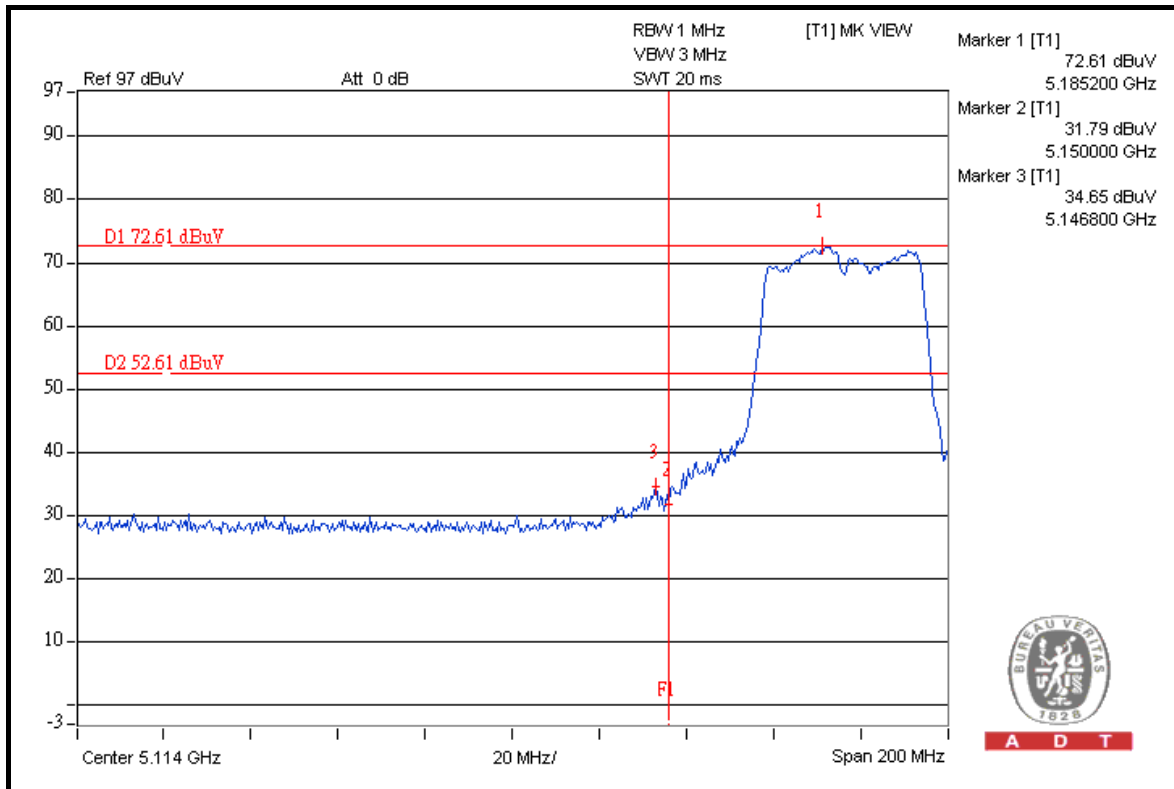



A D T

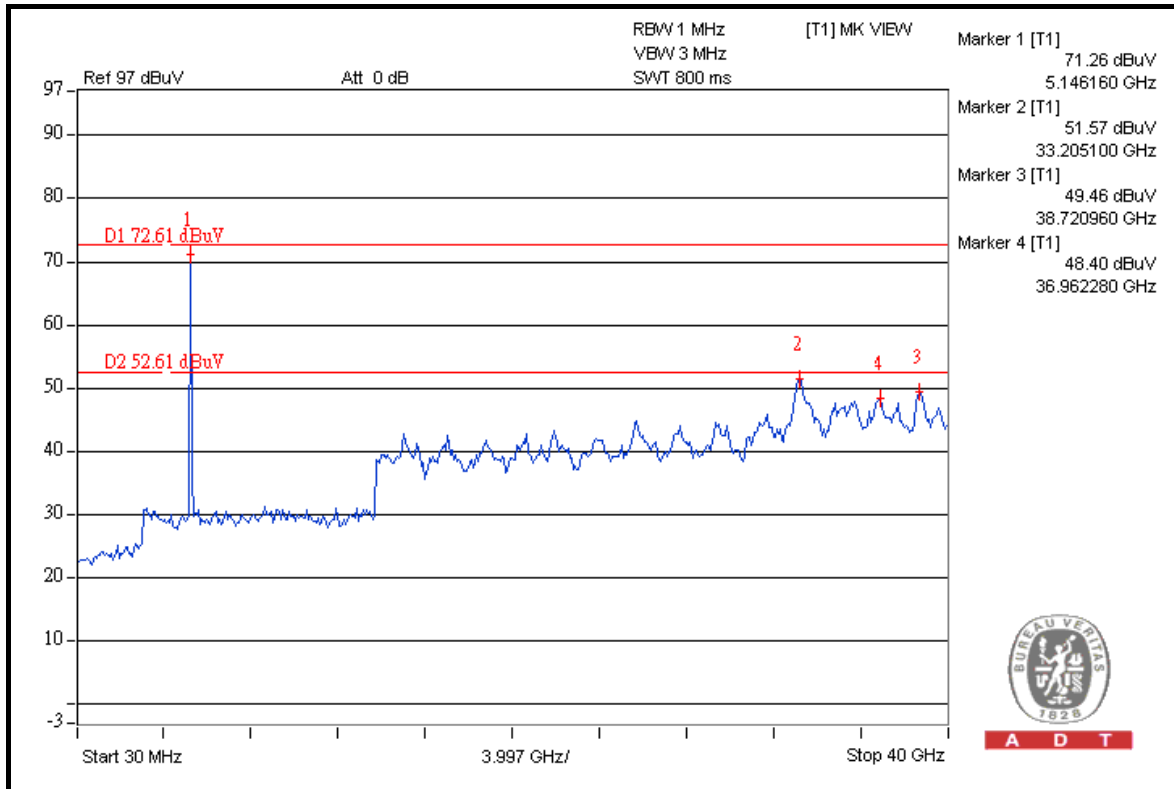

A D T

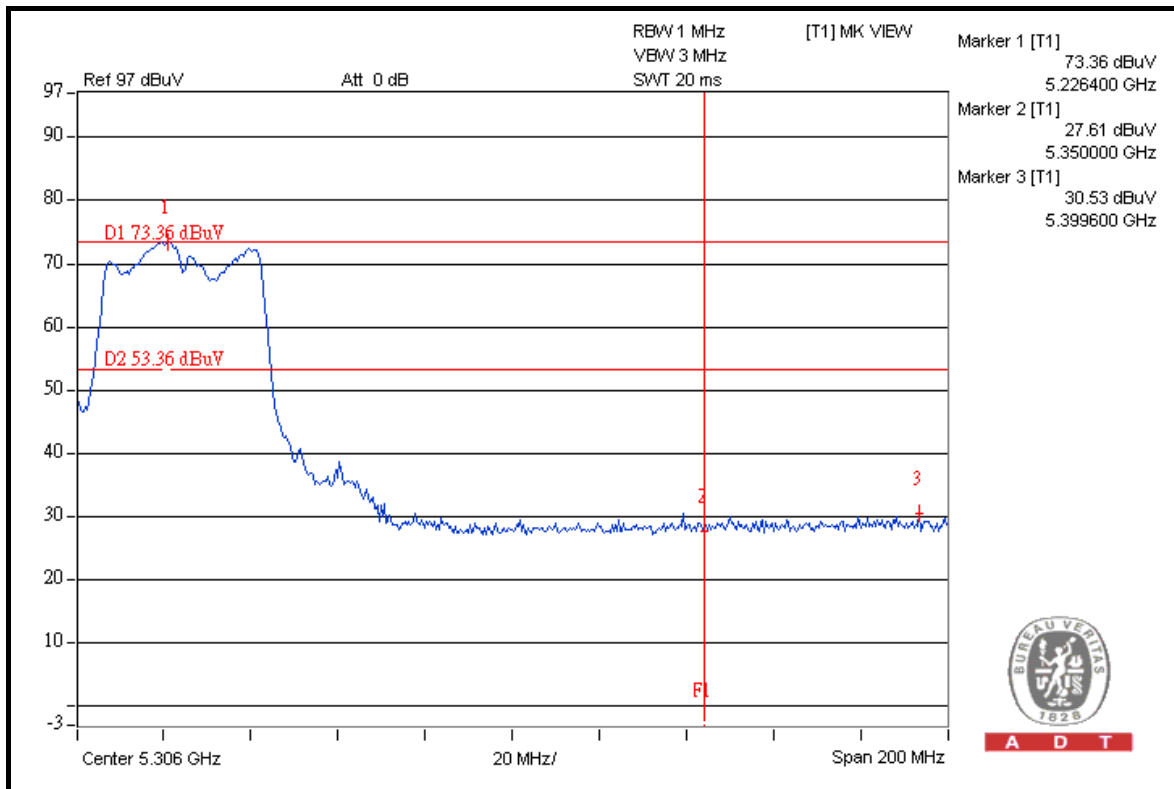

A D T



A D T

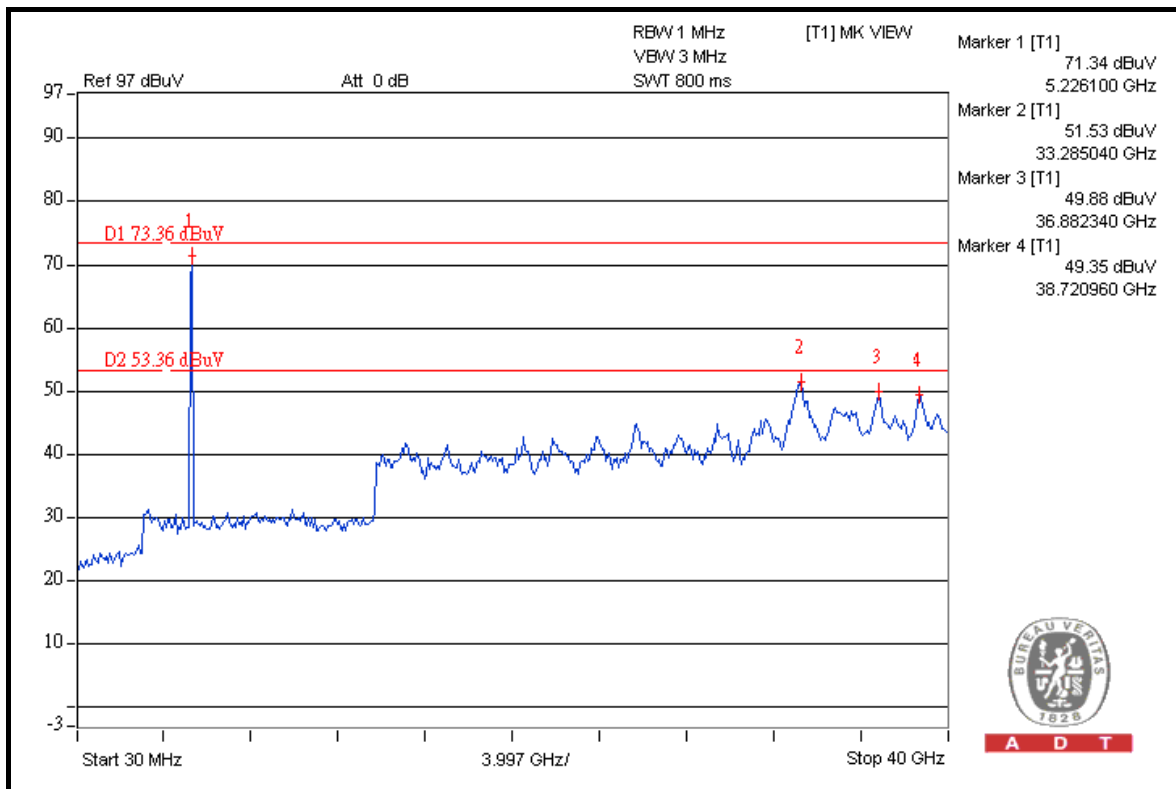
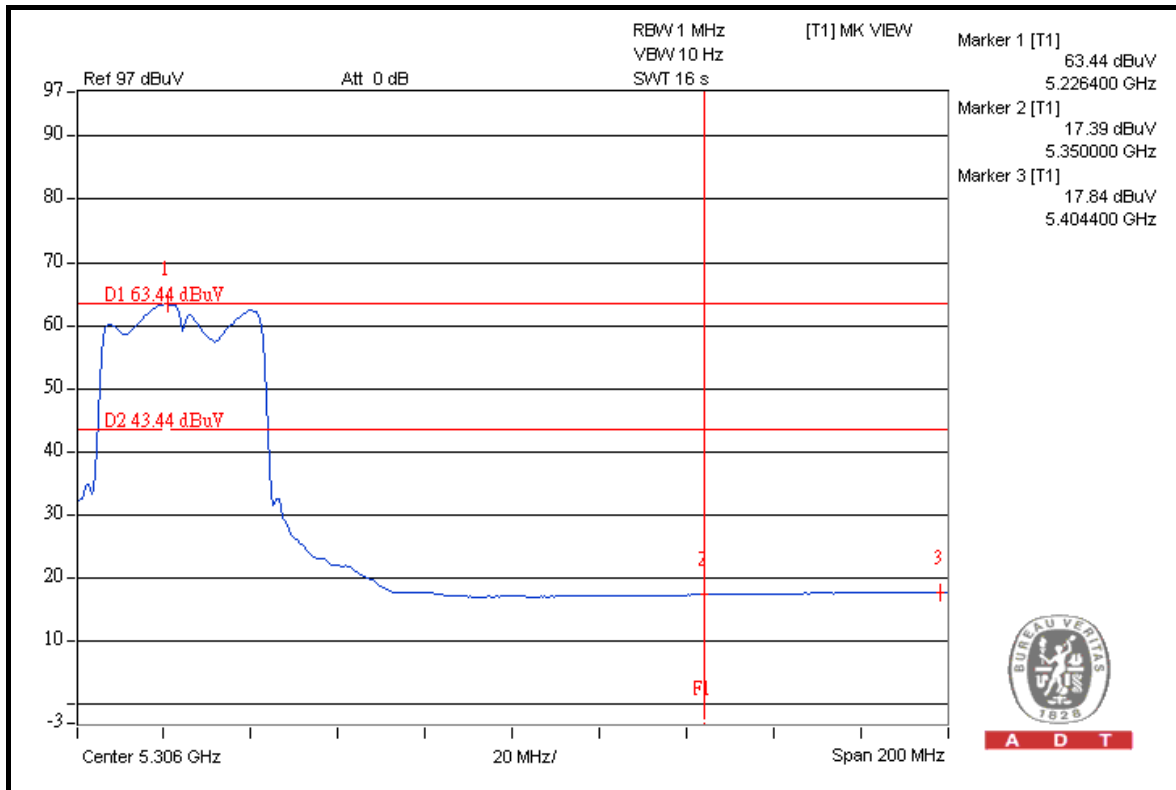

4.8 ANTENNA REQUIREMENT

4.8.1 STANDARD APPLICABLE

For intentional device, according to FCC 47 CFR Section 15.203, an intentional radiator shall be designed to ensure that no antenna other than that furnished by the responsible party shall be used with the device.

And according to FCC 47 CFR Section 15.407(a), if transmitting antennas of directional gain greater than 6dBi are used, the power shall be reduced by the amount in dB that the directional gain of the antenna exceeds 6dBi.

4.8.2 ANTENNA CONNECTED CONSTRUCTION

The antenna used in this product is Printed antenna without connector. The maximum gain of the antenna is 3.07dBi.

5. PHOTOGRAPHS OF THE TEST CONFIGURATION

Please refer to the attached file (Test Setup Photo).



6. INFORMATION ON THE TESTING LABORATORIES

We, Bureau Veritas Consumer Products Services (H.K.) Ltd., Taoyuan Branch, were founded in 1988 to provide our best service in EMC, Radio, Telecom and Safety consultation. Our laboratories are accredited and approved by the following approval agencies according to ISO/IEC 17025.

USA	FCC, NVLAP
Germany	TUV Rheinland
Japan	VCCI
Norway	NEMKO
Canada	INDUSTRY CANADA , CSA
R.O.C.	TAF, BSMI, NCC
Netherlands	Telefication
Singapore	GOST-ASIA(MOU)
Russia	CERTIS(MOU)

Copies of accreditation certificates of our laboratories obtained from approval agencies can be downloaded from our web site:
www.adt.com.tw/index.5/phtml. If you have any comments, please feel free to contact us at the following:

Linko EMC/RF Lab:
Tel: 886-2-26052180
Fax: 886-2-26051924

Hsin Chu EMC/RF Lab:
Tel: 886-3-5935343
Fax: 886-3-5935342

Hwa Ya EMC/RF/Safety Telecom Lab:
Tel: 886-3-3183232
Fax: 886-3-3185050

Web Site: www.adt.com.tw

The address and road map of all our labs can be found in our web site also.

7. APPENDIX A - MODIFICATIONS RECORDERS FOR ENGINEERING CHANGES TO THE EUT BY THE LAB

No any modifications are made to the EUT by the lab during the test.

---END---