



A D T

# FCC TEST REPORT (15.247)

**REPORT NO.:** RF9780105L17

**MODEL NO.:** TEW-664UB

**RECEIVED:** Nov. 11, 2008

**TESTED:** Dec. 24, 2008 ~ Jan. 13, 2009

**ISSUED:** Feb. 02, 2009

**APPLICANT:** TRENDware International Inc

**ADDRESS:** 20675 Manhattan Place, Torrance, CA 90501,  
USA

**ISSUED BY:** Bureau Veritas Consumer Products Services  
(H.K.) Ltd., Taoyuan Branch

**LAB ADDRESS:** No. 47, 14th Ling, Chia Pau Tsuen, Lin Kou  
Hsiang, Taipei Hsien 244, Taiwan, R.O.C.

**TEST LOCATION:** No. 19, Hwa Ya 2nd Rd, Wen Hwa Tsuen, Kwei  
Shan Hsiang, Taoyuan Hsien 333, Taiwan,  
R.O.C.

This test report consists of 160 pages in total. It may be duplicated completely for legal use with the approval of the applicant. It should not be reproduced except in full, without the written approval of our laboratory. The client should not use it to claim product endorsement by TAF or any government agencies. The test results in the report only apply to the tested sample.





A D T

## TABLE OF CONTENTS

1.	CERTIFICATION.....	5
2.	SUMMARY OF TEST RESULTS .....	6
2.1	MEASUREMENT UNCERTAINTY.....	6
3.	GENERAL INFORMATION.....	7
3.1	GENERAL DESCRIPTION OF EUT .....	7
3.2	DESCRIPTION OF TEST MODES.....	9
3.2.1	CONFIGURATION OF SYSTEM UNDER TEST .....	9
3.2.2	TEST MODE APPLICABILITY AND TESTED CHANNEL DETAIL .....	10
3.3	GENERAL DESCRIPTION OF APPLIED STANDARDS .....	14
3.4	DESCRIPTION OF SUPPORT UNITS .....	14
4.	TEST TYPES AND RESULTS (FOR 2.4GHz BAND).....	15
4.1	RADIATED EMISSION MEASUREMENT .....	15
4.1.1	LIMITS OF RADIATED EMISSION MEASUREMENT.....	15
4.1.2	TEST INSTRUMENTS.....	16
4.1.3	TEST PROCEDURES .....	17
4.1.4	DEVIATION FROM TEST STANDARD.....	17
4.1.5	TEST SETUP.....	18
4.1.6	EUT OPERATING CONDITIONS .....	18
4.1.7	TEST RESULTS .....	19
4.2	CONDUCTED EMISSION MEASUREMENT .....	32
4.2.1	LIMITS OF CONDUCTED EMISSION MEASUREMENT .....	32
4.2.2	TEST INSTRUMENTS.....	32
4.2.3	TEST PROCEDURES .....	33
4.2.4	DEVIATION FROM TEST STANDARD.....	33
4.2.5	TEST SETUP.....	34
4.2.6	EUT OPERATING CONDITIONS .....	34
4.2.7	TEST RESULTS .....	35
4.3	6dB BANDWIDTH MEASUREMENT.....	37
4.3.1	LIMITS OF 6dB BANDWIDTH MEASUREMENT .....	37
4.3.2	TEST INSTRUMENTS.....	37
4.3.3	TEST PROCEDURE.....	37
4.3.4	DEVIATION FROM TEST STANDARD.....	37
4.3.5	TEST SETUP.....	38
4.3.6	EUT OPERATING CONDITIONS .....	38
4.3.7	TEST RESULTS .....	39
4.4	MAXIMUM PEAK OUTPUT POWER.....	55
4.4.1	LIMITS OF MAXIMUM PEAK OUTPUT POWER MEASUREMENT .....	55
4.4.2	INSTRUMENTS.....	55
4.4.3	TEST PROCEDURES .....	55
4.4.4	DEVIATION FROM TEST STANDARD.....	56
4.4.5	TEST SETUP.....	56
4.4.6	EUT OPERATING CONDITIONS .....	56
4.4.7	TEST RESULTS .....	57
4.5	POWER SPECTRAL DENSITY MEASUREMENT .....	59
4.5.1	LIMITS OF POWER SPECTRAL DENSITY MEASUREMENT .....	59
4.5.2	TEST INSTRUMENTS.....	59
4.5.3	TEST PROCEDURE.....	59
4.5.4	DEVIATION FROM TEST STANDARD.....	60



A D T

4.5.5	TEST SETUP .....	60
4.5.6	EUT OPERATING CONDITION.....	60
4.5.7	TEST RESULTS .....	61
4.6	BAND EDGES MEASUREMENT .....	77
4.6.1	LIMITS OF BAND EDGES MEASUREMENT.....	77
4.6.2	TEST INSTRUMENTS.....	77
4.6.3	TEST PROCEDURE.....	78
4.6.4	DEVIATION FROM TEST STANDARD.....	79
4.6.5	EUT OPERATING CONDITION.....	79
4.6.6	TEST RESULTS .....	80
4.7	ANTENNA REQUIREMENT .....	96
4.7.1	STANDARD APPLICABLE .....	96
4.7.2	ANTENNA CONNECTED CONSTRUCTION .....	96
5.	TEST TYPES AND RESULTS (FOR 5.0GHz BAND) .....	97
5.1	RADIATED EMISSION MEASUREMENT .....	97
5.1.1	LIMITS OF RADIATED EMISSION MEASUREMENT.....	97
5.1.2	TEST INSTRUMENTS.....	98
5.1.3	TEST PROCEDURES .....	99
5.1.4	DEVIATION FROM TEST STANDARD.....	99
5.1.5	TEST SETUP .....	100
5.1.6	EUT OPERATING CONDITIONS .....	100
5.1.7	TEST RESULTS .....	101
5.2	CONDUCTED EMISSION MEASUREMENT .....	110
5.2.1	LIMITS OF CONDUCTED EMISSION MEASUREMENT.....	110
5.2.2	TEST INSTRUMENTS.....	110
5.2.3	TEST PROCEDURES .....	111
5.2.4	DEVIATION FROM TEST STANDARD.....	111
5.2.5	TEST SETUP .....	112
5.2.6	EUT OPERATING CONDITIONS .....	112
5.2.7	TEST RESULTS .....	113
5.3	6dB BANDWIDTH MEASUREMENT .....	115
5.3.1	LIMITS OF 6dB BANDWIDTH MEASUREMENT .....	115
5.3.2	TEST INSTRUMENTS.....	115
5.3.3	TEST PROCEDURE.....	115
5.3.4	DEVIATION FROM TEST STANDARD.....	116
5.3.5	TEST SETUP .....	116
5.3.6	EUT OPERATING CONDITIONS .....	116
5.3.7	TEST RESULTS .....	117
5.4	MAXIMUM PEAK OUTPUT POWER.....	128
5.4.1	LIMITS OF MAXIMUM PEAK OUTPUT POWER MEASUREMENT .....	128
5.4.2	INSTRUMENTS.....	128
5.4.3	TEST PROCEDURES .....	128
5.4.4	DEVIATION FROM TEST STANDARD.....	129
5.4.5	TEST SETUP .....	129
5.4.6	EUT OPERATING CONDITIONS .....	129
5.4.7	TEST RESULTS .....	130
5.5	POWER SPECTRAL DENSITY MEASUREMENT .....	132
5.5.1	LIMITS OF POWER SPECTRAL DENSITY MEASUREMENT .....	132
5.5.2	TEST INSTRUMENTS.....	132
5.5.3	TEST PROCEDURE.....	132
5.5.4	DEVIATION FROM TEST STANDARD.....	133



A D T

5.5.5	TEST SETUP .....	133
5.5.6	EUT OPERATING CONDITION.....	133
5.5.7	TEST RESULTS .....	134
5.6	BAND EDGES MEASUREMENT .....	145
5.6.1	LIMITS OF BAND EDGES MEASUREMENT .....	145
5.6.2	TEST INSTRUMENTS.....	145
5.6.3	TEST PROCEDURE.....	146
5.6.4	DEVIATION FROM TEST STANDARD.....	147
5.6.5	EUT OPERATING CONDITION.....	147
5.6.6	TEST RESULTS .....	147
5.7	ANTENNA REQUIREMENT .....	157
5.7.1	STANDARD APPLICABLE .....	157
5.7.2	ANTENNA CONNECTED CONSTRUCTION .....	157
6.	PHOTOGRAPHS OF THE TEST CONFIGURATION.....	158
7.	INFORMATION ON THE TESTING LABORATORIES .....	159
8.	APPENDIX A - MODIFICATIONS RECORDERS FOR ENGINEERING CHANGES TO THE EUT BY THE LAB.....	160



A D T

## 1. CERTIFICATION

**PRODUCT:** 802.11n dual band USB adapter

**MODEL:** TEW-664UB

**BRAND:** TRENDnet

**APPLICANT:** TRENDware International Inc

**TEST SAMPLE:** ENGINEERING SAMPLE

**TESTED:** Dec. 24, 2008 ~ Jan. 13, 2009

**STANDARDS:** FCC Part 15, Subpart C (Section 15.247)

ANSI C63.4-2003

The above equipment (Model: TEW-664UB) has been tested by **Bureau Veritas Consumer Products Services (H.K.) Ltd., Taoyuan Branch**, and found compliance with the requirement of the above standards. The test record, data evaluation & Equipment Under Test (EUT) configurations represented herein are true and accurate accounts of the measurements of the sample's EMC characteristics under the conditions specified in this report.

**PREPARED BY** : *Polly Chien* , **DATE** : Feb. 02, 2009  
Polly Chien / Specialist

**TECHNICAL ACCEPTANCE** : *Long Chen* , **DATE** : Feb. 02, 2009  
Responsible for RF Long Chen / Senior Engineer

**APPROVED BY** : *Gary Chang* , **DATE** : Feb. 02, 2009  
Gary Chang / Assistant Manager



## 2. SUMMARY OF TEST RESULTS

The EUT has been tested according to the following specifications:

APPLIED STANDARD: FCC PART 15, SUBPART C (SECTION 15.247)			
STANDARD SECTION	TEST TYPE AND LIMIT	RESULT	REMARK
15.207	AC Power Conducted Emission	PASS	Meet the requirement of limit. Minimum passing margin is -14.03dB at 0.173MHz
15.247(a)(2)	Spectrum Bandwidth of a Direct Sequence Spread Spectrum System Limit: min. 500kHz	PASS	Meet the requirement of limit.
15.247(b)	Maximum Peak Output Power Limit: max. 30dBm	PASS	Meet the requirement of limit.
15.247(d)	Radiated Emissions Limit: Table 15.209	PASS	Meet the requirement of limit. Minimum passing margin is -1.31dB at 11510.00MHz
15.247(e)	Power Spectral Density Limit: max. 8dBm	PASS	Meet the requirement of limit.
15.247(d)	Band Edge Measurement Limit: 20dB less than the peak value of fundamental frequency	PASS	Meet the requirement of limit.

### 2.1 MEASUREMENT UNCERTAINTY

Where relevant, the following measurement uncertainty levels have been estimated for tests performed on the EUT as specified in CISPR 16-4-2:

MEASUREMENT	FREQUENCY	UNCERTAINTY
Conducted emissions	9kHz~30MHz	2.44 dB
Radiated emissions	30MHz ~ 200MHz	2.93 dB
	200MHz ~1000MHz	2.95 dB
	1GHz ~ 18GHz	2.26 dB
	18GHz ~ 40GHz	1.94 dB

This uncertainty represents an expanded uncertainty expressed at approximately the 95% confidence level using a coverage factor of  $k = 2$ .



### 3. GENERAL INFORMATION

#### 3.1 GENERAL DESCRIPTION OF EUT

<b>EUT</b>	802.11n dual band USB adapter
<b>MODEL NO.</b>	TEW-664UB
<b>FCC ID</b>	S9ZTEW664UB
<b>POWER SUPPLY</b>	5.0Vdc from host equipment
<b>MODULATION TYPE</b>	CCK, DQPSK, DBPSK for DSSS 64QAM, 16QAM, QPSK, BPSK for OFDM
<b>MODULATION TECHNOLOGY</b>	DSSS, OFDM
<b>TRANSFER RATE</b>	802.11b:11.0/ 5.5/ 2.0/ 1.0Mbps 802.11g: 54.0/ 48.0/ 36.0/ 24.0/ 18.0/ 12.0/ 9.0/ 6.0Mbps 802.11a: 54.0/ 48.0/ 36.0/ 24.0/ 18.0/ 12.0/ 9.0/ 6.0Mbps Draft 802.11n: up to 300.0Mbps
<b>FREQUENCY RANGE</b>	2.4GHz: 2400.0 ~ 2483.5MHz 5.0GHz: 5150.0 ~ 5250.0MHz, 5725.0 ~ 5825.0MHz
<b>NUMBER OF CHANNEL</b>	2.4GHz: 11 for 802.11b, 802.11g, draft 802.11n (20MHz) 7 for draft 802.11n (40MHz) 5.0GHz: 9 for 802.11a, draft 802.11n (20MHz) 4 for draft 802.11n (40MHz)
<b>OUTPUT POWER</b>	387.900mW for 2400.0 ~ 2483.5MHz 36.611mW for 5150.0 ~ 5250.0MHz 256.766mW for 5725.0 ~ 5825.0MHz
<b>ANTENNA TYPE</b>	2.4GHz: Printed antenna with -0.07dBi gain 5.0GHz: Printed antenna with 3.07dBi gain
<b>DATA CABLE</b>	NA
<b>I/O PORTS</b>	USB
<b>ASSOCIATED DEVICES</b>	NA

**NOTE:**

- The EUT is a 802.11n dual band USB adapter. The functions of EUT listed as below:

	TEST STANDARD	REFERENCE REPORT
WLAN 802.11b/g, draft 802.11n	FCC Part 15, Subpart C (Section 15.247)	RF980105L17
WLAN 802.11a, draft 802.11n (5725~5825 MHz)		
WLAN 802.11a, draft 802.11n (5150~ 5250MHz)	FCC Part 15, Subpart E (Section 15.407)	RF980105L17-1



2. The frequency bands used in this EUT are listed as follows:

Frequency Band (MHz)	2400~2483.5	5150~5250	5725~5825
802.11b	√		
802.11g	√		
802.11a		√	√
Draft 802.11n (20MHz)	√	√	√
Draft 802.11n (40MHz)	√	√	√

3. The EUT incorporates a MIMO function. Physically, the EUT provides two completed transmitters and two receivers.

MODULATION MODE	TX FUNCTION
802.11b	2TX
802.11g	2TX
802.11a	2TX
Draft 802.11n (20MHz)	2TX
Draft 802.11n (40MHz)	2TX

4. The above EUT information was declared by manufacturer and for more detailed features description, please refer to the manufacturer's specifications or user's manual.



### 3.2 DESCRIPTION OF TEST MODES

#### FOR 2.4GHz:

11 channels are provided for 802.11b, 802.11g and draft 802.11n (20MHz):

CHANNEL	FREQUENCY	CHANNEL	FREQUENCY
1	2412MHz	7	2442MHz
2	2417MHz	8	2447MHz
3	2422MHz	9	2452MHz
4	2427MHz	10	2457MHz
5	2432MHz	11	2462MHz
6	2437MHz		

7 channels are provided for draft 802.11n (40MHz):

CHANNEL	FREQUENCY	CHANNEL	FREQUENCY
1	2422MHz	5	2442MHz
2	2427MHz	6	2447MHz
3	2432MHz	7	2452MHz
4	2437MHz		

#### FOR 5.0GHz (5725 ~ 5825MHz):

5 channels are provided for 802.11a, draft 802.11n (20MHz):

CHANNEL	FREQUENCY	CHANNEL	FREQUENCY
149	5745MHz	161	5805MHz
153	5765MHz	165	5825MHz
157	5785MHz		

2 channels are provided for draft 802.11n (40MHz):

CHANNEL	FREQUENCY	CHANNEL	FREQUENCY
151	5755MHz	159	5795MHz

#### 3.2.1 CONFIGURATION OF SYSTEM UNDER TEST

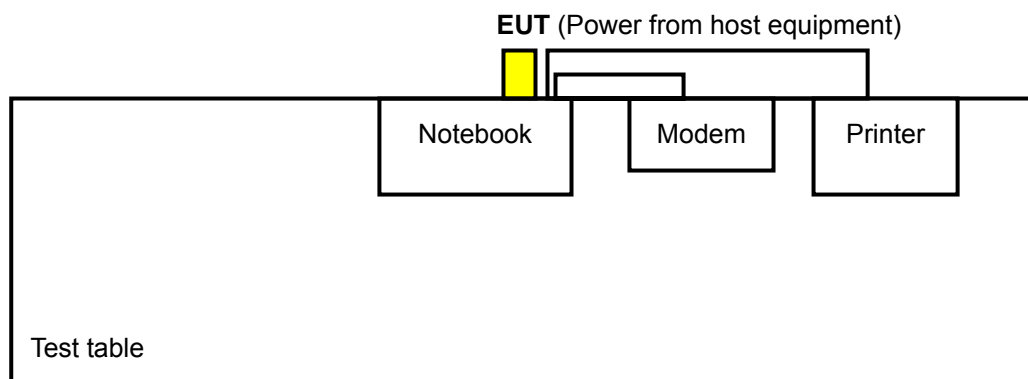

### 3.2.2 TEST MODE APPLICABILITY AND TESTED CHANNEL DETAIL FOR 2.400 ~ 2.4835GHz:

EUT CONFIGURE MODE	APPLICABLE TO				DESCRIPTION
	RE≥1G	RE<1G	PLC	APCM	
-	√	√	√	√	-

Where **RE≥1G**: Radiated Emission above 1GHz      **RE<1G**: Radiated Emission below 1GHz  
**PLC**: Power Line Conducted Emission      **APCM**: Antenna Port Conducted Measurement

#### **RADIATED EMISSION TEST (ABOVE 1GHz):**

- Pre-Scan has been conducted to determine the worst-case mode from all possible combinations between available modulations, data rates and antenna ports (if EUT with antenna diversity architecture).
- Following channel(s) was (were) selected for the final test as listed below.

EUT CONFIGURE MODE	MODE	AVAILABLE CHANNEL	TESTED CHANNEL	MODULATION TECHNOLOGY	MODULATION TYPE	DATA RATE (Mbps)
-	802.11b	1 to 11	1, 6, 11	DSSS	DBPSK	1.0
-	802.11g	1 to 11	1, 6, 11	OFDM	BPSK	6.0
-	Draft 802.11n (20MHz)	1 to 11	1, 6, 11	OFDM	BPSK	7.2
-	Draft 802.11n (40MHz)	1 to 7	1, 4, 7	OFDM	BPSK	15.0

#### **RADIATED EMISSION TEST (BELOW 1GHz):**

- Pre-Scan has been conducted to determine the worst-case mode from all possible combinations between available modulations, data rates and antenna ports (if EUT with antenna diversity architecture).
- Following channel(s) was (were) selected for the final test as listed below.

EUT CONFIGURE MODE	MODE	AVAILABLE CHANNEL	TESTED CHANNEL	MODULATION TECHNOLOGY	MODULATION TYPE	DATA RATE (Mbps)
-	Draft 802.11n (20MHz)	1 to 11	6	OFDM	BPSK	7.2

#### **POWER LINE CONDUCTED EMISSION TEST:**

- Pre-Scan has been conducted to determine the worst-case mode from all possible combinations between available modulations, data rates and antenna ports (if EUT with antenna diversity architecture).
- Following channel(s) was (were) selected for the final test as listed below.

EUT CONFIGURE MODE	MODE	AVAILABLE CHANNEL	TESTED CHANNEL	MODULATION TECHNOLOGY	MODULATION TYPE	DATA RATE (Mbps)
-	Draft 802.11n (20MHz)	1 to 11	6	OFDM	BPSK	7.2



**BANDEDGE MEASUREMENT:**

- Pre-Scan has been conducted to determine the worst-case mode from all possible combinations between available modulations, data rates and antenna ports (if EUT with antenna diversity architecture).
- Following channel(s) was (were) selected for the final test as listed below.

EUT CONFIGURE MODE	MODE	AVAILABLE CHANNEL	TESTED CHANNEL	MODULATION TECHNOLOGY	MODULATION TYPE	DATA RATE (Mbps)
-	802.11b	1 to 11	1, 11	DSSS	DBPSK	1.0
-	802.11g	1 to 11	1, 11	OFDM	BPSK	6.0
-	Draft 802.11n (20MHz)	1 to 11	1, 11	OFDM	BPSK	7.2
-	Draft 802.11n (40MHz)	1 to 7	1, 7	OFDM	BPSK	15.0

**ANTENNA PORT CONDUCTED MEASUREMENT:**

- Pre-Scan has been conducted to determine the worst-case mode from all possible combinations between available modulations, data rates and antenna ports (if EUT with antenna diversity architecture).
- Following channel(s) was (were) selected for the final test as listed below.

EUT CONFIGURE MODE	MODE	AVAILABLE CHANNEL	TESTED CHANNEL	MODULATION TECHNOLOGY	MODULATION TYPE	DATA RATE (Mbps)
-	802.11b	1 to 11	1, 6, 11	DSSS	DBPSK	1.0
-	802.11g	1 to 11	1, 6, 11	OFDM	BPSK	6.0
-	Draft 802.11n (20MHz)	1 to 11	1, 6, 11	OFDM	BPSK	7.2
-	Draft 802.11n (40MHz)	1 to 7	1, 4, 7	OFDM	BPSK	15.0



A D T

**FOR 5.725 ~ 5.825GHz:**

EUT CONFIGURE MODE	APPLICABLE TO				DESCRIPTION
	RE≥1G	RE<1G	PLC	APCM	
-	√	√	√	√	-

Where **PLC:** Power Line Conducted Emission      **RE<1G:** Radiated Emission below 1GHz  
**RE≥1G:** Radiated Emission above 1GHz      **APCM:** Antenna Port Conducted Measurement

**RADIATED EMISSION TEST (ABOVE 1GHz):**

- Pre-Scan has been conducted to determine the worst-case mode from all possible combinations between available modulations, data rates and antenna ports (if EUT with antenna diversity architecture).
- Following channel(s) was (were) selected for the final test as listed below.

EUT CONFIGURE MODE	MODE	AVAILABLE CHANNEL	TESTED CHANNEL	MODULATION TECHNOLOGY	MODULATION TYPE	DATA RATE (Mbps)
-	802.11a	149 to 165	149, 157, 165	OFDM	BPSK	6.0
-	Draft 802.11n (20MHz)	149 to 165	149, 157, 165	OFDM	BPSK	7.2
-	Draft 802.11n (40MHz)	151 to 159	151, 159	OFDM	BPSK	15.0

**RADIATED EMISSION TEST (BELOW 1GHz):**

- Pre-Scan has been conducted to determine the worst-case mode from all possible combinations between available modulations, data rates and antenna ports (if EUT with antenna diversity architecture).
- Following channel(s) was (were) selected for the final test as listed below.

EUT CONFIGURE MODE	MODE	AVAILABLE CHANNEL	TESTED CHANNEL	MODULATION TECHNOLOGY	MODULATION TYPE	DATA RATE (Mbps)
-	Draft 802.11n (40MHz)	151 to 159	159	OFDM	BPSK	15.0

**POWER LINE CONDUCTED EMISSION TEST:**

- Pre-Scan has been conducted to determine the worst-case mode from all possible combinations between available modulations, data rates and antenna ports (if EUT with antenna diversity architecture).
- Following channel(s) was (were) selected for the final test as listed below.

EUT CONFIGURE MODE	MODE	AVAILABLE CHANNEL	TESTED CHANNEL	MODULATION TECHNOLOGY	MODULATION TYPE	DATA RATE (Mbps)
-	Draft 802.11n (40MHz)	151 to 159	159	OFDM	BPSK	15.0



**BANDEDGE MEASUREMENT:**

- Pre-Scan has been conducted to determine the worst-case mode from all possible combinations between available modulations, data rates and antenna ports (if EUT with antenna diversity architecture).
- Following channel(s) was (were) selected for the final test as listed below.

EUT CONFIGURE MODE	MODE	AVAILABLE CHANNEL	TESTED CHANNEL	MODULATION TECHNOLOGY	MODULATION TYPE	DATA RATE (Mbps)
-	802.11a	149 to 165	149, 165	OFDM	BPSK	6.0
-	Draft 802.11n (20MHz)	149 to 165	149, 165	OFDM	BPSK	7.2
-	Draft 802.11n (40MHz)	151 to 159	151, 159	OFDM	BPSK	15.0

**ANTENNA PORT CONDUCTED MEASUREMENT:**

- Pre-Scan has been conducted to determine the worst-case mode from all possible combinations between available modulations, data rates and antenna ports (if EUT with antenna diversity architecture).
- Following channel(s) was (were) selected for the final test as listed below.

EUT CONFIGURE MODE	MODE	AVAILABLE CHANNEL	TESTED CHANNEL	MODULATION TECHNOLOGY	MODULATION TYPE	DATA RATE (Mbps)
-	802.11a	149 to 165	149, 157, 165	OFDM	BPSK	6.0
-	Draft 802.11n (20MHz)	149 to 165	149, 157, 165	OFDM	BPSK	7.2
-	Draft 802.11n (40MHz)	151 to 159	151, 159	OFDM	BPSK	15.0



### 3.3 GENERAL DESCRIPTION OF APPLIED STANDARDS

The EUT is a RF Product. According to the specifications of the manufacturer, it must comply with the requirements of the following standards:

#### FCC Part 15, Subpart C (15.247)

#### ANSI C63.4-2003

All test items have been performed and recorded as per the above standards.

**NOTE:** The EUT is also considered as a kind of computer peripheral, because the connection to computer is necessary for typical use. It has been verified to comply with the requirements of FCC Part 15, Subpart B, Class B (DoC). The test report has been issued separately.

### 3.4 DESCRIPTION OF SUPPORT UNITS

The EUT has been tested as an independent unit together with other necessary accessories or support units. The following support units or accessories were used to form a representative test configuration during the tests.

NO.	PRODUCT	BRAND	MODEL NO.	SERIAL NO.	FCC ID
1	NOTEBOOK	DELL	PP05L	16484462992	E2K24CLNS
2	PRINTER	EPSON	LQ-300+	DCGY054011	FCC DoC Approved
3	MODEM	ACEEX	1414V/3	0401008253	IFAXDM1414

NO.	SIGNAL CABLE DESCRIPTION OF THE ABOVE SUPPORT UNITS
1	NA
2	1.8m braid shielded wire, DB25 connector, w/o core.
3	1.2m braid shielded wire, DB25 & DB9 connector, w/o core.

**NOTE:** All power cords of the above support units are non shielded (1.8m).



A D T

## 4. TEST TYPES AND RESULTS (FOR 2.4GHz BAND)

### 4.1 RADIATED EMISSION MEASUREMENT

#### 4.1.1 LIMITS OF RADIATED EMISSION MEASUREMENT

Emissions radiated outside of the specified bands, shall be according to the general radiated limits in 15.209 as following:

FREQUENCIES (MHz)	FIELD STRENGTH (microvolts/meter)	MEASUREMENT DISTANCE (meters)
0.009 ~ 0.490	2400/F(kHz)	300
0.490 ~ 1.705	24000/F(kHz)	30
1.705 ~ 30.0	30	30
30 ~ 88	100	3
88 ~ 216	150	3
216 ~ 960	200	3
Above 960	500	3

**NOTE:**

1. The lower limit shall apply at the transition frequencies.
2. Emission level (dBuV/m) = 20 log Emission level (uV/m).
3. As shown in 15.35(b), for frequencies above 1000MHz, the field strength limits are based on average detector, however, the peak field strength of any emission shall not exceed the maximum permitted average limits, specified above by more than 20dB under any condition of modulation.



A D T

#### 4.1.2 TEST INSTRUMENTS

DESCRIPTION & MANUFACTURER	MODEL NO.	SERIAL NO.	DATE OF CALIBRATION	DUE DATE OF CALIBRATION
Test Receiver ROHDE & SCHWARZ	ESIB7	100212	May 28, 2008	May 27, 2009
Spectrum Analyzer ROHDE & SCHWARZ	FSP40	100269	Aug. 08, 2008	Aug. 07, 2009
BILOG Antenna SCHWARZBECK	VULB9168	9168-156	Apr. 25, 2008	Apr. 24, 2009
HORN Antenna SCHWARZBECK	BBHA 9120 D	9120D-563	Aug. 06, 2008	Aug. 05, 2009
HORN Antenna SCHWARZBECK	BBHA 9170	BBHA9170148	Jul. 03, 2008	Jul. 02, 2009
Preamplifier Agilent	8449B	3008A01911	Sep. 10, 2008	Sep. 09, 2009
Preamplifier Agilent	8447D	2944A10638	Dec. 26, 2008	Dec. 25, 2009
RF signal cable HUBER+SUHNNER	SUCOFLEX 104	218190/4 231241/4	May 20, 2008	May 19, 2009
RF signal cable Worken	8D-FB	Cable-HYCH9-01	Aug. 09, 2008	Aug. 08, 2009
Software	ADT_Radiated_ V7.6.15.9.2	NA	NA	NA
Antenna Tower EMCO	2070/2080	512.835.4684	NA	NA
Turn Table EMCO	2087-2.03	NA	NA	NA
Antenna Tower & Turn Table Controller EMCO	2090	NA	NA	NA

- NOTE:**
1. The calibration interval of the above test instruments is 12 months and the calibrations are traceable to NML/ROC and NIST/USA.
  2. The test was performed in HwaYa Chamber 9.
  3. The horn antenna and HP preamplifier (model: 8449B) are used only for the measurement of emission frequency above 1GHz if tested.
  4. The FCC Site Registration No. is 460141.
  5. The IC Site Registration No. is IC 7450F-4.





#### 4.1.3 TEST PROCEDURES

- a. The EUT was placed on the top of a rotating table 0.8 meters above the ground at a 3 meters semi-anechoic chamber. The table was rotated 360 degrees to determine the position of the highest radiation.
- b. The EUT was set 3 meters away from the interference-receiving antenna, which was mounted on the top of a variable-height antenna tower.
- c. The antenna is a broadband antenna, and its height is varied from one meter to four meters above the ground to determine the maximum value of the field strength. Both horizontal and vertical polarizations of the antenna are set to make the measurement.
- d. For each suspected emission, the EUT was arranged to its worst case and then the antenna was tuned to heights from 1 meter to 4 meters and the rotatable table was turned from 0 degrees to 360 degrees to find the maximum reading.
- e. The test-receiver system was set to Peak Detect Function and Specified Bandwidth with Maximum Hold Mode.
- f. If the emission level of the EUT in peak mode was lower than the limit specified, then testing could be stopped and the peak values of the EUT would be reported. Otherwise the emissions would be re-tested one by one using peak, quasi-peak or average method as specified and then reported in a data sheet.

**NOTE:**

1. The resolution bandwidth and video bandwidth of test receiver/spectrum analyzer is 120kHz for Quasi-peak detection at frequency below 1GHz.
2. The resolution bandwidth of test receiver/spectrum analyzer is 1MHz and video bandwidth is 3MHz for Peak detection at frequency above 1GHz.
3. The resolution bandwidth of test receiver/spectrum analyzer is 1MHz and the video bandwidth is 10Hz for Average detection (AV) at frequency above 1GHz.
4. All modes of operation were investigated and the worst-case emissions are reported.

#### 4.1.4 DEVIATION FROM TEST STANDARD

No deviation.

#### 4.1.5 TEST SETUP

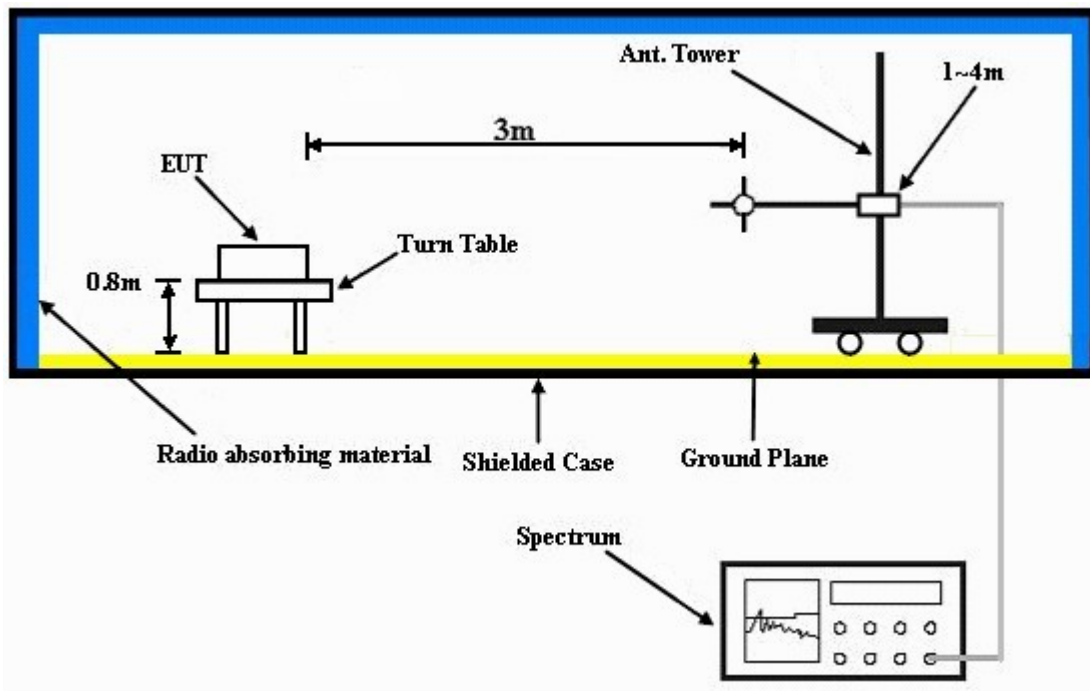

For the actual test configuration, please refer to the attached file (Test Setup Photo).

#### 4.1.6 EUT OPERATING CONDITIONS

- a. Plugged EUT into the notebook system and placed on the testing table.
- b. The notebook system ran a test program (provided by manufacturer) to enable EUT under transmission condition continuously at specific channel frequency.
- c. The necessary accessories enable the EUT in full functions.



A D T

#### 4.1.7 TEST RESULTS

##### 802.11b DSSS MODULATION

EUT TEST CONDITION		MEASUREMENT DETAIL	
CHANNEL	Channel 1	FREQUENCY RANGE	1 ~ 25GHz
INPUT POWER (SYSTEM)	120Vac, 60 Hz	DETECTOR FUNCTION	Peak (PK) Average (AV)
ENVIRONMENTAL CONDITIONS	24deg. C, 64%RH 1000hPa	TESTED BY	Match Tsui

ANTENNA POLARITY & TEST DISTANCE: HORIZONTAL AT 3 M								
NO.	FREQ. (MHz)	EMISSION LEVEL (dBuV/m)	LIMIT (dBuV/m)	MARGIN (dB)	ANTENNA HEIGHT (m)	TABLE ANGLE (Degree)	RAW VALUE (dBuV)	CORRECTION FACTOR (dB/m)
1	2390.00	59.40 PK	74.00	-14.60	1.06 H	156	26.32	33.08
2	2390.00	48.17 AV	54.00	-5.83	1.06 H	156	15.09	33.08
3	*2412.00	106.49 PK			1.03 H	166	73.31	33.18
4	*2412.00	102.09 AV			1.03 H	166	68.91	33.18
5	4824.00	46.97 PK	74.00	-27.03	1.13 H	191	7.82	39.15
6	4824.00	36.27 AV	54.00	-17.73	1.13 H	191	-2.88	39.15
ANTENNA POLARITY & TEST DISTANCE: VERTICAL AT 3 M								
NO.	FREQ. (MHz)	EMISSION LEVEL (dBuV/m)	LIMIT (dBuV/m)	MARGIN (dB)	ANTENNA HEIGHT (m)	TABLE ANGLE (Degree)	RAW VALUE (dBuV)	CORRECTION FACTOR (dB/m)
1	2387.00	58.46 PK	74.00	-15.54	1.58 V	338	25.40	33.06
2	2387.00	47.75 AV	54.00	-6.25	1.58 V	338	14.69	33.06
3	*2412.00	101.18 PK			1.58 V	338	68.00	33.18
4	*2412.00	96.92 AV			1.58 V	338	63.74	33.18
5	4824.00	47.43 PK	74.00	-26.57	1.18 V	203	8.28	39.15
6	4824.00	37.71 AV	54.00	-16.29	1.18 V	203	-1.44	39.15

- REMARKS:**
1. Emission level (dBuV/m) = Raw Value (dBuV) + Correction Factor (dB/m).
  2. Correction Factor (dB/m) = Antenna Factor (dB/m) + Cable Factor (dB).
  3. The other emission levels were very low against the limit.
  4. Margin value = Emission level – Limit value.
  5. “ \* “: Fundamental frequency.



A D T

EUT TEST CONDITION		MEASUREMENT DETAIL	
CHANNEL	Channel 6	FREQUENCY RANGE	1 ~ 25GHz
INPUT POWER (SYSTEM)	120Vac, 60 Hz	DETECTOR FUNCTION	Peak (PK) Average (AV)
ENVIRONMENTAL CONDITIONS	24deg. C, 64%RH 1000hPa	TESTED BY	Match Tsui

ANTENNA POLARITY & TEST DISTANCE: HORIZONTAL AT 3 M								
NO.	FREQ. (MHz)	EMISSION LEVEL (dBuV/m)	LIMIT (dBuV/m)	MARGIN (dB)	ANTENNA HEIGHT (m)	TABLE ANGLE (Degree)	RAW VALUE (dBuV)	CORRECTION FACTOR (dB/m)
1	*2437.00	105.15 PK			1.28 H	237	71.87	33.28
2	*2437.00	101.01 AV			1.28 H	237	67.73	33.28
3	4874.00	50.11 PK	74.00	-23.89	1.21 H	243	10.96	39.14
4	4874.00	44.41 AV	54.00	-9.59	1.21 H	243	5.26	39.14
5	7311.00	57.61 PK	74.00	-16.39	1.23 H	234	12.08	45.53
6	7311.00	49.60 AV	54.00	-4.40	1.23 H	234	4.07	45.53
ANTENNA POLARITY & TEST DISTANCE: VERTICAL AT 3 M								
NO.	FREQ. (MHz)	EMISSION LEVEL (dBuV/m)	LIMIT (dBuV/m)	MARGIN (dB)	ANTENNA HEIGHT (m)	TABLE ANGLE (Degree)	RAW VALUE (dBuV)	CORRECTION FACTOR (dB/m)
1	*2437.00	100.99PK			1.71 V	156	67.71	33.28
2	*2437.00	96.67AV			1.71 V	156	63.39	33.28
3	4874.00	49.38 PK	74.00	-24.62	1.15 V	174	10.24	39.14
4	4874.00	39.74 AV	54.00	-14.26	1.15 V	174	0.60	39.14
5	7311.00	53.90 PK	74.00	-20.10	1.32 V	173	8.37	45.53
6	7311.00	42.88 AV	54.00	-11.12	1.32 V	173	-2.65	45.53

- REMARKS:**
1. Emission level (dBuV/m) = Raw Value (dBuV) + Correction Factor (dB/m).
  2. Correction Factor (dB/m) = Antenna Factor (dB/m) + Cable Factor (dB).
  3. The other emission levels were very low against the limit.
  4. Margin value = Emission level – Limit value.
  5. “ \* “: Fundamental frequency.



A D T

EUT TEST CONDITION		MEASUREMENT DETAIL	
CHANNEL	Channel 11	FREQUENCY RANGE	1 ~ 25GHz
INPUT POWER (SYSTEM)	120Vac, 60 Hz	DETECTOR FUNCTION	Peak (PK) Average (AV)
ENVIRONMENTAL CONDITIONS	24deg. C, 64%RH 1000hPa	TESTED BY	Match Tsui

ANTENNA POLARITY & TEST DISTANCE: HORIZONTAL AT 3 M								
NO.	FREQ. (MHz)	EMISSION LEVEL (dBuV/m)	LIMIT (dBuV/m)	MARGIN (dB)	ANTENNA HEIGHT (m)	TABLE ANGLE (Degree)	RAW VALUE (dBuV)	CORRECTION FACTOR (dB/m)
1	*2462.00	105.41 PK			1.26 H	235	72.03	33.38
2	*2462.00	100.93 AV			1.26 H	235	67.55	33.38
3	2483.50	61.00 PK	74.00	-13.00	1.28 H	142	27.54	33.46
4	2483.50	52.50 AV	54.00	-1.50	1.28 H	142	19.04	33.46
5	4924.00	50.80 PK	74.00	-23.20	1.09 H	188	11.44	39.35
6	4924.00	43.58 AV	54.00	-10.42	1.09 H	188	4.22	39.35
7	7386.00	56.18 PK	74.00	-17.82	1.45 H	237	10.43	45.76
8	7386.00	47.21 AV	54.00	-6.79	1.45 H	237	1.46	45.76
ANTENNA POLARITY & TEST DISTANCE: VERTICAL AT 3 M								
NO.	FREQ. (MHz)	EMISSION LEVEL (dBuV/m)	LIMIT (dBuV/m)	MARGIN (dB)	ANTENNA HEIGHT (m)	TABLE ANGLE (Degree)	RAW VALUE (dBuV)	CORRECTION FACTOR (dB/m)
1	*2462.00	100.26 PK			1.14 V	156	66.88	33.38
2	*2462.00	96.17 AV			1.14 V	156	62.79	33.38
3	2483.50	59.03 PK	74.00	-14.97	1.17 V	156	25.57	33.46
4	2483.50	49.68 AV	54.00	-4.32	1.17 V	156	16.22	33.46
5	4924.00	47.99 PK	74.00	-26.01	1.16 V	175	8.63	39.35
6	4924.00	39.18 AV	54.00	-14.82	1.16 V	175	-0.18	39.35

- REMARKS:**
1. Emission level (dBuV/m) = Raw Value (dBuV) + Correction Factor (dB/m).
  2. Correction Factor (dB/m) = Antenna Factor (dB/m) + Cable Factor (dB).
  3. The other emission levels were very low against the limit.
  4. Margin value = Emission level – Limit value.
  5. “ \* “: Fundamental frequency.



A D T

### 802.11g OFDM MODULATION

EUT TEST CONDITION		MEASUREMENT DETAIL	
CHANNEL	Channel 1	FREQUENCY RANGE	1 ~ 25GHz
INPUT POWER (SYSTEM)	120Vac, 60 Hz	DETECTOR FUNCTION	Peak (PK) Average (AV)
ENVIRONMENTAL CONDITIONS	24deg. C, 64%RH 1000hPa	TESTED BY	Match Tsui

ANTENNA POLARITY & TEST DISTANCE: HORIZONTAL AT 3 M								
NO.	FREQ. (MHz)	EMISSION LEVEL (dBuV/m)	LIMIT (dBuV/m)	MARGIN (dB)	ANTENNA HEIGHT (m)	TABLE ANGLE (Degree)	RAW VALUE (dBuV)	CORRECTION FACTOR (dB/m)
1	2390.00	65.91 PK	74.00	-8.09	1.06 H	16	32.83	33.08
2	2390.00	49.16 AV	54.00	-4.84	1.06 H	16	16.08	33.08
3	*2412.00	106.66 PK			1.08 H	37	73.48	33.18
4	*2412.00	96.63 AV			1.08 H	37	63.45	33.18
5	4824.00	47.85 PK	74.00	-26.15	1.00 H	0	8.70	39.15
6	4824.00	34.70 AV	54.00	-19.30	1.00 H	0	-4.45	39.15
ANTENNA POLARITY & TEST DISTANCE: VERTICAL AT 3 M								
NO.	FREQ. (MHz)	EMISSION LEVEL (dBuV/m)	LIMIT (dBuV/m)	MARGIN (dB)	ANTENNA HEIGHT (m)	TABLE ANGLE (Degree)	RAW VALUE (dBuV)	CORRECTION FACTOR (dB/m)
1	2390.00	64.27 PK	74.00	-9.73	1.06 V	37	31.19	33.08
2	2390.00	47.57 AV	54.00	-6.43	1.06 V	37	14.49	33.08
3	*2412.00	102.32 PK			1.06 V	37	69.14	33.18
4	*2412.00	92.50 AV			1.06 V	37	59.32	33.18
5	4824.00	47.32 PK	74.00	-26.68	1.16 V	360	8.17	39.15
6	4824.00	34.11 AV	54.00	-19.89	1.16 V	360	-5.04	39.15

- REMARKS:**
1. Emission level (dBuV/m) = Raw Value (dBuV) + Correction Factor (dB/m).
  2. Correction Factor (dB/m) = Antenna Factor (dB/m) + Cable Factor (dB).
  3. The other emission levels were very low against the limit.
  4. Margin value = Emission level – Limit value.
  5. “ \* “: Fundamental frequency.



A D T

EUT TEST CONDITION		MEASUREMENT DETAIL	
CHANNEL	Channel 6	FREQUENCY RANGE	1 ~ 25GHz
INPUT POWER (SYSTEM)	120Vac, 60 Hz	DETECTOR FUNCTION	Peak (PK) Average (AV)
ENVIRONMENTAL CONDITIONS	24deg. C, 64%RH 1000hPa	TESTED BY	Match Tsui

ANTENNA POLARITY & TEST DISTANCE: HORIZONTAL AT 3 M								
NO.	FREQ. (MHz)	EMISSION LEVEL (dBuV/m)	LIMIT (dBuV/m)	MARGIN (dB)	ANTENNA HEIGHT (m)	TABLE ANGLE (Degree)	RAW VALUE (dBuV)	CORRECTION FACTOR (dB/m)
1	*2437.00	106.04 PK			1.07 H	34	72.76	33.28
2	*2437.00	96.04 AV			1.07 H	34	62.76	33.28
3	4874.00	47.11 PK	74.00	-26.89	1.07 H	360	7.96	39.14
4	4874.00	33.94 AV	54.00	-20.06	1.07 H	360	-5.21	39.14
ANTENNA POLARITY & TEST DISTANCE: VERTICAL AT 3 M								
NO.	FREQ. (MHz)	EMISSION LEVEL (dBuV/m)	LIMIT (dBuV/m)	MARGIN (dB)	ANTENNA HEIGHT (m)	TABLE ANGLE (Degree)	RAW VALUE (dBuV)	CORRECTION FACTOR (dB/m)
1	*2437.00	101.46 PK			1.06 V	39	68.18	33.28
2	*2437.00	91.75 AV			1.06 V	39	58.47	33.28
3	4874.00	47.04 PK	74.00	-26.96	1.06 V	0	7.89	39.14
4	4874.00	33.86 AV	54.00	-20.14	1.06 V	0	-5.29	39.14

- REMARKS:**
1. Emission level (dBuV/m) = Raw Value (dBuV) + Correction Factor (dB/m).
  2. Correction Factor (dB/m) = Antenna Factor (dB/m) + Cable Factor (dB).
  3. The other emission levels were very low against the limit.
  4. Margin value = Emission level – Limit value.
  5. “ \* “: Fundamental frequency.



A D T

EUT TEST CONDITION		MEASUREMENT DETAIL	
CHANNEL	Channel 11	FREQUENCY RANGE	1 ~ 25GHz
INPUT POWER (SYSTEM)	120Vac, 60 Hz	DETECTOR FUNCTION	Peak (PK) Average (AV)
ENVIRONMENTAL CONDITIONS	24deg. C, 64%RH 1000hPa	TESTED BY	Match Tsui

ANTENNA POLARITY & TEST DISTANCE: HORIZONTAL AT 3 M								
NO.	FREQ. (MHz)	EMISSION LEVEL (dBuV/m)	LIMIT (dBuV/m)	MARGIN (dB)	ANTENNA HEIGHT (m)	TABLE ANGLE (Degree)	RAW VALUE (dBuV)	CORRECTION FACTOR (dB/m)
1	*2462.00	105.45 PK			1.08 H	35	72.07	33.38
2	*2462.00	95.85 AV			1.08 H	35	62.47	33.38
3	2483.50	63.78 PK	74.00	-10.22	1.05 H	18	30.32	33.46
4	2483.50	50.20 AV	54.00	-3.80	1.05 H	18	16.74	33.46
5	4924.00	47.48 PK	74.00	-26.52	1.05 H	360	8.12	39.35
6	4924.00	34.33 AV	54.00	-19.67	1.05 H	360	-5.03	39.35
ANTENNA POLARITY & TEST DISTANCE: VERTICAL AT 3 M								
NO.	FREQ. (MHz)	EMISSION LEVEL (dBuV/m)	LIMIT (dBuV/m)	MARGIN (dB)	ANTENNA HEIGHT (m)	TABLE ANGLE (Degree)	RAW VALUE (dBuV)	CORRECTION FACTOR (dB/m)
1	*2462.00	101.08 PK			1.26 V	4	67.70	33.38
2	*2462.00	91.34 AV			1.26 V	4	57.96	33.38
3	2483.50	60.64 PK	74.00	-13.36	1.26 V	4	27.18	33.46
4	2483.50	48.78 AV	54.00	-5.22	1.26 V	4	15.32	33.46
5	4924.00	47.45 PK	74.00	-26.55	1.26 V	360	8.09	39.35
6	4924.00	34.26 AV	54.00	-19.74	1.26 V	360	-5.10	39.35

- REMARKS:**
1. Emission level (dBuV/m) = Raw Value (dBuV) + Correction Factor (dB/m).
  2. Correction Factor (dB/m) = Antenna Factor (dB/m) + Cable Factor (dB).
  3. The other emission levels were very low against the limit.
  4. Margin value = Emission level – Limit value.
  5. “ \* “: Fundamental frequency.





A D T

**DRAFT 802.11n (20MHz) OFDM MODULATION**

EUT TEST CONDITION		MEASUREMENT DETAIL	
CHANNEL	Channel 1	FREQUENCY RANGE	1 ~ 25GHz
INPUT POWER (SYSTEM)	120Vac, 60 Hz	DETECTOR FUNCTION	Peak (PK) Average (AV)
ENVIRONMENTAL CONDITIONS	24deg. C, 64%RH 1000hPa	TESTED BY	Match Tsui

ANTENNA POLARITY & TEST DISTANCE: HORIZONTAL AT 3 M								
NO.	FREQ. (MHz)	EMISSION LEVEL (dBuV/m)	LIMIT (dBuV/m)	MARGIN (dB)	ANTENNA HEIGHT (m)	TABLE ANGLE (Degree)	RAW VALUE (dBuV)	CORRECTION FACTOR (dB/m)
1	2390.00	63.54 PK	74.00	-10.46	1.12 H	33	30.46	33.08
2	2390.00	49.46 AV	54.00	-4.54	1.12 H	33	16.38	33.08
3	*2412.00	106.34 PK			1.10 H	34	73.16	33.18
4	*2412.00	96.05 AV			1.10 H	34	62.87	33.18
5	4824.00	47.45 PK	74.00	-26.55	1.12 H	0	8.30	39.15
6	4824.00	34.00 AV	54.00	-20.00	1.12 H	0	-5.15	39.15
ANTENNA POLARITY & TEST DISTANCE: VERTICAL AT 3 M								
NO.	FREQ. (MHz)	EMISSION LEVEL (dBuV/m)	LIMIT (dBuV/m)	MARGIN (dB)	ANTENNA HEIGHT (m)	TABLE ANGLE (Degree)	RAW VALUE (dBuV)	CORRECTION FACTOR (dB/m)
1	2390.00	63.49 PK	74.00	-10.51	1.06 V	39	30.41	33.08
2	2390.00	48.06 AV	54.00	-5.94	1.06 V	39	14.98	33.08
3	*2412.00	102.42 PK			1.06 V	39	69.24	33.18
4	*2412.00	91.97 AV			1.06 V	39	58.79	33.18
5	4824.00	47.03 PK	74.00	-26.97	1.06 V	360	7.88	39.15
6	4824.00	33.68 AV	54.00	-20.32	1.06 V	360	-5.47	39.15

- REMARKS:**
1. Emission level (dBuV/m) = Raw Value (dBuV) + Correction Factor (dB/m).
  2. Correction Factor (dB/m) = Antenna Factor (dB/m) + Cable Factor (dB).
  3. The other emission levels were very low against the limit.
  4. Margin value = Emission level – Limit value.
  5. “ \* “: Fundamental frequency.



A D T

EUT TEST CONDITION		MEASUREMENT DETAIL	
CHANNEL	Channel 6	FREQUENCY RANGE	1 ~ 25GHz
INPUT POWER (SYSTEM)	120Vac, 60 Hz	DETECTOR FUNCTION	Peak (PK) Average (AV)
ENVIRONMENTAL CONDITIONS	24deg. C, 64%RH 1000hPa	TESTED BY	Match Tsui

ANTENNA POLARITY & TEST DISTANCE: HORIZONTAL AT 3 M								
NO.	FREQ. (MHz)	EMISSION LEVEL (dBuV/m)	LIMIT (dBuV/m)	MARGIN (dB)	ANTENNA HEIGHT (m)	TABLE ANGLE (Degree)	RAW VALUE (dBuV)	CORRECTION FACTOR (dB/m)
1	*2437.00	105.99 PK			1.06 H	35	72.71	33.28
2	*2437.00	95.97 AV			1.06 H	35	62.69	33.28
3	4874.00	46.86 PK	74.00	-27.14	1.06 H	0	7.71	39.14
4	4874.00	33.86 AV	54.00	-20.14	1.06 H	0	-5.29	39.14

ANTENNA POLARITY & TEST DISTANCE: VERTICAL AT 3 M								
NO.	FREQ. (MHz)	EMISSION LEVEL (dBuV/m)	LIMIT (dBuV/m)	MARGIN (dB)	ANTENNA HEIGHT (m)	TABLE ANGLE (Degree)	RAW VALUE (dBuV)	CORRECTION FACTOR (dB/m)
1	*2437.00	101.65 PK			1.06 V	39	68.37	33.28
2	*2437.00	91.56 AV			1.06 V	39	58.28	33.28
3	4874.00	46.96 PK	74.00	-27.04	1.06 V	360	7.81	39.14
4	4874.00	33.79 AV	54.00	-20.21	1.06 V	360	-5.36	39.14

- REMARKS:**
1. Emission level (dBuV/m) = Raw Value (dBuV) + Correction Factor (dB/m).
  2. Correction Factor (dB/m) = Antenna Factor (dB/m) + Cable Factor (dB).
  3. The other emission levels were very low against the limit.
  4. Margin value = Emission level – Limit value.
  5. “ \* “: Fundamental frequency.



A D T

EUT TEST CONDITION		MEASUREMENT DETAIL	
CHANNEL	Channel 11	FREQUENCY RANGE	1 ~ 25GHz
INPUT POWER (SYSTEM)	120Vac, 60 Hz	DETECTOR FUNCTION	Peak (PK) Average (AV)
ENVIRONMENTAL CONDITIONS	24deg. C, 64%RH 1000hPa	TESTED BY	Match Tsui

ANTENNA POLARITY & TEST DISTANCE: HORIZONTAL AT 3 M								
NO.	FREQ. (MHz)	EMISSION LEVEL (dBuV/m)	LIMIT (dBuV/m)	MARGIN (dB)	ANTENNA HEIGHT (m)	TABLE ANGLE (Degree)	RAW VALUE (dBuV)	CORRECTION FACTOR (dB/m)
1	*2462.00	105.59 PK			1.05 H	35	72.21	33.38
2	*2462.00	95.13 AV			1.05 H	35	61.75	33.38
3	2483.50	66.85 PK	74.00	-7.15	1.05 H	31	33.39	33.46
4	2483.50	50.72 AV	54.00	-3.28	1.05 H	31	17.26	33.46
5	4924.00	47.28 PK	74.00	-26.72	1.05 H	360	7.92	39.35
6	4924.00	34.01 AV	54.00	-19.99	1.05 H	360	-5.35	39.35
ANTENNA POLARITY & TEST DISTANCE: VERTICAL AT 3 M								
NO.	FREQ. (MHz)	EMISSION LEVEL (dBuV/m)	LIMIT (dBuV/m)	MARGIN (dB)	ANTENNA HEIGHT (m)	TABLE ANGLE (Degree)	RAW VALUE (dBuV)	CORRECTION FACTOR (dB/m)
1	*2462.00	101.43 PK			1.25 V	3	68.05	33.38
2	*2462.00	90.96 AV			1.25 V	3	57.58	33.38
3	2483.50	64.29 PK	74.00	-9.71	1.25 V	3	30.83	33.46
4	2483.50	49.32 AV	54.00	-4.68	1.25 V	3	15.86	33.46
5	4924.00	47.27 PK	74.00	-26.73	1.25 V	0	7.91	39.35
6	4924.00	33.91 AV	54.00	-20.09	1.25 V	0	-5.45	39.35

- REMARKS:**
1. Emission level (dBuV/m) = Raw Value (dBuV) + Correction Factor (dB/m).
  2. Correction Factor (dB/m) = Antenna Factor (dB/m) + Cable Factor (dB).
  3. The other emission levels were very low against the limit.
  4. Margin value = Emission level – Limit value.
  5. “ \* “: Fundamental frequency.



A D T

**DRAFT 802.11n (40MHz) OFDM MODULATION**

EUT TEST CONDITION		MEASUREMENT DETAIL	
CHANNEL	Channel 1	FREQUENCY RANGE	1 ~ 25GHz
INPUT POWER (SYSTEM)	120Vac, 60 Hz	DETECTOR FUNCTION	Peak (PK) Average (AV)
ENVIRONMENTAL CONDITIONS	24deg. C, 64%RH 1000hPa	TESTED BY	Match Tsui

ANTENNA POLARITY & TEST DISTANCE: HORIZONTAL AT 3 M								
NO.	FREQ. (MHz)	EMISSION LEVEL (dBuV/m)	LIMIT (dBuV/m)	MARGIN (dB)	ANTENNA HEIGHT (m)	TABLE ANGLE (Degree)	RAW VALUE (dBuV)	CORRECTION FACTOR (dB/m)
1	2386.00	65.31 PK	74.00	-8.69	1.10 H	35	32.25	33.06
2	2386.00	52.33 AV	54.00	-1.67	1.10 H	35	19.27	33.06
3	*2422.00	102.07 PK			1.10 H	35	68.85	33.22
4	*2422.00	91.84 AV			1.10 H	35	58.62	33.22
5	4844.00	47.14 PK	74.00	-26.86	1.10 H	360	8.00	39.15
6	4844.00	33.74 AV	54.00	-20.26	1.10 H	360	-5.40	39.15
ANTENNA POLARITY & TEST DISTANCE: VERTICAL AT 3 M								
NO.	FREQ. (MHz)	EMISSION LEVEL (dBuV/m)	LIMIT (dBuV/m)	MARGIN (dB)	ANTENNA HEIGHT (m)	TABLE ANGLE (Degree)	RAW VALUE (dBuV)	CORRECTION FACTOR (dB/m)
1	2387.00	60.71 PK	74.00	-13.29	1.02 V	36	27.65	33.06
2	2387.00	48.88 AV	54.00	-5.12	1.02 V	36	15.82	33.06
3	*2422.00	97.64 PK			1.02 V	36	64.42	33.22
4	*2422.00	87.40 AV			1.02 V	36	54.18	33.22
5	4844.00	46.52 PK	74.00	-27.48	1.10 V	360	7.37	39.15
6	4844.00	33.37 AV	54.00	-20.63	1.10 V	360	-5.78	39.15

- REMARKS:**
1. Emission level (dBuV/m) = Raw Value (dBuV) + Correction Factor (dB/m).
  2. Correction Factor (dB/m) = Antenna Factor (dB/m) + Cable Factor (dB).
  3. The other emission levels were very low against the limit.
  4. Margin value = Emission level – Limit value.
  5. “ \* “: Fundamental frequency.



A D T

EUT TEST CONDITION		MEASUREMENT DETAIL	
CHANNEL	Channel 4	FREQUENCY RANGE	1 ~ 25GHz
INPUT POWER (SYSTEM)	120Vac, 60 Hz	DETECTOR FUNCTION	Peak (PK) Average (AV)
ENVIRONMENTAL CONDITIONS	24deg. C, 64%RH 1000hPa	TESTED BY	Match Tsui

ANTENNA POLARITY & TEST DISTANCE: HORIZONTAL AT 3 M								
NO.	FREQ. (MHz)	EMISSION LEVEL (dBuV/m)	LIMIT (dBuV/m)	MARGIN (dB)	ANTENNA HEIGHT (m)	TABLE ANGLE (Degree)	RAW VALUE (dBuV)	CORRECTION FACTOR (dB/m)
1	2390.00	65.21 PK	74.00	-8.79	1.11 H	37	32.13	33.08
2	2390.00	49.46 AV	54.00	-4.54	1.11 H	37	16.38	33.08
3	*2437.00	103.66 PK			1.08 H	34	70.38	33.28
4	*2437.00	93.19 AV			1.08 H	34	59.91	33.28
5	2483.50	62.54 PK	74.00	-11.46	1.03 H	35	29.08	33.46
6	2483.50	49.87 AV	54.00	-4.13	1.03 H	35	16.41	33.46
7	4874.00	47.01 PK	74.00	-26.99	1.03 H	0	7.86	39.14
8	4874.00	33.96 AV	54.00	-20.04	1.03 H	0	-5.19	39.14
ANTENNA POLARITY & TEST DISTANCE: VERTICAL AT 3 M								
NO.	FREQ. (MHz)	EMISSION LEVEL (dBuV/m)	LIMIT (dBuV/m)	MARGIN (dB)	ANTENNA HEIGHT (m)	TABLE ANGLE (Degree)	RAW VALUE (dBuV)	CORRECTION FACTOR (dB/m)
1	*2437.00	97.94 PK			1.03 V	37	64.66	33.28
2	*2437.00	87.72 AV			1.03 V	37	54.44	33.28
3	4874.00	47.22 PK	74.00	-26.78	1.08 V	360	8.07	39.14
4	4874.00	34.05 AV	54.00	-19.95	1.08 V	360	-5.10	39.14

- REMARKS:**
1. Emission level (dBuV/m) = Raw Value (dBuV) + Correction Factor (dB/m).
  2. Correction Factor (dB/m) = Antenna Factor (dB/m) + Cable Factor (dB).
  3. The other emission levels were very low against the limit.
  4. Margin value = Emission level – Limit value.
  5. “ \* “: Fundamental frequency.



A D T

EUT TEST CONDITION		MEASUREMENT DETAIL	
CHANNEL	Channel 7	FREQUENCY RANGE	1 ~ 25GHz
INPUT POWER (SYSTEM)	120Vac, 60 Hz	DETECTOR FUNCTION	Peak (PK) Average (AV)
ENVIRONMENTAL CONDITIONS	24deg. C, 64%RH 1000hPa	TESTED BY	Match Tsui

ANTENNA POLARITY & TEST DISTANCE: HORIZONTAL AT 3 M								
NO.	FREQ. (MHz)	EMISSION LEVEL (dBuV/m)	LIMIT (dBuV/m)	MARGIN (dB)	ANTENNA HEIGHT (m)	TABLE ANGLE (Degree)	RAW VALUE (dBuV)	CORRECTION FACTOR (dB/m)
1	*2452.00	101.69 PK			1.34 H	230	68.35	33.34
2	*2452.00	91.49 AV			1.34 H	230	58.15	33.34
3	2487.00	68.33 PK	74.00	-5.67	1.32 H	233	34.85	33.48
4	2487.00	52.19 AV	54.00	-1.81	1.32 H	233	18.71	33.48
5	4904.00	47.14 PK	74.00	-26.86	1.34 H	360	7.96	39.18
6	4904.00	34.07 AV	54.00	-19.93	1.34 H	360	-5.11	39.18
ANTENNA POLARITY & TEST DISTANCE: VERTICAL AT 3 M								
NO.	FREQ. (MHz)	EMISSION LEVEL (dBuV/m)	LIMIT (dBuV/m)	MARGIN (dB)	ANTENNA HEIGHT (m)	TABLE ANGLE (Degree)	RAW VALUE (dBuV)	CORRECTION FACTOR (dB/m)
1	*2452.00	97.37 PK			1.04 V	51	64.03	33.34
2	*2452.00	87.12 AV			1.04 V	51	53.78	33.34
3	2487.00	61.52 PK	74.00	-12.48	1.04 V	51	28.04	33.48
4	2487.00	49.22 AV	54.00	-4.78	1.04 V	51	15.74	33.48
5	4904.00	47.13 PK	74.00	-26.87	1.10 V	0	7.95	39.18
6	4904.00	33.73 AV	54.00	-20.27	1.10 V	0	-5.45	39.18

- REMARKS:**
1. Emission level (dBuV/m) = Raw Value (dBuV) + Correction Factor (dB/m).
  2. Correction Factor (dB/m) = Antenna Factor (dB/m) + Cable Factor (dB).
  3. The other emission levels were very low against the limit.
  4. Margin value = Emission level – Limit value.
  5. “ \* “: Fundamental frequency.



A D T

**BELOW 1GHz WORST-CASE DATA : DRAFT 802.11n (20MHz) OFDM MODULATION**

EUT TEST CONDITION		MEASUREMENT DETAIL	
CHANNEL	Channel 6	FREQUENCY RANGE	Below 1000MHz
INPUT POWER (SYSTEM)	120Vac, 60 Hz	DETECTOR FUNCTION	Quasi-Peak
ENVIRONMENTAL CONDITIONS	20deg. C, 70%RH 999hPa	TESTED BY	Lori Chiu

ANTENNA POLARITY & TEST DISTANCE: HORIZONTAL AT 3 M								
NO.	FREQ. (MHz)	EMISSION LEVEL (dBuV/m)	LIMIT (dBuV/m)	MARGIN (dB)	ANTENNA HEIGHT (m)	TABLE ANGLE (Degree)	RAW VALUE (dBuV)	CORRECTION FACTOR (dB/m)
1	360.43	32.53 QP	46.00	-13.47	1.00 H	10	17.43	15.10
2	479.03	32.75 QP	46.00	-13.25	2.00 H	271	14.14	18.60
3	599.58	38.56 QP	46.00	-7.44	1.25 H	277	16.66	21.90
4	720.12	36.50 QP	46.00	-9.50	1.50 H	283	13.28	23.22
5	799.84	34.90 QP	46.00	-11.10	1.00 H	253	9.58	25.32
6	834.84	43.29 QP	46.00	-2.71	1.50 H	70	17.76	25.54
7	951.49	38.01 QP	46.00	-7.99	1.00 H	10	11.51	26.50
ANTENNA POLARITY & TEST DISTANCE: VERTICAL AT 3 M								
NO.	FREQ. (MHz)	EMISSION LEVEL (dBuV/m)	LIMIT (dBuV/m)	MARGIN (dB)	ANTENNA HEIGHT (m)	TABLE ANGLE (Degree)	RAW VALUE (dBuV)	CORRECTION FACTOR (dB/m)
1	31.84	34.74 QP	40.00	-5.26	1.00 V	307	22.52	12.22
2	64.90	30.24 QP	40.00	-9.76	1.00 V	268	17.75	12.48
3	599.58	35.17 QP	46.00	-10.83	1.50 V	304	13.27	21.90
4	720.12	40.94 QP	46.00	-5.06	1.25 V	301	17.72	23.22
5	840.67	38.14 QP	46.00	-7.87	1.50 V	190	13.19	24.94
6	902.89	38.51 QP	46.00	-7.49	1.25 V	319	12.01	26.50

- REMARKS:**
1. Emission level (dBuV/m) = Raw Value (dBuV) + Correction Factor (dB/m).
  2. Correction Factor (dB/m) = Antenna Factor (dB/m) + Cable Factor (dB).
  3. The other emission levels were very low against the limit.
  4. Margin value = Emission level – Limit value.



## 4.2 CONDUCTED EMISSION MEASUREMENT

### 4.2.1 LIMITS OF CONDUCTED EMISSION MEASUREMENT

FREQUENCY OF EMISSION (MHz)	CONDUCTED LIMIT (dBµV)	
	Quasi-peak	Average
0.15 ~ 0.5	66 to 56	56 to 46
0.5 ~ 5	56	46
5 ~ 30	60	50

- NOTE:** 1. The lower limit shall apply at the transition frequencies.  
2. The limit decreases in line with the logarithm of the frequency in the range of 0.15 to 0.50MHz.  
3. All emanations from a class A/B digital device or system, including any network of conductors and apparatus connected thereto, shall not exceed the level of field strengths specified above.

### 4.2.2 TEST INSTRUMENTS

DESCRIPTION & MANUFACTURER	MODEL NO.	SERIAL NO.	DATE OF CALIBRATION	DUE DATE OF CALIBRATION
Test Receiver ROHDE & SCHWARZ	ESCS30	100291	Nov. 19, 2008	Nov. 18, 2009
RF signal cable Woken	5D-FB	Cable-HYC01-01	Dec. 31, 2008	Dec. 30, 2009
LISN ROHDE & SCHWARZ	ESH3-Z5	100312	Jun. 13, 2008	Jun. 12, 2009
LISN ROHDE & SCHWARZ	ESH2-Z5	100104	Dec. 04, 2008	Dec. 03, 2009
Software ADT	ADT_Cond_ V7.3.6	NA	NA	NA

- NOTE:** 1. The calibration interval of the above test instruments is 12 months and the calibrations are traceable to NML/ROC and NIST/USA.  
2. The test was performed in HwaYa Shielded Room 1.  
3. The VCCI Site Registration No. is C-2040.





A D T

#### 4.2.3 TEST PROCEDURES

- a. The EUT was placed 0.4 meters from the conducting wall of the shielded room with EUT being connected to the power mains through a line impedance stabilization network (LISN). Other support units were connected to the power mains through another LISN. The two LISNs provide 50 ohm/ 50uH of coupling impedance for the measuring instrument.
- b. Both lines of the power mains connected to the EUT were checked for maximum conducted interference.
- c. The frequency range from 150kHz to 30MHz was searched. Emission levels under (Limit - 20dB) was not recorded.

**NOTE:** All modes of operation were investigated and the worst-case emissions are reported.

#### 4.2.4 DEVIATION FROM TEST STANDARD

No deviation.

#### 4.2.5 TEST SETUP

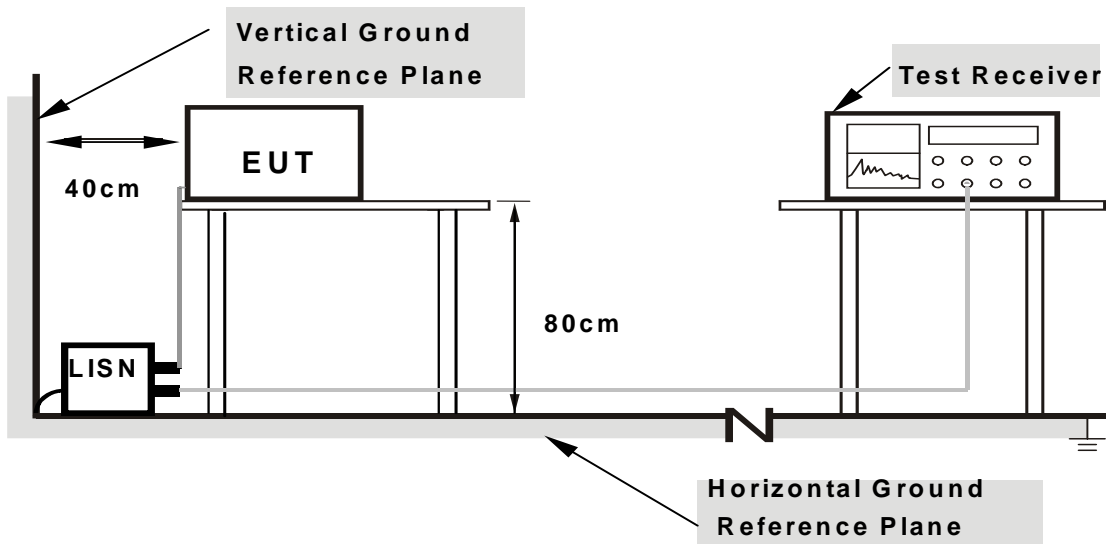

- Note:**
1. Support units were connected to second LISN.
  2. Both of LISNs (AMN) are 80 cm from EUT and at least 80 from other units and other metal planes

For the actual test configuration, please refer to the attached file (Test Setup Photo).

#### 4.2.6 EUT OPERATING CONDITIONS

Same as 4.1.6.



### 4.2.7 TEST RESULTS

#### CONDUCTED WORST-CASE DATA : DRAFT 802.11n (20MHz) OFDM MODULATION

EUT TEST CONDITION		MEASUREMENT DETAIL	
CHANNEL	Channel 6	PHASE	Line 1
MODULATION TYPE	BPSK	INPUT POWER	120Vac, 60Hz
TRANSFER RATE	7.2Mbps	6dB BANDWIDTH	9kHz
ENVIRONMENTAL CONDITIONS	22deg. C, 65%RH, 1021hPa	TESTED BY	Antony Lee

No	Freq. [MHz]	Corr. Factor (dB)	Reading Value		Emission Level		Limit		Margin	
			[dB (uV)]		[dB (uV)]		[dB (uV)]		(dB)	
			Q.P.	AV.	Q.P.	AV.	Q.P.	AV.	Q.P.	AV.
1	0.173	0.13	50.22	-	50.35	-	64.79	54.79	-14.44	-
2	0.230	0.13	42.92	-	43.05	-	62.44	52.44	-19.39	-
3	1.499	0.20	35.33	-	35.53	-	56.00	46.00	-20.47	-
4	3.516	0.36	37.26	-	37.62	-	56.00	46.00	-18.38	-
5	3.861	0.39	39.65	-	40.04	-	56.00	46.00	-15.96	-
6	18.902	1.11	29.19	-	30.30	-	60.00	50.00	-29.70	-

- REMARKS:**
1. Q.P. and AV. are abbreviations of quasi-peak and average individually.
  2. "-": The Quasi-peak reading value also meets average limit and measurement with the average detector is unnecessary.
  3. The emission levels of other frequencies were very low against the limit.
  4. Margin value = Emission level - Limit value
  5. Correction factor = Insertion loss + Cable loss
  6. Emission Level = Correction Factor + Reading Value.

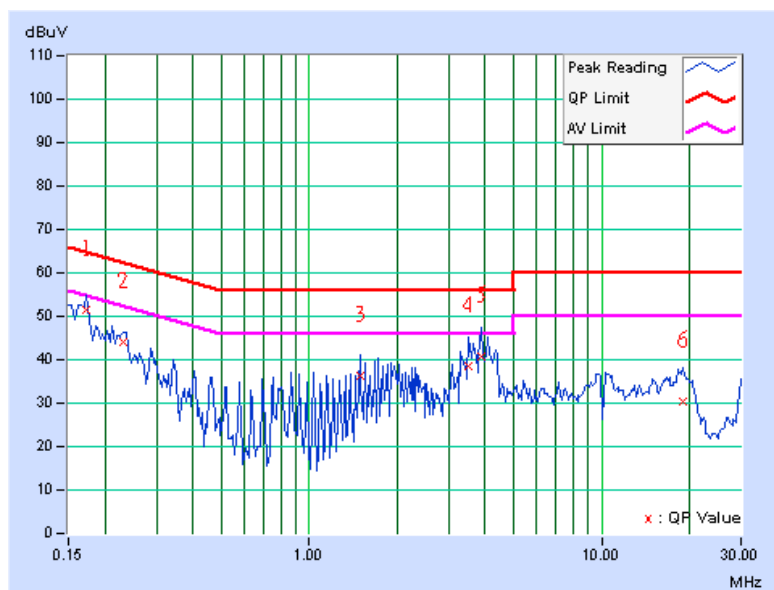

EUT TEST CONDITION		MEASUREMENT DETAIL	
CHANNEL	Channel 6	PHASE	Line 2
MODULATION TYPE	BPSK	INPUT POWER	120Vac, 60Hz
TRANSFER RATE	7.2Mbps	6dB BANDWIDTH	9kHz
ENVIRONMENTAL CONDITIONS	22deg. C, 65%RH, 1021hPa	TESTED BY	Antony Lee

No	Freq. [MHz]	Corr. Factor (dB)	Reading Value		Emission Level		Limit		Margin	
			[dB (uV)]		[dB (uV)]		[dB (uV)]		(dB)	
			Q.P.	AV.	Q.P.	AV.	Q.P.	AV.	Q.P.	AV.
1	0.173	0.14	50.62	-	50.76	-	64.79	54.79	-14.03	-
2	0.228	0.15	42.67	-	42.82	-	62.52	52.52	-19.70	-
3	0.287	0.15	37.67	-	37.82	-	60.62	50.62	-22.79	-
4	1.902	0.25	35.69	-	35.94	-	56.00	46.00	-20.06	-
5	3.859	0.41	39.61	-	40.02	-	56.00	46.00	-15.98	-
6	9.848	0.61	32.91	-	33.52	-	60.00	50.00	-26.48	-

- REMARKS:**
1. Q.P. and AV. are abbreviations of quasi-peak and average individually.
  2. "-": The Quasi-peak reading value also meets average limit and measurement with the average detector is unnecessary.
  3. The emission levels of other frequencies were very low against the limit.
  4. Margin value = Emission level - Limit value
  5. Correction factor = Insertion loss + Cable loss
  6. Emission Level = Correction Factor + Reading Value.

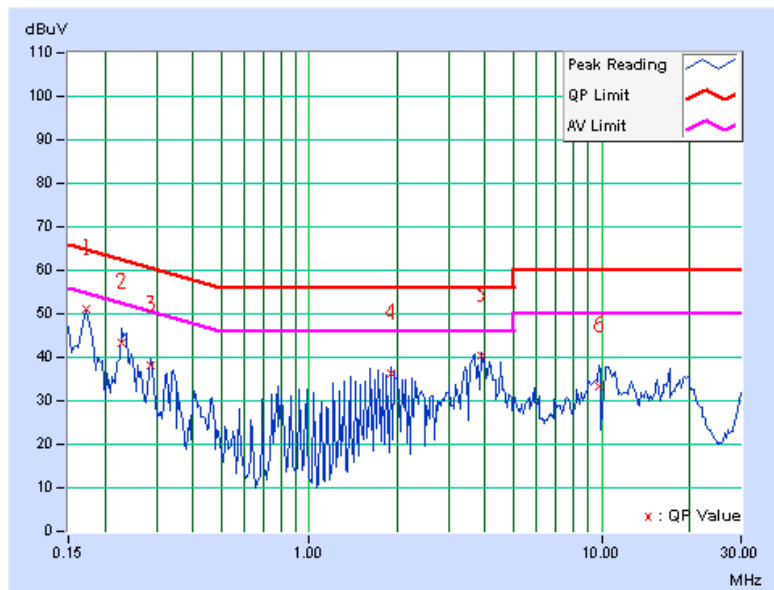



A D T

### 4.3 6dB BANDWIDTH MEASUREMENT

#### 4.3.1 LIMITS OF 6dB BANDWIDTH MEASUREMENT

The minimum of 6dB Bandwidth Measurement is 0.5 MHz.

#### 4.3.2 TEST INSTRUMENTS

DESCRIPTION & MANUFACTURER	MODEL NO.	SERIAL NO.	DATE OF CALIBRATION	CALIBRATED UNTIL
R&S SPECTRUM ANALYZER	FSP40	100041	Apr. 22, 2008	Apr. 21, 2009

**NOTE:** The calibration interval of the above test instruments is 12 months and the calibrations are traceable to NML/ROC and NIST/USA.

#### 4.3.3 TEST PROCEDURE

The transmitter output was connected to the spectrum analyzer through an attenuator. The bandwidth of the fundamental frequency was measured by spectrum analyzer with 100kHz RBW and 300kHz VBW. The 6dB bandwidth is defined as the total spectrum the power of which is higher than peak power minus 6dB.

#### 4.3.4 DEVIATION FROM TEST STANDARD

No deviation.

#### 4.3.5 TEST SETUP

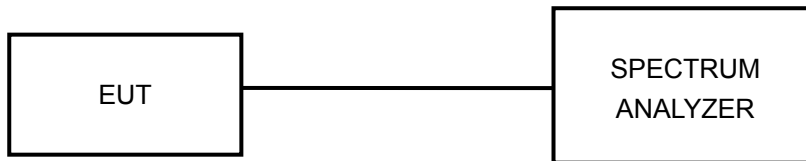

#### 4.3.6 EUT OPERATING CONDITIONS

The software provided by client to enable the EUT under transmission condition continuously at lowest, middle and highest channel frequencies individually.



A D T

### 4.3.7 TEST RESULTS

#### 802.11b DSSS MODULATION

<b>MODULATION TYPE</b>	DBPSK	<b>TRANSFER RATE</b>	1.0Mbps
<b>INPUT POWER</b>	120Vac, 60Hz	<b>ENVIRONMENTAL CONDITIONS</b>	24 deg.C, 64 %RH, 1021hPa
<b>TESTED BY</b>	Match Tsui		

CHANNEL	CHANNEL FREQUENCY (MHz)	6dB BANDWIDTH (MHz)		MINIMUM LIMIT (MHz)	PASS / FAIL
		CHAIN 0	CHAIN 1		
1	2412	12.18	12.21	0.5	PASS
6	2437	12.21	12.25	0.5	PASS
11	2462	12.22	12.28	0.5	PASS



A D T

### FOR CHAIN 0: CH 1

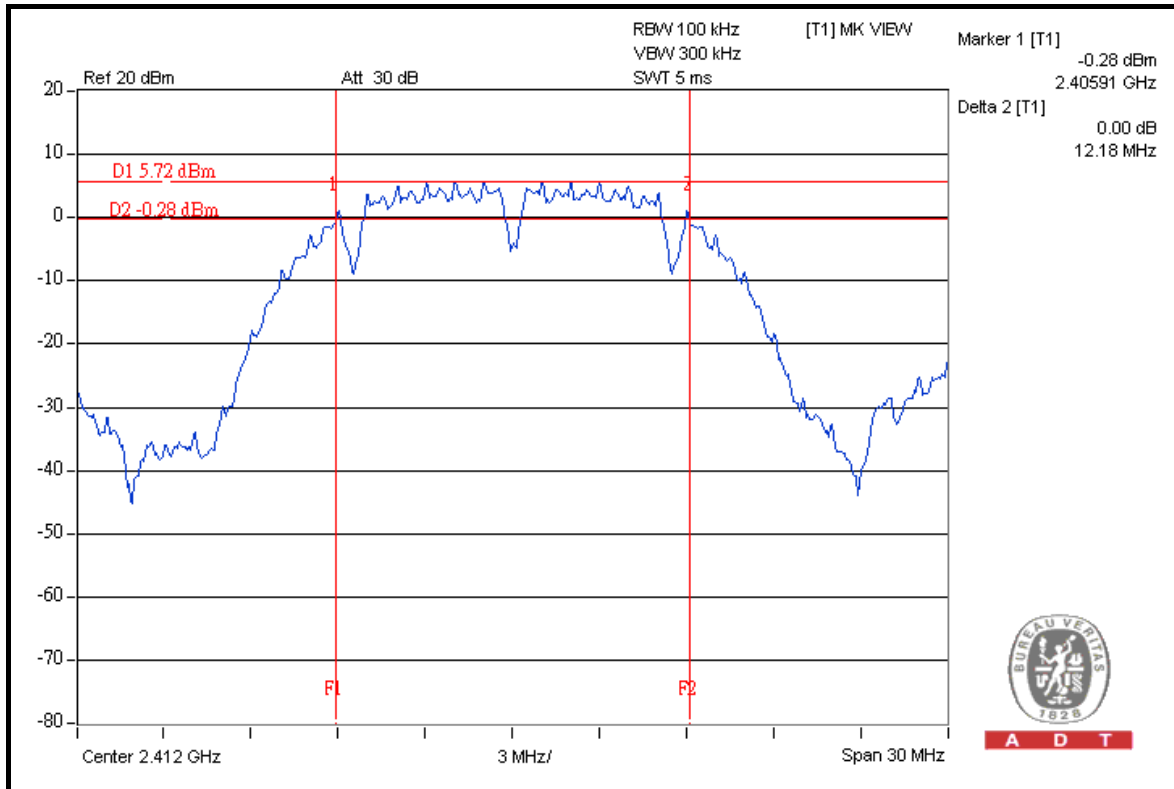

### CH 6

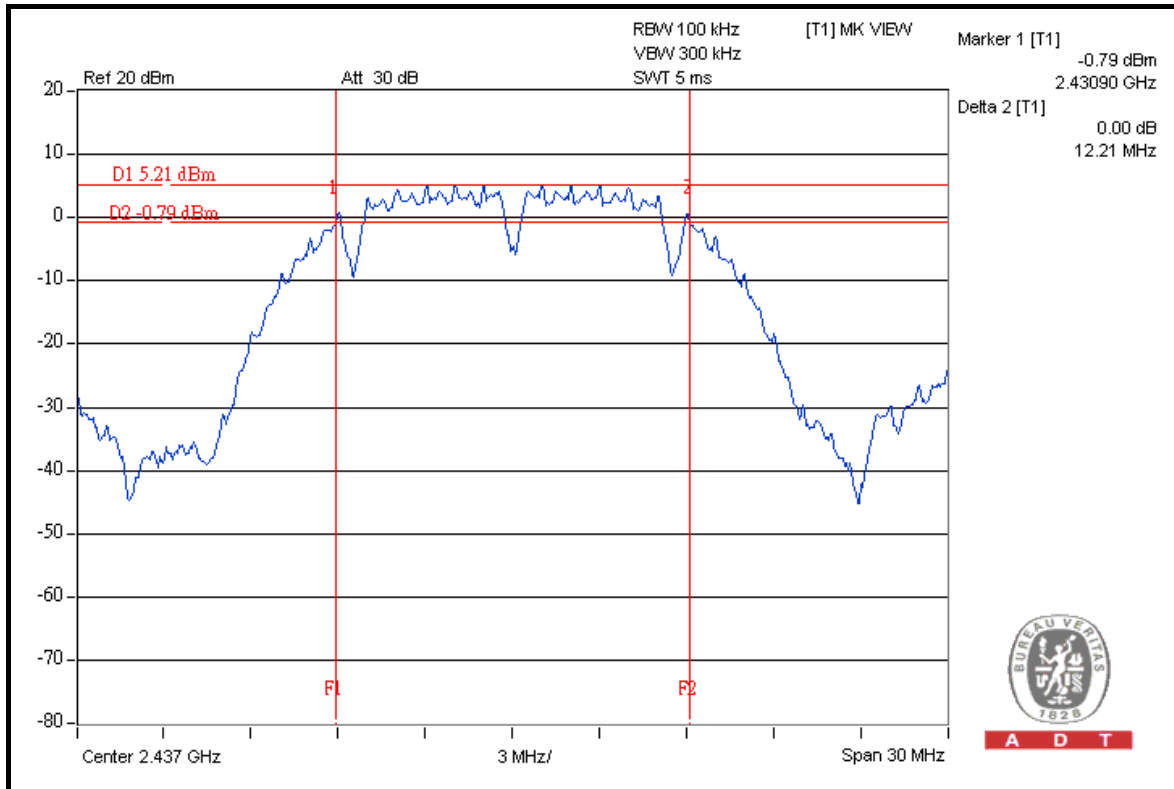





A D T

### CH 11

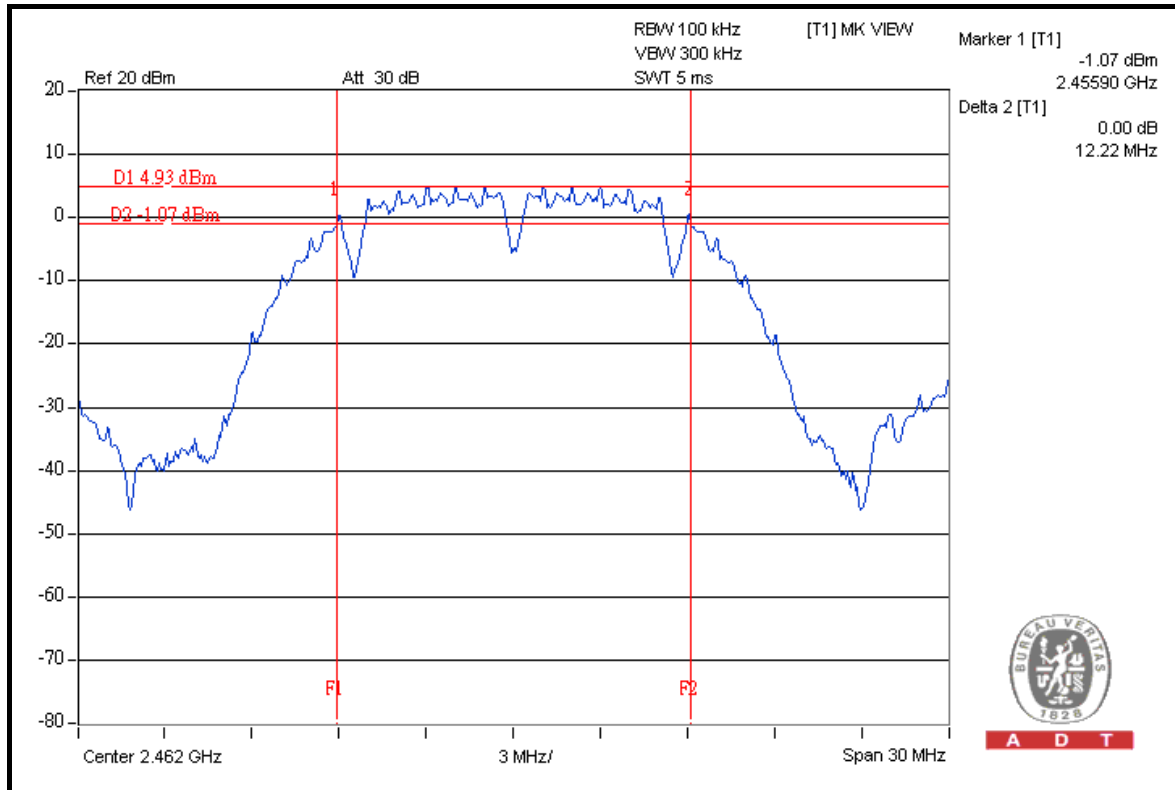

A D T

### FOR CHAIN 1: CH 1

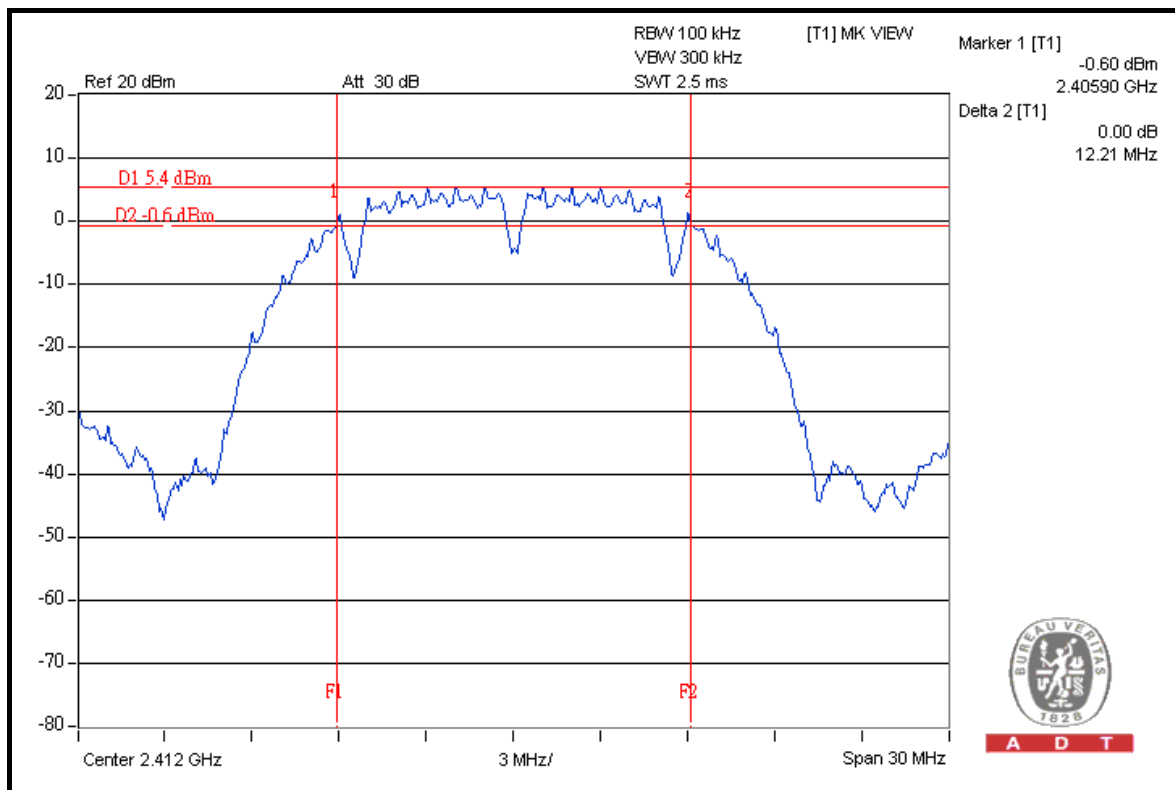

A D T



A D T

### CH 6

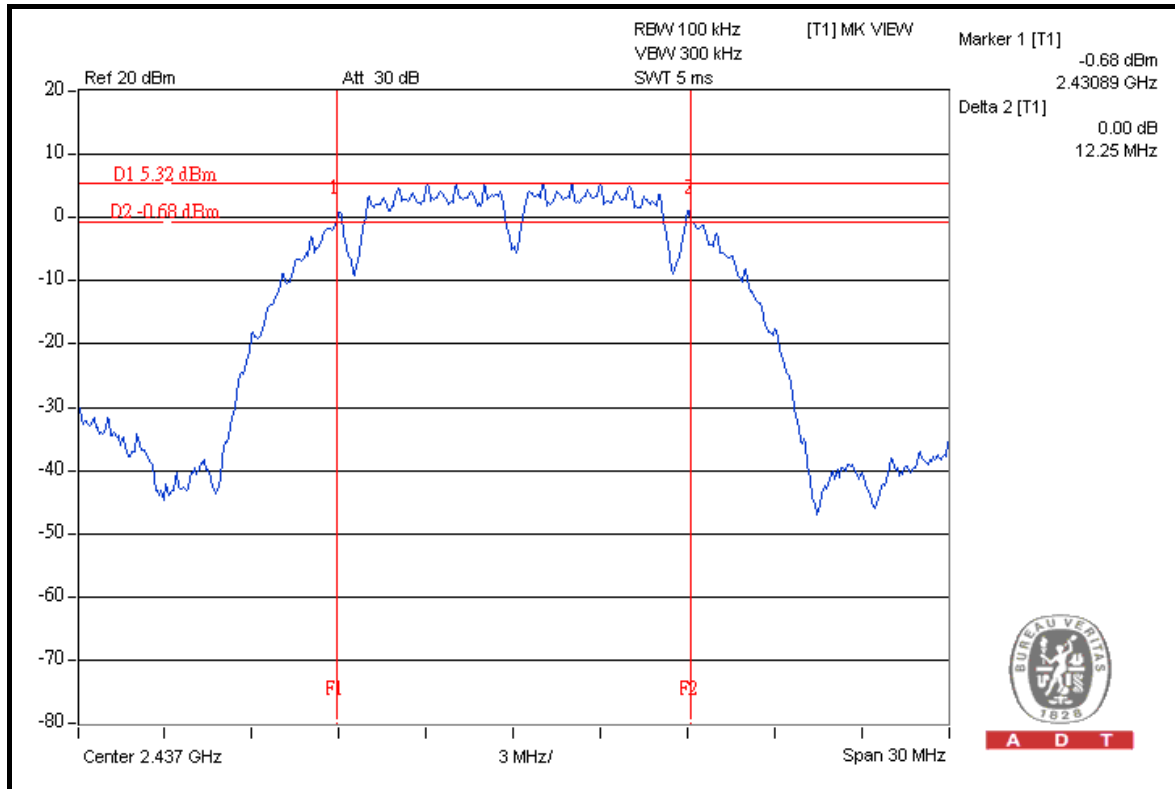

### CH 11

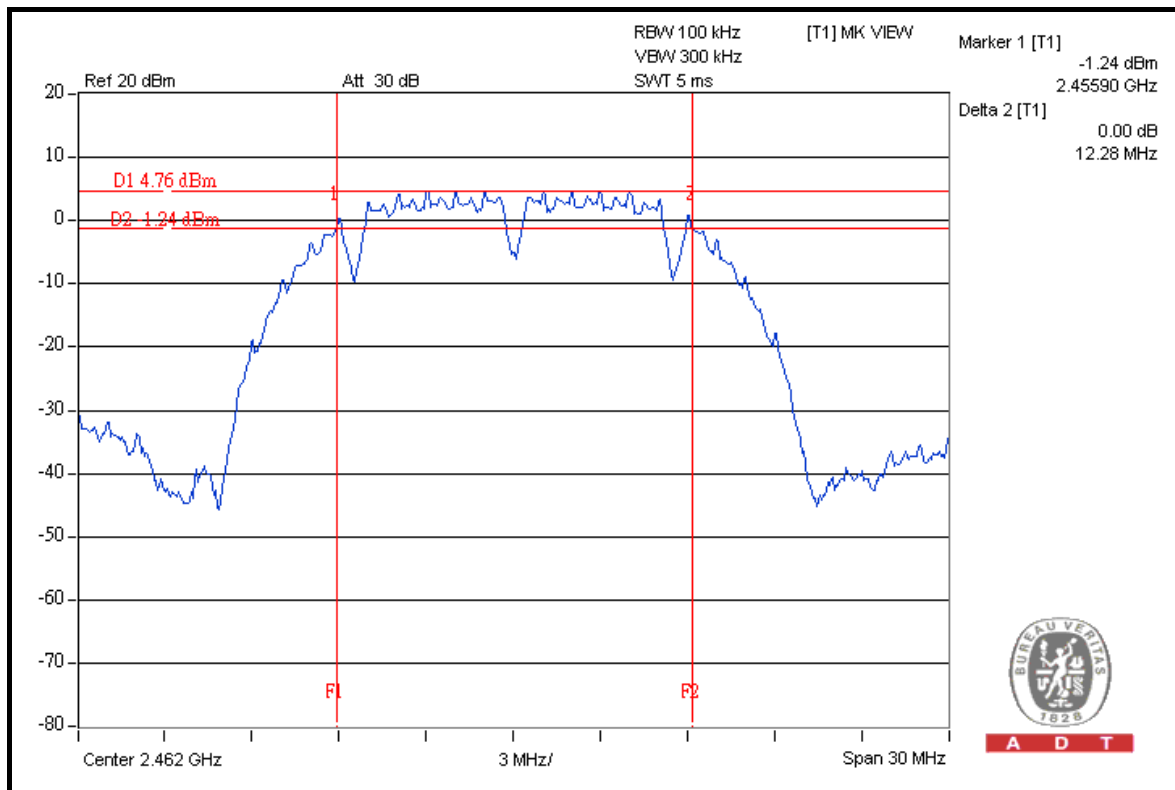



A D T

### 802.11g OFDM MODULATION

<b>MODULATION TYPE</b>	BPSK	<b>TRANSFER RATE</b>	6.0Mbps
<b>INPUT POWER</b>	120Vac, 60Hz	<b>ENVIRONMENTAL CONDITIONS</b>	24 deg.C, 64 %RH, 1021hPa
<b>TESTED BY</b>	Match Tsui		

CHANNEL	CHANNEL FREQUENCY (MHz)	6dB BANDWIDTH (MHz)		MINIMUM LIMIT (MHz)	PASS / FAIL
		CHAIN 0	CHAIN 1		
1	2412	16.59	16.61	0.5	PASS
6	2437	16.63	16.65	0.5	PASS
11	2462	16.62	16.61	10.5	PASS



A D T

### FOR CHAIN 0: CH 1

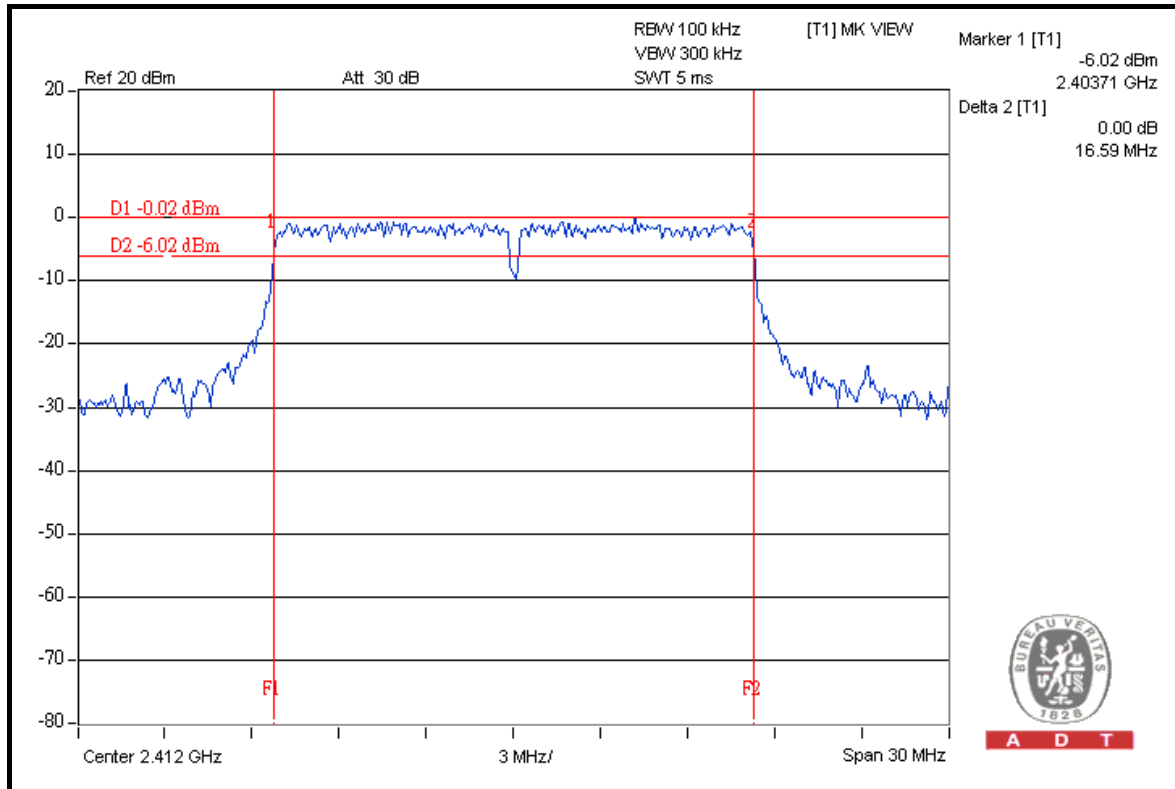

### CH 6

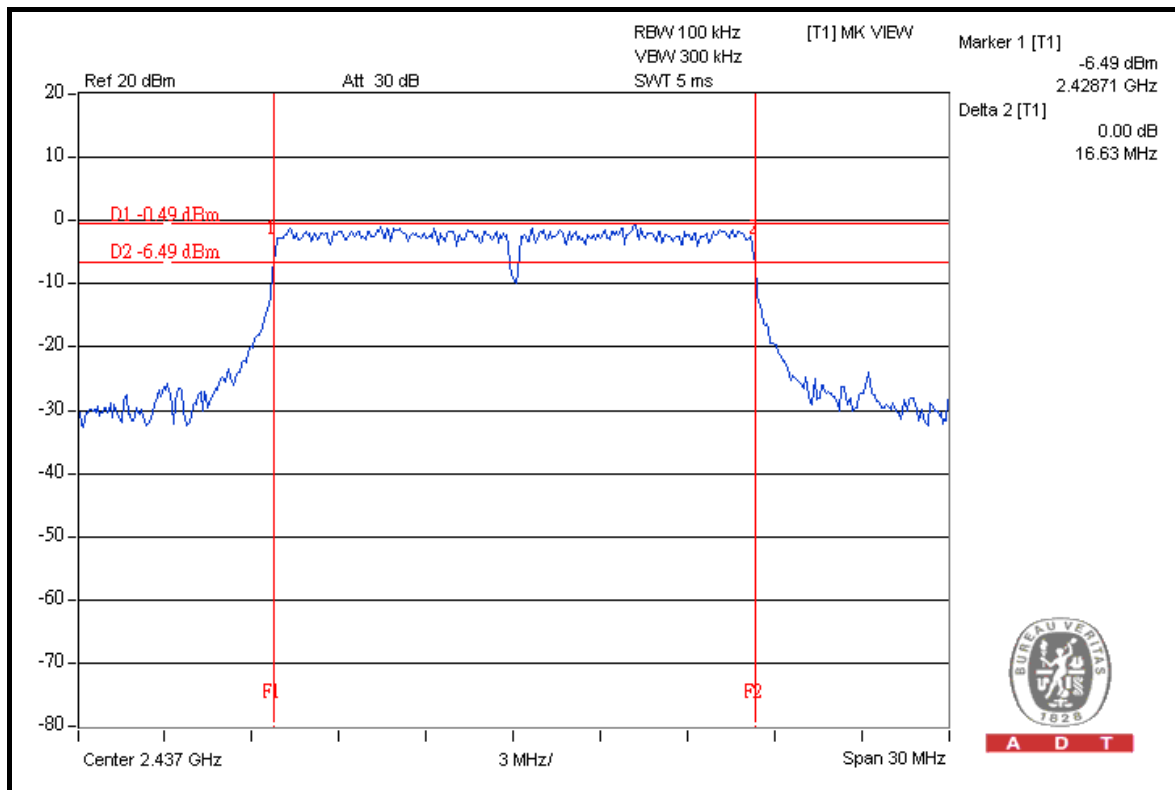



A D T

### CH 11

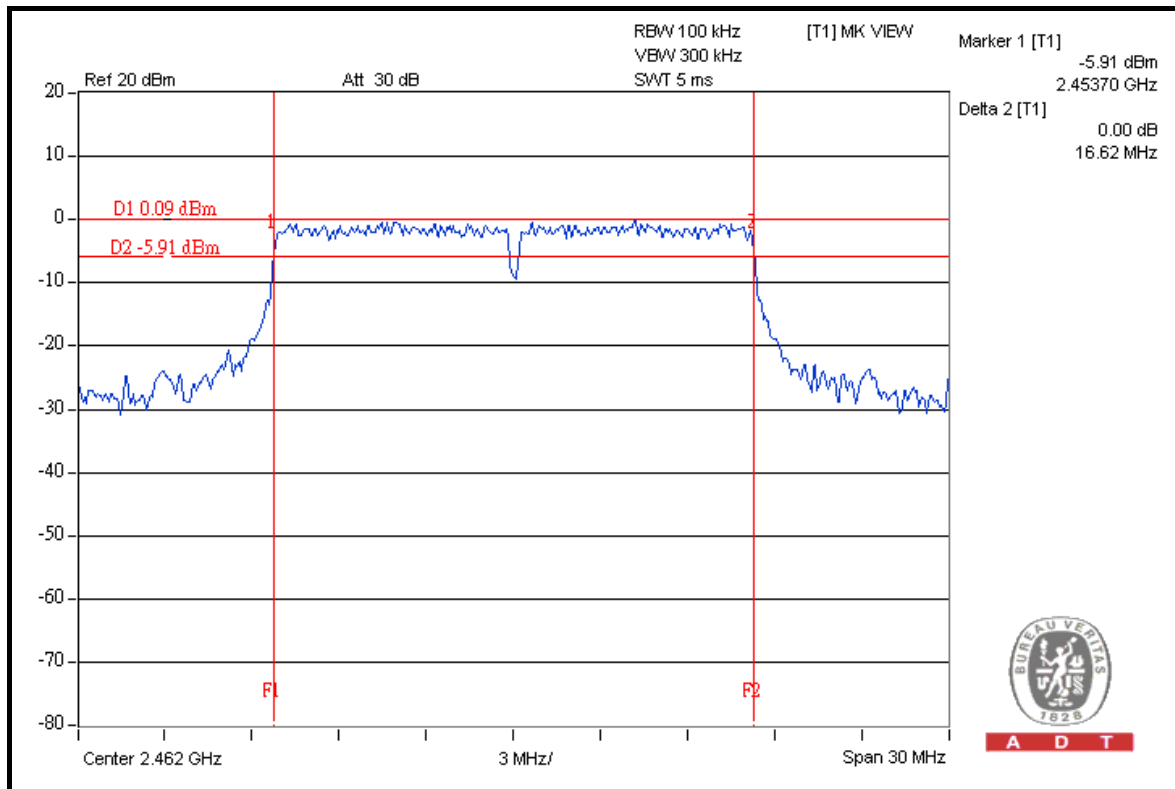

### FOR CHAIN 1: CH 1

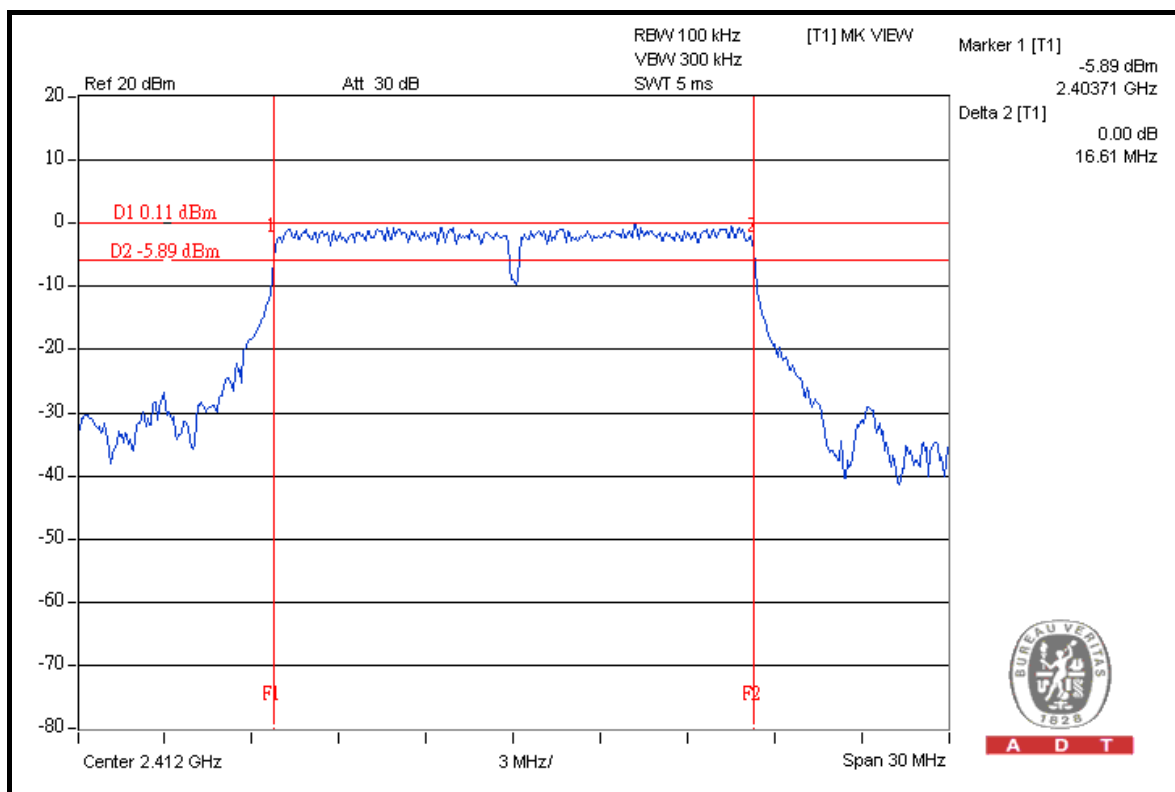



A D T

### CH 6

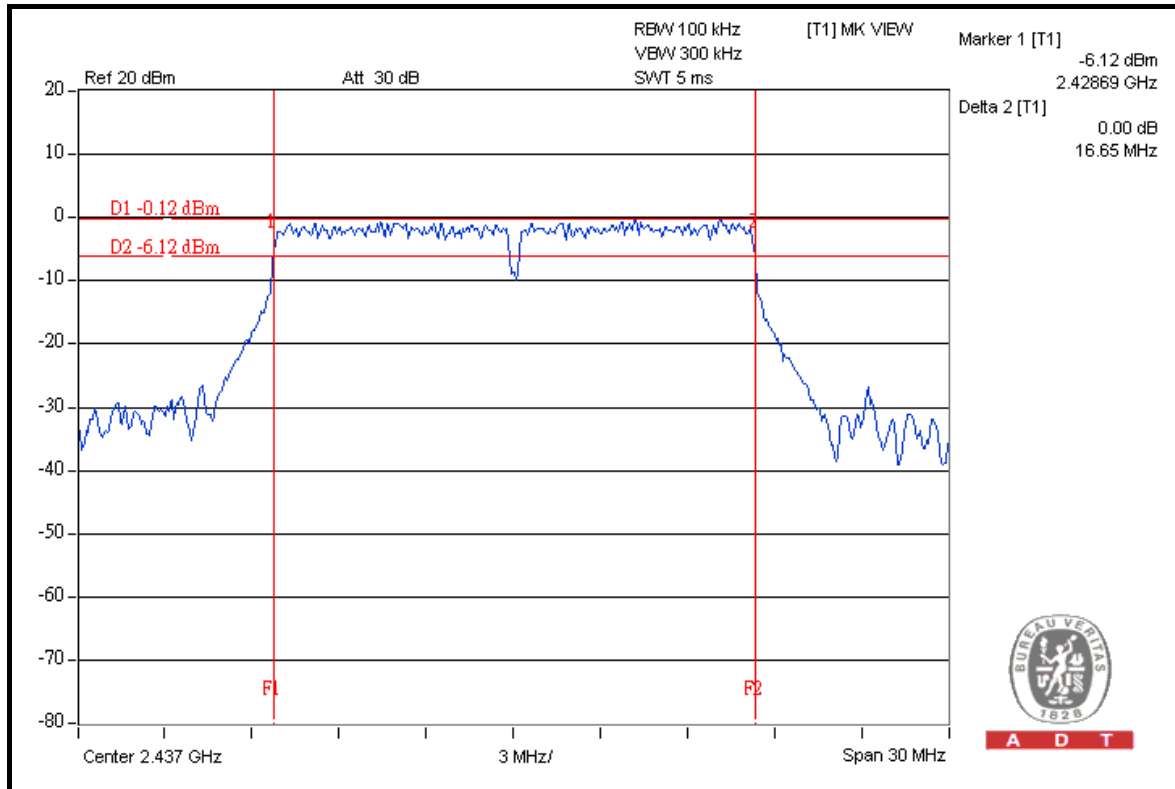

### CH 11

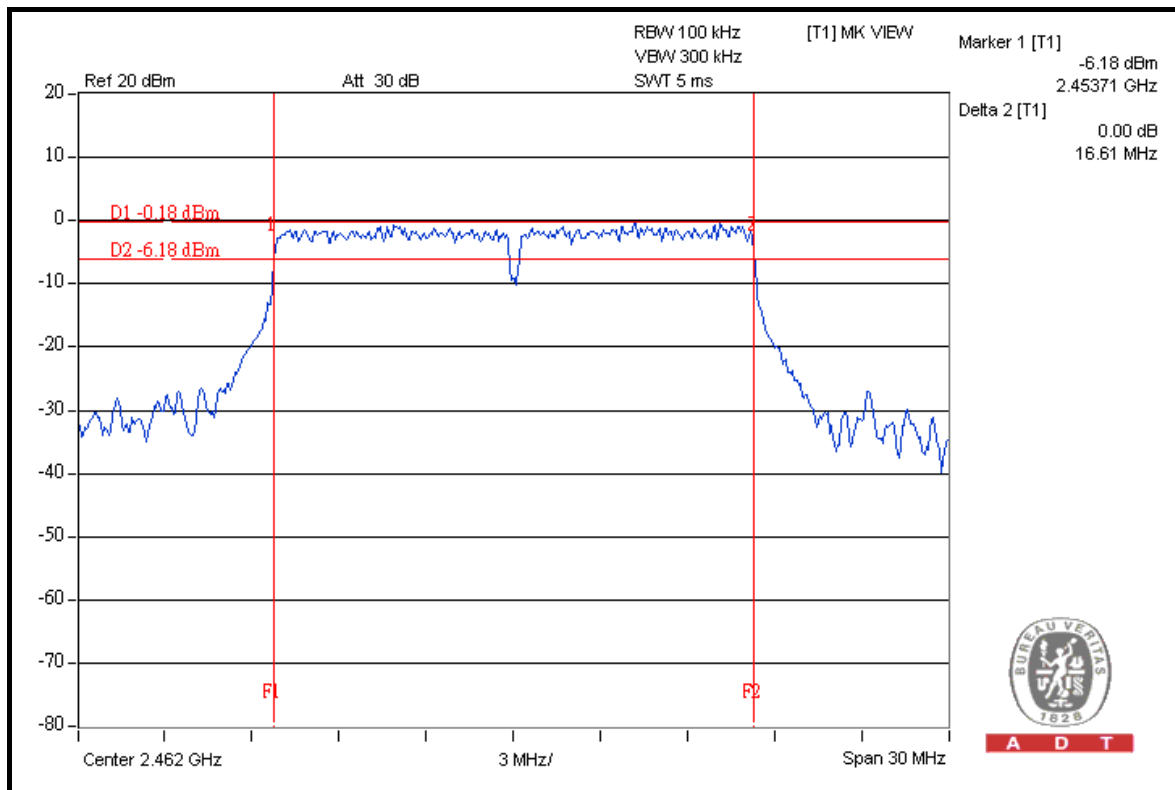



A D T

**DRAFT 802.11n (20MHz) OFDM MODULATION**

<b>MODULATION TYPE</b>	BPSK	<b>TRANSFER RATE</b>	7.2Mbps
<b>INPUT POWER</b>	120Vac, 60Hz	<b>ENVIRONMENTAL CONDITIONS</b>	24 deg.C, 64 %RH, 1021hPa
<b>TESTED BY</b>	Match Tsui		

CHANNEL	CHANNEL FREQUENCY (MHz)	6dB BANDWIDTH (MHz)		MINIMUM LIMIT (MHz)	PASS / FAIL
		CHAIN 0	CHAIN 1		
1	2412	17.73	17.80	0.5	PASS
6	2437	17.78	17.81	0.5	PASS
11	2462	17.77	17.75	0.5	PASS



A D T

### FOR CHAIN 0: CH 1

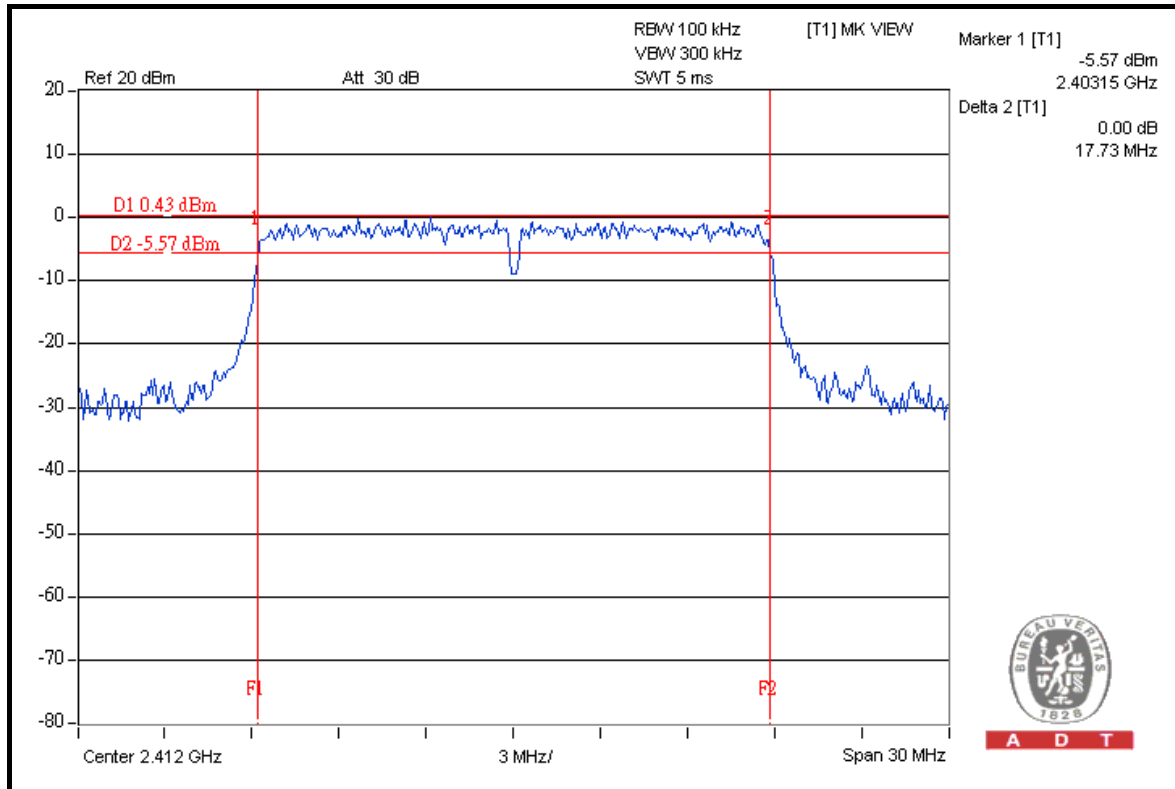

### CH 6

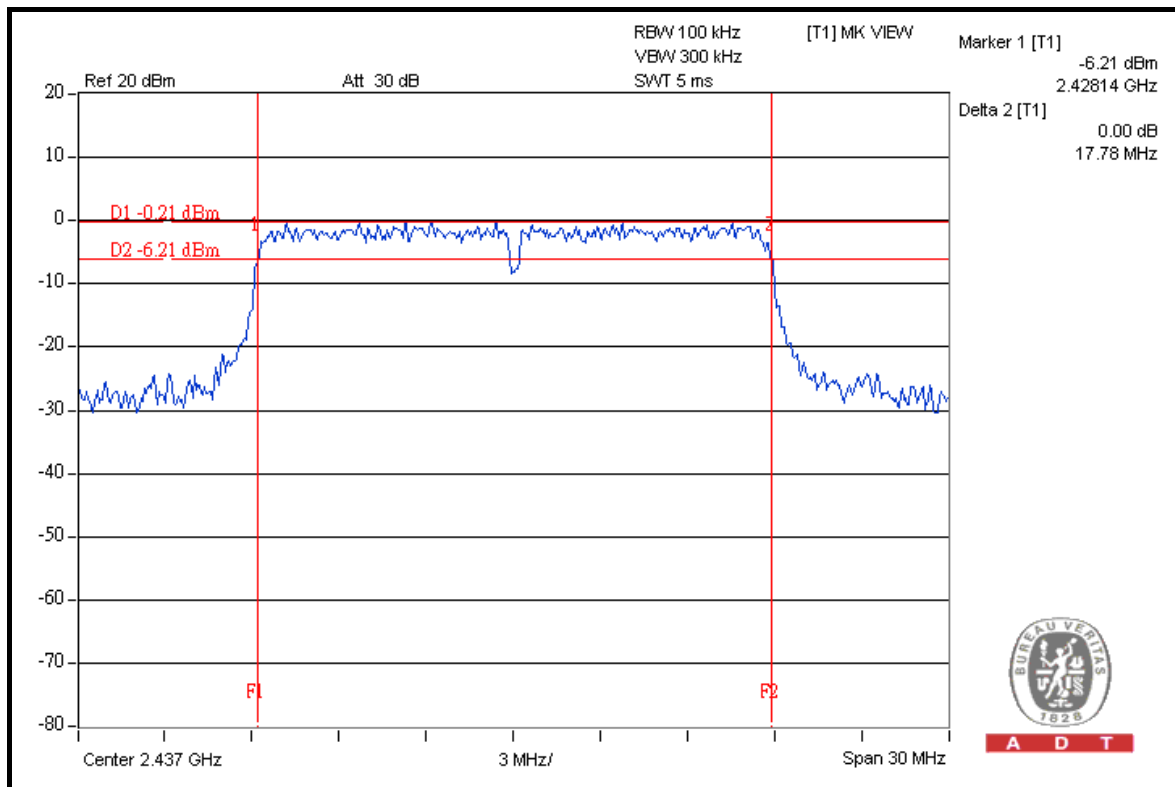





A D T

### CH 11

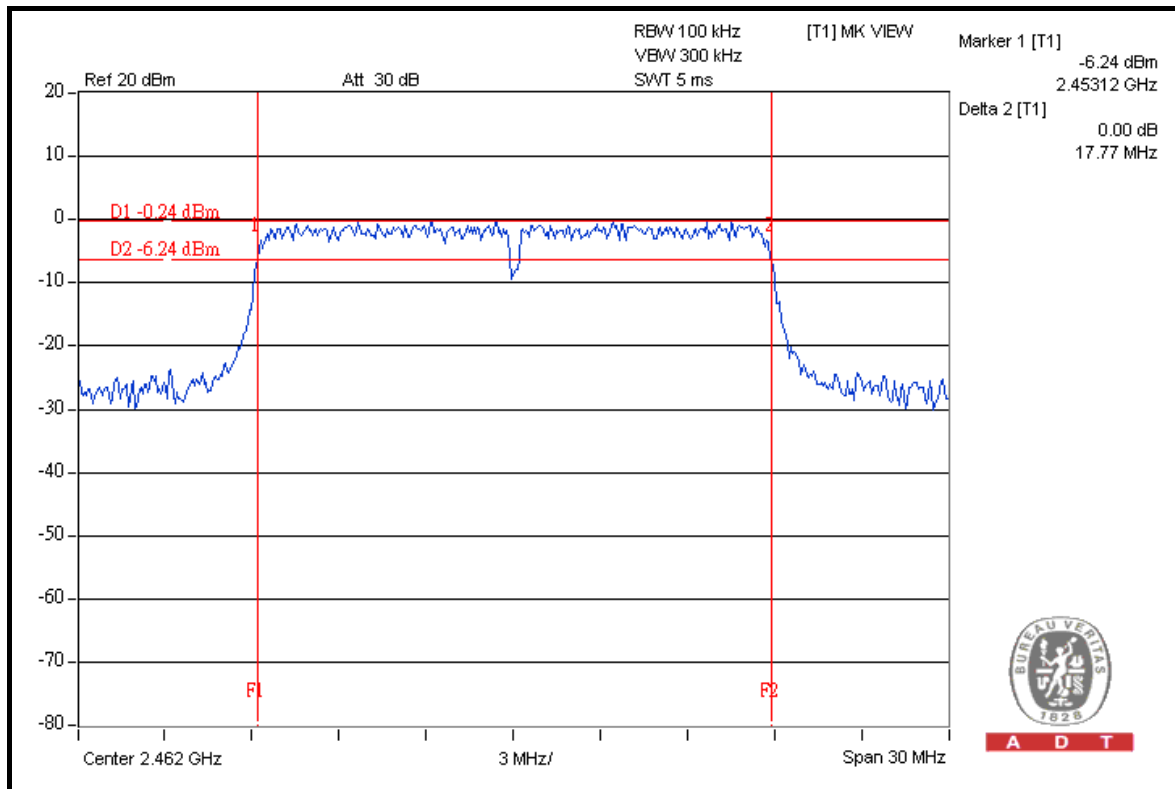

### FOR CHAIN 1: CH 1

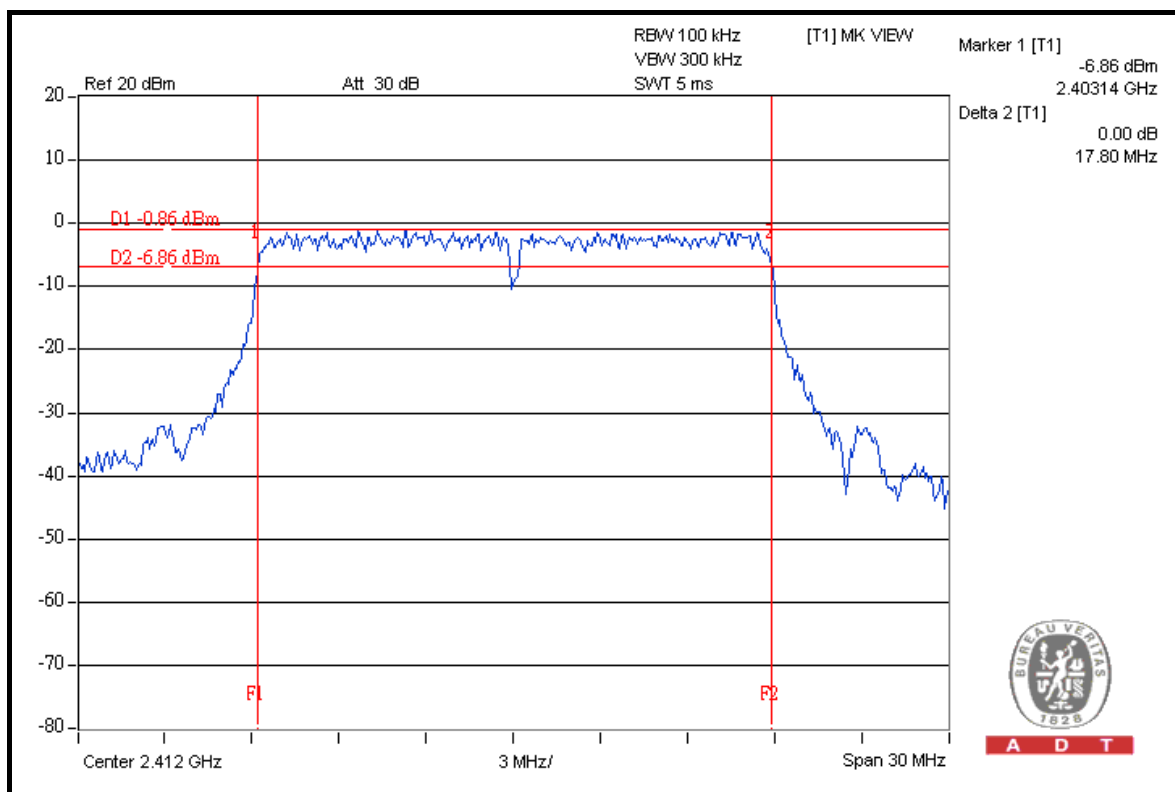



A D T

### CH 6

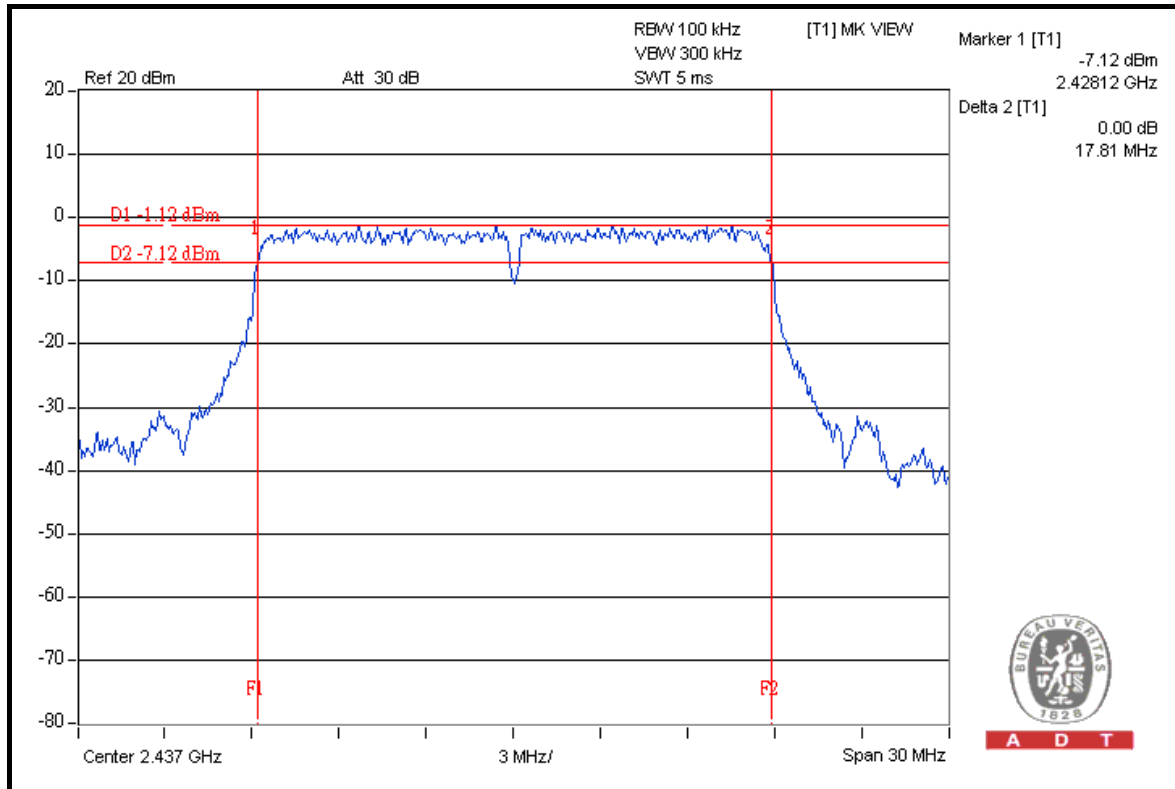

### CH 11

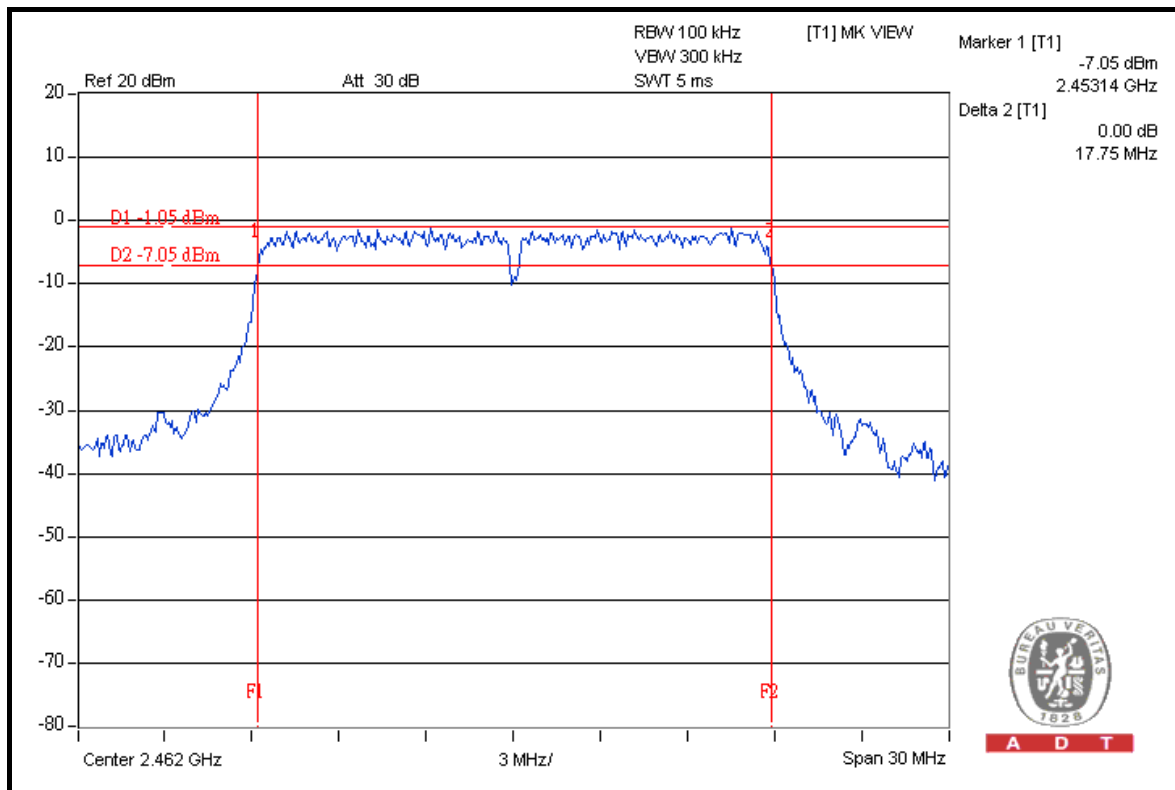



A D T

**DRAFT 802.11n (40MHz) OFDM MODULATION**

<b>MODULATION TYPE</b>	BPSK	<b>TRANSFER RATE</b>	15.0Mbps
<b>INPUT POWER</b>	120Vac, 60Hz	<b>ENVIRONMENTAL CONDITIONS</b>	24 deg.C, 64 %RH, 1021hPa
<b>TESTED BY</b>	Match Tsui		

CHANNEL	CHANNEL FREQUENCY (MHz)	6dB BANDWIDTH (MHz)		MINIMUM LIMIT (MHz)	PASS / FAIL
		CHAIN 0	CHAIN 1		
1	2422	36.57	36.57	0.5	PASS
4	2437	36.53	36.54	0.5	PASS
7	2452	36.53	36.53	0.5	PASS



A D T

### FOR CHAIN 0: CH 1

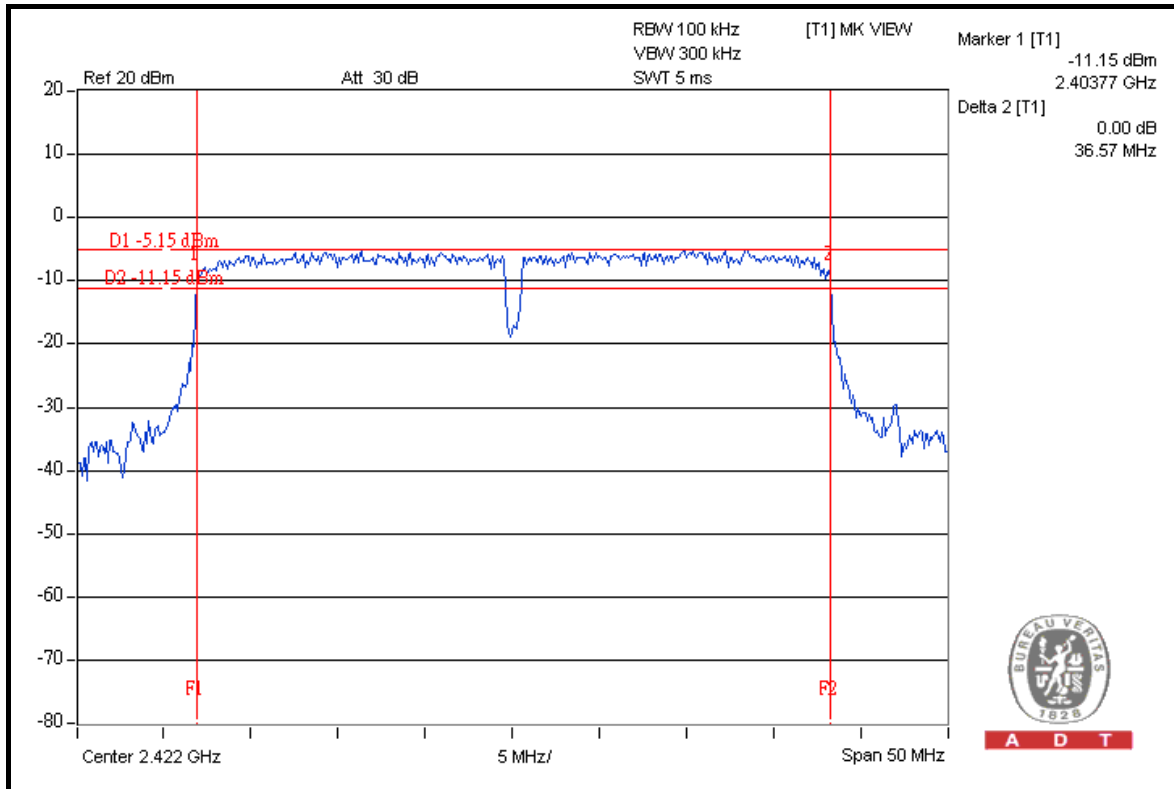

A D T

### CH 4

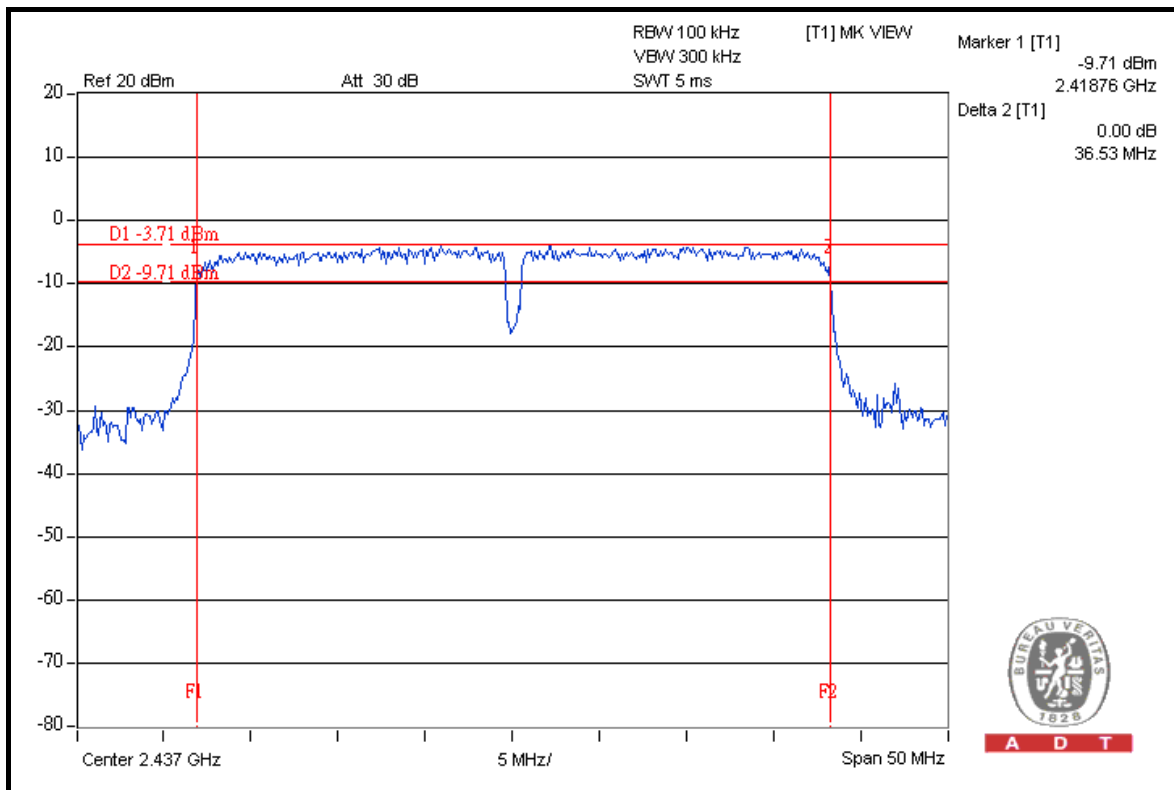

A D T



A D T

### CH 7

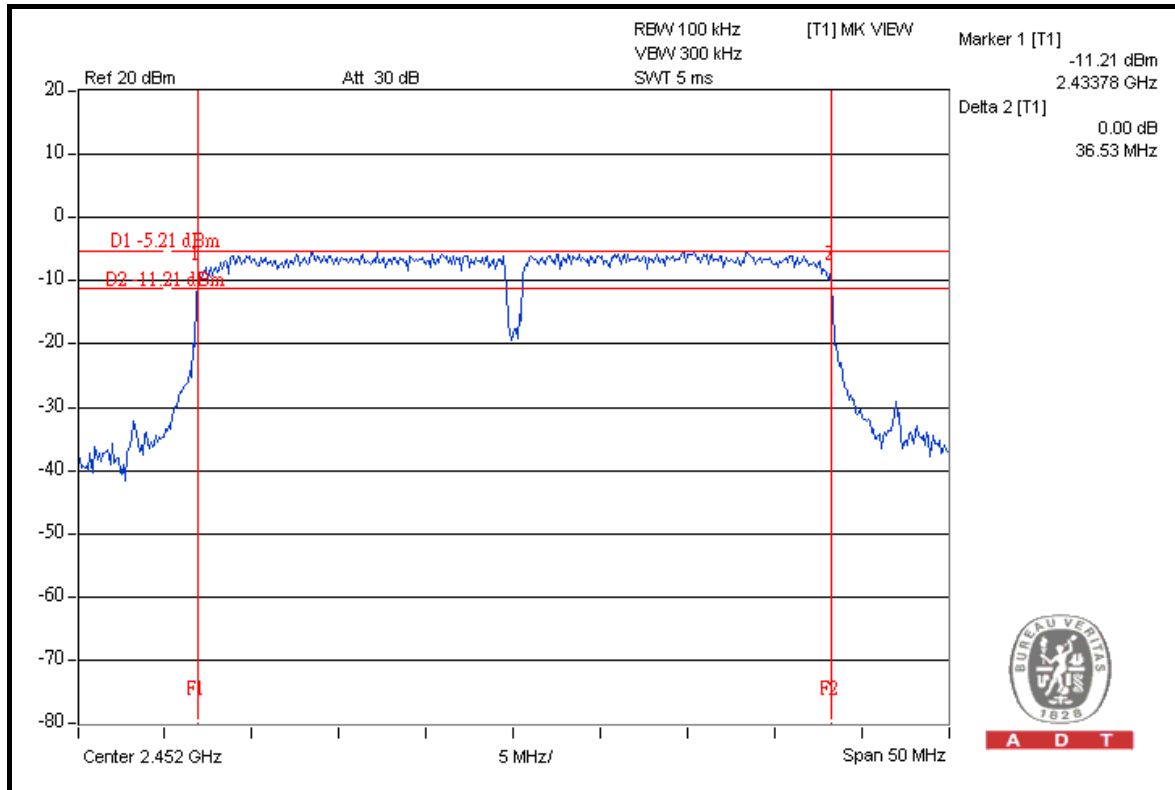

A D T

### FOR CHAIN 1: CH 1

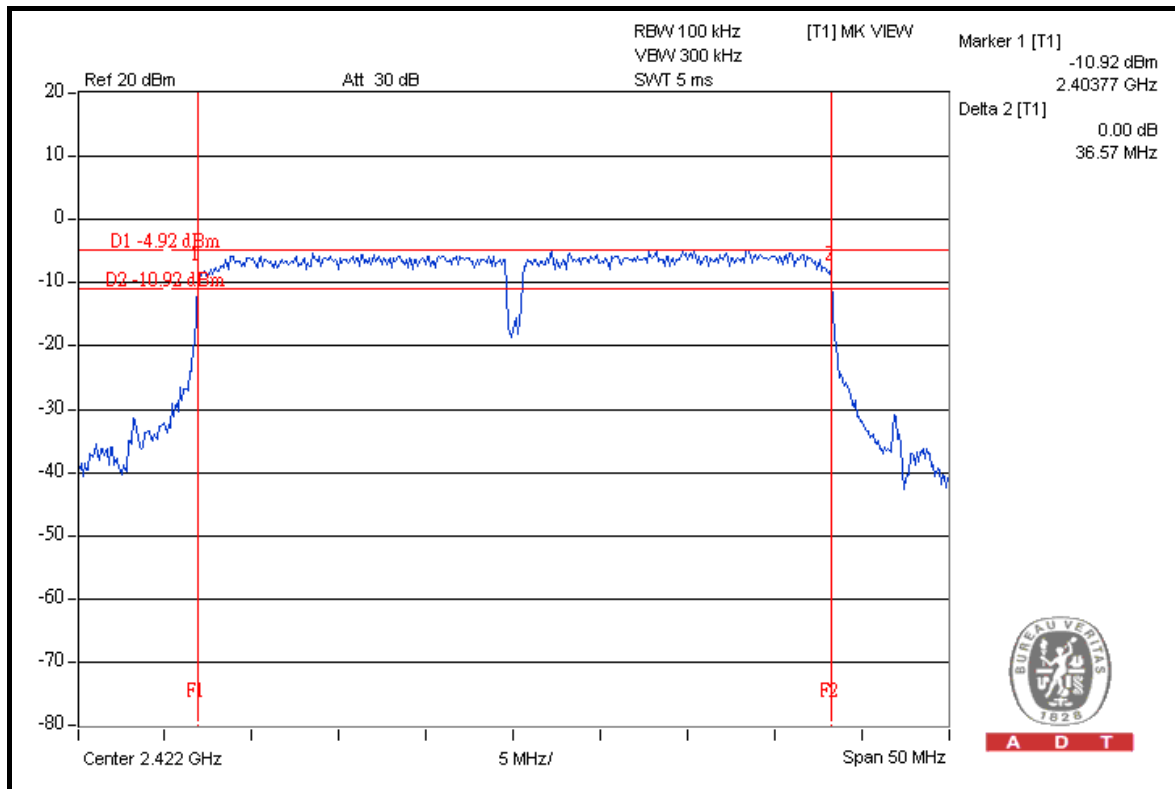

A D T

### CH 4



A D T

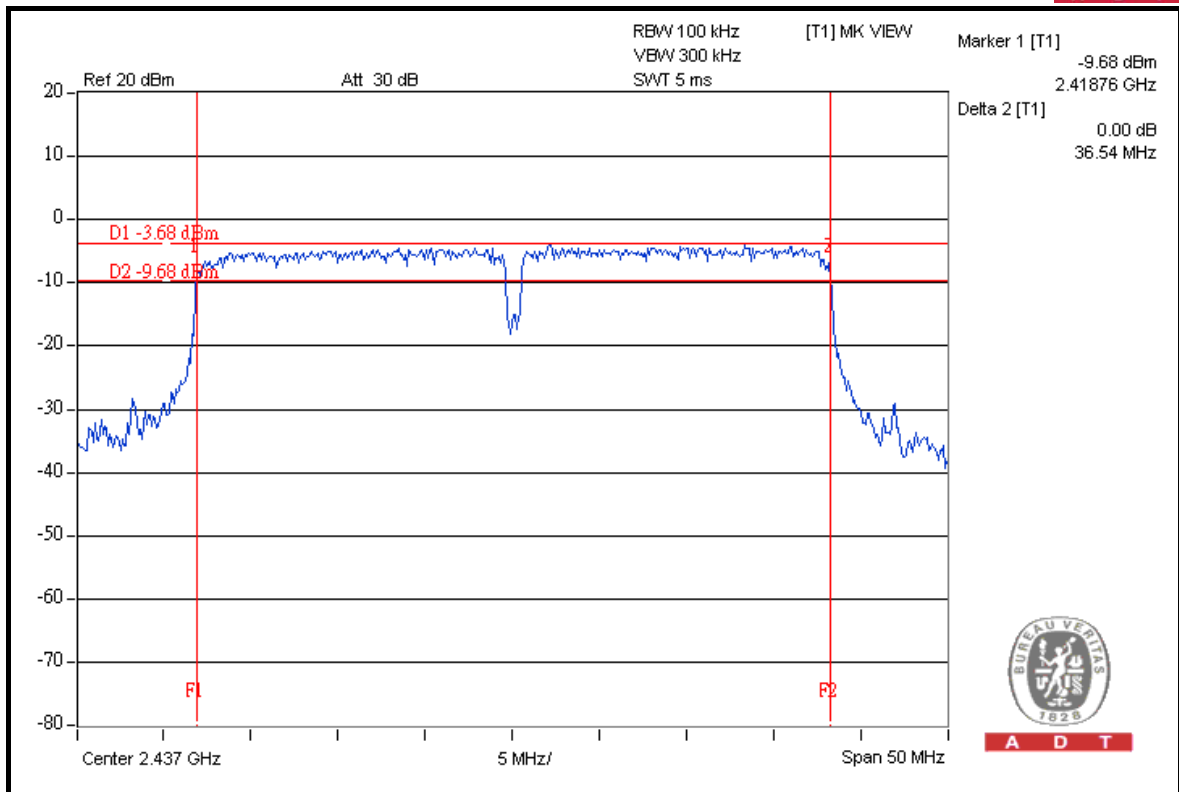

### CH 7

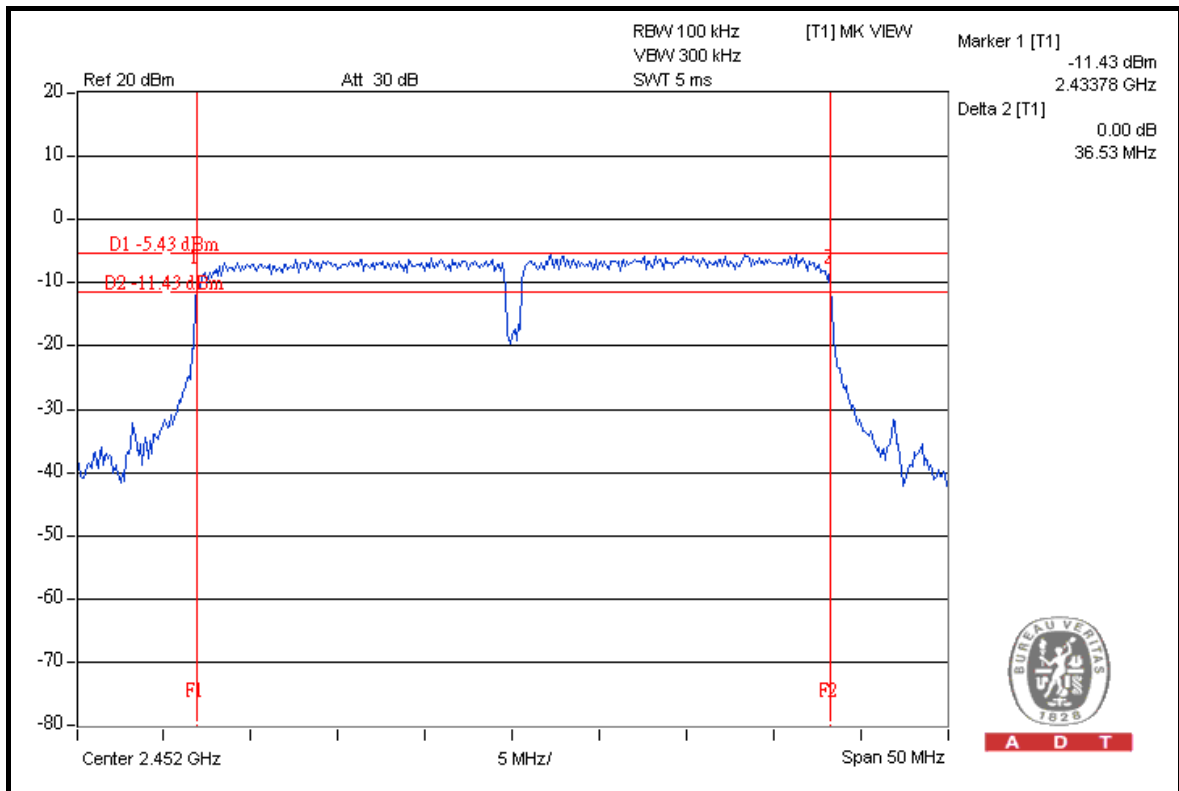

#### 4.4 MAXIMUM PEAK OUTPUT POWER

##### 4.4.1 LIMITS OF MAXIMUM PEAK OUTPUT POWER MEASUREMENT

The Maximum Peak Output Power Measurement is 30dBm.

##### 4.4.2 INSTRUMENTS

DESCRIPTION & MANUFACTURER	MODEL NO.	SERIAL NO.	DATE OF CALIBRATION	CALIBRATED UNTIL
High Speed Peak Power Meter	ML2495A	0824012	Aug. 04, 2008	Aug. 03, 2009
Power Sensor	MA2444B	0738138	Aug. 04, 2008	Aug. 03, 2009

**NOTE:**

1. The calibration interval of the above test instruments is 12 months and the calibrations are traceable to NML/ROC and NIST/USA.
2. Measurement Bandwidth of ML2495A is 65MHz greater than 6dB bandwidth of emission.

##### 4.4.3 TEST PROCEDURES

A power sensor was used on the output port of the EUT. A power meter was used to read the response of the power sensor. Record the power level.

#### 4.4.4 DEVIATION FROM TEST STANDARD

No deviation.

#### 4.4.5 TEST SETUP

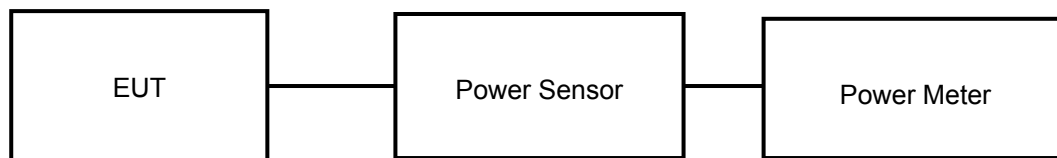

#### 4.4.6 EUT OPERATING CONDITIONS

Same as Item 4.3.6.





## 4.4.7 TEST RESULTS

## 802.11b DSSS MODULATION

<b>MODULATION TYPE</b>	DBPSK	<b>TRANSFER RATE</b>	1.0Mbps
<b>INPUT POWER</b>	120Vac, 60Hz	<b>ENVIRONMENTAL CONDITIONS</b>	24 deg.C, 64 %RH, 1021hPa
<b>TESTED BY</b>	Match Tsui		

CHAN.	CHAN. FREQ. (MHz)	PEAK POWER OUTPUT (dBm)		TOTAL PEAK POWER (mW)	TOTAL PEAK POWER (dBm)	PEAK POWER LIMIT (dBm)	PASS / FAIL
		CHAIN 0	CHAIN 1				
1	2412	19.53	19.52	179.279	22.54	30	PASS
6	2437	19.56	19.54	180.315	22.56	30	PASS
11	2462	19.02	19.11	161.270	22.08	30	PASS

## 802.11g OFDM MODULATION

<b>MODULATION TYPE</b>	BPSK	<b>TRANSFER RATE</b>	6.0Mbps
<b>INPUT POWER</b>	120Vac, 60Hz	<b>ENVIRONMENTAL CONDITIONS</b>	24 deg.C, 64 %RH, 1021hPa
<b>TESTED BY</b>	Match Tsui		

CHAN.	CHAN. FREQ. (MHz)	PEAK POWER OUTPUT (dBm)		TOTAL PEAK POWER (mW)	TOTAL PEAK POWER (dBm)	PEAK POWER LIMIT (dBm)	PASS / FAIL
		CHAIN 0	CHAIN 1				
1	2412	22.03	23.53	385.012	25.85	30	PASS
6	2437	22.06	23.56	387.681	25.88	30	PASS
11	2462	22.07	23.55	387.529	25.88	30	PASS



A D T

### DRAFT 802.11n (20MHz) OFDM MODULATION

<b>MODULATION TYPE</b>	BPSK	<b>TRANSFER RATE</b>	7.2Mbps
<b>INPUT POWER</b>	120Vac, 60Hz	<b>ENVIRONMENTAL CONDITIONS</b>	24 deg.C, 64 %RH, 1021hPa
<b>TESTED BY</b>	Match Tsui		

CHAN.	CHAN. FREQ. (MHz)	PEAK POWER OUTPUT (dBm)		TOTAL PEAK POWER (mW)	TOTAL PEAK POWER (dBm)	PEAK POWER LIMIT (dBm)	PASS / FAIL
		CHAIN 0	CHAIN 1				
1	2412	22.03	23.51	383.976	25.84	30	PASS
6	2437	22.08	23.55	387.900	25.89	30	PASS
11	2462	22.00	23.58	386.524	25.87	30	PASS

### DRAFT 802.11n (40MHz) OFDM MODULATION

<b>MODULATION TYPE</b>	BPSK	<b>TRANSFER RATE</b>	15.0Mbps
<b>INPUT POWER</b>	120Vac, 60Hz	<b>ENVIRONMENTAL CONDITIONS</b>	24 deg.C, 64 %RH, 1021hPa
<b>TESTED BY</b>	Match Tsui		

CHAN.	CHAN. FREQ. (MHz)	PEAK POWER OUTPUT (dBm)		TOTAL PEAK POWER (mW)	TOTAL PEAK POWER (dBm)	PEAK POWER LIMIT (dBm)	PASS / FAIL
		CHAIN 0	CHAIN 1				
1	2422	21.06	22.52	306.293	24.86	30	PASS
4	2437	22.04	23.54	385.899	25.86	30	PASS
7	2452	20.51	22.06	273.155	24.36	30	PASS



## 4.5 POWER SPECTRAL DENSITY MEASUREMENT

### 4.5.1 LIMITS OF POWER SPECTRAL DENSITY MEASUREMENT

The Maximum of Power Spectral Density Measurement is 8dBm.

### 4.5.2 TEST INSTRUMENTS

DESCRIPTION & MANUFACTURER	MODEL NO.	SERIAL NO.	DATE OF CALIBRATION	CALIBRATED UNTIL
R&S SPECTRUM ANALYZER	FSP40	100041	Apr. 22, 2008	Apr. 21, 2009

**NOTE:** The calibration interval of the above test instruments is 12 months and the calibrations are traceable to NML/ROC and NIST/USA.

### 4.5.3 TEST PROCEDURE

The transmitter output was connected to the spectrum analyzer through an attenuator, the bandwidth of the fundamental frequency was measured with the spectrum analyzer using 3kHz RBW and 30kHz VBW, set sweep time = span/3kHz. The power spectral density was measured and recorded.

The sweep time is allowed to be longer than span/3kHz for a full response of the mixer in the spectrum analyzer.



A D T

#### 4.5.4 DEVIATION FROM TEST STANDARD

No deviation

#### 4.5.5 TEST SETUP

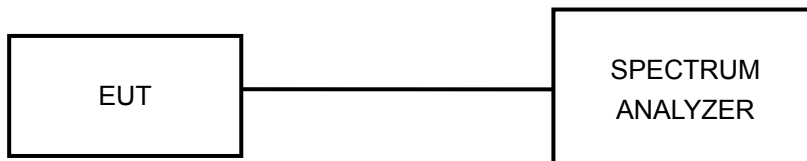

#### 4.5.6 EUT OPERATING CONDITION

Same as Item 4.3.6



A D T

#### 4.5.7 TEST RESULTS

##### 802.11b DSSS MODULATION

<b>MODULATION TYPE</b>	DBPSK	<b>TRANSFER RATE</b>	1.0Mbps
<b>INPUT POWER</b>	120Vac, 60Hz	<b>ENVIRONMENTAL CONDITIONS</b>	24 deg.C, 64 %RH, 1021hPa
<b>TESTED BY</b>	Match Tsui		

CHAN.	CHAN. FREQ. (MHz)	RF POWER LEVEL IN 3kHz BW (dBm)		TOTAL POWER DENSITY (mW)	TOTAL POWER DENSITY (dBm)	MAX. LIMIT (dBm)	PASS / FAIL
		CHAIN 0	CHAIN 1				
1	2412	-12.42	-12.78	0.110	-9.59	8	PASS
6	2437	-12.65	-12.90	0.106	-9.76	8	PASS
11	2462	-13.16	-13.42	0.094	-10.28	8	PASS



A D T

### FOR CHAIN 0: CH 1

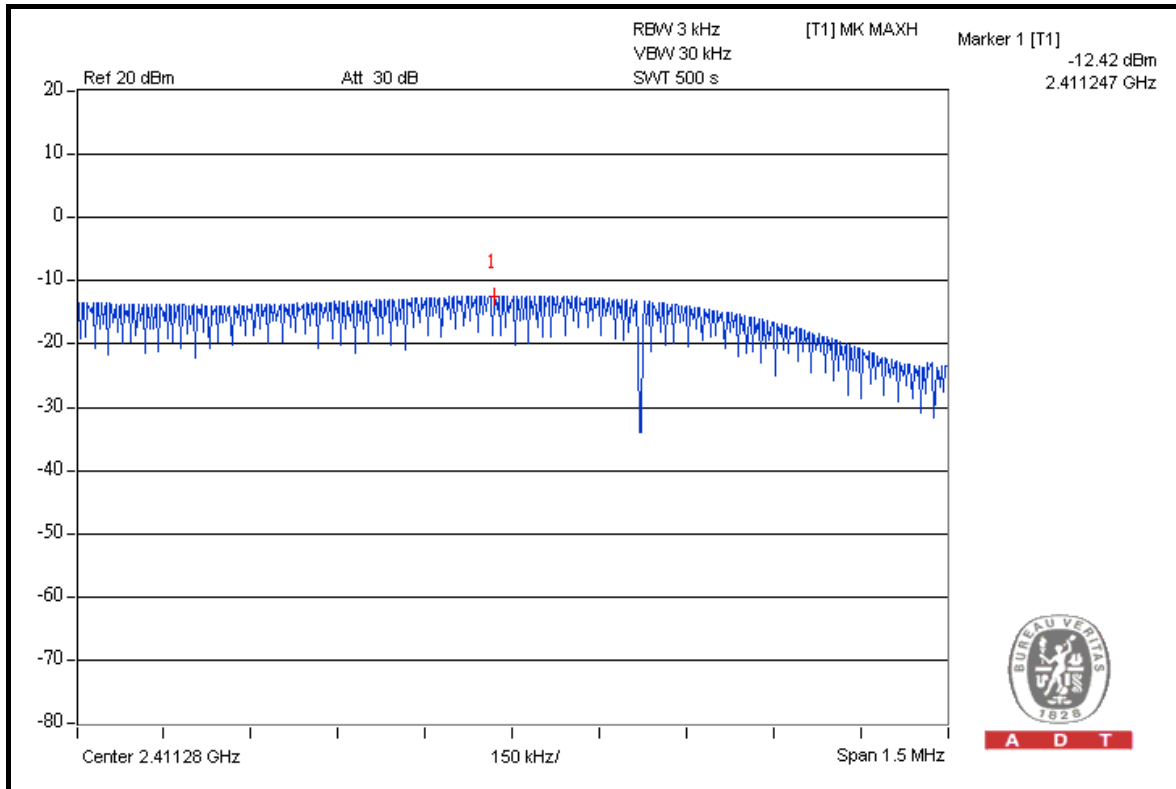

### CH 6

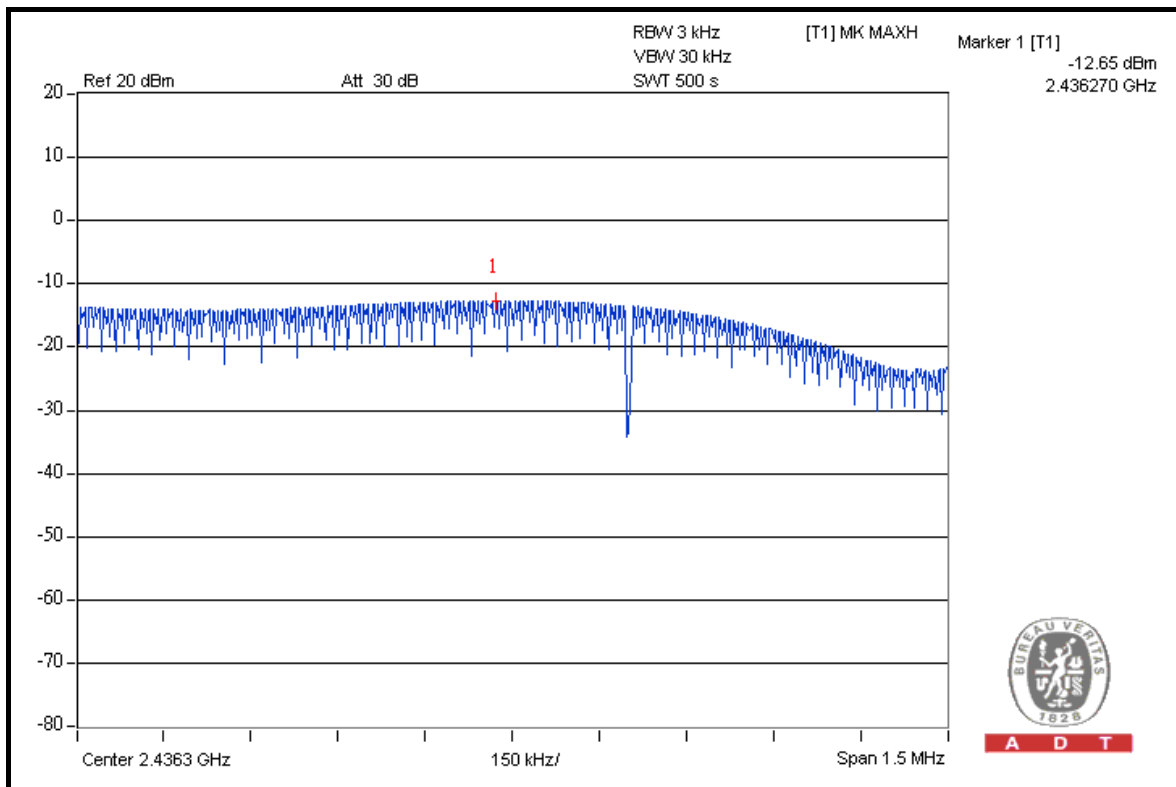



A D T

### CH 11

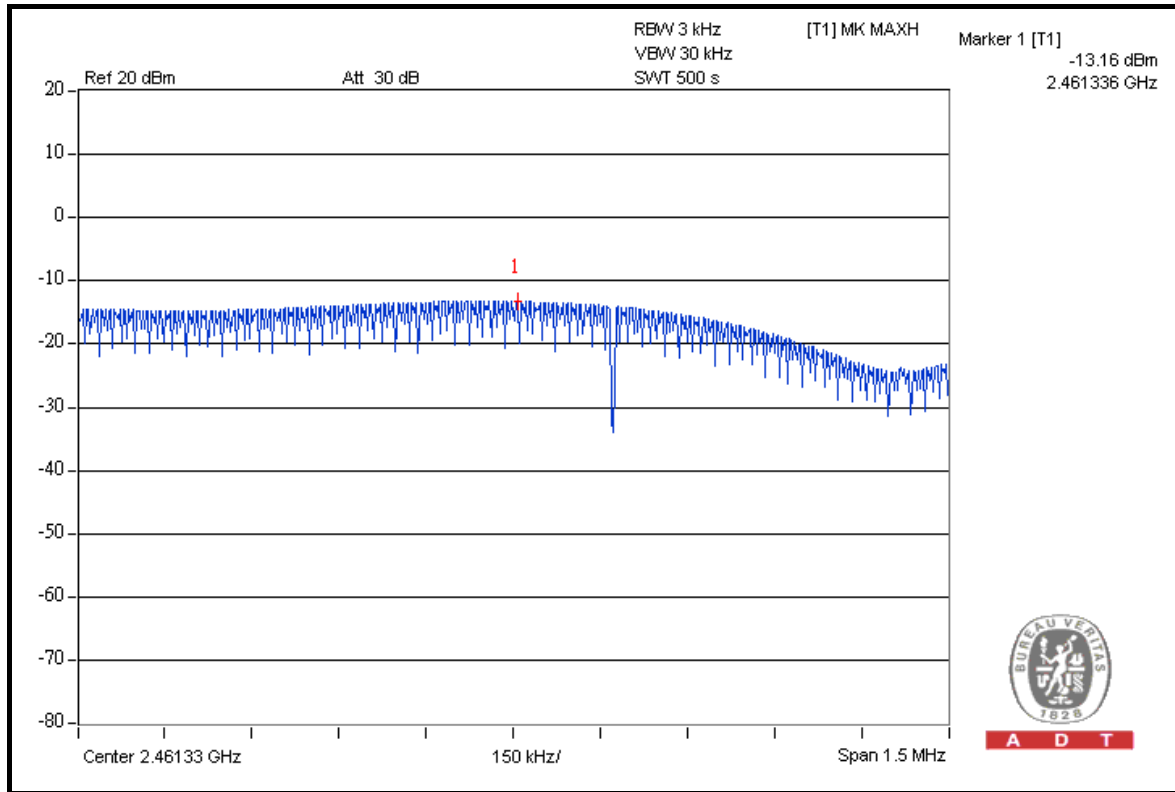

### FOR CHAIN 1: CH 1

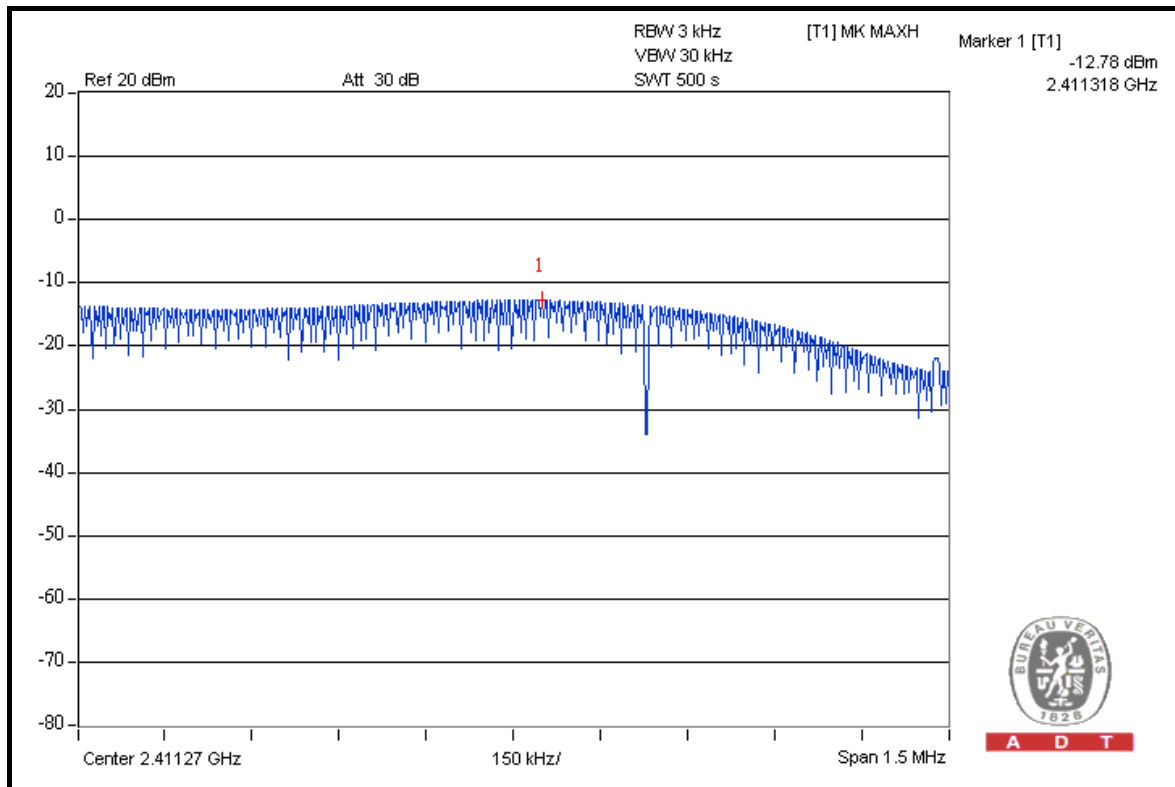



A D T

### CH 6

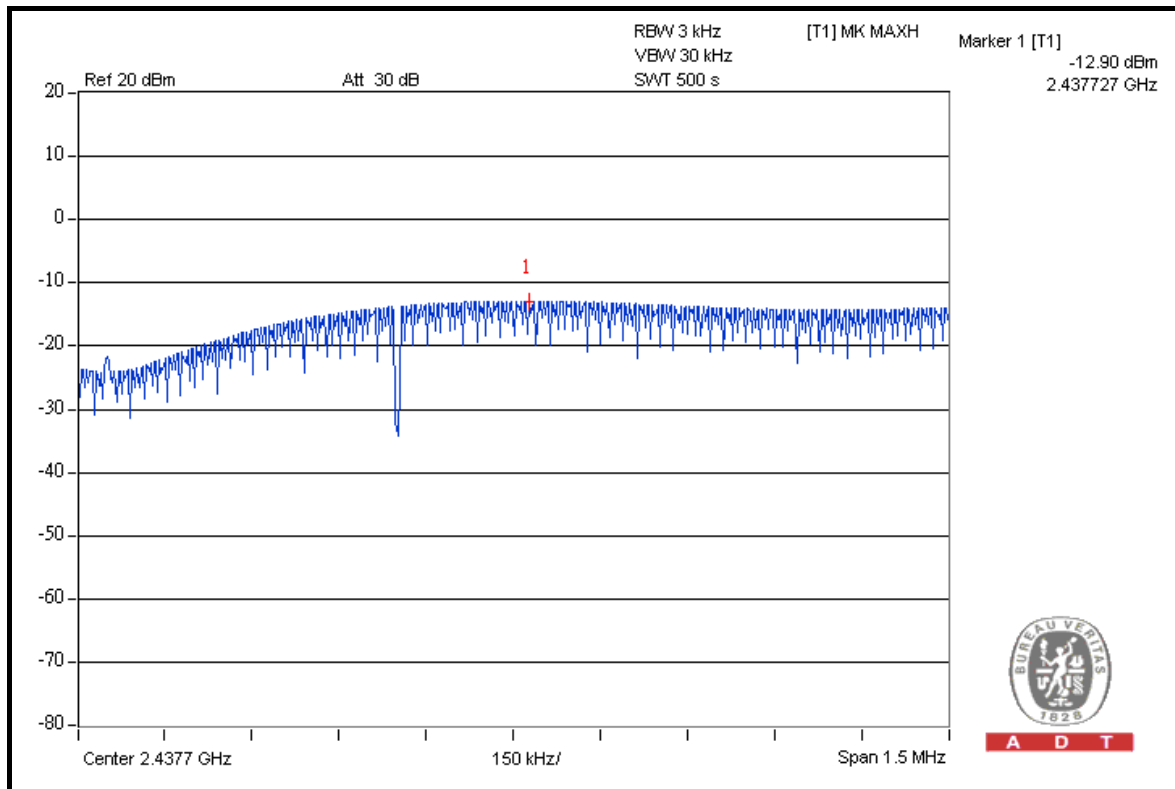

### CH 11

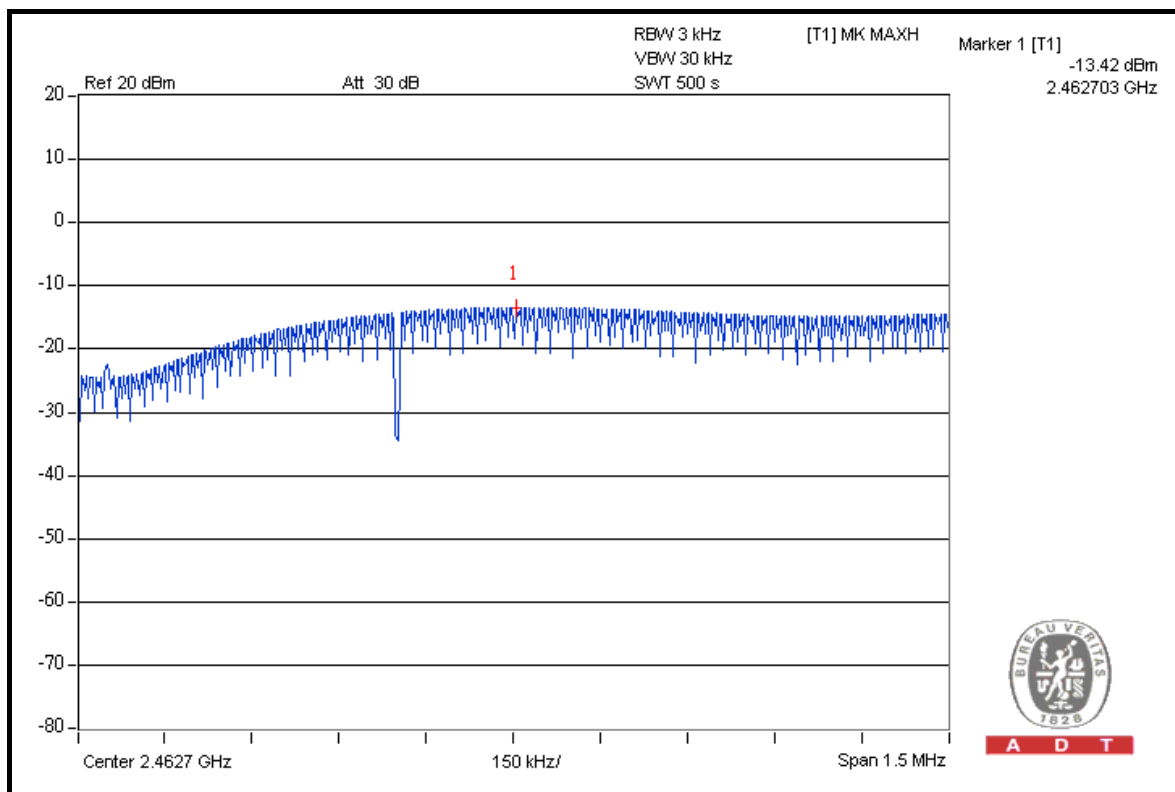





A D T

### 802.11g OFDM MODULATION

<b>MODULATION TYPE</b>	BPSK	<b>TRANSFER RATE</b>	6.0Mbps
<b>INPUT POWER</b>	120Vac, 60Hz	<b>ENVIRONMENTAL CONDITIONS</b>	24deg.C, 64%RH, 1021hPa
<b>TESTED BY</b>	Match Tsui		

CHAN.	CHAN. FREQ. (MHz)	RF POWER LEVEL IN 3kHz BW (dBm)		TOTAL POWER DENSITY (mW)	TOTAL POWER DENSITY (dBm)	MAX. LIMIT (dBm)	PASS / FAIL
		CHAIN 0	CHAIN 1				
1	2412	-14.66	-14.59	0.069	-11.61	8	PASS
6	2437	-14.83	-14.82	0.066	-11.81	8	PASS
11	2462	-14.87	-14.77	0.066	-11.81	8	PASS



A D T

### FOR CHAIN 0: CH 1

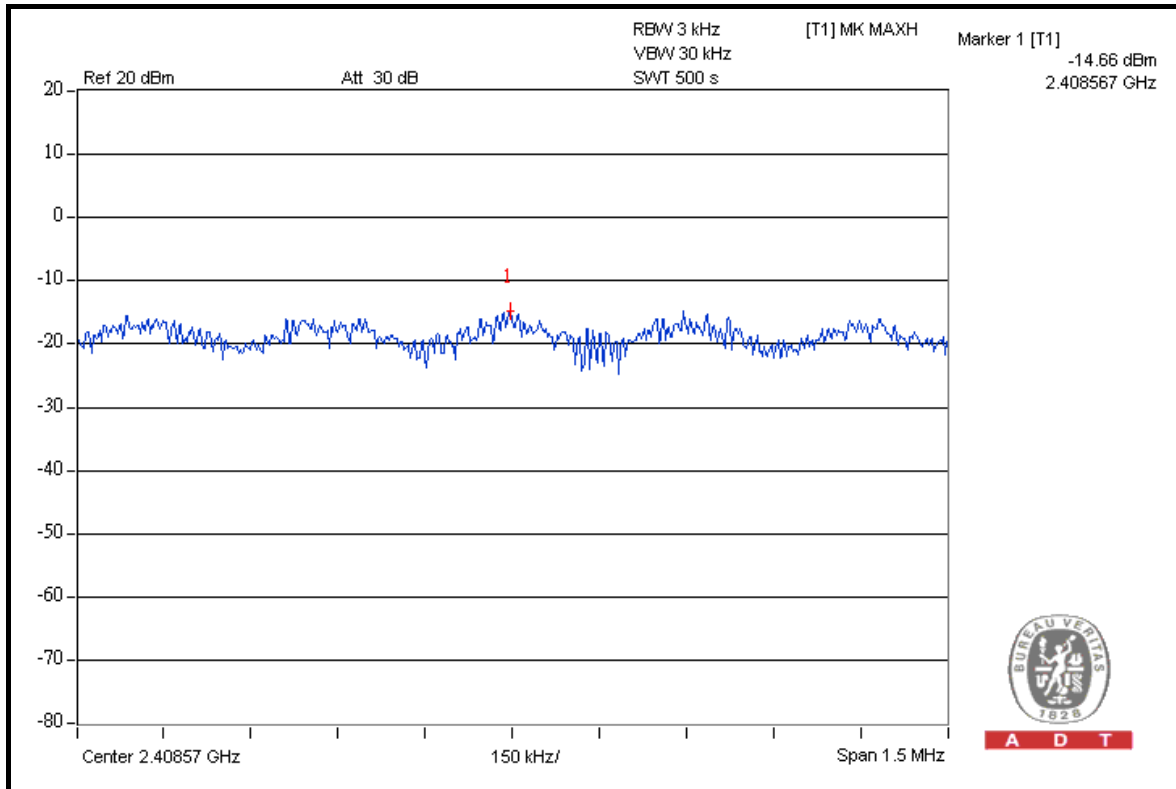

### CH 6

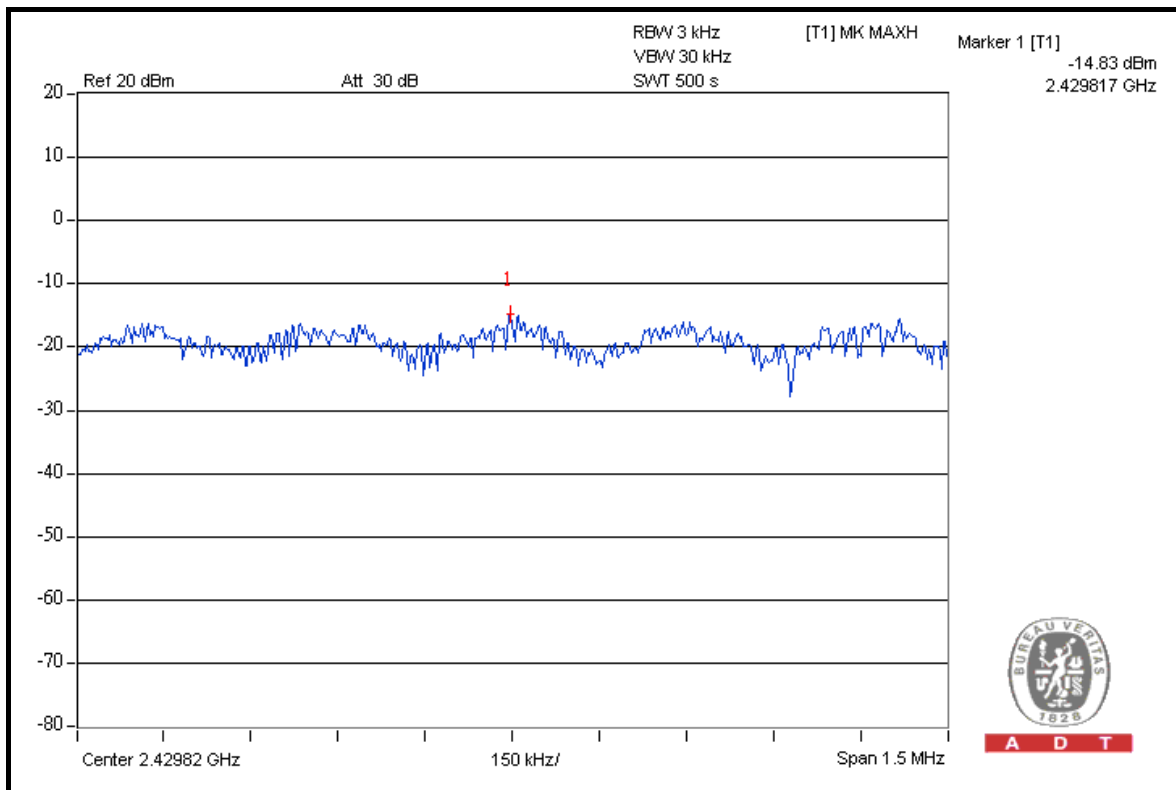



A D T

### CH 11

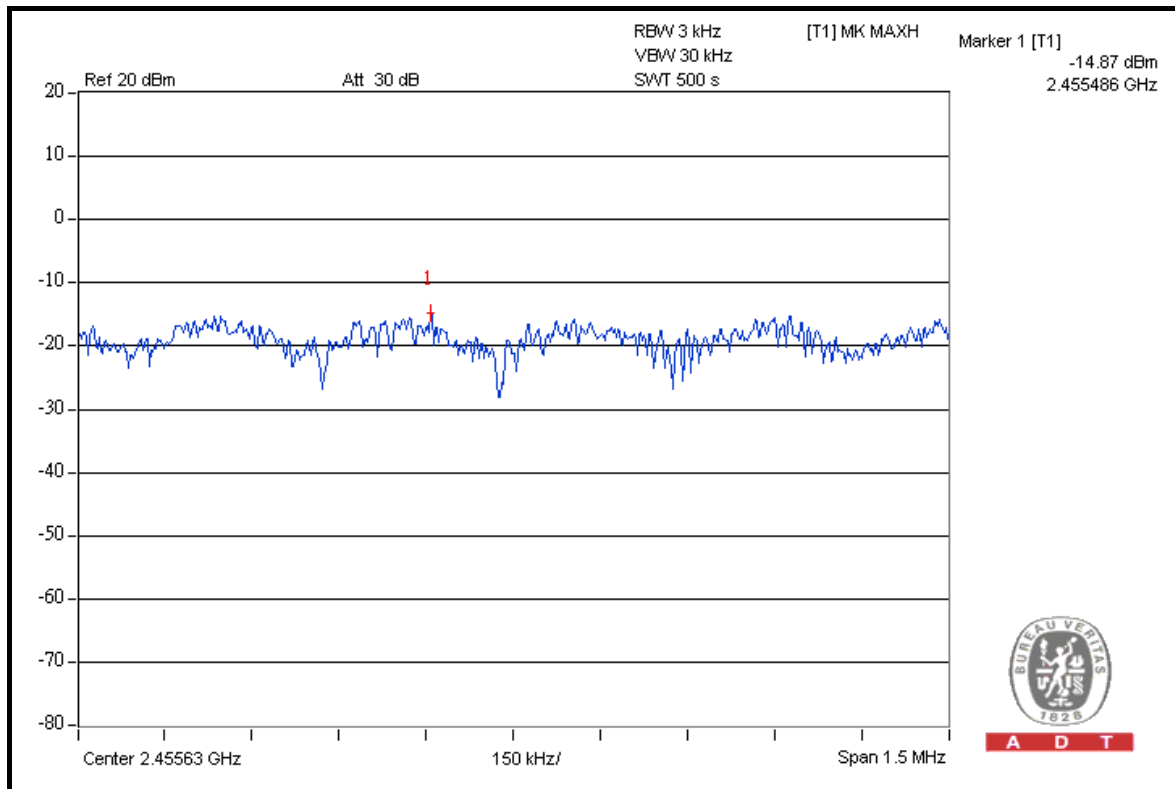

### FOR CHAIN 1: CH 1

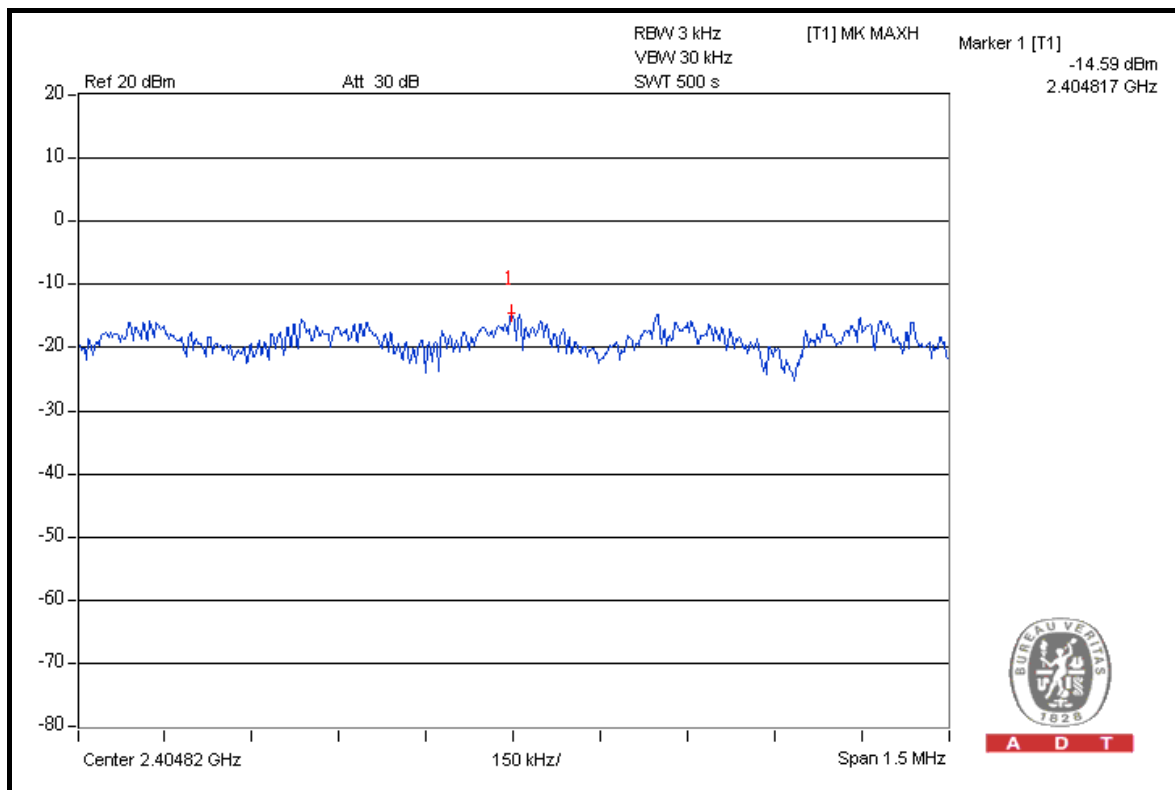



A D T

### CH 6

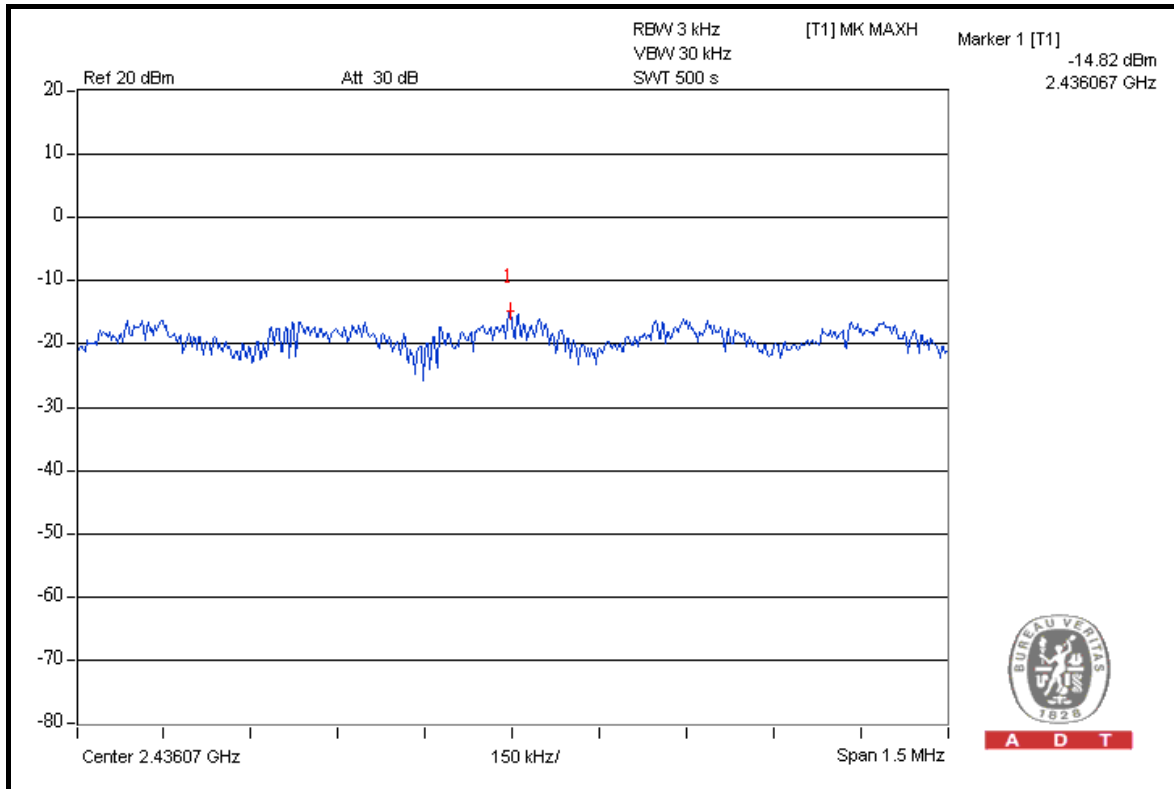

### CH 11

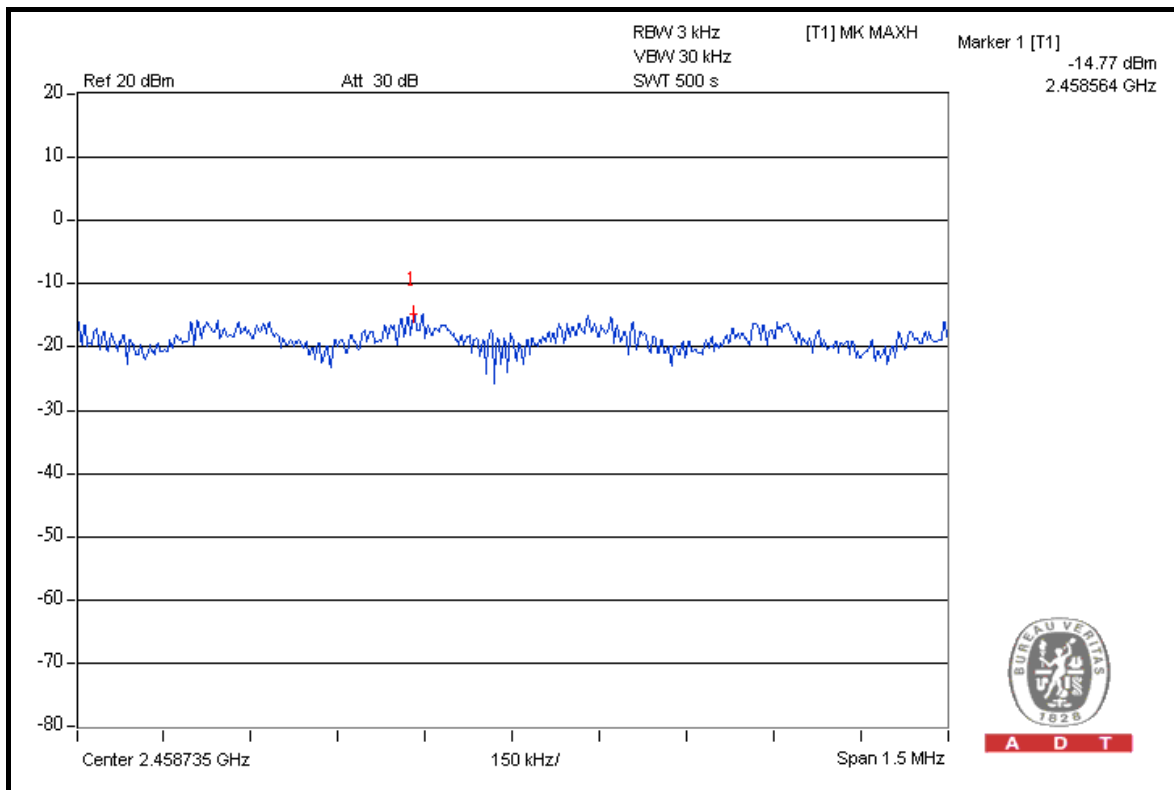



A D T

### DRAFT 802.11n (20MHz) OFDM MODULATION

<b>MODULATION TYPE</b>	BPSK	<b>TRANSFER RATE</b>	7.2Mbps
<b>INPUT POWER</b>	120Vac, 60Hz	<b>ENVIRONMENTAL CONDITIONS</b>	24 deg.C, 64 %RH, 1021hPa
<b>TESTED BY</b>	Match Tsui		

CHAN.	CHAN. FREQ. (MHz)	RF POWER LEVEL IN 3kHz BW (dBm)		TOTAL POWER DENSITY (mW)	TOTAL POWER DENSITY (dBm)	MAX. LIMIT (dBm)	PASS / FAIL
		CHAIN 0	CHAIN 1				
1	2412	-13.63	-15.30	0.073	-11.37	8	PASS
6	2437	-13.48	-15.50	0.073	-11.36	8	PASS
11	2462	-13.71	-15.47	0.071	-11.49	8	PASS



A D T

### FOR CHAIN 0: CH 1

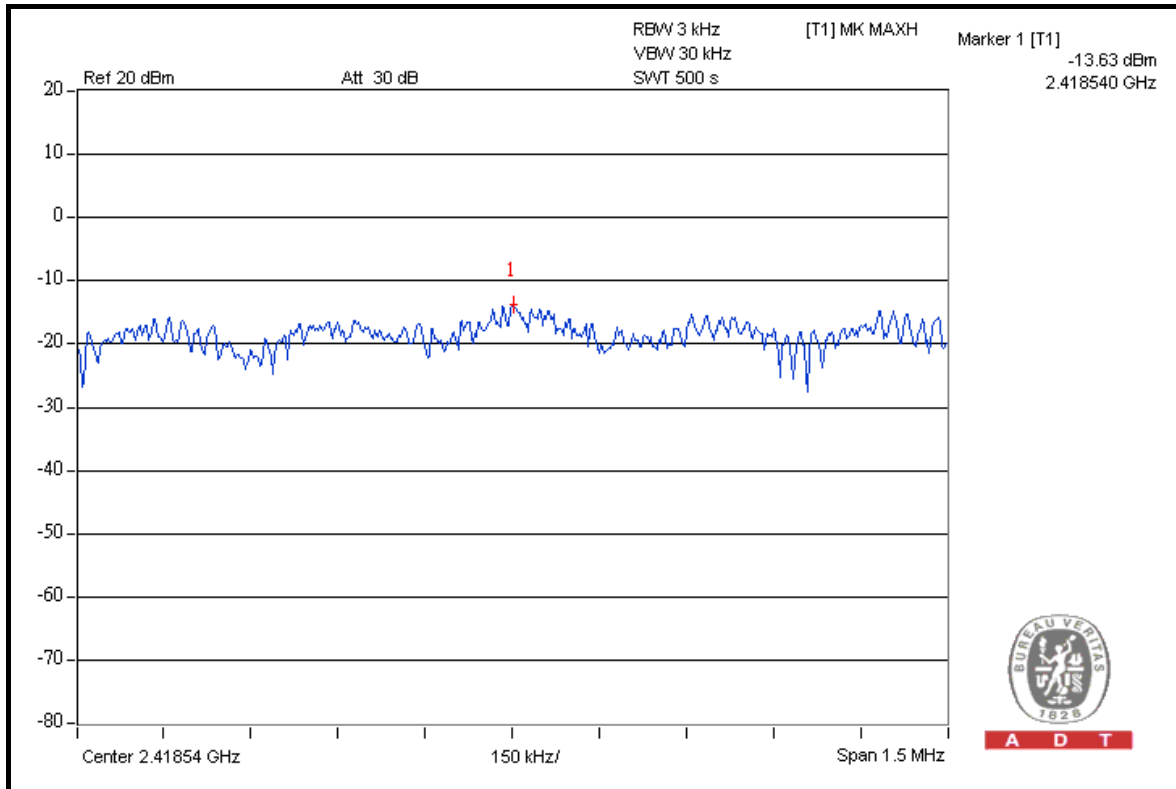

### CH 6

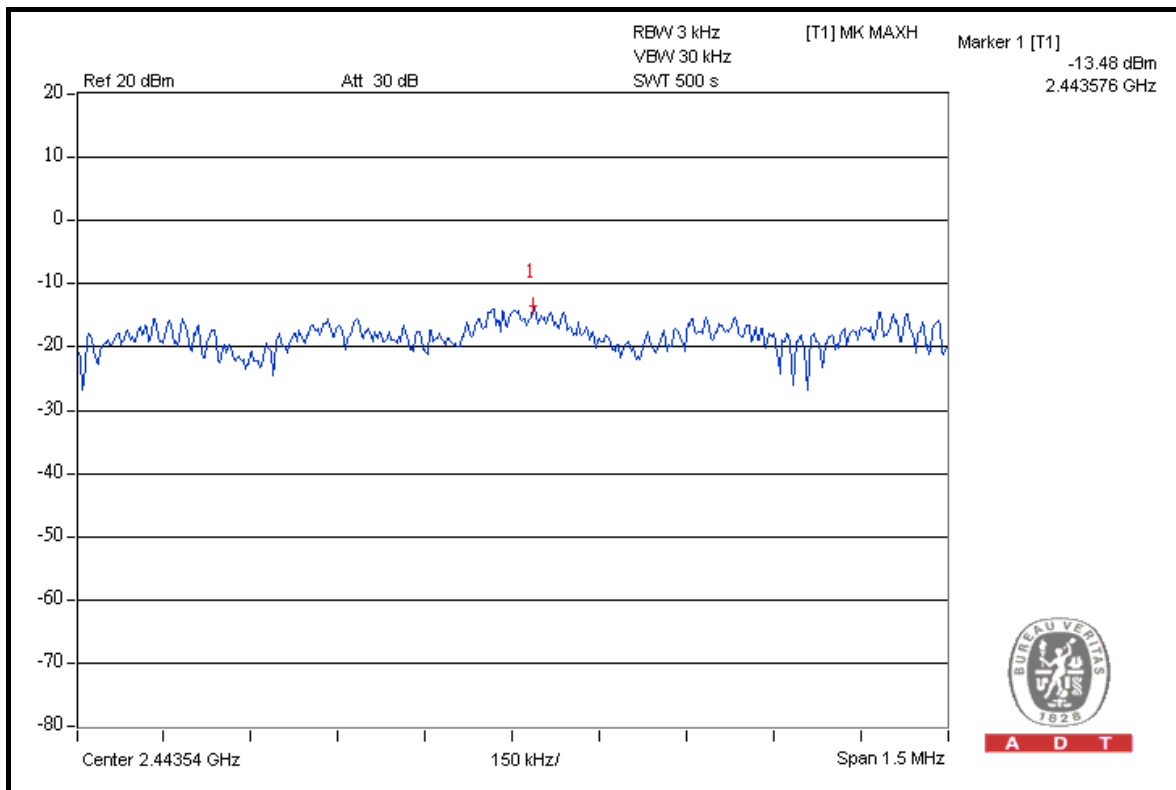



A D T

### CH 11

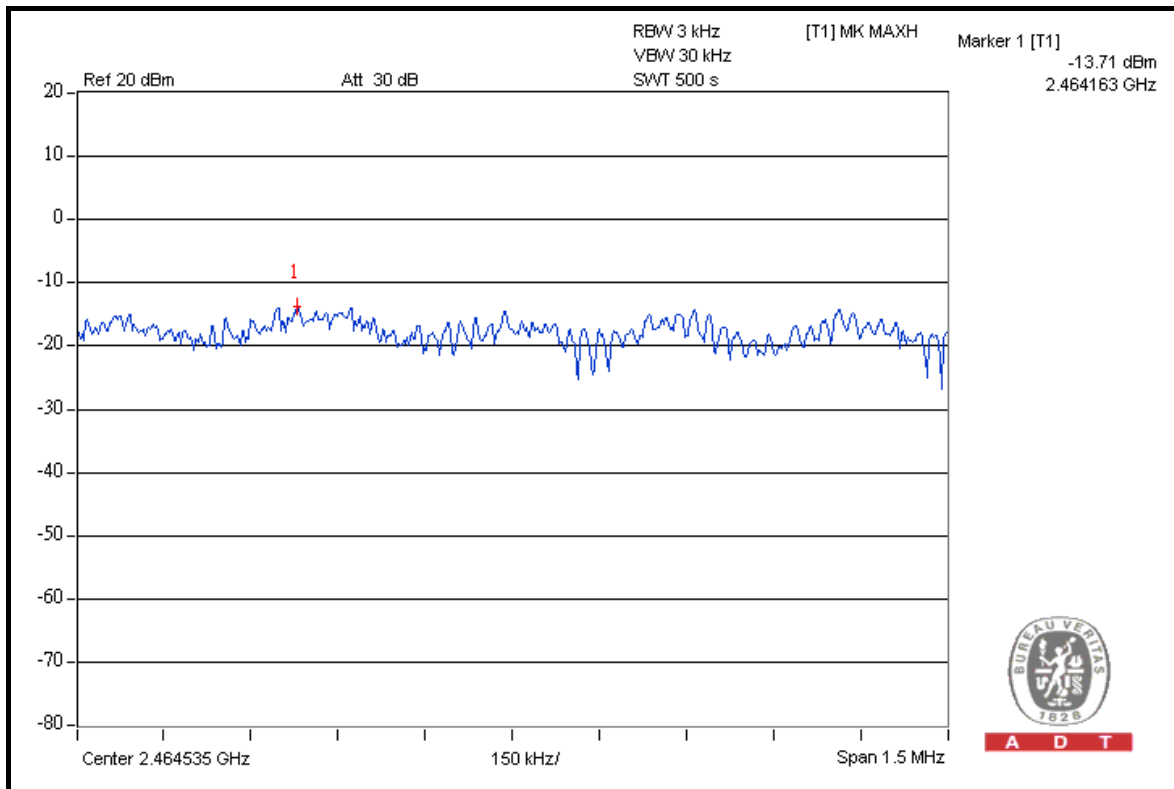

### FOR CHAIN 1: CH 1

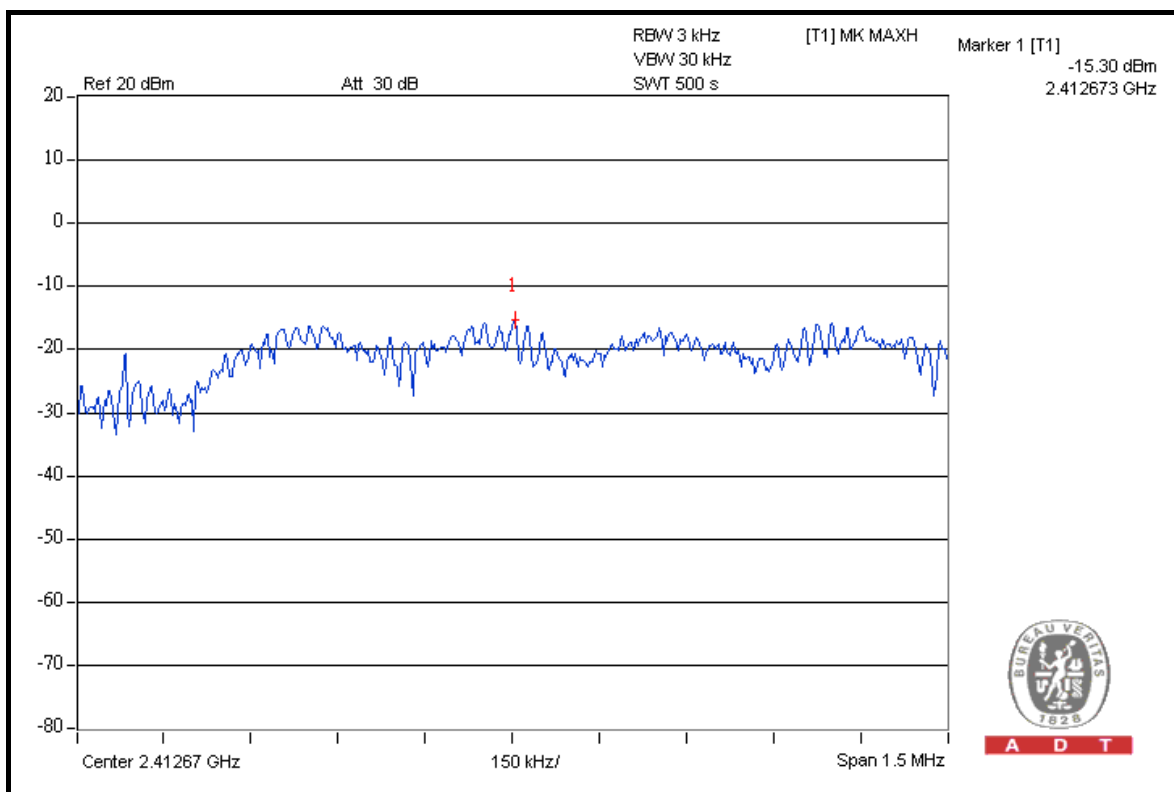



A D T

### CH 6

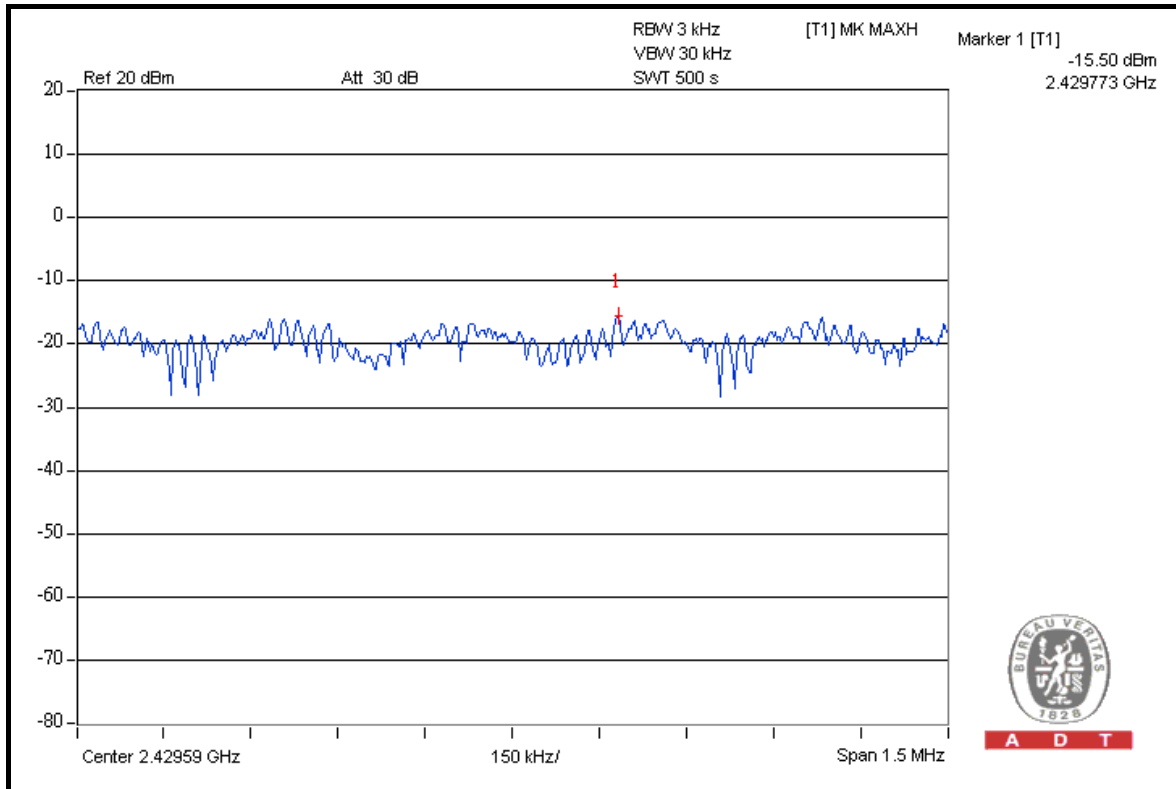

### CH 11

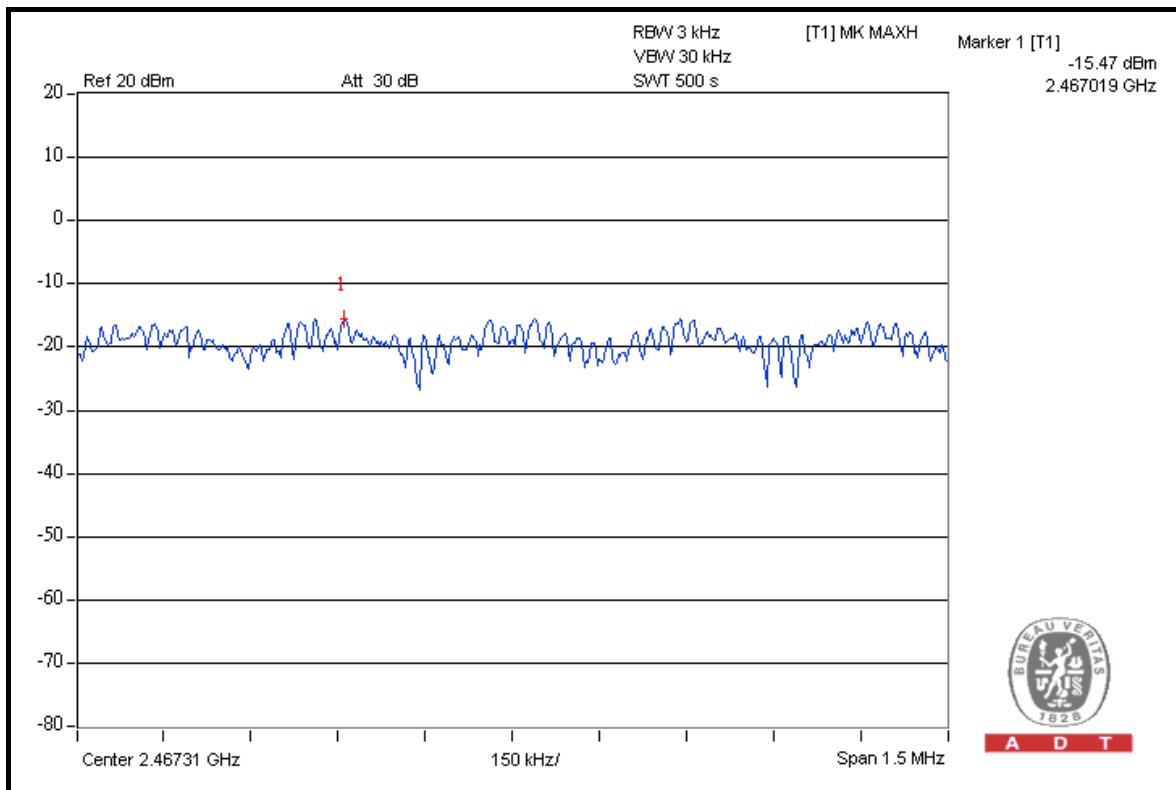





A D T

### DRAFT 802.11n (40MHz) OFDM MODULATION

<b>MODULATION TYPE</b>	BPSK	<b>TRANSFER RATE</b>	15.0Mbps
<b>INPUT POWER</b>	120Vac, 60Hz	<b>ENVIRONMENTAL CONDITIONS</b>	24 deg.C, 64 %RH, 1021hPa
<b>TESTED BY</b>	Match Tsui		

CHAN.	CHAN. FREQ. (MHz)	RF POWER LEVEL IN 3kHz BW (dBm)		TOTAL POWER DENSITY (mW)	TOTAL POWER DENSITY (dBm)	MAX. LIMIT (dBm)	PASS / FAIL
		CHAIN 0	CHAIN 1				
1	2422	-17.16	-17.20	0.038	-14.17	8	PASS
4	2437	-16.04	-16.04	0.050	-13.03	8	PASS
7	2452	-17.53	-17.66	0.035	-14.58	8	PASS



A D T

### FOR CHAIN 0: CH 1

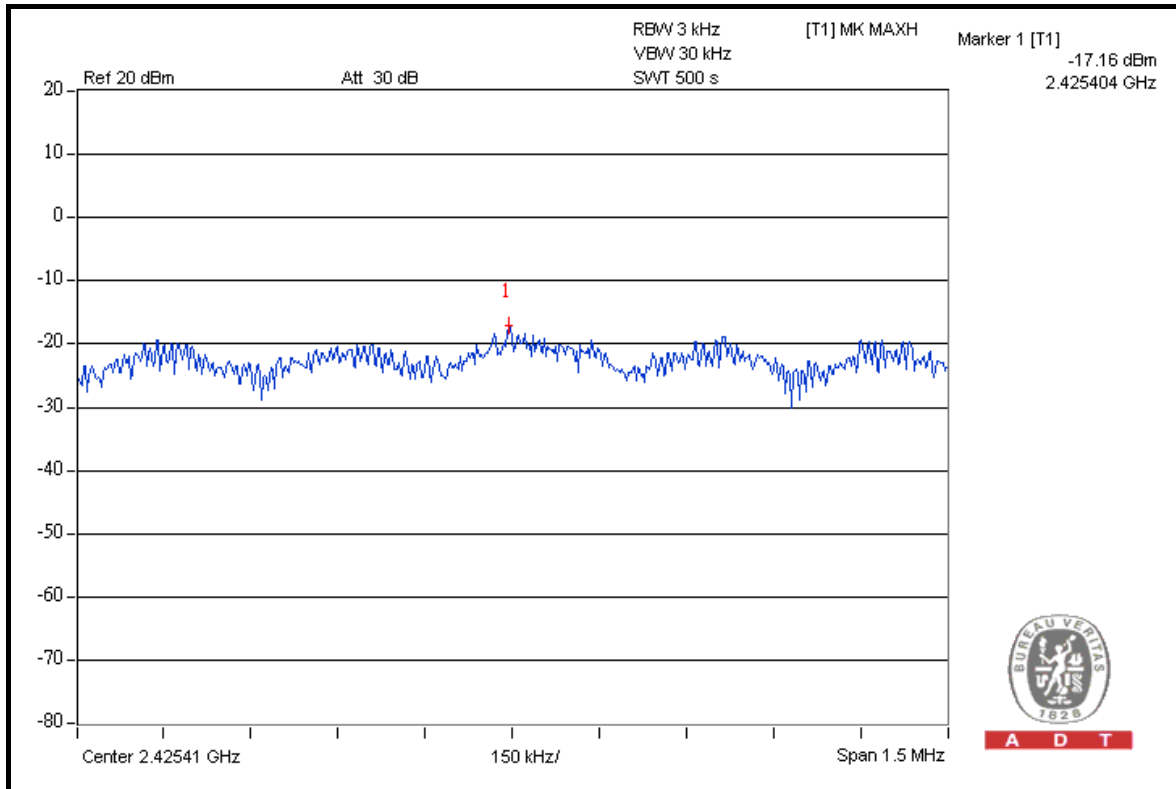

### CH 4

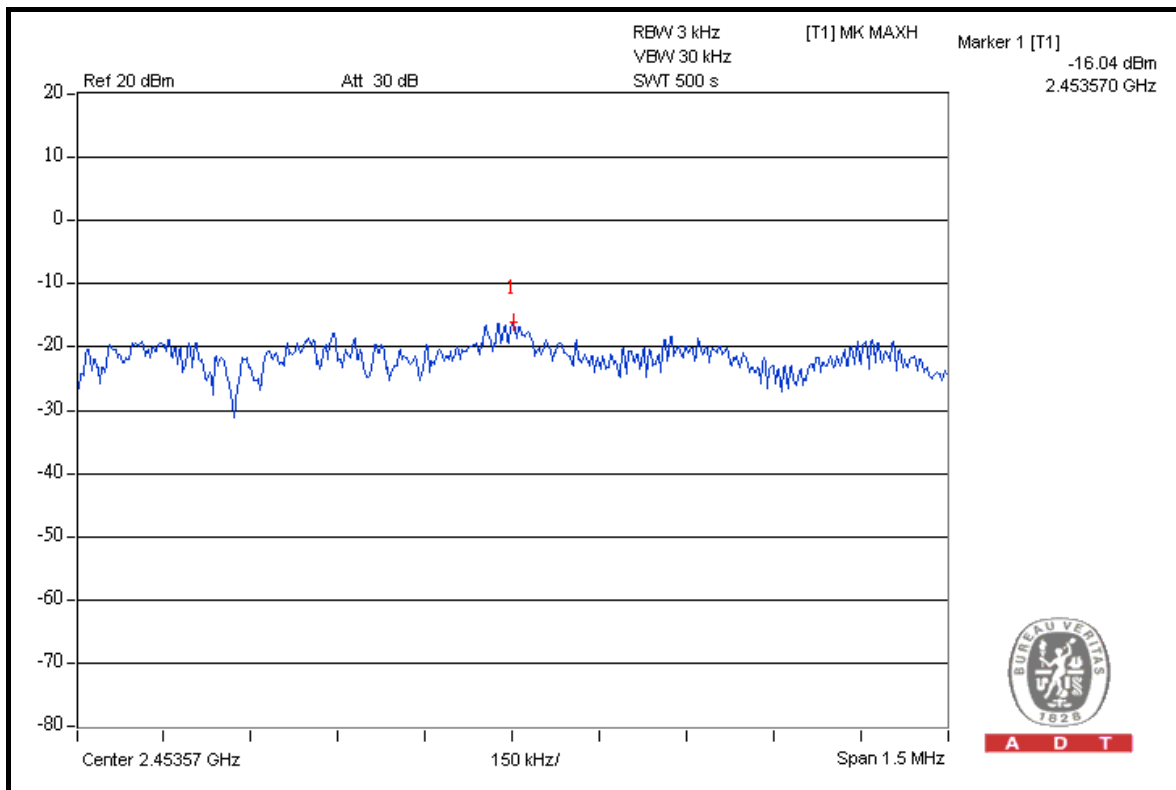



A D T

### CH 7

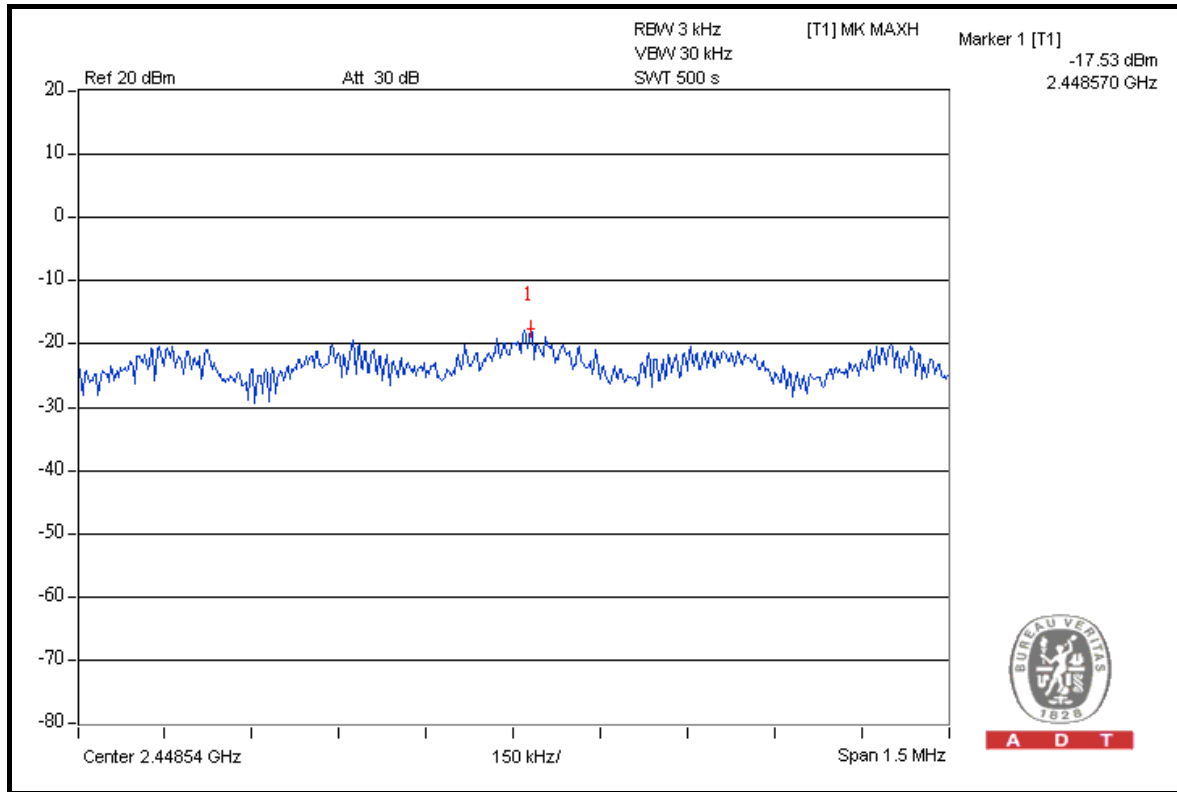

### FOR CHAIN 1: CH 1

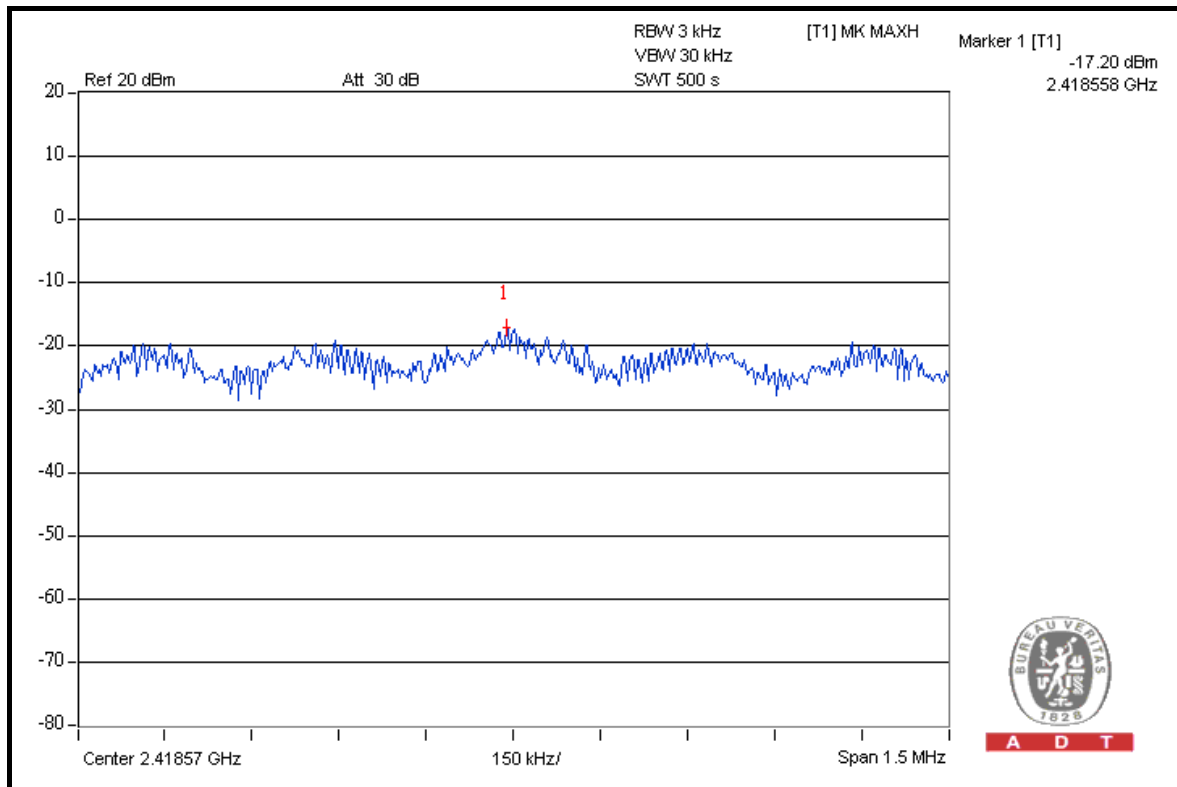



A D T

### CH 4

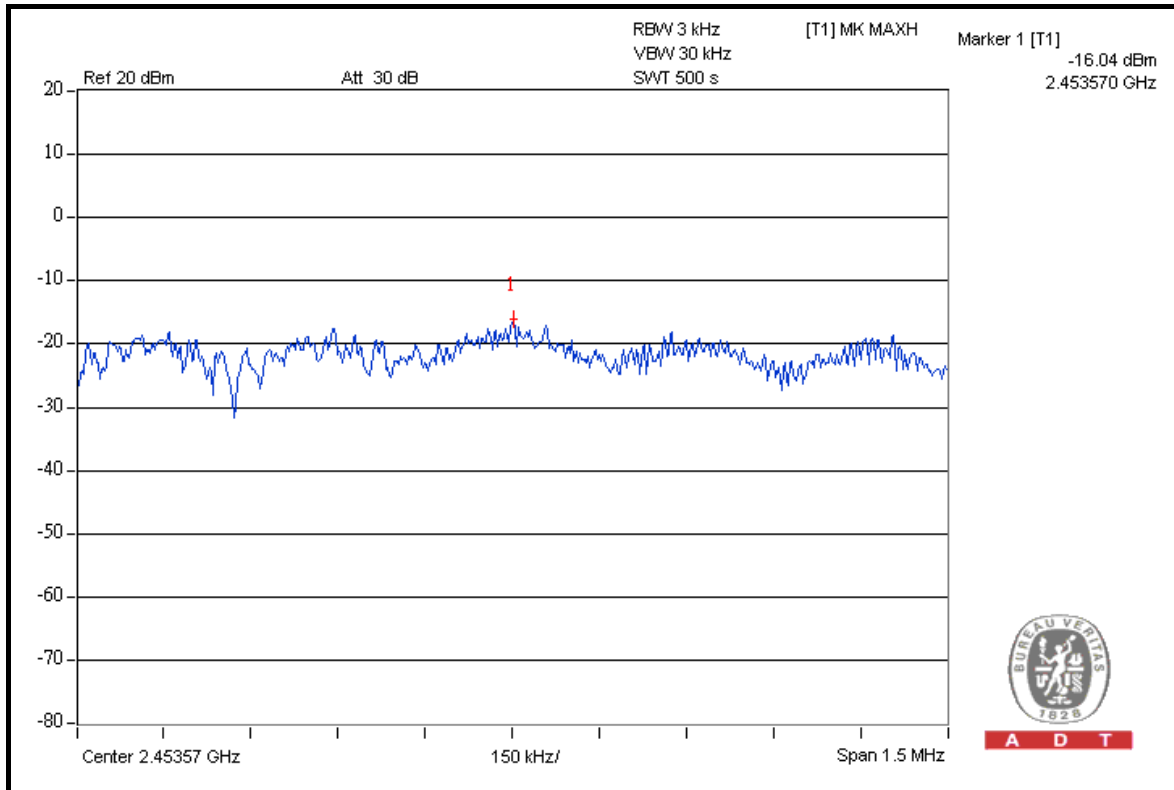

### CH 7

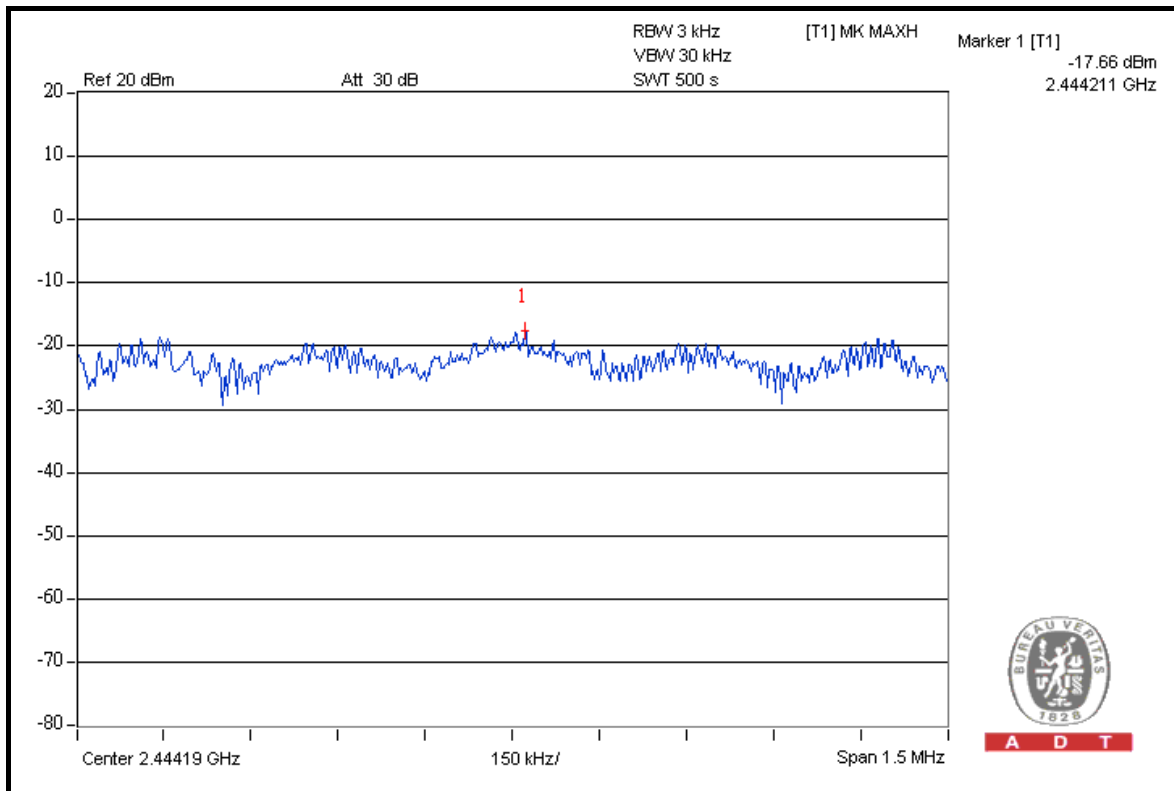



A D T

## 4.6 BAND EDGES MEASUREMENT

### 4.6.1 LIMITS OF BAND EDGES MEASUREMENT

Below -20dB of the highest emission level of operating band (in 100kHz Resolution Bandwidth).

### 4.6.2 TEST INSTRUMENTS

DESCRIPTION & MANUFACTURER	MODEL NO.	SERIAL NO.	DATE OF CALIBRATION	DUE DATE OF CALIBRATION
Test Receiver ROHDE & SCHWARZ	ESIB7	100212	May 28, 2008	May 27, 2009
Spectrum Analyzer ROHDE & SCHWARZ	FSP40	100269	Aug. 08, 2008	Aug. 07, 2009
BILOG Antenna SCHWARZBECK	VULB9168	9168-156	Apr. 25, 2008	Apr. 24, 2009
HORN Antenna SCHWARZBECK	BBHA 9120 D	9120D-563	Aug. 06, 2008	Aug. 05, 2009
HORN Antenna SCHWARZBECK	BBHA 9170	BBHA9170148	Jul. 03, 2008	Jul. 02, 2009
Preamplifier Agilent	8449B	3008A01911	Sep. 10, 2008	Sep. 09, 2009
Preamplifier Agilent	8447D	2944A10638	Dec. 26, 2008	Dec. 25, 2009
RF signal cable HUBER+SUHNNER	SUCOFLEX 104	218190/4 231241/4	May 20, 2008	May 19, 2009
RF signal cable Worken	8D-FB	Cable-HYCH9-01	Aug. 09, 2008	Aug. 08, 2009
Software	ADT_Radiated_ V7.6.15.9.2	NA	NA	NA
Antenna Tower EMCO	2070/2080	512.835.4684	NA	NA
Turn Table EMCO	2087-2.03	NA	NA	NA
Antenna Tower & Turn Table Controller EMCO	2090	NA	NA	NA

- NOTE:**
1. The calibration interval of the above test instruments is 12 months and the calibrations are traceable to NML/ROC and NIST/USA.
  2. The test was performed in HwaYa Chamber 9.
  3. The horn antenna and HP preamplifier (model: 8449B) are used only for the measurement of emission frequency above 1GHz if tested.
  4. The FCC Site Registration No. is 460141.
  5. The IC Site Registration No. is IC 7450F-4.



A D T

#### 4.6.3 TEST PROCEDURE

- a. The EUT was placed on the top of a rotating table 0.8 meters above the ground at a 3 meter semi-anechoic chamber. The table was rotated 360 degrees to determine the position of the highest radiation.
- b. The EUT was set 3 meters away from the interference-receiving antenna, which was mounted on the top of a variable-height antenna tower.
- c. The antenna is a broadband antenna, and its height is varied from one meter to four meters above the ground to determine the maximum value of the field strength. Both horizontal and vertical polarizations of the antenna are set to make the measurement.
- d. For each suspected emission, the EUT was arranged to its worst case and then the antenna was tuned to heights from 1 meter to 4 meters and the rotatable table was turned from 0 degrees to 360 degrees to find the maximum reading.
- e. Set both RBW and VBW of spectrum analyzer to 100kHz and 300kHz with suitable frequency span including 100MHz bandwidth from band edge. The band edges was measured and recorded.

The spectrum plots (Peak RBW = 100kHz, VBW = 300kHz) are attached on the following pages.

**NOTE:** The resolution bandwidth of test receiver/spectrum analyzer is 1MHz and the video bandwidth is 10Hz for Average detection (AV) at frequency above 1GHz.



A D T

#### 4.6.4 DEVIATION FROM TEST STANDARD

No deviation.

#### 4.6.5 EUT OPERATING CONDITION

Same as Item 4.3.6.

#### 4.6.6 TEST RESULTS

The spectrum plots are attached on the following pages. D1 line indicates the highest level, and D2 line indicates the 20dB offset below D1. It shows compliance with the requirement in part 15.247(d).

#### 802.11b DSSS MODULATION

**NOTE 1:** The band edge emission plot on the next page shows 48.86dBc between carrier maximum power and local maximum emission in restrict band (2.3838GHz). The emission of carrier strength list in the test result of channel 1 at the item 4.1.7 is 106.49dBuV/m (Peak), so the maximum field strength in restrict band is  $106.49 - 48.86 = 57.63$ dBuV/m which is under 74dBuV/m limit.

The band edge emission plot of on the next page shows 56.36dBc between carrier maximum power and local maximum emission in restrict band (2.3862GHz). The emission of carrier strength list in the test result of channel 1 at the item 4.1.7 is 102.09dBuV/m (Average), so the maximum field strength in restrict band is  $102.09 - 56.36 = 45.73$ dBuV/m which is under 54dBuV/m limit.

**NOTE 2:** The band edge emission plot on the next second page shows 46.38dBc between carrier maximum power and local maximum emission in restrict band (2.4880GHz). The emission of carrier strength list in the test result of channel 11 at the item 4.1.7 is 105.41dBuV/m (Peak), so the maximum field strength in restrict band is  $105.41 - 46.38 = 59.03$ dBuV/m which is under 74dBuV/m limit.

The band edge emission plot on the next third page shows 53.51dBc between carrier maximum power and local maximum emission in restrict band (2.4878GHz). The emission of carrier strength list in the test result of channel 11 at the item 4.1.7 is 100.93dBuV/m (Average), so the maximum field strength in restrict band is  $100.93 - 53.51 = 47.42$ dBuV/m which is under 54dBuV/m limit.





A D T

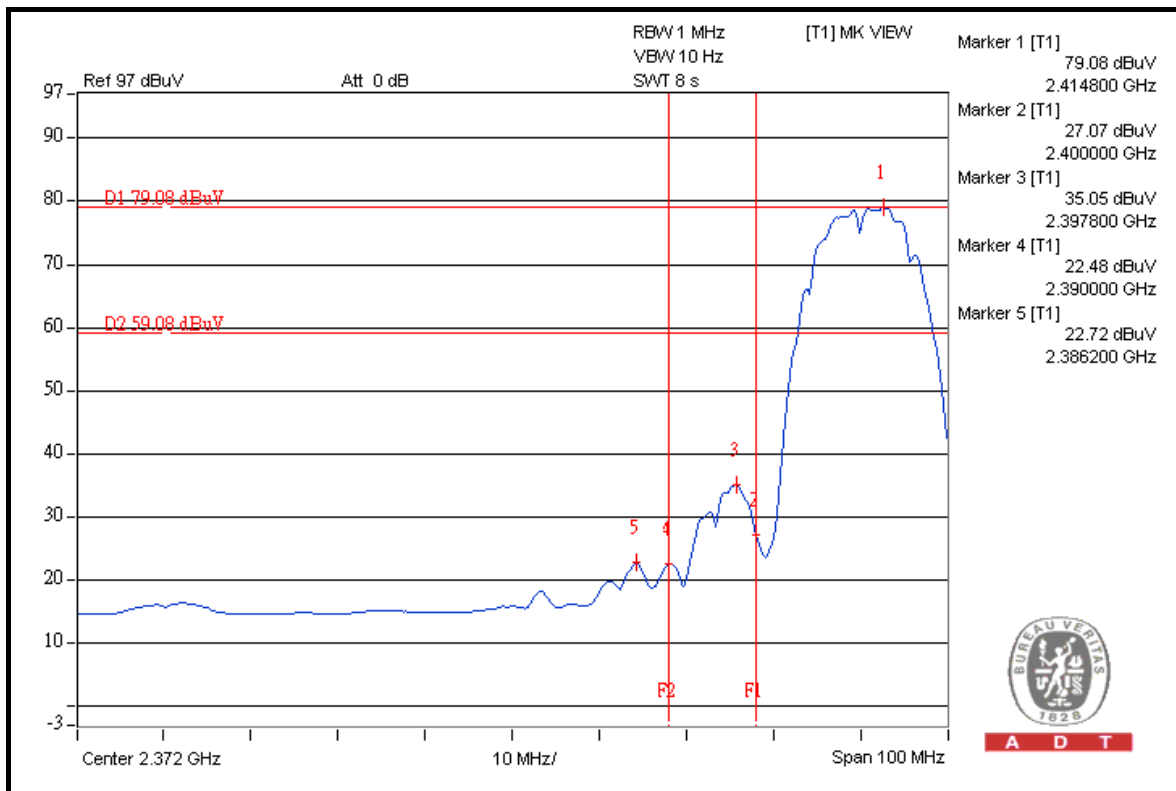
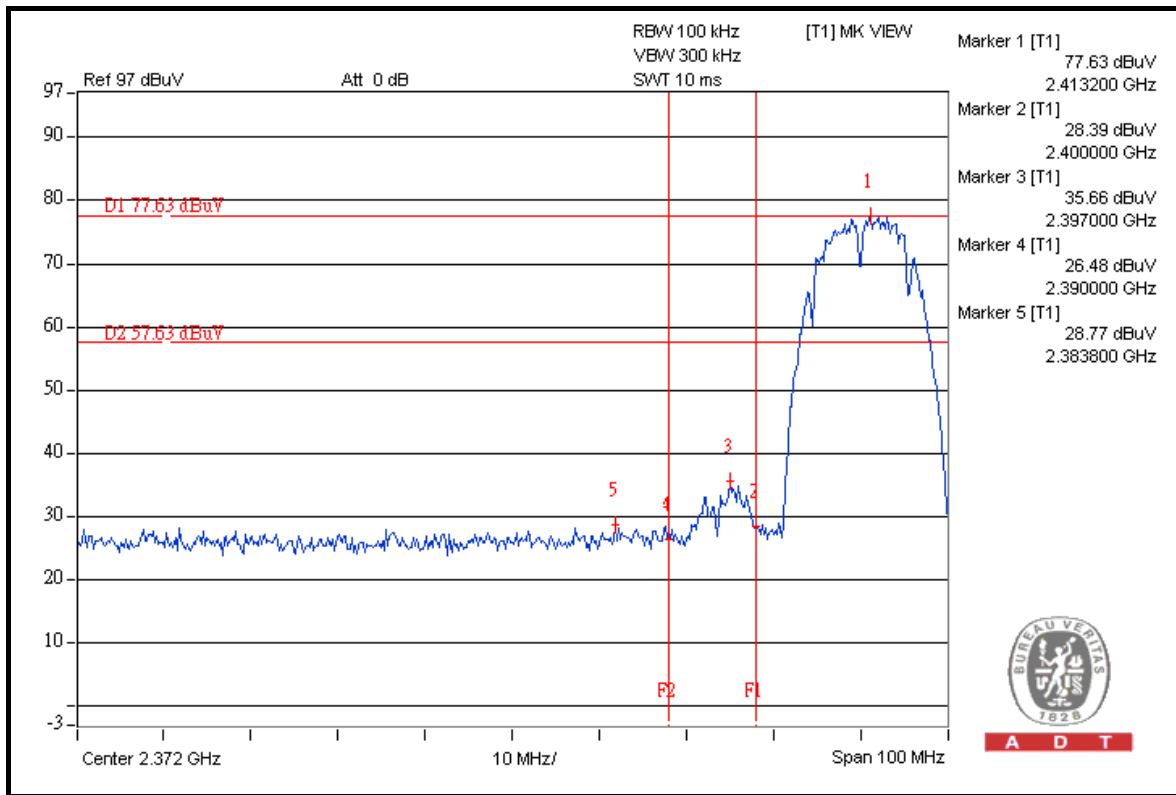



A D T

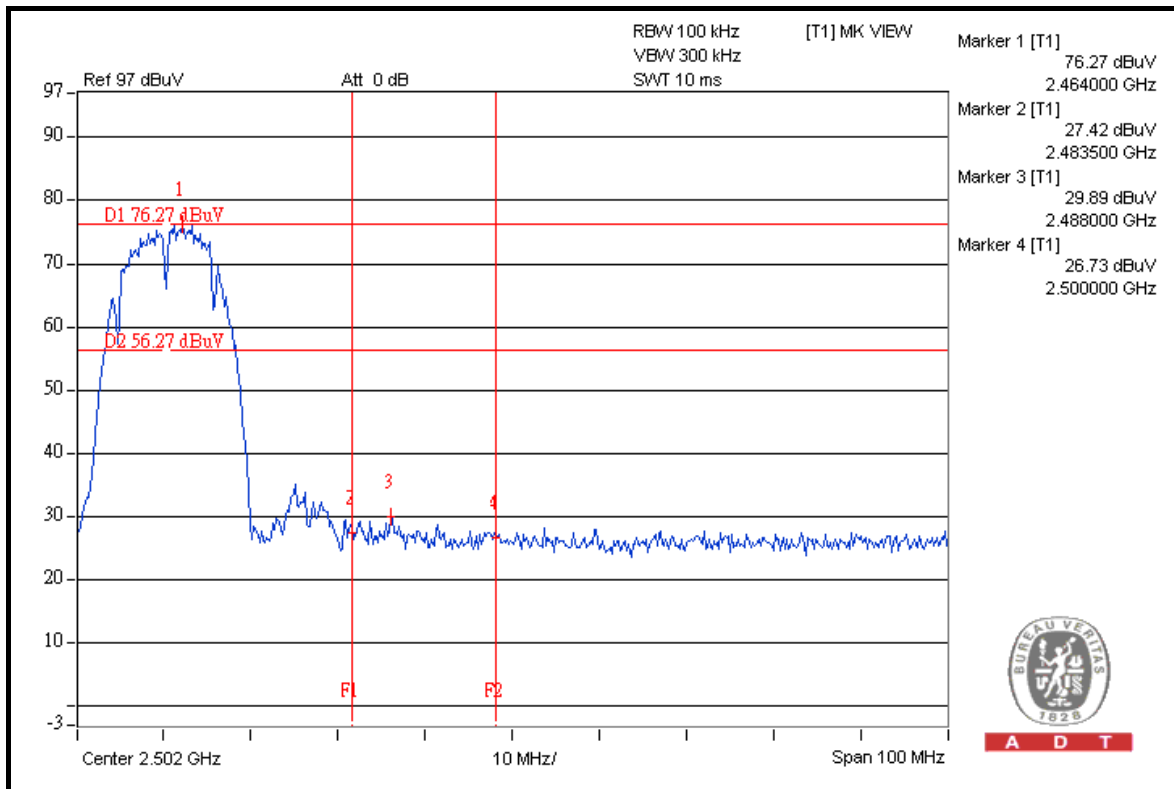
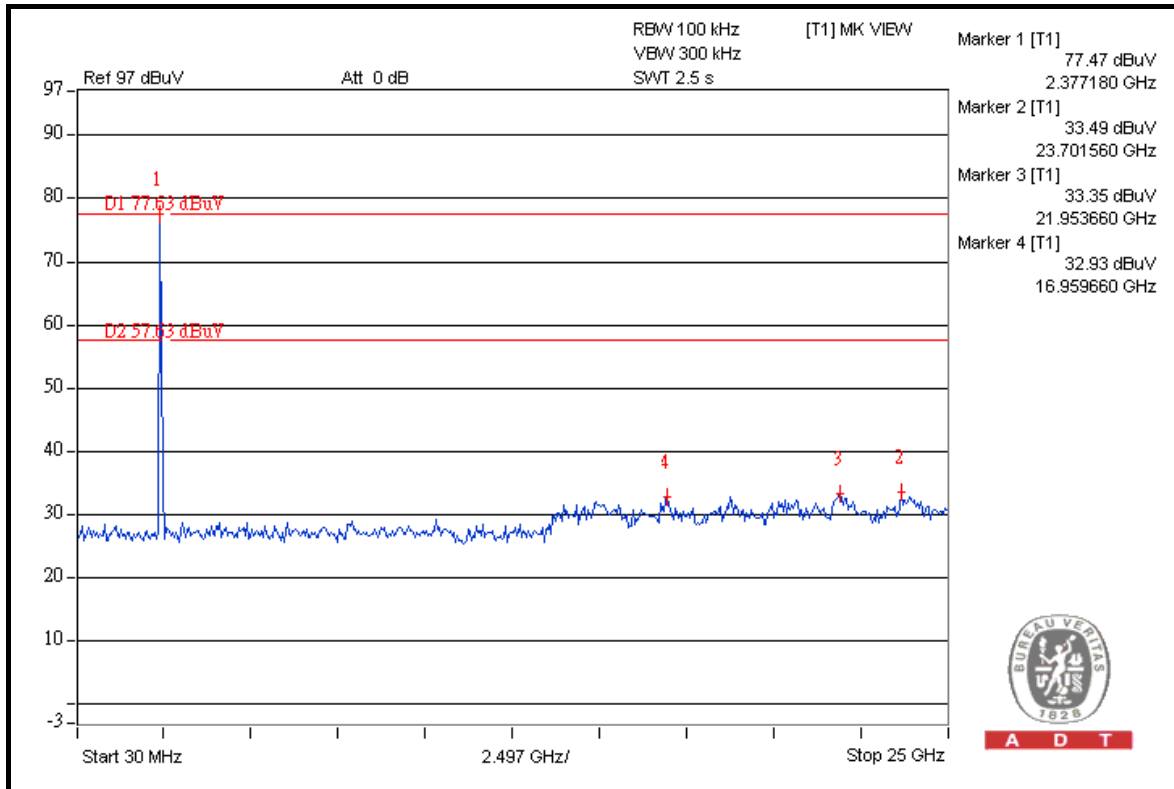



A D T

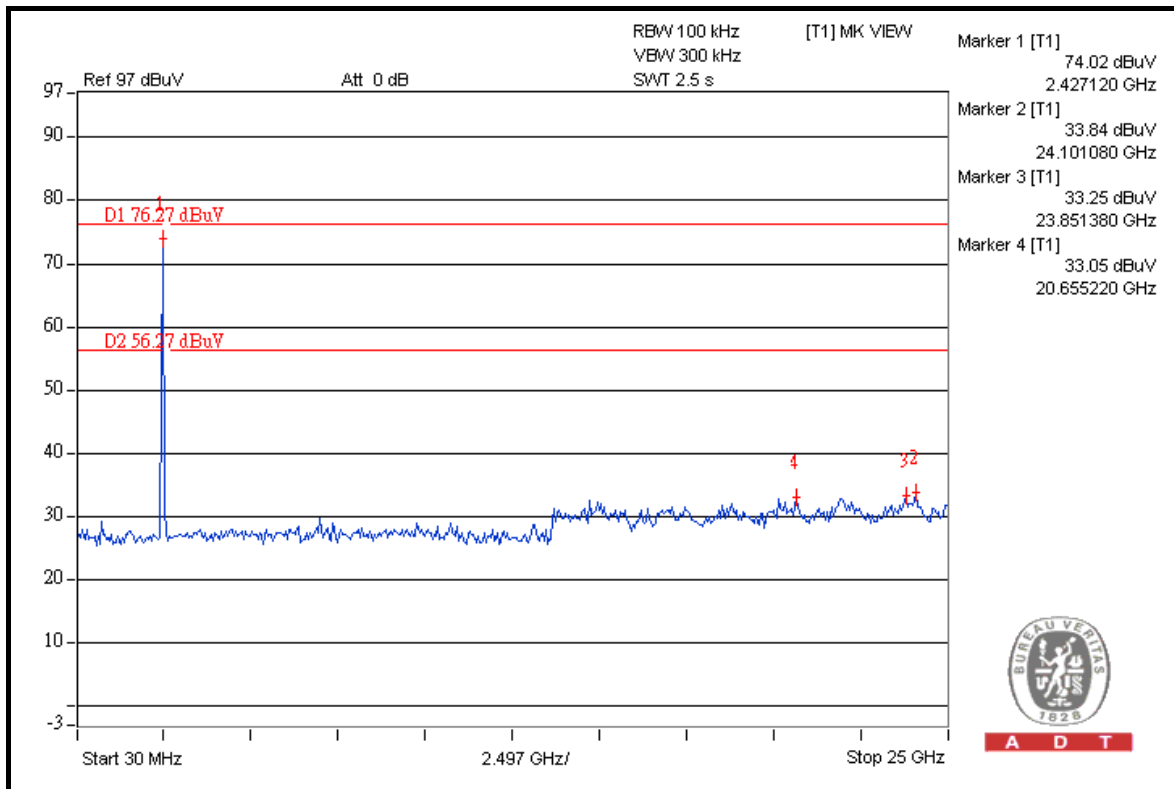
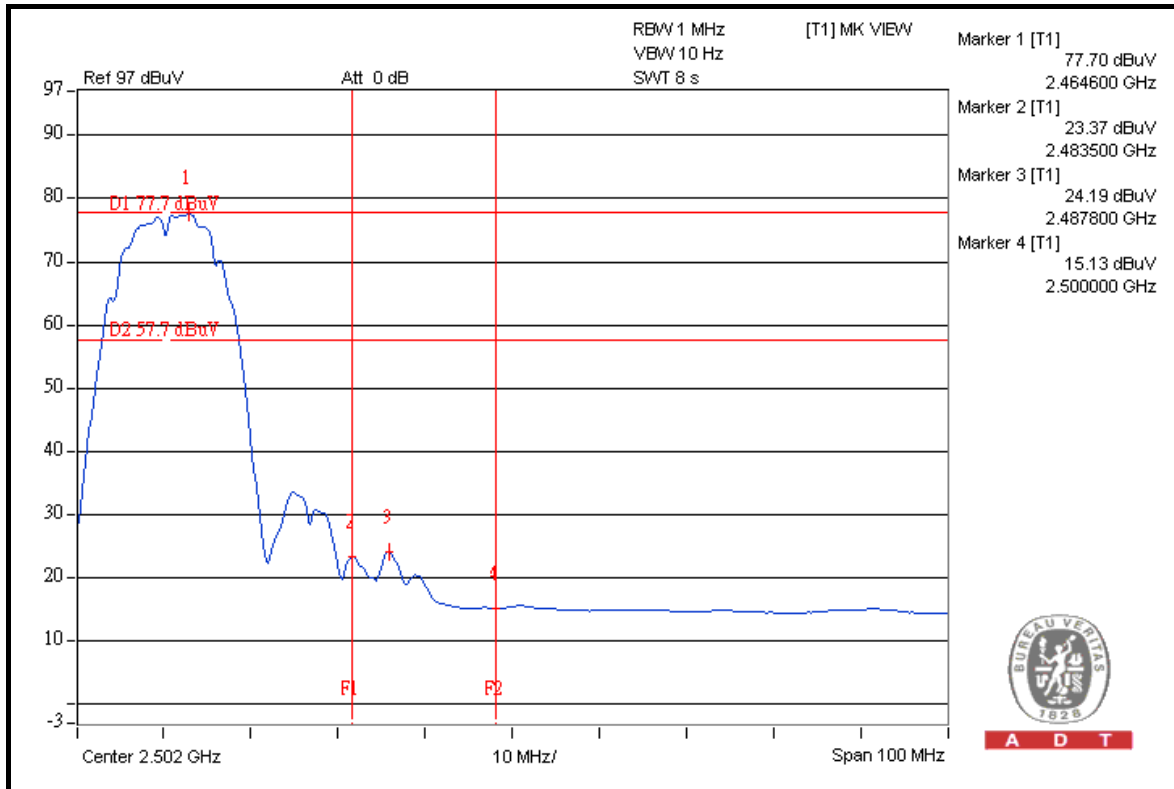



## 802.11g OFDM MODULATION

**NOTE 1:** The band edge emission plot on the next page shows 38.90dBc between carrier maximum power and local maximum emission in restrict band (2.3898GHz). The emission of carrier strength list in the test result of channel 1 at the item 4.1.7 is 106.66dBuV/m (Peak), so the maximum field strength in restrict band is  $106.66 - 38.90 = 67.76$ dBuV/m which is under 74dBuV/m limit.

The band edge emission plot of on the next page shows 50.14dBc between carrier maximum power and local maximum emission in restrict band (2.3900GHz). The emission of carrier strength list in the test result of channel 1 at the item 4.1.7 is 96.63dBuV/m (Average), so the maximum field strength in restrict band is  $96.63 - 50.14 = 46.49$ dBuV/m which is under 54dBuV/m limit.

**NOTE 2:** The band edge emission plot on the next second page shows 42.85dBc between carrier maximum power and local maximum emission in restrict band (2.4835GHz). The emission of carrier strength list in the test result of channel 11 at the item 4.1.7 is 105.45dBuV/m (Peak), so the maximum field strength in restrict band is  $105.45 - 42.85 = 62.60$ dBuV/m which is under 74dBuV/m limit.

The band edge emission plot on the next third page shows 51.03dBc between carrier maximum power and local maximum emission in restrict band (2.4835GHz). The emission of carrier strength list in the test result of channel 11 at the item 4.1.7 is 95.85dBuV/m (Average), so the maximum field strength in restrict band is  $95.85 - 51.03 = 44.82$ dBuV/m which is under 54dBuV/m limit.



A D T

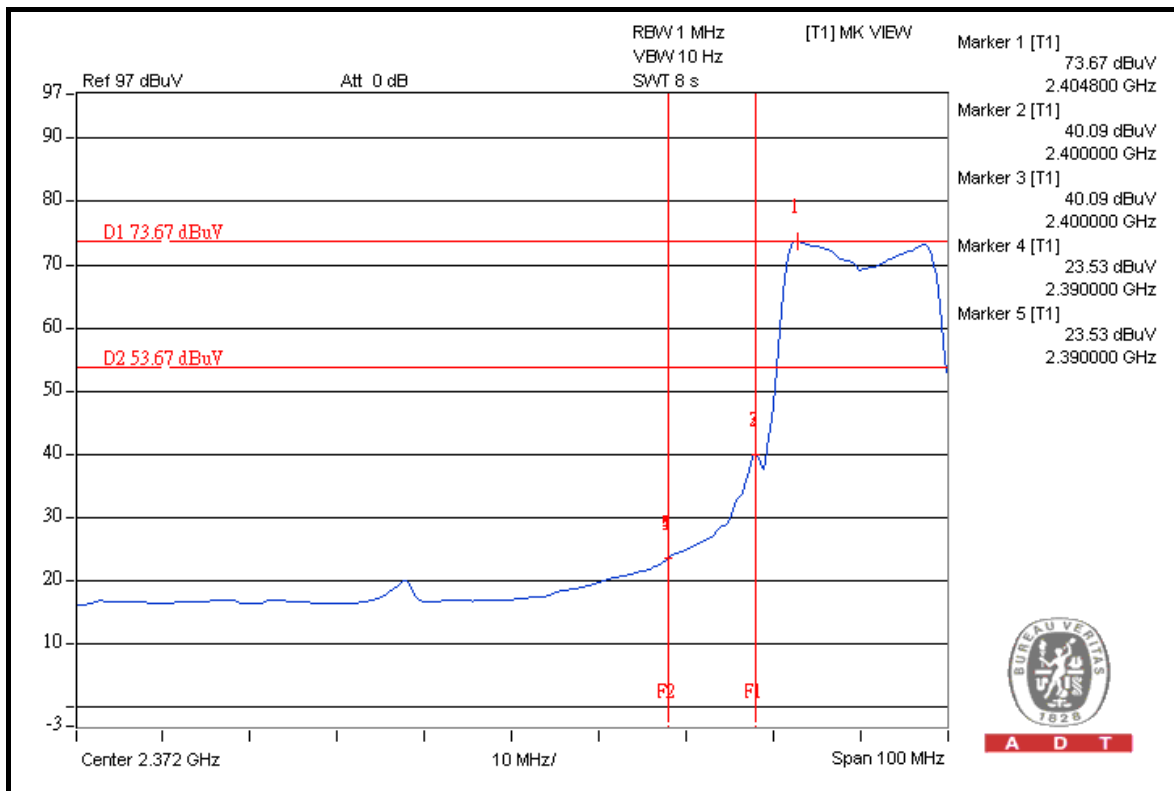
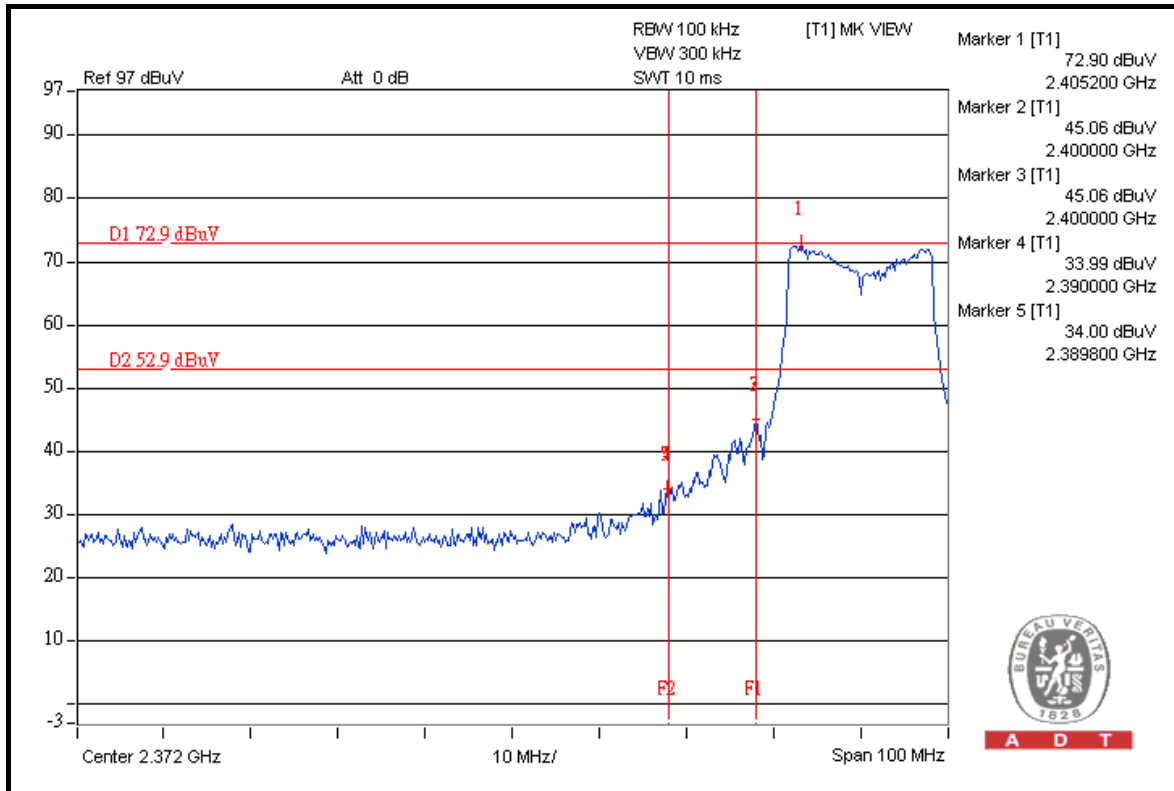



A D T

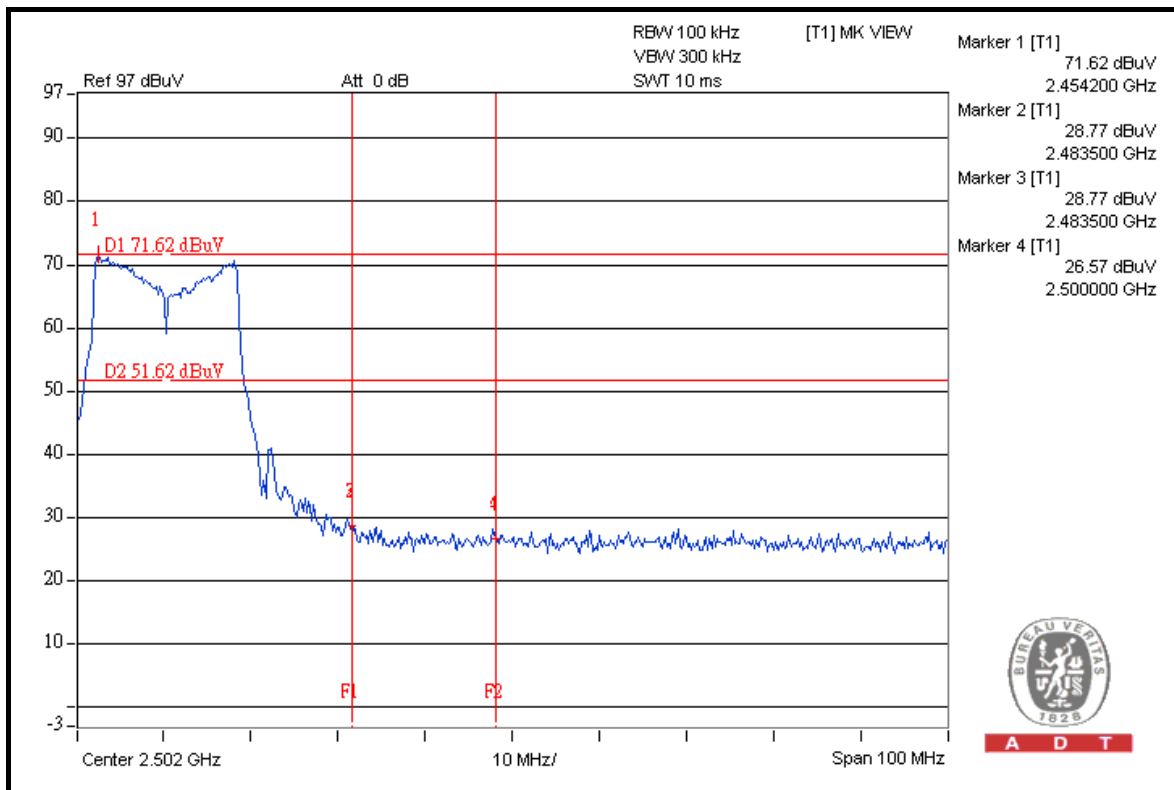
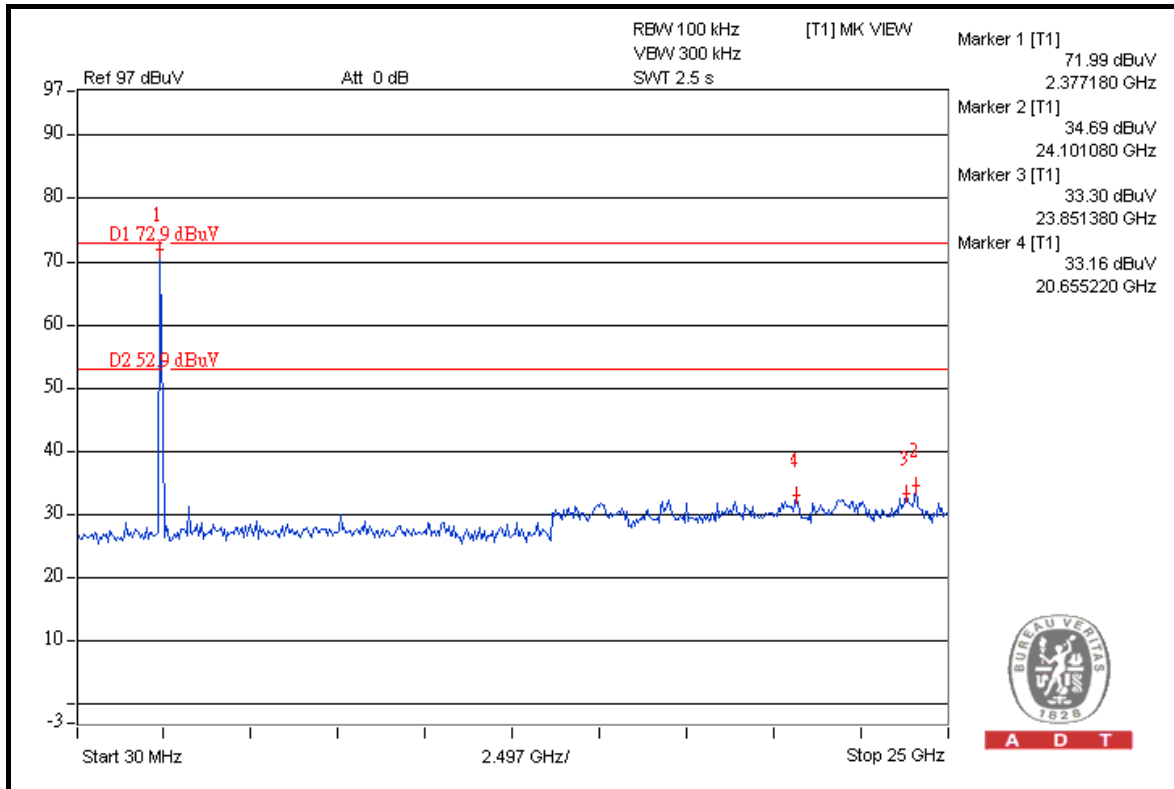



A D T

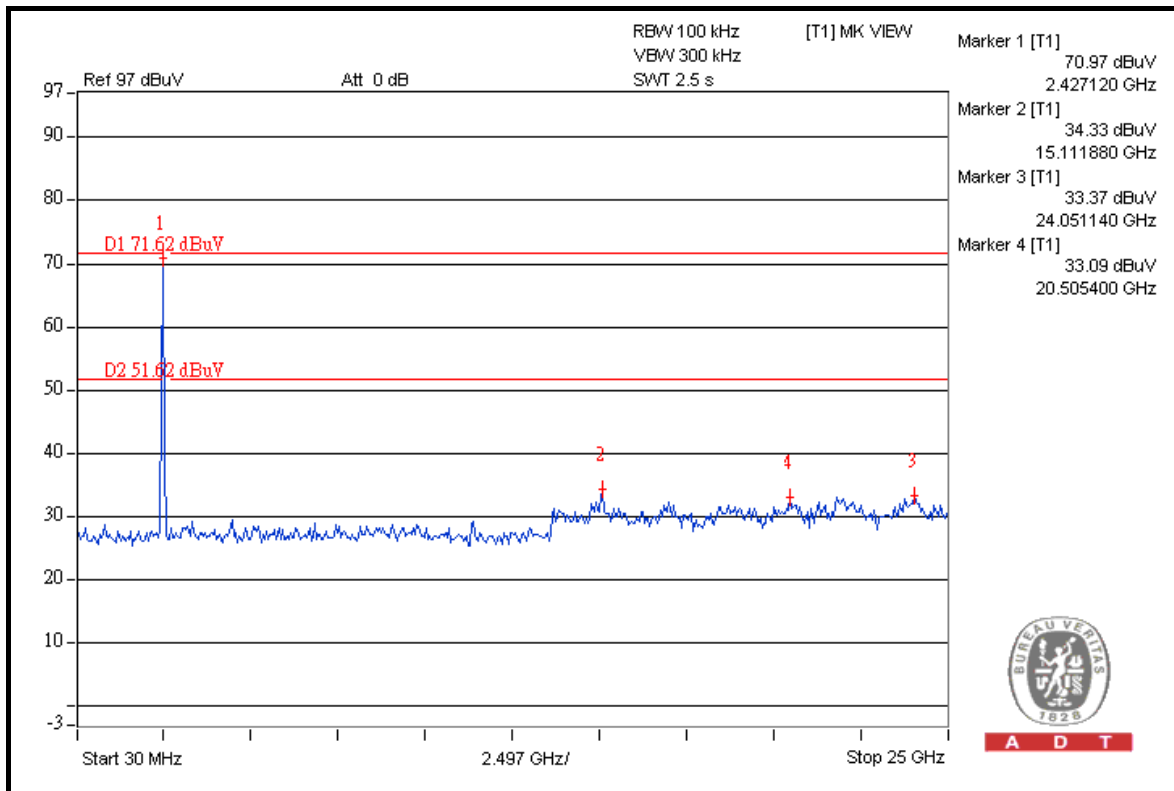
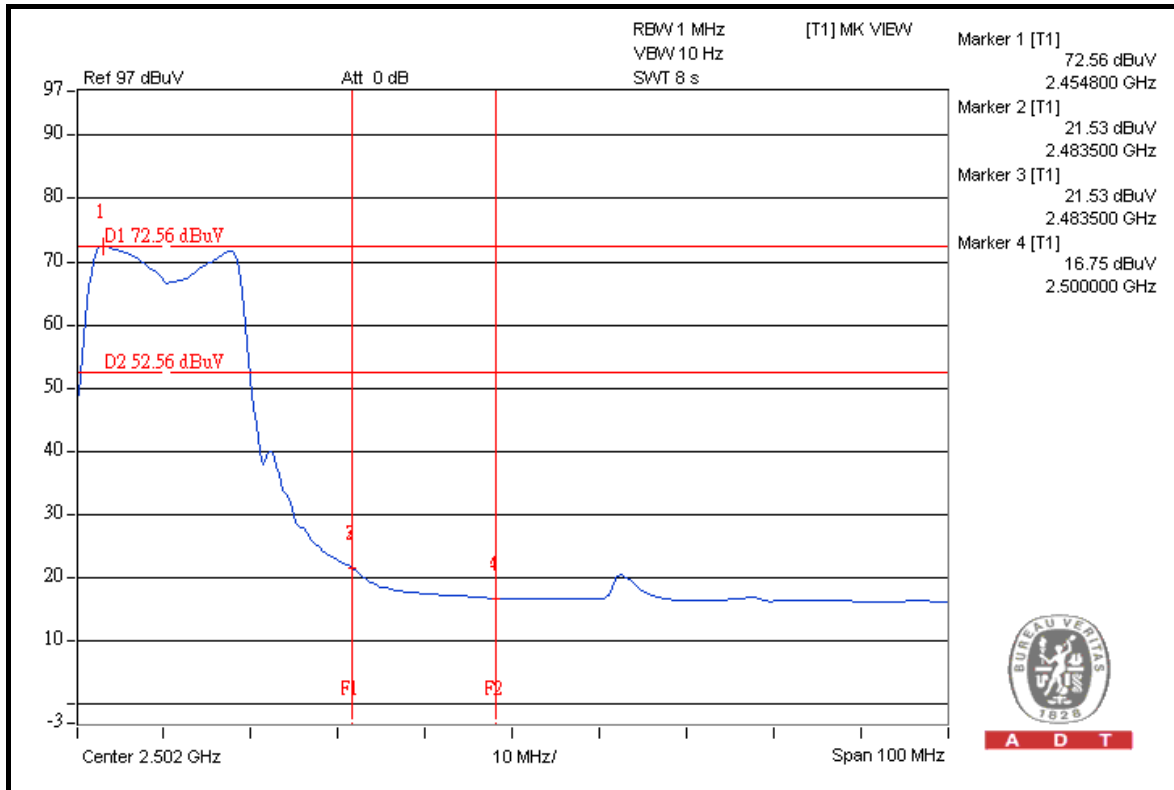

## DRAFT 802.11n (20MHz) OFDM MODULATION

**NOTE 1:** The band edge emission plot on the next page shows 39.84dBc between carrier maximum power and local maximum emission in restrict band (2.3892GHz). The emission of carrier strength list in the test result of channel 1 at the item 4.1.7 is 106.34dBuV/m (Peak), so the maximum field strength in restrict band is  $106.34 - 39.84 = 66.50$ dBuV/m which is under 74dBuV/m limit.

The band edge emission plot of on the next page shows 50.44dBc between carrier maximum power and local maximum emission in restrict band (2.3900GHz). The emission of carrier strength list in the test result of channel 1 at the item 4.1.7 is 96.05dBuV/m (Average), so the maximum field strength in restrict band is  $96.05 - 50.44 = 45.61$ dBuV/m which is under 54dBuV/m limit.

**NOTE 2:** The band edge emission plot on the next second page shows 42.26dBc between carrier maximum power and local maximum emission in restrict band (2.4860GHz). The emission of carrier strength list in the test result of channel 11 at the item 4.1.7 is 105.59dBuV/m (Peak), so the maximum field strength in restrict band is  $105.59 - 42.26 = 63.33$ dBuV/m which is under 74dBuV/m limit.

The band edge emission plot on the next third page shows 49.48dBc between carrier maximum power and local maximum emission in restrict band (2.4835GHz). The emission of carrier strength list in the test result of channel 11 at the item 4.1.7 is 95.13dBuV/m (Average), so the maximum field strength in restrict band is  $95.13 - 49.48 = 45.65$ dBuV/m which is under 54dBuV/m limit.





A D T

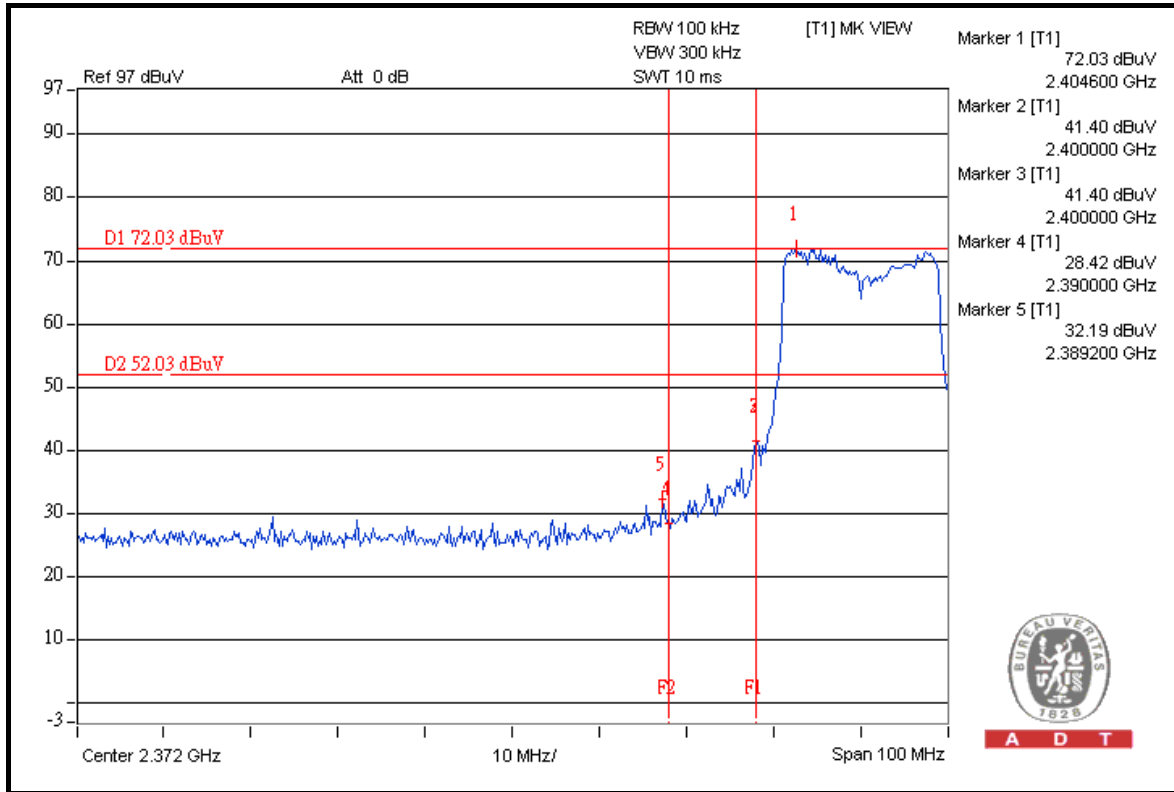

A D T

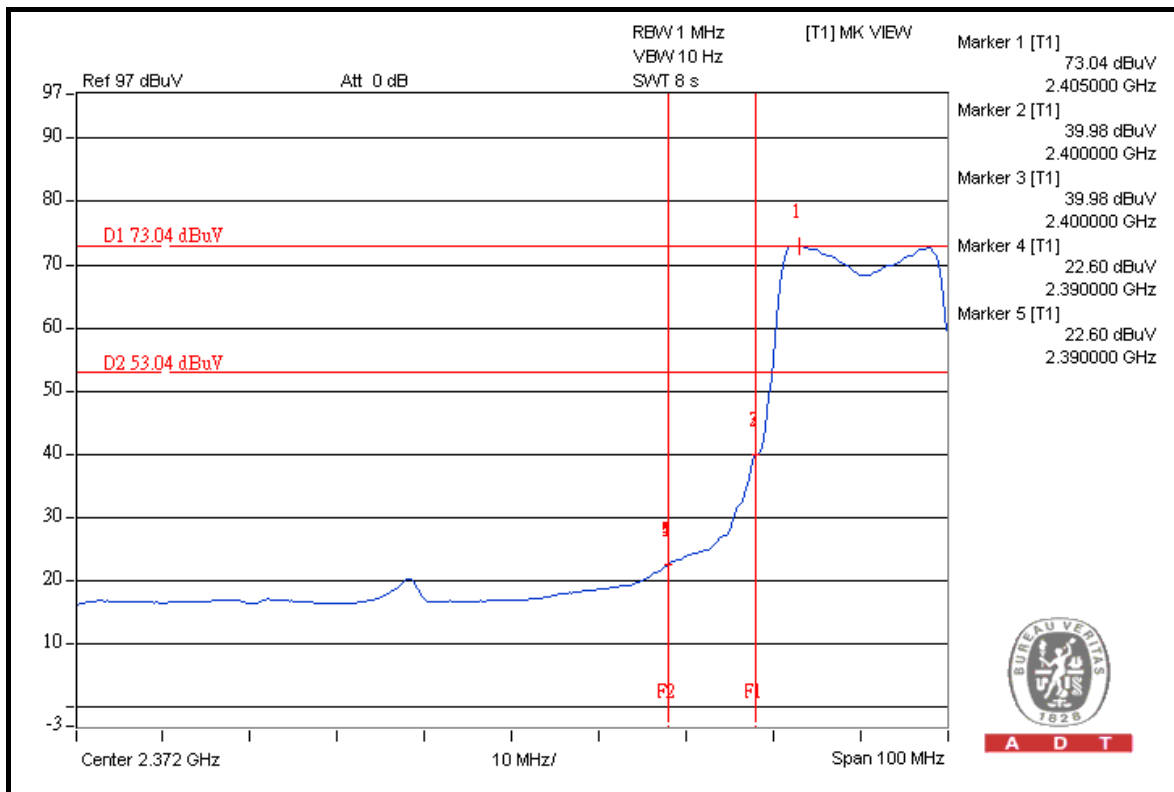

A D T



A D T

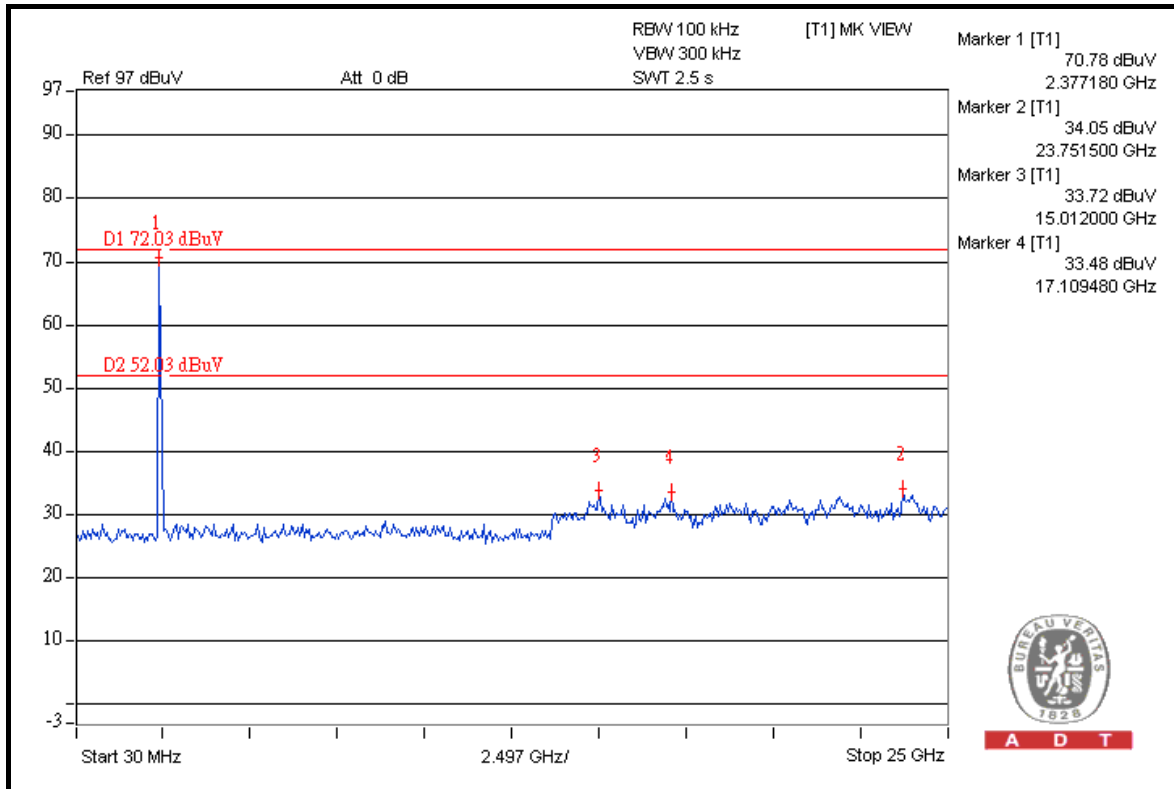

A D T

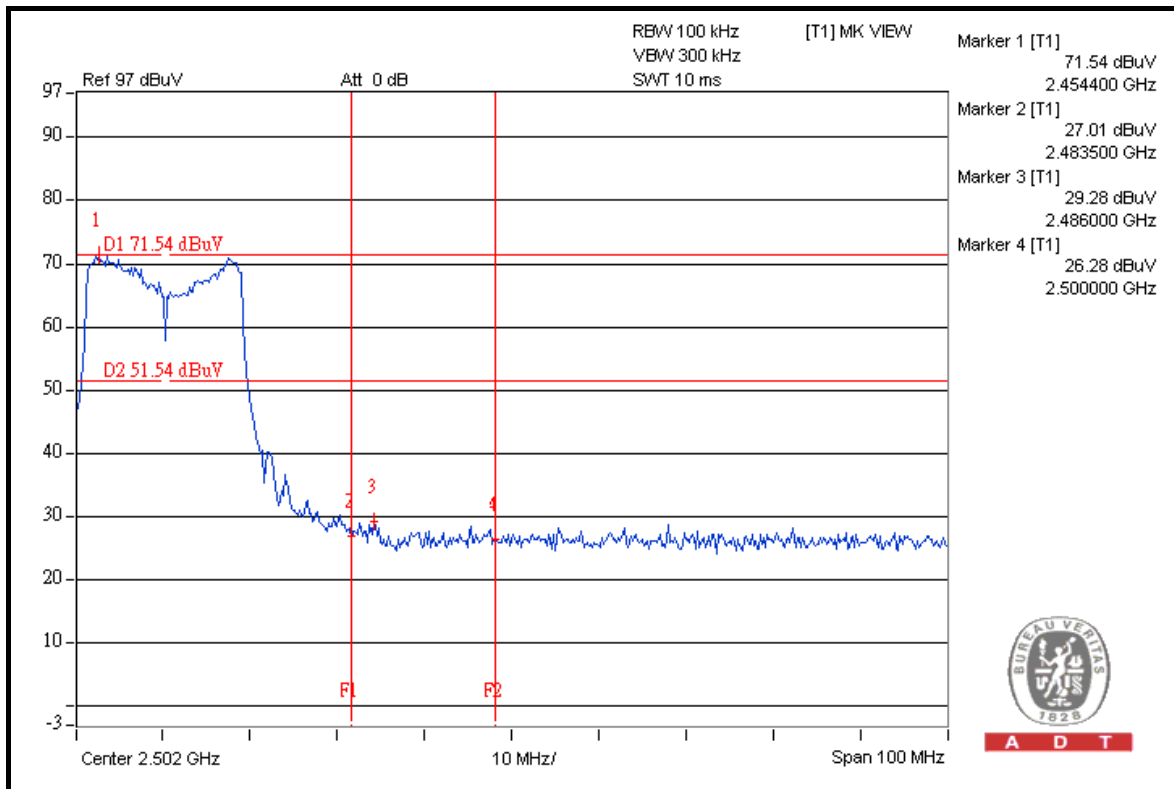

A D T



A D T

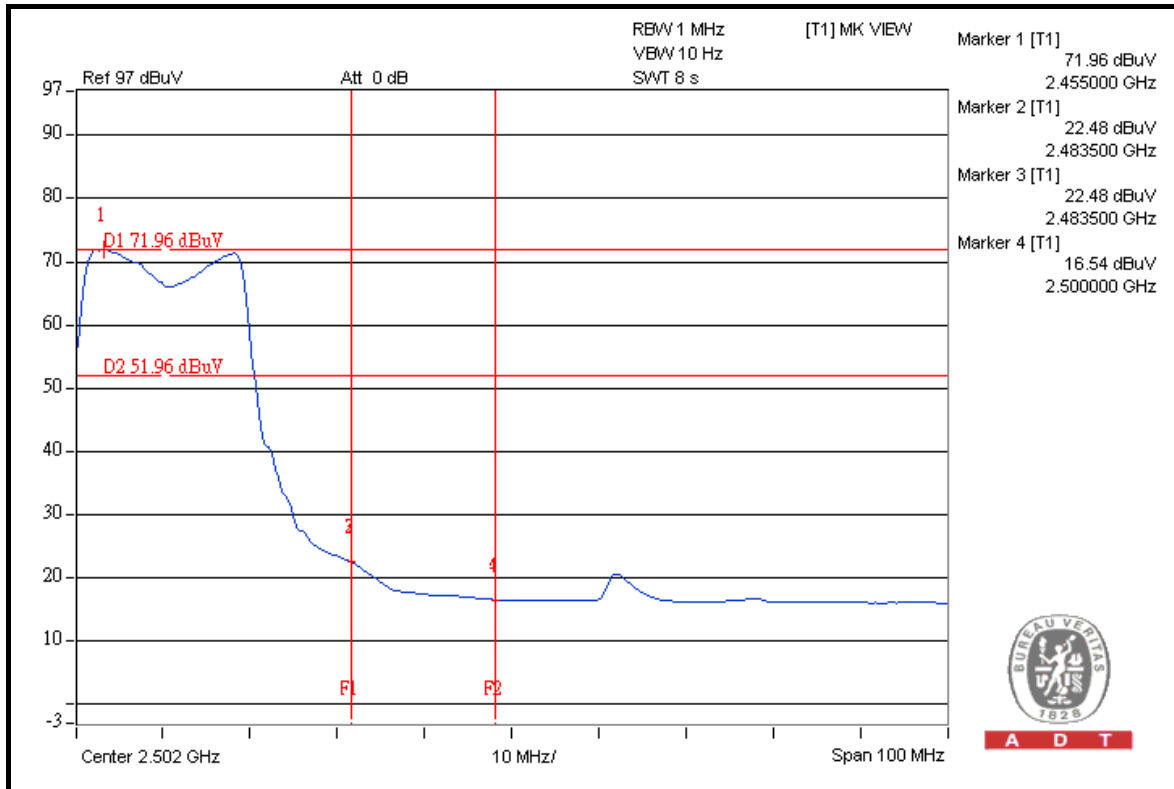

A D T

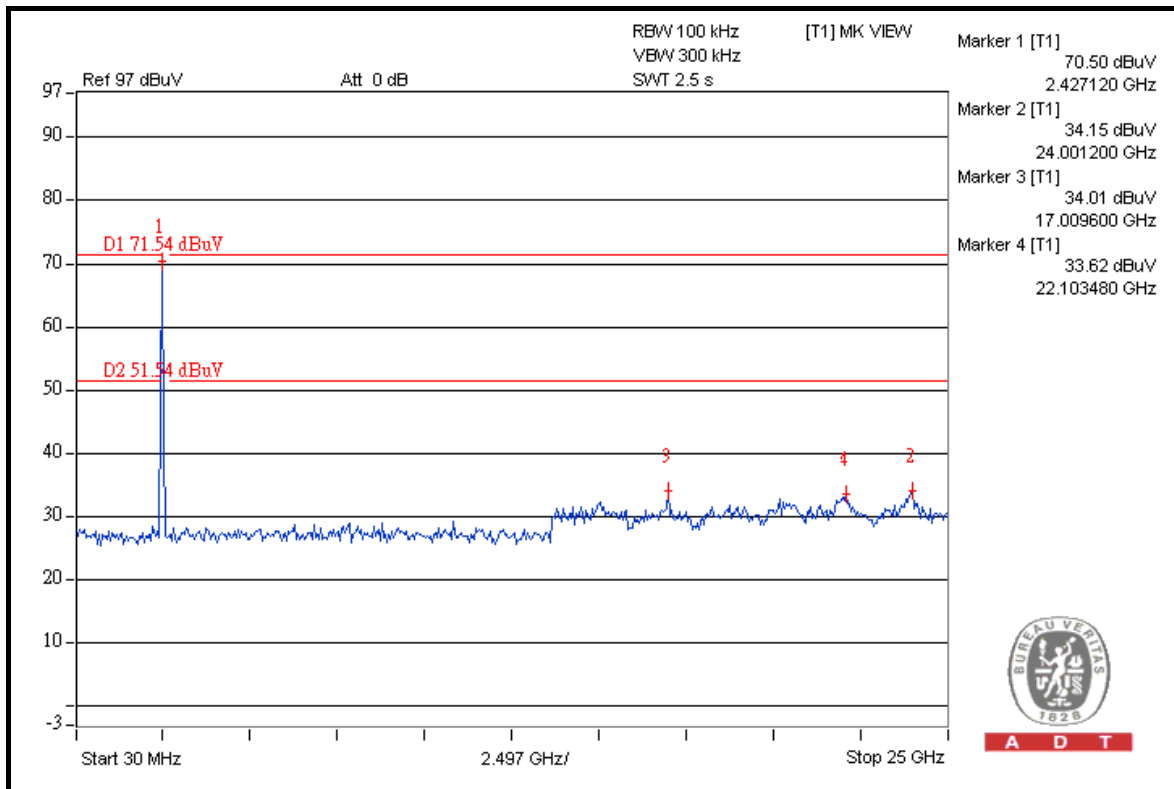

A D T



## DRAFT 802.11n (40MHz) OFDM MODULATION

**NOTE 1:** The band edge emission plot on the next page shows 37.23dBc between carrier maximum power and local maximum emission in restrict band (2.2708GHz). The emission of carrier strength list in the test result of channel 1 at the item 4.1.7 is 102.07dBuV/m (Peak), so the maximum field strength in restrict band is  $102.07 - 37.23 = 64.84$ dBuV/m which is under 74dBuV/m limit.

The band edge emission plot of on the next page shows 46.44dBc between carrier maximum power and local maximum emission in restrict band (2.3868GHz). The emission of carrier strength list in the test result of channel 1 at the item 4.1.7 is 91.84dBuV/m (Average), so the maximum field strength in restrict band is  $91.84 - 46.44 = 45.40$ dBuV/m which is under 54dBuV/m limit.

**NOTE 2:** The band edge emission plot on the next second page shows 36.76dBc between carrier maximum power and local maximum emission in restrict band (2.4864GHz). The emission of carrier strength list in the test result of channel 7 at the item 4.1.7 is 101.69dBuV/m (Peak), so the maximum field strength in restrict band is  $101.69 - 36.76 = 64.93$ dBuV/m which is under 74dBuV/m limit.

The band edge emission plot on the next third page shows 45.92dBc between carrier maximum power and local maximum emission in restrict band (2.4872GHz). The emission of carrier strength list in the test result of channel 7 at the item 4.1.7 is 91.49dBuV/m (Average), so the maximum field strength in restrict band is  $91.49 - 45.92 = 45.57$ dBuV/m which is under 54dBuV/m limit.



A D T

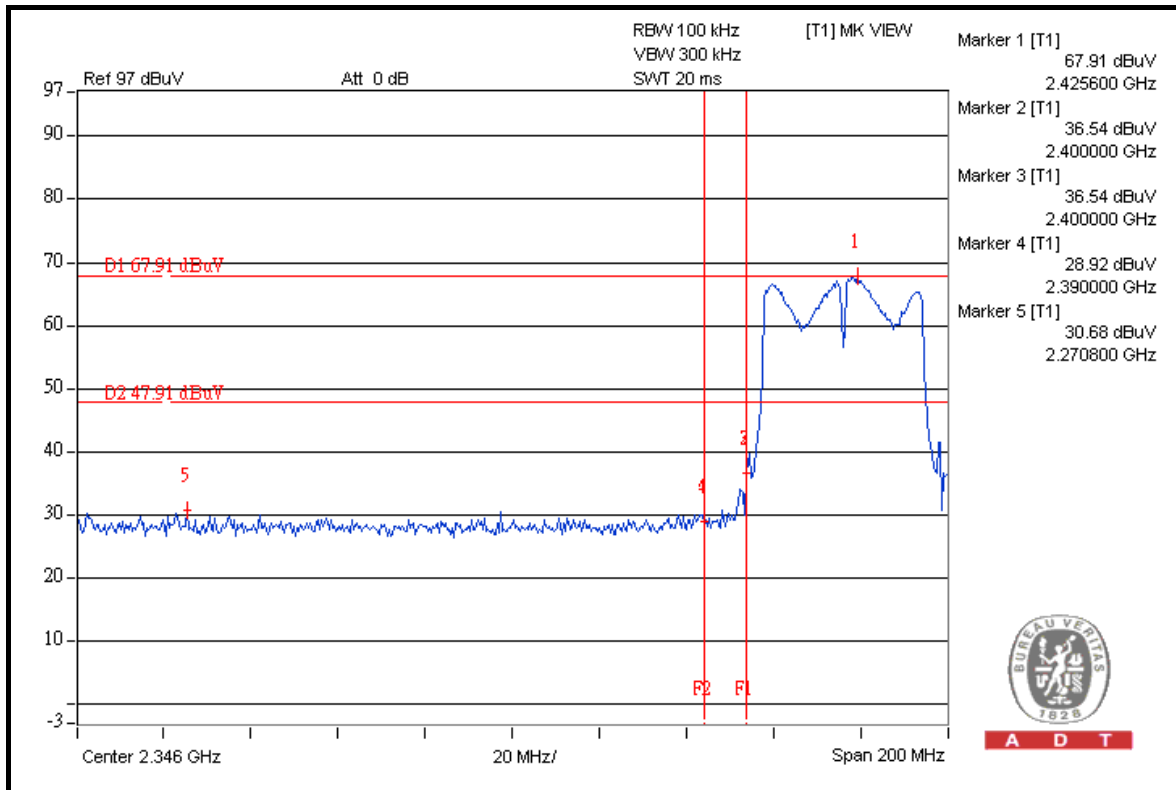

A D T

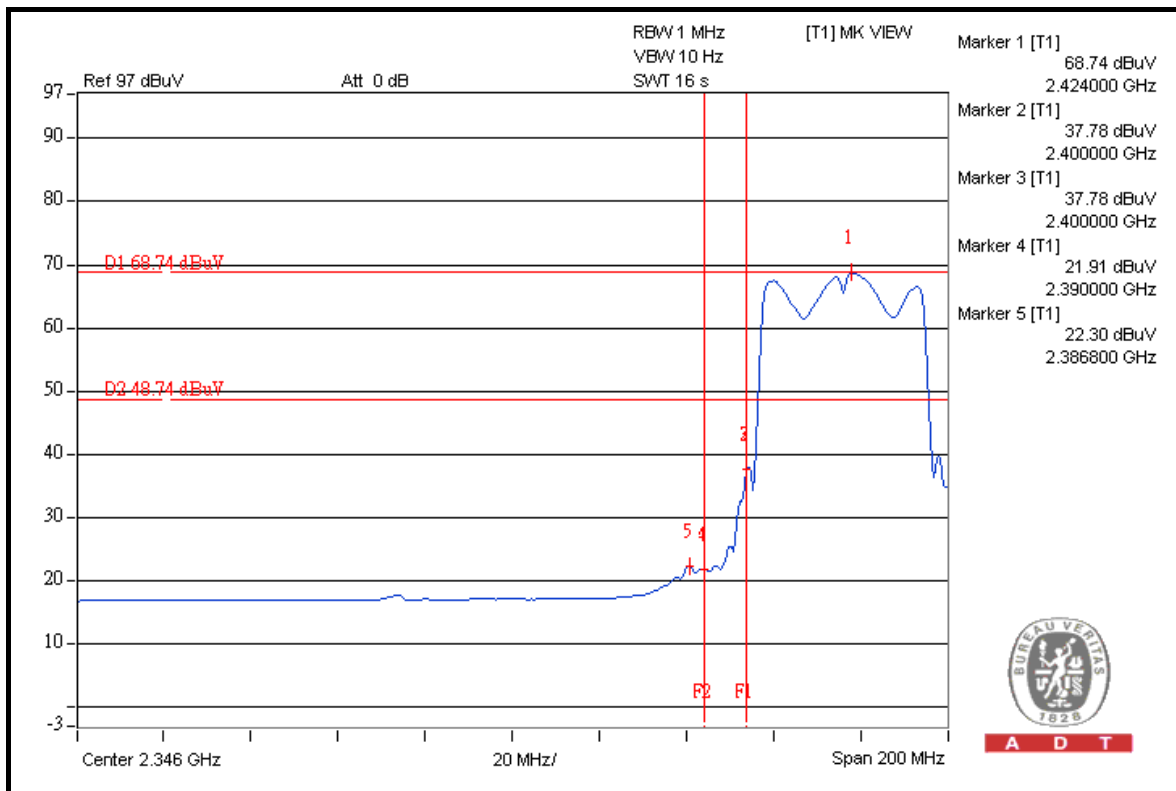

A D T



A D T

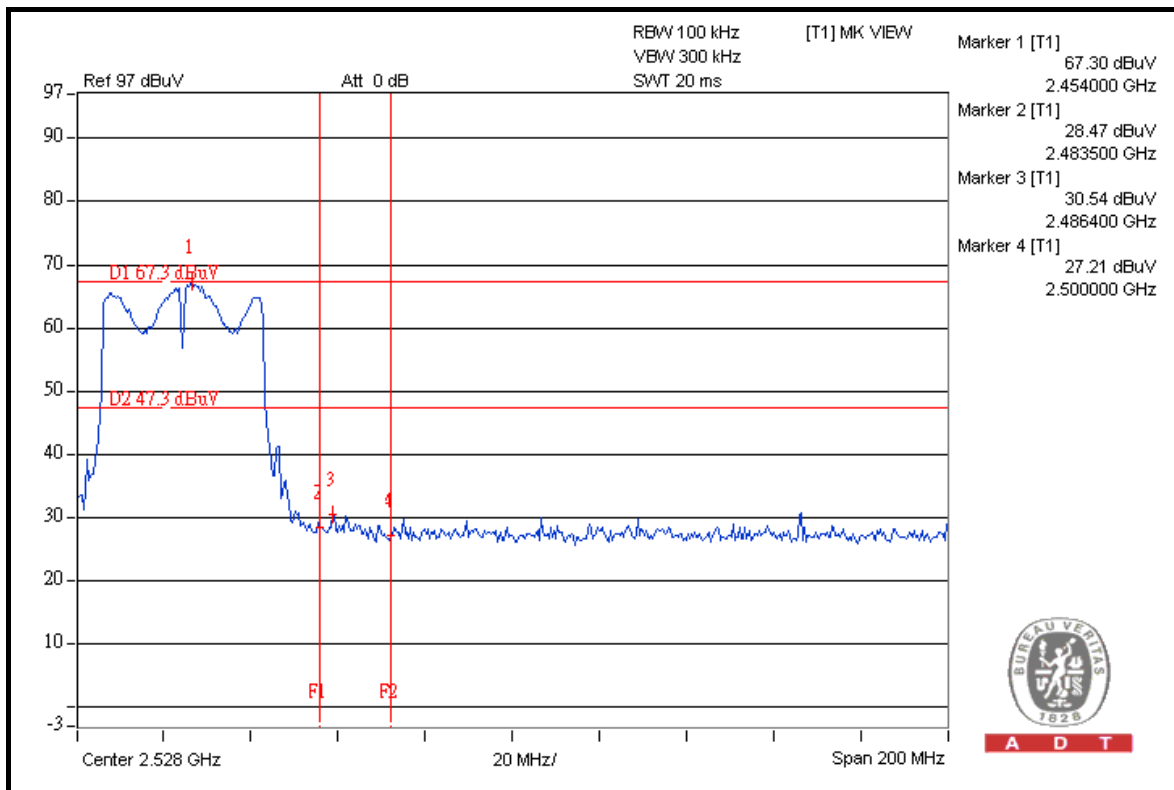
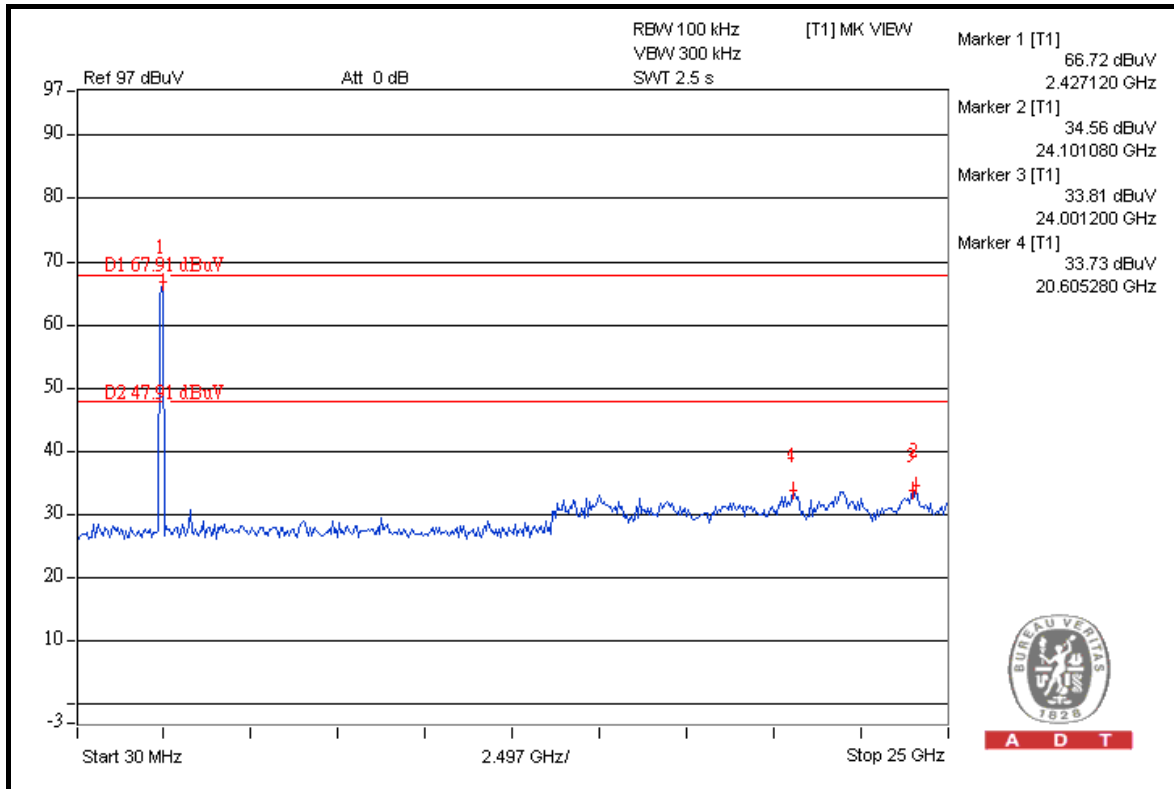



A D T

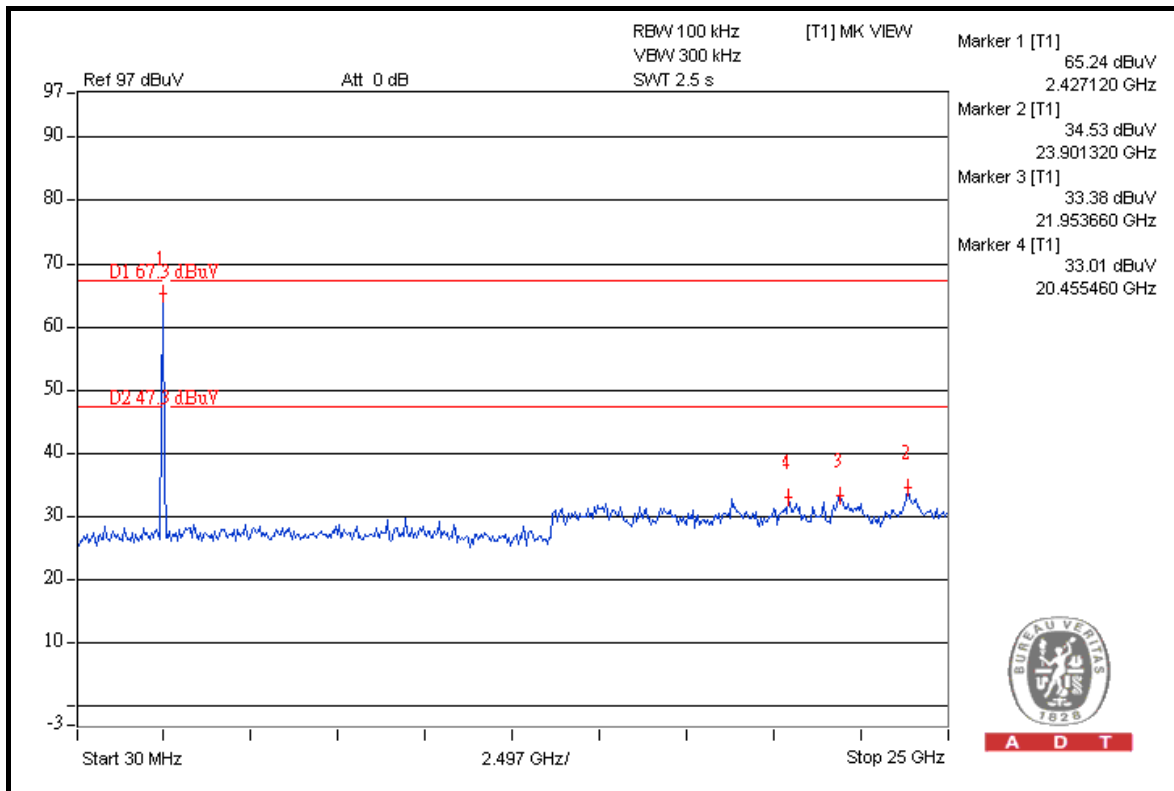
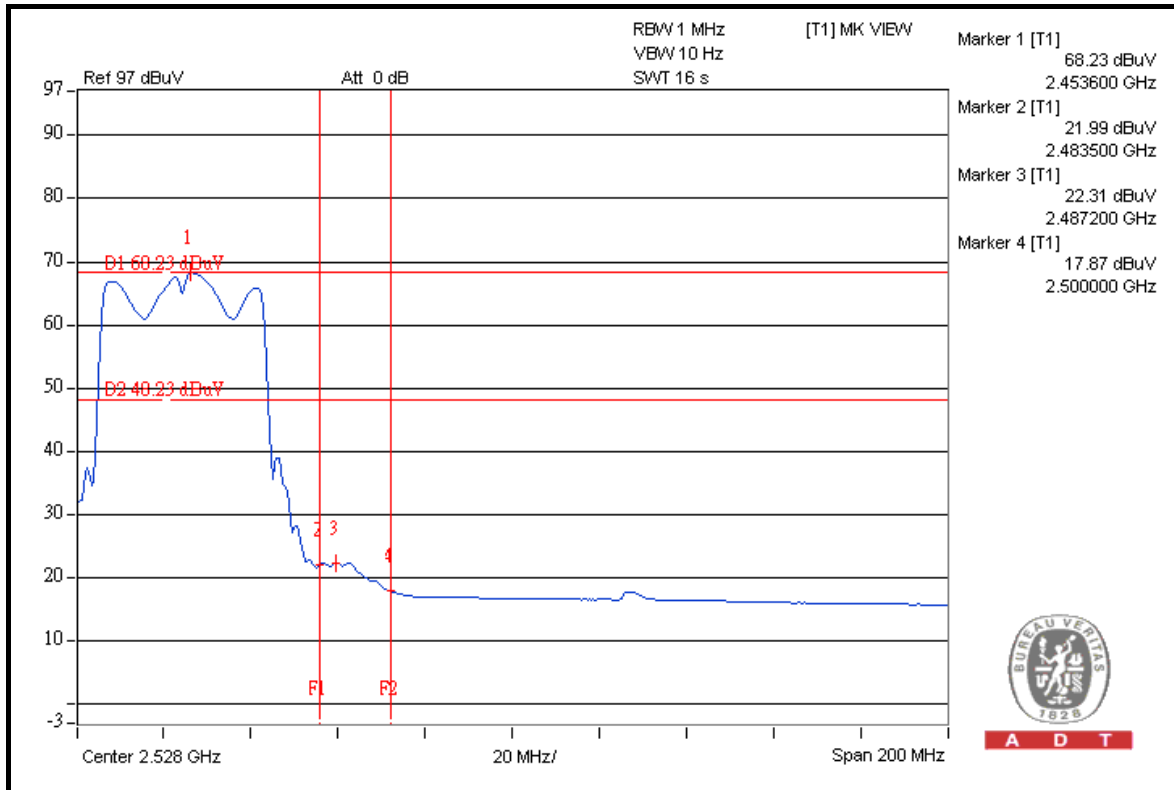



A D T

## 4.7 ANTENNA REQUIREMENT

### 4.7.1 STANDARD APPLICABLE

For intentional device, according to FCC 47 CFR Section 15.203, an intentional radiator shall be designed to ensure that no antenna other than that furnished by the responsible party shall be used with the device.

And according to FCC 47 CFR Section 15.247 (b), if transmitting antennas of directional gain greater than 6dBi are used, the power shall be reduced by the amount in dB that the directional gain of the antenna exceeds 6dBi.

### 4.7.2 ANTENNA CONNECTED CONSTRUCTION

The antenna used in this product is Printed antenna without connector. The maximum gain of the antenna is -0.07dBi.





## 5. TEST TYPES AND RESULTS (FOR 5.0GHz BAND)

### 5.1 RADIATED EMISSION MEASUREMENT

#### 5.1.1 LIMITS OF RADIATED EMISSION MEASUREMENT

Emissions radiated outside of the specified bands, shall be according to the general radiated limits in 15.209 as following:

FREQUENCIES (MHz)	FIELD STRENGTH (microvolts/meter)	MEASUREMENT DISTANCE (meters)
0.009 ~ 0.490	2400/F(kHz)	300
0.490 ~ 1.705	24000/F(kHz)	30
1.705 ~ 30.0	30	30
30 ~ 88	100	3
88 ~ 216	150	3
216 ~ 960	200	3
Above 960	500	3

**NOTE:**

1. The lower limit shall apply at the transition frequencies.
2. Emission level (dBuV/m) = 20 log Emission level (uV/m).
3. As shown in 15.35(b), for frequencies above 1000MHz, the field strength limits are based on average detector, however, the peak field strength of any emission shall not exceed the maximum permitted average limits, specified above by more than 20dB under any condition of modulation.



A D T

### 5.1.2 TEST INSTRUMENTS

DESCRIPTION & MANUFACTURER	MODEL NO.	SERIAL NO.	DATE OF CALIBRATION	DUE DATE OF CALIBRATION
Test Receiver ROHDE & SCHWARZ	ESIB7	100212	May 28, 2008	May 27, 2009
Spectrum Analyzer ROHDE & SCHWARZ	FSP40	100269	Aug. 08, 2008	Aug. 07, 2009
BILOG Antenna SCHWARZBECK	VULB9168	9168-156	Apr. 25, 2008	Apr. 24, 2009
HORN Antenna SCHWARZBECK	BBHA 9120 D	9120D-563	Aug. 06, 2008	Aug. 05, 2009
HORN Antenna SCHWARZBECK	BBHA 9170	BBHA9170148	Jul. 03, 2008	Jul. 02, 2009
Preamplifier Agilent	8449B	3008A01911	Sep. 10, 2008	Sep. 09, 2009
Preamplifier Agilent	8447D	2944A10638	Dec. 26, 2008	Dec. 25, 2009
RF signal cable HUBER+SUHNNER	SUCOFLEX 104	218190/4 231241/4	May 20, 2008	May 19, 2009
RF signal cable Worken	8D-FB	Cable-HYCH9-01	Aug. 09, 2008	Aug. 08, 2009
Software	ADT_Radiated_ V7.6.15.9.2	NA	NA	NA
Antenna Tower EMCO	2070/2080	512.835.4684	NA	NA
Turn Table EMCO	2087-2.03	NA	NA	NA
Antenna Tower & Turn Table Controller EMCO	2090	NA	NA	NA
26GHz ~ 40GHz Amplifier	EM26400	07026401	Aug. 27, 2008	Aug. 26, 2009

- NOTE:**
1. The calibration interval of the above test instruments is 12 months and the calibrations are traceable to NML/ROC and NIST/USA.
  2. The test was performed in HwaYa Chamber 9.
  3. The horn antenna and HP preamplifier (model: 8449B) are used only for the measurement of emission frequency above 1GHz if tested.
  4. The FCC Site Registration No. is 460141.
  5. The IC Site Registration No. is IC 7450F-4.



A D T

### 5.1.3 TEST PROCEDURES

- a. The EUT was placed on the top of a rotating table 0.8 meters above the ground at a 3 meters semi-anechoic chamber. The table was rotated 360 degrees to determine the position of the highest radiation.
- b. The EUT was set 3 meters away from the interference-receiving antenna, which was mounted on the top of a variable-height antenna tower.
- c. The antenna is a broadband antenna, and its height is varied from one meter to four meters above the ground to determine the maximum value of the field strength. Both horizontal and vertical polarizations of the antenna are set to make the measurement.
- d. For each suspected emission, the EUT was arranged to its worst case and then the antenna was tuned to heights from 1 meter to 4 meters and the rotatable table was turned from 0 degrees to 360 degrees to find the maximum reading.
- e. The test-receiver system was set to Peak Detect Function and Specified Bandwidth with Maximum Hold Mode.
- f. If the emission level of the EUT in peak mode was lower than the limit specified, then testing could be stopped and the peak values of the EUT would be reported. Otherwise the emissions would be re-tested one by one using peak, quasi-peak or average method as specified and then reported in a data sheet.

**NOTE:**

1. The resolution bandwidth and video bandwidth of test receiver/spectrum analyzer is 120kHz for Quasi-peak detection at frequency below 1GHz.
2. The resolution bandwidth of test receiver/spectrum analyzer is 1MHz and video bandwidth is 3MHz for Peak detection at frequency above 1GHz.
3. The resolution bandwidth of test receiver/spectrum analyzer is 1MHz and the video bandwidth is 10Hz for Average detection (AV) at frequency above 1GHz.
4. All modes of operation were investigated and the worst-case emissions are reported.

### 5.1.4 DEVIATION FROM TEST STANDARD

No deviation.

### 5.1.5 TEST SETUP

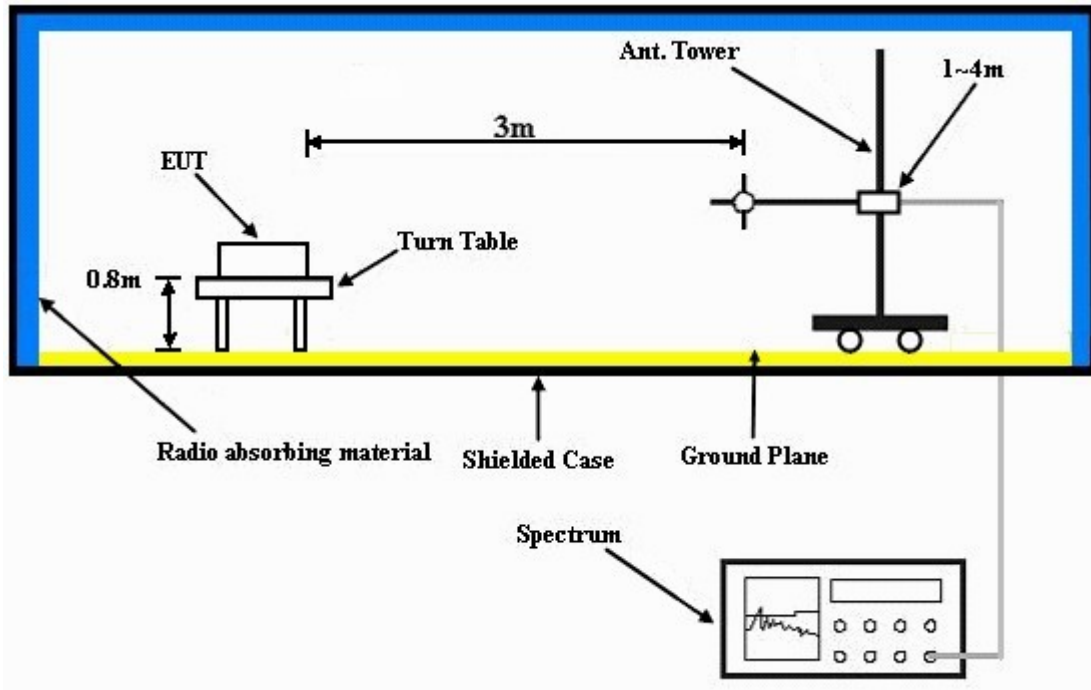

For the actual test configuration, please refer to the attached file (Test Setup Photo).

### 5.1.6 EUT OPERATING CONDITIONS

Same as 4.1.6.



A D T

## 5.1.7 TEST RESULTS

### 802.11a OFDM MODULATION

EUT TEST CONDITION		MEASUREMENT DETAIL	
CHANNEL	Channel 149	FREQUENCY RANGE	1 ~ 40GHz
INPUT POWER (SYSTEM)	120Vac, 60 Hz	DETECTOR FUNCTION	Peak (PK) Average (AV)
ENVIRONMENTAL CONDITIONS	24deg. C, 64%RH 1000hPa	TESTED BY	Match Tsui

ANTENNA POLARITY & TEST DISTANCE: HORIZONTAL AT 3 M								
NO.	FREQ. (MHz)	EMISSION LEVEL (dBuV/m)	LIMIT (dBuV/m)	MARGIN (dB)	ANTENNA HEIGHT (m)	TABLE ANGLE (Degree)	RAW VALUE (dBuV)	CORRECTION FACTOR (dB/m)
1	4596.00	51.59 PK	74.00	-22.41	1.17 H	24	12.96	38.63
2	4596.00	46.26 AV	54.00	-7.74	1.17 H	24	7.63	38.63
3	#5725.00	55.96 PK	85.46	-29.50	1.00 H	193	15.37	40.60
4	#5725.00	42.70 AV	75.06	-32.36	1.00 H	193	2.10	40.60
5	*5745.00	105.46 PK			1.00 H	193	64.79	40.67
6	*5745.00	95.06 AV			1.00 H	193	54.39	40.67
7	11490.00	60.38 PK	74.00	-13.62	1.23 H	347	8.44	51.94
8	11490.00	47.83 AV	54.00	-6.17	1.23 H	347	-4.11	51.94
ANTENNA POLARITY & TEST DISTANCE: VERTICAL AT 3 M								
NO.	FREQ. (MHz)	EMISSION LEVEL (dBuV/m)	LIMIT (dBuV/m)	MARGIN (dB)	ANTENNA HEIGHT (m)	TABLE ANGLE (Degree)	RAW VALUE (dBuV)	CORRECTION FACTOR (dB/m)
1	4596.00	50.80 PK	74.00	-23.20	1.39 V	343	12.17	38.63
2	4596.00	45.39 AV	54.00	-8.61	1.39 V	343	6.76	38.63
3	#5725.00	53.68 PK	84.90	-31.22	1.23 V	10	13.09	40.60
4	#5725.00	42.60 AV	74.62	-32.02	1.23 V	10	2.01	40.60
5	*5745.00	104.90 PK			1.21 V	8	64.23	40.67
6	*5745.00	94.62 AV			1.21 V	8	53.95	40.67
7	11490.00	66.73 PK	74.00	-7.27	1.42 V	207	14.79	51.94
8	11490.00	52.45 AV	54.00	-1.55	1.42 V	207	0.51	51.94

- REMARKS:**
1. Emission level (dBuV/m) = Raw Value (dBuV) + Correction Factor (dB/m).
  2. Correction Factor (dB/m) = Antenna Factor (dB/m) + Cable Factor (dB).
  3. The other emission levels were very low against the limit.
  4. Margin value = Emission level – Limit value.
  5. “ \* “: Fundamental frequency.
  6. The limit value is defined as per 15.247.
  7. "#":The radiated frequency is out the restricted band.



A D T

EUT TEST CONDITION		MEASUREMENT DETAIL	
CHANNEL	Channel 157	FREQUENCY RANGE	1 ~ 40GHz
INPUT POWER (SYSTEM)	120Vac, 60 Hz	DETECTOR FUNCTION	Peak (PK) Average (AV)
ENVIRONMENTAL CONDITIONS	24deg. C, 64%RH 1000hPa	TESTED BY	Match Tsui

ANTENNA POLARITY & TEST DISTANCE: HORIZONTAL AT 3 M								
NO.	FREQ. (MHz)	EMISSION LEVEL (dBuV/m)	LIMIT (dBuV/m)	MARGIN (dB)	ANTENNA HEIGHT (m)	TABLE ANGLE (Degree)	RAW VALUE (dBuV)	CORRECTION FACTOR (dB/m)
1	4628.00	52.04 PK	74.00	-21.96	1.14 H	24	13.32	38.73
2	4628.00	47.64 AV	54.00	-6.36	1.14 H	24	8.92	38.73
3	*5785.00	105.84 PK			1.30 H	202	65.02	40.82
4	*5785.00	95.29 AV			1.30 H	202	54.47	40.82
5	11570.00	60.66 PK	74.00	-13.34	1.24 H	105	8.80	51.86
6	11570.00	48.33 AV	54.00	-5.67	1.24 H	105	-3.53	51.86
ANTENNA POLARITY & TEST DISTANCE: VERTICAL AT 3 M								
NO.	FREQ. (MHz)	EMISSION LEVEL (dBuV/m)	LIMIT (dBuV/m)	MARGIN (dB)	ANTENNA HEIGHT (m)	TABLE ANGLE (Degree)	RAW VALUE (dBuV)	CORRECTION FACTOR (dB/m)
1	4628.00	50.52 PK	74.00	-23.48	1.20 V	168	11.80	38.73
2	4628.00	44.65 AV	54.00	-9.35	1.20 V	168	5.93	38.73
3	*5785.00	104.78 PK			1.30 V	8	63.96	40.82
4	*5785.00	94.30 AV			1.30 V	8	53.48	40.82
5	11570.00	68.16 PK	74.00	-5.84	1.31 V	208	16.30	51.86
6	11570.00	52.61 AV	54.00	-1.39	1.31 V	208	0.75	51.86

- REMARKS:**
1. Emission level (dBuV/m) = Raw Value (dBuV) + Correction Factor (dB/m).
  2. Correction Factor (dB/m) = Antenna Factor (dB/m) + Cable Factor (dB).
  3. The other emission levels were very low against the limit.
  4. Margin value = Emission level – Limit value.
  5. “ \* “: Fundamental frequency.
  6. The limit value is defined as per 15.247.



A D T

EUT TEST CONDITION		MEASUREMENT DETAIL	
CHANNEL	Channel 165	FREQUENCY RANGE	1 ~ 40GHz
INPUT POWER (SYSTEM)	120Vac, 60 Hz	DETECTOR FUNCTION	Peak (PK) Average (AV)
ENVIRONMENTAL CONDITIONS	24deg. C, 64%RH 1000hPa	TESTED BY	Match Tsui

ANTENNA POLARITY & TEST DISTANCE: HORIZONTAL AT 3 M								
NO.	FREQ. (MHz)	EMISSION LEVEL (dBuV/m)	LIMIT (dBuV/m)	MARGIN (dB)	ANTENNA HEIGHT (m)	TABLE ANGLE (Degree)	RAW VALUE (dBuV)	CORRECTION FACTOR (dB/m)
1	4660.00	53.36 PK	74.00	-20.64	1.06 H	200	14.53	38.83
2	4660.00	49.09 AV	54.00	-4.91	1.06 H	200	10.26	38.83
3	*5825.00	105.30 PK			1.00 H	187	64.41	40.89
4	*5825.00	96.00 AV			1.00 H	187	55.11	40.89
5	#5850.00	51.70 PK	85.30	-33.60	1.00 H	187	10.79	40.91
6	#5850.00	38.84 AV	76.00	-37.16	1.00 H	187	-2.07	40.91
7	11650.00	62.15 PK	74.00	-11.85	1.22 H	184	10.42	51.73
8	11650.00	48.40 AV	54.00	-5.60	1.22 H	184	-3.33	51.73
ANTENNA POLARITY & TEST DISTANCE: VERTICAL AT 3 M								
NO.	FREQ. (MHz)	EMISSION LEVEL (dBuV/m)	LIMIT (dBuV/m)	MARGIN (dB)	ANTENNA HEIGHT (m)	TABLE ANGLE (Degree)	RAW VALUE (dBuV)	CORRECTION FACTOR (dB/m)
1	4660.00	50.63 PK	74.00	-23.37	1.02 V	146	11.80	38.83
2	4660.00	44.56 AV	54.00	-9.44	1.02 V	146	5.73	38.83
3	*5825.00	104.81 PK			1.49 V	194	63.92	40.89
4	*5825.00	95.78 AV			1.49 V	194	54.89	40.89
5	#5850.00	48.52 PK	84.81	-36.29	1.48 V	194	7.61	40.91
6	#5850.00	37.85 AV	75.78	-37.93	1.48 V	194	-3.06	40.91
7	11650.00	66.67 PK	74.00	-7.33	1.24 V	203	14.94	51.73
8	11650.00	52.53 AV	54.00	-1.47	1.24 V	203	0.80	51.73

- REMARKS:**
1. Emission level (dBuV/m) = Raw Value (dBuV) + Correction Factor (dB/m).
  2. Correction Factor (dB/m) = Antenna Factor (dB/m) + Cable Factor (dB).
  3. The other emission levels were very low against the limit.
  4. Margin value = Emission level – Limit value.
  5. “ \* “: Fundamental frequency.
  6. The limit value is defined as per 15.247.
  7. "#":The radiated frequency is out the restricted band.



A D T

**DRAFT 802.11n (20MHz) OFDM MODULATION**

EUT TEST CONDITION		MEASUREMENT DETAIL	
CHANNEL	Channel 149	FREQUENCY RANGE	1 ~ 40GHz
INPUT POWER (SYSTEM)	120Vac, 60 Hz	DETECTOR FUNCTION	Peak (PK) Average (AV)
ENVIRONMENTAL CONDITIONS	24deg. C, 64%RH 1000hPa	TESTED BY	Match Tsui

ANTENNA POLARITY & TEST DISTANCE: HORIZONTAL AT 3 M								
NO.	FREQ. (MHz)	EMISSION LEVEL (dBuV/m)	LIMIT (dBuV/m)	MARGIN (dB)	ANTENNA HEIGHT (m)	TABLE ANGLE (Degree)	RAW VALUE (dBuV)	CORRECTION FACTOR (dB/m)
1	4596.00	49.49 PK	74.00	-24.51	1.19 H	51	10.86	38.63
2	4596.00	42.68 AV	54.00	-11.32	1.19 H	51	4.05	38.63
3	#5725.00	60.45 PK	84.32	-23.87	1.39 H	73	19.85	40.60
4	#5725.00	42.42 AV	74.00	-31.58	1.39 H	73	1.83	40.60
5	*5745.00	104.32 PK			1.39 H	73	63.65	40.67
6	*5745.00	94.00 AV			1.39 H	73	53.33	40.67
7	11490.00	61.79 PK	74.00	-12.21	1.41 H	28	9.85	51.94
8	11490.00	48.02 AV	54.00	-5.98	1.41 H	28	-3.92	51.94
ANTENNA POLARITY & TEST DISTANCE: VERTICAL AT 3 M								
NO.	FREQ. (MHz)	EMISSION LEVEL (dBuV/m)	LIMIT (dBuV/m)	MARGIN (dB)	ANTENNA HEIGHT (m)	TABLE ANGLE (Degree)	RAW VALUE (dBuV)	CORRECTION FACTOR (dB/m)
1	4596.00	50.05 PK	74.00	-23.95	1.02 V	360	11.42	38.63
2	4596.00	44.50 AV	54.00	-9.50	1.02 V	360	5.87	38.63
3	#5725.00	58.36 PK	83.98	-25.62	1.04 V	194	17.77	40.60
4	#5725.00	42.39 AV	73.64	-31.25	1.04 V	194	1.80	40.60
5	*5745.00	103.98 PK			1.04 V	194	63.31	40.67
6	*5745.00	93.64 AV			1.04 V	194	52.97	40.67
7	11490.00	66.38 PK	74.00	-7.62	1.28 V	21	14.44	51.94
8	11490.00	51.56 AV	54.00	-2.44	1.28 V	21	-0.38	51.94

- REMARKS:**
1. Emission level (dBuV/m) = Raw Value (dBuV) + Correction Factor (dB/m).
  2. Correction Factor (dB/m) = Antenna Factor (dB/m) + Cable Factor (dB).
  3. The other emission levels were very low against the limit.
  4. Margin value = Emission level – Limit value.
  5. “ \* “: Fundamental frequency.
  6. The limit value is defined as per 15.247.
  7. "#":The radiated frequency is out the restricted band.





A D T

EUT TEST CONDITION		MEASUREMENT DETAIL	
CHANNEL	Channel 157	FREQUENCY RANGE	1 ~ 40GHz
INPUT POWER (SYSTEM)	120Vac, 60 Hz	DETECTOR FUNCTION	Peak (PK) Average (AV)
ENVIRONMENTAL CONDITIONS	24deg. C, 64%RH 1000hPa	TESTED BY	Match Tsui

ANTENNA POLARITY & TEST DISTANCE: HORIZONTAL AT 3 M								
NO.	FREQ. (MHz)	EMISSION LEVEL (dBuV/m)	LIMIT (dBuV/m)	MARGIN (dB)	ANTENNA HEIGHT (m)	TABLE ANGLE (Degree)	RAW VALUE (dBuV)	CORRECTION FACTOR (dB/m)
1	4628.00	48.64 PK	74.00	-25.36	1.01 H	10	9.91	38.73
2	4628.00	42.25 AV	54.00	-11.75	1.01 H	10	3.52	38.73
3	*5785.00	103.31 PK			1.38 H	71	62.49	40.82
4	*5785.00	93.01 AV			1.38 H	71	52.19	40.82
5	11570.00	61.67 PK	74.00	-12.33	1.39 H	30	9.81	51.86
6	11570.00	47.85 AV	54.00	-6.15	1.39 H	30	-4.01	51.86
ANTENNA POLARITY & TEST DISTANCE: VERTICAL AT 3 M								
NO.	FREQ. (MHz)	EMISSION LEVEL (dBuV/m)	LIMIT (dBuV/m)	MARGIN (dB)	ANTENNA HEIGHT (m)	TABLE ANGLE (Degree)	RAW VALUE (dBuV)	CORRECTION FACTOR (dB/m)
1	4628.00	49.57 PK	74.00	-24.43	1.00 V	11	10.85	38.73
2	4628.00	43.99 AV	54.00	-10.01	1.00 V	11	5.27	38.73
3	*5785.00	103.01 PK			1.41 V	15	62.19	40.82
4	*5785.00	92.84 AV			1.41 V	15	52.02	40.82
5	11570.00	66.01 PK	74.00	-7.99	1.13 V	360	14.15	51.86
6	11570.00	51.63 AV	54.00	-2.37	1.13 V	360	-0.23	51.86

- REMARKS:**
1. Emission level (dBuV/m) = Raw Value (dBuV) + Correction Factor (dB/m).
  2. Correction Factor (dB/m) = Antenna Factor (dB/m) + Cable Factor (dB).
  3. The other emission levels were very low against the limit.
  4. Margin value = Emission level – Limit value.
  5. “ \* “: Fundamental frequency.
  6. The limit value is defined as per 15.247.



A D T

EUT TEST CONDITION		MEASUREMENT DETAIL	
CHANNEL	Channel 165	FREQUENCY RANGE	1 ~ 40GHz
INPUT POWER (SYSTEM)	120Vac, 60 Hz	DETECTOR FUNCTION	Peak (PK) Average (AV)
ENVIRONMENTAL CONDITIONS	24deg. C, 64%RH 1000hPa	TESTED BY	Match Tsui

ANTENNA POLARITY & TEST DISTANCE: HORIZONTAL AT 3 M								
NO.	FREQ. (MHz)	EMISSION LEVEL (dBuV/m)	LIMIT (dBuV/m)	MARGIN (dB)	ANTENNA HEIGHT (m)	TABLE ANGLE (Degree)	RAW VALUE (dBuV)	CORRECTION FACTOR (dB/m)
1	4660.00	49.21 PK	74.00	-24.79	1.20 H	60	10.38	38.83
2	4660.00	42.42 AV	54.00	-11.58	1.20 H	60	3.59	38.83
3	*5825.00	105.04 PK			1.31 H	88	64.15	40.89
4	*5825.00	94.68 AV			1.31 H	88	53.79	40.89
5	#5850.00	55.10 PK	85.04	-29.94	1.31 H	88	14.19	40.91
6	#5850.00	39.07 AV	74.68	-35.61	1.31 H	88	-1.84	40.91
7	11650.00	61.47 PK	74.00	-12.53	1.39 H	35	9.74	51.73
8	11650.00	47.96 AV	54.00	-6.04	1.39 H	35	-3.77	51.73
ANTENNA POLARITY & TEST DISTANCE: VERTICAL AT 3 M								
NO.	FREQ. (MHz)	EMISSION LEVEL (dBuV/m)	LIMIT (dBuV/m)	MARGIN (dB)	ANTENNA HEIGHT (m)	TABLE ANGLE (Degree)	RAW VALUE (dBuV)	CORRECTION FACTOR (dB/m)
1	4660.00	51.54 PK	74.00	-22.46	1.00 V	4	12.71	38.83
2	4660.00	45.31 AV	54.00	-8.69	1.00 V	4	6.48	38.83
3	*5825.00	104.58 PK			1.31 V	190	63.69	40.89
4	*5825.00	94.05 AV			1.31 V	190	53.16	40.89
5	#5850.00	54.46 PK	84.58	-30.12	1.31 V	190	13.55	40.91
6	#5850.00	38.93 AV	74.05	-35.12	1.31 V	190	-1.98	40.91
7	11650.00	68.60 PK	74.00	-5.40	1.23 V	360	16.87	51.73
8	11650.00	52.37 AV	54.00	-1.63	1.23 V	360	0.64	51.73

- REMARKS:**
1. Emission level (dBuV/m) = Raw Value (dBuV) + Correction Factor (dB/m).
  2. Correction Factor (dB/m) = Antenna Factor (dB/m) + Cable Factor (dB).
  3. The other emission levels were very low against the limit.
  4. Margin value = Emission level – Limit value.
  5. “ \* “: Fundamental frequency.
  6. The limit value is defined as per 15.247.
  7. “#”:The radiated frequency is out the restricted band.



A D T

**DRAFT 802.11n (40MHz) OFDM MODULATION**

EUT TEST CONDITION		MEASUREMENT DETAIL	
CHANNEL	Channel 151	FREQUENCY RANGE	1 ~ 40GHz
INPUT POWER (SYSTEM)	120Vac, 60 Hz	DETECTOR FUNCTION	Peak (PK) Average (AV)
ENVIRONMENTAL CONDITIONS	24deg. C, 64%RH 1000hPa	TESTED BY	Match Tsui

ANTENNA POLARITY & TEST DISTANCE: HORIZONTAL AT 3 M								
NO.	FREQ. (MHz)	EMISSION LEVEL (dBuV/m)	LIMIT (dBuV/m)	MARGIN (dB)	ANTENNA HEIGHT (m)	TABLE ANGLE (Degree)	RAW VALUE (dBuV)	CORRECTION FACTOR (dB/m)
1	4604.00	49.58 PK	74.00	-24.42	1.19 H	50	10.93	38.65
2	4604.00	42.62 AV	54.00	-11.38	1.19 H	50	3.97	38.65
3	#5725.00	58.67 PK	82.26	-23.59	1.00 H	202	18.07	40.60
4	#5725.00	44.26 AV	71.29	-27.03	1.00 H	202	3.66	40.60
5	*5755.00	102.26 PK			1.00 H	202	61.55	40.71
6	*5755.00	91.29 AV			1.00 H	202	50.58	40.71
7	11510.00	60.64 PK	74.00	-13.36	1.00 H	360	8.70	51.94
8	11510.00	47.53 AV	54.00	-6.47	1.00 H	360	-4.41	51.94
ANTENNA POLARITY & TEST DISTANCE: VERTICAL AT 3 M								
NO.	FREQ. (MHz)	EMISSION LEVEL (dBuV/m)	LIMIT (dBuV/m)	MARGIN (dB)	ANTENNA HEIGHT (m)	TABLE ANGLE (Degree)	RAW VALUE (dBuV)	CORRECTION FACTOR (dB/m)
1	4604.00	48.00 PK	74.00	-26.00	1.16 V	320	9.35	38.65
2	4604.00	41.31 AV	54.00	-12.69	1.16 V	320	2.66	38.65
3	#5725.00	57.53 PK	81.15	-23.62	1.18 V	194	16.94	40.60
4	#5725.00	43.56 AV	70.83	-27.27	1.18 V	194	2.96	40.60
5	*5755.00	101.15 PK			1.18 V	194	60.44	40.71
6	*5755.00	90.83 AV			1.18 V	194	50.12	40.71
7	11510.00	66.49 PK	74.00	-7.51	1.20 V	31	14.55	51.94
8	11510.00	52.69 AV	54.00	-1.31	1.20 V	31	0.75	51.94

- REMARKS:**
1. Emission level (dBuV/m) = Raw Value (dBuV) + Correction Factor (dB/m).
  2. Correction Factor (dB/m) = Antenna Factor (dB/m) + Cable Factor (dB).
  3. The other emission levels were very low against the limit.
  4. Margin value = Emission level – Limit value.
  5. “ \* “: Fundamental frequency.
  6. The limit value is defined as per 15.247.
  7. "#":The radiated frequency is out the restricted band.



A D T

EUT TEST CONDITION		MEASUREMENT DETAIL	
CHANNEL	Channel 159	FREQUENCY RANGE	1 ~ 40GHz
INPUT POWER (SYSTEM)	120Vac, 60 Hz	DETECTOR FUNCTION	Peak (PK) Average (AV)
ENVIRONMENTAL CONDITIONS	24deg. C, 64%RH 1000hPa	TESTED BY	Match Tsui

ANTENNA POLARITY & TEST DISTANCE: HORIZONTAL AT 3 M								
NO.	FREQ. (MHz)	EMISSION LEVEL (dBuV/m)	LIMIT (dBuV/m)	MARGIN (dB)	ANTENNA HEIGHT (m)	TABLE ANGLE (Degree)	RAW VALUE (dBuV)	CORRECTION FACTOR (dB/m)
1	4363.00	48.62 PK	74.00	-25.38	1.20 H	63	10.61	38.01
2	4363.00	41.25 AV	54.00	-12.75	1.20 H	63	3.24	38.01
3	*5795.00	102.86 PK			1.00 H	198	62.01	40.85
4	*5795.00	91.53 AV			1.00 H	198	50.68	40.85
5	#5850.00	47.41 PK	82.86	-35.45	1.00 H	198	6.50	40.91
6	#5850.00	36.05 AV	71.53	-35.48	1.00 H	198	-4.86	40.91
7	11590.00	59.37 PK	74.00	-14.63	1.00 H	180	7.54	51.83
8	11590.00	46.95 AV	54.00	-7.05	1.00 H	180	-4.88	51.83
ANTENNA POLARITY & TEST DISTANCE: VERTICAL AT 3 M								
NO.	FREQ. (MHz)	EMISSION LEVEL (dBuV/m)	LIMIT (dBuV/m)	MARGIN (dB)	ANTENNA HEIGHT (m)	TABLE ANGLE (Degree)	RAW VALUE (dBuV)	CORRECTION FACTOR (dB/m)
1	4636.00	49.30 PK	74.00	-24.70	1.00 V	13	10.55	38.75
2	4636.00	42.54 AV	54.00	-11.46	1.00 V	13	3.79	38.75
3	*5795.00	101.75 PK			1.44 V	360	60.90	40.85
4	*5795.00	91.34 AV			1.44 V	360	50.49	40.85
5	#5850.00	46.93 PK	81.75	-34.82	1.44 V	360	6.02	40.91
6	#5850.00	35.84 AV	71.34	-35.50	1.44 V	360	-5.07	40.91
7	11590.00	64.16 PK	74.00	-9.84	1.38 V	0	12.33	51.83
8	11590.00	51.53 AV	54.00	-2.47	1.38 V	0	-0.30	51.83

- REMARKS:**
1. Emission level (dBuV/m) = Raw Value (dBuV) + Correction Factor (dB/m).
  2. Correction Factor (dB/m) = Antenna Factor (dB/m) + Cable Factor (dB).
  3. The other emission levels were very low against the limit.
  4. Margin value = Emission level – Limit value.
  5. “ \* “: Fundamental frequency.
  6. The limit value is defined as per 15.247.
  7. "#":The radiated frequency is out the restricted band.



A D T

**BELOW 1GHz WORST-CASE DATA : DRAFT 802.11n (40MHz) OFDM MODULATION**

EUT TEST CONDITION		MEASUREMENT DETAIL	
CHANNEL	Channel 159	FREQUENCY RANGE	Below 1000MHz
INPUT POWER (SYSTEM)	120Vac, 60 Hz	DETECTOR FUNCTION	Quasi-Peak
ENVIRONMENTAL CONDITIONS	20deg. C, 70%RH 999hPa	TESTED BY	Lori Chiu

ANTENNA POLARITY & TEST DISTANCE: HORIZONTAL AT 3 M								
NO.	FREQ. (MHz)	EMISSION LEVEL (dBuV/m)	LIMIT (dBuV/m)	MARGIN (dB)	ANTENNA HEIGHT (m)	TABLE ANGLE (Degree)	RAW VALUE (dBuV)	CORRECTION FACTOR (dB/m)
1	360.43	32.23 QP	46.00	-13.77	1.00 H	25	17.13	15.10
2	479.03	34.43 QP	46.00	-11.57	2.00 H	274	15.83	18.60
3	599.58	38.05 QP	46.00	-7.95	1.50 H	352	16.15	21.90
4	720.12	39.14 QP	46.00	-6.86	1.25 H	43	15.92	23.22
5	799.84	34.57 QP	46.00	-11.43	1.00 H	256	9.25	25.32
6	840.67	37.96 QP	46.00	-8.04	1.00 H	19	12.39	25.57
ANTENNA POLARITY & TEST DISTANCE: VERTICAL AT 3 M								
NO.	FREQ. (MHz)	EMISSION LEVEL (dBuV/m)	LIMIT (dBuV/m)	MARGIN (dB)	ANTENNA HEIGHT (m)	TABLE ANGLE (Degree)	RAW VALUE (dBuV)	CORRECTION FACTOR (dB/m)
1	33.79	30.34 QP	40.00	-9.66	1.25 V	10	18.18	12.16
2	144.61	29.58 QP	43.50	-13.92	1.00 V	292	16.42	13.16
3	599.58	33.35 QP	46.00	-12.65	1.25 V	307	11.45	21.90
4	720.12	31.46 QP	46.00	-14.54	2.00 V	289	8.24	23.22
5	840.67	32.76 QP	46.00	-13.24	2.00 V	289	7.18	25.57
6	951.49	33.85 QP	46.00	-12.15	1.00 V	271	7.35	26.50

- REMARKS:**
1. Emission level (dBuV/m) = Raw Value (dBuV) + Correction Factor (dB/m).
  2. Correction Factor (dB/m) = Antenna Factor (dB/m) + Cable Factor (dB).
  3. The other emission levels were very low against the limit.
  4. Margin value = Emission level – Limit value.



## 5.2 CONDUCTED EMISSION MEASUREMENT

### 5.2.1 LIMITS OF CONDUCTED EMISSION MEASUREMENT

FREQUENCY OF EMISSION (MHz)	CONDUCTED LIMIT (dBµV)	
	Quasi-peak	Average
0.15 ~ 0.5	66 to 56	56 to 46
0.5 ~ 5	56	46
5 ~ 30	60	50

- NOTE:** 1. The lower limit shall apply at the transition frequencies.  
2. The limit decreases in line with the logarithm of the frequency in the range of 0.15 to 0.50MHz.  
3. All emanations from a class A/B digital device or system, including any network of conductors and apparatus connected thereto, shall not exceed the level of field strengths specified above.

### 5.2.2 TEST INSTRUMENTS

DESCRIPTION & MANUFACTURER	MODEL NO.	SERIAL NO.	DATE OF CALIBRATION	DUE DATE OF CALIBRATION
Test Receiver ROHDE & SCHWARZ	ESCS30	100291	Nov. 19, 2008	Nov. 18, 2009
RF signal cable Woken	5D-FB	Cable-HYC01-01	Dec. 31, 2008	Dec. 30, 2009
LISN ROHDE & SCHWARZ	ESH3-Z5	100312	Jun. 13, 2008	Jun. 12, 2009
LISN ROHDE & SCHWARZ	ESH2-Z5	100104	Dec. 04, 2008	Dec. 03, 2009
Software ADT	ADT_Cond_ V7.3.6	NA	NA	NA

- NOTE:** 1. The calibration interval of the above test instruments is 12 months and the calibrations are traceable to NML/ROC and NIST/USA.  
2. The test was performed in HwaYa Shielded Room 1.  
3. The VCCI Site Registration No. is C-2040.



A D T

### 5.2.3 TEST PROCEDURES

- a. The EUT was placed 0.4 meters from the conducting wall of the shielded room with EUT being connected to the power mains through a line impedance stabilization network (LISN). Other support units were connected to the power mains through another LISN. The two LISNs provide 50 ohm/ 50uH of coupling impedance for the measuring instrument.
- b. Both lines of the power mains connected to the EUT were checked for maximum conducted interference.
- c. The frequency range from 150kHz to 30MHz was searched. Emission levels under (Limit - 20dB) was not recorded.

### 5.2.4 DEVIATION FROM TEST STANDARD

No deviation.

### 5.2.5 TEST SETUP

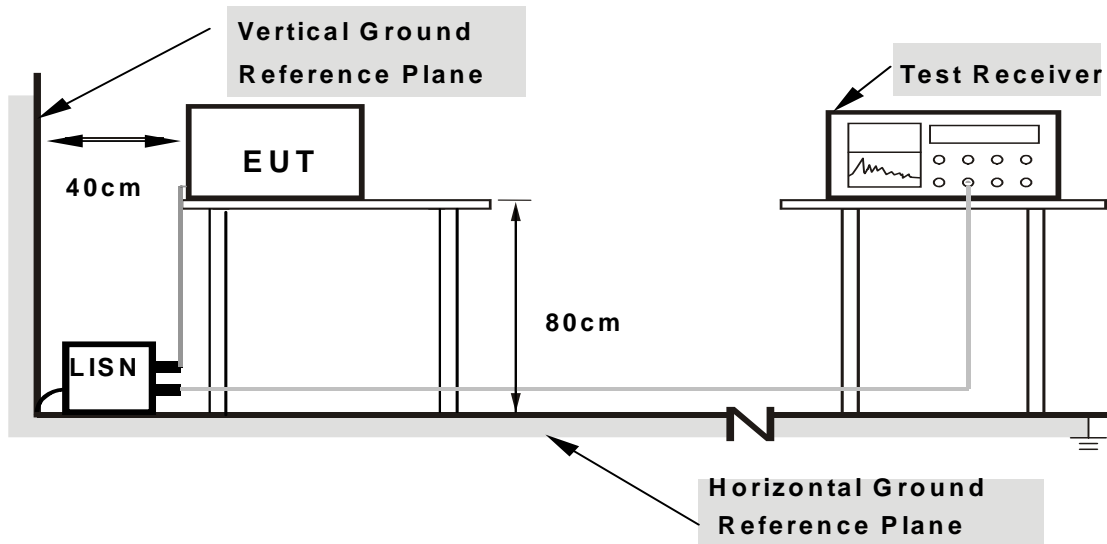

**Note: 1.Support units were connected to second LISN.**

**2.Both of LISNs (AMN) are 80 cm from EUT and at least 80 from other units and other metal planes**

For the actual test configuration, please refer to the attached file (Test Setup Photo).

### 5.2.6 EUT OPERATING CONDITIONS

Same as 4.1.6



### 5.2.7 TEST RESULTS

#### CONDUCTED WORST-CASE DATA : DRAFT 802.11n (40MHz) OFDM MODULATION

EUT TEST CONDITION		MEASUREMENT DETAIL	
CHANNEL	Channel 159	PHASE	Line 1
MODULATION TYPE	BPSK	INPUT POWER	120Vac, 60Hz
TRANSFER RATE	15.0Mbps	6dB BANDWIDTH	9kHz
ENVIRONMENTAL CONDITIONS	22deg. C, 65%RH, 1021hPa	TESTED BY	Antony Lee

No	Freq. [MHz]	Corr. Factor (dB)	Reading Value [dB (uV)]		Emission Level [dB (uV)]		Limit [dB (uV)]		Margin (dB)	
			Q.P.	AV.	Q.P.	AV.	Q.P.	AV.	Q.P.	AV.
			1	0.173	0.13	49.86	-	49.99	-	64.79
2	0.228	0.13	41.89	-	42.02	-	62.52	52.52	-20.50	-
3	0.404	0.14	34.77	-	34.91	-	57.77	47.77	-22.86	-
4	1.957	0.23	35.92	-	36.15	-	56.00	46.00	-19.85	-
5	3.685	0.37	38.92	-	39.29	-	56.00	46.00	-16.71	-
6	18.766	1.10	31.87	-	32.97	-	60.00	50.00	-27.03	-

- REMARKS:**
1. Q.P. and AV. are abbreviations of quasi-peak and average individually.
  2. "-": The Quasi-peak reading value also meets average limit and measurement with the average detector is unnecessary.
  3. The emission levels of other frequencies were very low against the limit.
  4. Margin value = Emission level - Limit value
  5. Correction factor = Insertion loss + Cable loss
  6. Emission Level = Correction Factor + Reading Value.

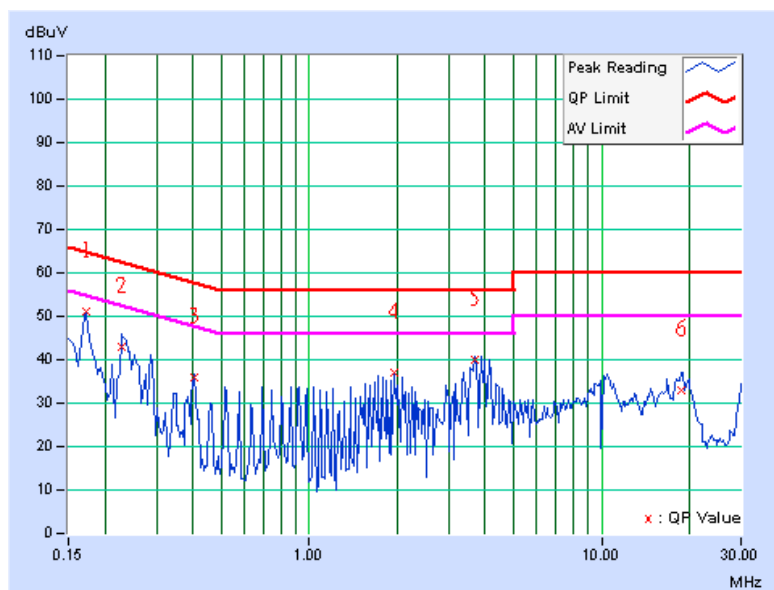

EUT TEST CONDITION		MEASUREMENT DETAIL	
CHANNEL	Channel 159	PHASE	Line 2
MODULATION TYPE	BPSK	INPUT POWER	120Vac, 60Hz
TRANSFER RATE	15.0Mbps	6dB BANDWIDTH	9kHz
ENVIRONMENTAL CONDITIONS	22deg. C, 65%RH, 1021hPa	TESTED BY	Antony Lee

No	Freq. [MHz]	Corr. Factor (dB)	Reading Value		Emission Level		Limit		Margin	
			[dB (uV)]		[dB (uV)]		[dB (uV)]		(dB)	
			Q.P.	AV.	Q.P.	AV.	Q.P.	AV.	Q.P.	AV.
1	0.173	0.14	49.80	-	49.94	-	64.84	54.84	-14.89	-
2	0.232	0.15	42.86	-	43.01	-	62.38	52.38	-19.37	-
3	0.287	0.15	38.87	-	39.02	-	60.62	50.62	-21.59	-
4	1.898	0.24	35.92	-	36.16	-	56.00	46.00	-19.84	-
5	3.914	0.41	38.52	-	38.93	-	56.00	46.00	-17.07	-
6	10.359	0.63	33.30	-	33.93	-	60.00	50.00	-26.07	-

- REMARKS:**
1. Q.P. and AV. are abbreviations of quasi-peak and average individually.
  2. "-": The Quasi-peak reading value also meets average limit and measurement with the average detector is unnecessary.
  3. The emission levels of other frequencies were very low against the limit.
  4. Margin value = Emission level - Limit value
  5. Correction factor = Insertion loss + Cable loss
  6. Emission Level = Correction Factor + Reading Value.

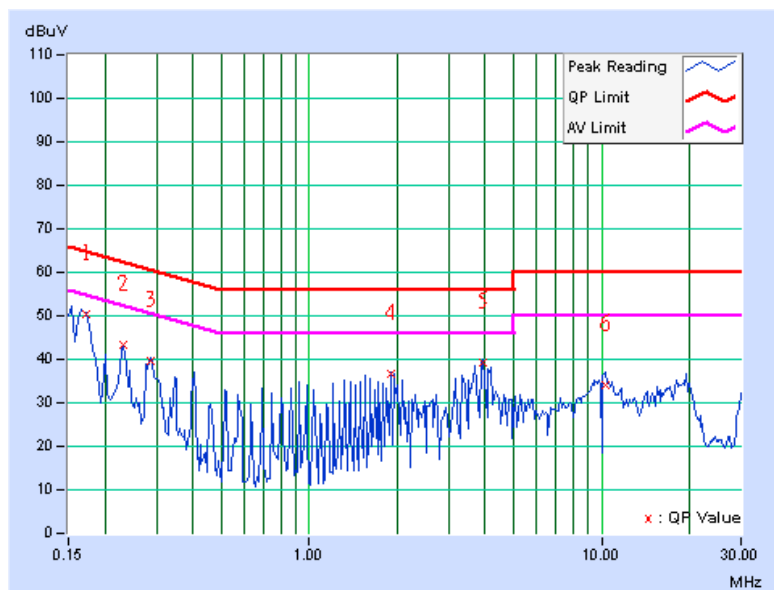



### 5.3 6dB BANDWIDTH MEASUREMENT

#### 5.3.1 LIMITS OF 6dB BANDWIDTH MEASUREMENT

The minimum of 6dB Bandwidth Measurement is 0.5MHz.

#### 5.3.2 TEST INSTRUMENTS

DESCRIPTION & MANUFACTURER	MODEL NO.	SERIAL NO.	DATE OF CALIBRATION	CALIBRATED UNTIL
R&S SPECTRUM ANALYZER	FSP40	100041	Apr. 22, 2008	Apr. 21, 2009

**NOTE:** The calibration interval of the above test instruments is 12 months and the calibrations are traceable to NML/ROC and NIST/USA.

#### 5.3.3 TEST PROCEDURE

The transmitter output was connected to the spectrum analyzer through an attenuator. The bandwidth of the fundamental frequency was measured by spectrum analyzer with 100kHz RBW and 300kHz VBW. The 6dB bandwidth is defined as the total spectrum the power of which is higher than peak power minus 6dB.

### 5.3.4 DEVIATION FROM TEST STANDARD

No deviation

### 5.3.5 TEST SETUP

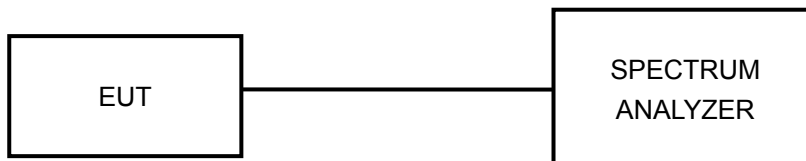

### 5.3.6 EUT OPERATING CONDITIONS

The software provided by client to enable the EUT under transmission condition continuously at lowest, middle and highest channel frequencies individually.



A D T

### 5.3.7 TEST RESULTS

#### 802.11a OFDM MODULATION

<b>MODULATION TYPE</b>	BPSK	<b>TRANSFER RATE</b>	6.0Mbps
<b>INPUT POWER</b>	120Vac, 60Hz	<b>ENVIRONMENTAL CONDITIONS</b>	24 deg.C, 64%RH, 1021hPa
<b>TESTED BY</b>	Match Tsui		

CHANNEL	CHANNEL FREQUENCY (MHz)	6dB BANDWIDTH (MHz)		MINIMUM LIMIT (MHz)	PASS / FAIL
		CHAIN 0	CHAIN 1		
149	5745	16.64	16.65	0.5	PASS
157	5785	16.64	16.66	0.5	PASS
165	5825	16.60	16.61	0.5	PASS



A D T

### FOR CHAIN 0: CH 149

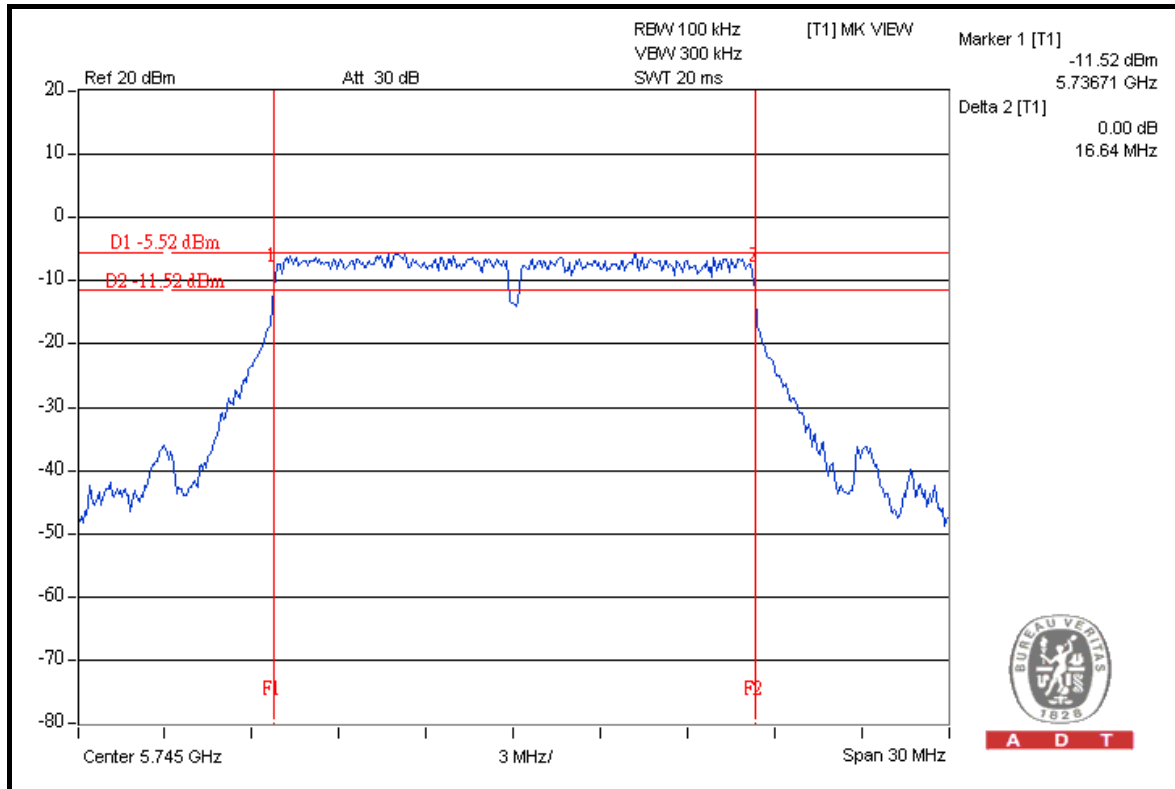

### CH 157

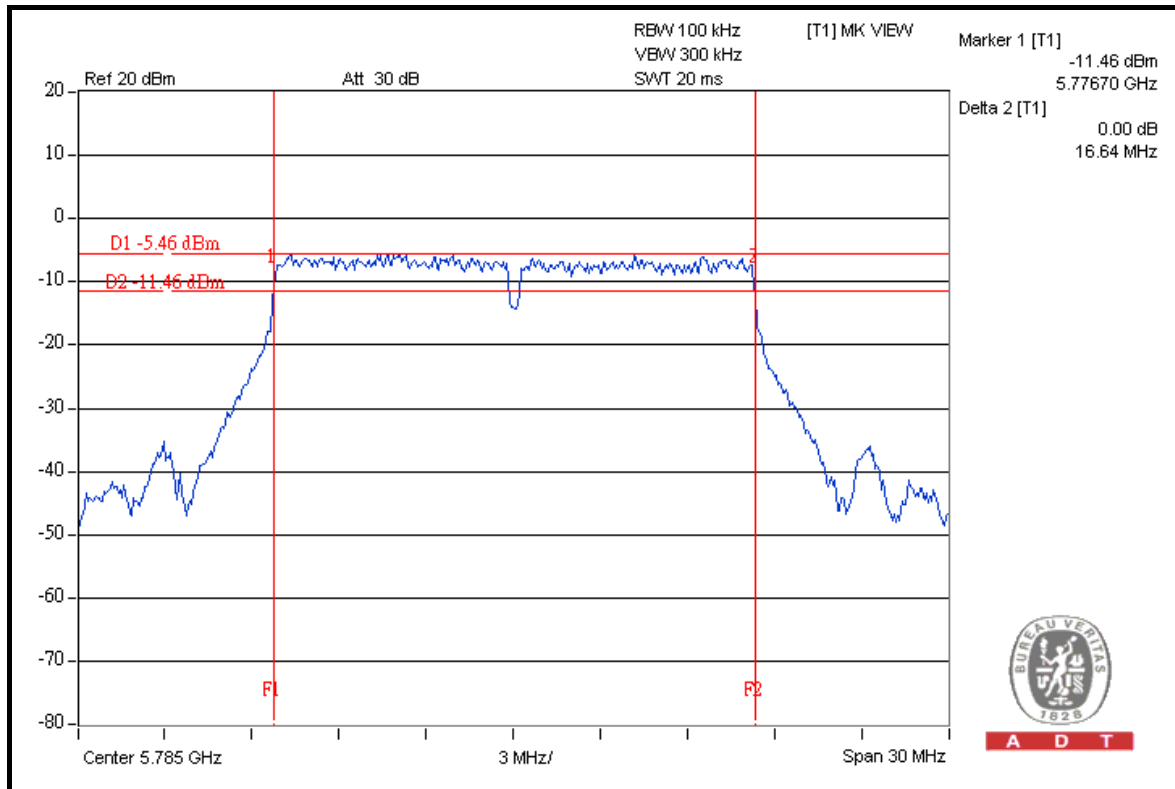



A D T

### CH 165

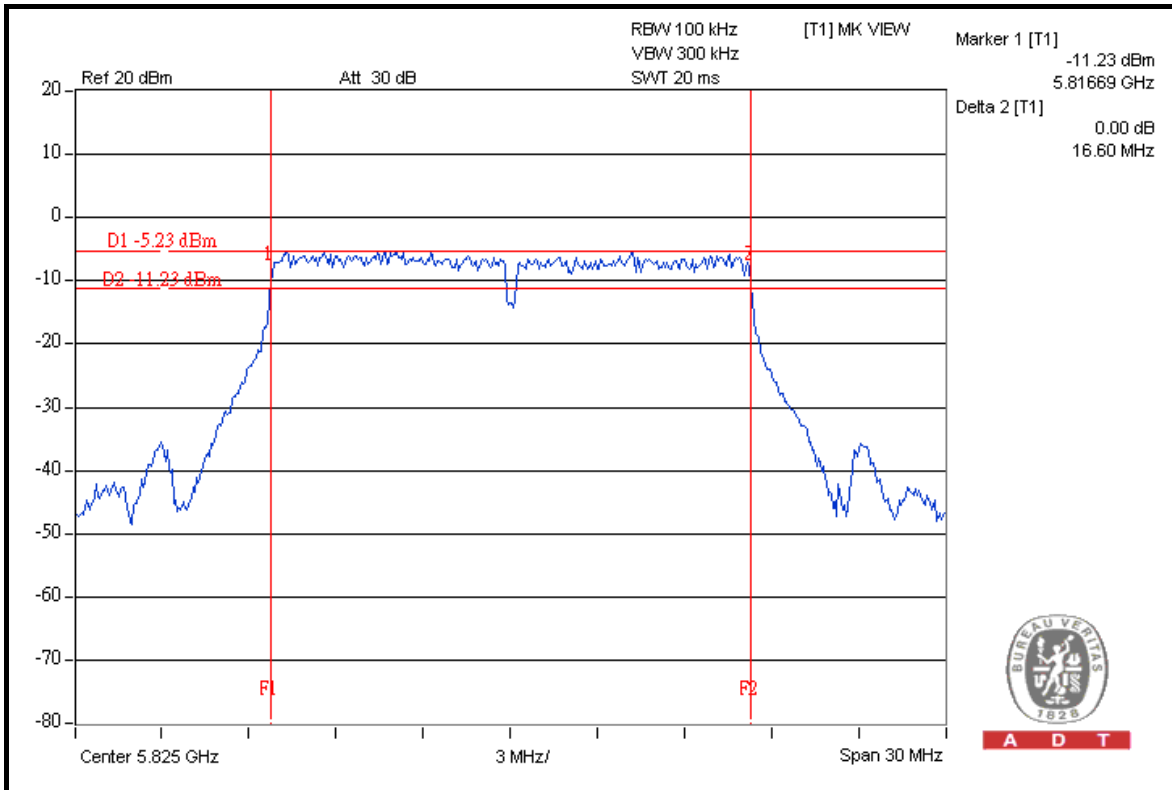

A D T

### FOR CHAIN 1: CH 149

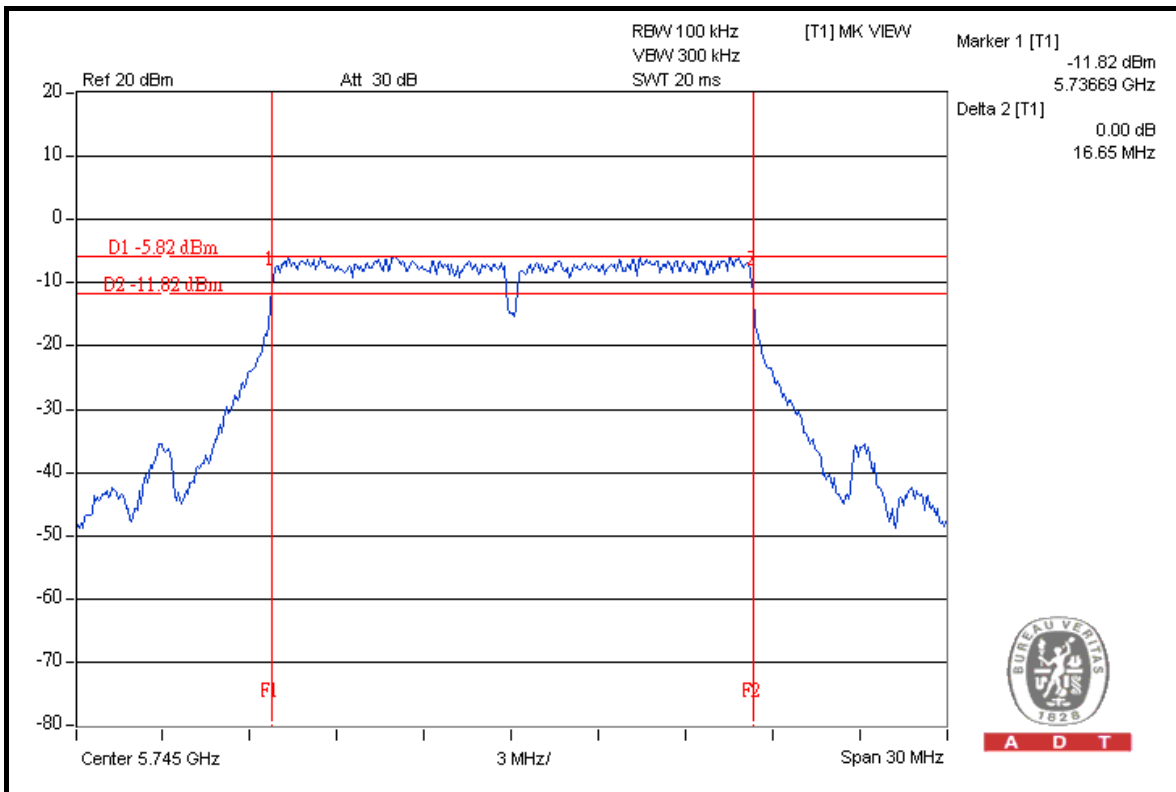

A D T



A D T

### CH 157

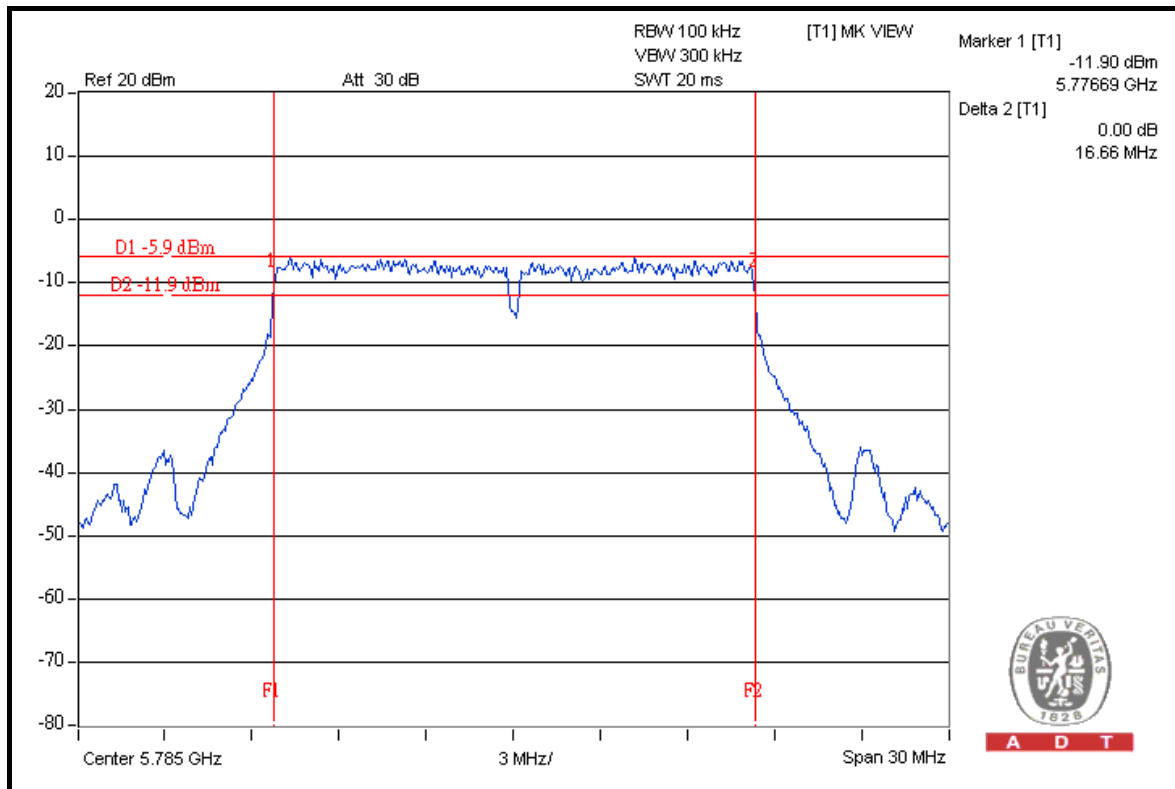

### CH 165

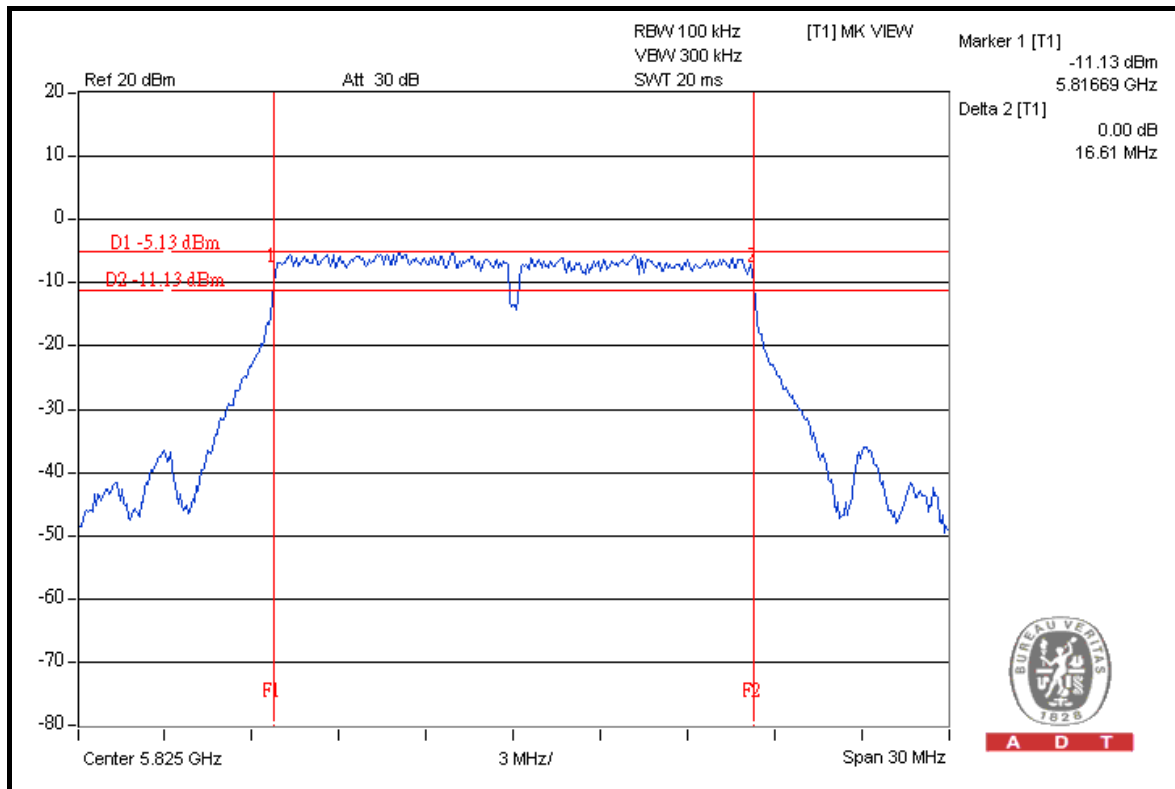





A D T

### DRAFT 802.11n (20MHz) OFDM MODULATION

<b>MODULATION TYPE</b>	BPSK	<b>TRANSFER RATE</b>	7.2Mbps
<b>INPUT POWER</b>	120Vac, 60Hz	<b>ENVIRONMENTAL CONDITIONS</b>	24 deg.C, 64%RH, 1021hPa
<b>TESTED BY</b>	Match Tsui		

CHANNEL	CHANNEL FREQUENCY (MHz)	6dB BANDWIDTH (MHz)		MINIMUM LIMIT (MHz)	PASS / FAIL
		CHAIN 0	CHAIN 1		
149	5745	17.73	17.79	0.5	PASS
157	5785	17.73	17.77	0.5	PASS
165	5825	17.71	17.69	0.5	PASS



A D T

### FOR CHAIN 0: CH 149

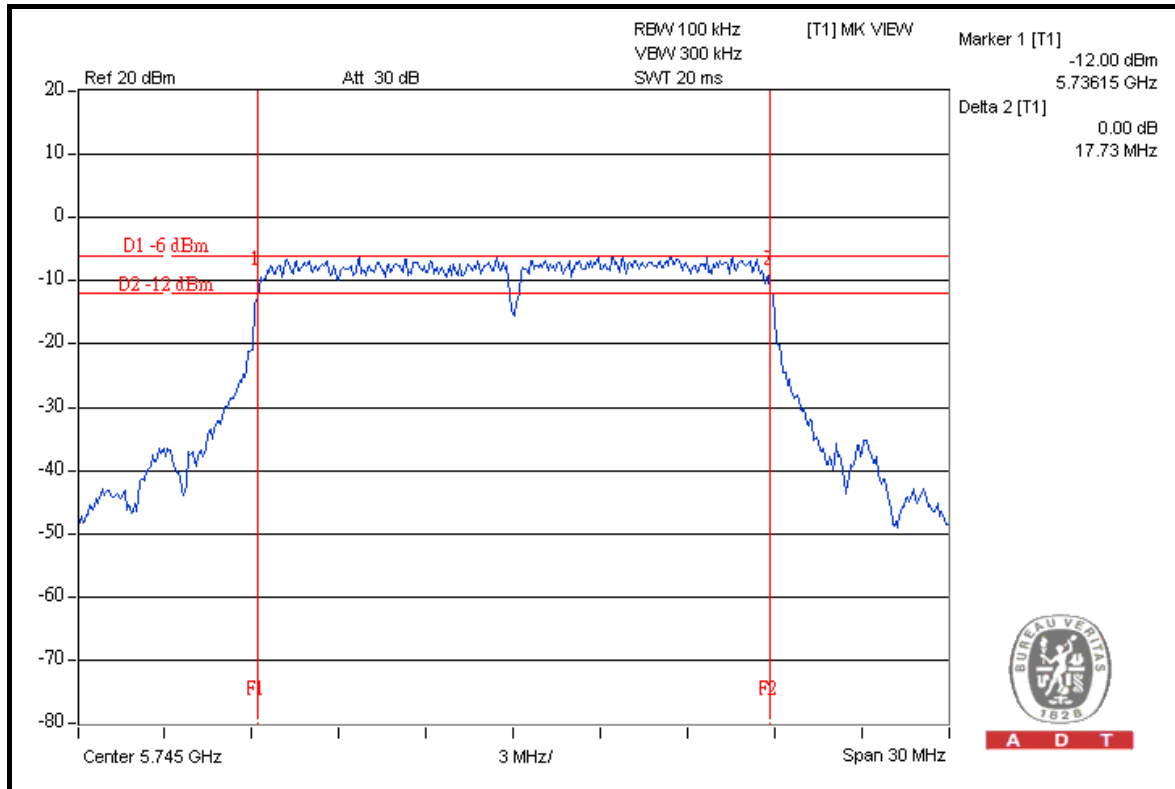

A D T

### CH 157

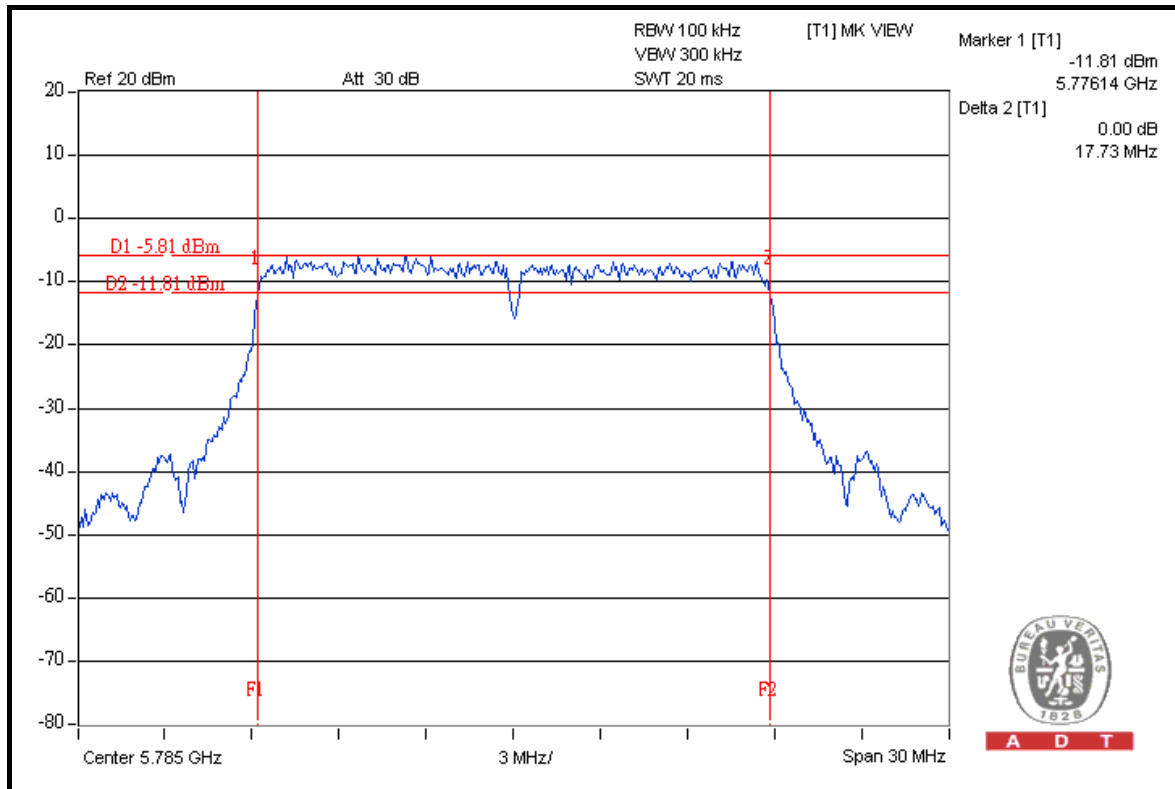

A D T



A D T

### CH 165

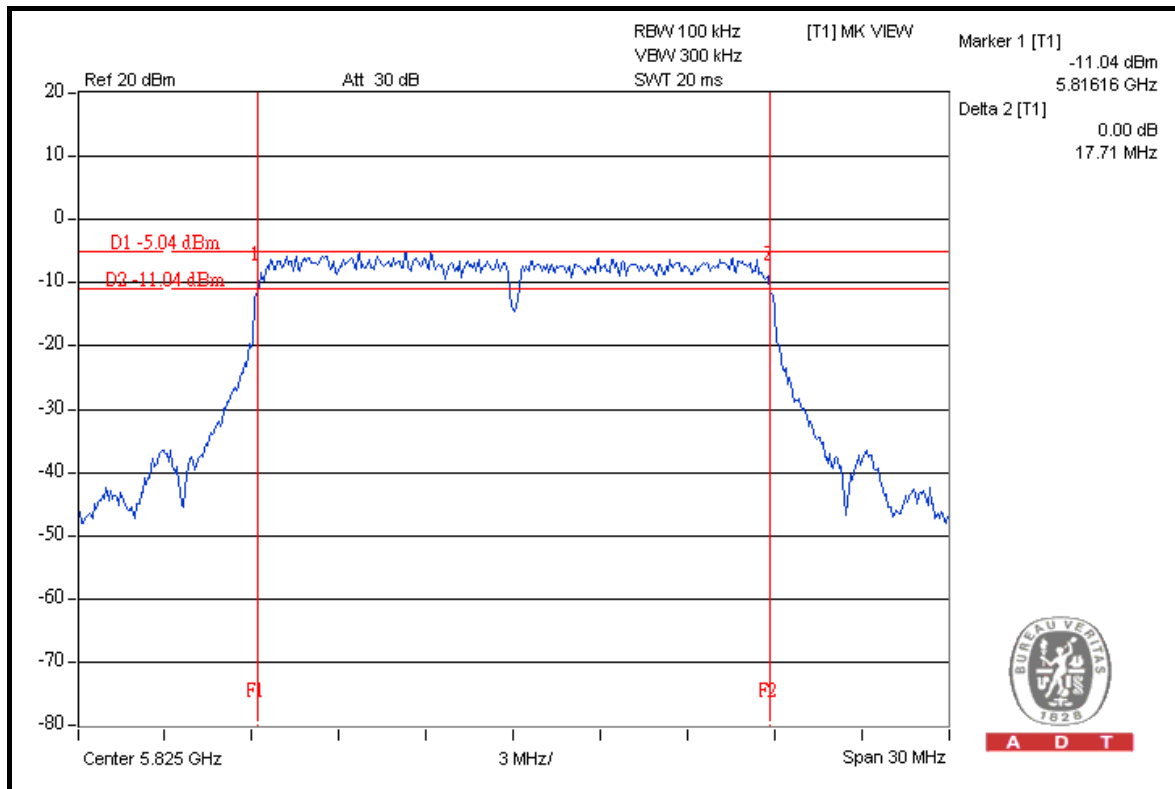

### FOR CHAIN 1: CH 149

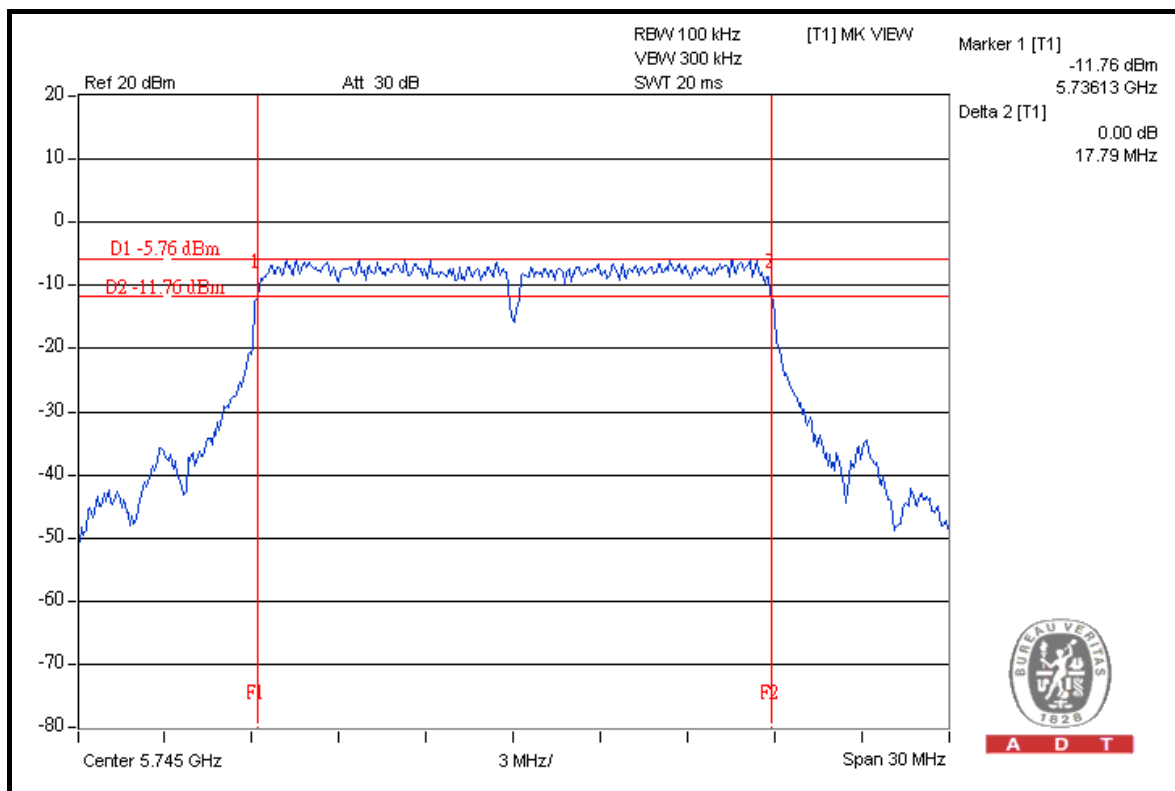



A D T

### CH 157

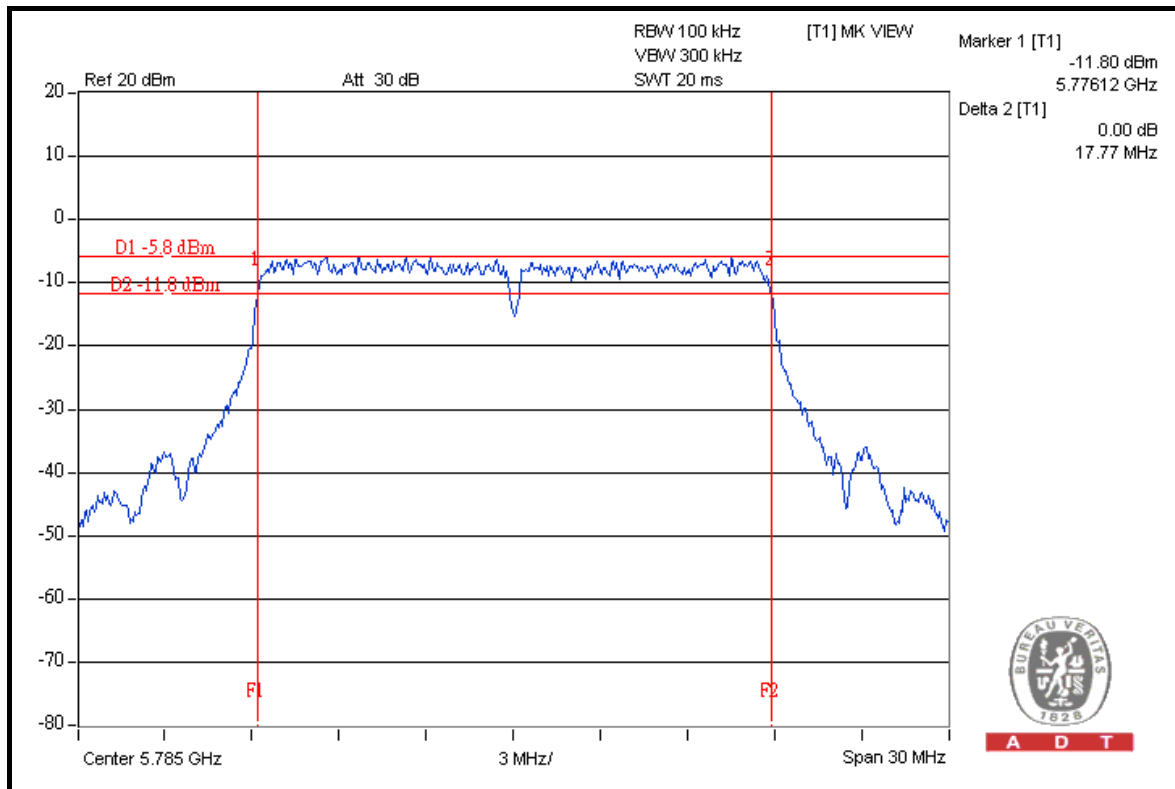

### CH 165

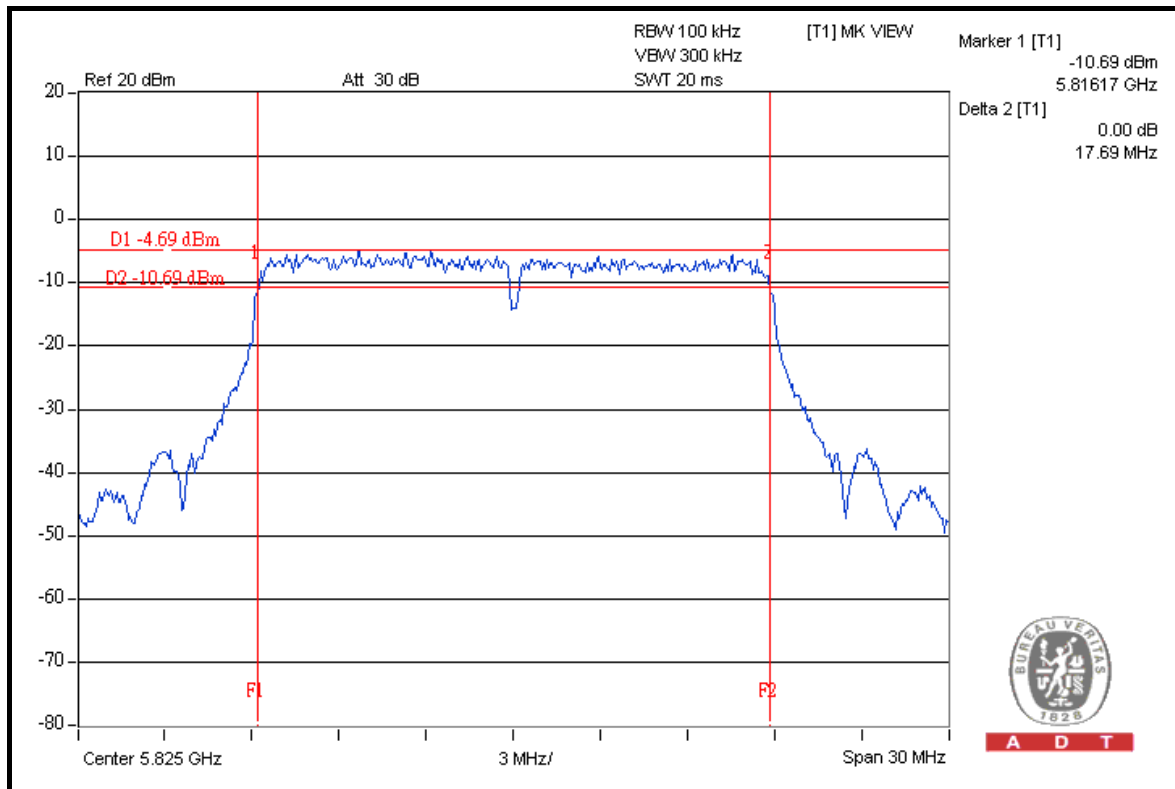



A D T

### DRAFT 802.11n (40MHz) OFDM MODULATION

<b>MODULATION TYPE</b>	BPSK	<b>TRANSFER RATE</b>	15.0Mbps
<b>INPUT POWER</b>	120Vac, 60Hz	<b>ENVIRONMENTAL CONDITIONS</b>	24 deg.C, 64%RH, 1021hPa
<b>TESTED BY</b>	Match Tsui		

CHANNEL	CHANNEL FREQUENCY (MHz)	6dB BANDWIDTH (MHz)		MINIMUM LIMIT (MHz)	PASS / FAIL
		CHAIN 0	CHAIN 1		
151	5755	36.52	36.57	0.5	PASS
159	5795	36.58	36.63	0.5	PASS



A D T

### FOR CHAIN 0: CH 151

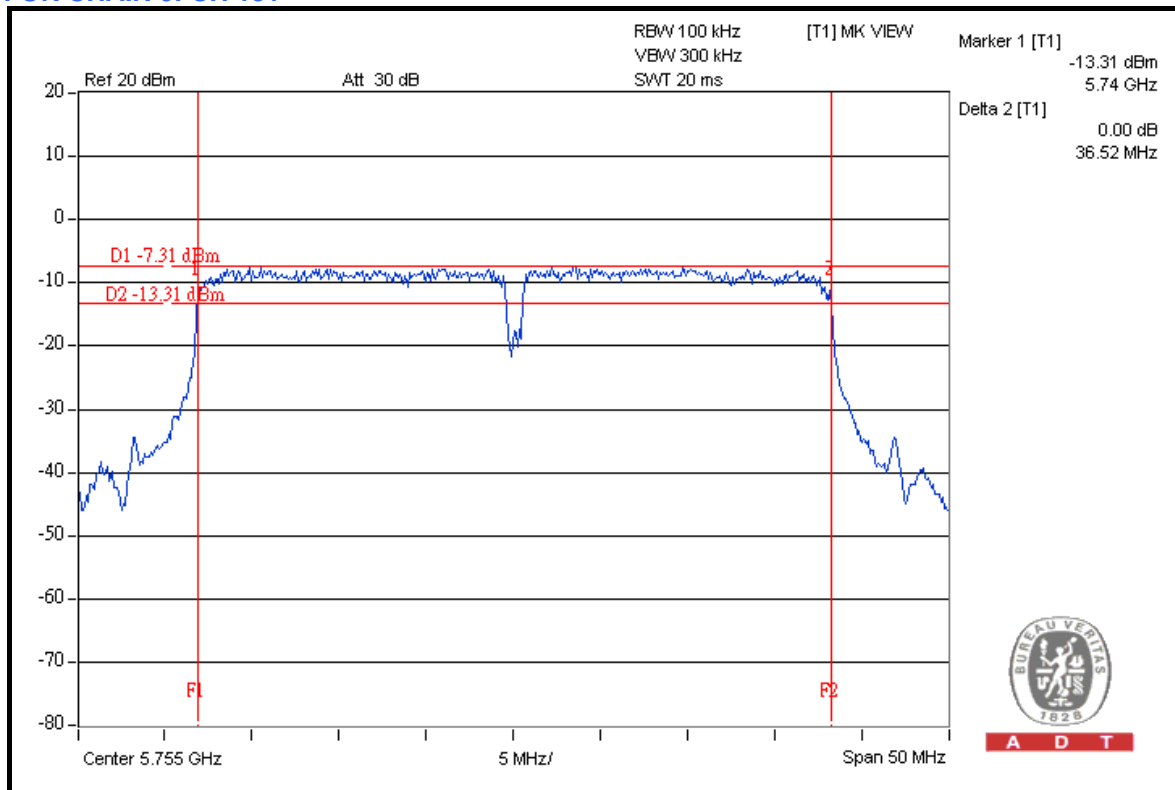

### CH 159

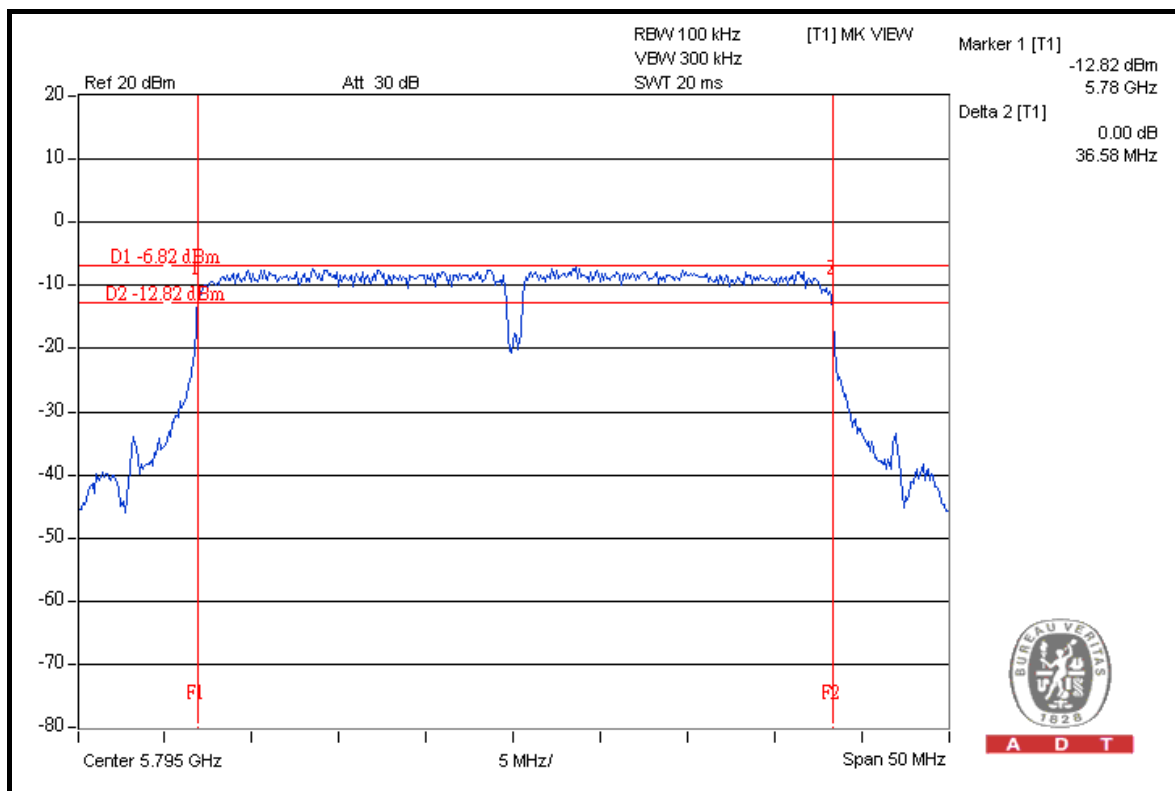



A D T

### FOR CHAIN 1: CH 151

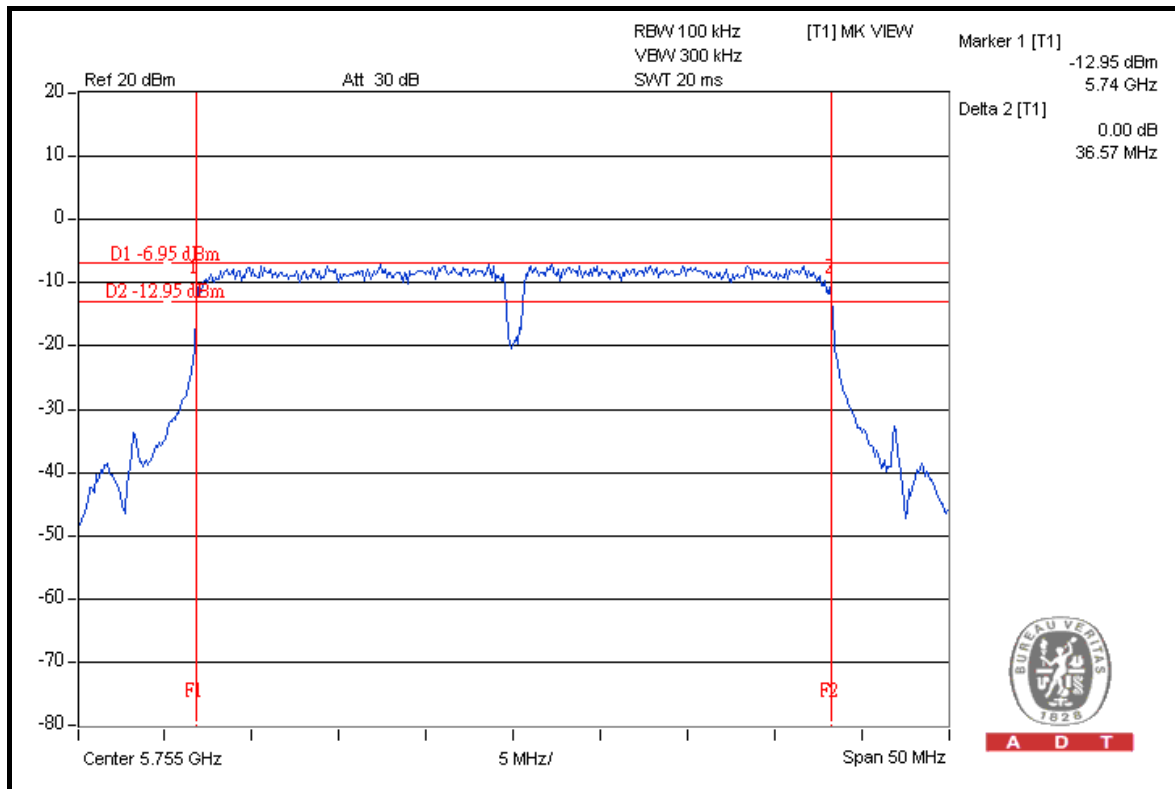

### CH 159

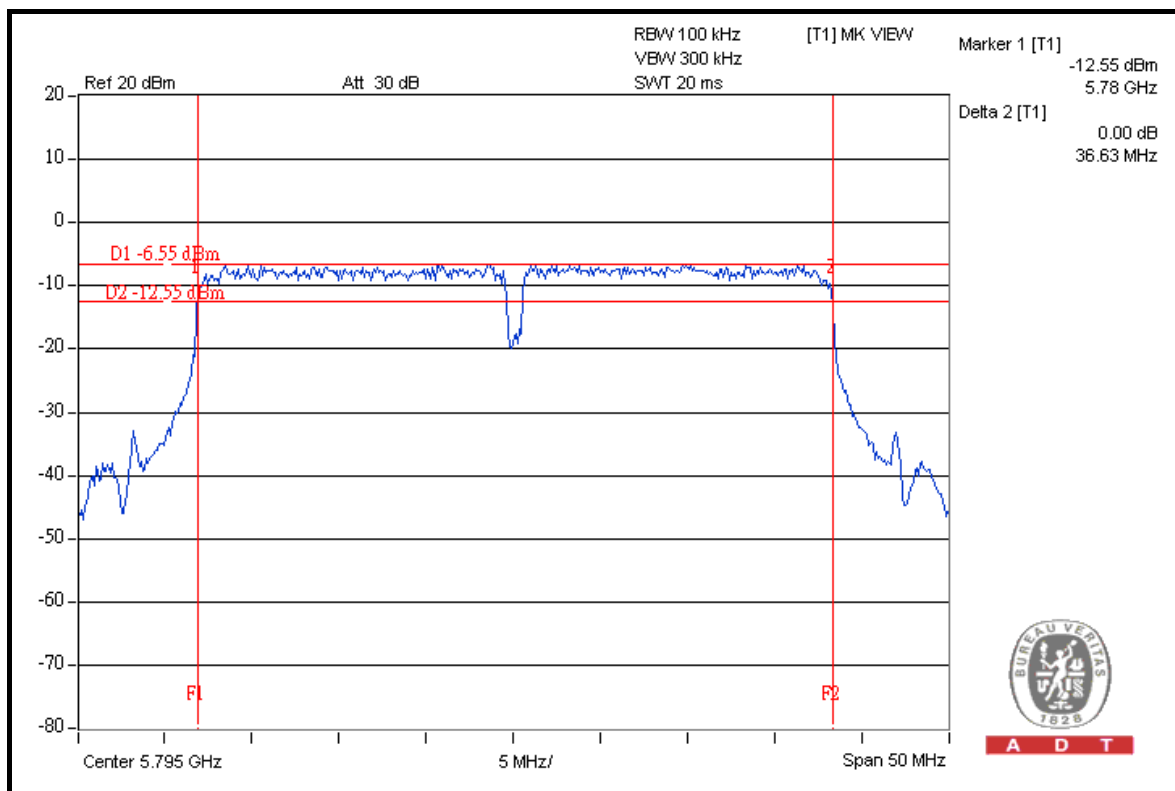



A D T

## 5.4 MAXIMUM PEAK OUTPUT POWER

### 5.4.1 LIMITS OF MAXIMUM PEAK OUTPUT POWER MEASUREMENT

The Maximum Peak Output Power Measurement is 30dBm.

### 5.4.2 INSTRUMENTS

DESCRIPTION & MANUFACTURER	MODEL NO.	SERIAL NO.	DATE OF CALIBRATION	CALIBRATED UNTIL
High Speed Peak Power Meter	ML2495A	0824012	Aug. 04, 2008	Aug. 03, 2009
Power Sensor	MA2444B	0738138	Aug. 04, 2008	Aug. 03, 2009

- Note:** 1. The calibration interval of the above test instruments is 12 months and the calibrations are traceable to NML/ROC and NIST/USA.  
2. Measurement Bandwidth of ML2495A is 65MHz greater than 6dB bandwidth of emission.

### 5.4.3 TEST PROCEDURES

A power sensor was used on the output port of the EUT. A power meter was used to read the response of the power sensor. Record the power level.



#### 5.4.4 DEVIATION FROM TEST STANDARD

No deviation.

#### 5.4.5 TEST SETUP

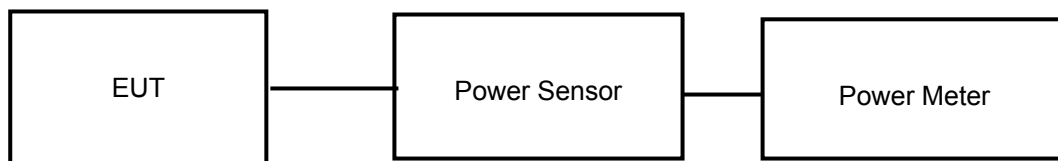

#### 5.4.6 EUT OPERATING CONDITIONS

Same as Item 5.3.6



### 5.4.7 TEST RESULTS

#### 802.11a OFDM MODULATION

<b>MODULATION TYPE</b>	BPSK	<b>TRANSFER RATE</b>	6.0Mbps
<b>INPUT POWER</b>	120Vac, 60Hz	<b>ENVIRONMENTAL CONDITIONS</b>	24 deg.C, 64%RH, 1021hPa
<b>TESTED BY</b>	Match Tsui		

CHAN.	CHAN. FREQ. (MHz)	PEAK POWER OUTPUT (dBm)		TOTAL PEAK POWER (mW)	TOTAL PEAK POWER (dBm)	PEAK POWER LIMIT (dBm)	PASS / FAIL
		CHAIN 0	CHAIN 1				
149	5745	19.52	19.53	179.279	22.54	30	PASS
157	5785	19.54	19.51	179.280	22.54	30	PASS
165	5825	20.04	20.05	202.083	23.06	30	PASS

#### DRAFT 802.11n (20MHz) OFDM MODULATION

<b>MODULATION TYPE</b>	BPSK	<b>TRANSFER RATE</b>	7.2Mbps
<b>INPUT POWER</b>	120Vac, 60Hz	<b>ENVIRONMENTAL CONDITIONS</b>	24 deg.C, 64%RH, 1021hPa
<b>TESTED BY</b>	Match Tsui		

CHAN.	CHAN. FREQ. (MHz)	PEAK POWER OUTPUT (dBm)		TOTAL PEAK POWER (mW)	TOTAL PEAK POWER (dBm)	PEAK POWER LIMIT (dBm)	PASS / FAIL
		CHAIN 0	CHAIN 1				
149	5745	19.52	19.55	179.694	22.55	30	PASS
157	5785	19.53	19.56	180.108	22.56	30	PASS
165	5825	20.54	20.53	226.220	23.55	30	PASS



A D T

**DRAFT 802.11n (40MHz) OFDM MODULATION**

<b>MODULATION TYPE</b>	BPSK	<b>TRANSFER RATE</b>	15.0Mbps
<b>INPUT POWER</b>	120Vac, 60Hz	<b>ENVIRONMENTAL CONDITIONS</b>	24 deg.C, 64%RH, 1021hPa
<b>TESTED BY</b>	Match Tsui		

CHAN.	CHAN. FREQ. (MHz)	PEAK POWER OUTPUT (dBm)		TOTAL PEAK POWER (mW)	TOTAL PEAK POWER (dBm)	PEAK POWER LIMIT (dBm)	PASS / FAIL
		CHAIN 0	CHAIN 1				
151	5755	20.52	20.54	225.960	23.54	30	PASS
159	5795	21.11	21.06	256.766	24.10	30	PASS



## 5.5 POWER SPECTRAL DENSITY MEASUREMENT

### 5.5.1 LIMITS OF POWER SPECTRAL DENSITY MEASUREMENT

The Maximum of Power Spectral Density Measurement is 8dBm.

### 5.5.2 TEST INSTRUMENTS

DESCRIPTION & MANUFACTURER	MODEL NO.	SERIAL NO.	DATE OF CALIBRATION	CALIBRATED UNTIL
R&S SPECTRUM ANALYZER	FSP40	100041	Apr. 22, 2008	Apr. 21, 2009

**NOTE:** The calibration interval of the above test instruments is 12 months and the calibrations are traceable to NML/ROC and NIST/USA.

### 5.5.3 TEST PROCEDURE

The transmitter output was connected to the spectrum analyzer through an attenuator, the bandwidth of the fundamental frequency was measured with the spectrum analyzer using 3kHz RBW and 30kHz VBW, set sweep time = span/3kHz. The power spectral density was measured and recorded.

The sweep time is allowed to be longer than span/3kHz for a full response of the mixer in the spectrum analyzer.



A D T

#### 5.5.4 DEVIATION FROM TEST STANDARD

No deviation.

#### 5.5.5 TEST SETUP

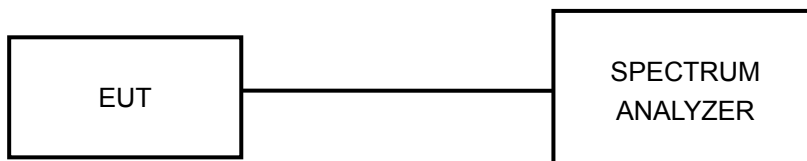

#### 5.5.6 EUT OPERATING CONDITION

Same as Item 5.3.6.



A D T

### 5.5.7 TEST RESULTS

#### 802.11a OFDM MODULATION

<b>MODULATION TYPE</b>	BPSK	<b>TRANSFER RATE</b>	6.0Mbps
<b>INPUT POWER</b>	120Vac, 60Hz	<b>ENVIRONMENTAL CONDITIONS</b>	24 deg.C, 64%RH, 1021hPa
<b>TESTED BY</b>	Match Tsui		

CHAN.	CHAN. FREQ. (MHz)	RF POWER LEVEL IN 3kHz BW (dBm)		TOTAL POWER DENSITY (mW)	TOTAL POWER DENSITY (dBm)	MAX. LIMIT (dBm)	PASS / FAIL
		CHAIN 0	CHAIN 1				
149	5745	-19.72	-19.26	0.023	-16.47	8	PASS
157	5785	-19.67	-19.48	0.022	-16.56	8	PASS
165	5825	-19.03	-18.99	0.025	-16.00	8	PASS



A D T

### FOR CHAIN 0: CH 149

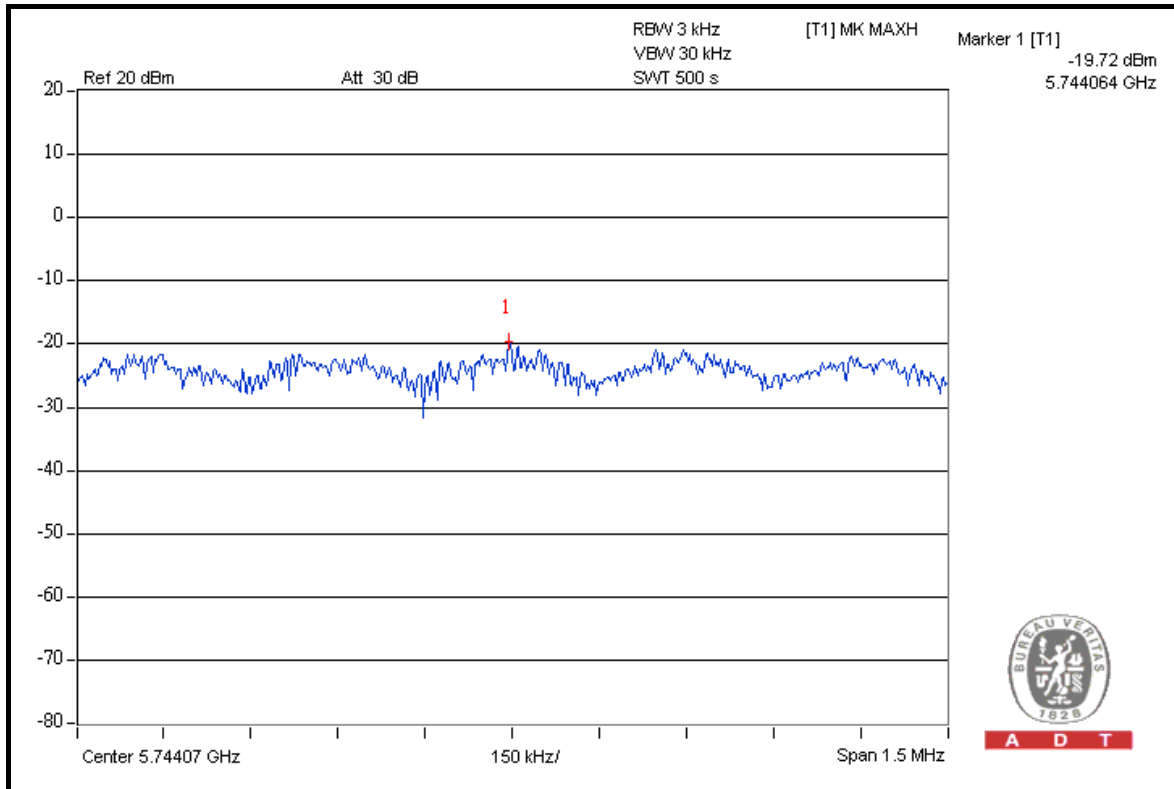

### CH 157

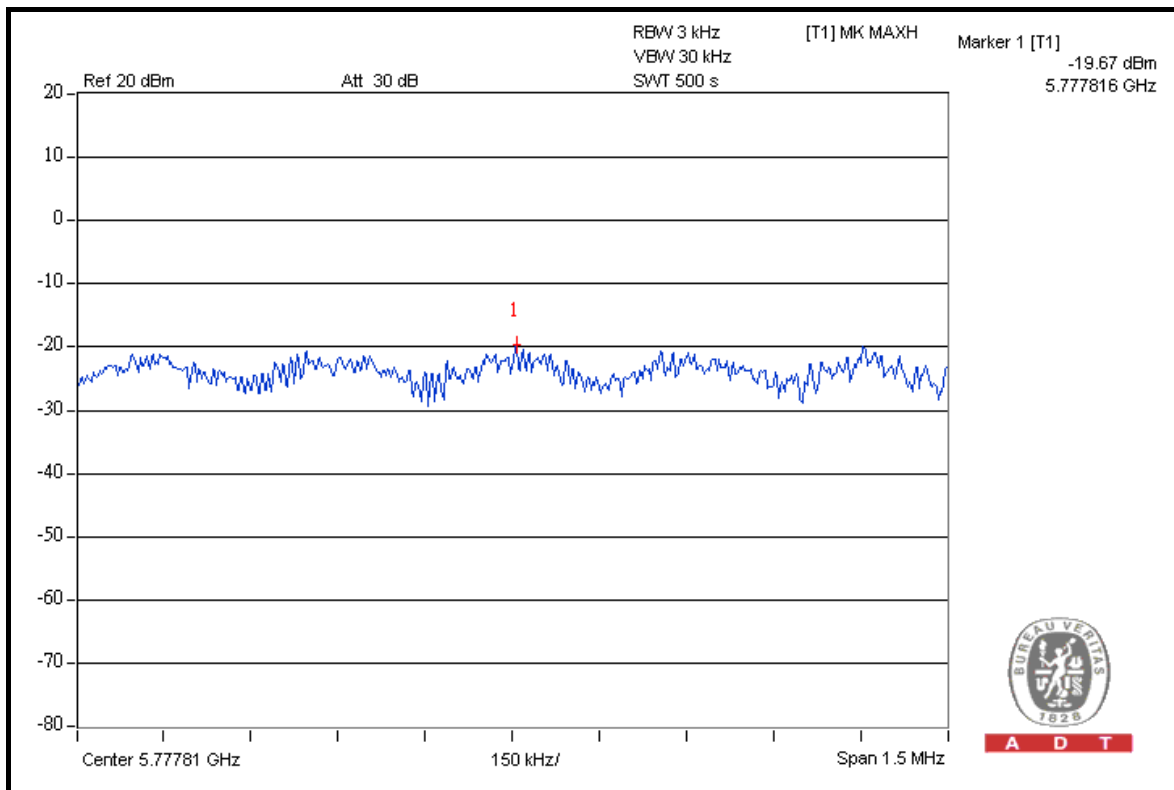



A D T

### CH 165

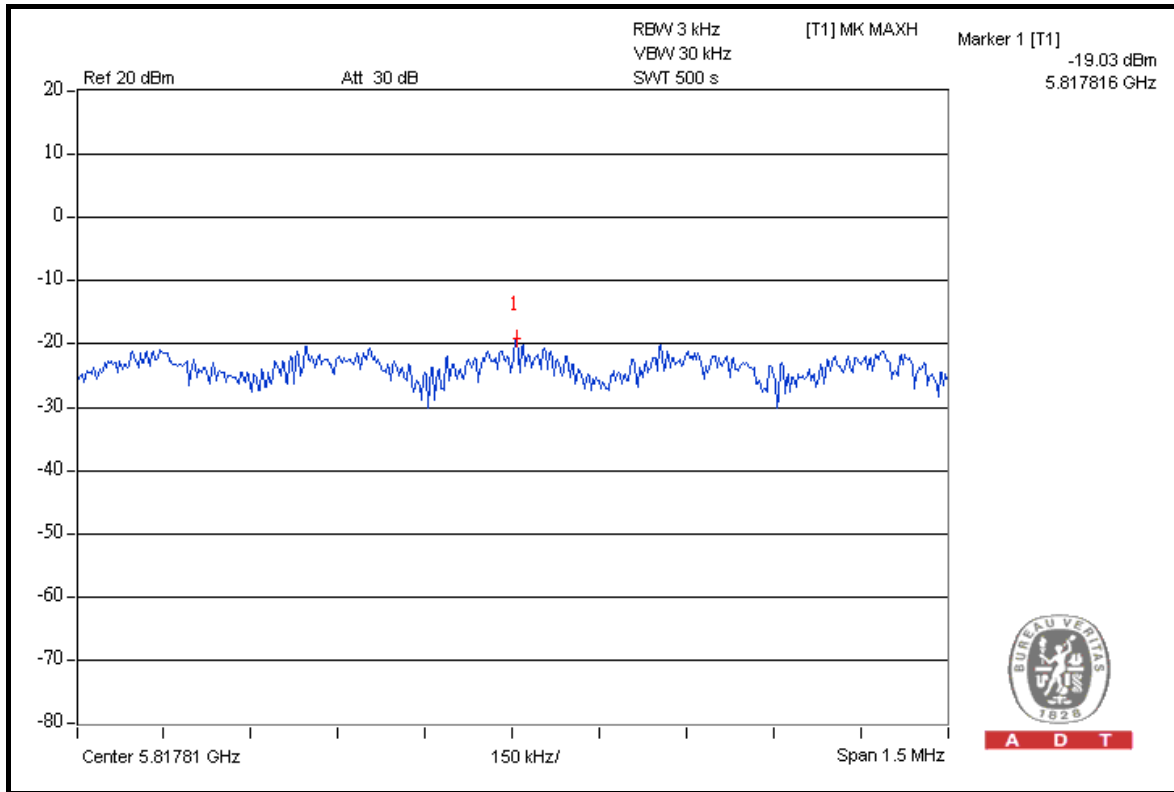

### FOR CHAIN 1: CH 149

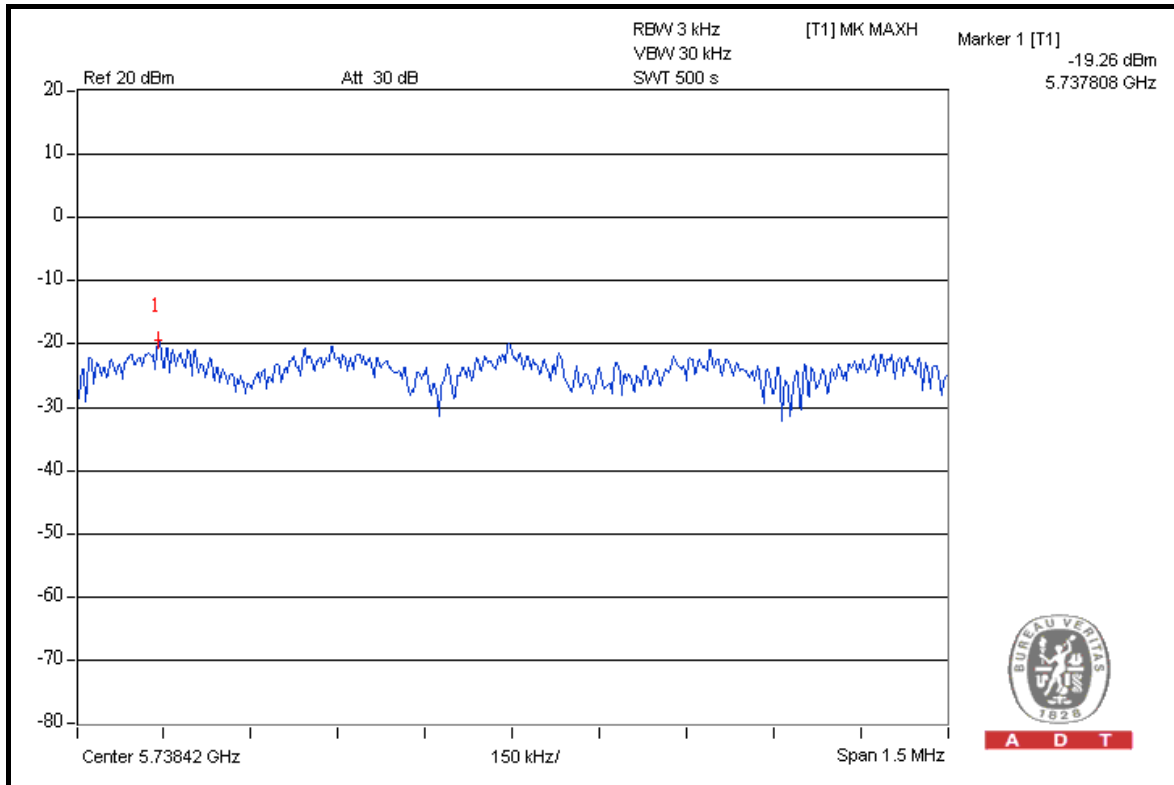





A D T

### CH 157

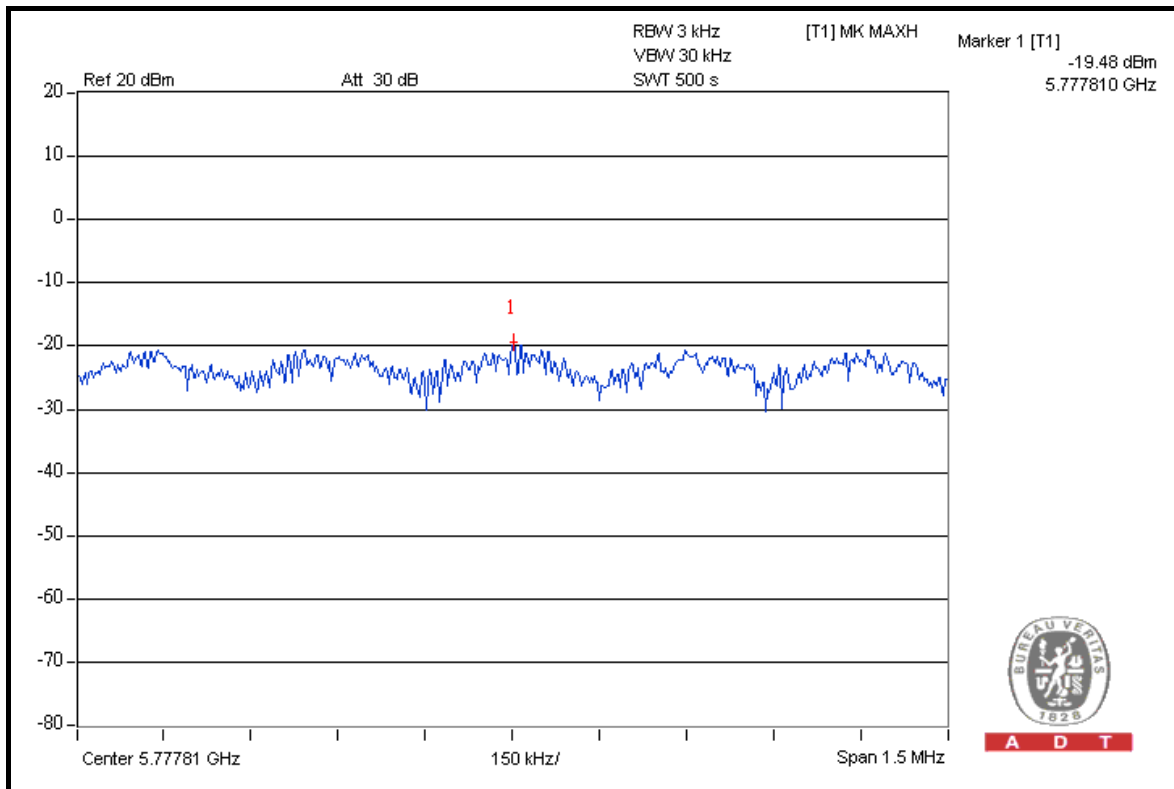

### CH 165

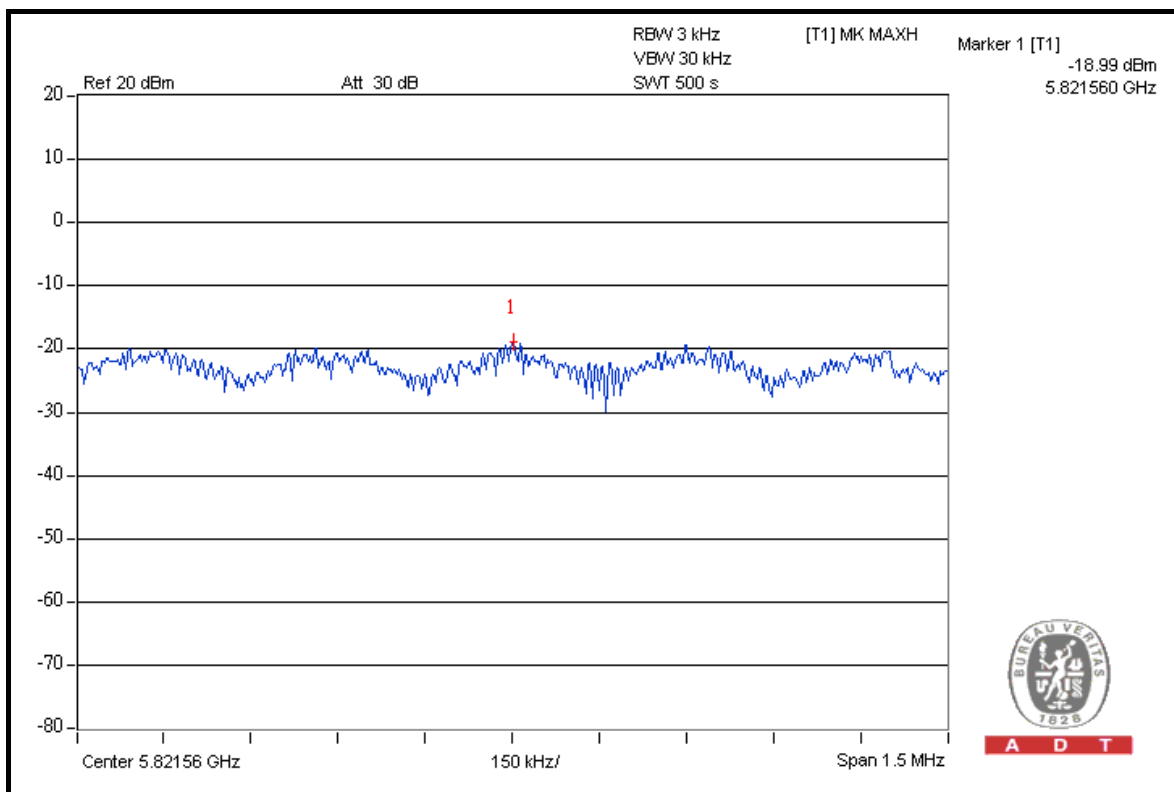



A D T

**DRAFT 802.11n (20MHz) OFDM MODULATION**

<b>MODULATION TYPE</b>	BPSK	<b>TRANSFER RATE</b>	7.2Mbps
<b>INPUT POWER</b>	120Vac, 60Hz	<b>ENVIRONMENTAL CONDITIONS</b>	24 deg.C, 64%RH, 991hPa
<b>TESTED BY</b>	Match Tsui		

CHAN.	CHAN. FREQ. (MHz)	RF POWER LEVEL IN 3kHz BW (dBm)		TOTAL POWER DENSITY (mW)	TOTAL POWER DENSITY (dBm)	MAX. LIMIT (dBm)	PASS / FAIL
		CHAIN 0	CHAIN 1				
149	5745	-19.31	-19.46	0.023	-16.37	8	PASS
157	5785	-19.15	-19.49	0.023	-16.31	8	PASS
165	5825	-18.33	-18.37	0.029	-15.34	8	PASS



A D T

### FOR CHAIN 0: CH 149

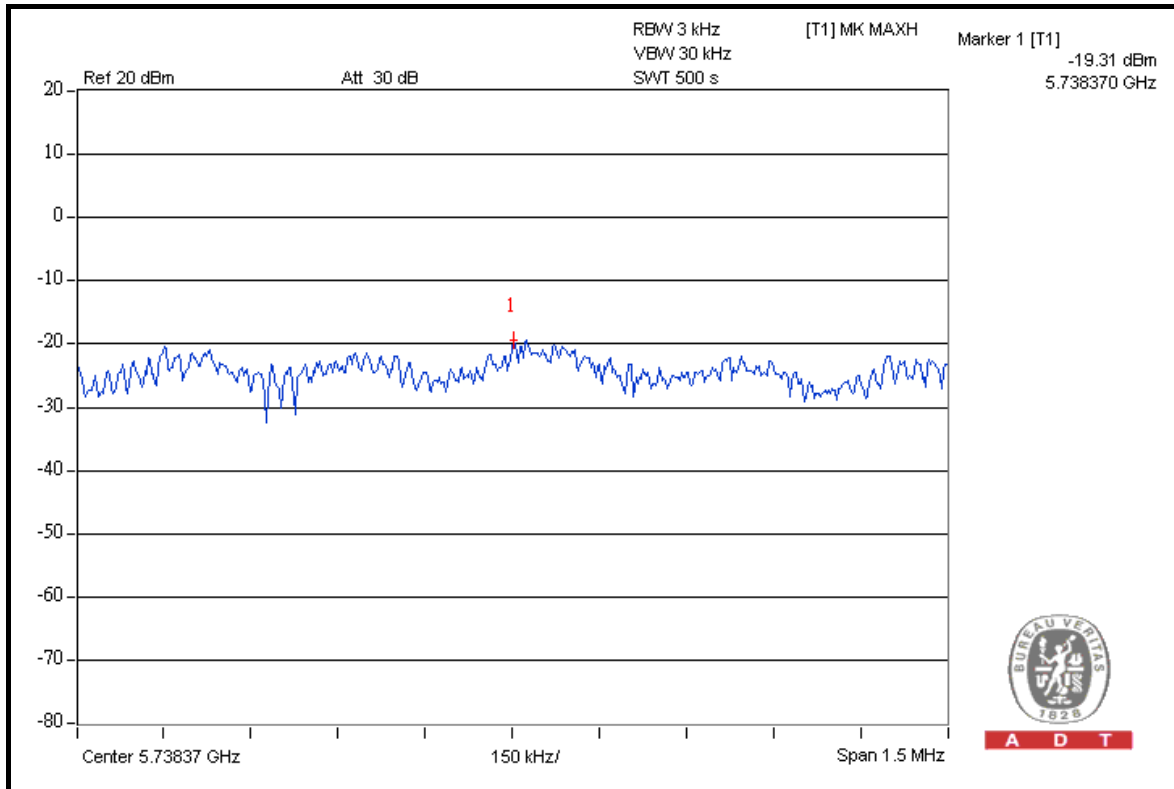

### CH 157

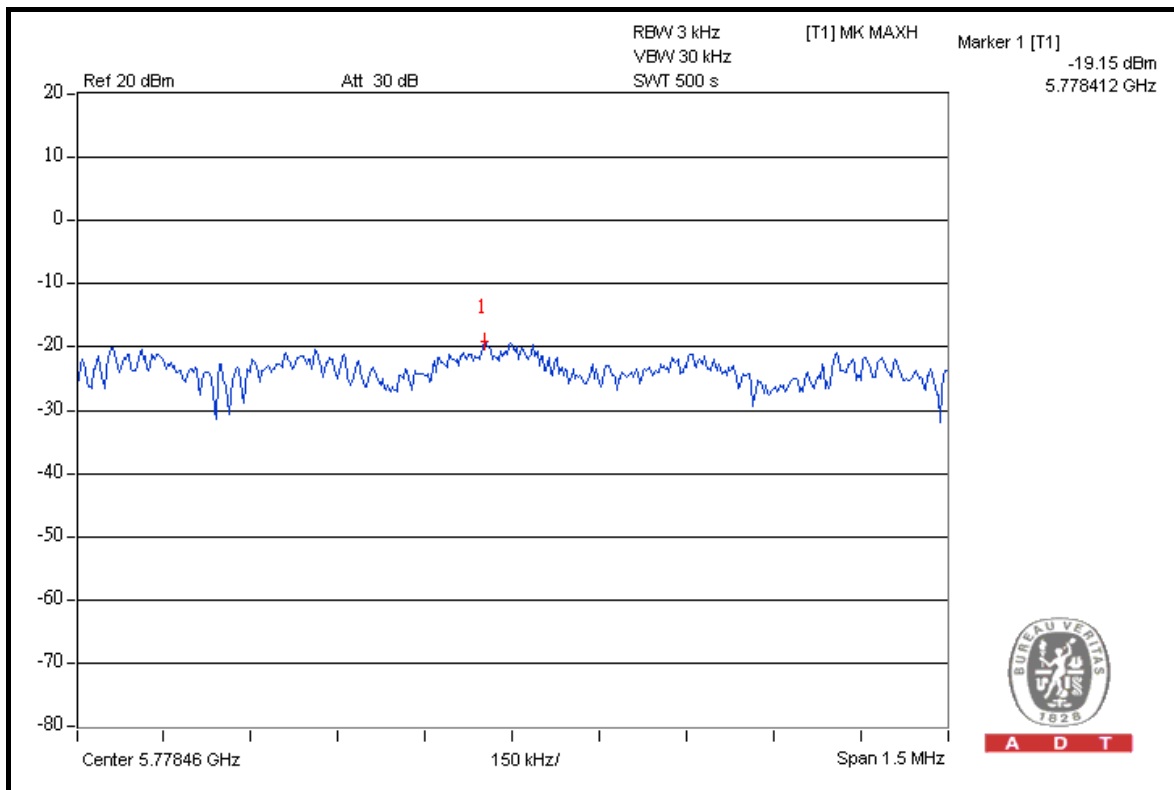



A D T

### CH 165

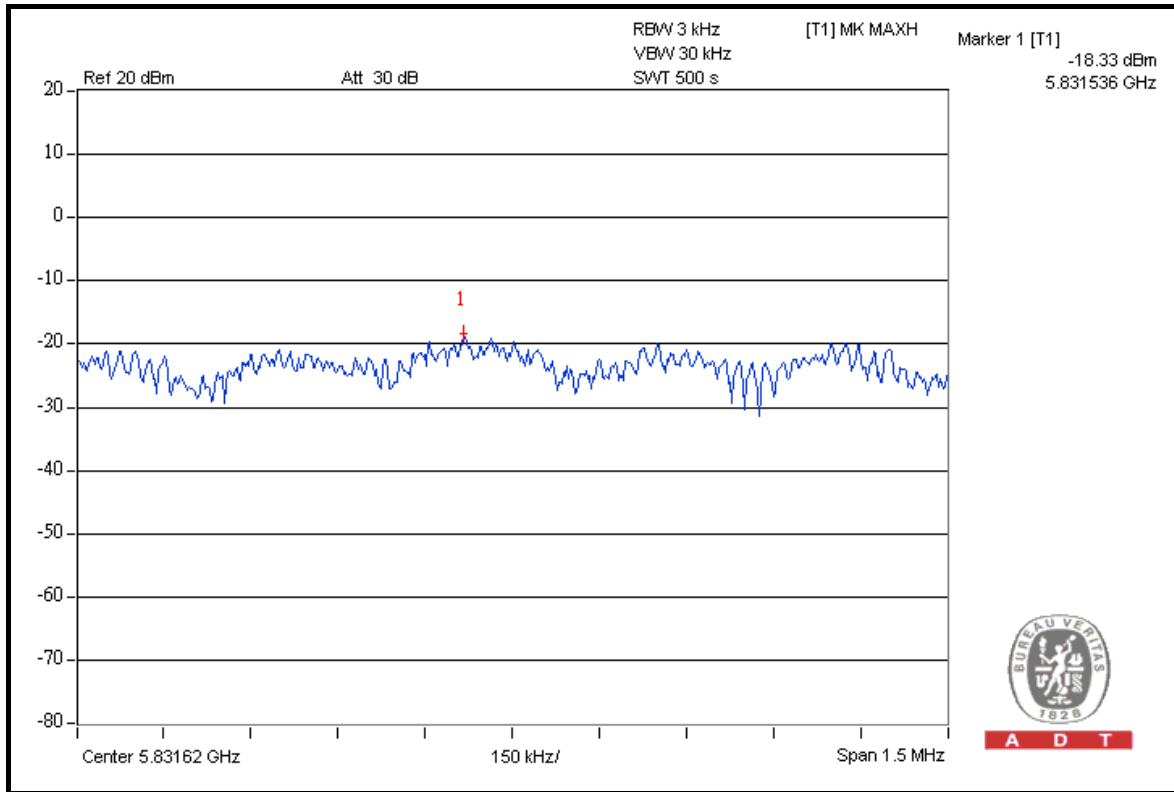

### FOR CHAIN 1: CH 149

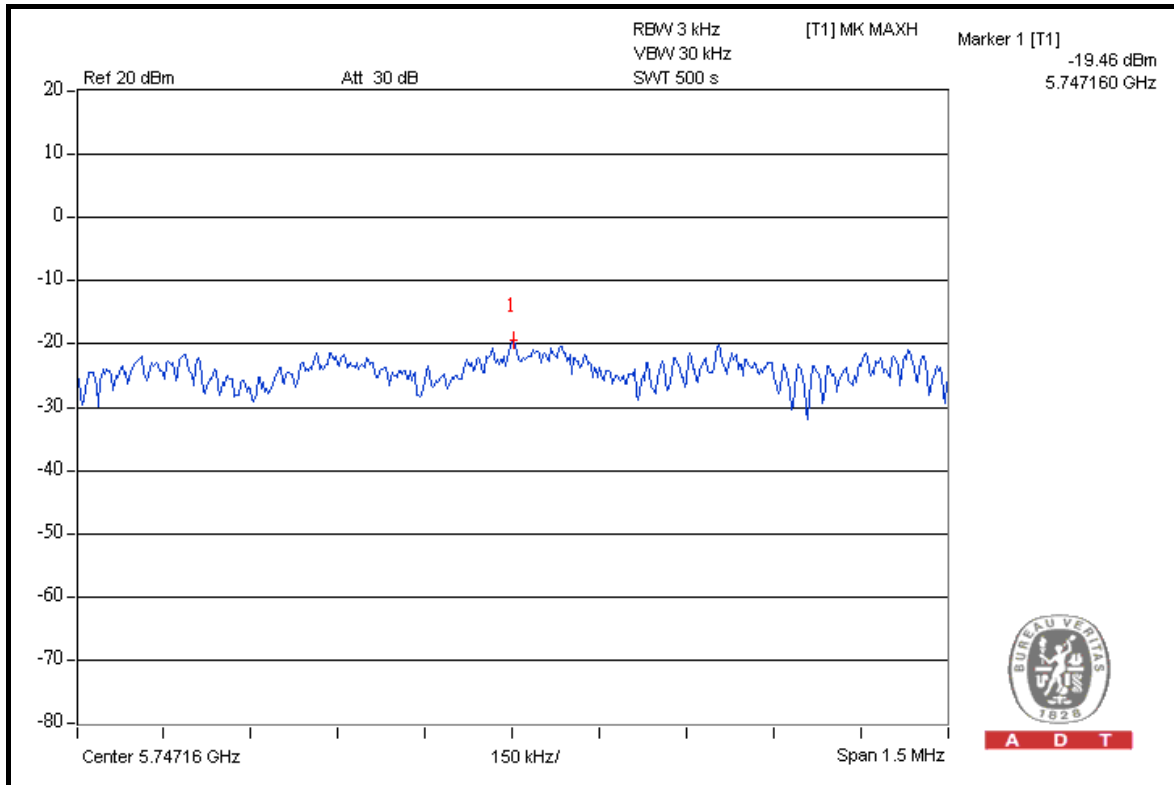



A D T

### CH 157

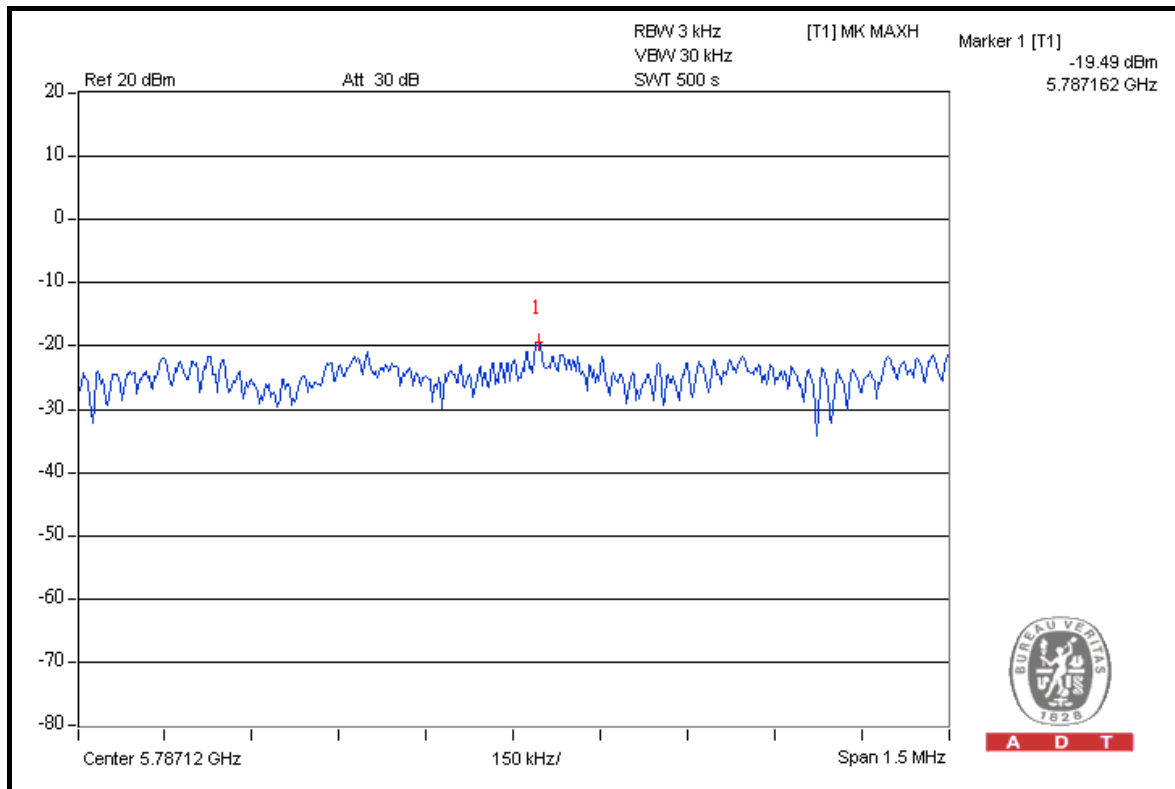

### CH 165

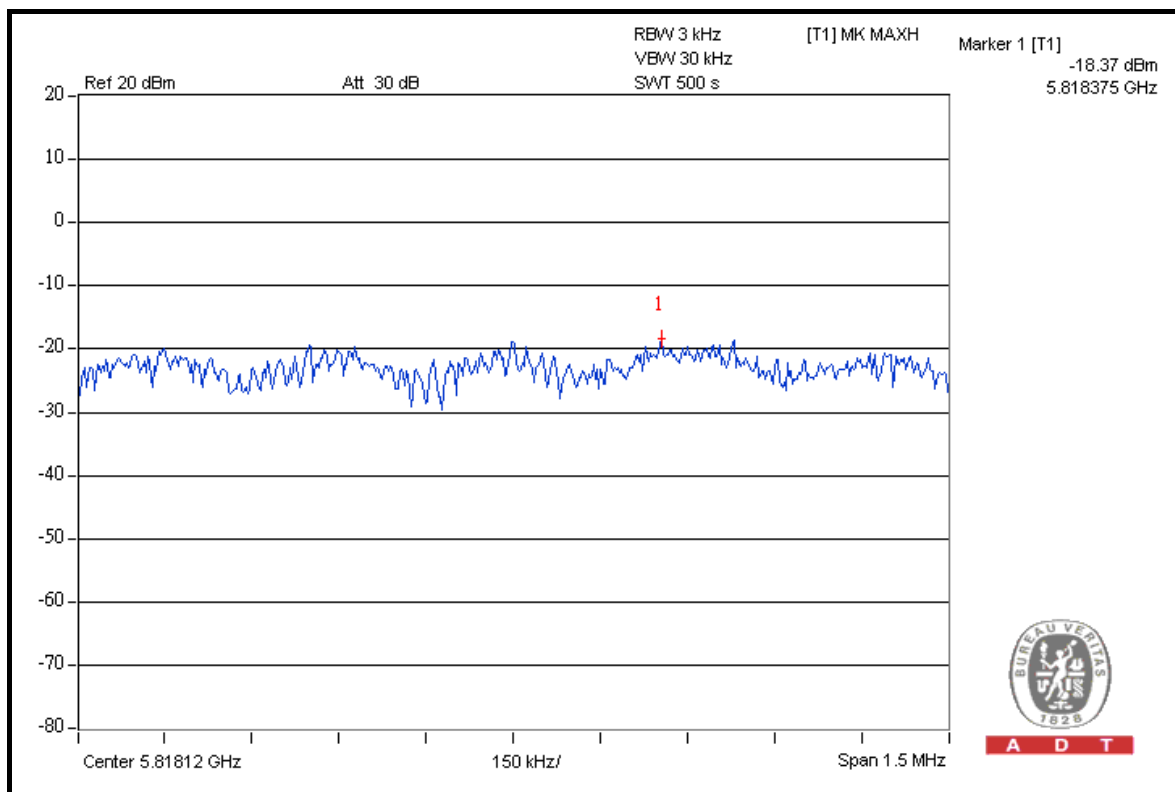



A D T

**DRAFT 802.11n (40MHz) OFDM MODULATION**

<b>MODULATION TYPE</b>	BPSK	<b>TRANSFER RATE</b>	15.0Mbps
<b>INPUT POWER</b>	120Vac, 60Hz	<b>ENVIRONMENTAL CONDITIONS</b>	24 deg.C, 64%RH, 1021hPa
<b>TESTED BY</b>	Match Tsui		

CHAN.	CHAN. FREQ. (MHz)	RF POWER LEVEL IN 3kHz BW (dBm)		TOTAL POWER DENSITY (mW)	TOTAL POWER DENSITY (dBm)	MAX. LIMIT (dBm)	PASS / FAIL
		CHAIN 0	CHAIN 1				
151	5755	-20.89	-19.20	0.020	-16.95	8	PASS
159	5795	-20.44	-18.85	0.022	-16.56	8	PASS



A D T

### FOR CHAIN 0: CH 151

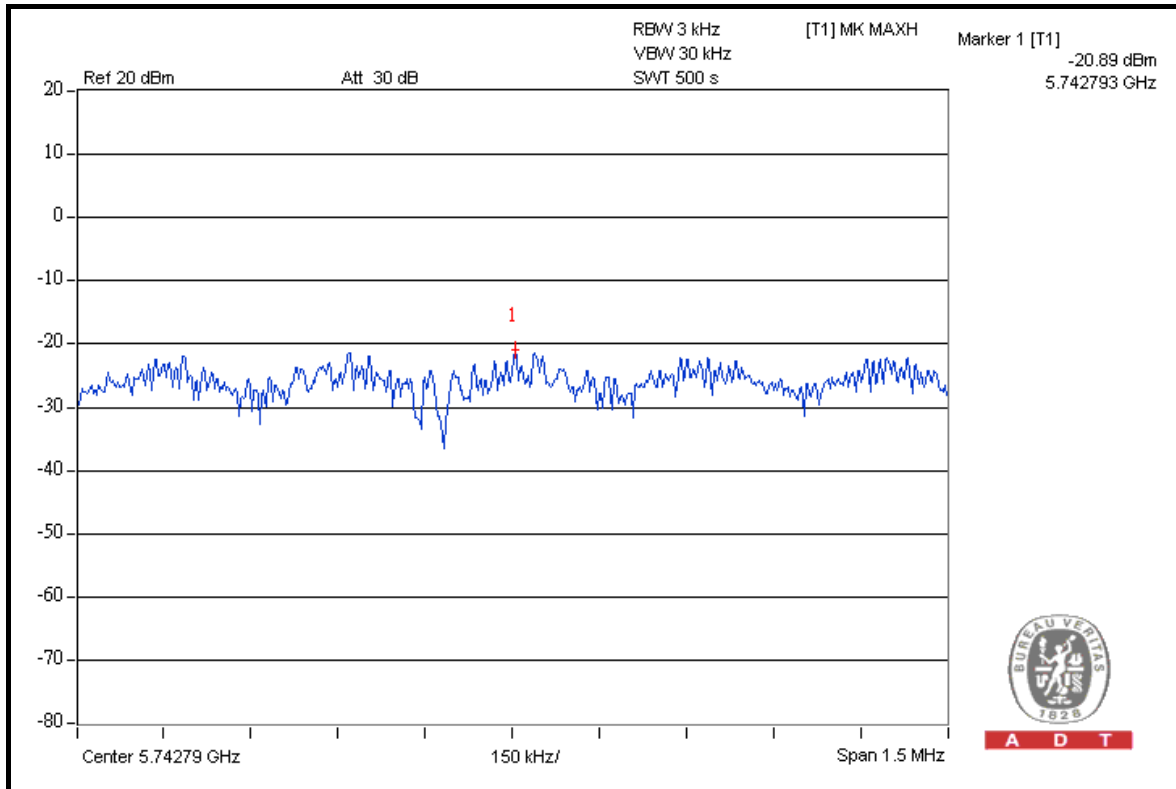

### CH 159

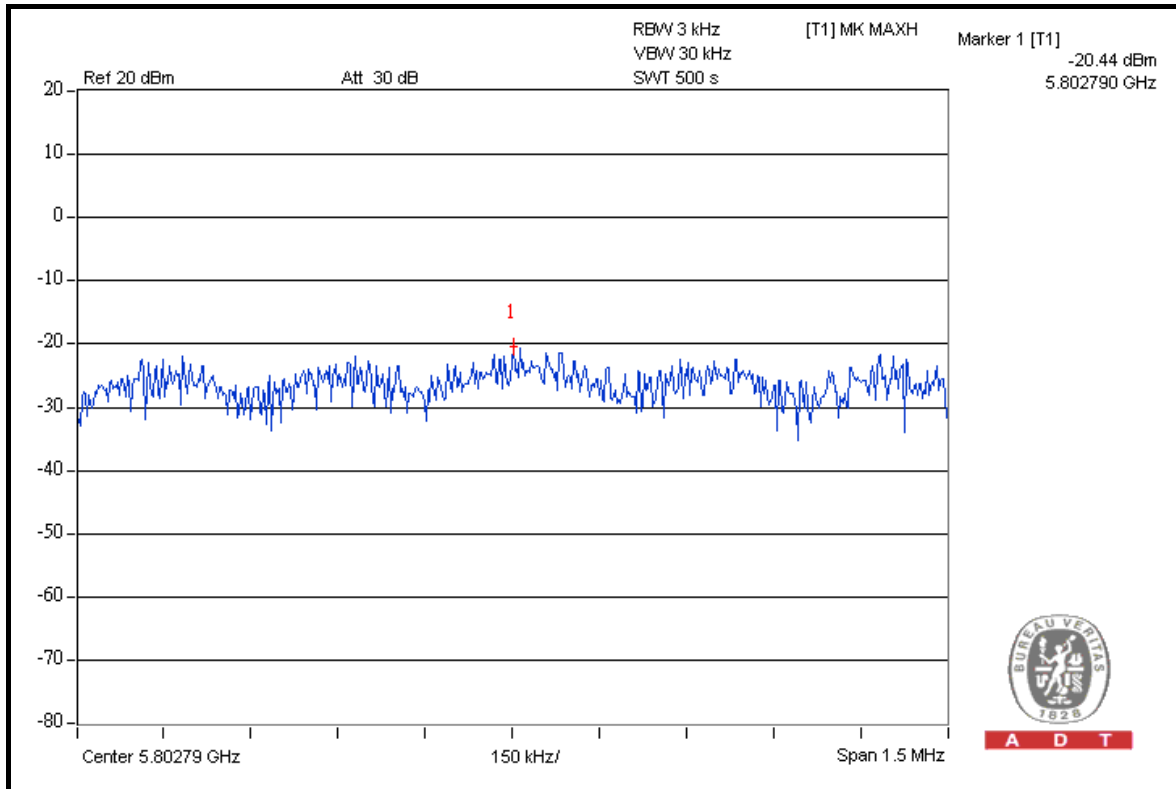



A D T

### FOR CHAIN 1: CH 151

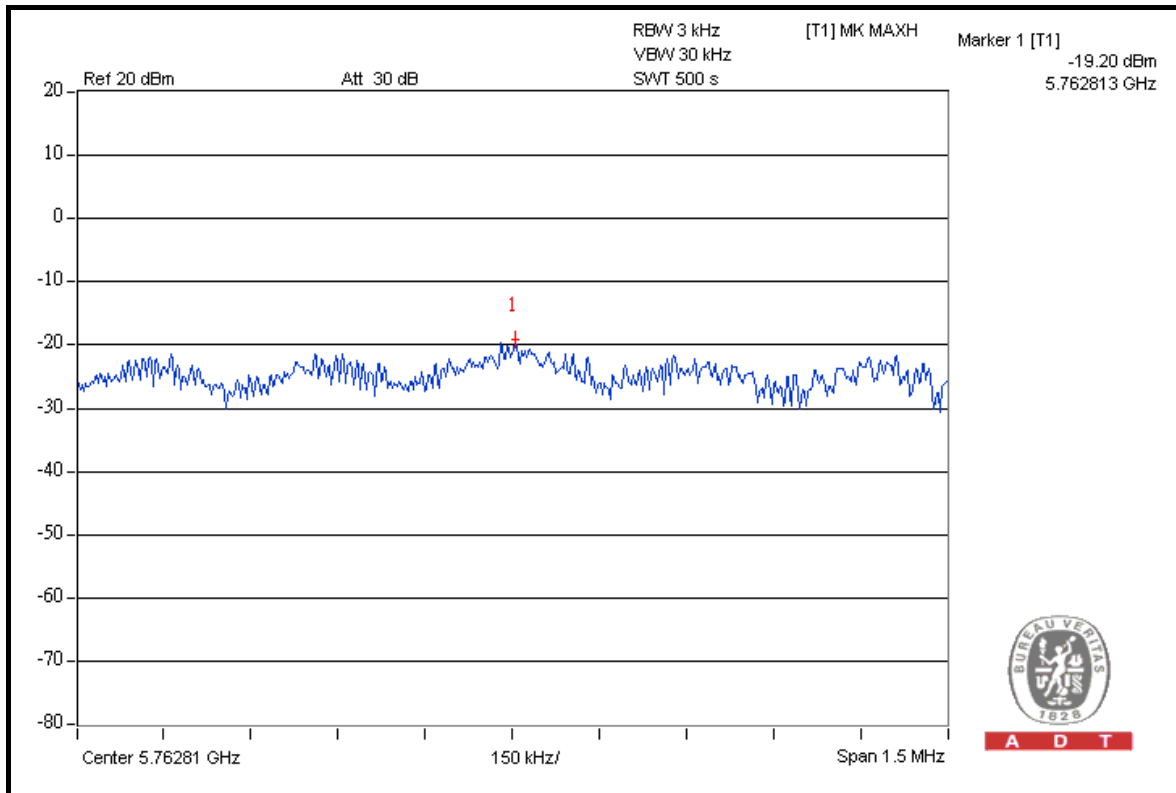

### CH 159

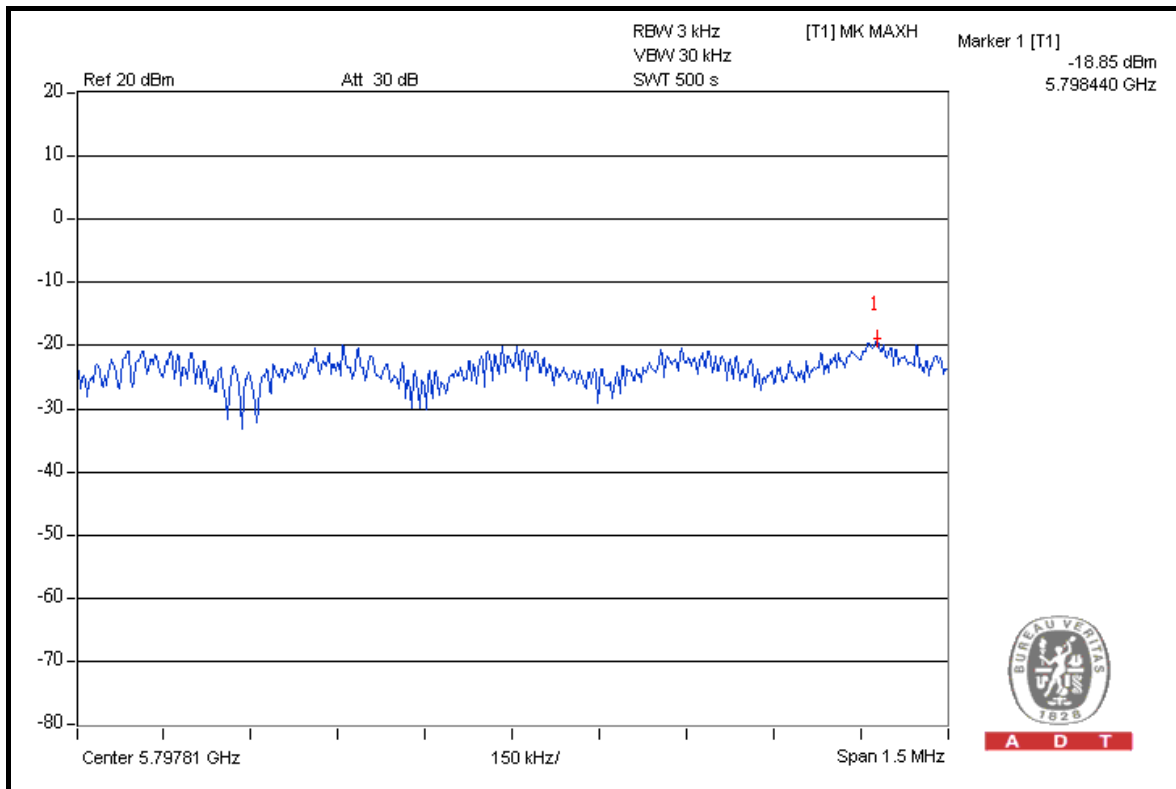





A D T

## 5.6 BAND EDGES MEASUREMENT

### 5.6.1 LIMITS OF BAND EDGES MEASUREMENT

Below -20dB of the highest emission level of operating band (in 100kHz Resolution Bandwidth).

### 5.6.2 TEST INSTRUMENTS

DESCRIPTION & MANUFACTURER	MODEL NO.	SERIAL NO.	DATE OF CALIBRATION	DUE DATE OF CALIBRATION
Test Receiver ROHDE & SCHWARZ	ESIB7	100212	May 28, 2008	May 27, 2009
Spectrum Analyzer ROHDE & SCHWARZ	FSP40	100269	Aug. 08, 2008	Aug. 07, 2009
BILOG Antenna SCHWARZBECK	VULB9168	9168-156	Apr. 25, 2008	Apr. 24, 2009
HORN Antenna SCHWARZBECK	BBHA 9120 D	9120D-563	Aug. 06, 2008	Aug. 05, 2009
HORN Antenna SCHWARZBECK	BBHA 9170	BBHA9170148	Jul. 03, 2008	Jul. 02, 2009
Preamplifier Agilent	8449B	3008A01911	Sep. 10, 2008	Sep. 09, 2009
Preamplifier Agilent	8447D	2944A10638	Dec. 26, 2008	Dec. 25, 2009
RF signal cable HUBER+SUHNNER	SUCOFLEX 104	218190/4 231241/4	May 20, 2008	May 19, 2009
RF signal cable Worken	8D-FB	Cable-HYCH9-01	Aug. 09, 2008	Aug. 08, 2009
Software	ADT_Radiated_ V7.6.15.9.2	NA	NA	NA
Antenna Tower EMCO	2070/2080	512.835.4684	NA	NA
Turn Table EMCO	2087-2.03	NA	NA	NA
Antenna Tower & Turn Table Controller EMCO	2090	NA	NA	NA
26GHz ~ 40GHz Amplifier	EM26400	07026401	Aug. 27, 2008	Aug. 26, 2009

- NOTE:**
1. The calibration interval of the above test instruments is 12 months and the calibrations are traceable to NML/ROC and NIST/USA.
  2. The test was performed in HwaYa Chamber 9.
  3. The horn antenna and HP preamplifier (model: 8449B) are used only for the measurement of emission frequency above 1GHz if tested.
  4. The FCC Site Registration No. is 460141.
  5. The IC Site Registration No. is IC 7450F-4.



A D T

### 5.6.3 TEST PROCEDURE

- a. The EUT was placed on the top of a rotating table 0.8 meters above the ground at a 3 meter semi-anechoic chamber. The table was rotated 360 degrees to determine the position of the highest radiation.
- b. The EUT was set 3 meters away from the interference-receiving antenna, which was mounted on the top of a variable-height antenna tower.
- c. The antenna is a broadband antenna, and its height is varied from one meter to four meters above the ground to determine the maximum value of the field strength. Both horizontal and vertical polarizations of the antenna are set to make the measurement.
- d. For each suspected emission, the EUT was arranged to its worst case and then the antenna was tuned to heights from 1 meter to 4 meters and the rotatable table was turned from 0 degrees to 360 degrees to find the maximum reading.
- e. Set both RBW and VBW of spectrum analyzer to 100kHz and 300kHz with suitable frequency span including 100MHz bandwidth from band edge. The band edges was measured and recorded.

**NOTE:** The resolution bandwidth of test receiver/spectrum analyzer is 1MHz and the video bandwidth is 10Hz for Average detection (AV) at frequency above 1GHz.



A D T

#### 5.6.4 DEVIATION FROM TEST STANDARD

No deviation.

#### 5.6.5 EUT OPERATING CONDITION

Same as Item 5.3.6.

#### 5.6.6 TEST RESULTS

The spectrum plots are attached on the following pages. D1 line indicates the highest level, D2 line indicates the 20dB offset below D1. It shows compliance with the requirement in part 15.247(d).



A D T

### 802.11a OFDM MODULATION

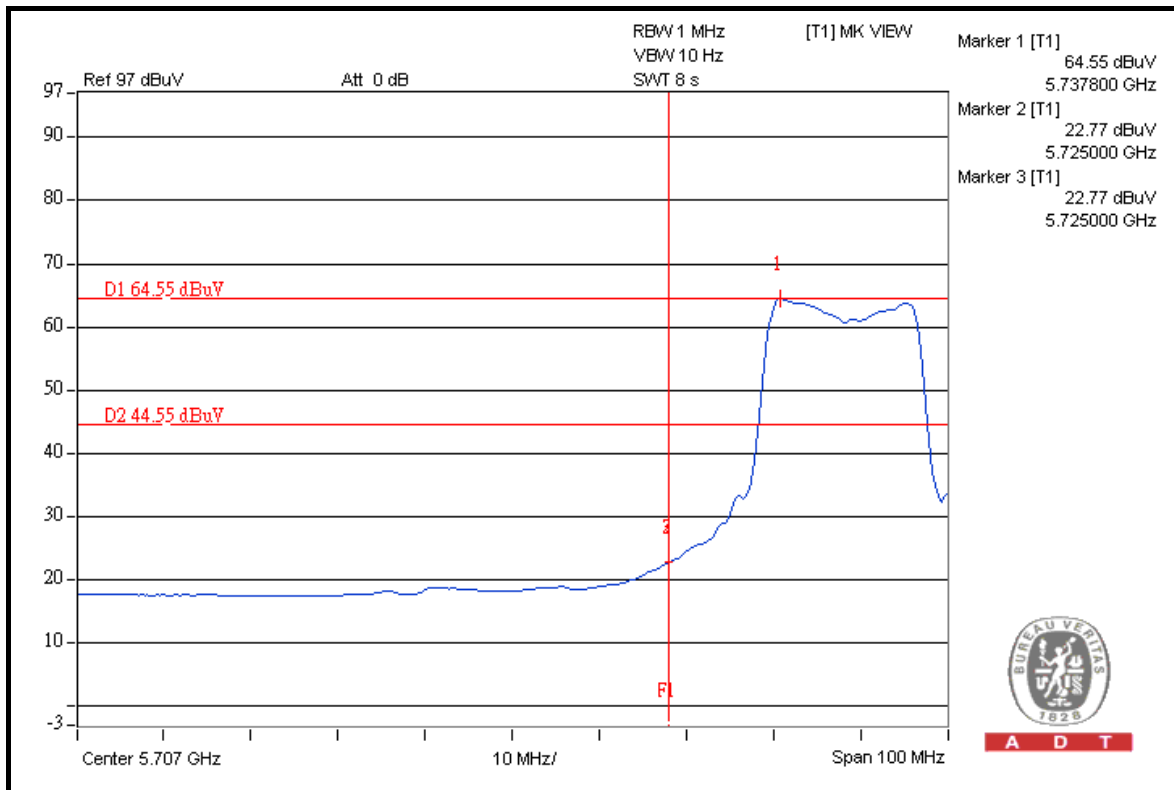
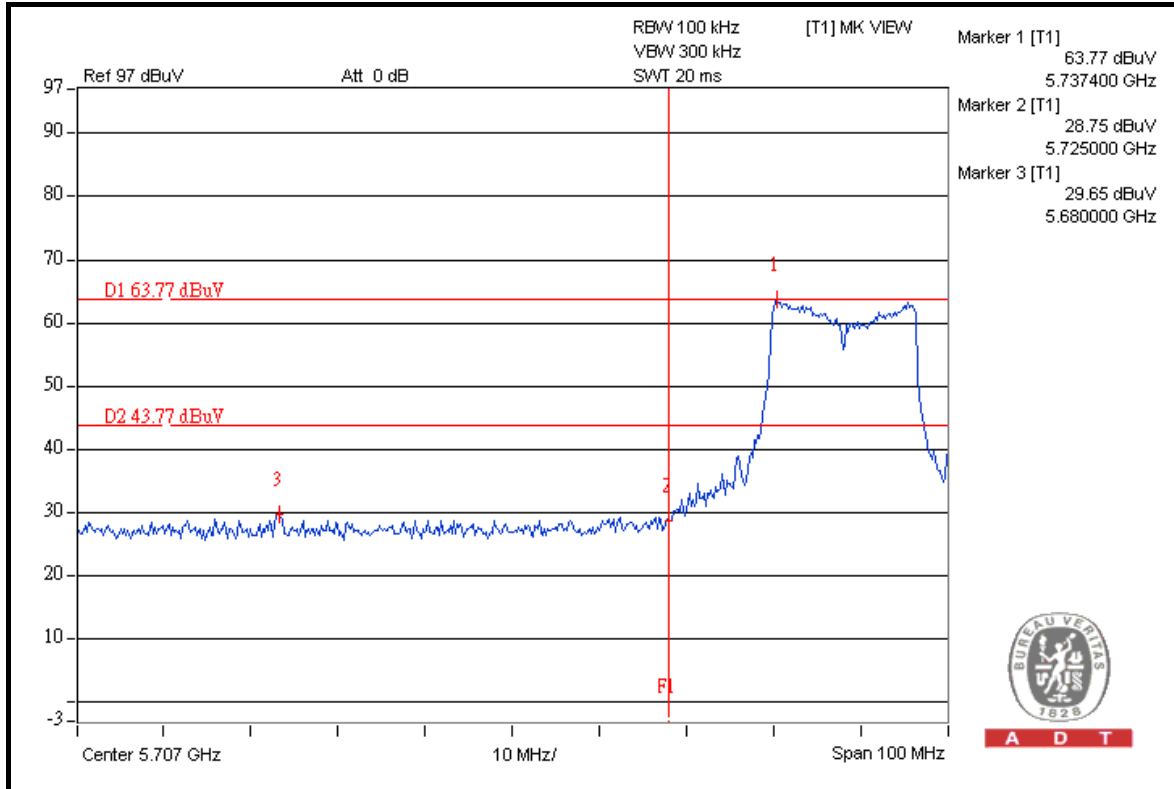



A D T

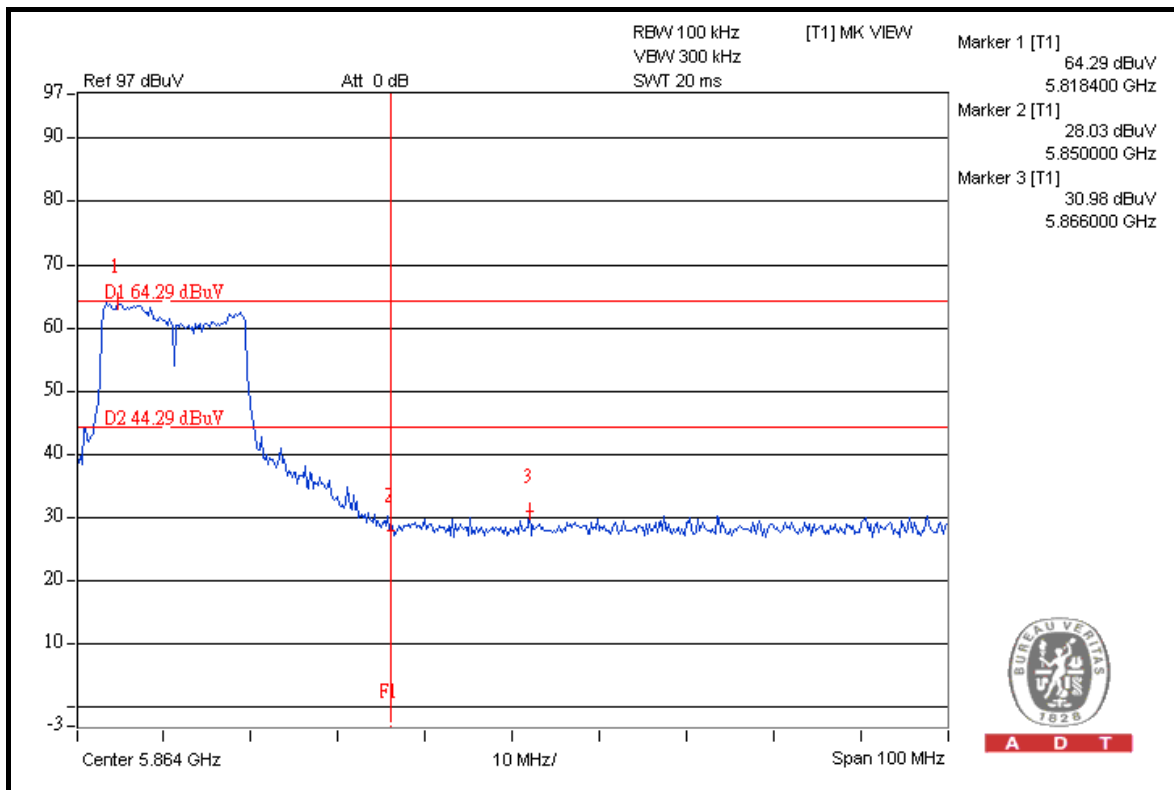
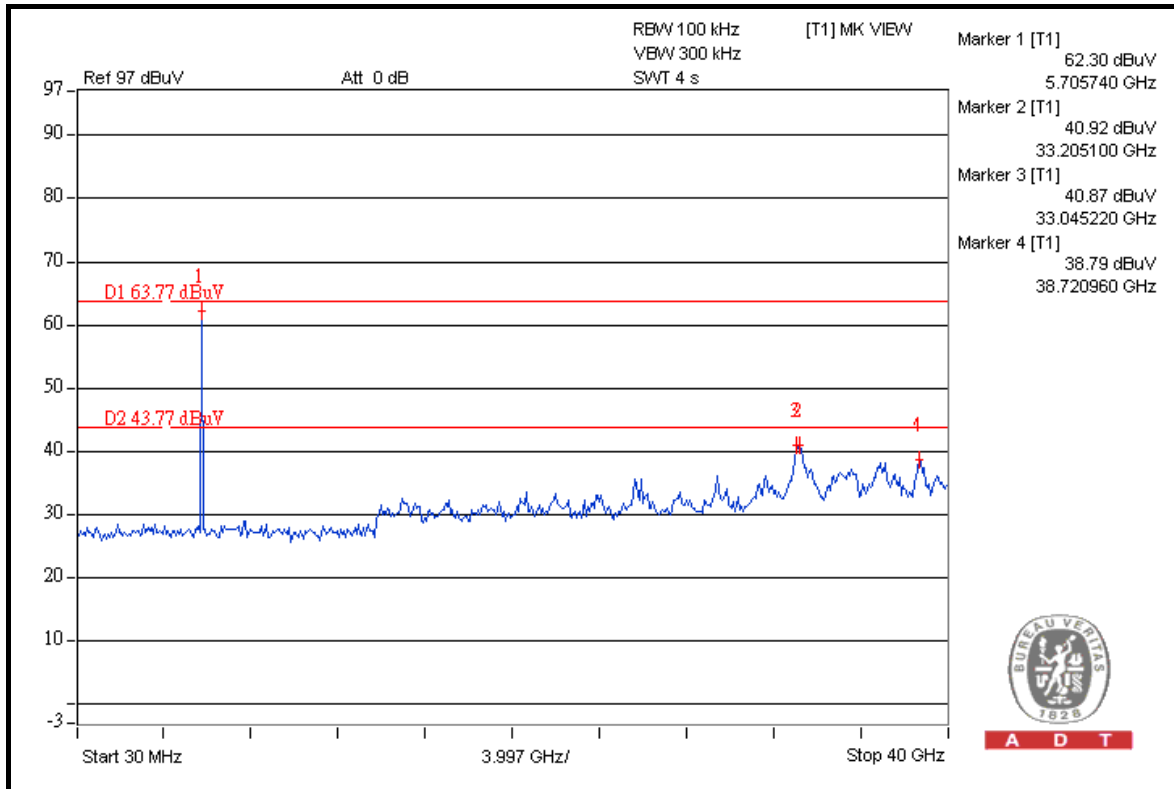



A D T

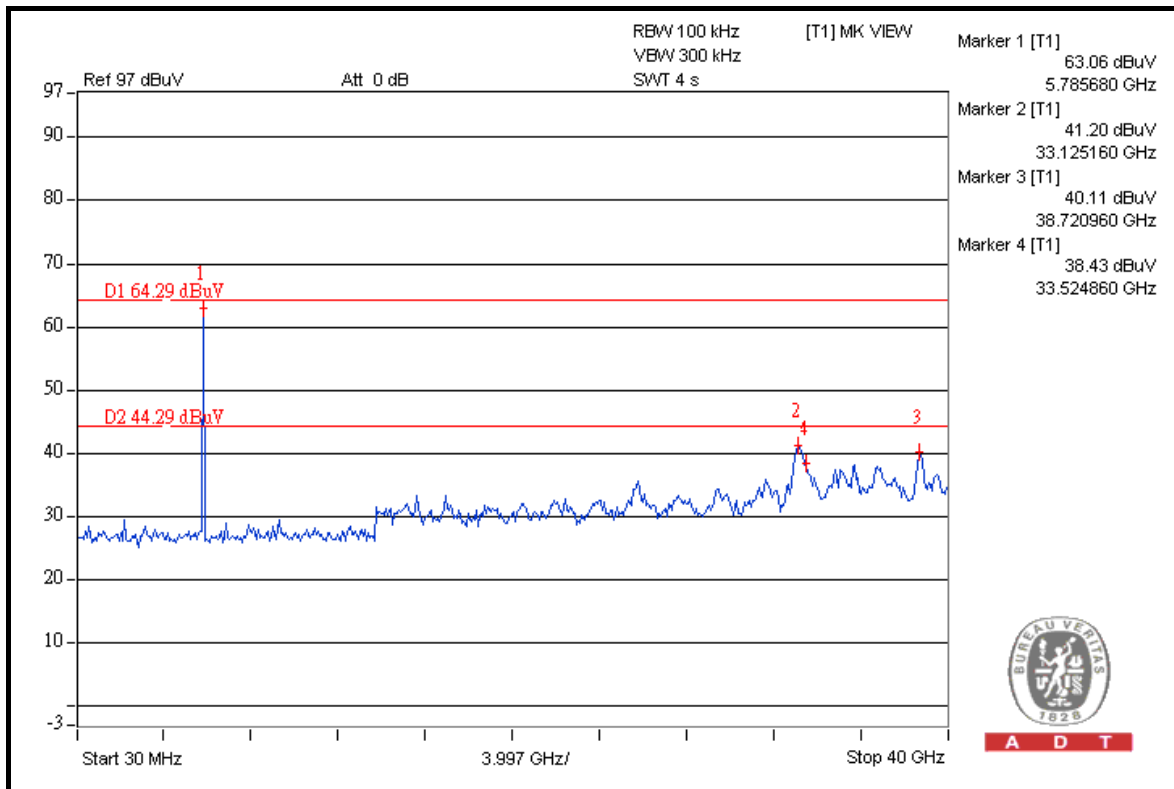
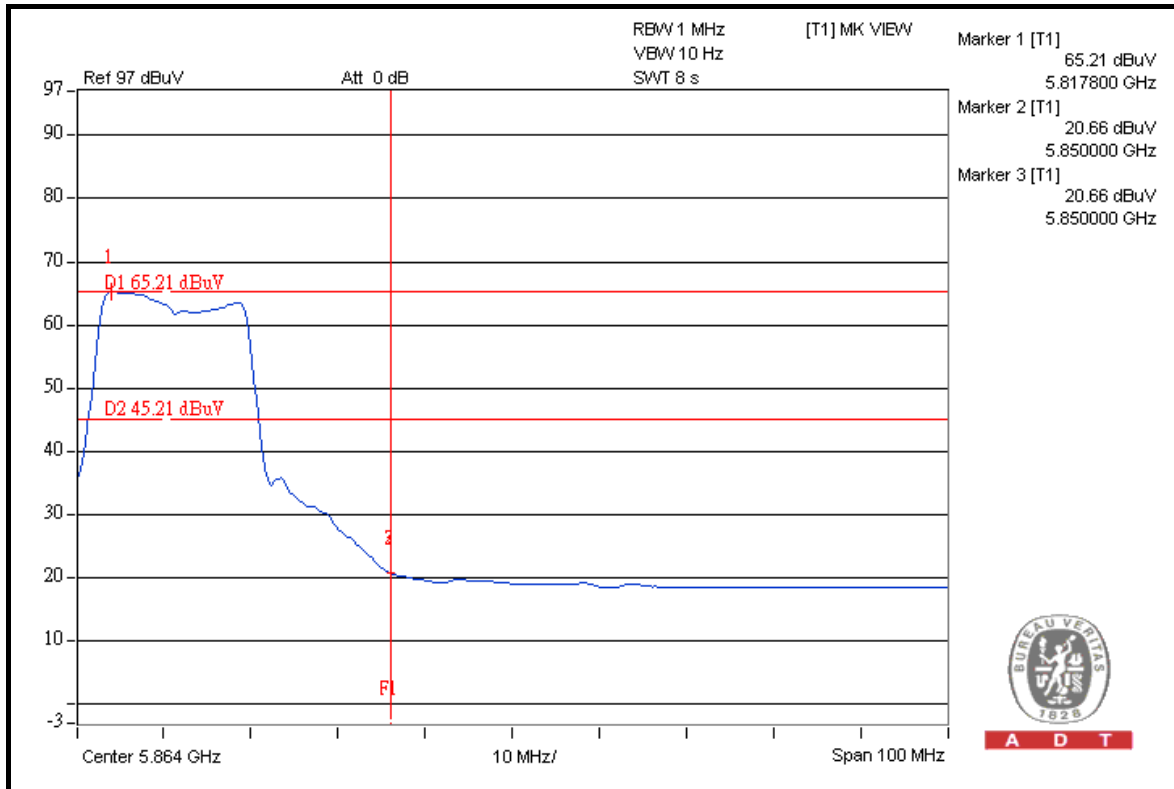



A D T

### DRAFT 802.11n (20MHz) OFDM MODULATION

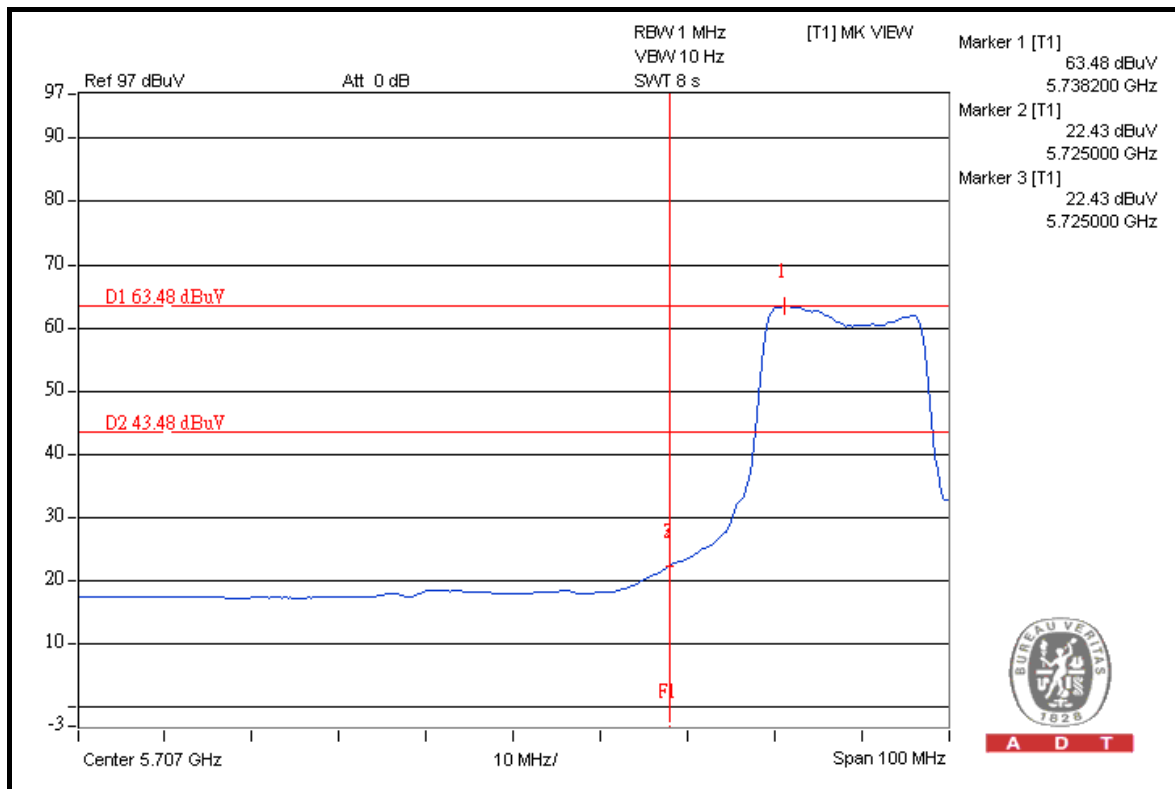
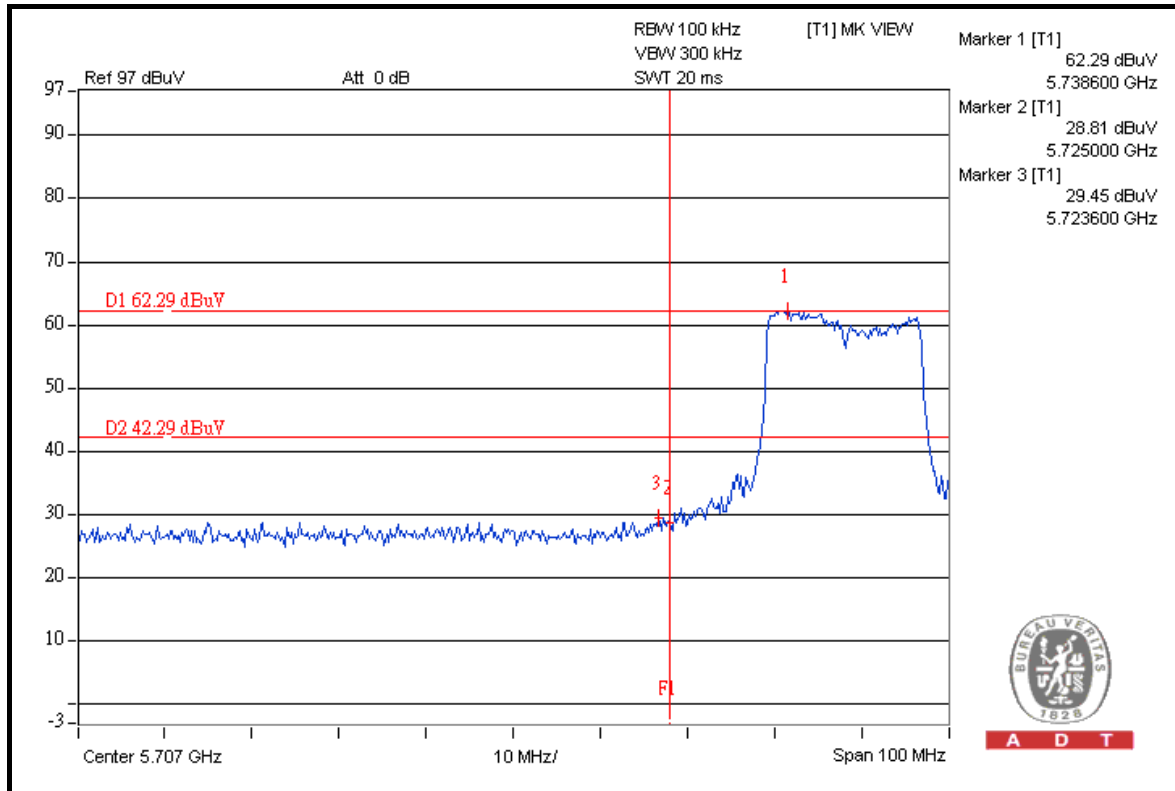



A D T

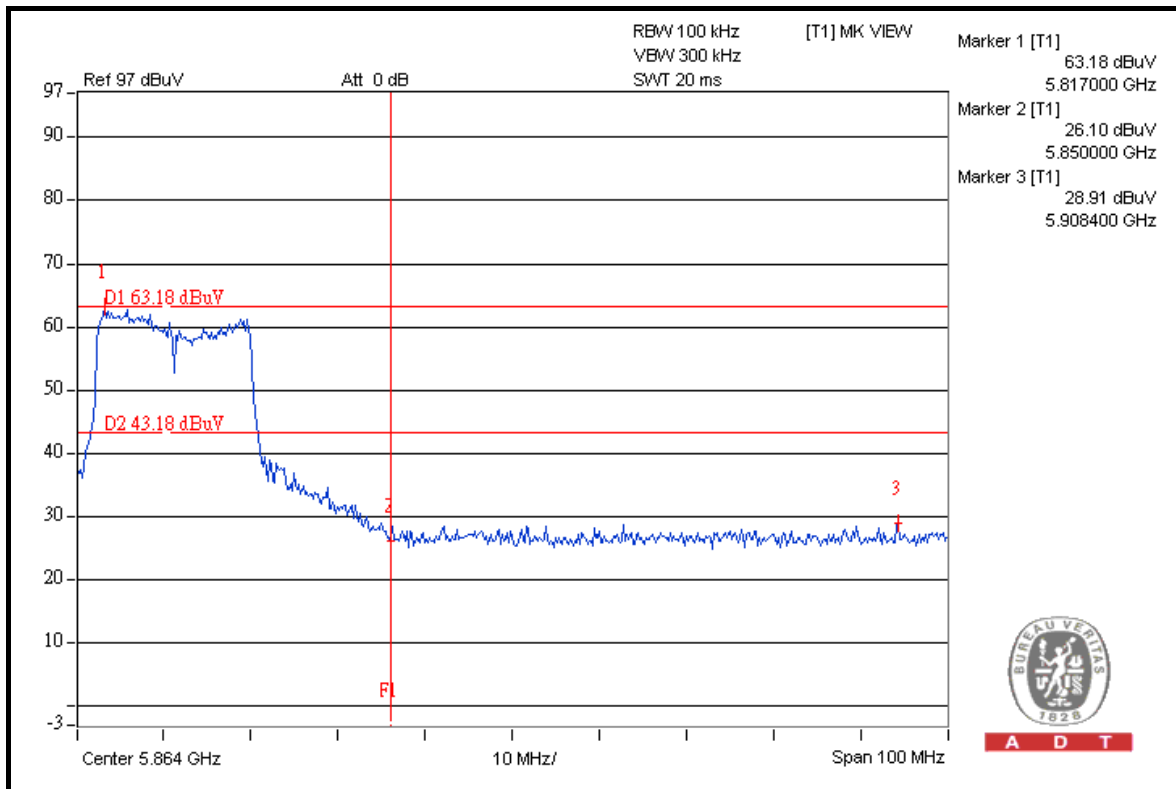
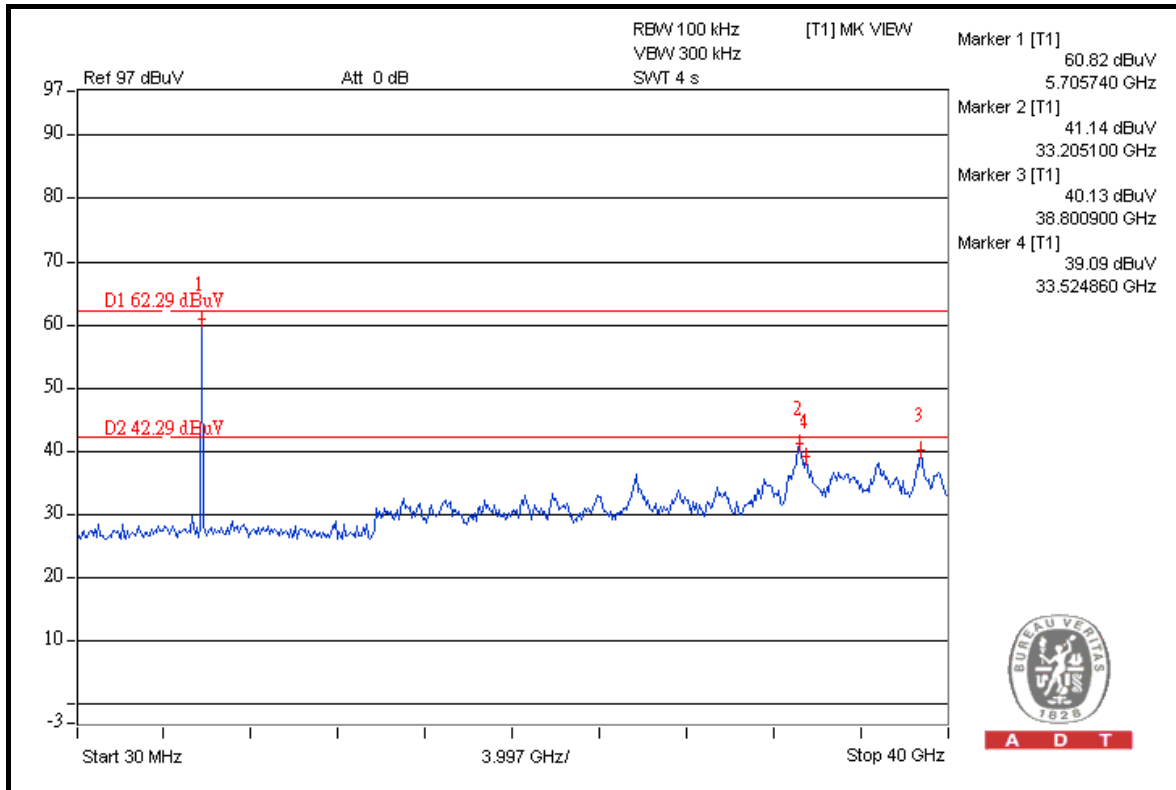





A D T

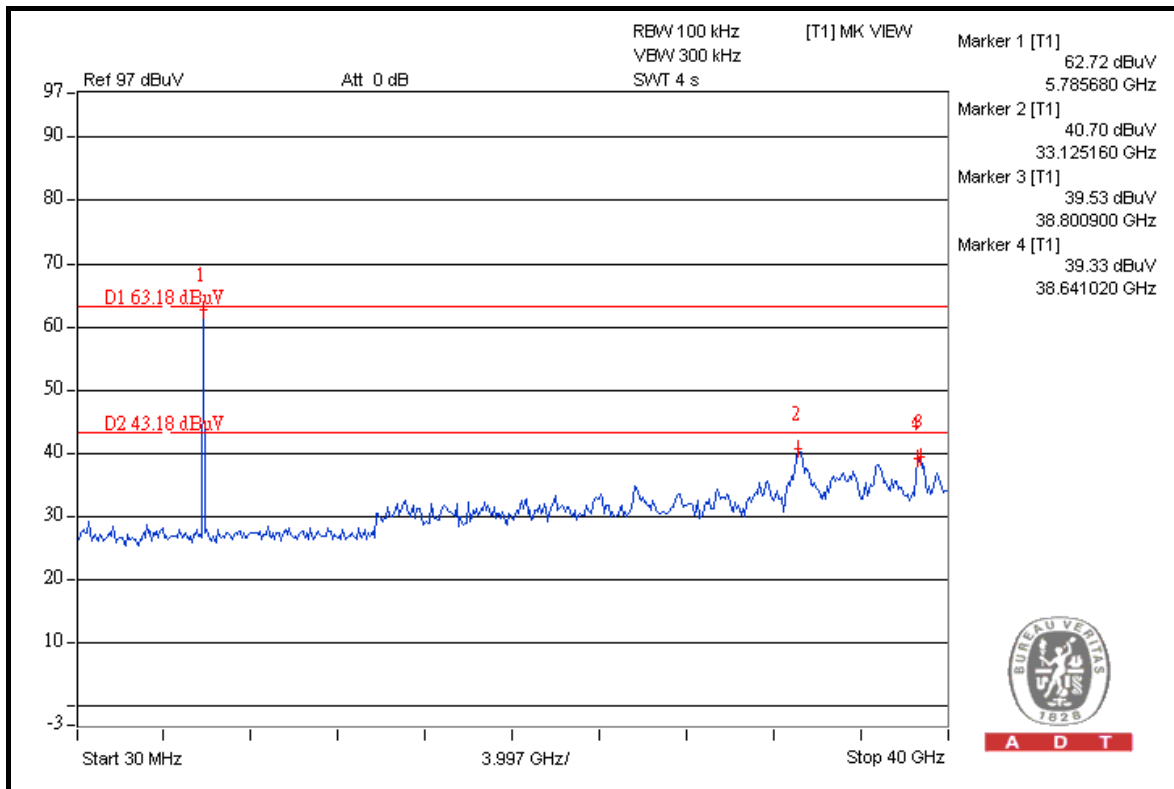
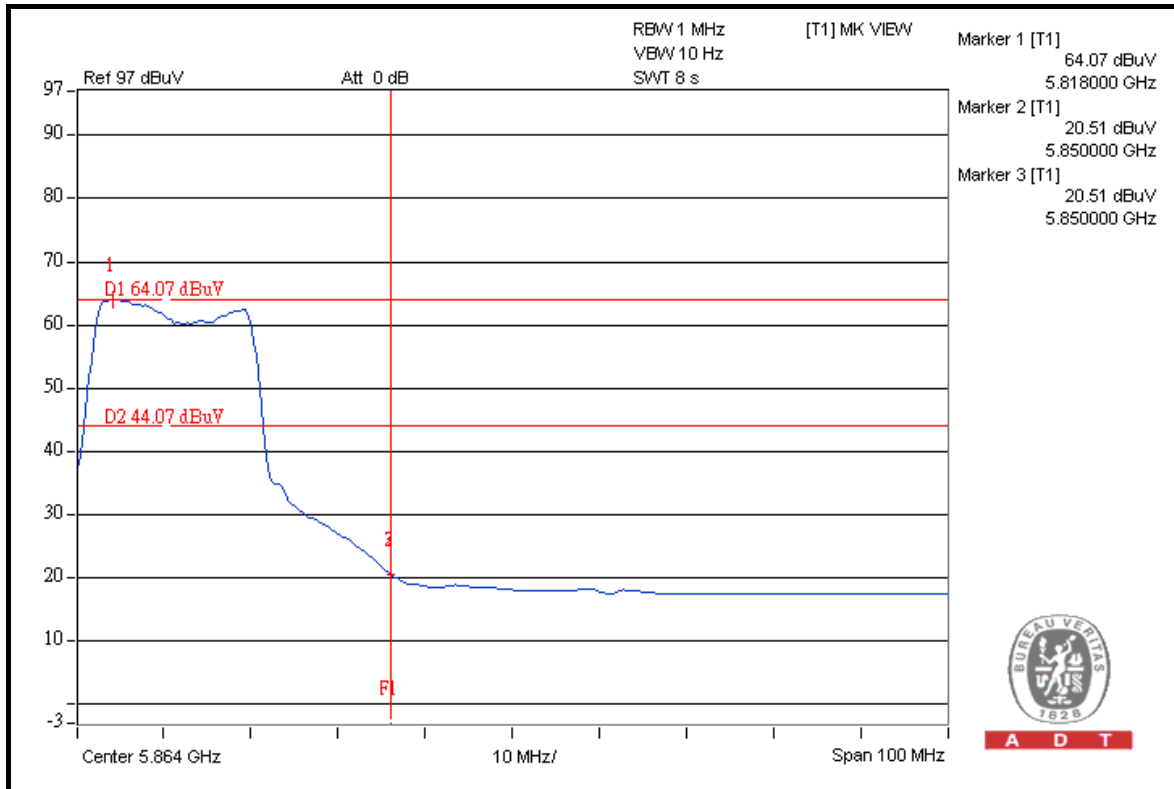



A D T

### DRAFT 802.11n (40MHz) OFDM MODULATION

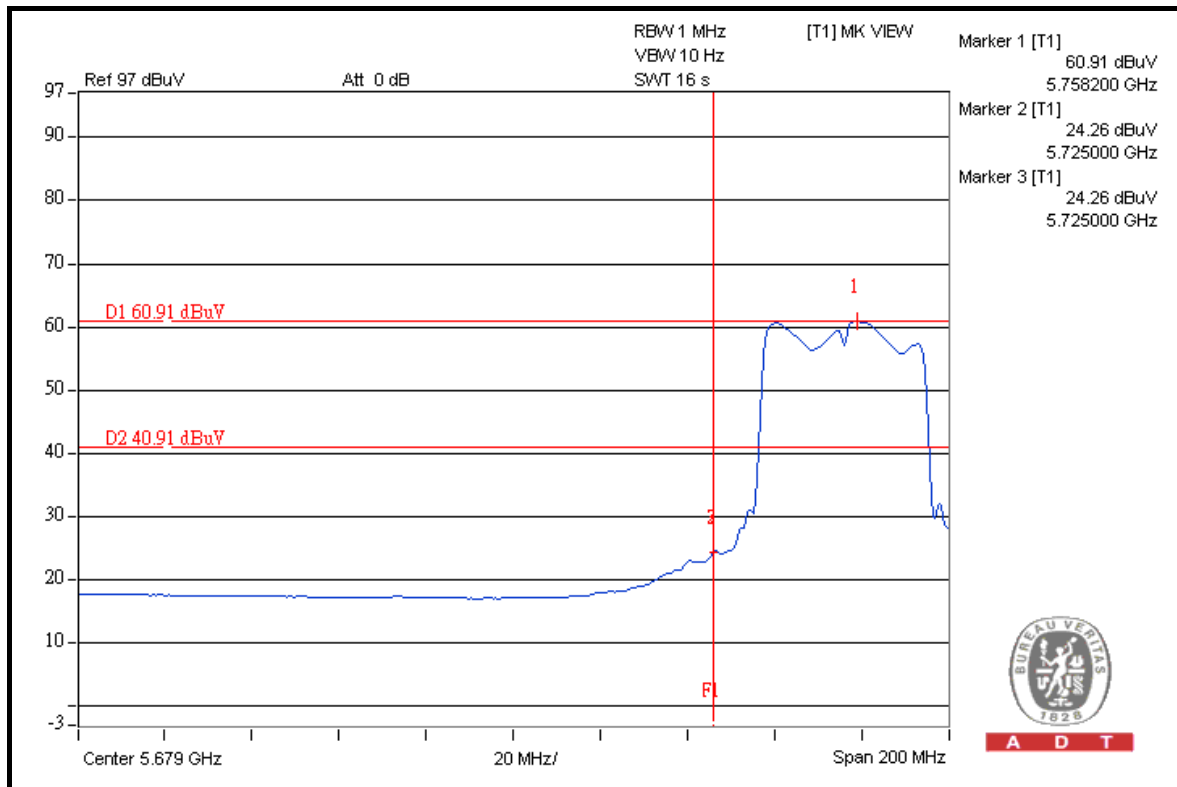
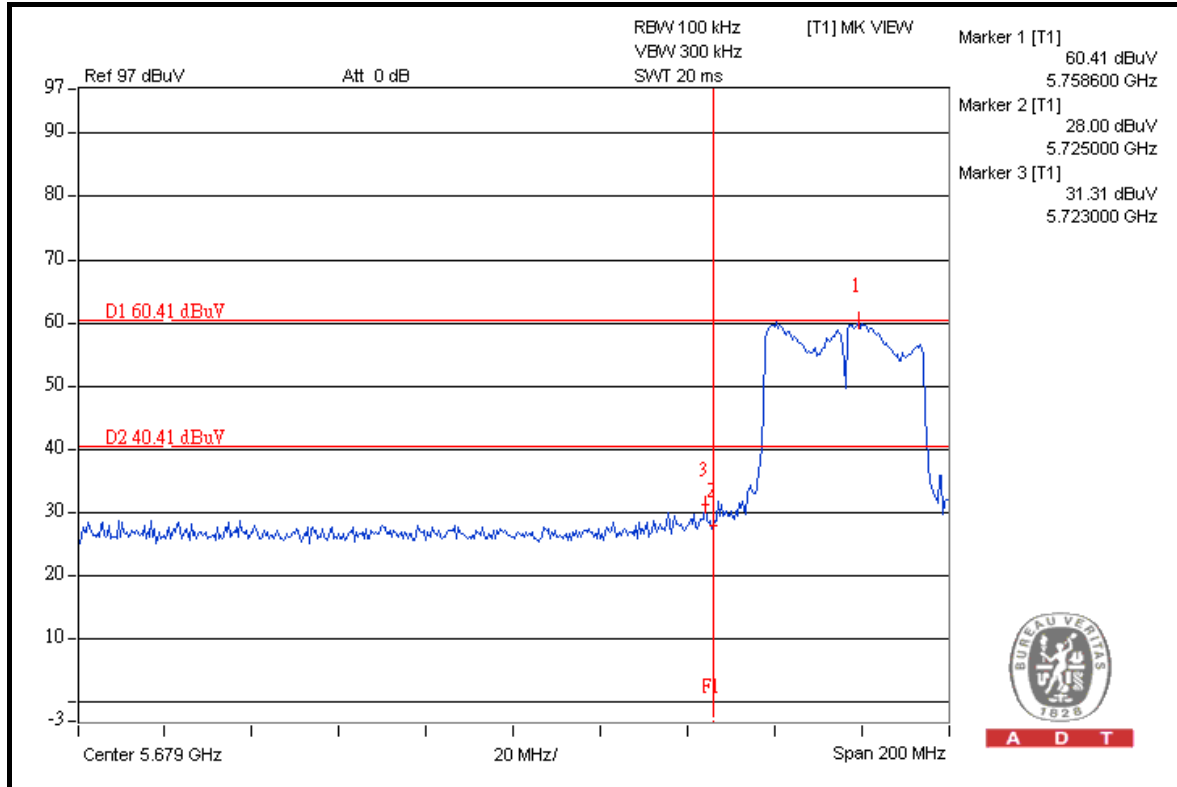



A D T

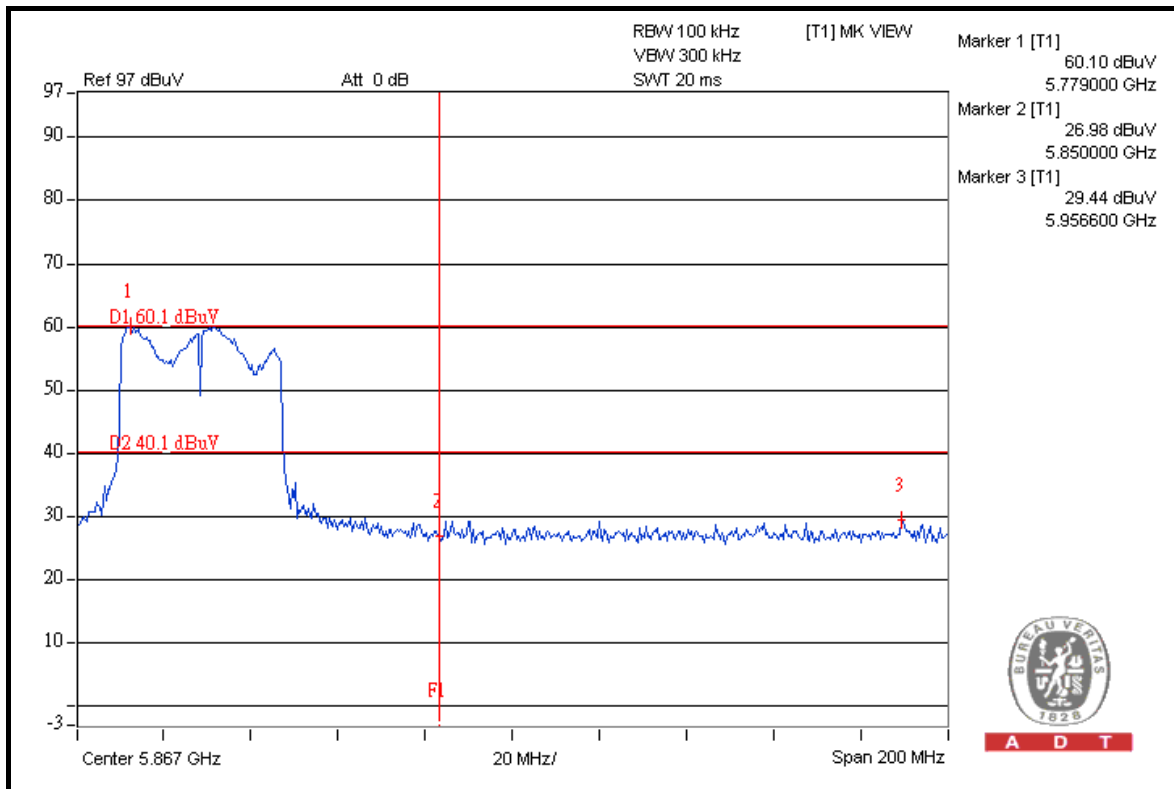
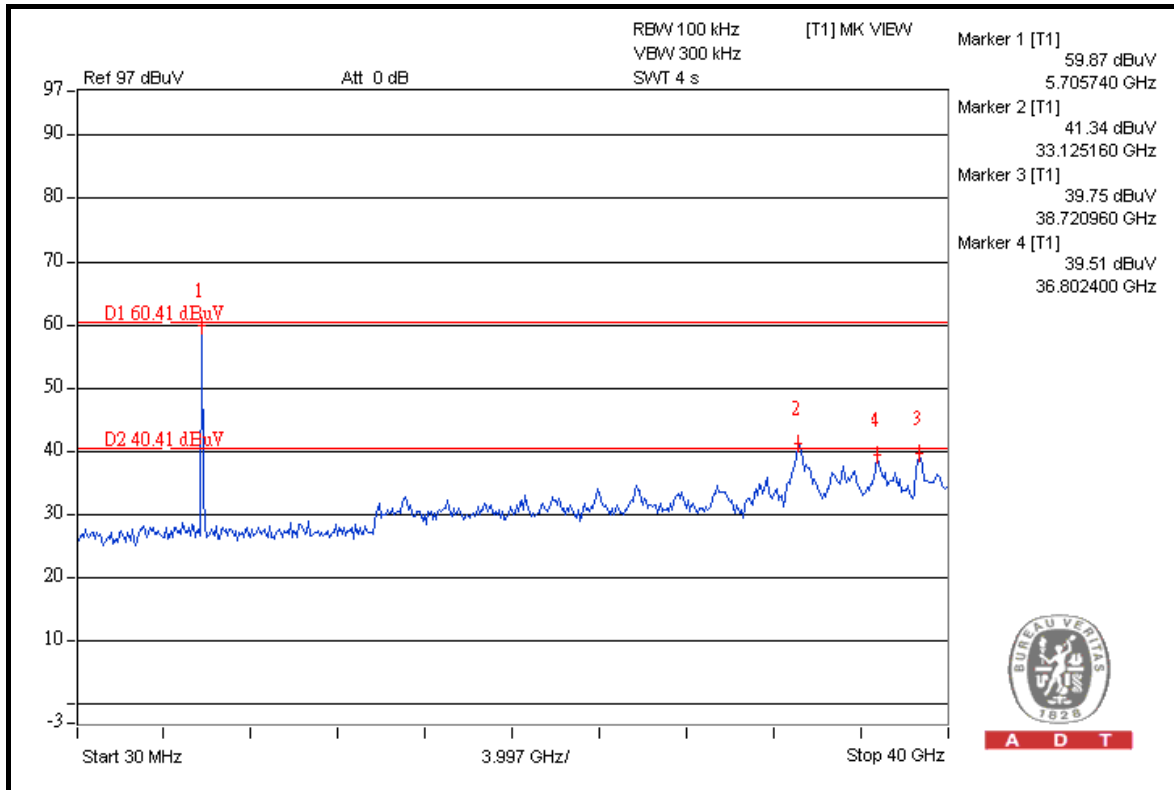



A D T

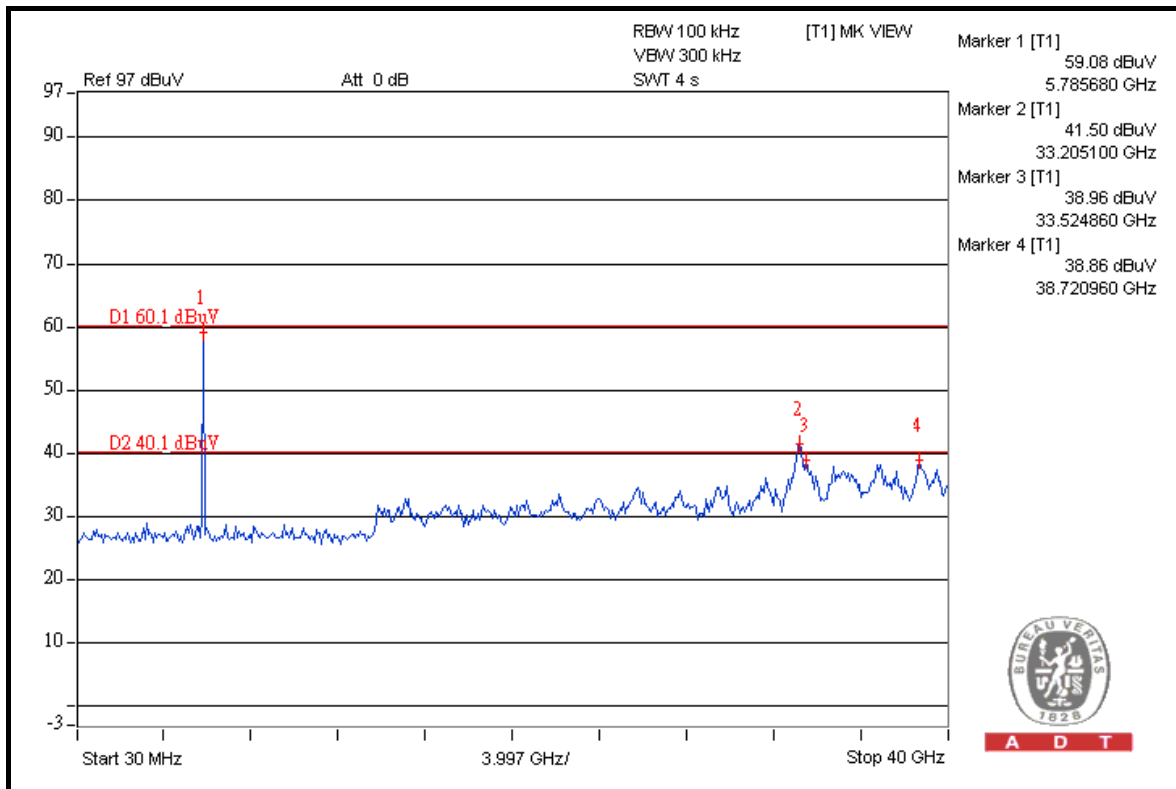
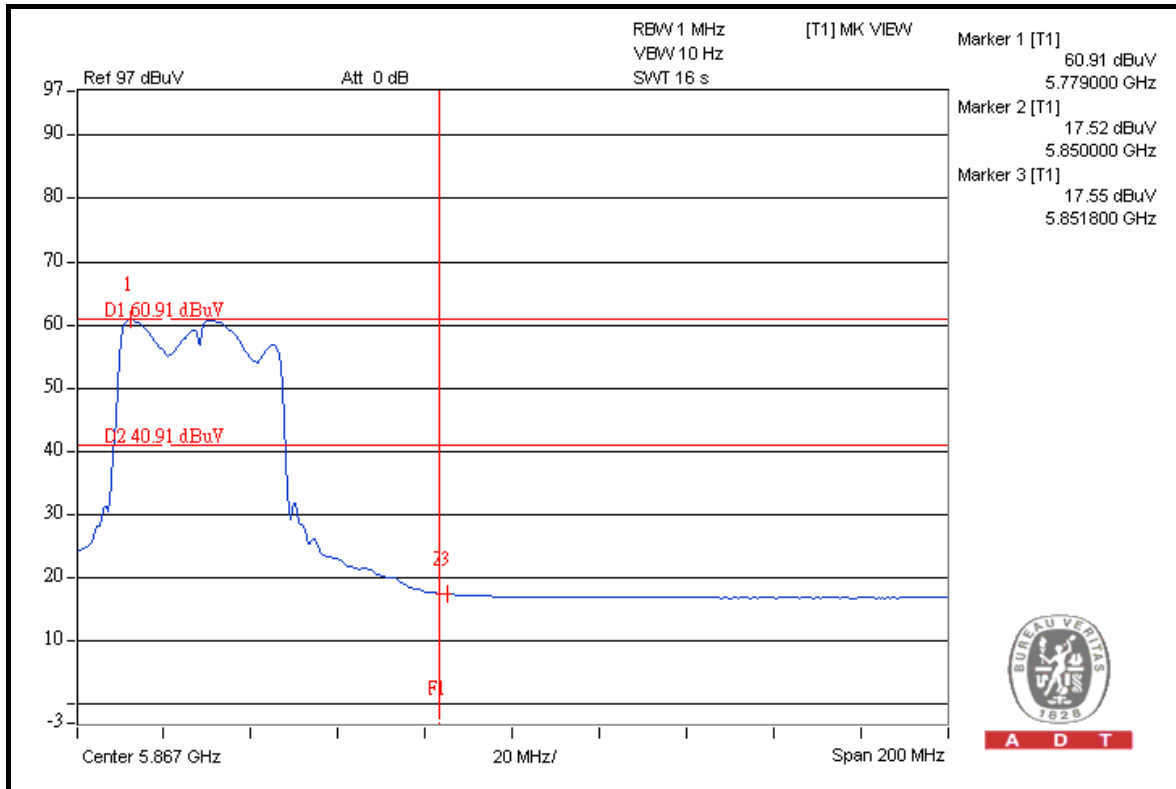



A D T

## 5.7 ANTENNA REQUIREMENT

### 5.7.1 STANDARD APPLICABLE

For intentional device, according to FCC 47 CFR Section 15.203, an intentional radiator shall be designed to ensure that no antenna other than that furnished by the responsible party shall be used with the device.

And according to FCC 47 CFR Section 15.247(a), if transmitting antennas of directional gain greater than 6dBi are used, the power shall be reduced by the amount in dB that the directional gain of the antenna exceeds 6dBi.

### 5.7.2 ANTENNA CONNECTED CONSTRUCTION

The antenna used in this product is Printed antenna without connector. The maximum gain of the antenna is 3.07dBi.



A D T

## 6. PHOTOGRAPHS OF THE TEST CONFIGURATION

Please refer to the attached file (Test Setup Photo).



A D T

## 7. INFORMATION ON THE TESTING LABORATORIES

We, Bureau Veritas Consumer Products Services (H.K.) Ltd., Taoyuan Branch, were founded in 1988 to provide our best service in EMC, Radio, Telecom and Safety consultation. Our laboratories are accredited and approved by the following approval agencies according to ISO/IEC 17025.

<b>USA</b>	FCC, NVLAP
<b>Germany</b>	TUV Rheinland
<b>Japan</b>	VCCI
<b>Norway</b>	NEMKO
<b>Canada</b>	INDUSTRY CANADA , CSA
<b>R.O.C.</b>	TAF, BSMI, NCC
<b>Netherlands</b>	Telefication
<b>Singapore</b>	GOST-ASIA(MOU)
<b>Russia</b>	CERTIS(MOU)

Copies of accreditation certificates of our laboratories obtained from approval agencies can be downloaded from our web site:

[www.adt.com.tw/index.5/phtml](http://www.adt.com.tw/index.5/phtml). If you have any comments, please feel free to contact us at the following:

**Linko EMC/RF Lab:**

Tel: 886-2-26052180

Fax: 886-2-26051924

**Hsin Chu EMC/RF Lab:**

Tel: 886-3-5935343

Fax: 886-3-5935342

**Hwa Ya EMC/RF/Safety Telecom Lab:**

Tel: 886-3-3183232

Fax: 886-3-3185050

**Web Site:** [www.adt.com.tw](http://www.adt.com.tw)

The address and road map of all our labs can be found in our web site also.



A D T

## **8. APPENDIX A - MODIFICATIONS RECORDERS FOR ENGINEERING CHANGES TO THE EUT BY THE LAB**

No any modifications are made to the EUT by the lab during the test.

**---END---**