



FCC TEST REPORT

REPORT NO.: RF970220L09A

MODEL NO.: TEW-641PC

RECEIVED: Feb. 20, 2008

TESTED: Mar. 18 ~ Mar. 22, 2008

ISSUED: Jun. 27, 2008

APPLICANT: TRENDware International Inc

ADDRESS: 20675 Manhattan Place, Torrance, CA 90501,
U.S.A.

ISSUED BY: Advance Data Technology Corporation

LAB ADDRESS: 47 14th Lin, Chiapau Tsun, Linko, Taipei, Taiwan,
R.O.C.

TEST LOCATION: No. 19, Hwa Ya 2nd Rd., Kueishan, Taoyuan,
Taiwan, R.O.C.

This test report consists of 77 pages in total. It may be duplicated completely for legal use with the approval of the applicant. It should not be reproduced except in full, without the written approval of our laboratory. The client should not use it to claim product endorsement by TAF, A2LA or any government agencies. The test results in the report only apply to the tested sample.





TABLE OF CONTENTS

1.	CERTIFICATION	4
2.	SUMMARY OF TEST RESULTS	5
2.1	MEASUREMENT UNCERTAINTY	5
3.	GENERAL INFORMATION	6
3.1	GENERAL DESCRIPTION OF EUT	6
3.2	DESCRIPTION OF TEST MODES	7
3.2.1	CONFIGURATION OF SYSTEM UNDER TEST	7
3.2.2	TEST MODE APPLICABILITY AND TESTED CHANNEL DETAIL	8
3.3	GENERAL DESCRIPTION OF APPLIED STANDARDS	10
3.4	DESCRIPTION OF SUPPORT UNITS	10
4.	TEST TYPES AND RESULTS	11
4.1	RADIATED EMISSION MEASUREMENT	11
4.1.1	LIMITS OF RADIATED EMISSION MEASUREMENT	11
4.1.2	TEST INSTRUMENTS	12
4.1.3	TEST PROCEDURES	13
4.1.4	DEVIATION FROM TEST STANDARD	13
4.1.5	TEST SETUP	14
4.1.6	EUT OPERATING CONDITIONS	14
4.1.7	TEST RESULTS	15
4.2	CONDUCTED EMISSION MEASUREMENT	28
4.2.1	LIMITS OF CONDUCTED EMISSION MEASUREMENT	28
4.2.2	TEST INSTRUMENTS	28
4.2.3	TEST PROCEDURES	29
4.2.4	DEVIATION FROM TEST STANDARD	29
4.2.5	TEST SETUP	30
4.2.6	EUT OPERATING CONDITIONS	30
4.2.7	TEST RESULTS	31
4.3	6dB BANDWIDTH MEASUREMENT	33
4.3.1	LIMITS OF 6dB BANDWIDTH MEASUREMENT	33
4.3.2	TEST INSTRUMENTS	33
4.3.3	TEST PROCEDURE	33
4.3.4	DEVIATION FROM TEST STANDARD	33
4.3.5	TEST SETUP	34
4.3.6	EUT OPERATING CONDITIONS	34
4.3.7	TEST RESULTS	35
4.4	MAXIMUM PEAK OUTPUT POWER	43



4.4.1	LIMITS OF MAXIMUM PEAK OUTPUT POWER MEASUREMENT	43
4.4.2	INSTRUMENTS.....	43
4.4.3	TEST PROCEDURES	43
4.4.4	DEVIATION FROM TEST STANDARD	43
4.4.5	TEST SETUP.....	44
4.4.6	EUT OPERATING CONDITIONS	44
4.4.7	TEST RESULTS	45
4.5	POWER SPECTRAL DENSITY MEASUREMENT	47
4.5.1	LIMITS OF POWER SPECTRAL DENSITY MEASUREMENT	47
4.5.2	TEST INSTRUMENTS.....	47
4.5.3	TEST PROCEDURE.....	47
4.5.4	DEVIATION FROM TEST STANDARD	47
4.5.5	TEST SETUP.....	48
4.5.6	EUT OPERATING CONDITION	48
4.5.7	TEST RESULTS	49
4.6	BAND EDGES MEASUREMENT.....	57
4.6.1	LIMITS OF BAND EDGES MEASUREMENT.....	57
4.6.2	TEST INSTRUMENTS.....	57
4.6.3	TEST PROCEDURE.....	57
4.6.4	DEVIATION FROM TEST STANDARD	57
4.6.5	EUT OPERATING CONDITION	57
4.6.6	TEST RESULTS	58
4.7	ANTENNA REQUIREMENT	74
4.7.1	STANDARD APPLICABLE	74
4.7.2	ANTENNA CONNECTED CONSTRUCTION	74
5.	PHOTOGRAPHS OF THE TEST CONFIGURATION.....	75
6.	INFORMATION ON THE TESTING LABORATORIES	76
7.	APPENDIX A - MODIFICATIONS RECORDERS FOR ENGINEERING CHANGES TO THE EUT BY THE LAB	77



1. CERTIFICATION

PRODUCT: 802.11n 2.0 Draft WLAN PC Card

MODEL: TEW-641PC

BRAND: TRENDnet

APPLICANT: TRENDware International Inc

TESTED: Mar. 18 ~ Mar. 22, 2008

TEST SAMPLE: ENGINEERING SAMPLE

STANDARDS: FCC Part 15, Subpart C (Section 15.247)

ANSI C63.4-2003

The above equipment (model: TEW-641PC) has been tested by **Advance Data Technology Corporation**, and found compliance with the requirement of the above standards. The test record, data evaluation & Equipment Under Test (EUT) configurations represented herein are true and accurate accounts of the measurements of the sample's EMC characteristics under the conditions specified in this report.

PREPARED BY :  , **DATE** : Jun. 27, 2008
Joanna Wang / Senior Specialist

TECHNICAL ACCEPTANCE :  , **DATE** : Jun. 27, 2008
Responsible for RF Long Chen / Senior Engineer

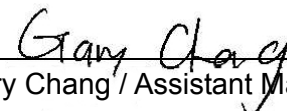
APPROVED BY :  , **DATE** : Jun. 27, 2008
Gary Chang / Assistant Manager

2. SUMMARY OF TEST RESULTS

The EUT has been tested according to the following specifications:

APPLIED STANDARD: FCC Part 15, Subpart C			
STANDARD SECTION	TEST TYPE AND LIMIT	RESULT	REMARK
15.207	AC Power Conducted Emission	PASS	Meet the requirement of limit. Minimum passing margin is -19.82dB at 0.205MHz.
15.247(a)(2)	Spectrum Bandwidth of a Direct Sequence Spread Spectrum System Limit : min. 500kHz	PASS	Meet the requirement of limit.
15.247(b)	Maximum Peak Output Power Limit: max. 30dBm	PASS	Meet the requirement of limit.
15.247(d)	Transmitter Radiated Emissions Limit: Table 15.209	PASS	Meet the requirement of limit. Minimum passing margin is -2.43dB at 154.330MHz.
15.247(e)	Power Spectral Density Limit: max. 8dBm	PASS	Meet the requirement of limit.
15.247(d)	Band Edge Measurement Limit: 20dB less than the peak value of fundamental frequency	PASS	Meet the requirement of limit.

2.1 MEASUREMENT UNCERTAINTY

Where relevant, the following measurement uncertainty levels have been estimated for tests performed on the EUT as specified in CISPR 16-4-2:

MEASUREMENT	FREQUENCY	UNCERTAINTY
Conducted emissions	9kHz ~ 30MHz	2.44 dB
Radiated emissions	30MHz ~ 200MHz	2.93 dB
	200MHz ~1000MHz	2.95 dB
	1GHz ~ 18GHz	2.26 dB
	18GHz ~ 40GHz	1.94 dB

This uncertainty represents an expanded uncertainty expressed at approximately the 95% confidence level using a coverage factor of $k = 2$.

3. GENERAL INFORMATION

3.1 GENERAL DESCRIPTION OF EUT

PRODUCT	802.11n 2.0 Draft WLAN PC Card
MODEL NO.	TEW-641PC
FCC ID	S9ZTEW641PC
POWER SUPPLY	3.3Vdc from host equipment
MODULATION TYPE	CCK, DQPSK, DBPSK for DSSS 64QAM, 16QAM, QPSK, BPSK for OFDM
MODULATION TECHNOLOGY	DSSS, OFDM
TRANSFER RATE	802.11b: 11/ 5.5/ 2/ 1Mbps 802.11g: 54/ 48/ 36/ 24/ 18/ 12/ 9/ 6Mbps Draft 802.11n: up to 135Mbps
FREQUENCY RANGE	2412MHz ~ 2462MHz
NUMBER OF CHANNEL	11 for 802.11b, 802.11g, draft 802.11n (20MHz) 7 for draft 802.11n (40MHz)
MAXIMUM OUTPUT POWER	50.816mW
ANTENNA TYPE	PIFA antenna with 1dBi gain Printed antenna (for receiver only)
DATA CABLE	NA
I/O PORTS	NA
ACCESSORY DEVICES	NA

NOTE:

1. This report is issued as a duplicate report to the original ADT report no.: RF970220L09. The EUT was identical to the original application one. The differences are changing the model name, brand name, product name and applicant due to marketing requirement.
2. The EUT incorporates a MIMO function. Physically, the EUT provides one completed transmitter and two receivers.

MODULATION MODE	TX FUNCTION
802.11b	1TX
802.11g	1TX
Draft 802.11n (20MHz)	1TX
Draft 802.11n (40MHz)	1TX

3. The above EUT information was declared by manufacturer and for more detailed features description, please refer to the manufacturer's specifications or user's manual.

3.2 DESCRIPTION OF TEST MODES

Eleven channels are provided for 802.11b, 802.11g and draft 802.11n (20MHz):

CHANNEL	FREQUENCY	CHANNEL	FREQUENCY
1	2412MHz	7	2442MHz
2	2417MHz	8	2447MHz
3	2422MHz	9	2452MHz
4	2427MHz	10	2457MHz
5	2432MHz	11	2462MHz
6	2437MHz		

Seven channels are provided for draft 802.11n (40MHz):

CHANNEL	FREQUENCY	CHANNEL	FREQUENCY
1	2422MHz	5	2442MHz
2	2427MHz	6	2447MHz
3	2432MHz	7	2452MHz
4	2437MHz		

3.2.1 CONFIGURATION OF SYSTEM UNDER TEST

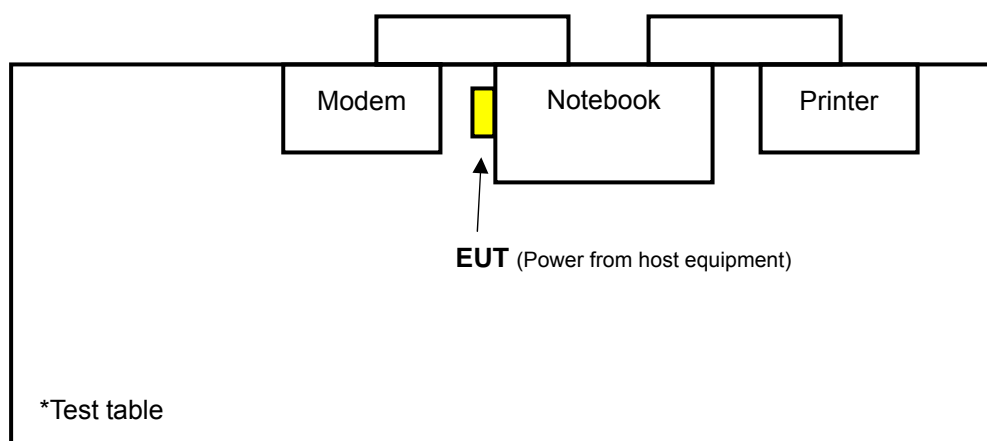

3.2.2 TEST MODE APPLICABILITY AND TESTED CHANNEL DETAIL

EUT CONFIGURE MODE	APPLICABLE TO				DESCRIPTION
	RE ≥ 1G	RE < 1G	PLC	APCM	
-	√	√	√	√	-

Where **RE ≥ 1G**: Radiated Emission above 1GHz

RE < 1G: Radiated Emission below 1GHz

PLC: Power Line Conducted Emission

APCM: Antenna Port Conducted Measurement

RADIATED EMISSION TEST (ABOVE 1 GHz):

- Pre-Scan has been conducted to determine the worst-case mode from all possible combinations between available modulations, data rates and antenna ports (if EUT with antenna diversity architecture).
- Following channel(s) was (were) selected for the final test as listed below.

MODE	AVAILABLE CHANNEL	TESTED CHANNEL	MODULATION TECHNOLOGY	MODULATION TYPE	DATA RATE (Mbps)
802.11b	1 to 11	1, 6, 11	DSSS	DBPSK	1.0
802.11g	1 to 11	1, 6, 11	OFDM	BPSK	6.0
Draft 802.11n (20MHz)	1 to 11	1, 6, 11	OFDM	BPSK	6.5
Draft 802.11n (40MHz)	1 to 7	1, 4, 7	OFDM	BPSK	13.5

RADIATED EMISSION TEST (BELOW 1 GHz):

- Pre-Scan has been conducted to determine the worst-case mode from all possible combinations between available modulations, data rates and antenna ports (if EUT with antenna diversity architecture).
- Following channel(s) was (were) selected for the final test as listed below.

MODE	AVAILABLE CHANNEL	TESTED CHANNEL	MODULATION TECHNOLOGY	MODULATION TYPE	DATA RATE (Mbps)
802.11b	1 to 11	11	DSSS	DBPSK	1.0



POWER LINE CONDUCTED EMISSION TEST:

- Pre-Scan has been conducted to determine the worst-case mode from all possible combinations between available modulations, data rates and antenna ports (if EUT with antenna diversity architecture).
- Following channel(s) was (were) selected for the final test as listed below.

MODE	AVAILABLE CHANNEL	TESTED CHANNEL	MODULATION TECHNOLOGY	MODULATION TYPE	DATA RATE (Mbps)
802.11b	1 to 11	11	DSSS	DBPSK	1.0

BANDEDGE MEASUREMENT:

- Pre-Scan has been conducted to determine the worst-case mode from all possible combinations between available modulations, data rates and antenna ports (if EUT with antenna diversity architecture).
- Following channel(s) was (were) selected for the final test as listed below.

MODE	AVAILABLE CHANNEL	TESTED CHANNEL	MODULATION TECHNOLOGY	MODULATION TYPE	DATA RATE (Mbps)
802.11b	1 to 11	1, 11	DSSS	DBPSK	1.0
802.11g	1 to 11	1, 11	OFDM	BPSK	6.0
Draft 802.11n (20MHz)	1 to 11	1, 11	OFDM	BPSK	6.5
Draft 802.11n (40MHz)	1 to 7	1, 7	OFDM	BPSK	13.5

ANTENNA PORT CONDUCTED MEASUREMENT:

- Pre-Scan has been conducted to determine the worst-case mode from all possible combinations between available modulations, data rates and antenna ports (if EUT with antenna diversity architecture).
- Following channel(s) was (were) selected for the final test as listed below.

MODE	AVAILABLE CHANNEL	TESTED CHANNEL	MODULATION TECHNOLOGY	MODULATION TYPE	DATA RATE (Mbps)
802.11b	1 to 11	1, 6, 11	DSSS	DBPSK	1.0
802.11g	1 to 11	1, 6, 11	OFDM	BPSK	6.0
Draft 802.11n (20MHz)	1 to 11	1, 6, 11	OFDM	BPSK	6.5
Draft 802.11n (40MHz)	1 to 7	1, 4, 7	OFDM	BPSK	13.5



3.3 GENERAL DESCRIPTION OF APPLIED STANDARDS

The EUT is a RF product. According to the specifications of the manufacturer, it must comply with the requirements of the following standards:

FCC Part 15, Subpart C (15.247)

ANSI C63.4-2003

All test items have been performed and recorded as per the above standards.

NOTE: The EUT is also considered as a kind of computer peripheral, because the connection to computer is necessary for typical use. It has been verified to comply with the requirements of FCC Part 15, Subpart B, Class B (DoC). The test report has been issued separately.

3.4 DESCRIPTION OF SUPPORT UNITS

The EUT has been tested as an independent unit together with other necessary accessories or support units. The following support units or accessories were used to form a representative test configuration during the tests.

NO.	PRODUCT	BRAND	MODEL NO.	SERIAL NO.	FCC ID
1	NOTEBOOK COMPUTER	DELL	PP05L	16484462992	E2K24CLNS
2	PRINTER	EPSON	LQ-300+	DCGY054147	FCC DoC Approved
3	MODEM	ACEEX	1414V/3	0401008269	IFAXDM1414

NO.	SIGNAL CABLE DESCRIPTION OF THE ABOVE SUPPORT UNITS
1	NA
2	1.8m braid shielded wire, DB25 connector, w/o core.
3	1.2m braid shielded wire, DB25 & DB9 connector, w/o core.

NOTE: All power cords of the above support units are non shielded (1.8m).

4. TEST TYPES AND RESULTS

4.1 RADIATED EMISSION MEASUREMENT

4.1.1 LIMITS OF RADIATED EMISSION MEASUREMENT

Emissions radiated outside of the specified bands, shall be according to the general radiated limits in 15.209 as following:

FREQUENCIES (MHz)	FIELD STRENGTH (microvolts/meter)	MEASUREMENT DISTANCE (meters)
0.009 ~ 0.490	2400 / F(kHz)	300
0.490 ~ 1.705	24000 / F(kHz)	30
1.705 ~ 30.0	30	30
30 ~ 88	100	3
88 ~ 216	150	3
216 ~ 960	200	3
Above 960	500	3

NOTE:

1. The lower limit shall apply at the transition frequencies.
2. Emission level (dBuV/m) = 20 log Emission level (uV/m).
3. As shown in 15.35(b), for frequencies above 1000MHz, the field strength limits are based on average detector, however, the peak field strength of any emission shall not exceed the maximum permitted average limits, specified above by more than 20dB under any condition of modulation.



4.1.2 TEST INSTRUMENTS

DESCRIPTION & MANUFACTURER	MODEL NO.	SERIAL NO.	CALIBRATED UNTIL
Test Receiver ROHDE & SCHWARZ	ESCI	100424	Jul. 27, 2008
Spectrum Analyzer ROHDE & SCHWARZ	FSP40	100269	Aug. 05, 2008
BILOG Antenna SCHWARZBECK	VULB9168	9168-153	Jan. 03, 2009
HORN Antenna SCHWARZBECK	BBHA 9120 D	9120D-563	Jul. 30, 2008
HORN Antenna SCHWARZBECK	BBHA 9170	BBHA9170242	Jan. 06, 2009
Preamplifier Agilent	8449B	3008A01910	Sep. 19, 2008
Preamplifier Agilent	8447D	2944A10638	Dec. 19, 2008
RF signal cable HUBER+SUHNNER	SUCOFLEX 104	274039/223650	Nov. 07, 2008
RF signal cable Worken	8D-FB	Cable-HYCH9-01	Aug. 09, 2008
Software	ADT_Radiated_V7.6	NA	NA
Antenna Tower EMCO	2070/2080	512.835.4684	NA
Turn Table EMCO	2087-2.03	NA	NA
Antenna Tower & Turn Table Controller EMCO	2090	NA	NA

- NOTE:**
1. The calibration interval of the above test instruments is 12 months and the calibrations are traceable to NML/ROC and NIST/USA.
 2. The test was performed in HwaYa Chamber 9.
 3. The horn antenna and HP preamplifier (model: 8449B) are used only for the measurement of emission frequency above 1GHz if tested.
 4. The FCC Site Registration No. is 215374.
 5. The IC Site Registration No. is IC3789B-9.

4.1.3 TEST PROCEDURES

- a. The EUT was placed on the top of a rotating table 0.8 meters above the ground at a 3 meters semi-anechoic chamber. The table was rotated 360 degrees to determine the position of the highest radiation.
- b. The EUT was set 3 meters away from the interference-receiving antenna, which was mounted on the top of a variable-height antenna tower.
- c. The antenna is a broadband antenna, and its height is varied from one meter to four meters above the ground to determine the maximum value of the field strength. Both horizontal and vertical polarizations of the antenna are set to make the measurement.
- d. For each suspected emission, the EUT was arranged to its worst case and then the antenna was tuned to heights from 1 meter to 4 meters and the rotatable table was turned from 0 degrees to 360 degrees to find the maximum reading.
- e. The test-receiver system was set to Peak Detect Function and Specified Bandwidth with Maximum Hold Mode.
- f. If the emission level of the EUT in peak mode was lower than the limit specified, then testing could be stopped and the peak values of the EUT would be reported. Otherwise the emissions would be re-tested one by one using peak, quasi-peak or average method as specified and then reported in a data sheet.

NOTE:

1. The resolution bandwidth and video bandwidth of test receiver/spectrum analyzer is 120kHz for Peak detection (PK) and Quasi-peak detection (QP) at frequency below 1GHz.
2. The resolution bandwidth of test receiver/spectrum analyzer is 1MHz and video bandwidth is 3MHz for Peak detection at frequency above 1GHz.
3. The resolution bandwidth of test receiver/spectrum analyzer is 1MHz and the video bandwidth is 10Hz for Average detection (AV) at frequency above 1GHz.
4. All modes of operation were investigated and the worst-case emissions are reported.

4.1.4 DEVIATION FROM TEST STANDARD

No deviation.

4.1.5 TEST SETUP

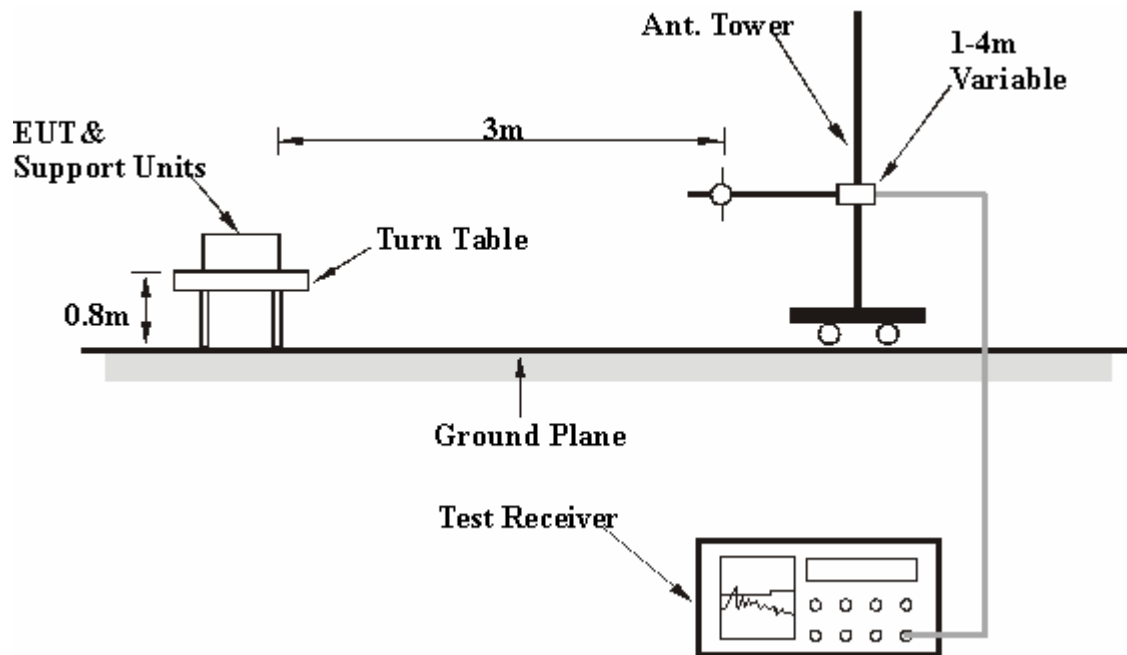

For the actual test configuration, please refer to the attached file (Test Setup Photo).

4.1.6 EUT OPERATING CONDITIONS

- Plugged EUT into the notebook system and placed on the testing table.
- The notebook system ran a test program (provided by manufacturer) to enable EUT under transmission condition continuously at specific channel frequency.
- The necessary accessories enable the EUT in full functions.

4.1.7 TEST RESULTS

802.11b DSSS MODULATION

EUT TEST CONDITION		MEASUREMENT DETAIL	
CHANNEL	Channel 1	FREQUENCY RANGE	1 ~ 25GHz
INPUT POWER (SYSTEM)	120Vac, 60 Hz	DETECTOR FUNCTION	Peak (PK) Average (AV)
ENVIRONMENTAL CONDITIONS	23deg. C, 69%RH 1015hPa	TESTED BY	Lori Chiu

ANTENNA POLARITY & TEST DISTANCE: HORIZONTAL AT 3 M								
NO.	FREQ. (MHz)	EMISSION LEVEL (dBuV/m)	LIMIT (dBuV/m)	MARGIN (dB)	ANTENNA HEIGHT (m)	TABLE ANGLE (Degree)	RAW VALUE (dBuV)	CORRECTION FACTOR (dB/m)
1	2386.00	58.64 PK	74.00	-15.36	1.28 H	300	26.32	32.32
2	2386.00	49.23 AV	54.00	-4.77	1.28 H	300	16.91	32.32
3	*2412.00	108.08 PK			1.28 H	301	75.76	32.32
4	*2412.00	103.75 AV			1.28 H	301	71.43	32.32
5	4824.00	48.14 PK	74.00	-25.86	1.00 H	356	10.14	38.00
6	4824.00	40.41 AV	54.00	-13.59	1.00 H	356	2.41	38.00
7	7236.00	59.00 PK	88.08	-29.08	1.53 H	2	14.12	44.88
8	7236.00	49.98 AV	83.75	-33.77	1.53 H	2	5.10	44.88
ANTENNA POLARITY & TEST DISTANCE: VERTICAL AT 3 M								
NO.	FREQ. (MHz)	EMISSION LEVEL (dBuV/m)	LIMIT (dBuV/m)	MARGIN (dB)	ANTENNA HEIGHT (m)	TABLE ANGLE (Degree)	RAW VALUE (dBuV)	CORRECTION FACTOR (dB/m)
1	2386.00	57.57 PK	74.00	-16.43	1.56 V	92	25.25	32.32
2	2386.00	46.63 AV	54.00	-7.37	1.56 V	92	14.31	32.32
3	*2412.00	104.97 PK			1.55 V	94	72.65	32.32
4	*2412.00	100.76 AV			1.55 V	94	68.44	32.32
5	4824.00	52.20 PK	74.00	-21.80	1.04 V	277	14.20	38.00
6	4824.00	48.47 AV	54.00	-5.53	1.04 V	277	10.47	38.00
7	7236.00	59.74 PK	84.97	-25.23	1.40 V	66	14.86	44.88
8	7236.00	51.70 AV	80.76	-29.06	1.40 V	66	6.82	44.88

- REMARKS:**
1. Emission level (dBuV/m) = Raw Value (dBuV) + Correction Factor (dB/m).
 2. Correction Factor (dB/m) = Antenna Factor (dB/m) + Cable Factor (dB).
 3. The other emission levels were very low against the limit.
 4. Margin value = Emission level – Limit value.
 5. “ * “: Fundamental frequency.

EUT TEST CONDITION		MEASUREMENT DETAIL	
CHANNEL	Channel 6	FREQUENCY RANGE	1 ~ 25GHz
INPUT POWER (SYSTEM)	120Vac, 60 Hz	DETECTOR FUNCTION	Peak (PK) Average (AV)
ENVIRONMENTAL CONDITIONS	23deg. C, 69%RH 1015hPa	TESTED BY	Lori Chiu

ANTENNA POLARITY & TEST DISTANCE: HORIZONTAL AT 3 M								
NO.	FREQ. (MHz)	EMISSION LEVEL (dBuV/m)	LIMIT (dBuV/m)	MARGIN (dB)	ANTENNA HEIGHT (m)	TABLE ANGLE (Degree)	RAW VALUE (dBuV)	CORRECTION FACTOR (dB/m)
1	2356.00	59.27 PK	74.00	-14.73	1.30 H	259	26.92	32.35
2	2356.00	48.05 AV	54.00	-5.95	1.30 H	259	15.70	32.35
3	*2437.00	108.73 PK			1.30 H	281	76.39	32.34
4	*2437.00	104.38 AV			1.30 H	281	72.04	32.34
5	4874.00	47.17 PK	74.00	-26.83	1.00 H	248	9.05	38.12
6	4874.00	37.25 AV	54.00	-16.75	1.00 H	248	-0.87	38.12
7	7311.00	56.74 PK	74.00	-17.26	1.32 H	285	11.78	44.97
8	7311.00	47.81 AV	54.00	-6.19	1.32 H	285	2.85	44.97
ANTENNA POLARITY & TEST DISTANCE: VERTICAL AT 3 M								
NO.	FREQ. (MHz)	EMISSION LEVEL (dBuV/m)	LIMIT (dBuV/m)	MARGIN (dB)	ANTENNA HEIGHT (m)	TABLE ANGLE (Degree)	RAW VALUE (dBuV)	CORRECTION FACTOR (dB/m)
1	*2437.00	104.76 PK			1.65 V	100	72.42	32.34
2	*2437.00	100.11 AV			1.65 V	100	67.77	32.34
3	4874.00	50.72 PK	74.00	-23.28	1.31 V	276	12.60	38.12
4	4874.00	46.13 AV	54.00	-7.87	1.31 V	276	8.01	38.12
5	7311.00	59.18 PK	74.00	-14.82	1.41 V	68	14.22	44.97
6	7311.00	51.45 AV	54.00	-2.55	1.41 V	68	6.49	44.97

- REMARKS:**
1. Emission level (dBuV/m) = Raw Value (dBuV) + Correction Factor (dB/m).
 2. Correction Factor (dB/m) = Antenna Factor (dB/m) + Cable Factor (dB).
 3. The other emission levels were very low against the limit.
 4. Margin value = Emission level – Limit value.
 5. “ * “: Fundamental frequency.

EUT TEST CONDITION		MEASUREMENT DETAIL	
CHANNEL	Channel 11	FREQUENCY RANGE	1 ~ 25GHz
INPUT POWER (SYSTEM)	120Vac, 60 Hz	DETECTOR FUNCTION	Peak (PK) Average (AV)
ENVIRONMENTAL CONDITIONS	23deg. C, 69%RH 1015hPa	TESTED BY	Lori Chiu

ANTENNA POLARITY & TEST DISTANCE: HORIZONTAL AT 3 M								
NO.	FREQ. (MHz)	EMISSION LEVEL (dBuV/m)	LIMIT (dBuV/m)	MARGIN (dB)	ANTENNA HEIGHT (m)	TABLE ANGLE (Degree)	RAW VALUE (dBuV)	CORRECTION FACTOR (dB/m)
1	2300.00	60.59 PK	74.00	-13.41	1.35 H	301	28.19	32.40
2	2300.00	50.88 AV	54.00	-3.12	1.35 H	301	18.48	32.40
3	2381.00	60.86 PK	74.00	-13.14	1.29 H	301	28.53	32.33
4	2381.00	50.23 AV	54.00	-3.77	1.29 H	301	17.90	32.33
5	*2462.00	108.53 PK			1.29 H	278	76.16	32.37
6	*2462.00	104.07 AV			1.29 H	278	71.70	32.37
7	2487.00	59.50 PK	74.00	-14.50	1.32 H	283	27.11	32.39
8	2487.00	50.26 AV	54.00	-3.74	1.32 H	283	17.87	32.39
9	4924.00	51.15 PK	74.00	-22.85	1.49 H	24	12.92	38.23
10	4924.00	46.14 AV	54.00	-7.86	1.49 H	24	7.91	38.23
11	7386.00	55.17 PK	74.00	-18.83	1.51 H	261	10.15	45.03
12	7386.00	44.09 AV	54.00	-9.91	1.51 H	261	-0.93	45.03
ANTENNA POLARITY & TEST DISTANCE: VERTICAL AT 3 M								
NO.	FREQ. (MHz)	EMISSION LEVEL (dBuV/m)	LIMIT (dBuV/m)	MARGIN (dB)	ANTENNA HEIGHT (m)	TABLE ANGLE (Degree)	RAW VALUE (dBuV)	CORRECTION FACTOR (dB/m)
1	*2462.00	104.87 PK			1.84 V	97	72.50	32.37
2	*2462.00	100.39 AV			1.84 V	97	68.02	32.37
3	2487.00	58.56 PK	74.00	-15.44	1.81 V	91	26.17	32.39
4	2487.00	46.69 AV	54.00	-7.31	1.81 V	91	14.30	32.39
5	4924.00	53.07 PK	74.00	-20.93	1.27 V	83	14.84	38.23
6	4924.00	49.89 AV	54.00	-4.11	1.27 V	83	11.66	38.23
7	7386.00	57.32 PK	74.00	-16.68	1.42 V	68	12.30	45.03
8	7386.00	48.10 AV	54.00	-5.90	1.42 V	68	3.08	45.03

- REMARKS:**
1. Emission level (dBuV/m) = Raw Value (dBuV) + Correction Factor (dB/m).
 2. Correction Factor (dB/m) = Antenna Factor (dB/m) + Cable Factor (dB).
 3. The other emission levels were very low against the limit.
 4. Margin value = Emission level – Limit value.
 5. “ * “: Fundamental frequency.

802.11g OFDM MODULATION

EUT TEST CONDITION		MEASUREMENT DETAIL	
CHANNEL	Channel 1	FREQUENCY RANGE	1 ~ 25GHz
INPUT POWER (SYSTEM)	120Vac, 60 Hz	DETECTOR FUNCTION	Peak (PK) Average (AV)
ENVIRONMENTAL CONDITIONS	23deg. C, 69%RH 1015hPa	TESTED BY	Lori Chiu

ANTENNA POLARITY & TEST DISTANCE: HORIZONTAL AT 3 M								
NO.	FREQ. (MHz)	EMISSION LEVEL (dBuV/m)	LIMIT (dBuV/m)	MARGIN (dB)	ANTENNA HEIGHT (m)	TABLE ANGLE (Degree)	RAW VALUE (dBuV)	CORRECTION FACTOR (dB/m)
1	2390.00	66.91 PK	74.00	-7.09	1.30 H	302	34.59	32.32
2	2390.00	49.13 AV	54.00	-4.87	1.30 H	302	16.81	32.32
3	*2412.00	108.17 PK			1.32 H	281	75.85	32.32
4	*2412.00	97.98 AV			1.32 H	281	65.66	32.32
5	4824.00	46.71 PK	74.00	-27.29	1.13 H	208	8.71	38.00
6	4824.00	33.39 AV	54.00	-20.61	1.13 H	208	-4.61	38.00
ANTENNA POLARITY & TEST DISTANCE: VERTICAL AT 3 M								
NO.	FREQ. (MHz)	EMISSION LEVEL (dBuV/m)	LIMIT (dBuV/m)	MARGIN (dB)	ANTENNA HEIGHT (m)	TABLE ANGLE (Degree)	RAW VALUE (dBuV)	CORRECTION FACTOR (dB/m)
1	2390.00	66.25 PK	74.00	-7.75	1.19 V	59	33.93	32.32
2	2390.00	47.62 AV	54.00	-6.38	1.19 V	59	15.30	32.32
3	*2412.00	106.27 PK			1.19 V	58	73.95	32.32
4	*2412.00	96.02 AV			1.19 V	58	63.70	32.32
5	4824.00	50.22 PK	74.00	-23.78	1.18 V	85	12.22	38.00
6	4824.00	36.38 AV	54.00	-17.62	1.18 V	85	-1.62	38.00

- REMARKS:**
1. Emission level (dBuV/m) = Raw Value (dBuV) + Correction Factor (dB/m).
 2. Correction Factor (dB/m) = Antenna Factor (dB/m) + Cable Factor (dB).
 3. The other emission levels were very low against the limit.
 4. Margin value = Emission level – Limit value.
 5. “ * “: Fundamental frequency.

EUT TEST CONDITION		MEASUREMENT DETAIL	
CHANNEL	Channel 6	FREQUENCY RANGE	1 ~ 25GHz
INPUT POWER (SYSTEM)	120Vac, 60 Hz	DETECTOR FUNCTION	Peak (PK) Average (AV)
ENVIRONMENTAL CONDITIONS	23deg. C, 69%RH 1015hPa	TESTED BY	Lori Chiu

ANTENNA POLARITY & TEST DISTANCE: HORIZONTAL AT 3 M								
NO.	FREQ. (MHz)	EMISSION LEVEL (dBuV/m)	LIMIT (dBuV/m)	MARGIN (dB)	ANTENNA HEIGHT (m)	TABLE ANGLE (Degree)	RAW VALUE (dBuV)	CORRECTION FACTOR (dB/m)
1	2390.00	57.26 PK	74.00	-16.74	1.28 H	277	24.94	32.32
2	2390.00	46.03 AV	54.00	-7.97	1.28 H	277	13.71	32.32
3	*2437.00	108.04 PK			1.28 H	279	75.70	32.34
4	*2437.00	97.84 AV			1.28 H	279	65.50	32.34
5	2483.50	58.05 PK	74.00	-15.95	1.28 H	279	25.66	32.39
6	2483.50	46.21 AV	54.00	-7.79	1.28 H	279	13.82	32.39
7	4874.00	45.66 PK	74.00	-28.34	1.41 H	153	7.54	38.12
8	4874.00	33.28 AV	54.00	-20.72	1.41 H	153	-4.84	38.12
ANTENNA POLARITY & TEST DISTANCE: VERTICAL AT 3 M								
NO.	FREQ. (MHz)	EMISSION LEVEL (dBuV/m)	LIMIT (dBuV/m)	MARGIN (dB)	ANTENNA HEIGHT (m)	TABLE ANGLE (Degree)	RAW VALUE (dBuV)	CORRECTION FACTOR (dB/m)
1	2390.00	57.08 PK	74.00	-16.92	1.05 V	61	24.76	32.32
2	2390.00	45.89 AV	54.00	-8.11	1.05 V	61	13.57	32.32
3	*2437.00	106.89 PK			1.06 V	61	74.55	32.34
4	*2437.00	97.26 AV			1.06 V	61	64.92	32.34
5	2483.50	57.22 PK	74.00	-16.78	1.08 V	60	24.83	32.39
6	2483.50	46.00 AV	54.00	-8.00	1.08 V	60	13.61	32.39
7	4874.00	47.99 PK	74.00	-26.01	1.39 V	83	9.87	38.12
8	4874.00	34.61 AV	54.00	-19.39	1.39 V	83	-3.51	38.12

- REMARKS:**
1. Emission level (dBuV/m) = Raw Value (dBuV) + Correction Factor (dB/m).
 2. Correction Factor (dB/m) = Antenna Factor (dB/m) + Cable Factor (dB).
 3. The other emission levels were very low against the limit.
 4. Margin value = Emission level – Limit value.
 5. “ * “: Fundamental frequency.



EUT TEST CONDITION		MEASUREMENT DETAIL	
CHANNEL	Channel 11	FREQUENCY RANGE	1 ~ 25GHz
INPUT POWER (SYSTEM)	120Vac, 60 Hz	DETECTOR FUNCTION	Peak (PK) Average (AV)
ENVIRONMENTAL CONDITIONS	23deg. C, 69%RH 1015hPa	TESTED BY	Lori Chiu

ANTENNA POLARITY & TEST DISTANCE: HORIZONTAL AT 3 M								
NO.	FREQ. (MHz)	EMISSION LEVEL (dBuV/m)	LIMIT (dBuV/m)	MARGIN (dB)	ANTENNA HEIGHT (m)	TABLE ANGLE (Degree)	RAW VALUE (dBuV)	CORRECTION FACTOR (dB/m)
1	*2462.00	108.06 PK			1.29 H	280	75.69	32.37
2	*2462.00	96.70 AV			1.29 H	280	64.33	32.37
3	2483.50	66.26 PK	74.00	-7.74	1.27 H	283	33.87	32.39
4	2483.50	50.34 AV	54.00	-3.66	1.27 H	283	17.95	32.39
5	4924.00	45.51 PK	74.00	-28.49	1.13 H	208	7.28	38.23
6	4924.00	32.48 AV	54.00	-21.52	1.13 H	208	-5.75	38.23
ANTENNA POLARITY & TEST DISTANCE: VERTICAL AT 3 M								
NO.	FREQ. (MHz)	EMISSION LEVEL (dBuV/m)	LIMIT (dBuV/m)	MARGIN (dB)	ANTENNA HEIGHT (m)	TABLE ANGLE (Degree)	RAW VALUE (dBuV)	CORRECTION FACTOR (dB/m)
1	*2462.00	106.54 PK			1.08 V	60	74.17	32.37
2	*2462.00	96.65 AV			1.08 V	60	64.28	32.37
3	2483.50	64.24 PK	74.00	-9.76	1.08 V	60	31.85	32.39
4	2483.50	47.38 AV	54.00	-6.62	1.08 V	60	14.99	32.39
5	4924.00	48.38 PK	74.00	-25.62	1.16 V	268	10.15	38.23
6	4924.00	35.59 AV	54.00	-18.41	1.16 V	268	-2.64	38.23

- REMARKS:**
1. Emission level (dBuV/m) = Raw Value (dBuV) + Correction Factor (dB/m).
 2. Correction Factor (dB/m) = Antenna Factor (dB/m) + Cable Factor (dB).
 3. The other emission levels were very low against the limit.
 4. Margin value = Emission level – Limit value.
 5. “ * “: Fundamental frequency.

DRAFT 802.11n (20MHz) OFDM MODULATION

EUT TEST CONDITION		MEASUREMENT DETAIL	
CHANNEL	Channel 1	FREQUENCY RANGE	1 ~ 25GHz
INPUT POWER (SYSTEM)	120Vac, 60 Hz	DETECTOR FUNCTION	Peak (PK) Average (AV)
ENVIRONMENTAL CONDITIONS	23deg. C, 69%RH 1015hPa	TESTED BY	Lori Chiu

ANTENNA POLARITY & TEST DISTANCE: HORIZONTAL AT 3 M								
NO.	FREQ. (MHz)	EMISSION LEVEL (dBuV/m)	LIMIT (dBuV/m)	MARGIN (dB)	ANTENNA HEIGHT (m)	TABLE ANGLE (Degree)	RAW VALUE (dBuV)	CORRECTION FACTOR (dB/m)
1	2390.00	69.18 PK	74.00	-4.82	1.31 H	311	36.86	32.32
2	2390.00	48.64 AV	54.00	-5.36	1.31 H	311	16.32	32.32
3	*2412.00	107.34 PK			1.29 H	279	75.02	32.32
4	*2412.00	96.55 AV			1.29 H	279	64.23	32.32
5	4824.00	47.05 PK	74.00	-26.95	1.19 H	207	9.05	38.00
6	4824.00	33.30 AV	54.00	-20.70	1.19 H	207	-4.70	38.00
ANTENNA POLARITY & TEST DISTANCE: VERTICAL AT 3 M								
NO.	FREQ. (MHz)	EMISSION LEVEL (dBuV/m)	LIMIT (dBuV/m)	MARGIN (dB)	ANTENNA HEIGHT (m)	TABLE ANGLE (Degree)	RAW VALUE (dBuV)	CORRECTION FACTOR (dB/m)
1	2390.00	67.30 PK	74.00	-6.70	1.52 V	56	34.98	32.32
2	2390.00	45.85 AV	54.00	-8.15	1.52 V	56	13.53	32.32
3	*2412.00	104.78 PK			1.52 V	56	72.46	32.32
4	*2412.00	95.27 AV			1.52 V	56	62.95	32.32
5	4824.00	52.05 PK	74.00	-21.95	1.20 V	310	14.05	38.00
6	4824.00	35.21 AV	54.00	-18.79	1.20 V	310	-2.79	38.00

- REMARKS:**
1. Emission level (dBuV/m) = Raw Value (dBuV) + Correction Factor (dB/m).
 2. Correction Factor (dB/m) = Antenna Factor (dB/m) + Cable Factor (dB).
 3. The other emission levels were very low against the limit.
 4. Margin value = Emission level – Limit value.
 5. “ * “: Fundamental frequency.



EUT TEST CONDITION		MEASUREMENT DETAIL	
CHANNEL	Channel 6	FREQUENCY RANGE	1 ~ 25GHz
INPUT POWER (SYSTEM)	120Vac, 60 Hz	DETECTOR FUNCTION	Peak (PK) Average (AV)
ENVIRONMENTAL CONDITIONS	23deg. C, 69%RH 1015hPa	TESTED BY	Lori Chiu

ANTENNA POLARITY & TEST DISTANCE: HORIZONTAL AT 3 M								
NO.	FREQ. (MHz)	EMISSION LEVEL (dBuV/m)	LIMIT (dBuV/m)	MARGIN (dB)	ANTENNA HEIGHT (m)	TABLE ANGLE (Degree)	RAW VALUE (dBuV)	CORRECTION FACTOR (dB/m)
1	*2437.00	107.44 PK			1.26 H	304	75.10	32.34
2	*2437.00	96.23 AV			1.26 H	304	63.89	32.34
3	4874.00	47.07 PK	74.00	-26.93	1.22 H	20	8.95	38.12
4	4874.00	33.82 AV	54.00	-20.18	1.22 H	20	-4.30	38.12
ANTENNA POLARITY & TEST DISTANCE: VERTICAL AT 3 M								
NO.	FREQ. (MHz)	EMISSION LEVEL (dBuV/m)	LIMIT (dBuV/m)	MARGIN (dB)	ANTENNA HEIGHT (m)	TABLE ANGLE (Degree)	RAW VALUE (dBuV)	CORRECTION FACTOR (dB/m)
1	*2437.00	105.37 PK			1.26 V	182	73.03	32.34
2	*2437.00	95.50 AV			1.26 V	182	63.16	32.34
3	4874.00	48.72 PK	74.00	-25.28	1.01 V	351	10.60	38.12
4	4874.00	34.69 AV	54.00	-19.31	1.01 V	351	-3.43	38.12

- REMARKS:**
1. Emission level (dBuV/m) = Raw Value (dBuV) + Correction Factor (dB/m).
 2. Correction Factor (dB/m) = Antenna Factor (dB/m) + Cable Factor (dB).
 3. The other emission levels were very low against the limit.
 4. Margin value = Emission level – Limit value.
 5. “ * “: Fundamental frequency.

EUT TEST CONDITION		MEASUREMENT DETAIL	
CHANNEL	Channel 11	FREQUENCY RANGE	1 ~ 25GHz
INPUT POWER (SYSTEM)	120Vac, 60 Hz	DETECTOR FUNCTION	Peak (PK) Average (AV)
ENVIRONMENTAL CONDITIONS	23deg. C, 69%RH 1015hPa	TESTED BY	Lori Chiu

ANTENNA POLARITY & TEST DISTANCE: HORIZONTAL AT 3 M								
NO.	FREQ. (MHz)	EMISSION LEVEL (dBuV/m)	LIMIT (dBuV/m)	MARGIN (dB)	ANTENNA HEIGHT (m)	TABLE ANGLE (Degree)	RAW VALUE (dBuV)	CORRECTION FACTOR (dB/m)
1	*2462.00	107.72 PK			1.29 H	280	75.35	32.37
2	*2462.00	96.28 AV			1.29 H	280	63.91	32.37
3	2483.50	67.30 PK	74.00	-6.70	1.28 H	283	34.91	32.39
4	2483.50	50.13 AV	54.00	-3.87	1.28 H	283	17.74	32.39
5	4924.00	47.32 PK	74.00	-26.68	1.00 H	13	9.09	38.23
6	4924.00	33.45 AV	54.00	-20.55	1.00 H	13	-4.78	38.23
ANTENNA POLARITY & TEST DISTANCE: VERTICAL AT 3 M								
NO.	FREQ. (MHz)	EMISSION LEVEL (dBuV/m)	LIMIT (dBuV/m)	MARGIN (dB)	ANTENNA HEIGHT (m)	TABLE ANGLE (Degree)	RAW VALUE (dBuV)	CORRECTION FACTOR (dB/m)
1	*2462.00	105.57 PK			1.59 V	59	73.20	32.37
2	*2462.00	94.82 AV			1.59 V	59	62.45	32.37
3	2483.50	67.24 PK	74.00	-6.76	1.59 V	59	34.85	32.39
4	2483.50	47.82 AV	54.00	-6.18	1.59 V	59	15.43	32.39
5	4924.00	52.38 PK	74.00	-21.62	1.00 V	175	14.15	38.23
6	4924.00	35.64 AV	54.00	-18.36	1.00 V	175	-2.59	38.23

- REMARKS:**
1. Emission level (dBuV/m) = Raw Value (dBuV) + Correction Factor (dB/m).
 2. Correction Factor (dB/m) = Antenna Factor (dB/m) + Cable Factor (dB).
 3. The other emission levels were very low against the limit.
 4. Margin value = Emission level – Limit value.
 5. “ * “: Fundamental frequency.

DRAFT 802.11n (40MHz) OFDM MODULATION

EUT TEST CONDITION		MEASUREMENT DETAIL	
CHANNEL	Channel 1	FREQUENCY RANGE	1 ~ 25GHz
INPUT POWER (SYSTEM)	120Vac, 60 Hz	DETECTOR FUNCTION	Peak (PK) Average (AV)
ENVIRONMENTAL CONDITIONS	23deg. C, 69%RH 1015hPa	TESTED BY	Lori Chiu

ANTENNA POLARITY & TEST DISTANCE: HORIZONTAL AT 3 M								
NO.	FREQ. (MHz)	EMISSION LEVEL (dBuV/m)	LIMIT (dBuV/m)	MARGIN (dB)	ANTENNA HEIGHT (m)	TABLE ANGLE (Degree)	RAW VALUE (dBuV)	CORRECTION FACTOR (dB/m)
1	2390.00	66.93 PK	74.00	-7.07	1.32 H	302	34.61	32.32
2	2390.00	49.45 AV	54.00	-4.55	1.32 H	302	17.13	32.32
3	*2422.00	103.21 PK			1.29 H	281	70.88	32.33
4	*2422.00	92.83 AV			1.29 H	281	60.50	32.33
5	4844.00	46.12 PK	74.00	-27.88	1.29 H	185	8.08	38.05
6	4844.00	33.57 AV	54.00	-20.43	1.29 H	185	-4.48	38.05
ANTENNA POLARITY & TEST DISTANCE: VERTICAL AT 3 M								
NO.	FREQ. (MHz)	EMISSION LEVEL (dBuV/m)	LIMIT (dBuV/m)	MARGIN (dB)	ANTENNA HEIGHT (m)	TABLE ANGLE (Degree)	RAW VALUE (dBuV)	CORRECTION FACTOR (dB/m)
1	2390.00	62.53 PK	74.00	-11.47	1.50 V	57	30.21	32.32
2	2390.00	49.23 AV	54.00	-4.77	1.50 V	57	16.91	32.32
3	*2422.00	101.30 PK			1.50 V	57	68.97	32.33
4	*2422.00	91.00 AV			1.50 V	57	58.67	32.33
5	4844.00	47.87 PK	74.00	-26.13	1.24 V	76	9.82	38.05
6	4844.00	35.60 AV	54.00	-18.40	1.24 V	76	-2.45	38.05

- REMARKS:**
1. Emission level (dBuV/m) = Raw Value (dBuV) + Correction Factor (dB/m).
 2. Correction Factor (dB/m) = Antenna Factor (dB/m) + Cable Factor (dB).
 3. The other emission levels were very low against the limit.
 4. Margin value = Emission level – Limit value.
 5. “ * “: Fundamental frequency.



EUT TEST CONDITION		MEASUREMENT DETAIL	
CHANNEL	Channel 4	FREQUENCY RANGE	1 ~ 25GHz
INPUT POWER (SYSTEM)	120Vac, 60 Hz	DETECTOR FUNCTION	Peak (PK) Average (AV)
ENVIRONMENTAL CONDITIONS	23deg. C, 69%RH 1015hPa	TESTED BY	Lori Chiu

ANTENNA POLARITY & TEST DISTANCE: HORIZONTAL AT 3 M								
NO.	FREQ. (MHz)	EMISSION LEVEL (dBuV/m)	LIMIT (dBuV/m)	MARGIN (dB)	ANTENNA HEIGHT (m)	TABLE ANGLE (Degree)	RAW VALUE (dBuV)	CORRECTION FACTOR (dB/m)
1	*2437.00	103.40 PK			1.27 H	281	71.06	32.34
2	*2437.00	93.08 AV			1.27 H	281	60.74	32.34
3	2483.50	65.25 PK	74.00	-8.75	1.27 H	281	32.86	32.39
4	2483.50	51.21 AV	54.00	-2.79	1.27 H	281	18.82	32.39
5	4874.00	47.31 PK	74.00	-26.69	1.05 H	167	9.19	38.12
6	4874.00	34.50 AV	54.00	-19.50	1.05 H	167	-3.62	38.12
ANTENNA POLARITY & TEST DISTANCE: VERTICAL AT 3 M								
NO.	FREQ. (MHz)	EMISSION LEVEL (dBuV/m)	LIMIT (dBuV/m)	MARGIN (dB)	ANTENNA HEIGHT (m)	TABLE ANGLE (Degree)	RAW VALUE (dBuV)	CORRECTION FACTOR (dB/m)
1	*2437.00	101.67 PK			1.08 V	317	69.33	32.34
2	*2437.00	92.12 AV			1.08 V	317	59.78	32.34
3	2483.50	62.99 PK	74.00	-11.01	1.08 V	311	30.60	32.39
4	2483.50	48.74 AV	54.00	-5.26	1.08 V	311	16.35	32.39
5	4874.00	48.37 PK	74.00	-25.63	1.42 V	126	10.25	38.12
6	4874.00	35.62 AV	54.00	-18.38	1.42 V	126	-2.50	38.12

- REMARKS:**
1. Emission level (dBuV/m) = Raw Value (dBuV) + Correction Factor (dB/m).
 2. Correction Factor (dB/m) = Antenna Factor (dB/m) + Cable Factor (dB).
 3. The other emission levels were very low against the limit.
 4. Margin value = Emission level – Limit value.
 5. “ * “: Fundamental frequency.



EUT TEST CONDITION		MEASUREMENT DETAIL	
CHANNEL	Channel 7	FREQUENCY RANGE	1 ~ 25GHz
INPUT POWER (SYSTEM)	120Vac, 60 Hz	DETECTOR FUNCTION	Peak (PK) Average (AV)
ENVIRONMENTAL CONDITIONS	23deg. C, 69%RH 1015hPa	TESTED BY	Lori Chiu

ANTENNA POLARITY & TEST DISTANCE: HORIZONTAL AT 3 M								
NO.	FREQ. (MHz)	EMISSION LEVEL (dBuV/m)	LIMIT (dBuV/m)	MARGIN (dB)	ANTENNA HEIGHT (m)	TABLE ANGLE (Degree)	RAW VALUE (dBuV)	CORRECTION FACTOR (dB/m)
1	*2452.00	103.33 PK			1.28 H	280	70.97	32.36
2	*2452.00	91.83 AV			1.28 H	280	59.47	32.36
3	2483.50	62.19 PK	74.00	-11.81	1.28 H	278	29.80	32.39
4	2483.50	50.85 AV	54.00	-3.15	1.28 H	278	18.46	32.39
5	4904.00	46.37 PK	74.00	-27.63	1.00 H	6	8.18	38.19
6	4904.00	33.62 AV	54.00	-20.38	1.00 H	6	-4.57	38.19
ANTENNA POLARITY & TEST DISTANCE: VERTICAL AT 3 M								
NO.	FREQ. (MHz)	EMISSION LEVEL (dBuV/m)	LIMIT (dBuV/m)	MARGIN (dB)	ANTENNA HEIGHT (m)	TABLE ANGLE (Degree)	RAW VALUE (dBuV)	CORRECTION FACTOR (dB/m)
1	*2452.00	101.52 PK			1.00 V	256	69.16	32.36
2	*2452.00	90.60 AV			1.00 V	256	58.24	32.36
3	2483.50	61.13 PK	74.00	-12.87	1.01 V	257	28.74	32.39
4	2483.50	49.07 AV	54.00	-4.93	1.01 V	257	16.68	32.39
5	4904.00	47.79 PK	74.00	-26.21	1.33 V	318	9.60	38.19
6	4904.00	35.01 AV	54.00	-18.99	1.33 V	318	-3.18	38.19

- REMARKS:**
1. Emission level (dBuV/m) = Raw Value (dBuV) + Correction Factor (dB/m).
 2. Correction Factor (dB/m) = Antenna Factor (dB/m) + Cable Factor (dB).
 3. The other emission levels were very low against the limit.
 4. Margin value = Emission level – Limit value.
 5. “ * “: Fundamental frequency.

BELOW 1GHz WORST-CASE DATA : 802.11b DSSS MODULATION

EUT TEST CONDITION		MEASUREMENT DETAIL	
CHANNEL	Channel 11	FREQUENCY RANGE	Below 1000MHz
INPUT POWER (SYSTEM)	120Vac, 60 Hz	DETECTOR FUNCTION	Quasi-Peak
ENVIRONMENTAL CONDITIONS	23deg. C, 69%RH 1015hPa	TESTED BY	Lori Chiu

ANTENNA POLARITY & TEST DISTANCE: HORIZONTAL AT 3 M								
NO.	FREQ. (MHz)	EMISSION LEVEL (dBuV/m)	LIMIT (dBuV/m)	MARGIN (dB)	ANTENNA HEIGHT (m)	TABLE ANGLE (Degree)	RAW VALUE (dBuV)	CORRECTION FACTOR (dB/m)
1	94.06	29.83 QP	43.50	-13.67	2.00 H	328	20.59	9.24
2	119.34	38.08 QP	43.50	-5.42	1.50 H	142	26.41	11.67
3	154.33	41.07 QP	43.50	-2.43	1.00 H	283	27.29	13.78
4	162.11	39.78 QP	43.50	-3.72	1.75 H	298	26.27	13.52
5	232.11	32.87 QP	46.00	-13.13	1.25 H	274	20.89	11.98
6	333.21	32.15 QP	46.00	-13.85	2.00 H	7	17.76	14.39
7	379.87	31.33 QP	46.00	-14.67	1.00 H	154	15.82	15.51
8	533.47	31.12 QP	46.00	-14.88	1.50 H	217	11.20	19.92
ANTENNA POLARITY & TEST DISTANCE: VERTICAL AT 3 M								
NO.	FREQ. (MHz)	EMISSION LEVEL (dBuV/m)	LIMIT (dBuV/m)	MARGIN (dB)	ANTENNA HEIGHT (m)	TABLE ANGLE (Degree)	RAW VALUE (dBuV)	CORRECTION FACTOR (dB/m)
1	66.84	26.02 QP	40.00	-13.98	1.00 V	10	13.93	12.09
2	127.11	36.87 QP	43.50	-6.63	1.00 V	88	24.86	12.01
3	148.50	41.00 QP	43.50	-2.50	1.00 V	208	27.35	13.65
4	162.11	38.44 QP	43.50	-5.06	1.00 V	145	24.92	13.52
5	232.11	31.00 QP	46.00	-15.00	1.00 V	130	19.02	11.98
6	333.21	31.05 QP	46.00	-14.95	2.00 V	109	16.65	14.39
7	953.44	32.21 QP	46.00	-13.79	1.00 V	199	5.86	26.35

- REMARKS:**
1. Emission level (dBuV/m) = Raw Value (dBuV) + Correction Factor (dB/m).
 2. Correction Factor (dB/m) = Antenna Factor (dB/m) + Cable Factor (dB).
 3. The other emission levels were very low against the limit.
 4. Margin value = Emission level – Limit value.



4.2 CONDUCTED EMISSION MEASUREMENT

4.2.1 LIMITS OF CONDUCTED EMISSION MEASUREMENT

FREQUENCY OF EMISSION (MHz)	CONDUCTED LIMIT (dB μ V)	
	Quasi-peak	Average
0.15-0.5	66 to 56	56 to 46
0.5-5	56	46
5-30	60	50

- NOTE:**
1. The lower limit shall apply at the transition frequencies.
 2. The limit decreases in line with the logarithm of the frequency in the range of 0.15 to 0.50 MHz.
 3. All emanations from a class A/B digital device or system, including any network of conductors and apparatus connected thereto, shall not exceed the level of field strengths specified above.

4.2.2 TEST INSTRUMENTS

DESCRIPTION & MANUFACTURER	MODEL NO.	SERIAL NO.	CALIBRATED UNTIL
Test Receiver ROHDE & SCHWARZ	ESCS30	100288	Sep. 21, 2008
RF signal cable Woken	5D-FB	Cable-HYCO3-01	Jan. 06, 2009
LISN ROHDE & SCHWARZ	ESH2-Z5	100100	Jan. 09, 2009
LISN SCHWARZBECK	NNBL 8226-2	8226-142	May 07, 2008
Software ADT	ADT_Cond_V3	NA	NA

- NOTE:**
1. The calibration interval of the above test instruments is 12 months and the calibrations are traceable to NML/ROC and NIST/USA.
 2. The test was performed in HwaYa Shielded Room 2.
 3. The VCCI Site Registration No. is C-2047.

4.2.3 TEST PROCEDURES

- a. The EUT was placed 0.4 meters from the conducting wall of the shielded room with EUT being connected to the power mains through a line impedance stabilization network (LISN). Other support units were connected to the power mains through another LISN. The two LISNs provide 50 ohm/ 50uH of coupling impedance for the measuring instrument.
- b. Both lines of the power mains connected to the EUT were checked for maximum conducted interference.
- c. The frequency range from 150kHz to 30MHz was searched. Emission levels under (Limit - 20dB) was not recorded.

NOTE: All modes of operation were investigated and the worst-case emissions are reported.

4.2.4 DEVIATION FROM TEST STANDARD

No deviation.

4.2.5 TEST SETUP

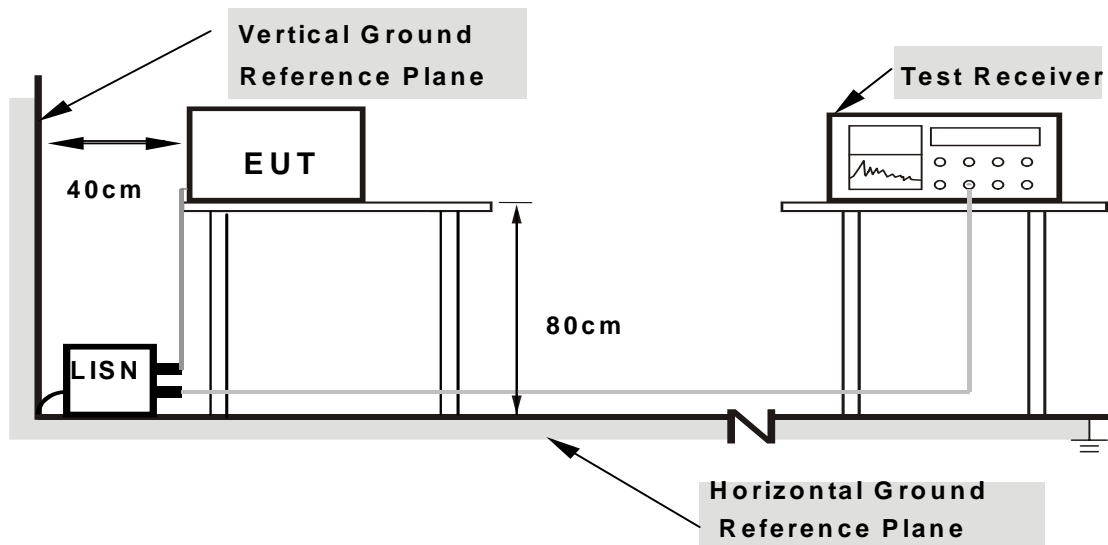

- Note:**
1. Support units were connected to second LISN.
 2. Both of LISNs (AMN) are 80 cm from EUT and at least 80 from other units and other metal planes

For the actual test configuration, please refer to the attached file (Test Setup Photo).

4.2.6 EUT OPERATING CONDITIONS

Same as 4.1.6.

4.2.7 TEST RESULTS

CONDUCTED WORST-CASE DATA 802.11b DSSS MODULATION

EUT TEST CONDITION		MEASUREMENT DETAIL	
CHANNEL	Channel 11	PHASE	Line 1
ENVIRONMENTAL CONDITIONS	23deg. C, 65% RH, 1015hPa	6dB BANDWIDTH	9 kHz
INPUT POWER (SYSTEM)	120Vac, 60 Hz	TESTED BY	Kevin Liang

No	Freq. [MHz]	Corr. Factor (dB)	Reading Value [dB (uV)]		Emission Level [dB (uV)]		Limit [dB (uV)]		Margin (dB)	
			Q.P.	AV.	Q.P.	AV.	Q.P.	AV.	Q.P.	AV.
1	0.158	0.10	43.06	-	43.16	-	65.58	55.58	-22.42	-
2	0.205	0.10	43.50	-	43.60	-	63.42	53.42	-19.82	-
3	0.302	0.10	34.99	-	35.09	-	60.18	50.18	-25.09	-
4	1.512	0.17	27.20	-	27.37	-	56.00	46.00	-28.63	-
5	3.852	0.28	25.39	-	25.67	-	56.00	46.00	-30.33	-
6	10.801	0.35	33.78	-	34.13	-	60.00	50.00	-25.87	-

- REMARKS:**
1. Q.P. and AV. are abbreviations of quasi-peak and average individually.
 2. "-": The Quasi-peak reading value also meets average limit and measurement with the average detector is unnecessary.
 3. The emission levels of other frequencies were very low against the limit.
 4. Margin value = Emission level - Limit value
 5. Correction factor = Insertion loss + Cable loss
 6. Emission Level = Correction Factor + Reading Value.

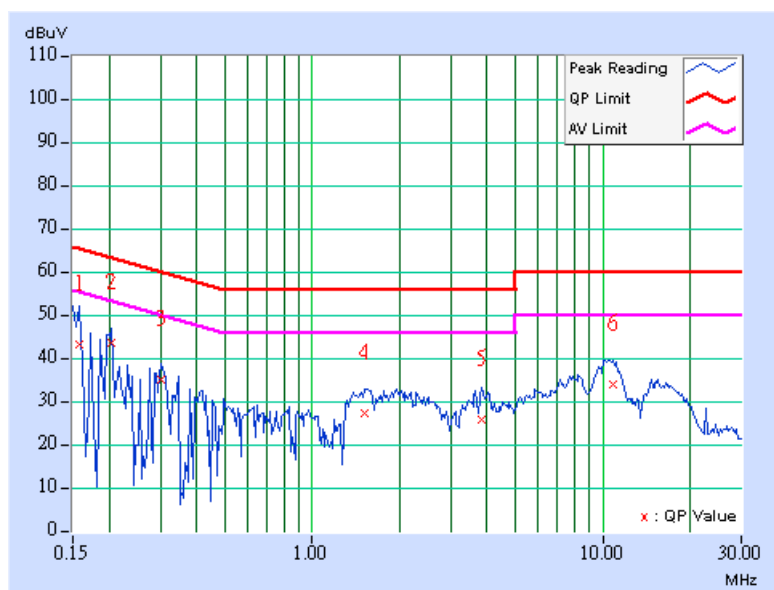

EUT TEST CONDITION		MEASUREMENT DETAIL	
CHANNEL	Channel 11	PHASE	Line 2
ENVIRONMENTAL CONDITIONS	23deg. C, 65% RH, 1015hPa	6dB BANDWIDTH	9 kHz
INPUT POWER (SYSTEM)	120Vac, 60 Hz	TESTED BY	Kevin Liang

No	Freq. [MHz]	Corr. Factor (dB)	Reading Value [dB (uV)]		Emission Level [dB (uV)]		Limit [dB (uV)]		Margin (dB)	
			Q.P.	AV.	Q.P.	AV.	Q.P.	AV.	Q.P.	AV.
			1	0.203	0.10	44.07	-	44.17	-	63.48
2	0.345	0.10	32.42	-	32.52	-	59.07	49.07	-26.55	-
3	0.623	0.14	29.46	-	29.60	-	56.00	46.00	-26.40	-
4	1.508	0.22	25.48	-	25.70	-	56.00	46.00	-30.30	-
5	3.848	0.28	24.50	-	24.78	-	56.00	46.00	-31.22	-
6	10.594	0.44	34.50	-	34.94	-	60.00	50.00	-25.06	-

- REMARKS:**
1. Q.P. and AV. are abbreviations of quasi-peak and average individually.
 2. "-": The Quasi-peak reading value also meets average limit and measurement with the average detector is unnecessary.
 3. The emission levels of other frequencies were very low against the limit.
 4. Margin value = Emission level - Limit value
 5. Correction factor = Insertion loss + Cable loss
 6. Emission Level = Correction Factor + Reading Value.

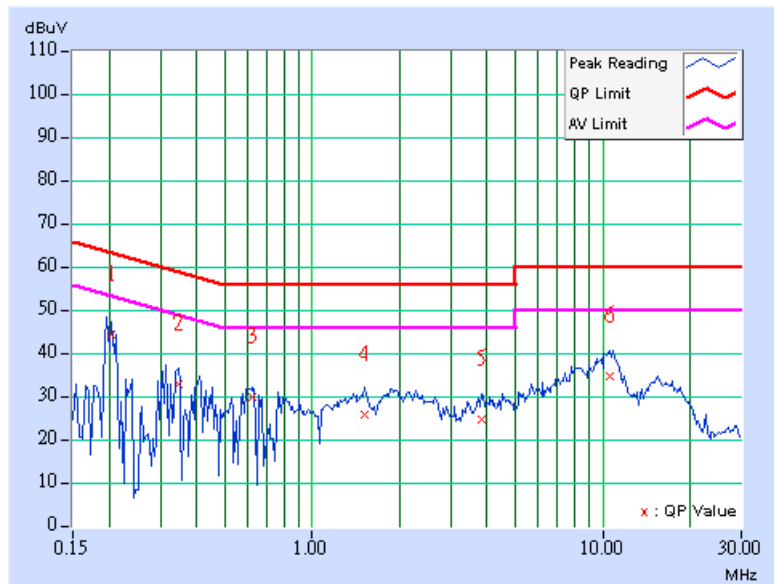



4.3 6dB BANDWIDTH MEASUREMENT

4.3.1 LIMITS OF 6dB BANDWIDTH MEASUREMENT

The minimum of 6dB Bandwidth Measurement is 0.5 MHz.

4.3.2 TEST INSTRUMENTS

DESCRIPTION & MANUFACTURER	MODEL NO.	SERIAL NO.	CALIBRATED UNTIL
SPECTRUM ANALYZER	FSP40	100040	Jun. 28, 2008

NOTE: The calibration interval of the above test instruments is 12 months and the calibrations are traceable to NML/ROC and NIST/USA.

4.3.3 TEST PROCEDURE

The transmitter output was connected to the spectrum analyzer through an attenuator. The bandwidth of the fundamental frequency was measured by spectrum analyzer with 100kHz RBW and 300kHz VBW. The 6dB bandwidth is defined as the total spectrum the power of which is higher than peak power minus 6dB.

4.3.4 DEVIATION FROM TEST STANDARD

No deviation.

4.3.5 TEST SETUP

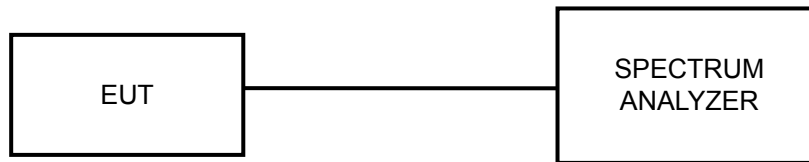

4.3.6 EUT OPERATING CONDITIONS

The software provided by client to enable the EUT under transmission condition continuously at lowest, middle and highest channel frequencies individually.



4.3.7 TEST RESULTS

802.11b DSSS MODULATION

INPUT POWER (SYSTEM)	120Vac, 60 Hz	ENVIRONMENTAL CONDITIONS	25deg.C, 65% RH, 1015hPa
TESTED BY	Match Tsui		

CHANNEL	CHANNEL FREQUENCY (MHz)	6dB BANDWIDTH (MHz)	MINIMUM LIMIT (MHz)	PASS / FAIL
1	2412	10.02	0.5	PASS
6	2437	10.08	0.5	PASS
11	2462	10.02	0.5	PASS

CH 1

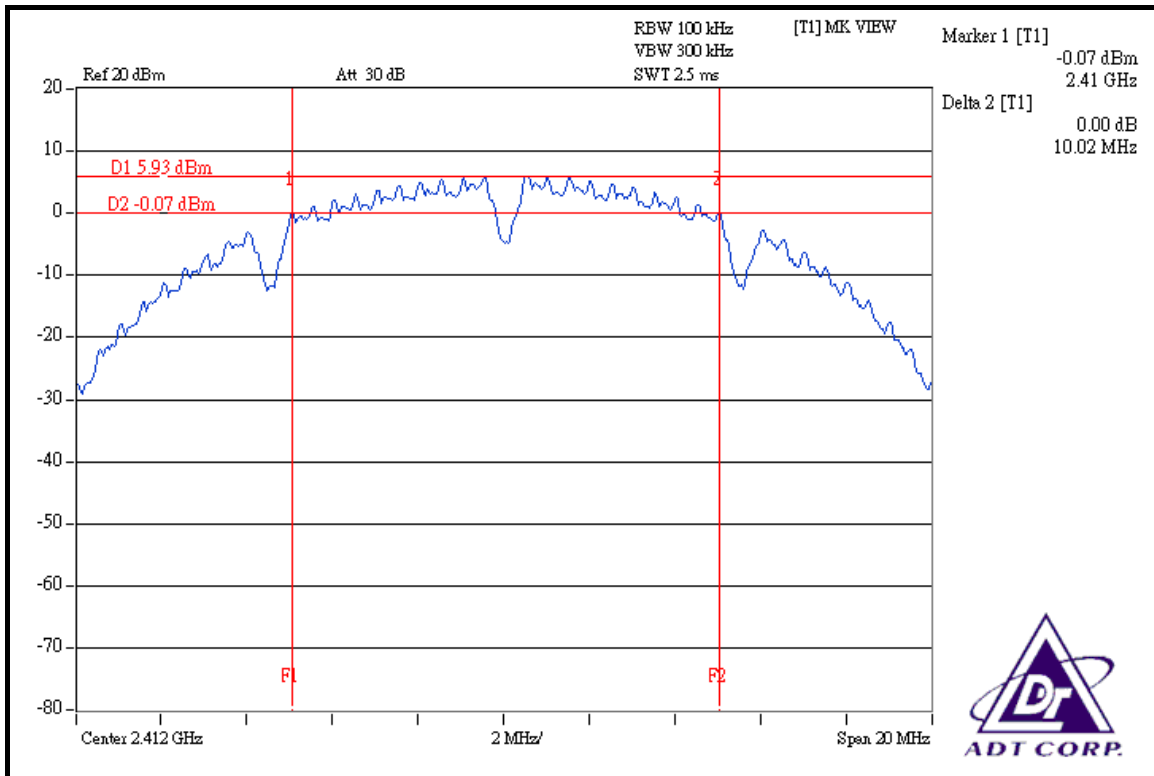

CH 6

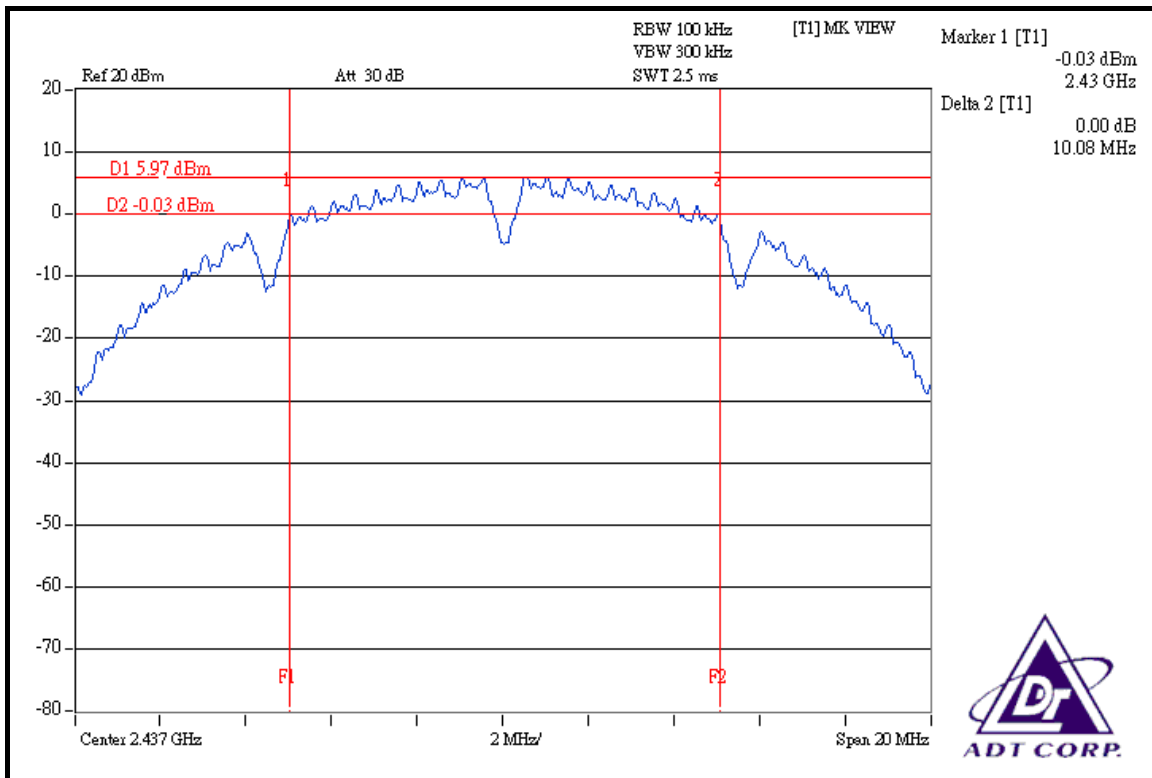

CH 11

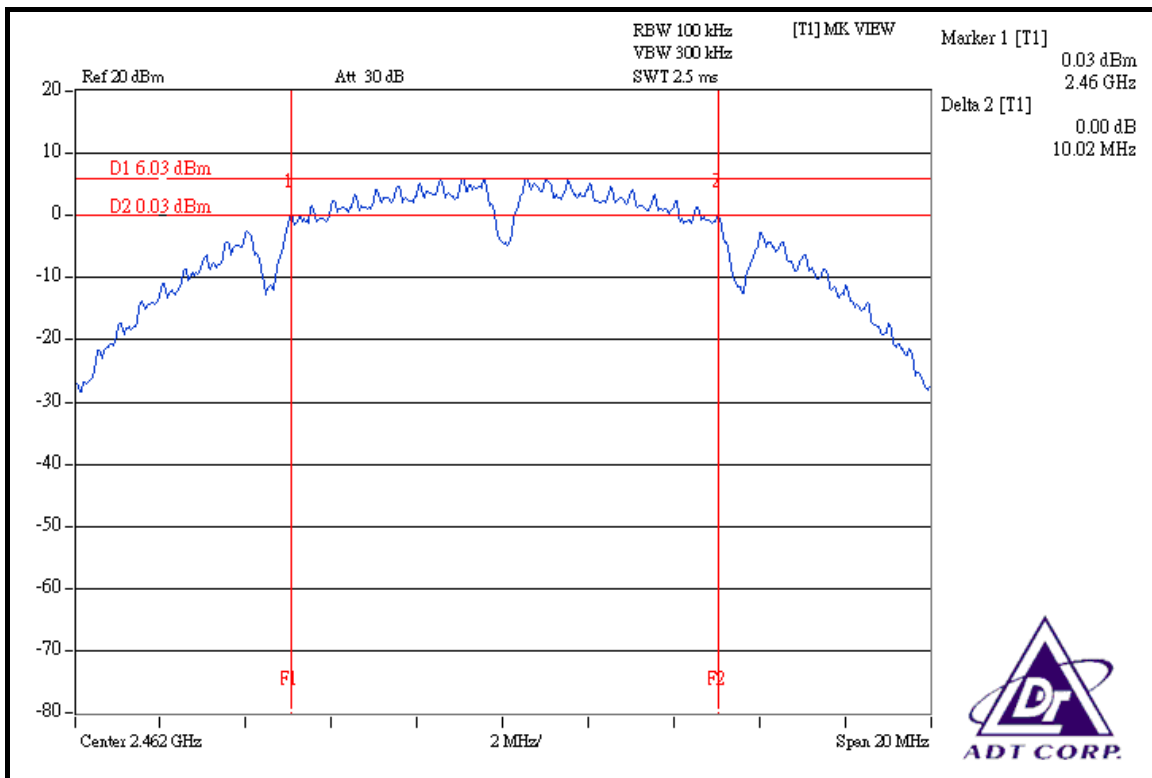



802.11g OFDM MODULATION

INPUT POWER (SYSTEM)	120Vac, 60 Hz	ENVIRONMENTAL CONDITIONS	25deg.C, 65% RH, 1015hPa
TESTED BY	Match Tsui		

CHANNEL	CHANNEL FREQUENCY (MHz)	6dB BANDWIDTH (MHz)	MINIMUM LIMIT (MHz)	PASS / FAIL
1	2412	16.47	0.5	PASS
6	2437	16.46	0.5	PASS
11	2462	16.50	0.5	PASS

CH 1

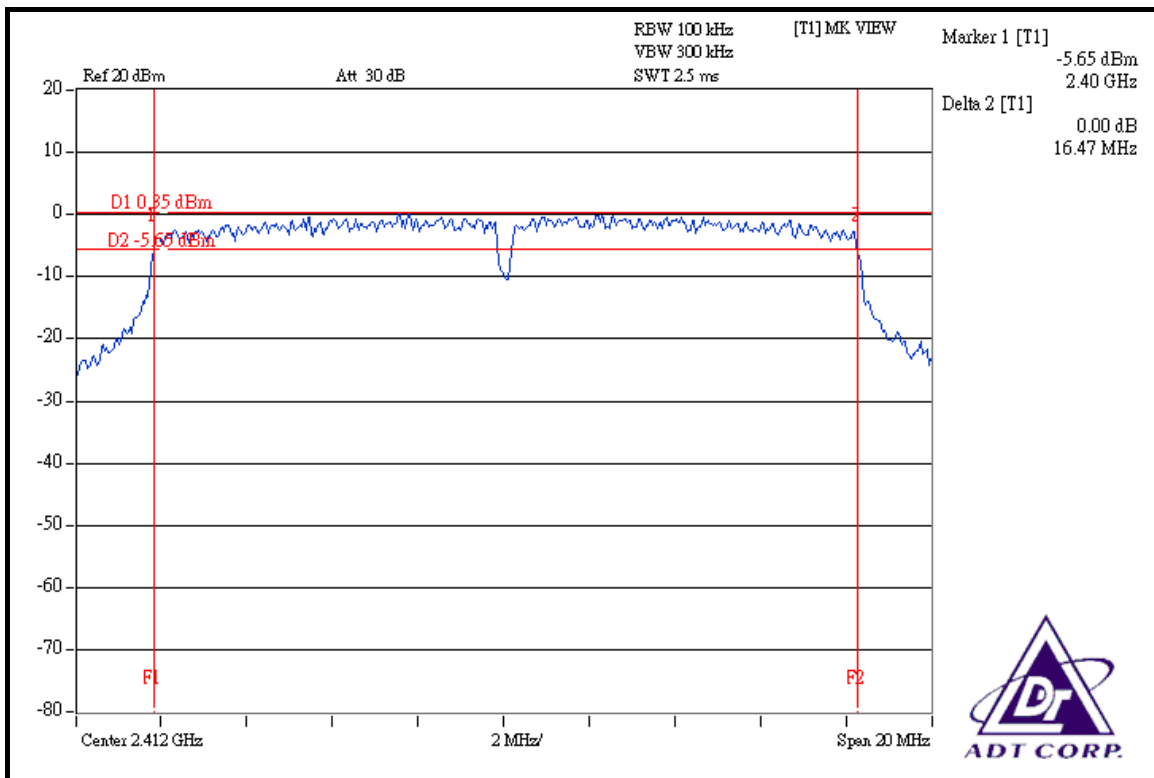

CH 6

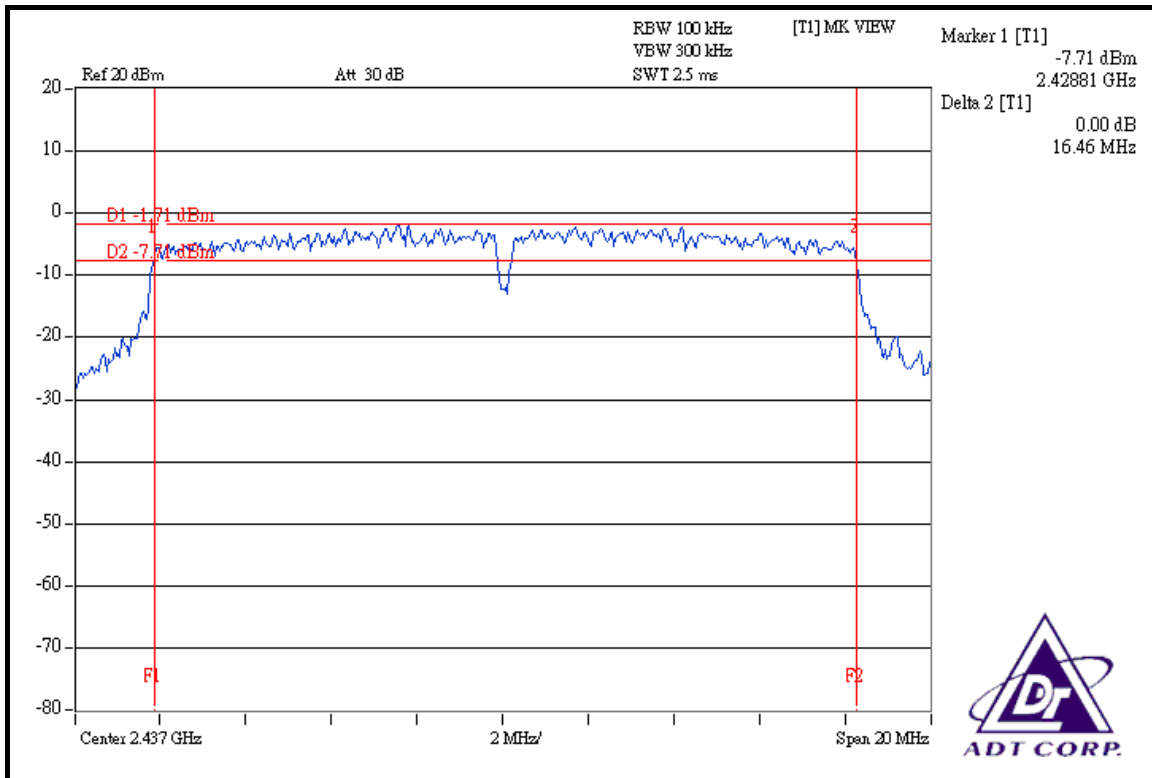

CH 11

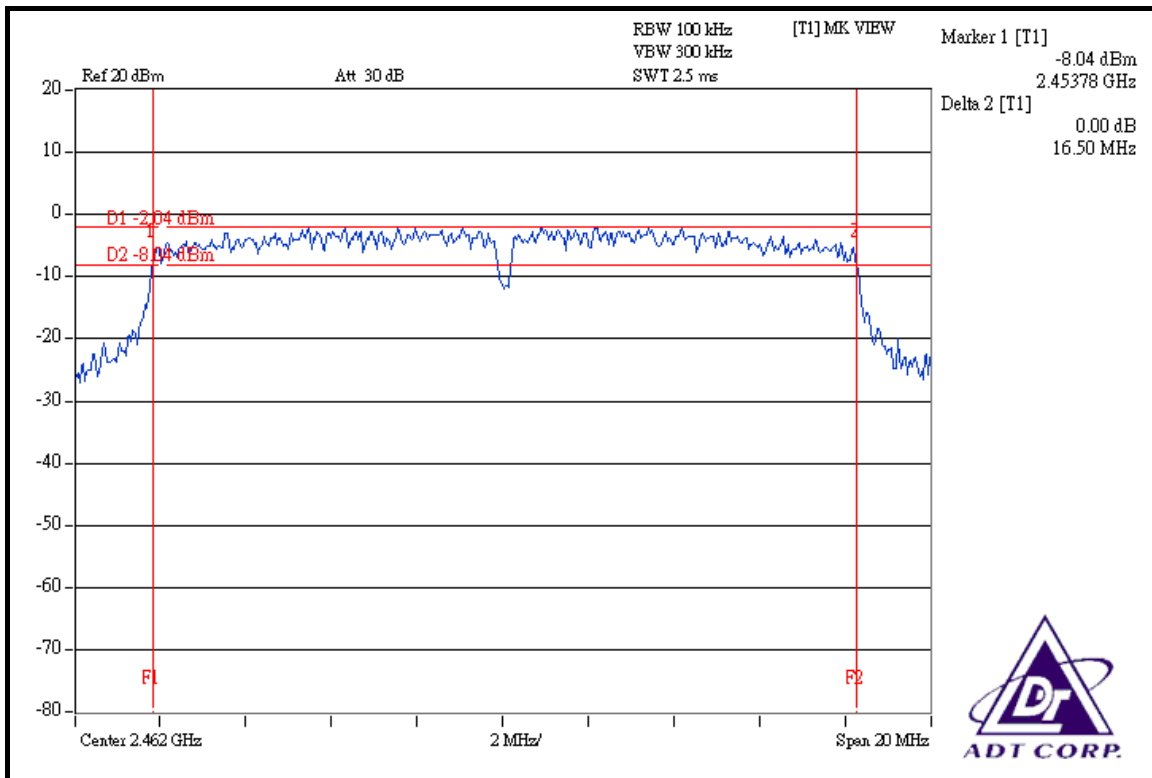



DRAFT 802.11n (20MHz) OFDM MODULATION

INPUT POWER (SYSTEM)	120Vac, 60 Hz	ENVIRONMENTAL CONDITIONS	25deg.C, 65% RH, 1015hPa
TESTED BY	Match Tsui		

CHANNEL	CHANNEL FREQUENCY (MHz)	6dB BANDWIDTH (MHz)	MINIMUM LIMIT (MHz)	PASS / FAIL
1	2412	17.69	0.5	PASS
6	2437	17.66	0.5	PASS
11	2462	17.65	0.5	PASS

CH 1

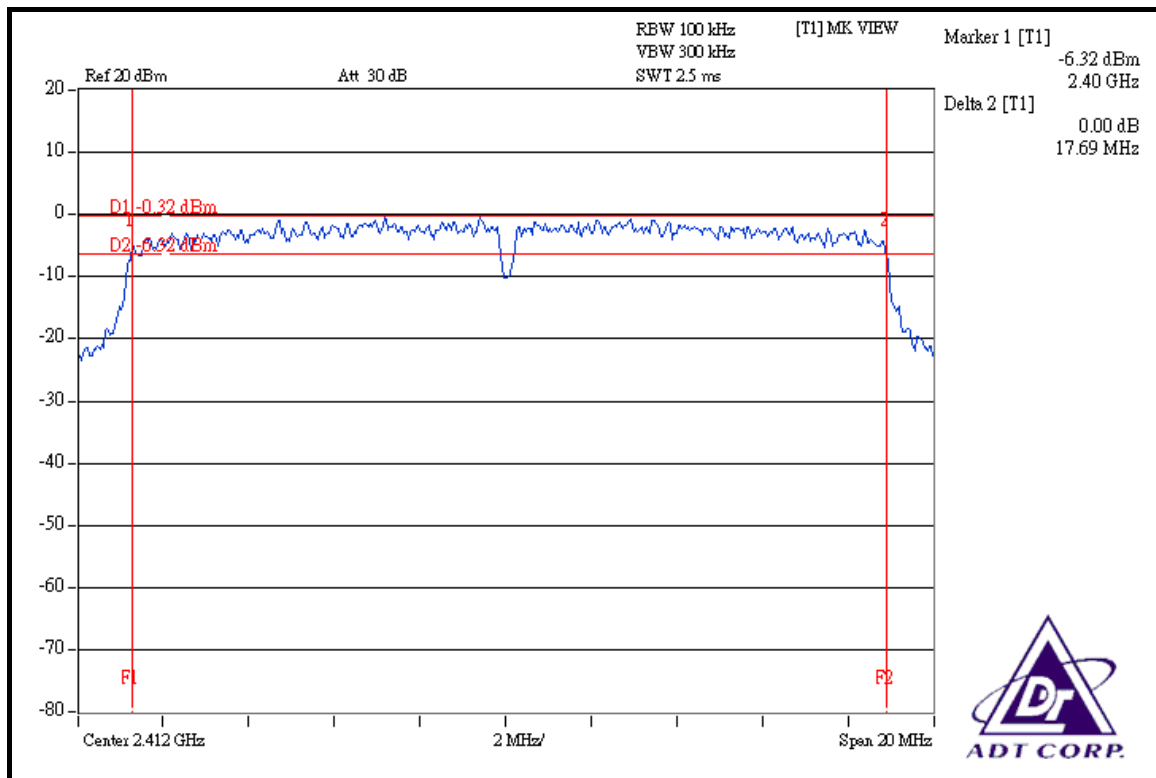

CH 6

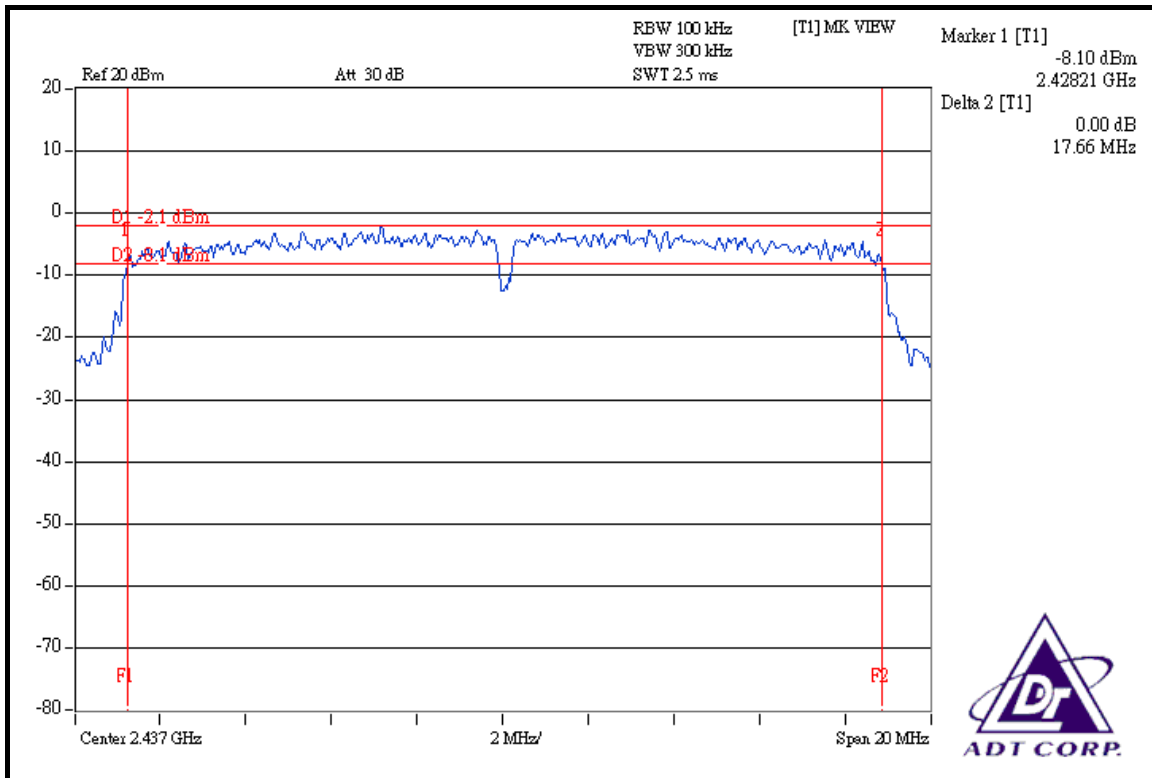

CH 11

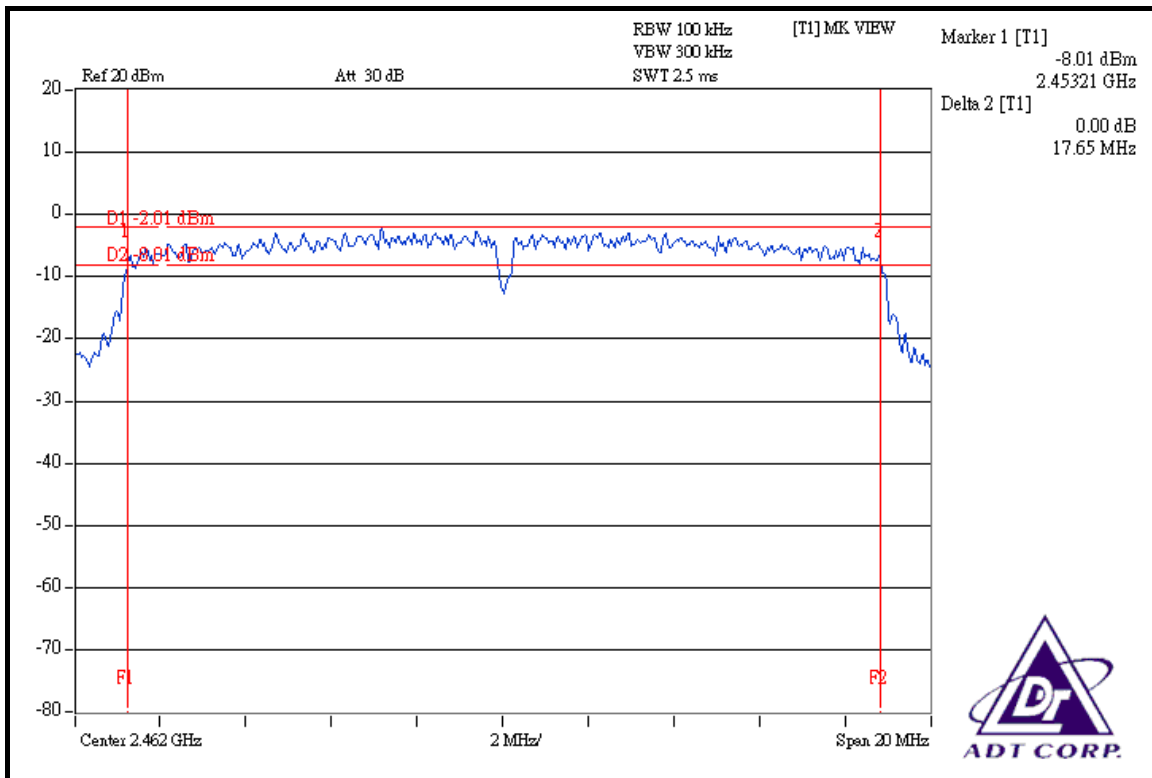



DRAFT 802.11n (40MHz) OFDM MODULATION

INPUT POWER (SYSTEM)	120Vac, 60 Hz	ENVIRONMENTAL CONDITIONS	25deg.C, 65% RH, 1015hPa
TESTED BY	Match Tsui		

CHANNEL	CHANNEL FREQUENCY (MHz)	6dB BANDWIDTH (MHz)	MINIMUM LIMIT (MHz)	PASS / FAIL
1	2422	36.47	0.5	PASS
4	2437	36.50	0.5	PASS
7	2452	36.50	0.5	PASS

CH 1

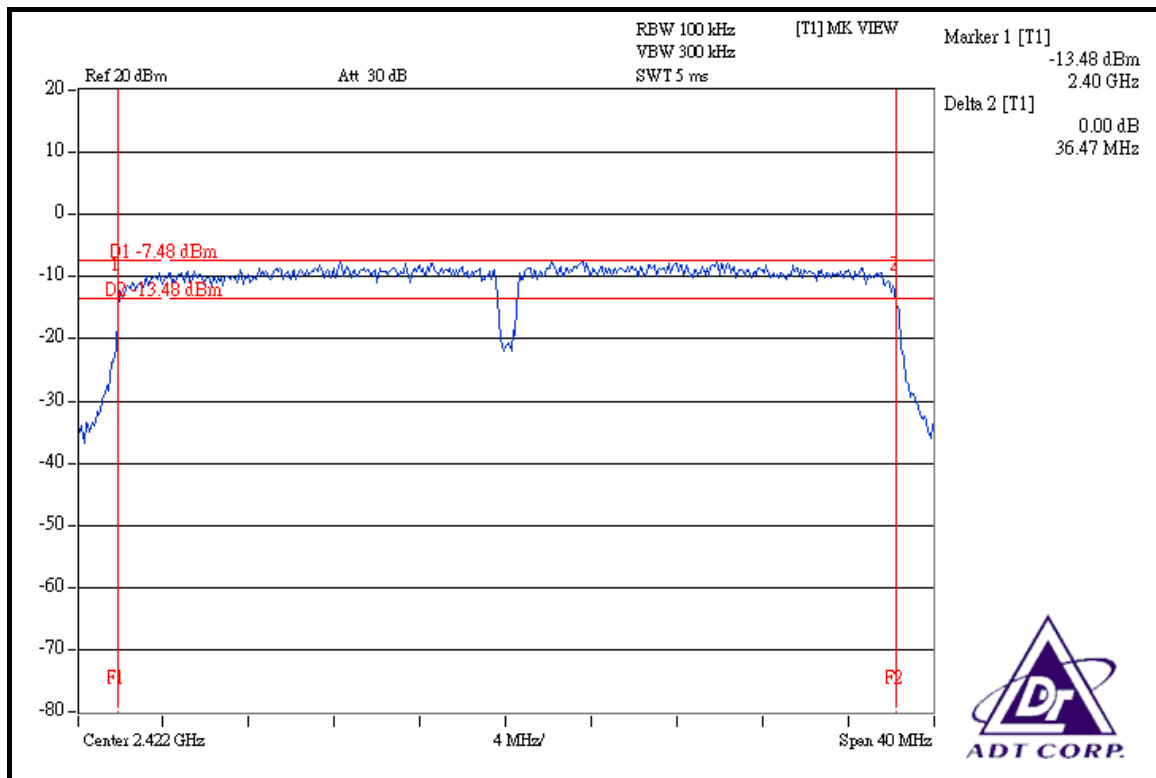

CH 4

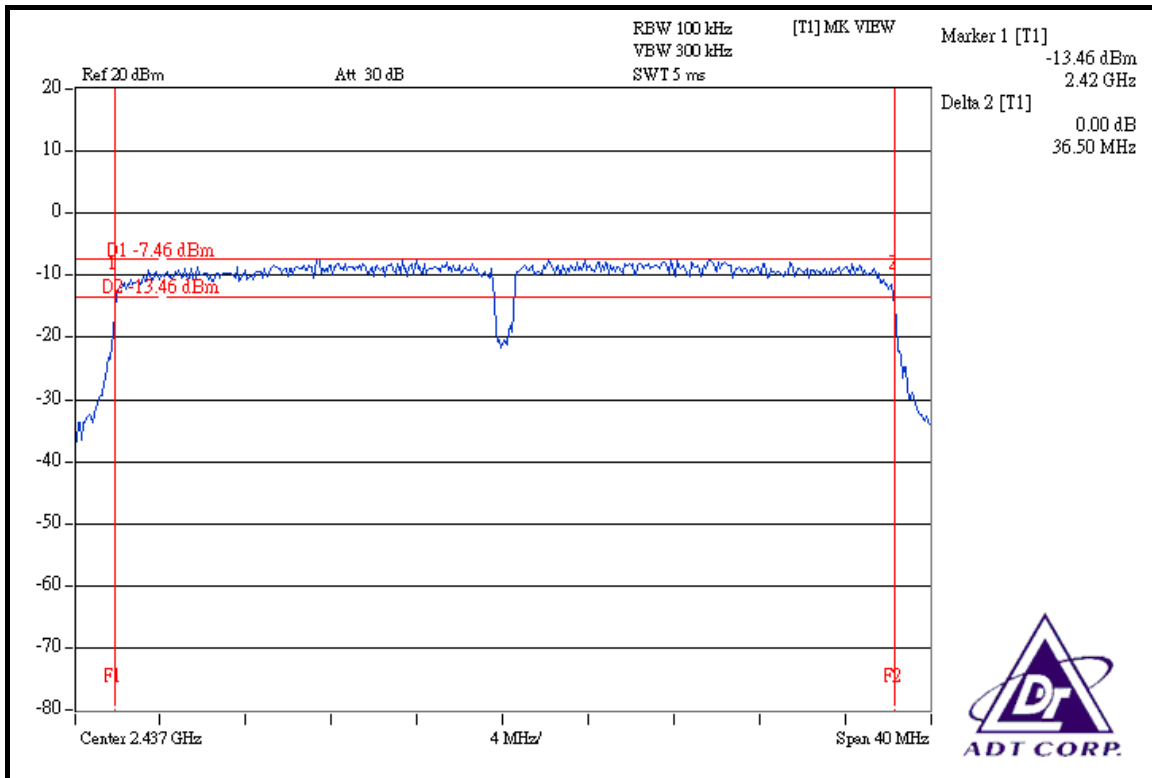

CH 7

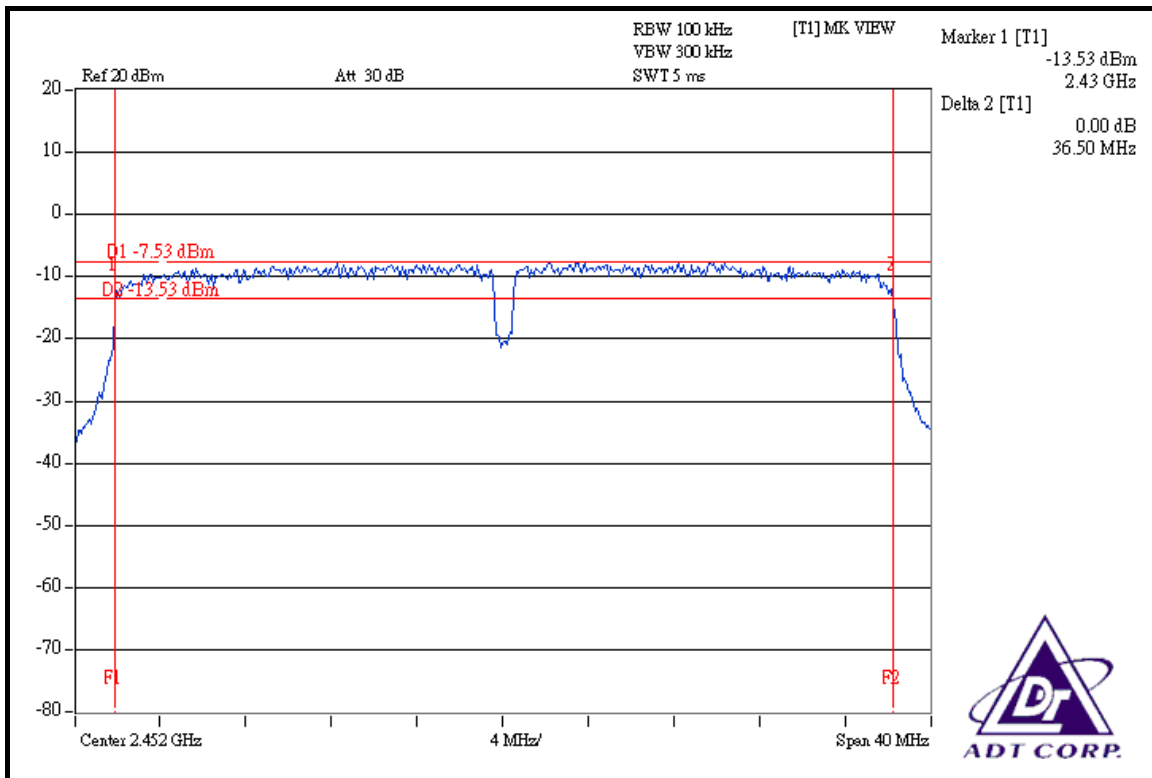



4.4 MAXIMUM PEAK OUTPUT POWER

4.4.1 LIMITS OF MAXIMUM PEAK OUTPUT POWER MEASUREMENT

The Maximum Peak Output Power Measurement is 30dBm.

4.4.2 INSTRUMENTS

DESCRIPTION & MANUFACTURER	MODEL NO.	SERIAL NO.	CALIBRATED UNTIL
R&S SPECTRUM ANALYZER	FSP40	100040	Jun. 28, 2008
AGILENT SYNTHESIZED SIGNAL GENERATOR	E8257C	MY43320668	Dec. 25, 2008
DIGITAL RT OSCILLOSCOPE	TDS1012	C037299	Nov. 21, 2008
NARDA DETECTOR	4503A	FSCM99899	NA

NOTE: The calibration interval of the above test instruments is 12 months and the calibrations are traceable to NML/ROC and NIST/USA.

4.4.3 TEST PROCEDURES

- a. A detector was used on the output port of the EUT. An oscilloscope was used to read the response of the detector.
- b. Replaced the EUT by the signal generator. The center frequency of the S.G was adjusted to the center frequency of the measured channel.
- c. Adjusted the power to have the same reading on oscilloscope. Record the power level.

4.4.4 DEVIATION FROM TEST STANDARD

No deviation.

4.4.5 TEST SETUP



4.4.6 EUT OPERATING CONDITIONS

Same as Item 4.3.6.

4.4.7 TEST RESULTS

802.11b DSSS MODULATION

INPUT POWER (SYSTEM)	120Vac, 60 Hz	ENVIRONMENTAL CONDITIONS	25deg.C, 65% RH, 1015hPa
TESTED BY	Match Tsui		

CHANNEL	CHANNEL FREQUENCY (MHz)	PEAK POWER OUTPUT (mW)	PEAK POWER OUTPUT (dBm)	PEAK POWER LIMIT (dBm)	PASS / FAIL
1	2412	50.816	17.06	30	PASS
6	2437	50.699	17.05	30	PASS
11	2462	50.466	17.03	30	PASS

802.11g OFDM MODULATION

INPUT POWER (SYSTEM)	120Vac, 60 Hz	ENVIRONMENTAL CONDITIONS	25deg.C, 65% RH, 1015hPa
TESTED BY	Match Tsui		

CHANNEL	CHANNEL FREQUENCY (MHz)	PEAK POWER OUTPUT (mW)	PEAK POWER OUTPUT (dBm)	PEAK POWER LIMIT (dBm)	PASS / FAIL
1	2412	40.644	16.09	30	PASS
6	2437	40.926	16.12	30	PASS
11	2462	40.365	16.06	30	PASS



DRAFT 802.11n (20MHz) OFDM MODULATION

INPUT POWER (SYSTEM)	120Vac, 60 Hz	ENVIRONMENTAL CONDITIONS	25deg.C, 65% RH, 1015hPa
TESTED BY	Match Tsui		

CHANNEL	CHANNEL FREQUENCY (MHz)	PEAK POWER OUTPUT (mW)	PEAK POWER OUTPUT (dBm)	PEAK POWER LIMIT (dBm)	PASS / FAIL
1	2412	31.915	15.04	30	PASS
6	2437	32.285	15.09	30	PASS
11	2462	32.137	15.07	30	PASS

DRAFT 802.11n (40MHz) OFDM MODULATION

INPUT POWER (SYSTEM)	120Vac, 60 Hz	ENVIRONMENTAL CONDITIONS	25deg.C, 65% RH, 1015hPa
TESTED BY	Match Tsui		

CHANNEL	CHANNEL FREQUENCY (MHz)	PEAK POWER OUTPUT (mW)	PEAK POWER OUTPUT (dBm)	PEAK POWER LIMIT (dBm)	PASS / FAIL
1	2422	25.235	14.02	30	PASS
4	2437	25.468	14.06	30	PASS
7	2452	25.527	14.07	30	PASS



4.5 POWER SPECTRAL DENSITY MEASUREMENT

4.5.1 LIMITS OF POWER SPECTRAL DENSITY MEASUREMENT

The Maximum of Power Spectral Density Measurement is 8dBm.

4.5.2 TEST INSTRUMENTS

DESCRIPTION & MANUFACTURER	MODEL NO.	SERIAL NO.	CALIBRATED UNTIL
R&S SPECTRUM ANALYZER	FSP40	100040	Jun. 28, 2008

NOTE: The calibration interval of the above test instruments is 12 months and the calibrations are traceable to NML/ROC and NIST/USA.

4.5.3 TEST PROCEDURE

The transmitter output was connected to the spectrum analyzer through an attenuator, the bandwidth of the fundamental frequency was measured with the spectrum analyzer using 3kHz RBW and 30kHz VBW, set sweep time = span/3kHz. The power spectral density was measured and recorded.

The sweep time is allowed to be longer than span/3kHz for a full response of the mixer in the spectrum analyzer.

4.5.4 DEVIATION FROM TEST STANDARD

No deviation.

4.5.5 TEST SETUP

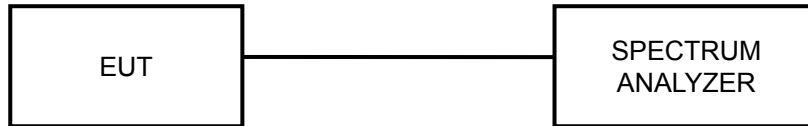

4.5.6 EUT OPERATING CONDITION

Same as Item 4.3.6.



4.5.7 TEST RESULTS

802.11b DSSS MODULATION

INPUT POWER (SYSTEM)	120Vac, 60 Hz	ENVIRONMENTAL CONDITIONS	25deg.C, 65% RH, 1015hPa
TESTED BY	Match Tsui		

CHANNEL	CHANNEL FREQUENCY (MHz)	RF POWER LEVEL IN 3kHz BW (dBm)	MAXIMUM LIMIT (dBm)	PASS / FAIL
1	2412	-13.88	8	PASS
6	2437	-13.79	8	PASS
11	2462	-13.77	8	PASS

CH 1

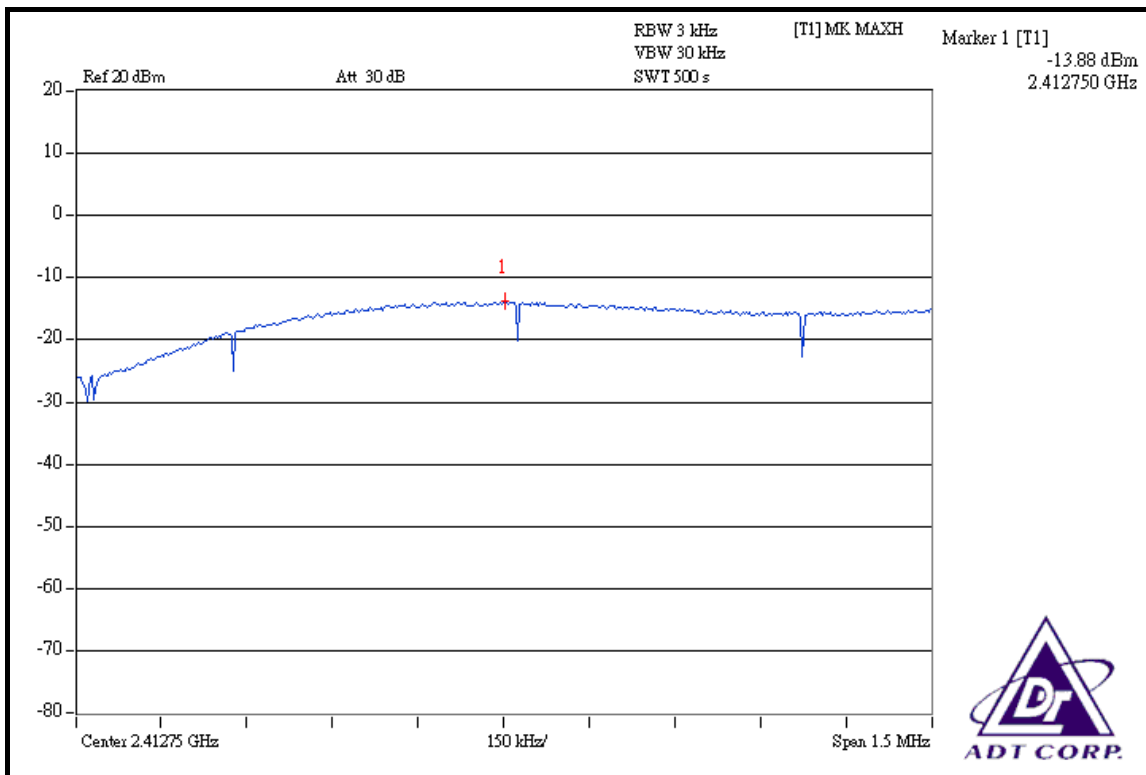

CH 6

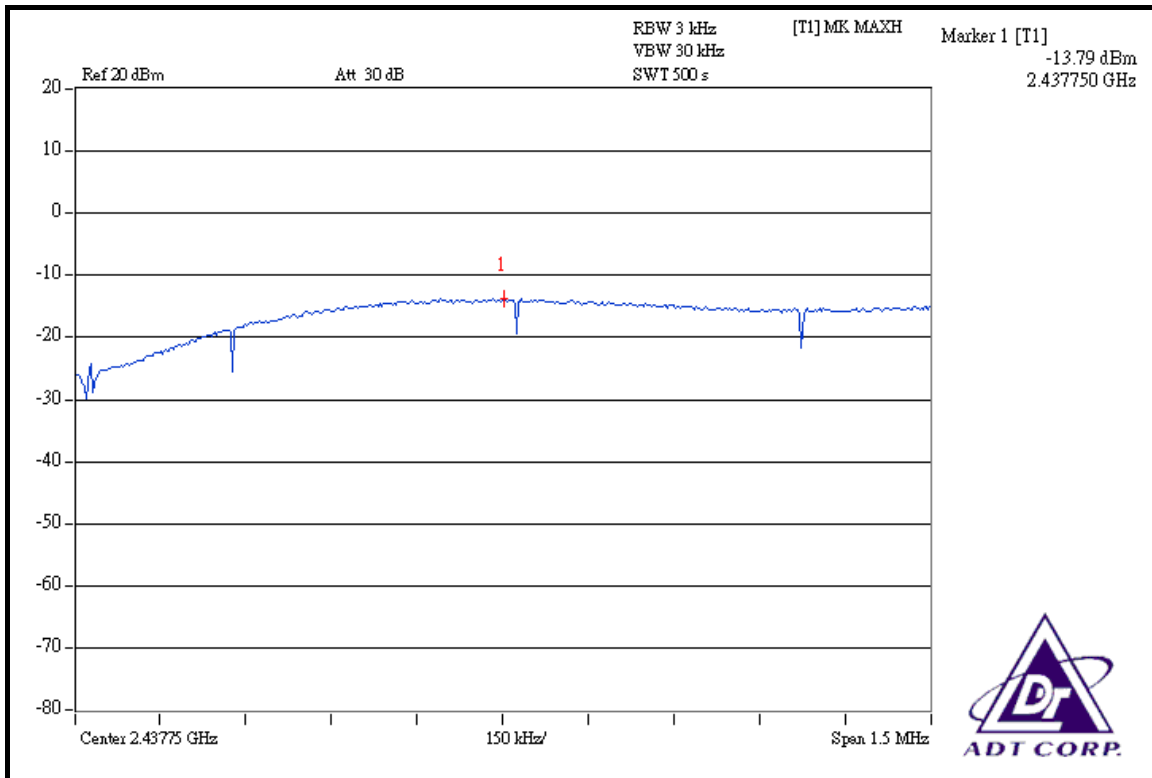

CH 11

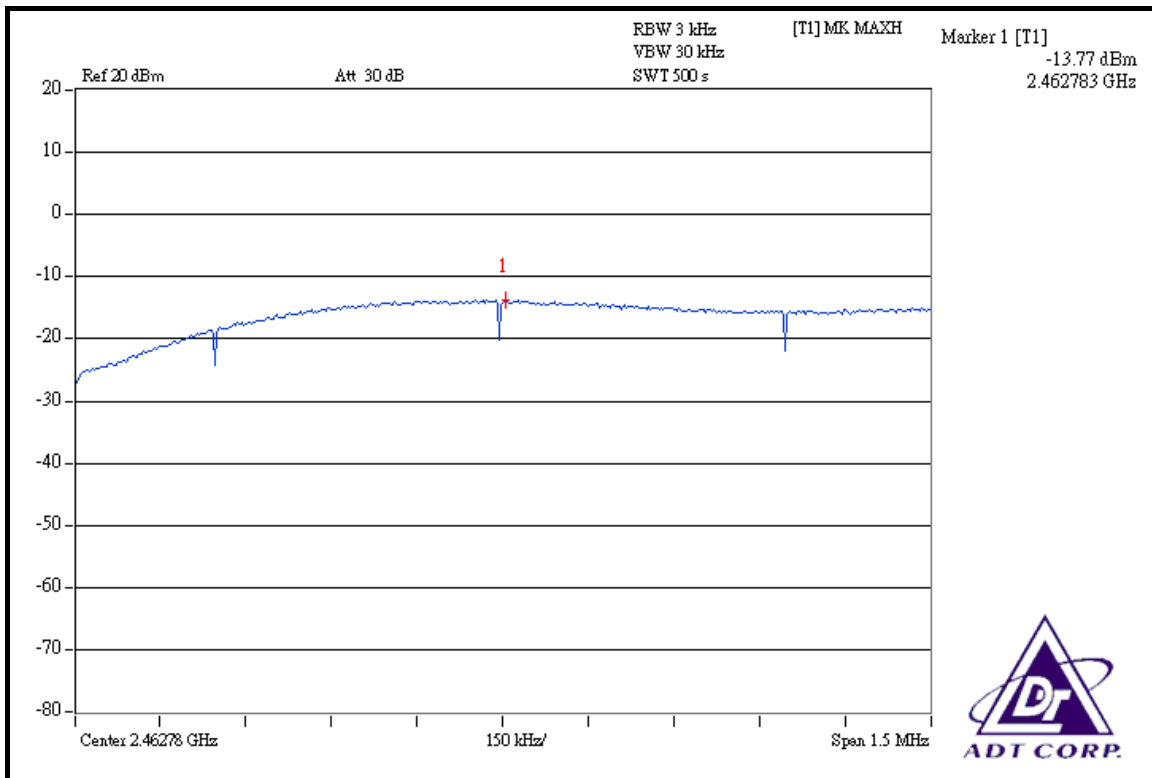



802.11g OFDM MODULATION

INPUT POWER (SYSTEM)	120Vac, 60 Hz	ENVIRONMENTAL CONDITIONS	25deg.C, 65% RH, 1015hPa
TESTED BY	Match Tsui		

CHANNEL	CHANNEL FREQUENCY (MHz)	RF POWER LEVEL IN 3kHz BW (dBm)	MAXIMUM LIMIT (dBm)	PASS / FAIL
1	2412	-16.36	8	PASS
6	2437	-16.43	8	PASS
11	2462	-16.39	8	PASS

CH 1

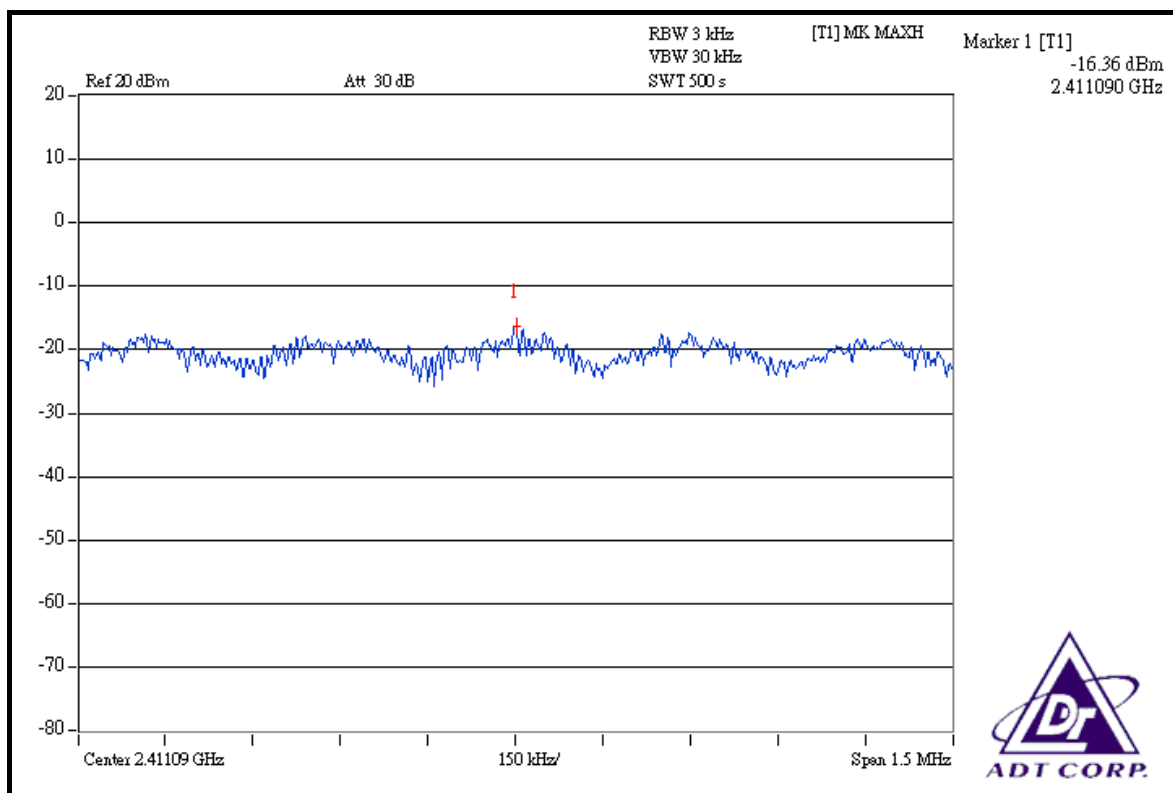



CH 6

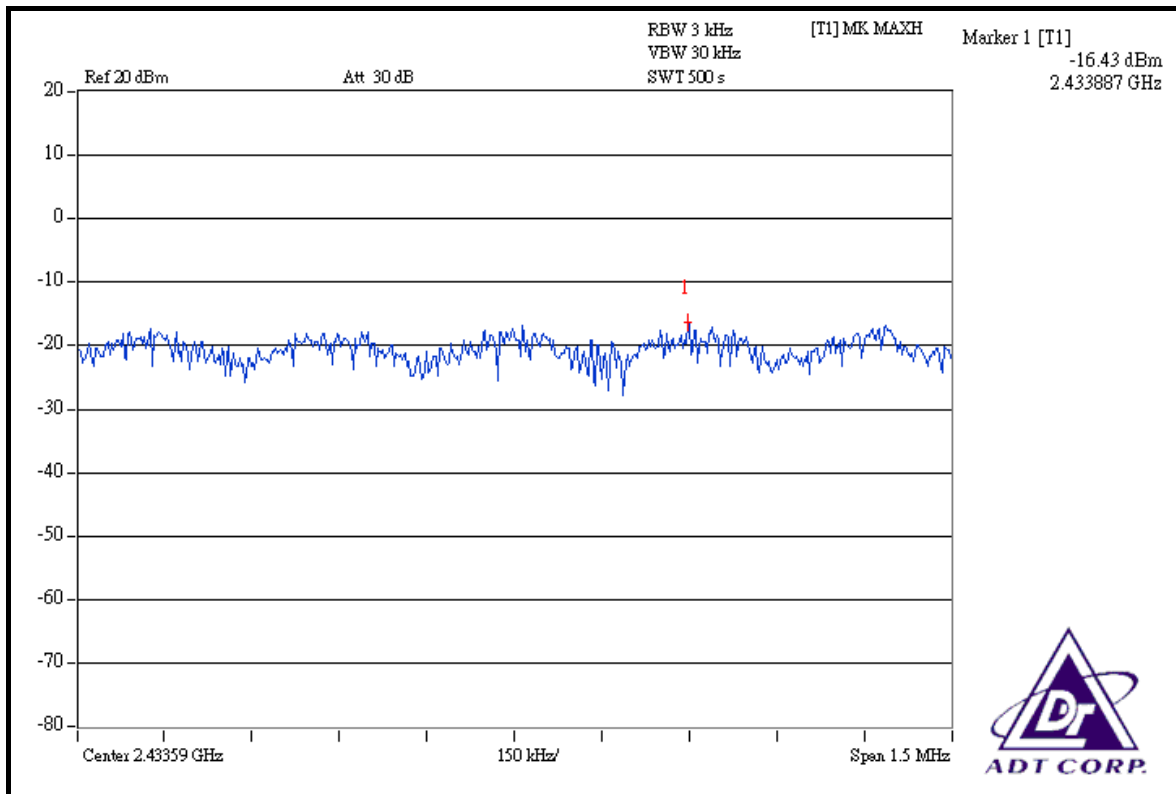

CH 11

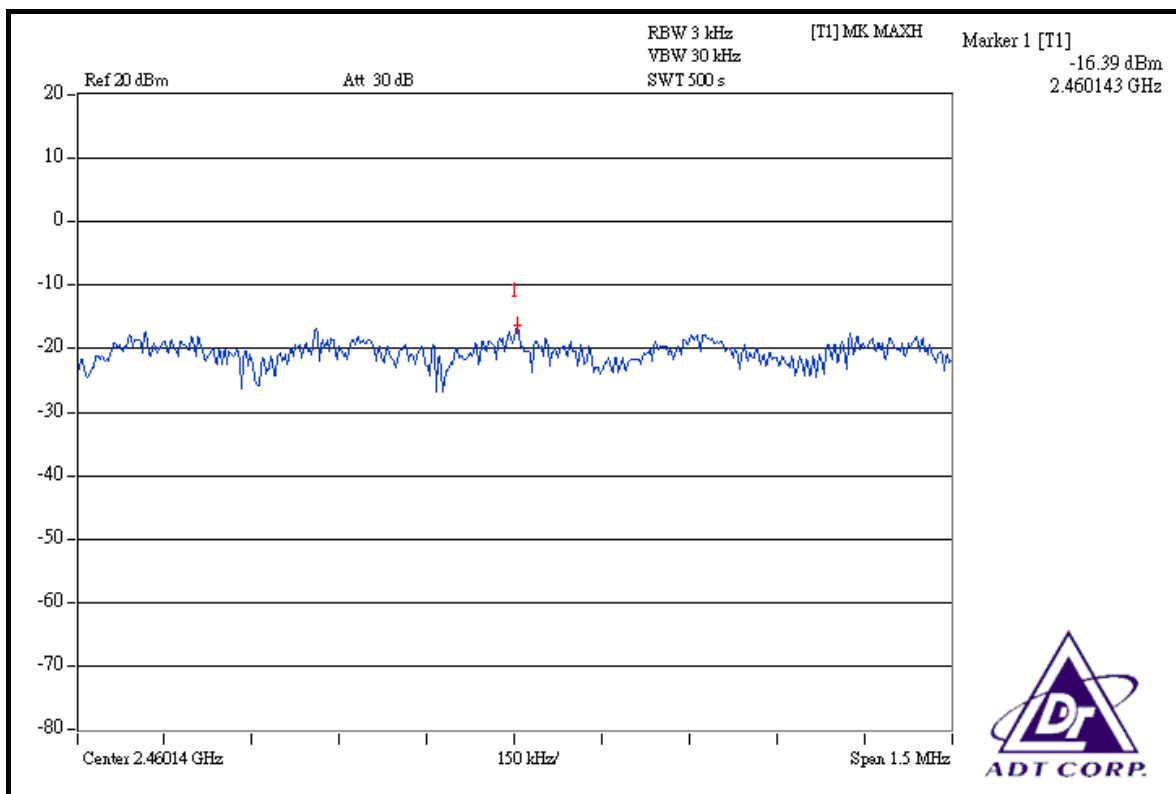



DRAFT 802.11n (20MHz) OFDM MODULATION

INPUT POWER (SYSTEM)	120Vac, 60 Hz	ENVIRONMENTAL CONDITIONS	25deg.C, 65% RH, 1015hPa
TESTED BY	Match Tsui		

CHANNEL	CHANNEL FREQUENCY (MHz)	RF POWER LEVEL IN 3kHz BW (dBm)	MAXIMUM LIMIT (dBm)	PASS / FAIL
1	2412	-16.50	8	PASS
6	2437	-16.53	8	PASS
11	2462	-16.33	8	PASS

CH 1

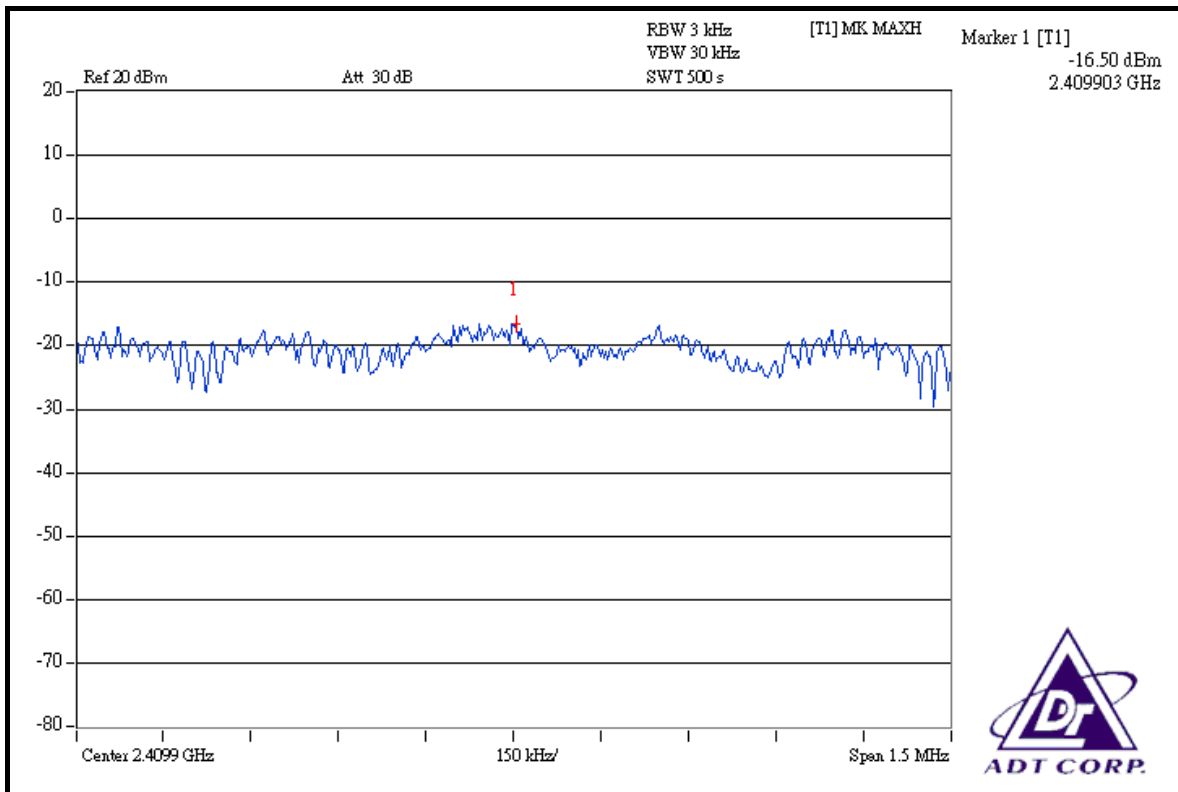



CH 6

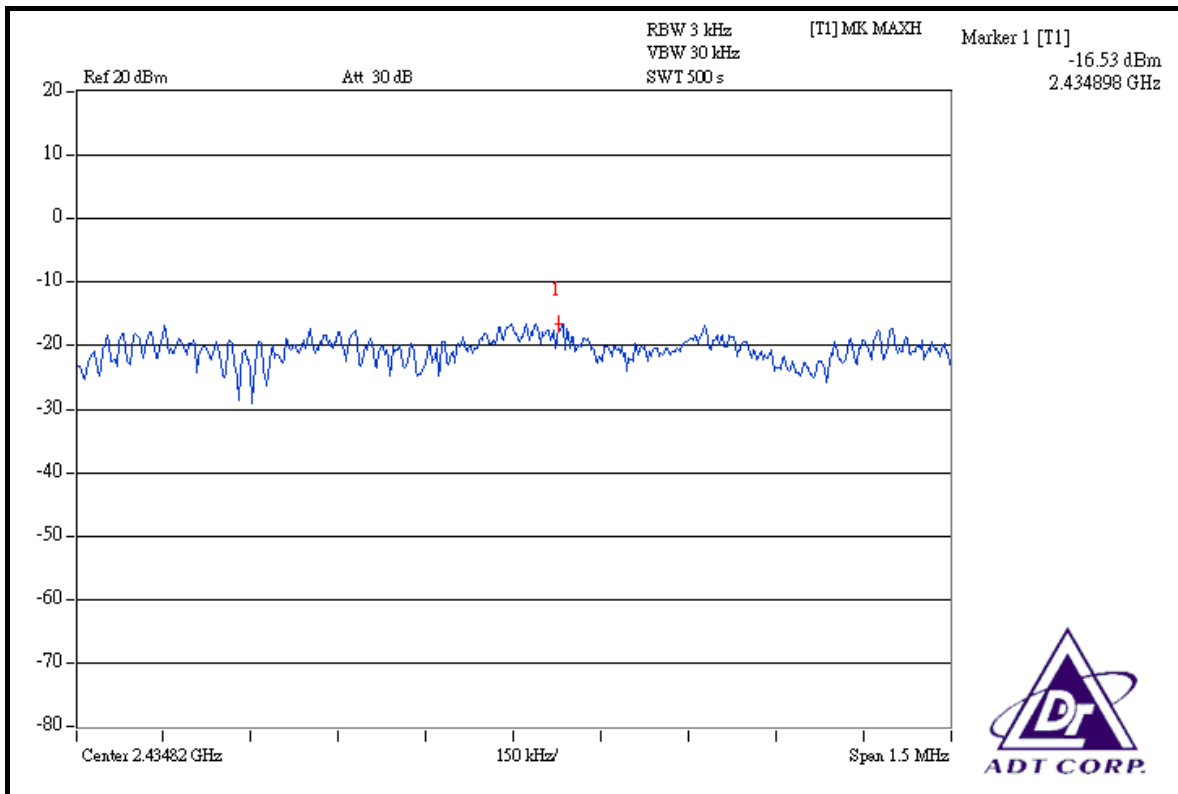

CH 11

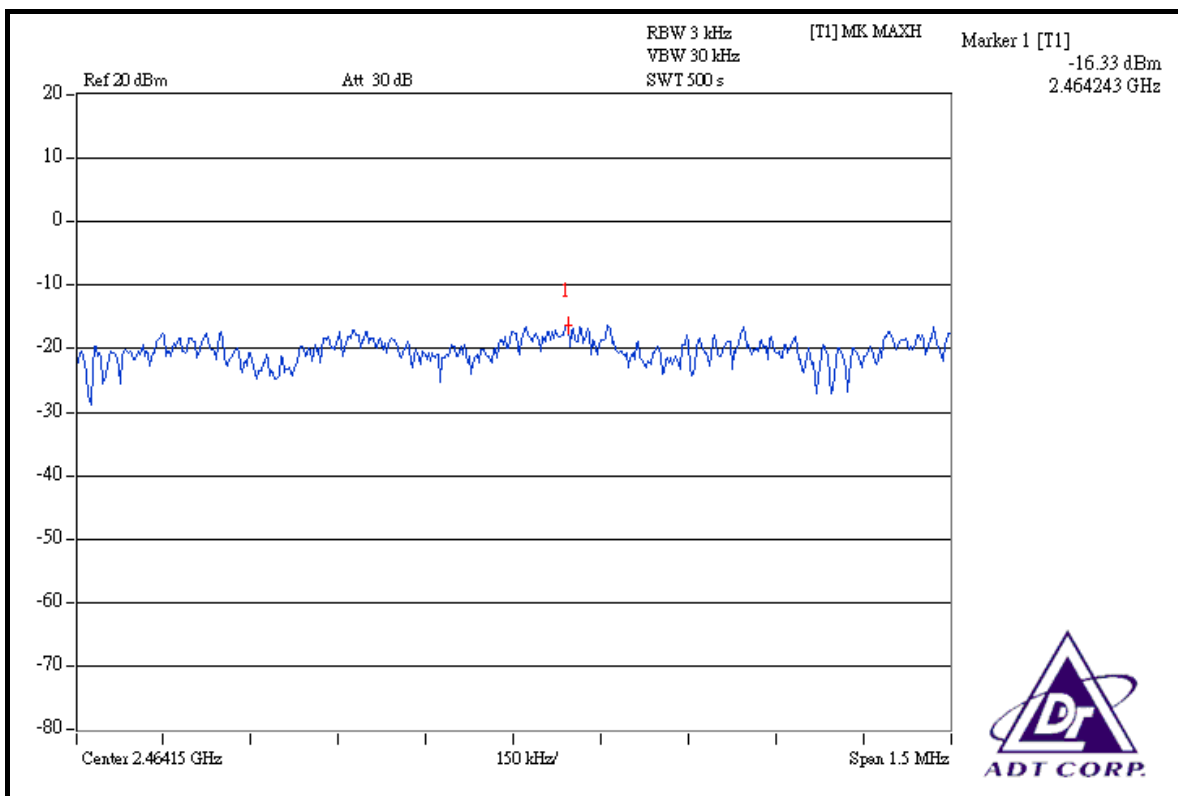



DRAFT 802.11n (40MHz) OFDM MODULATION

INPUT POWER (SYSTEM)	120Vac, 60 Hz	ENVIRONMENTAL CONDITIONS	25deg.C, 65% RH, 1015hPa
TESTED BY	Match Tsui		

CHANNEL	CHANNEL FREQUENCY (MHz)	RF POWER LEVEL IN 3kHz BW (dBm)	MAXIMUM LIMIT (dBm)	PASS / FAIL
1	2422	-20.63	8	PASS
4	2437	-20.40	8	PASS
7	2452	-20.46	8	PASS

CH 1

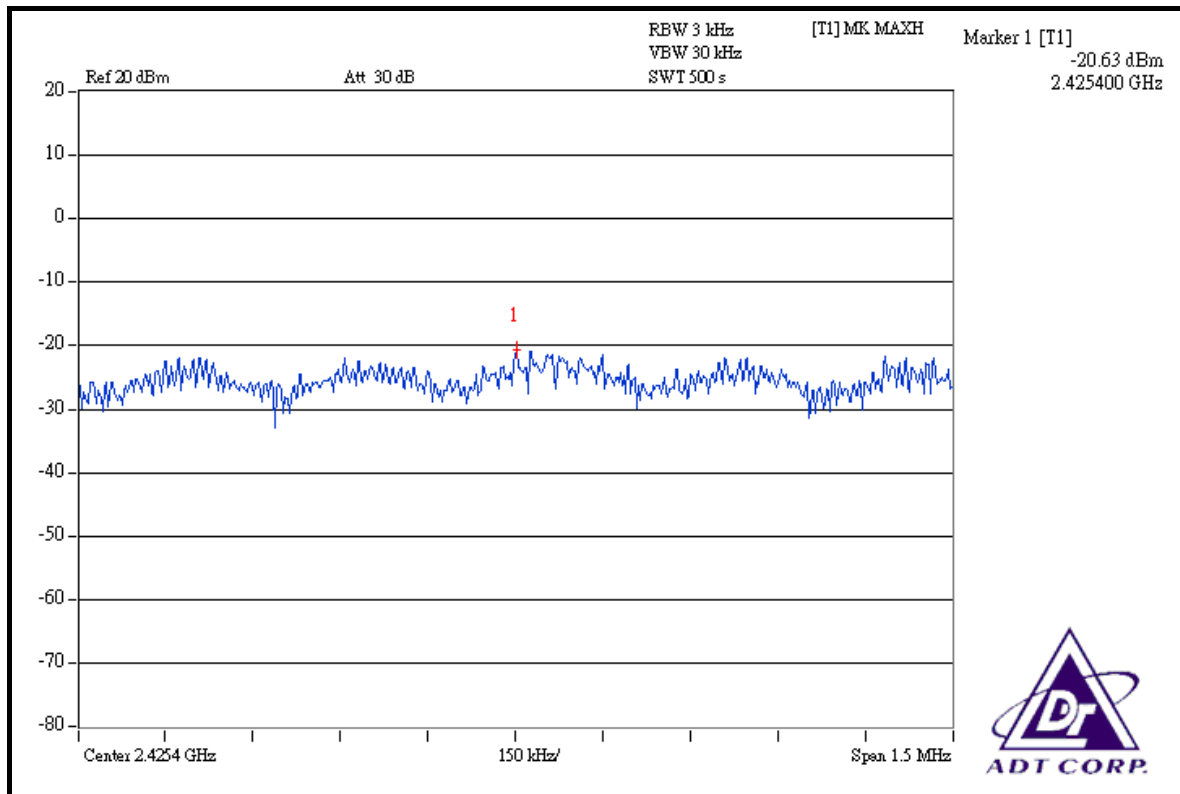



CH 4

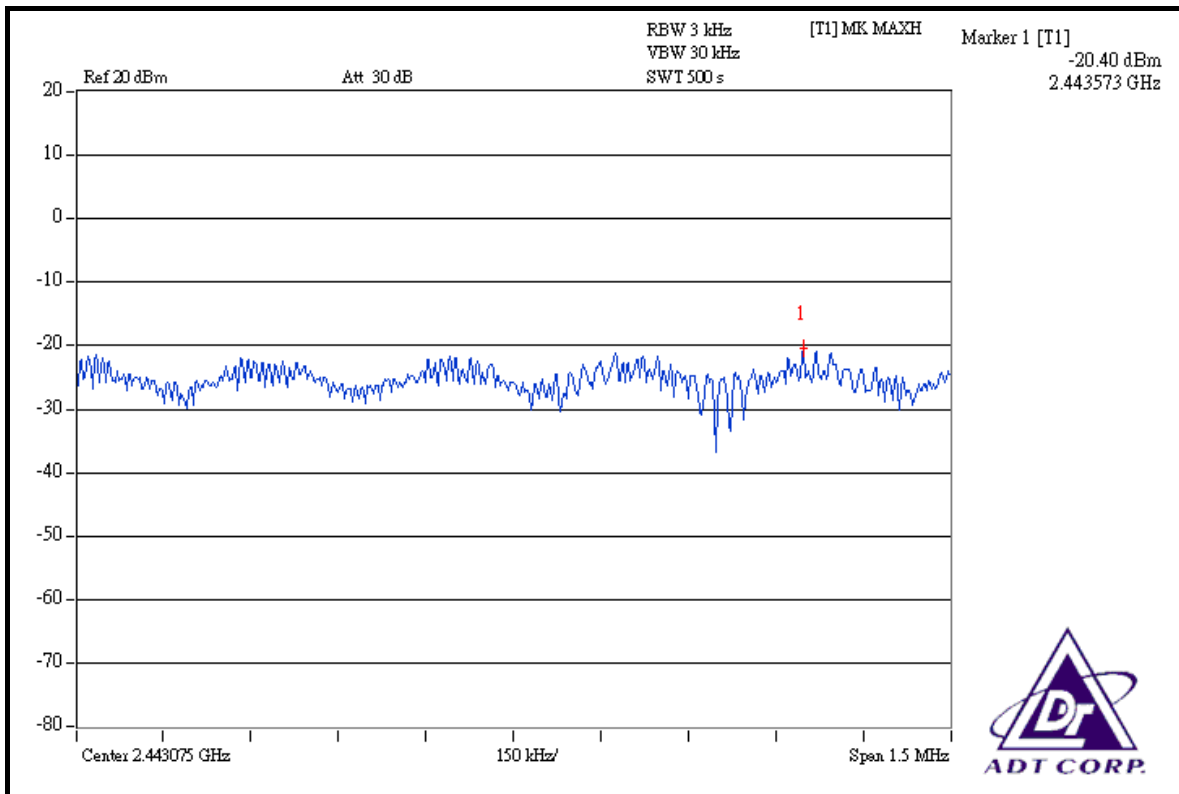

CH 7

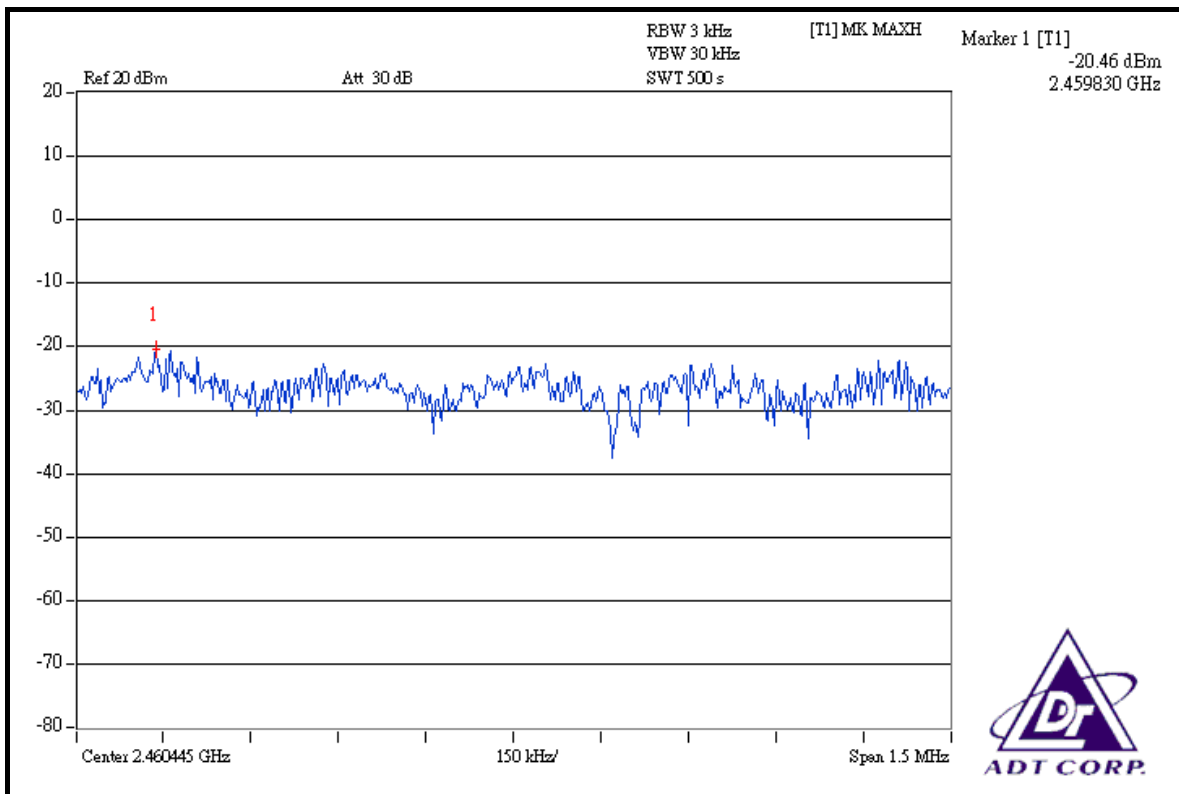



4.6 BAND EDGES MEASUREMENT

4.6.1 LIMITS OF BAND EDGES MEASUREMENT

Below -20dB of the highest emission level of operating band (in 100kHz Resolution Bandwidth).

4.6.2 TEST INSTRUMENTS

DESCRIPTION & MANUFACTURER	MODEL NO.	SERIAL NO.	CALIBRATED UNTIL
R&S SPECTRUM ANALYZER	FSP40	100040	Jun. 28, 2008

NOTE: The calibration interval of the above test instruments is 12 months and the calibrations are traceable to NML/ROC and NIST/USA.

4.6.3 TEST PROCEDURE

The transmitter output was connected to the spectrum analyzer via a low loss cable. Set both RBW and VBW of spectrum analyzer to 100kHz with suitable frequency span including 10Hz bandwidth from band edge. The band edges was measured and recorded.

The spectrum plots (Peak RBW = 100kHz, VBW = 300kHz; Average RBW = 1MHz, VBW = 10Hz) are attached on the following pages.

4.6.4 DEVIATION FROM TEST STANDARD

No deviation.

4.6.5 EUT OPERATING CONDITION

Same as Item 4.3.6.

4.6.6 TEST RESULTS

The spectrum plots are attached on the following 24 images. D1 line indicates the highest level, and D2 line indicates the 20dB offset below D1. It shows compliance with the requirement in part 15.247(d).

802.11b DSSS MODULATION

NOTE 1:

The band edge emission plot on the next page shows 52.53dBc between carrier maximum power and local maximum emission in restrict band (2.33460GHz). The emission of carrier strength list in the test result of channel 1 at the item 4.2.7 is 108.08dBuV/m (Peak), so the maximum field strength in restrict band is $108.08 - 52.53 = 55.55$ dBuV/m which is under 74dBuV/m limit.

The band edge emission plot on the next page shows 62.48dBc between carrier maximum power and local maximum emission in restrict band (2.38720GHz). The emission of carrier strength list in the test result of channel 1 at the item 4.2.7 is 103.75dBuV/m (Average), so the maximum field strength in restrict band is $103.75 - 62.48 = 41.27$ dBuV/m which is under 54dBuV/m limit.

NOTE 2:

The band edge emission plot on the next second page shows 53.66dBc between carrier maximum power and local maximum emission in restrict band (2.48460GHz). The emission of carrier strength list in the test result of channel 11 at the item 4.2.7 is 108.53dBuV/m (Peak), so the maximum field strength in restrict band is $108.53 - 53.66 = 54.87$ dBuV/m which is under 74dBuV/m limit.

The band edge emission plot on the next third page shows 60.05dBc between carrier maximum power and local maximum emission in restrict band (2.48350GHz). The emission of carrier strength list in the test result of channel 11 at the item 4.2.7 is 104.07dBuV/m (Average), so the maximum field strength in restrict band is $104.07 - 60.05 = 44.02$ dBuV/m which is under 54dBuV/m limit.

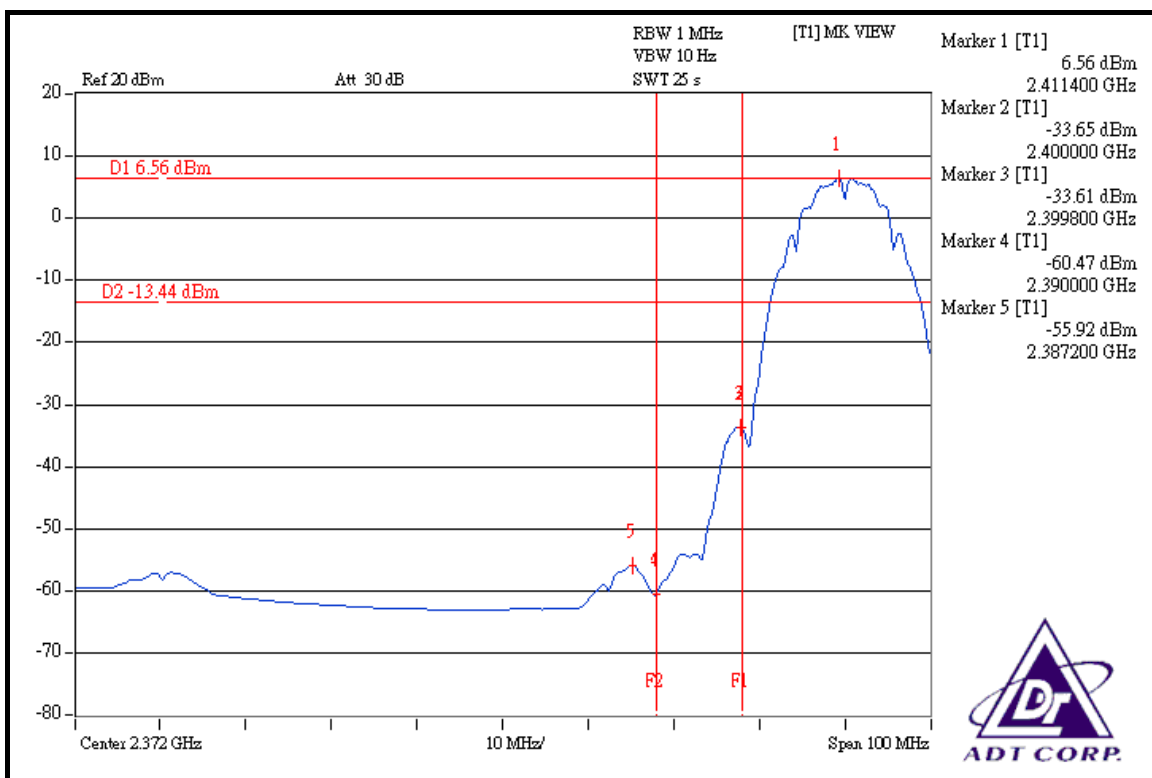
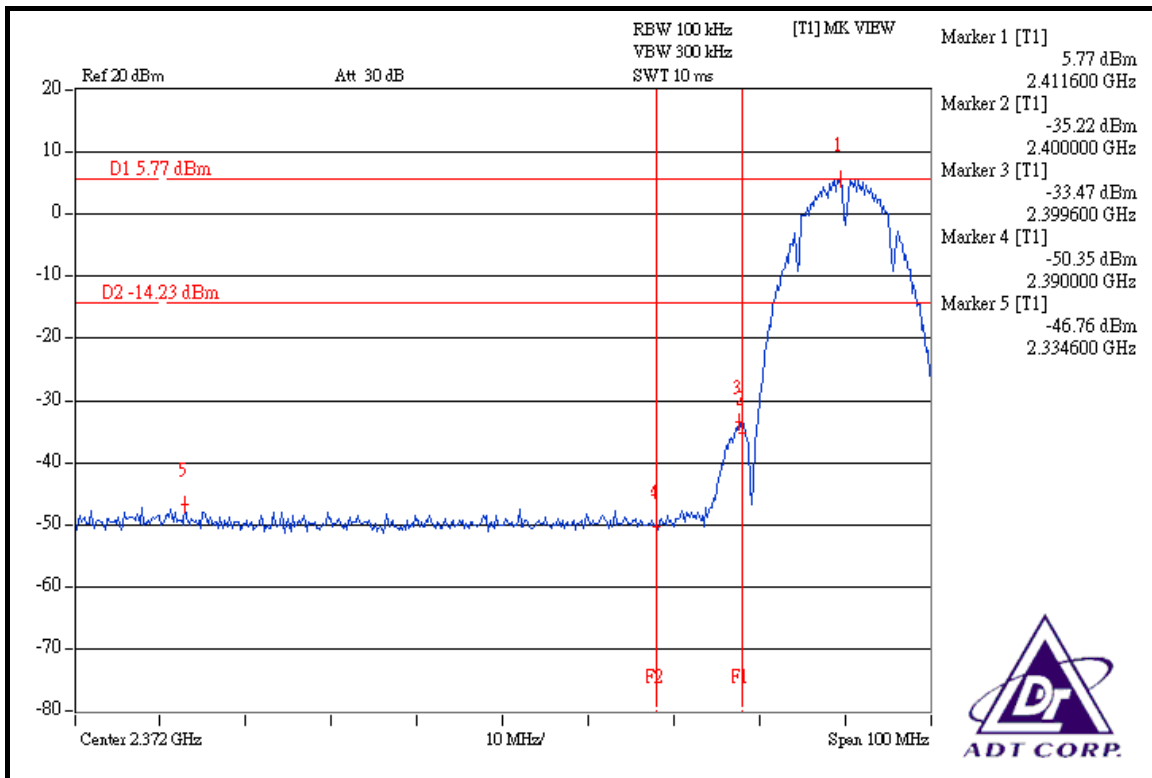

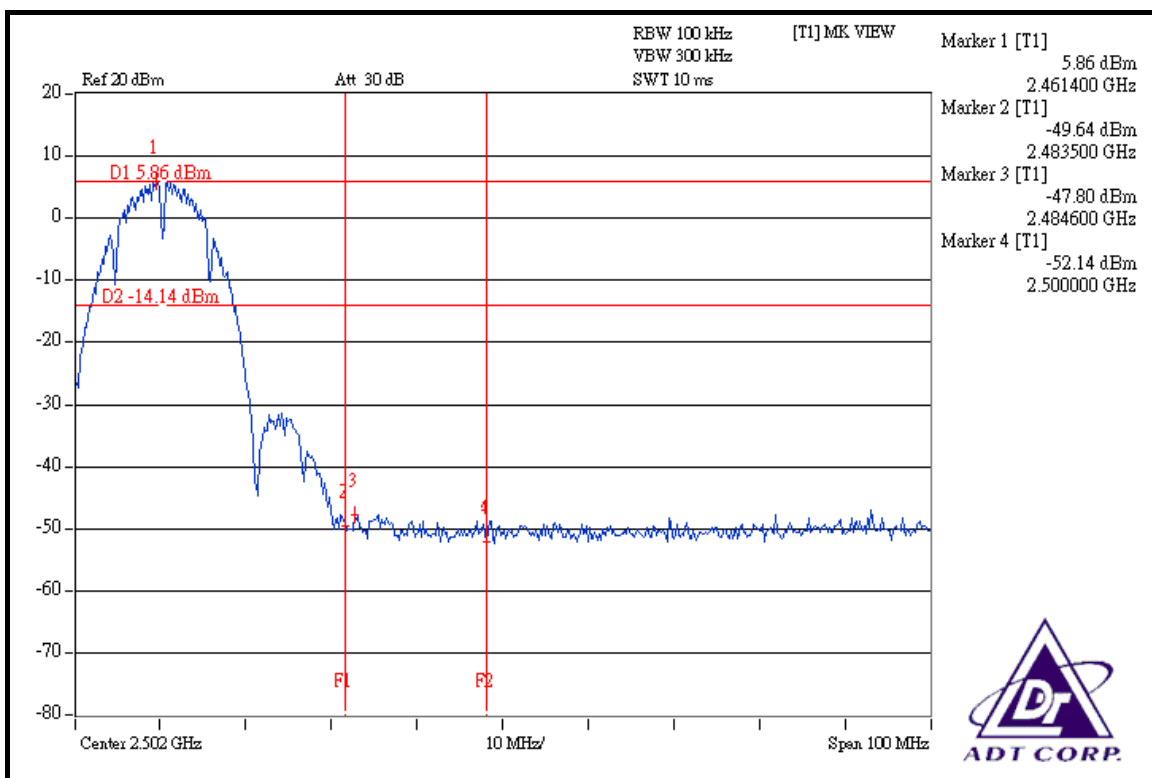
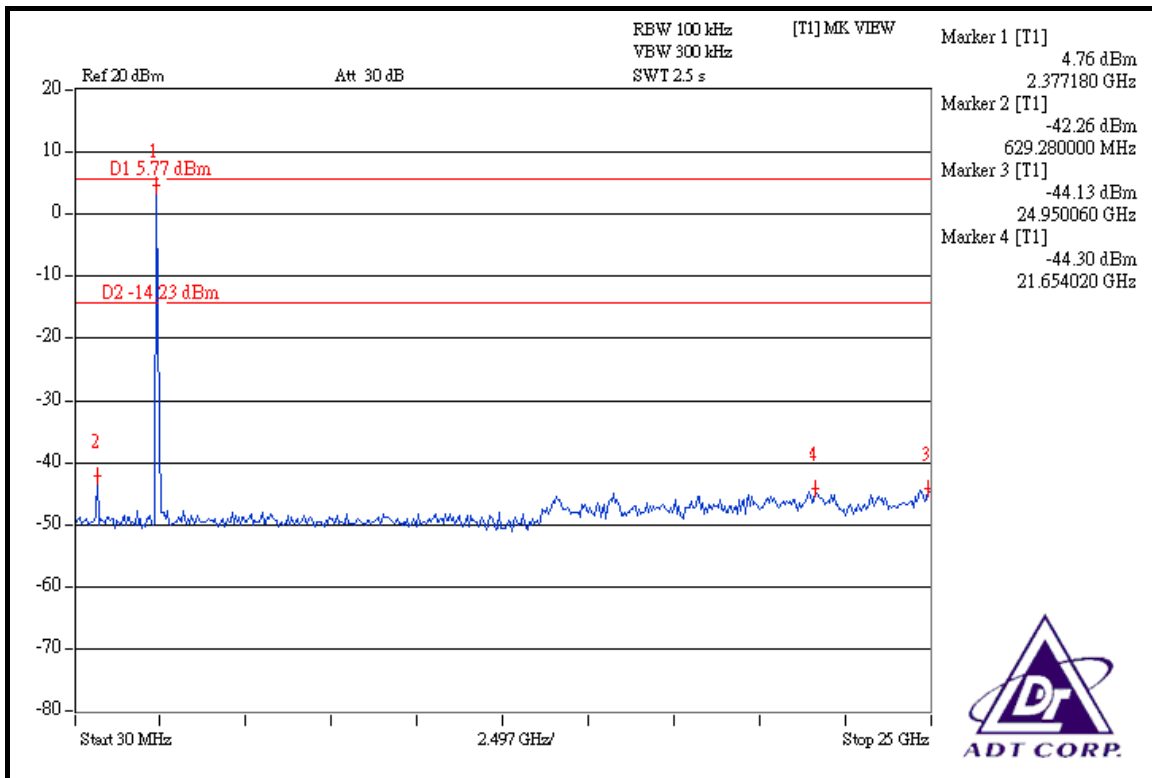

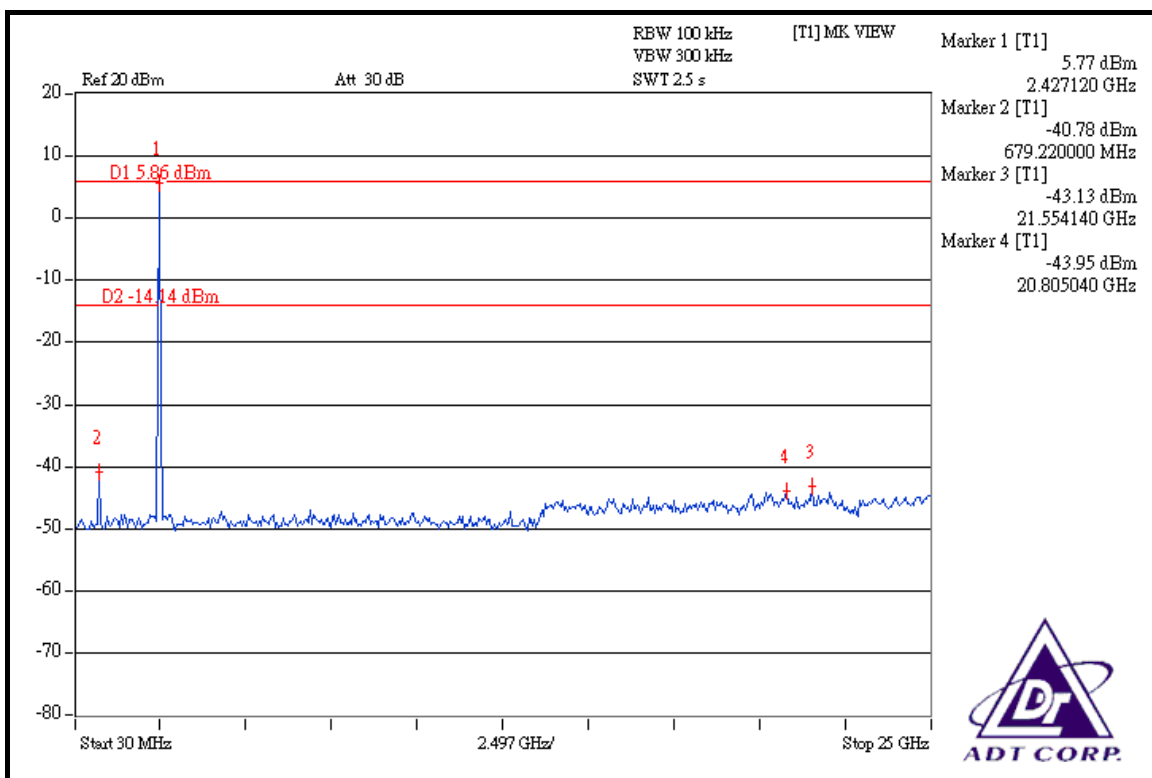
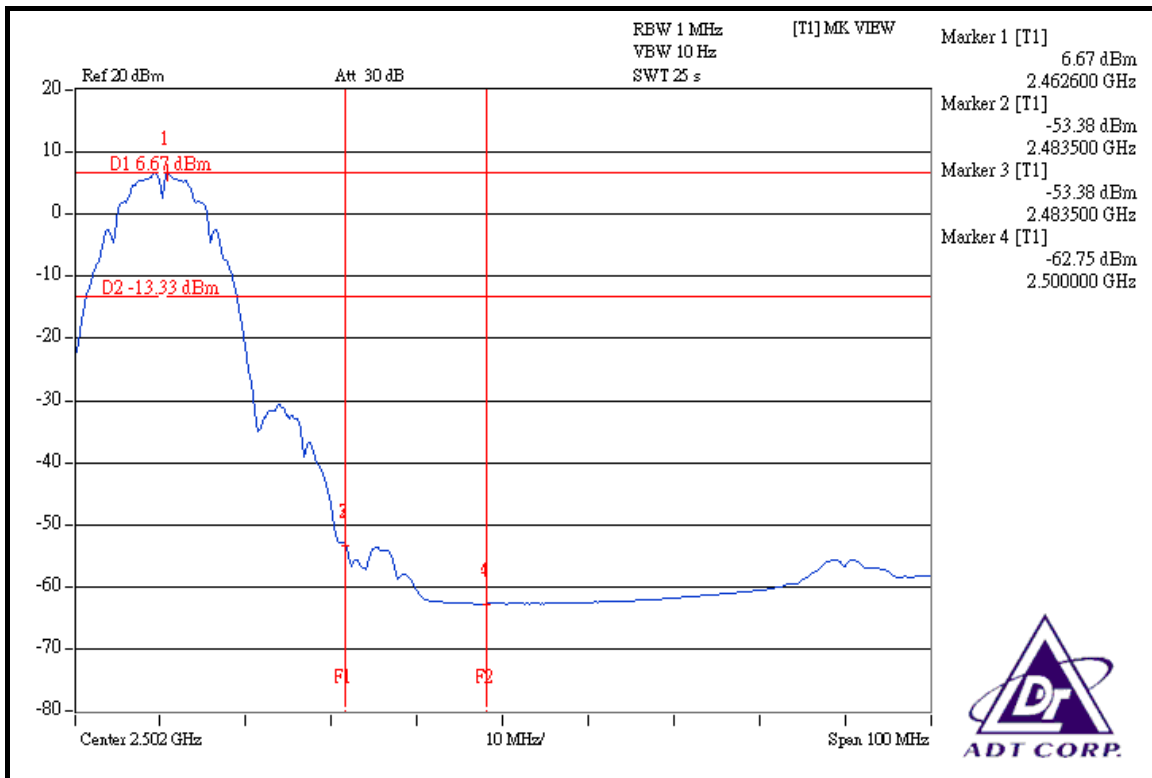

802.11g OFDM MODULATION

NOTE 1:

The band edge emission plot on the next page shows 44.89dBc between carrier maximum power and local maximum emission in restrict band (2.38960GHz). The emission of carrier strength list in the test result of channel 1 at the item 4.2.7 is 108.17dBuV/m (Peak), so the maximum field strength in restrict band is $108.17 - 44.89 = 63.28$ dBuV/m which is under 74dBuV/m limit.

The band edge emission plot on the next page shows 54.03dBc between carrier maximum power and local maximum emission in restrict band (2.39000GHz). The emission of carrier strength list in the test result of channel 1 at the item 4.2.7 is 97.98dBuV/m (Average), so the maximum field strength in restrict band is $97.98 - 54.03 = 43.95$ dBuV/m which is under 54dBuV/m limit.

NOTE 2:

The band edge emission plot on the next second page shows 37.50dBc between carrier maximum power and local maximum emission in restrict band (2.48420GHz). The emission of carrier strength list in the test result of channel 11 at the item 4.2.7 is 108.06dBuV/m (Peak), so the maximum field strength in restrict band is $108.06 - 37.50 = 70.56$ dBuV/m which is under 74dBuV/m limit.

The band edge emission plot on the next third page shows 45.43dBc between carrier maximum power and local maximum emission in restrict band (2.48350GHz). The emission of carrier strength list in the test result of channel 11 at the item 4.2.7 is 96.70dBuV/m (Average), so the maximum field strength in restrict band is $96.70 - 45.43 = 51.27$ dBuV/m which is under 54dBuV/m limit.

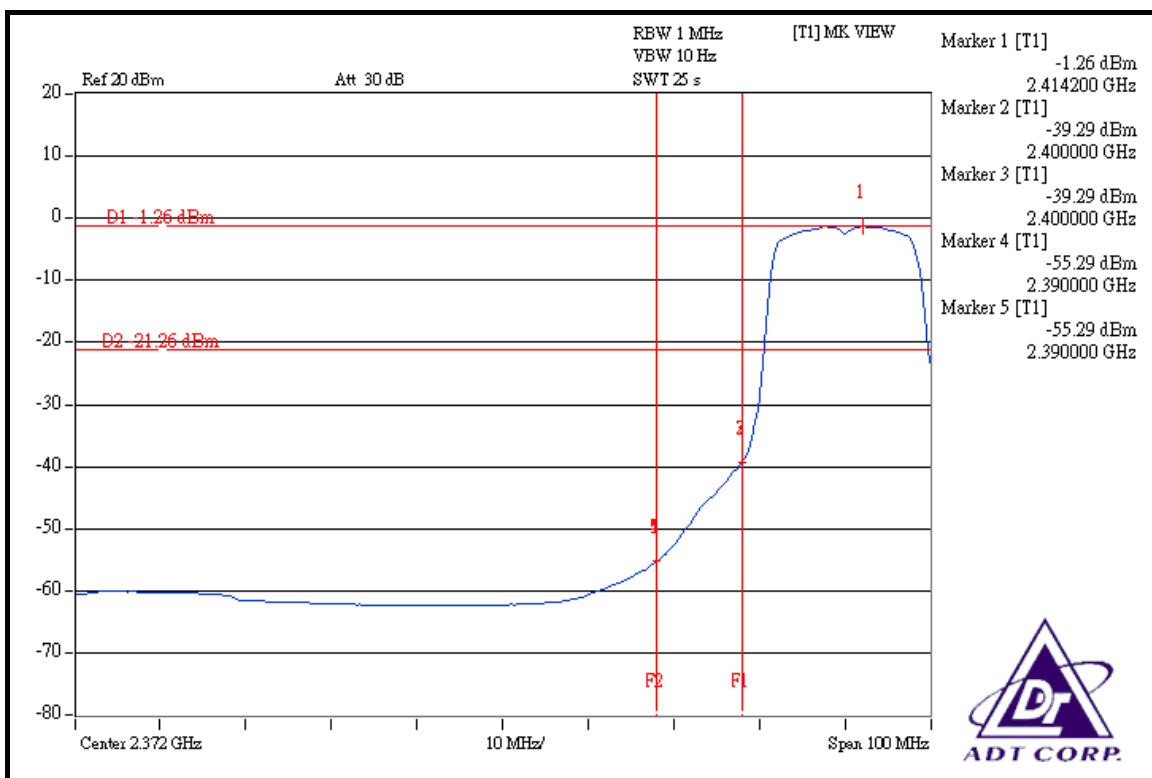
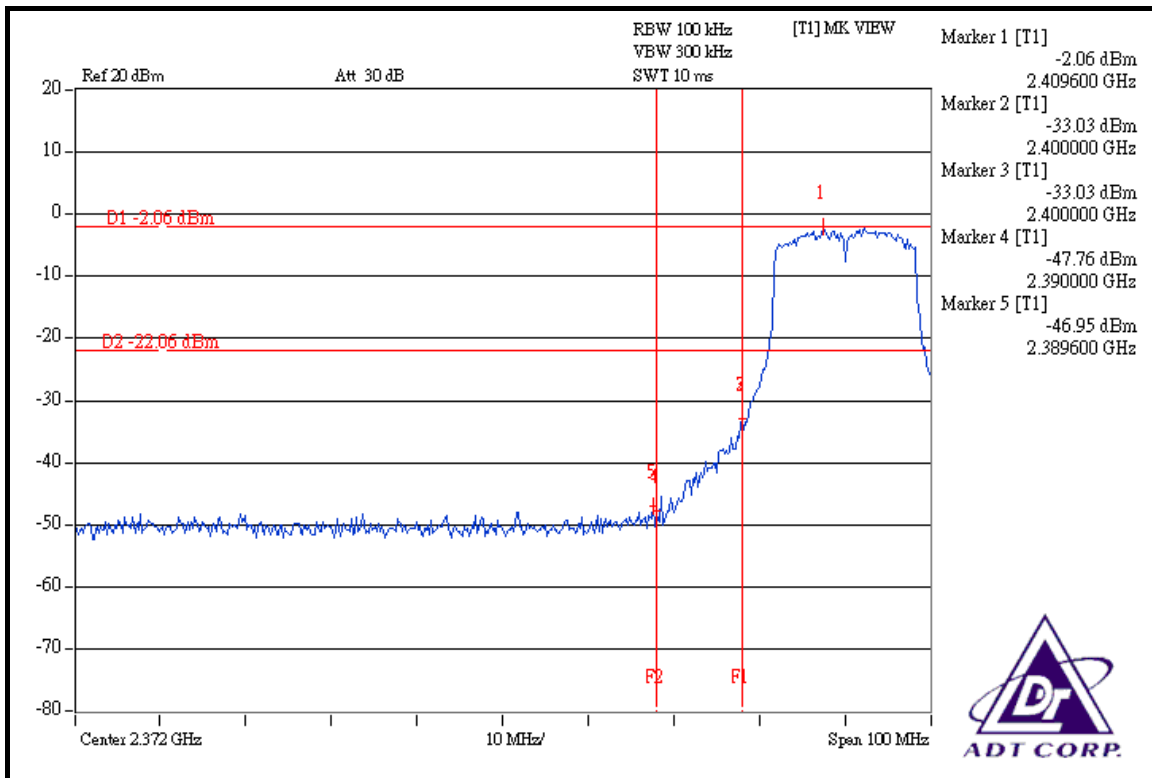

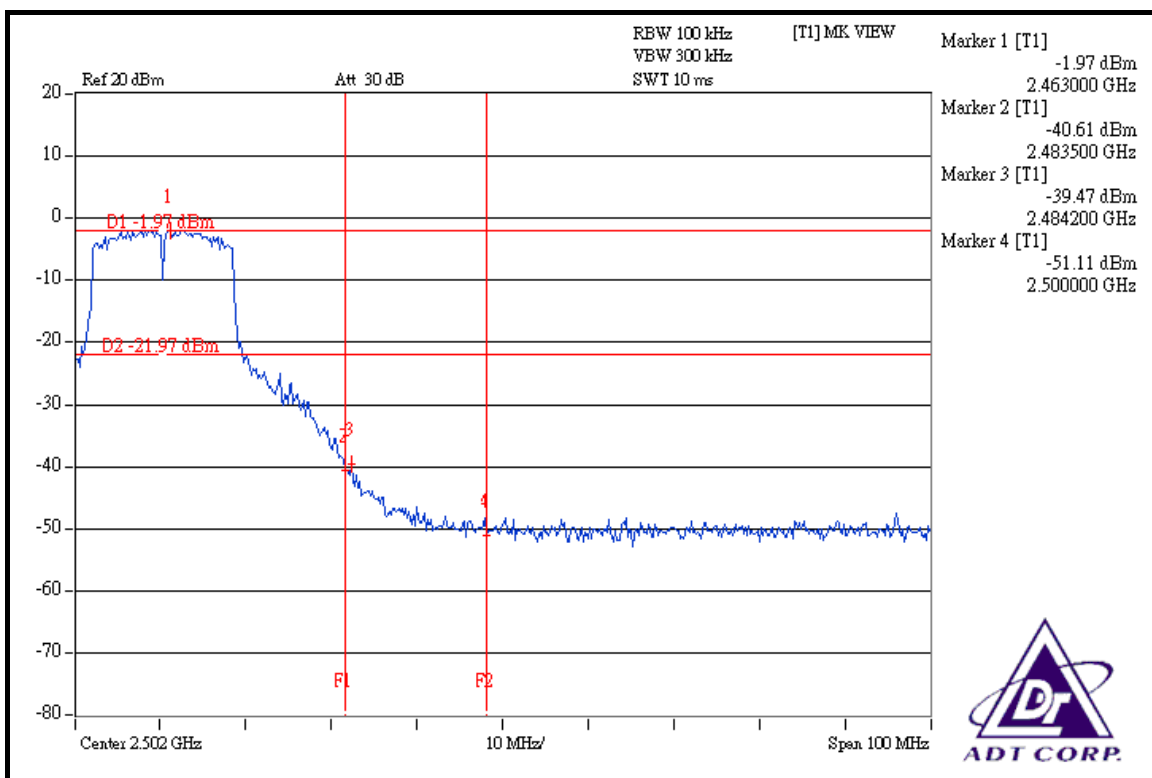
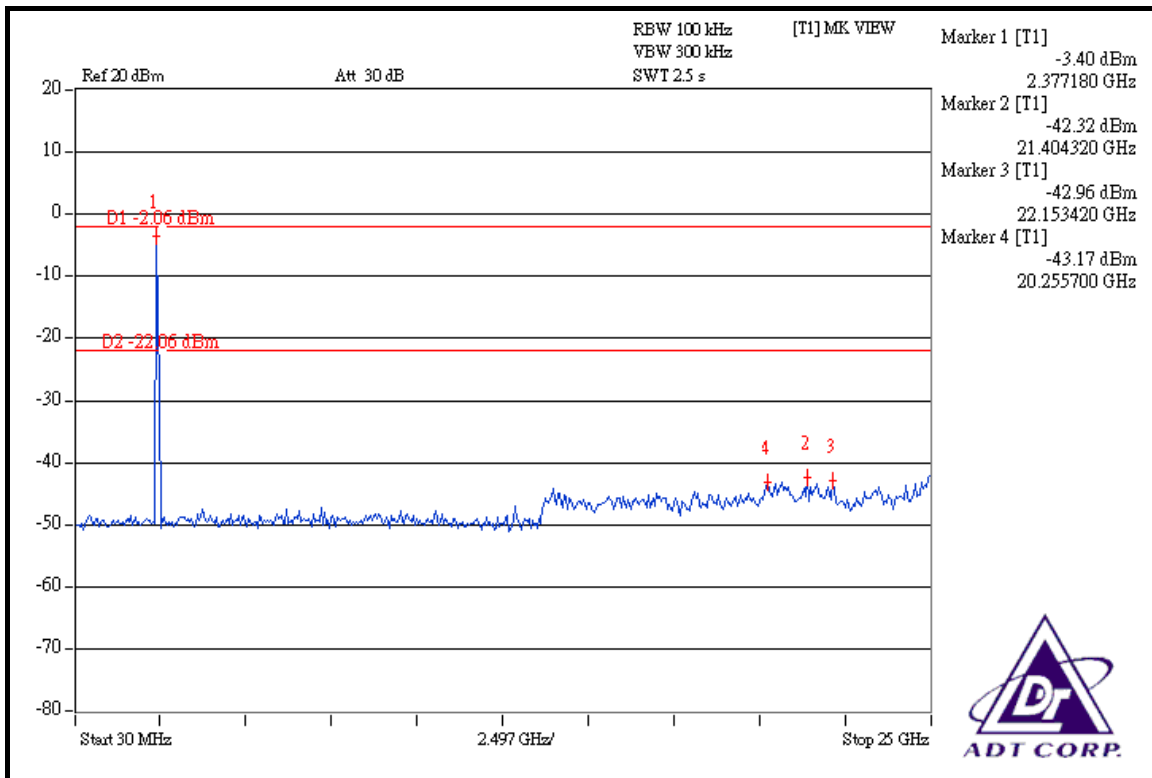

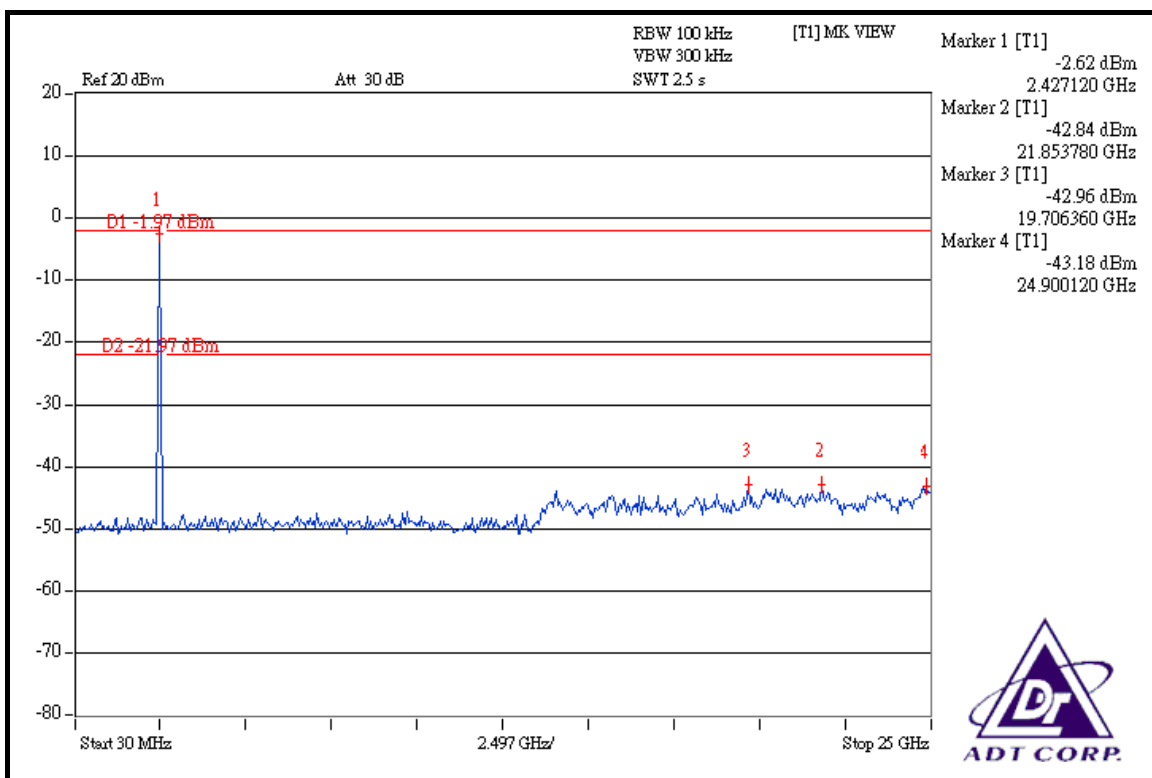
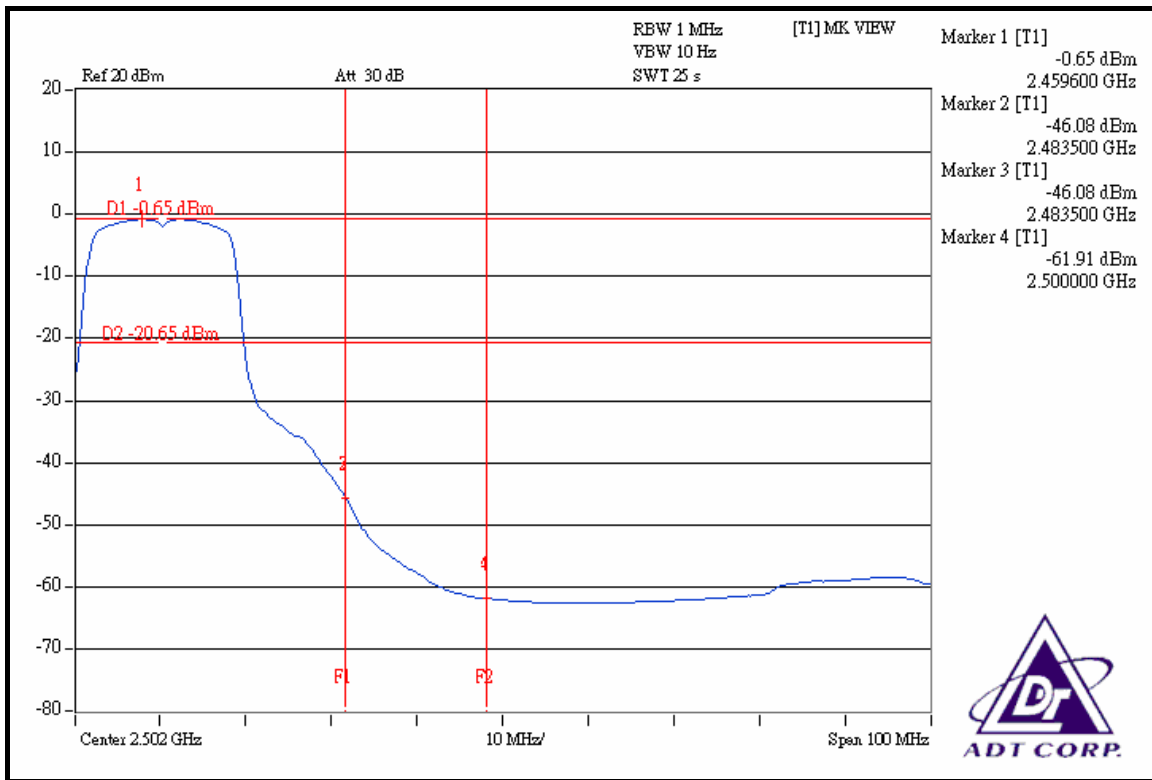

DRAFT 802.11n (20MHz) OFDM MODULATION

NOTE 1:

The band edge emission plot on the next page shows 44.87dBc between carrier maximum power and local maximum emission in restrict band (2.33220GHz). The emission of carrier strength list in the test result of channel 1 at the item 4.2.7 is 107.34dBuV/m (Peak), so the maximum field strength in restrict band is $107.34 - 44.87 = 62.47$ dBuV/m which is under 74dBuV/m limit.

The band edge emission plot on the next page shows 54.06dBc between carrier maximum power and local maximum emission in restrict band (2.39000GHz). The emission of carrier strength list in the test result of channel 1 at the item 4.2.7 is 96.55dBuV/m (Average), so the maximum field strength in restrict band is $96.55 - 54.06 = 42.49$ dBuV/m which is under 54dBuV/m limit.

NOTE 2:

The band edge emission plot on the next second page shows 36.43dBc between carrier maximum power and local maximum emission in restrict band (2.48420GHz). The emission of carrier strength list in the test result of channel 11 at the item 4.2.7 is 107.72dBuV/m (Peak), so the maximum field strength in restrict band is $107.72 - 36.43 = 71.29$ dBuV/m which is under 74dBuV/m limit.

The band edge emission plot on the next third page shows 44.01dBc between carrier maximum power and local maximum emission in restrict band (2.48350GHz). The emission of carrier strength list in the test result of channel 11 at the item 4.2.7 is 96.28dBuV/m (Average), so the maximum field strength in restrict band is $96.28 - 44.01 = 52.27$ dBuV/m which is under 54dBuV/m limit.

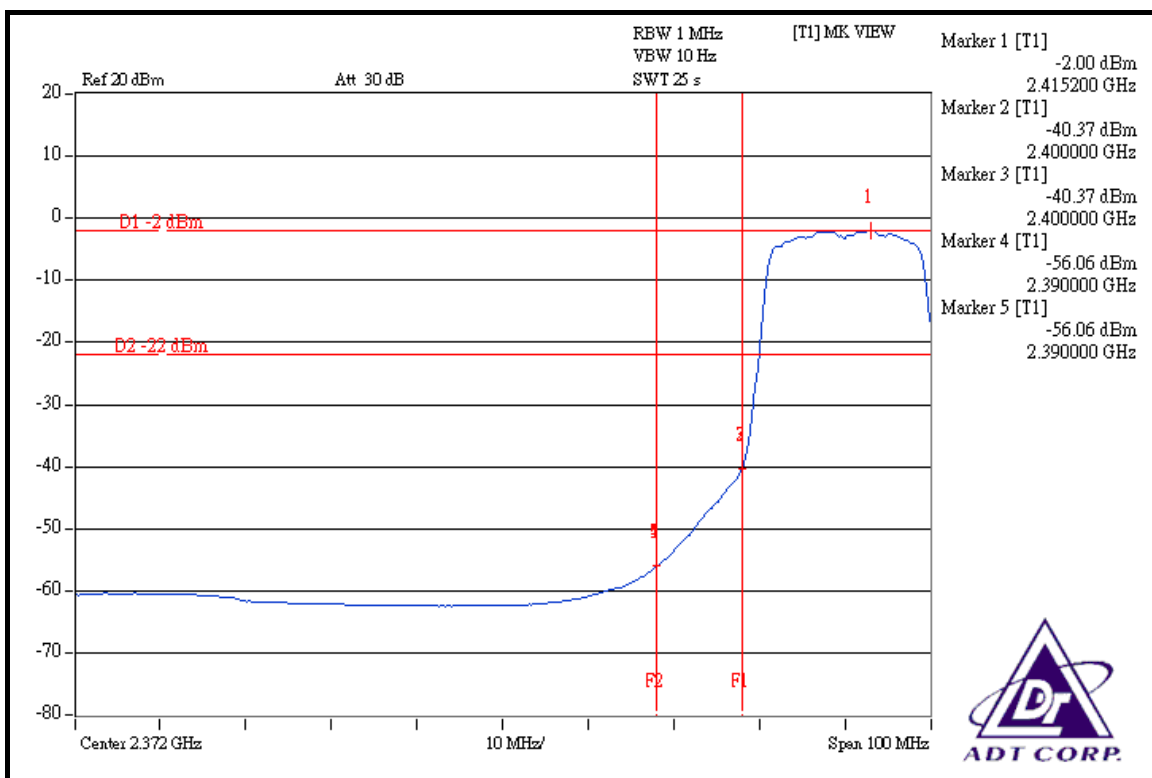
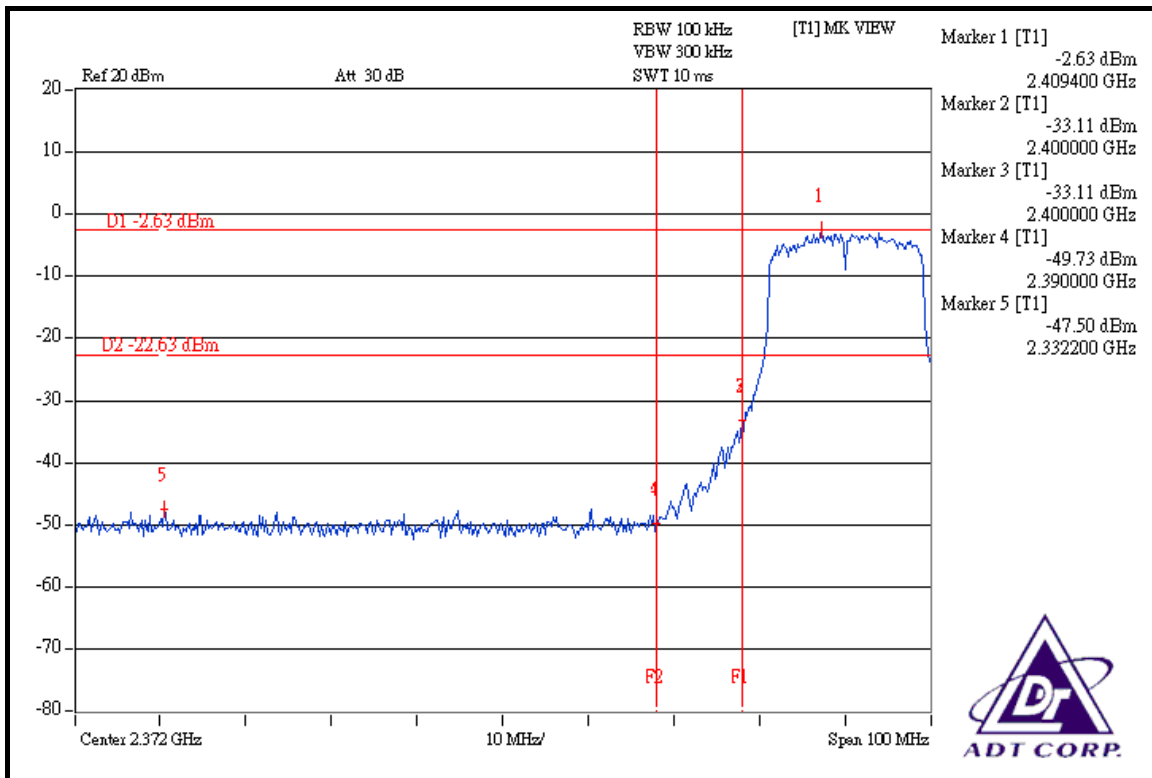

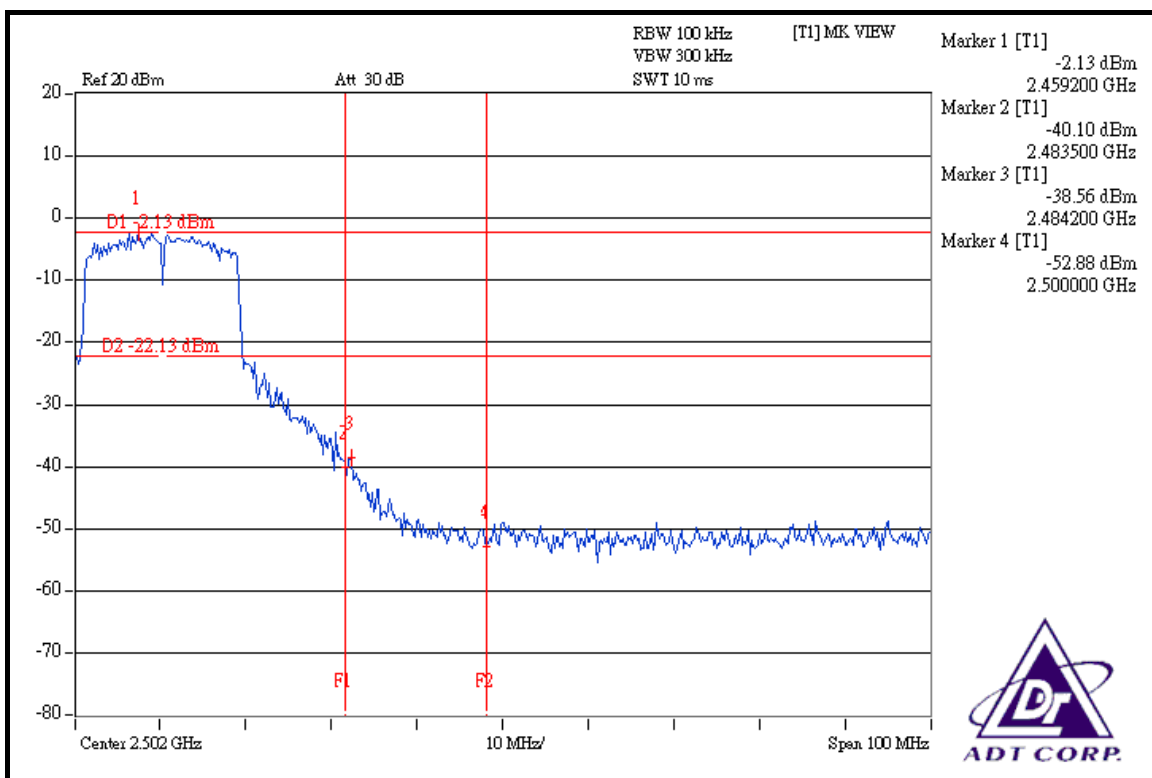
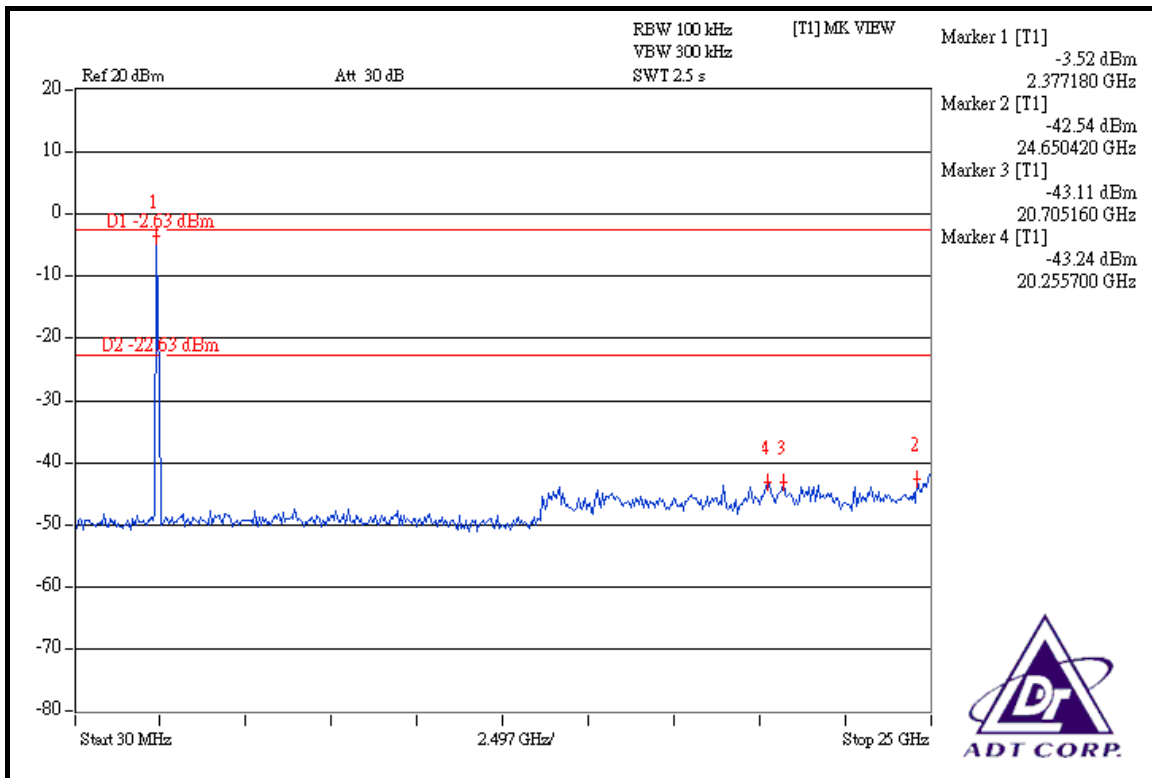

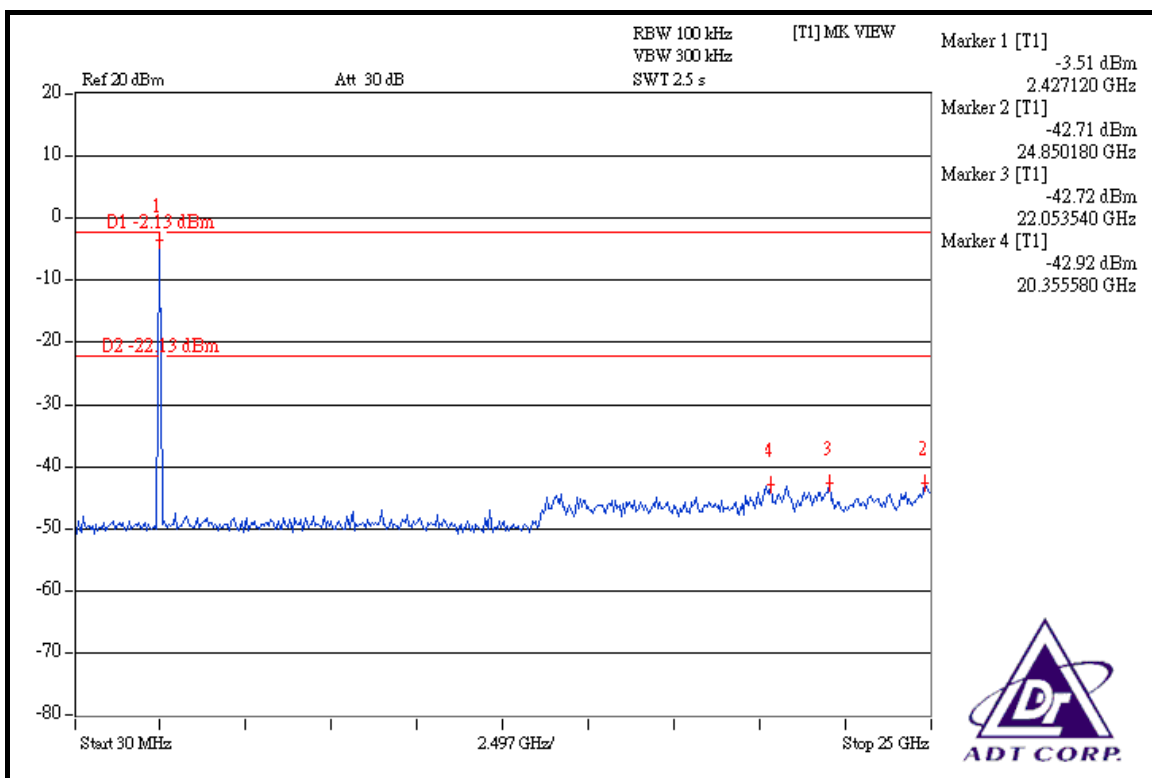
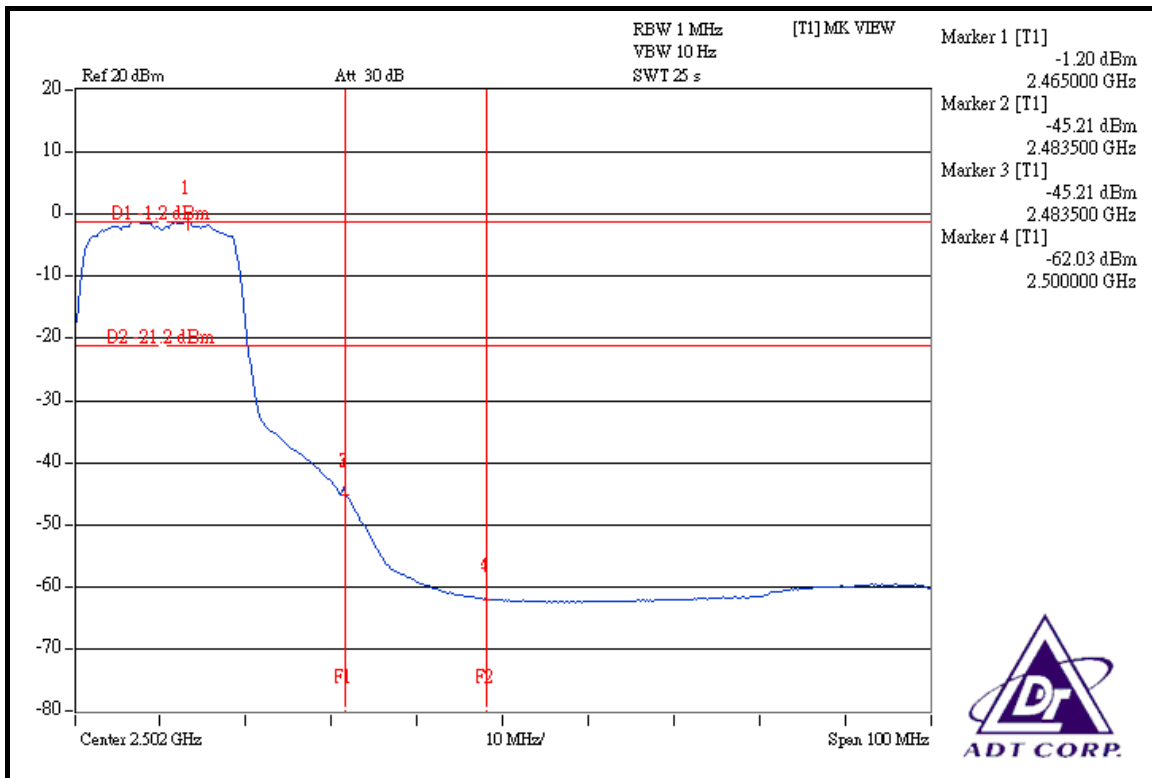

DRAFT 802.11n (40MHz) OFDM MODULATION

NOTE 1:

The band edge emission plot on the next page shows 40.11dBc between carrier maximum power and local maximum emission in restrict band (2.30880GHz). The emission of carrier strength list in the test result of channel 1 at the item 4.2.7 is 103.21dBuV/m (Peak), so the maximum field strength in restrict band is $103.21 - 40.11 = 63.10$ dBuV/m which is under 74dBuV/m limit.

The band edge emission plot on the next page shows 50.04dBc between carrier maximum power and local maximum emission in restrict band (2.39000GHz). The emission of carrier strength list in the test result of channel 1 at the item 4.2.7 is 92.83dBuV/m (Average), so the maximum field strength in restrict band is $92.83 - 50.04 = 42.79$ dBuV/m which is under 54dBuV/m limit.

NOTE 2:

The band edge emission plot on the next second page shows 32.35dBc between carrier maximum power and local maximum emission in restrict band (2.48440GHz). The emission of carrier strength list in the test result of channel 11 at the item 4.2.7 is 103.33dBuV/m (Peak), so the maximum field strength in restrict band is $103.33 - 32.35 = 70.98$ dBuV/m which is under 74dBuV/m limit.

The band edge emission plot on the next third page shows 39.85dBc between carrier maximum power and local maximum emission in restrict band (2.48350GHz). The emission of carrier strength list in the test result of channel 11 at the item 4.2.7 is 91.83dBuV/m (Average), so the maximum field strength in restrict band is $91.83 - 39.85 = 51.98$ dBuV/m which is under 54dBuV/m limit.

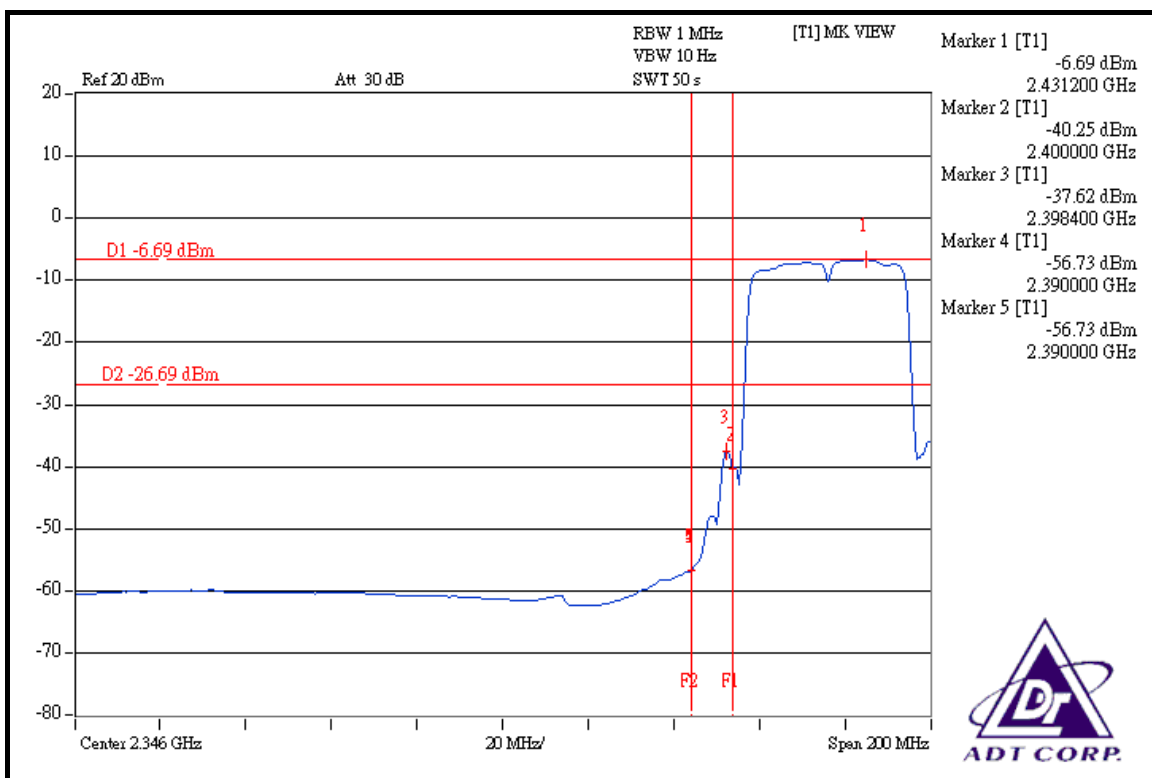
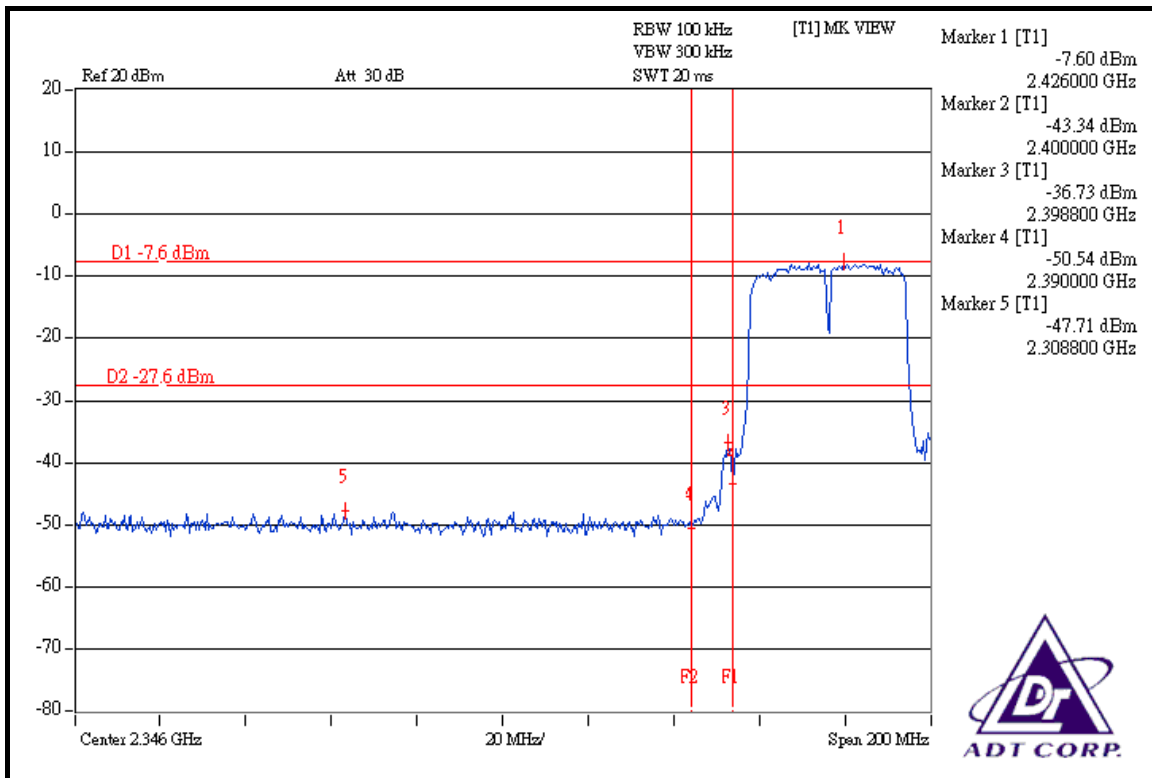

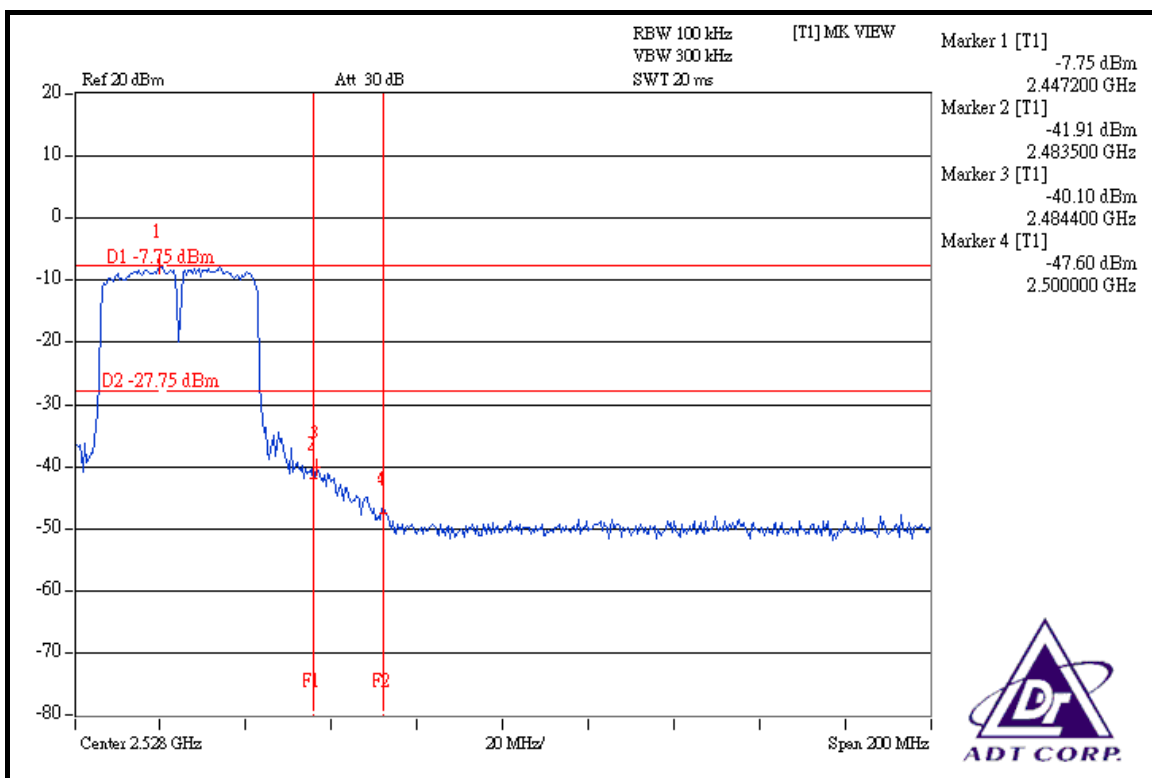
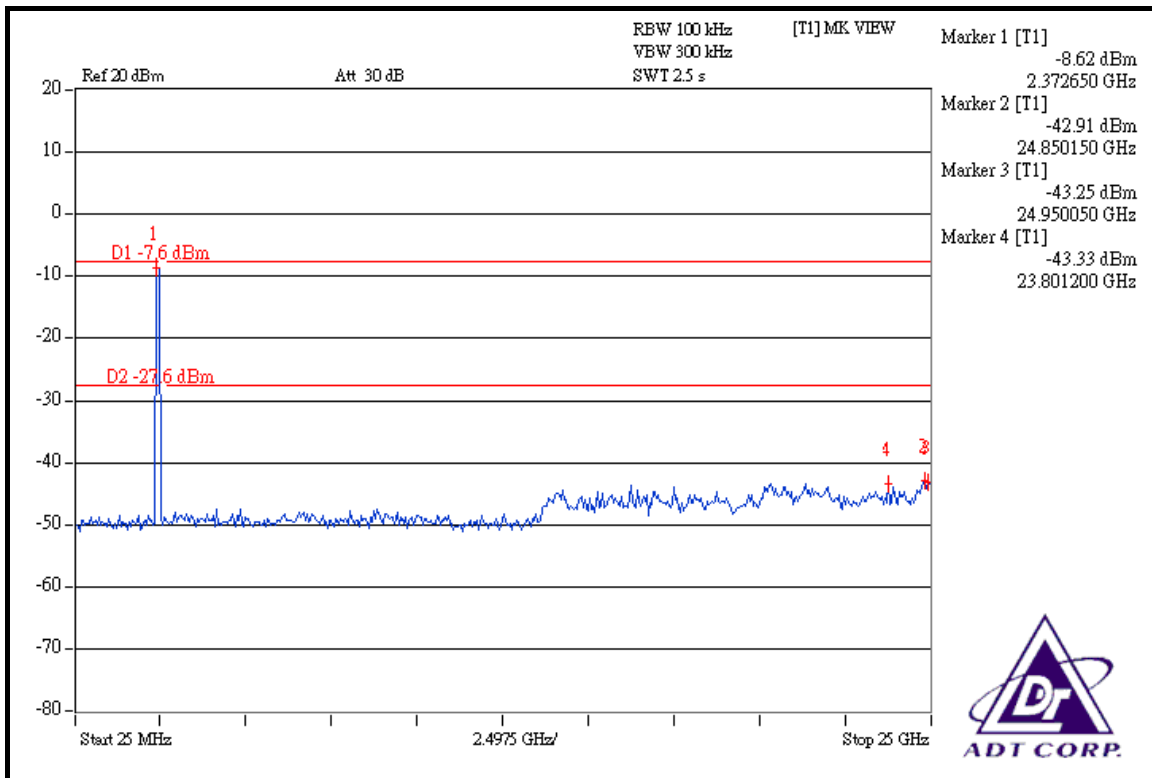

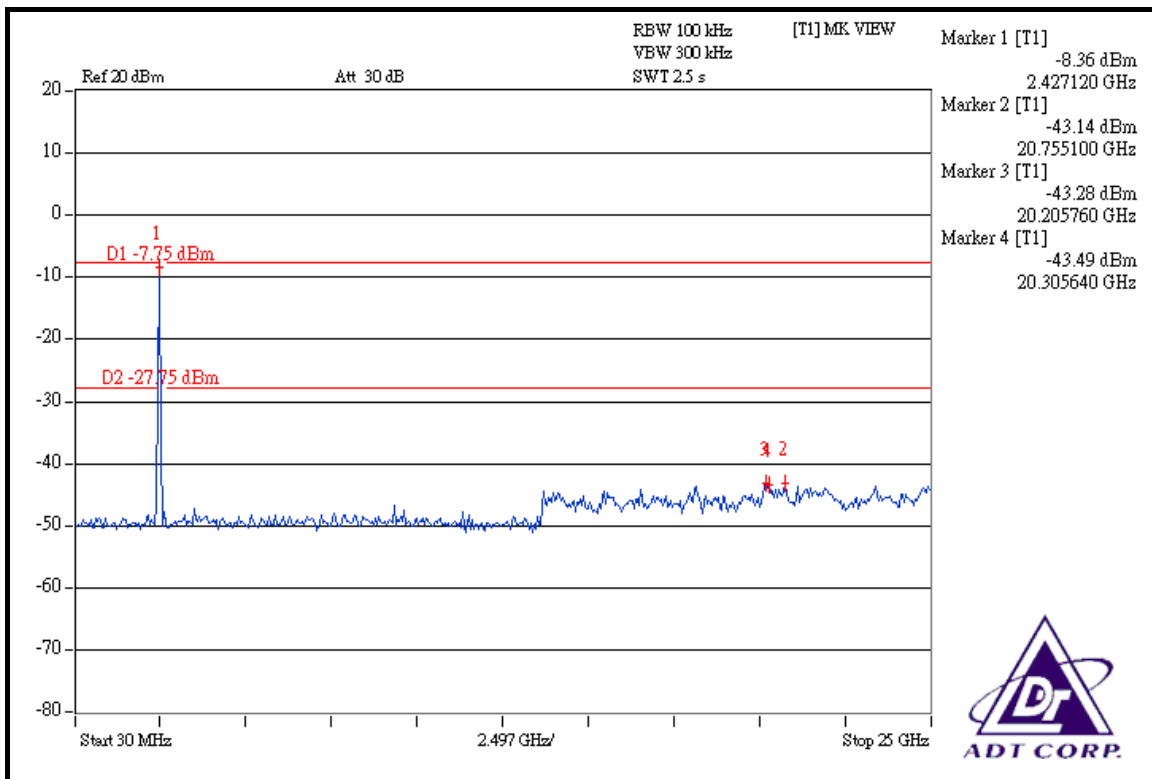
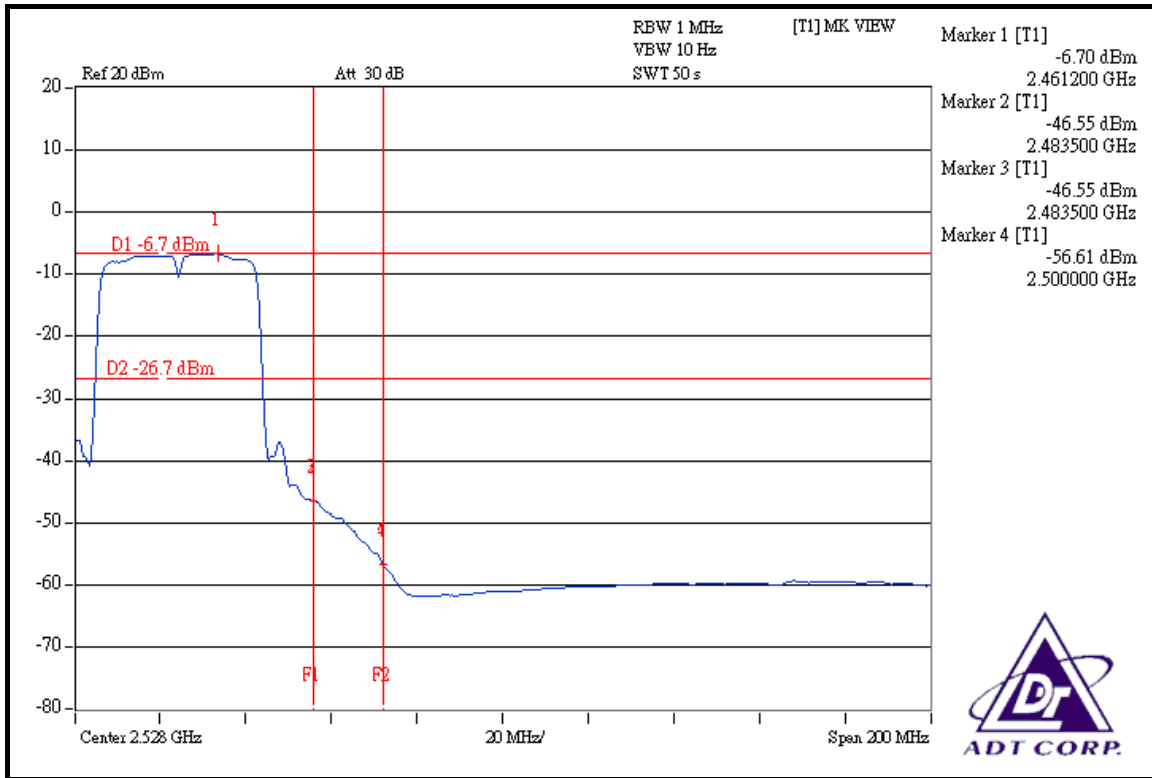



4.7 ANTENNA REQUIREMENT

4.7.1 STANDARD APPLICABLE

For intentional device, according to FCC 47 CFR Section 15.203, an intentional radiator shall be designed to ensure that no antenna other than that furnished by the responsible party shall be used with the device. And according to FCC 47 CFR Section 15.247 (b), if transmitting antennas of directional gain greater than 6dBi are used, the power shall be reduced by the amount in dB that the directional gain of the antenna exceeds 6dBi.

4.7.2 ANTENNA CONNECTED CONSTRUCTION

The antenna used in this product is PIFA antenna without connector. The maximum gain of the antenna is 1dBi.



5. PHOTOGRAPHS OF THE TEST CONFIGURATION

Please refer to the attached file (Test Setup Photo).



6. INFORMATION ON THE TESTING LABORATORIES

We, ADT Corp., were founded in 1988 to provide our best service in EMC, Radio, Telecom and Safety consultation. Our laboratories are accredited and approved by the following approval agencies according to ISO/IEC 17025.

USA	FCC, UL, A2LA
Germany	TUV Rheinland
Japan	VCCI
Norway	NEMKO
Canada	INDUSTRY CANADA, CSA
R.O.C.	TAF, BSMI, NCC
Netherlands	Telefication
Singapore	GOST-ASIA(MOU)
Russia	CERTIS(MOU)

Copies of accreditation certificates of our laboratories obtained from approval agencies can be downloaded from our web site:

www.adt.com.tw/index.5/phtml. If you have any comments, please feel free to contact us at the following:

Linko EMC/RF Lab:

Tel: 886-2-26052180

Fax: 886-2-26051924

Hsin Chu EMC/RF Lab:

Tel: 886-3-5935343

Fax: 886-3-5935342

Hwa Ya EMC/RF/Safety Telecom Lab:

Tel: 886-3-3183232

Fax: 886-3-3185050

Web Site: www.adt.com.tw

The address and road map of all our labs can be found in our web site also.



7. APPENDIX A - MODIFICATIONS RECORDERS FOR ENGINEERING CHANGES TO THE EUT BY THE LAB

No any modifications are made to the EUT by the lab during the test.

---END---