



A D T

FCC TEST REPORT

REPORT NO.: RF980505L04A

MODEL NO.: TEW-634GRU

RECEIVED: May 05, 2009

TESTED: May 06 ~ May 13, 2009

ISSUED: May 26, 2009

APPLICANT: TRENDware International Inc.

ADDRESS: 20675 Manhattan Place, Torrance, CA 90501,
USA

ISSUED BY: Bureau Veritas Consumer Products Services
(H.K.) Ltd., Taoyuan Branch

LAB ADDRESS: No. 47, 14th Ling, Chia Pau Tsuen, Lin Kou
Hsiang, Taipei Hsien 244, Taiwan, R.O.C.

TEST LOCATION: No. 19, Hwa Ya 2nd Rd, Wen Hwa Tsuen, Kwei
Shan Hsiang, Taoyuan Hsien 333, Taiwan,
R.O.C.

This test report consists of 95 pages in total. It may be duplicated completely for legal use with the approval of the applicant. It should not be reproduced except in full, without the written approval of our laboratory. The client should not use it to claim product endorsement by TAF or any government agencies. The test results in the report only apply to the tested sample.





A D T

TABLE OF CONTENTS

| | | |
|-------|---|----|
| 1. | CERTIFICATION..... | 4 |
| 2. | SUMMARY OF TEST RESULTS | 5 |
| 2.1 | MEASUREMENT UNCERTAINTY | 5 |
| 3. | GENERAL INFORMATION | 6 |
| 3.1 | GENERAL DESCRIPTION OF EUT | 6 |
| 3.2 | DESCRIPTION OF TEST MODES | 7 |
| 3.2.1 | CONFIGURATION OF SYSTEM UNDER TEST | 8 |
| 3.2.2 | TEST MODE APPLICABILITY AND TESTED CHANNEL DETAIL | 9 |
| 3.3 | GENERAL DESCRIPTION OF APPLIED STANDARDS | 11 |
| 3.4 | DESCRIPTION OF SUPPORT UNITS | 11 |
| 4. | TEST TYPES AND RESULTS | 12 |
| 4.1 | RADIATED EMISSION MEASUREMENT | 12 |
| 4.1.1 | LIMITS OF RADIATED EMISSION MEASUREMENT | 12 |
| 4.1.2 | TEST INSTRUMENTS..... | 13 |
| 4.1.3 | TEST PROCEDURES | 14 |
| 4.1.4 | DEVIATION FROM TEST STANDARD..... | 14 |
| 4.1.5 | TEST SETUP | 15 |
| 4.1.6 | EUT OPERATING CONDITIONS | 15 |
| 4.1.7 | TEST RESULTS | 16 |
| 4.2 | CONDUCTED EMISSION MEASUREMENT | 29 |
| 4.2.1 | LIMITS OF CONDUCTED EMISSION MEASUREMENT | 29 |
| 4.2.2 | TEST INSTRUMENTS..... | 29 |
| 4.2.3 | TEST PROCEDURES | 30 |
| 4.2.4 | DEVIATION FROM TEST STANDARD..... | 30 |
| 4.2.5 | TEST SETUP | 31 |
| 4.2.6 | EUT OPERATING CONDITIONS | 31 |
| 4.2.7 | TEST RESULTS | 32 |
| 4.3 | 6dB BANDWIDTH MEASUREMENT | 34 |
| 4.3.1 | LIMITS OF 6dB BANDWIDTH MEASUREMENT | 34 |
| 4.3.2 | TEST INSTRUMENTS..... | 34 |
| 4.3.3 | TEST PROCEDURE..... | 34 |
| 4.3.4 | DEVIATION FROM TEST STANDARD..... | 34 |
| 4.3.5 | TEST SETUP | 35 |
| 4.3.6 | EUT OPERATING CONDITIONS | 35 |
| 4.3.7 | TEST RESULTS | 36 |
| 4.4 | MAXIMUM PEAK OUTPUT POWER..... | 52 |



4.4.1 LIMITS OF MAXIMUM PEAK OUTPUT POWER MEASUREMENT52

4.4.2 INSTRUMENTS52

4.4.3 TEST PROCEDURES52

4.4.4 DEVIATION FROM TEST STANDARD.....53

4.4.5 TEST SETUP53

4.4.6 EUT OPERATING CONDITIONS53

4.4.7 TEST RESULTS54

4.5 POWER SPECTRAL DENSITY MEASUREMENT56

4.5.1 LIMITS OF POWER SPECTRAL DENSITY MEASUREMENT56

4.5.2 TEST INSTRUMENTS.....56

4.5.3 TEST PROCEDURE.....56

4.5.4 DEVIATION FROM TEST STANDARD.....57

4.5.5 TEST SETUP.....57

4.5.6 EUT OPERATING CONDITION.....57

4.5.7 TEST RESULTS58

4.6 BAND EDGES MEASUREMENT74

4.6.1 LIMITS OF BAND EDGES MEASUREMENT74

4.6.2 TEST INSTRUMENTS.....74

4.6.3 TEST PROCEDURE.....75

4.6.4 DEVIATION FROM TEST STANDARD.....75

4.6.5 EUT OPERATING CONDITION.....75

4.6.6 TEST RESULTS76

4.7 ANTENNA REQUIREMENT92

4.7.1 STANDARD APPLICABLE92

4.7.2 ANTENNA CONNECTED CONSTRUCTION92

5. PHOTOGRAPHS OF THE TEST CONFIGURATION.....93

6. INFORMATION ON THE TESTING LABORATORIES94

7. APPENDIX A - MODIFICATIONS RECORDERS FOR ENGINEERING CHANGES
TO THE EUT BY THE LAB.....95



A D T

1. CERTIFICATION

PRODUCT: 802.11n Draft 2.0 Wireless LAN Gigabit Router
MODEL: TEW-634GRU
BRAND: TRENDnet
APPLICANT: TRENDware International Inc.
TEST SAMPLE: ENGINEERING SAMPLE
TESTED: May 06 ~ May 13, 2009
STANDARDS: **FCC Part 15, Subpart C (Section 15.247)**
ANSI C63.4-2003

The above equipment (Model: TEW-634GRU) has been tested by **Bureau Veritas Consumer Products Services (H.K.) Ltd., Taoyuan Branch**, and found compliance with the requirement of the above standards. The test record, data evaluation & Equipment Under Test (EUT) configurations represented herein are true and accurate accounts of the measurements of the sample's EMC characteristics under the conditions specified in this report.

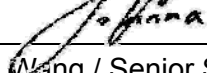
PREPARED BY :  , **DATE** : May 26, 2009
Joanna Wang / Senior Specialist

TECHNICAL ACCEPTANCE :  , **DATE** : May 26, 2009
Responsible for RF Long Chen / Senior Engineer

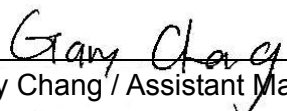
APPROVED BY :  , **DATE** : May 26, 2009
Gary Chang / Assistant Manager



2. SUMMARY OF TEST RESULTS

The EUT has been tested according to the following specifications:

| APPLIED STANDARD: FCC PART 15, SUBPART C (SECTION 15.247) | | | |
|---|--|--------|--|
| STANDARD SECTION | TEST TYPE AND LIMIT | RESULT | REMARK |
| 15.207 | AC Power Conducted Emission | PASS | Meet the requirement of limit. Minimum passing margin is -5.31dB at 0.157MHz. |
| 15.247(a)(2) | Spectrum Bandwidth of a Direct Sequence Spread Spectrum System Limit: min. 500kHz | PASS | Meet the requirement of limit. |
| 15.247(b) | Maximum Peak Output Power Limit: max. 30dBm | PASS | Meet the requirement of limit. |
| 15.247(d) | Radiated Emissions Limit: Table 15.209 | PASS | Meet the requirement of limit. Minimum passing margin is -1.13dB at 500.42MHz. |
| 15.247(e) | Power Spectral Density Limit: max. 8dBm | PASS | Meet the requirement of limit. |
| 15.247(d) | Band Edge Measurement Limit: 20dB less than the peak value of fundamental frequency | PASS | Meet the requirement of limit. |

2.1 MEASUREMENT UNCERTAINTY

Where relevant, the following measurement uncertainty levels have been estimated for tests performed on the EUT as specified in CISPR 16-4-2:

| MEASUREMENT | FREQUENCY | UNCERTAINTY |
|---------------------|-----------------|-------------|
| Conducted emissions | 150kHz~30MHz | 2.44dB |
| Radiated emissions | 30MHz ~ 200MHz | 3.19dB |
| | 200MHz ~1000MHz | 3.21dB |
| | 1GHz ~ 18GHz | 2.26dB |
| | 18GHz ~ 40GHz | 1.94dB |

This uncertainty represents an expanded uncertainty expressed at approximately the 95% confidence level using a coverage factor of $k = 2$.



3. GENERAL INFORMATION

3.1 GENERAL DESCRIPTION OF EUT

| | |
|------------------------------|--|
| EUT | 802.11n Draft 2.0 Wireless LAN Gigabit Router |
| MODEL NO. | TEW-634GRU |
| FCC ID | S9ZTEW634GRU |
| POWER SUPPLY | 12Vdc from adapter |
| MODULATION TYPE | CCK, DQPSK, DBPSK for DSSS 64QAM, 16QAM, QPSK, BPSK for OFDM |
| MODULATION TECHNOLOGY | DSSS, OFDM |
| TRANSFER RATE | 802.11b:11.0/ 5.5/ 2.0/ 1.0Mbps 802.11g: 54.0/ 48.0/ 36.0/ 24.0/ 18.0/ 12.0/ 9.0/ 6.0Mbps Draft 802.11n: up to 300.0Mbps |
| OPERATING FREQUENCY | 2412.0 ~ 2462.0MHz |
| NUMBER OF CHANNEL | 11 for 802.11b, 802.11g, draft 802.11n (20MHz) 7 for draft 802.11n (40MHz) |
| OUTPUT POWER | 386.763mW |
| ANTENNA TYPE | Dipole antenna with 2dBi gain |
| DATA CABLE | NA |
| I/O PORTS | Refer to user's manual |
| ACCESSORY DEVICES | Adapter |

NOTE:

1. This is a duplicate report of RF980505L04. The differences compared with original report are changing the applicant, product name and FCC ID.
2. The EUT incorporates a MIMO function. Physically, the EUT provides two completed transmitters and two receivers.

| MODULATION MODE | TX FUNCTION |
|------------------------------|--------------------|
| 802.11b | 2TX |
| 802.11g | 2TX |
| Draft 802.11n (20MHz) | 2TX |
| Draft 802.11n (40MHz) | 2TX |

3. The EUT was operated with following power adapter:

| | |
|---------------------|--------------------------------------|
| BRAND | JENTEC TECHNOLOGY CO., LTD. |
| MODEL | CG2412-B |
| INPUT POWER | 100-120Vac, 50-60Hz, 0.5A |
| OUTPUT POWER | 12Vdc, 2A |
| POWER LINE | 1.8m non-shielded cable without core |

4. The above EUT information was declared by manufacturer and for more detailed features description, please refer to the manufacturer's specifications or user's manual.



3.2 DESCRIPTION OF TEST MODES

11 channels are provided for 802.11b, 802.11g and draft 802.11n (20MHz):

| CHANNEL | FREQUENCY | CHANNEL | FREQUENCY |
|----------------|------------------|----------------|------------------|
| 1 | 2412MHz | 7 | 2442MHz |
| 2 | 2417MHz | 8 | 2447MHz |
| 3 | 2422MHz | 9 | 2452MHz |
| 4 | 2427MHz | 10 | 2457MHz |
| 5 | 2432MHz | 11 | 2462MHz |
| 6 | 2437MHz | | |

7 channels are provided for draft 802.11n (40MHz):

| CHANNEL | FREQUENCY | CHANNEL | FREQUENCY |
|----------------|------------------|----------------|------------------|
| 1 | 2422MHz | 5 | 2442MHz |
| 2 | 2427MHz | 6 | 2447MHz |
| 3 | 2432MHz | 7 | 2452MHz |
| 4 | 2437MHz | | |

3.2.1 CONFIGURATION OF SYSTEM UNDER TEST

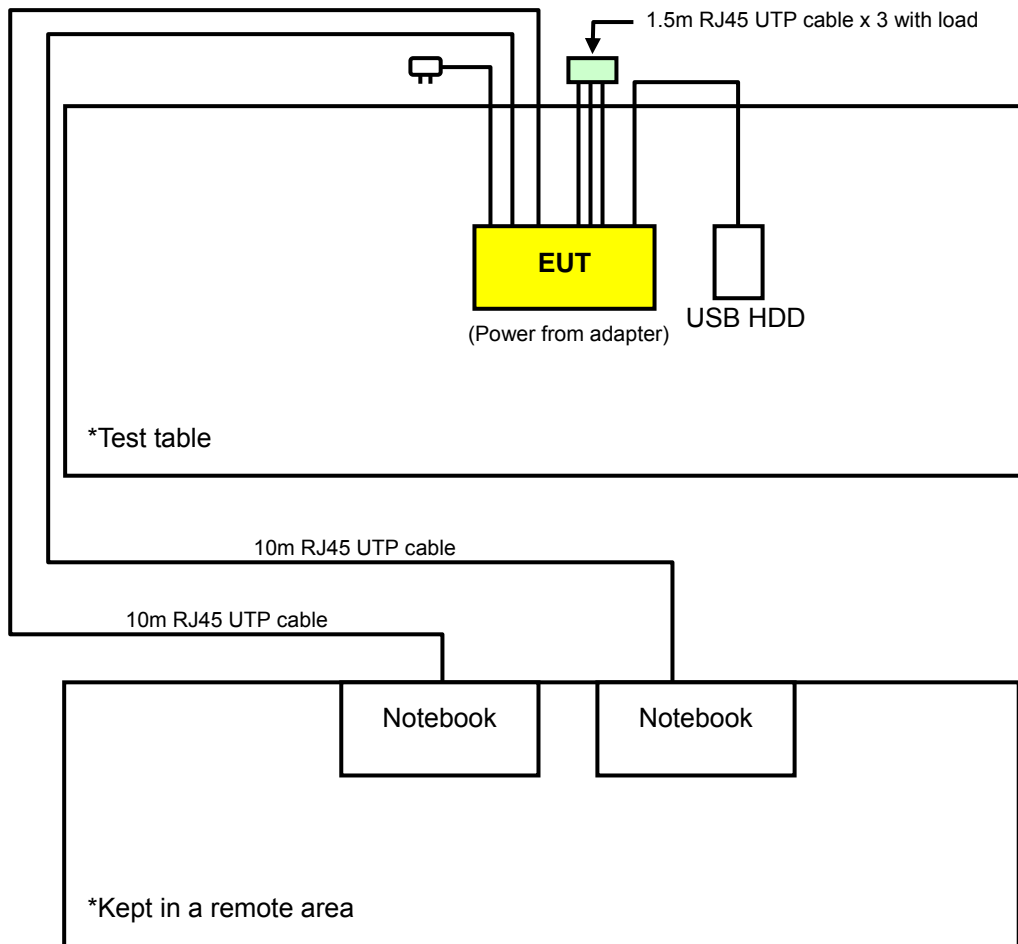

3.2.2 TEST MODE APPLICABILITY AND TESTED CHANNEL DETAIL

| EUT CONFIGURE MODE | APPLICABLE TO | | | | DESCRIPTION |
|--------------------|---------------|-------|-----|------|-------------|
| | RE≥1G | RE<1G | PLC | APCM | |
| - | √ | √ | √ | √ | - |

Where **RE≥1G**: Radiated Emission above 1GHz **RE<1G**: Radiated Emission below 1GHz
PLC: Power Line Conducted Emission **APCM**: Antenna Port Conducted Measurement

RADIATED EMISSION TEST (ABOVE 1GHz):

- Pre-Scan has been conducted to determine the worst-case mode from all possible combinations between available modulations, data rates, XYZ axis and antenna ports (if EUT with antenna diversity architecture).
- Following channel(s) was (were) selected for the final test as listed below.

| MODE | AVAILABLE CHANNEL | TESTED CHANNEL | MODULATION TECHNOLOGY | MODULATION TYPE | DATA RATE (Mbps) | AXIS |
|-----------------------|-------------------|----------------|-----------------------|-----------------|------------------|------|
| 802.11b | 1 to 11 | 1, 6, 11 | DSSS | DBPSK | 1.0 | X |
| 802.11g | 1 to 11 | 1, 6, 11 | OFDM | BPSK | 6.0 | |
| Draft 802.11n (20MHz) | 1 to 11 | 1, 6, 11 | OFDM | BPSK | 7.2 | |
| Draft 802.11n (40MHz) | 1 to 7 | 1, 4, 7 | OFDM | BPSK | 15.0 | |

RADIATED EMISSION TEST (BELOW 1GHz):

- Pre-Scan has been conducted to determine the worst-case mode from all possible combinations between available modulations, data rates, XYZ axis and antenna ports (if EUT with antenna diversity architecture).
- Following channel(s) was (were) selected for the final test as listed below.

| MODE | AVAILABLE CHANNEL | TESTED CHANNEL | MODULATION TECHNOLOGY | MODULATION TYPE | DATA RATE (Mbps) | AXIS |
|-----------------------|-------------------|----------------|-----------------------|-----------------|------------------|------|
| Draft 802.11n (40MHz) | 1 to 7 | 4 | OFDM | BPSK | 15.0 | X |

POWER LINE CONDUCTED EMISSION TEST:

- Pre-Scan has been conducted to determine the worst-case mode from all possible combinations between available modulations, data rates and antenna ports (if EUT with antenna diversity architecture).
- Following channel(s) was (were) selected for the final test as listed below.

| MODE | AVAILABLE CHANNEL | TESTED CHANNEL | MODULATION TECHNOLOGY | MODULATION TYPE | DATA RATE (Mbps) |
|-----------------------|-------------------|----------------|-----------------------|-----------------|------------------|
| Draft 802.11n (40MHz) | 1 to 7 | 1, 4, 7 | OFDM | BPSK | 15.0 |



A D T

BANDEDGE MEASUREMENT:

- Pre-Scan has been conducted to determine the worst-case mode from all possible combinations between available modulations, data rates and antenna ports (if EUT with antenna diversity architecture).
- Following channel(s) was (were) selected for the final test as listed below.

| MODE | AVAILABLE CHANNEL | TESTED CHANNEL | MODULATION TECHNOLOGY | MODULATION TYPE | DATA RATE (Mbps) |
|-----------------------|-------------------|----------------|-----------------------|-----------------|------------------|
| 802.11b | 1 to 11 | 1, 11 | DSSS | DBPSK | 1.0 |
| 802.11g | 1 to 11 | 1, 11 | OFDM | BPSK | 6.0 |
| Draft 802.11n (20MHz) | 1 to 11 | 1, 11 | OFDM | BPSK | 7.2 |
| Draft 802.11n (40MHz) | 1 to 7 | 1, 7 | OFDM | BPSK | 15.0 |

ANTENNA PORT CONDUCTED MEASUREMENT:

- Pre-Scan has been conducted to determine the worst-case mode from all possible combinations between available modulations, data rates and antenna ports (if EUT with antenna diversity architecture).
- Following channel(s) was (were) selected for the final test as listed below.

| MODE | AVAILABLE CHANNEL | TESTED CHANNEL | MODULATION TECHNOLOGY | MODULATION TYPE | DATA RATE (Mbps) |
|-----------------------|-------------------|----------------|-----------------------|-----------------|------------------|
| 802.11b | 1 to 11 | 1, 6, 11 | DSSS | DBPSK | 1.0 |
| 802.11g | 1 to 11 | 1, 6, 11 | OFDM | BPSK | 6.0 |
| Draft 802.11n (20MHz) | 1 to 11 | 1, 6, 11 | OFDM | BPSK | 7.2 |
| Draft 802.11n (40MHz) | 1 to 7 | 1, 4, 7 | OFDM | BPSK | 15.0 |



3.3 GENERAL DESCRIPTION OF APPLIED STANDARDS

The EUT is a RF Product. According to the specifications of the manufacturer, it must comply with the requirements of the following standards:

FCC Part 15, Subpart C (15.247)

ANSI C63.4-2003

All test items have been performed and recorded as per the above standards.

NOTE: The EUT is also considered as a kind of computer peripheral, because the connection to computer is necessary for typical use. It has been verified to comply with the requirements of FCC Part 15, Subpart B, Class B (DoC). The test report has been issued separately.

3.4 DESCRIPTION OF SUPPORT UNITS

The EUT has been tested as an independent unit together with other necessary accessories or support units. The following support units or accessories were used to form a representative test configuration during the tests.

| NO. | PRODUCT | BRAND | MODEL NO. | SERIAL NO. | FCC ID |
|-----|----------|---------|-----------|------------------|------------------|
| 1 | USB HDD | Terasys | F12-UF | A0100222-4860009 | FCC DoC Approved |
| 2 | NOTEBOOK | DELL | PP05L | 12130898320 | E2K24CLNS |
| 3 | NOTEBOOK | DELL | PP05L | 16484462992 | E2K24CLNS |

| NO. | SIGNAL CABLE DESCRIPTION OF THE ABOVE SUPPORT UNITS |
|-----|---|
| 1 | 1.5m shielded cable, terminated with USB connector, w/o core. |
| 2 | 10m RJ45 UTP cable. |
| 3 | 10m RJ45 UTP cable. |

NOTE:

1. All power cords of the above support units are non shielded (1.8m).
2. Item 2~3 acted as communication partners to transfer data.



4. TEST TYPES AND RESULTS

4.1 RADIATED EMISSION MEASUREMENT

4.1.1 LIMITS OF RADIATED EMISSION MEASUREMENT

Emissions radiated outside of the specified bands, shall be according to the general radiated limits in 15.209 as following:

| FREQUENCIES (MHz) | FIELD STRENGTH (microvolts/meter) | MEASUREMENT DISTANCE (meters) |
|-------------------|-----------------------------------|-------------------------------|
| 0.009 ~ 0.490 | 2400/F(kHz) | 300 |
| 0.490 ~ 1.705 | 24000/F(kHz) | 30 |
| 1.705 ~ 30.0 | 30 | 30 |
| 30 ~ 88 | 100 | 3 |
| 88 ~ 216 | 150 | 3 |
| 216 ~ 960 | 200 | 3 |
| Above 960 | 500 | 3 |

NOTE:

1. The lower limit shall apply at the transition frequencies.
2. Emission level (dBuV/m) = 20 log Emission level (uV/m).
3. As shown in 15.35(b), for frequencies above 1000MHz, the field strength limits are based on average detector, however, the peak field strength of any emission shall not exceed the maximum permitted average limits, specified above by more than 20dB under any condition of modulation.



A D T

4.1.2 TEST INSTRUMENTS

| DESCRIPTION & MANUFACTURER | MODEL NO. | SERIAL NO. | DATE OF CALIBRATION | DUE DATE OF CALIBRATION |
|---|------------------------------|-------------|---------------------|-------------------------|
| Test Receiver ROHDE & SCHWARZ | ESI7 | 838496/016 | Dec. 29, 2008 | Dec. 28, 2009 |
| Spectrum Analyzer ROHDE & SCHWARZ | FSP40 | 100039 | Dec. 08, 2008 | Dec. 07, 2009 |
| BILOG Antenna SCHWARZBECK | VULB9168 | 9168-155 | Apr. 30, 2008 | Apr. 28, 2010 |
| HORN Antenna SCHWARZBECK | BBHA 9120D | 9120D-408 | Dec. 29, 2008 | Dec. 28, 2009 |
| HORN Antenna SCHWARZBECK | BBHA 9170 | BBHA9170242 | Jan. 06, 2009 | Jan. 05, 2010 |
| Preamplifier Agilent | 8449B | 3008A01960 | Nov. 03, 2008 | Nov. 02, 2009 |
| Preamplifier Agilent | 8447D | 2944A10631 | Nov. 03, 2008 | Nov. 02, 2009 |
| RF signal cable HUBER+SUHNNER | SUCOFLEX 104 | 274041/4 | Aug. 21, 2008 | Aug. 20, 2009 |
| RF signal cable HUBER+SUHNNER | SUCOFLEX 104 | 283397/4 | Aug. 21, 2008 | Aug. 20, 2009 |
| Software ADT. | ADT_Radiated_ V7.6.15.9.2 | NA | NA | NA |
| Antenna Tower inn-co GmbH | MA 4000 | 010303 | NA | NA |
| Antenna Tower Controller inn-co GmbH | CO2000 | 019303 | NA | NA |
| Turn Table ADT. | TT100. | TT93021704 | NA | NA |
| Turn Table Controller ADT. | SC100. | SC93021704 | NA | NA |

- NOTE:**
1. The calibration interval of the above test instruments is 12 months and the calibrations are traceable to NML/ROC and NIST/USA.
 2. The test was performed in HwaYa Chamber 4.
 3. The horn antenna and HP preamplifier (model: 8449B) are used only for the measurement of emission frequency above 1GHz if tested.
 4. The FCC Site Registration No. is 988962.
 5. The IC Site Registration No. is IC7450F-4.



4.1.3 TEST PROCEDURES

- a. The EUT was placed on the top of a rotating table 0.8 meters above the ground at a 3 meters semi-anechoic chamber. The table was rotated 360 degrees to determine the position of the highest radiation.
- b. The EUT was set 3 meters away from the interference-receiving antenna, which was mounted on the top of a variable-height antenna tower.
- c. The antenna is a broadband antenna, and its height is varied from one meter to four meters above the ground to determine the maximum value of the field strength. Both horizontal and vertical polarizations of the antenna are set to make the measurement.
- d. For each suspected emission, the EUT was arranged to its worst case and then the antenna was tuned to heights from 1 meter to 4 meters and the rotatable table was turned from 0 degrees to 360 degrees to find the maximum reading.
- e. The test-receiver system was set to Peak Detect Function and Specified Bandwidth with Maximum Hold Mode.
- f. If the emission level of the EUT in peak mode was lower than the limit specified, then testing could be stopped and the peak values of the EUT would be reported. Otherwise the emissions would be re-tested one by one using peak, quasi-peak or average method as specified and then reported in a data sheet.

NOTE:

1. The resolution bandwidth and video bandwidth of test receiver/spectrum analyzer is 120kHz for Quasi-peak detection at frequency below 1GHz.
2. The resolution bandwidth of test receiver/spectrum analyzer is 1MHz and video bandwidth is 3MHz for Peak detection at frequency above 1GHz.
3. The resolution bandwidth of test receiver/spectrum analyzer is 1MHz and the video bandwidth is 10Hz for Average detection (AV) at frequency above 1GHz.
4. All modes of operation were investigated and the worst-case emissions are reported.

4.1.4 DEVIATION FROM TEST STANDARD

No deviation.

4.1.5 TEST SETUP

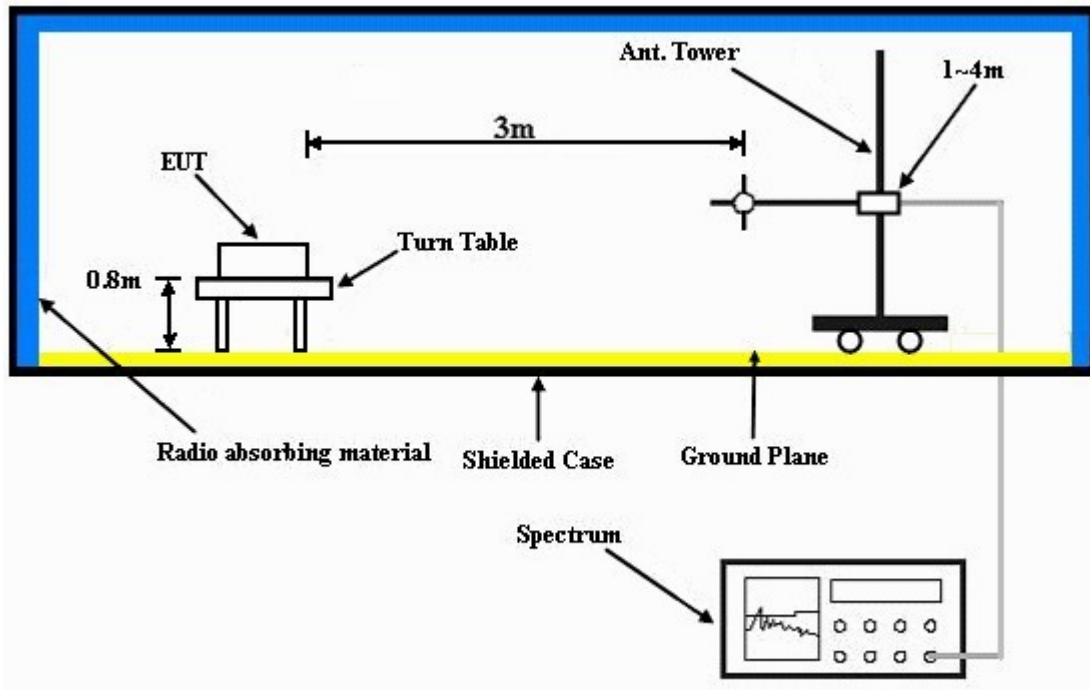

For the actual test configuration, please refer to the attached file (Test Setup Photo).

4.1.6 EUT OPERATING CONDITIONS

- a. Placed the EUT on the testing table.
- b. Prepared two notebook systems outside of testing area to act as communication partner.
- c. The communication partners connected with EUT via a RJ45 cable and run a test program (provided by manufacturer) to enable EUT under transmission condition continuously at specific channel frequency.
- d. The communication partner sent data to EUT by command "PING".
- e. The EUT communicated messages with the USB HDD.



A D T

4.1.7 TEST RESULTS

802.11b DSSS MODULATION

| EUT TEST CONDITION | | MEASUREMENT DETAIL | |
|--------------------------|--------------------------------|--------------------|---------------------------|
| CHANNEL | Channel 1 | FREQUENCY RANGE | 1 ~ 25GHz |
| INPUT POWER | 120Vac, 60 Hz | DETECTOR FUNCTION | Peak (PK) Average (AV) |
| ENVIRONMENTAL CONDITIONS | 23.0deg. C, 70.0%RH 1011hPa | TESTED BY | Lori Chiu |

| ANTENNA POLARITY & TEST DISTANCE: HORIZONTAL AT 3 M | | | | | | | | |
|---|-------------|-------------------------|----------------|-------------|--------------------|----------------------|------------------|--------------------------|
| NO. | FREQ. (MHz) | EMISSION LEVEL (dBuV/m) | LIMIT (dBuV/m) | MARGIN (dB) | ANTENNA HEIGHT (m) | TABLE ANGLE (Degree) | RAW VALUE (dBuV) | CORRECTION FACTOR (dB/m) |
| 1 | 2390.00 | 57.45 PK | 74.00 | -16.55 | 1.07 H | 211 | 25.16 | 32.29 |
| 2 | 2390.00 | 46.58 AV | 54.00 | -7.42 | 1.07 H | 211 | 14.29 | 32.29 |
| 3 | *2412.00 | 102.34 PK | | | 1.07 H | 211 | 69.96 | 32.38 |
| 4 | *2412.00 | 97.65 AV | | | 1.07 H | 211 | 65.27 | 32.38 |
| 5 | 4824.00 | 48.33 PK | 74.00 | -25.67 | 1.32 H | 66 | 9.77 | 38.56 |
| 6 | 4824.00 | 37.63 AV | 54.00 | -16.37 | 1.32 H | 66 | -0.93 | 38.56 |
| 7 | #7236.00 | 53.59 PK | 82.34 | -28.75 | 1.11 H | 341 | 9.08 | 44.51 |
| 8 | #7236.00 | 43.27 AV | 77.65 | -34.38 | 1.11 H | 341 | -1.24 | 44.51 |

| ANTENNA POLARITY & TEST DISTANCE: VERTICAL AT 3 M | | | | | | | | |
|---|-------------|-------------------------|----------------|-------------|--------------------|----------------------|------------------|--------------------------|
| NO. | FREQ. (MHz) | EMISSION LEVEL (dBuV/m) | LIMIT (dBuV/m) | MARGIN (dB) | ANTENNA HEIGHT (m) | TABLE ANGLE (Degree) | RAW VALUE (dBuV) | CORRECTION FACTOR (dB/m) |
| 1 | 2390.00 | 58.08 PK | 74.00 | -15.92 | 1.17 V | 220 | 25.79 | 32.29 |
| 2 | 2390.00 | 47.31 AV | 54.00 | -6.69 | 1.17 V | 220 | 15.02 | 32.29 |
| 3 | *2412.00 | 113.40 PK | | | 1.17 V | 219 | 81.02 | 32.38 |
| 4 | *2412.00 | 108.73 AV | | | 1.17 V | 219 | 76.35 | 32.38 |
| 5 | 4824.00 | 49.49 PK | 74.00 | -24.51 | 1.12 V | 150 | 10.92 | 38.56 |
| 6 | 4824.00 | 38.30 AV | 54.00 | -15.70 | 1.12 V | 150 | -0.27 | 38.56 |
| 7 | #7236.00 | 60.87 PK | 93.40 | -32.53 | 1.72 V | 155 | 16.36 | 44.51 |
| 8 | #7236.00 | 52.50 AV | 88.73 | -36.23 | 1.72 V | 155 | 7.99 | 44.51 |

- REMARKS:**
1. Emission level (dBuV/m) = Raw Value (dBuV) + Correction Factor (dB/m).
 2. Correction Factor (dB/m) = Antenna Factor (dB/m) + Cable Factor (dB).
 3. The other emission levels were very low against the limit.
 4. Margin value = Emission level – Limit value.
 5. “ * “: Fundamental frequency.
 6. “#”:The radiated frequency is out the restricted band.



A D T

| EUT TEST CONDITION | | MEASUREMENT DETAIL | |
|--------------------------|--------------------------------|--------------------|---------------------------|
| CHANNEL | Channel 6 | FREQUENCY RANGE | 1 ~ 25GHz |
| INPUT POWER | 120Vac, 60 Hz | DETECTOR FUNCTION | Peak (PK) Average (AV) |
| ENVIRONMENTAL CONDITIONS | 23.0deg. C, 70.0%RH 1011hPa | TESTED BY | Lori Chiu |

| ANTENNA POLARITY & TEST DISTANCE: HORIZONTAL AT 3 M | | | | | | | | |
|---|-------------|-------------------------|----------------|-------------|--------------------|----------------------|------------------|--------------------------|
| NO. | FREQ. (MHz) | EMISSION LEVEL (dBuV/m) | LIMIT (dBuV/m) | MARGIN (dB) | ANTENNA HEIGHT (m) | TABLE ANGLE (Degree) | RAW VALUE (dBuV) | CORRECTION FACTOR (dB/m) |
| 1 | *2437.00 | 100.98 PK | | | 1.06 H | 200 | 68.50 | 32.48 |
| 2 | *2437.00 | 95.95 AV | | | 1.06 H | 200 | 63.47 | 32.48 |
| 3 | 4874.00 | 48.09 PK | 74.00 | -25.91 | 1.00 H | 169 | 9.42 | 38.67 |
| 4 | 4874.00 | 35.88 AV | 54.00 | -18.12 | 1.00 H | 169 | -2.79 | 38.67 |
| 5 | 7311.00 | 53.46 PK | 74.00 | -20.54 | 1.22 H | 256 | 8.80 | 44.66 |
| 6 | 7311.00 | 43.33 AV | 54.00 | -10.67 | 1.22 H | 256 | -1.33 | 44.66 |
| ANTENNA POLARITY & TEST DISTANCE: VERTICAL AT 3 M | | | | | | | | |
| NO. | FREQ. (MHz) | EMISSION LEVEL (dBuV/m) | LIMIT (dBuV/m) | MARGIN (dB) | ANTENNA HEIGHT (m) | TABLE ANGLE (Degree) | RAW VALUE (dBuV) | CORRECTION FACTOR (dB/m) |
| 1 | *2437.00 | 112.06 PK | | | 1.16 V | 346 | 79.58 | 32.48 |
| 2 | *2437.00 | 107.09 AV | | | 1.16 V | 346 | 74.61 | 32.48 |
| 3 | 4874.00 | 48.26 PK | 74.00 | -25.74 | 1.13 V | 172 | 9.58 | 38.67 |
| 4 | 4874.00 | 35.95 AV | 54.00 | -18.05 | 1.13 V | 172 | -2.73 | 38.67 |
| 5 | 7311.00 | 58.66 PK | 74.00 | -15.34 | 1.66 V | 42 | 14.00 | 44.66 |
| 6 | 7311.00 | 52.73 AV | 54.00 | -1.27 | 1.66 V | 42 | 8.07 | 44.66 |

- REMARKS:**
1. Emission level (dBuV/m) = Raw Value (dBuV) + Correction Factor (dB/m).
 2. Correction Factor (dB/m) = Antenna Factor (dB/m) + Cable Factor (dB).
 3. The other emission levels were very low against the limit.
 4. Margin value = Emission level – Limit value.
 5. “ * “: Fundamental frequency.



A D T

| EUT TEST CONDITION | | MEASUREMENT DETAIL | |
|--------------------------|--------------------------------|--------------------|---------------------------|
| CHANNEL | Channel 11 | FREQUENCY RANGE | 1 ~ 25GHz |
| INPUT POWER | 120Vac, 60 Hz | DETECTOR FUNCTION | Peak (PK) Average (AV) |
| ENVIRONMENTAL CONDITIONS | 23.0deg. C, 70.0%RH 1011hPa | TESTED BY | Lori Chiu |

| ANTENNA POLARITY & TEST DISTANCE: HORIZONTAL AT 3 M | | | | | | | | |
|---|-------------|-------------------------|----------------|-------------|--------------------|----------------------|------------------|--------------------------|
| NO. | FREQ. (MHz) | EMISSION LEVEL (dBuV/m) | LIMIT (dBuV/m) | MARGIN (dB) | ANTENNA HEIGHT (m) | TABLE ANGLE (Degree) | RAW VALUE (dBuV) | CORRECTION FACTOR (dB/m) |
| 1 | *2462.00 | 101.04 PK | | | 1.06 H | 201 | 68.46 | 32.58 |
| 2 | *2462.00 | 96.28 AV | | | 1.06 H | 201 | 63.70 | 32.58 |
| 3 | 2483.50 | 56.10 PK | 74.00 | -17.90 | 1.06 H | 201 | 23.44 | 32.66 |
| 4 | 2483.50 | 46.57 AV | 54.00 | -7.43 | 1.06 H | 201 | 13.91 | 32.66 |
| 5 | 4924.00 | 47.24 PK | 74.00 | -26.76 | 1.05 H | 205 | 8.45 | 38.79 |
| 6 | 4924.00 | 35.10 AV | 54.00 | -18.90 | 1.05 H | 205 | -3.69 | 38.79 |
| 7 | 7386.00 | 53.63 PK | 74.00 | -20.37 | 1.05 H | 122 | 8.81 | 44.82 |
| 8 | 7386.00 | 43.15 AV | 54.00 | -10.85 | 1.05 H | 122 | -1.67 | 44.82 |
| ANTENNA POLARITY & TEST DISTANCE: VERTICAL AT 3 M | | | | | | | | |
| NO. | FREQ. (MHz) | EMISSION LEVEL (dBuV/m) | LIMIT (dBuV/m) | MARGIN (dB) | ANTENNA HEIGHT (m) | TABLE ANGLE (Degree) | RAW VALUE (dBuV) | CORRECTION FACTOR (dB/m) |
| 1 | *2462.00 | 112.00 PK | | | 1.13 V | 222 | 79.42 | 32.58 |
| 2 | *2462.00 | 107.49 AV | | | 1.13 V | 222 | 74.91 | 32.58 |
| 3 | 2483.50 | 57.82 PK | 74.00 | -16.18 | 1.13 V | 222 | 25.16 | 32.66 |
| 4 | 2483.50 | 47.17 AV | 54.00 | -6.83 | 1.13 V | 222 | 14.51 | 32.66 |
| 5 | 4924.00 | 47.81 PK | 74.00 | -26.19 | 1.32 V | 199 | 9.02 | 38.79 |
| 6 | 4924.00 | 35.38 AV | 54.00 | -18.62 | 1.32 V | 199 | -3.41 | 38.79 |
| 7 | 7386.00 | 59.84 PK | 74.00 | -14.16 | 1.74 V | 40 | 15.02 | 44.82 |
| 8 | 7386.00 | 52.50 AV | 54.00 | -1.50 | 1.74 V | 40 | 7.68 | 44.82 |

- REMARKS:**
1. Emission level (dBuV/m) = Raw Value (dBuV) + Correction Factor (dB/m).
 2. Correction Factor (dB/m) = Antenna Factor (dB/m) + Cable Factor (dB).
 3. The other emission levels were very low against the limit.
 4. Margin value = Emission level – Limit value.
 5. “ * “: Fundamental frequency.



A D T

802.11g OFDM MODULATION

| EUT TEST CONDITION | | MEASUREMENT DETAIL | |
|--------------------------|--------------------------------|--------------------|---------------------------|
| CHANNEL | Channel 1 | FREQUENCY RANGE | 1 ~ 25GHz |
| INPUT POWER | 120Vac, 60 Hz | DETECTOR FUNCTION | Peak (PK) Average (AV) |
| ENVIRONMENTAL CONDITIONS | 23.0deg. C, 70.0%RH 1011hPa | TESTED BY | Lori Chiu |

| ANTENNA POLARITY & TEST DISTANCE: HORIZONTAL AT 3 M | | | | | | | | |
|---|-------------|-------------------------|----------------|-------------|--------------------|----------------------|------------------|--------------------------|
| NO. | FREQ. (MHz) | EMISSION LEVEL (dBuV/m) | LIMIT (dBuV/m) | MARGIN (dB) | ANTENNA HEIGHT (m) | TABLE ANGLE (Degree) | RAW VALUE (dBuV) | CORRECTION FACTOR (dB/m) |
| 1 | 2390.00 | 57.55 PK | 74.00 | -16.45 | 1.30 H | 344 | 25.26 | 32.29 |
| 2 | 2390.00 | 48.02 AV | 54.00 | -5.98 | 1.30 H | 344 | 15.73 | 32.29 |
| 3 | *2412.00 | 105.63 PK | | | 1.30 H | 344 | 73.25 | 32.38 |
| 4 | *2412.00 | 94.35 AV | | | 1.30 H | 344 | 61.97 | 32.38 |
| 5 | 4824.00 | 47.67 PK | 74.00 | -26.33 | 1.02 H | 288 | 9.11 | 38.56 |
| 6 | 4824.00 | 35.83 AV | 54.00 | -18.17 | 1.02 H | 288 | -2.73 | 38.56 |
| 7 | #7236.00 | 54.65 PK | 85.63 | -30.98 | 1.20 H | 25 | 10.14 | 44.51 |
| 8 | #7236.00 | 43.67 AV | 74.35 | -30.68 | 1.20 H | 25 | -0.84 | 44.51 |
| ANTENNA POLARITY & TEST DISTANCE: VERTICAL AT 3 M | | | | | | | | |
| NO. | FREQ. (MHz) | EMISSION LEVEL (dBuV/m) | LIMIT (dBuV/m) | MARGIN (dB) | ANTENNA HEIGHT (m) | TABLE ANGLE (Degree) | RAW VALUE (dBuV) | CORRECTION FACTOR (dB/m) |
| 1 | 2390.00 | 72.18 PK | 74.00 | -1.82 | 1.17 V | 181 | 39.89 | 32.29 |
| 2 | 2390.00 | 52.22 AV | 54.00 | -1.78 | 1.17 V | 181 | 19.93 | 32.29 |
| 3 | *2412.00 | 116.82 PK | | | 1.12 V | 222 | 84.44 | 32.38 |
| 4 | *2412.00 | 105.47 AV | | | 1.12 V | 222 | 73.09 | 32.38 |
| 5 | 4824.00 | 48.66 PK | 74.00 | -25.34 | 1.23 V | 66 | 10.10 | 38.56 |
| 6 | 4824.00 | 35.78 AV | 54.00 | -18.22 | 1.23 V | 66 | -2.78 | 38.56 |
| 7 | #7236.00 | 66.65 PK | 96.82 | -30.17 | 1.02 V | 19 | 22.14 | 44.51 |
| 8 | #7236.00 | 48.69 AV | 85.47 | -36.78 | 1.02 V | 19 | 4.18 | 44.51 |

- REMARKS:**
1. Emission level (dBuV/m) = Raw Value (dBuV) + Correction Factor (dB/m).
 2. Correction Factor (dB/m) = Antenna Factor (dB/m) + Cable Factor (dB).
 3. The other emission levels were very low against the limit.
 4. Margin value = Emission level – Limit value.
 5. “ * “: Fundamental frequency.
 6. “#”:The radiated frequency is out the restricted band.



A D T

| EUT TEST CONDITION | | MEASUREMENT DETAIL | |
|--------------------------|--------------------------------|--------------------|---------------------------|
| CHANNEL | Channel 6 | FREQUENCY RANGE | 1 ~ 25GHz |
| INPUT POWER | 120Vac, 60 Hz | DETECTOR FUNCTION | Peak (PK) Average (AV) |
| ENVIRONMENTAL CONDITIONS | 23.0deg. C, 70.0%RH 1011hPa | TESTED BY | Lori Chiu |

| ANTENNA POLARITY & TEST DISTANCE: HORIZONTAL AT 3 M | | | | | | | | |
|---|-------------|-------------------------|----------------|-------------|--------------------|----------------------|------------------|--------------------------|
| NO. | FREQ. (MHz) | EMISSION LEVEL (dBuV/m) | LIMIT (dBuV/m) | MARGIN (dB) | ANTENNA HEIGHT (m) | TABLE ANGLE (Degree) | RAW VALUE (dBuV) | CORRECTION FACTOR (dB/m) |
| 1 | *2437.00 | 104.06 PK | | | 1.24 H | 316 | 71.58 | 32.48 |
| 2 | *2437.00 | 93.13 AV | | | 1.24 H | 316 | 60.65 | 32.48 |
| 3 | 4874.00 | 49.67 PK | 74.00 | -24.33 | 1.02 H | 111 | 11.00 | 38.67 |
| 4 | 4874.00 | 35.54 AV | 54.00 | -18.46 | 1.02 H | 111 | -3.13 | 38.67 |
| 5 | 7311.00 | 62.34 PK | 74.00 | -11.66 | 1.26 H | 258 | 17.68 | 44.66 |
| 6 | 7311.00 | 47.23 AV | 54.00 | -6.77 | 1.26 H | 258 | 2.57 | 44.66 |
| ANTENNA POLARITY & TEST DISTANCE: VERTICAL AT 3 M | | | | | | | | |
| NO. | FREQ. (MHz) | EMISSION LEVEL (dBuV/m) | LIMIT (dBuV/m) | MARGIN (dB) | ANTENNA HEIGHT (m) | TABLE ANGLE (Degree) | RAW VALUE (dBuV) | CORRECTION FACTOR (dB/m) |
| 1 | *2437.00 | 115.00 PK | | | 1.15 V | 15 | 82.52 | 32.48 |
| 2 | *2437.00 | 103.92 AV | | | 1.15 V | 15 | 71.44 | 32.48 |
| 3 | 4874.00 | 50.15 PK | 74.00 | -23.85 | 1.00 V | 135 | 11.47 | 38.67 |
| 4 | 4874.00 | 36.88 AV | 54.00 | -17.12 | 1.00 V | 135 | -1.80 | 38.67 |
| 5 | 7311.00 | 68.30 PK | 74.00 | -5.70 | 1.66 V | 43 | 23.64 | 44.66 |
| 6 | 7311.00 | 52.57 AV | 54.00 | -1.43 | 1.66 V | 43 | 7.91 | 44.66 |

- REMARKS:**
1. Emission level (dBuV/m) = Raw Value (dBuV) + Correction Factor (dB/m).
 2. Correction Factor (dB/m) = Antenna Factor (dB/m) + Cable Factor (dB).
 3. The other emission levels were very low against the limit.
 4. Margin value = Emission level – Limit value.
 5. “ * “: Fundamental frequency.



A D T

| EUT TEST CONDITION | | MEASUREMENT DETAIL | |
|--------------------------|--------------------------------|--------------------|---------------------------|
| CHANNEL | Channel 11 | FREQUENCY RANGE | 1 ~ 25GHz |
| INPUT POWER | 120Vac, 60 Hz | DETECTOR FUNCTION | Peak (PK) Average (AV) |
| ENVIRONMENTAL CONDITIONS | 23.0deg. C, 70.0%RH 1011hPa | TESTED BY | Lori Chiu |

| ANTENNA POLARITY & TEST DISTANCE: HORIZONTAL AT 3 M | | | | | | | | |
|---|-------------|-------------------------|----------------|-------------|--------------------|----------------------|------------------|--------------------------|
| NO. | FREQ. (MHz) | EMISSION LEVEL (dBuV/m) | LIMIT (dBuV/m) | MARGIN (dB) | ANTENNA HEIGHT (m) | TABLE ANGLE (Degree) | RAW VALUE (dBuV) | CORRECTION FACTOR (dB/m) |
| 1 | *2462.00 | 104.30 PK | | | 1.01 H | 335 | 71.72 | 32.58 |
| 2 | *2462.00 | 93.22 AV | | | 1.01 H | 335 | 60.64 | 32.58 |
| 3 | 2483.50 | 57.48 PK | 74.00 | -16.52 | 1.01 H | 355 | 24.82 | 32.66 |
| 4 | 2483.50 | 48.22 AV | 54.00 | -5.78 | 1.01 H | 355 | 15.56 | 32.66 |
| 5 | 4924.00 | 47.69 PK | 74.00 | -26.31 | 1.00 H | 166 | 8.90 | 38.79 |
| 6 | 4924.00 | 35.55 AV | 54.00 | -18.45 | 1.00 H | 166 | -3.24 | 38.79 |
| 7 | 7386.00 | 60.32 PK | 74.00 | -13.68 | 1.20 H | 5 | 15.50 | 44.82 |
| 8 | 7386.00 | 45.39 AV | 54.00 | -8.61 | 1.20 H | 5 | 0.57 | 44.82 |
| ANTENNA POLARITY & TEST DISTANCE: VERTICAL AT 3 M | | | | | | | | |
| NO. | FREQ. (MHz) | EMISSION LEVEL (dBuV/m) | LIMIT (dBuV/m) | MARGIN (dB) | ANTENNA HEIGHT (m) | TABLE ANGLE (Degree) | RAW VALUE (dBuV) | CORRECTION FACTOR (dB/m) |
| 1 | *2462.00 | 115.73 PK | | | 1.14 V | 35 | 83.15 | 32.58 |
| 2 | *2462.00 | 104.43 AV | | | 1.14 V | 35 | 71.85 | 32.58 |
| 3 | 2483.50 | 66.82 PK | 74.00 | -7.18 | 1.13 V | 31 | 34.16 | 32.66 |
| 4 | 2483.50 | 52.79 AV | 54.00 | -1.21 | 1.13 V | 31 | 20.13 | 32.66 |
| 5 | 4924.00 | 48.75 PK | 74.00 | -25.25 | 1.02 V | 223 | 9.96 | 38.79 |
| 6 | 4924.00 | 36.94 AV | 54.00 | -17.06 | 1.02 V | 223 | -1.85 | 38.79 |
| 7 | 7386.00 | 66.72 PK | 74.00 | -7.28 | 1.68 V | 82 | 21.90 | 44.82 |
| 8 | 7386.00 | 50.24 AV | 54.00 | -3.76 | 1.68 V | 82 | 5.42 | 44.82 |

- REMARKS:**
1. Emission level (dBuV/m) = Raw Value (dBuV) + Correction Factor (dB/m).
 2. Correction Factor (dB/m) = Antenna Factor (dB/m) + Cable Factor (dB).
 3. The other emission levels were very low against the limit.
 4. Margin value = Emission level – Limit value.
 5. “ * “: Fundamental frequency.



A D T

DRAFT 802.11n (20MHz) OFDM MODULATION

| EUT TEST CONDITION | | MEASUREMENT DETAIL | |
|--------------------------|--------------------------------|--------------------|---------------------------|
| CHANNEL | Channel 1 | FREQUENCY RANGE | 1 ~ 25GHz |
| INPUT POWER | 120Vac, 60 Hz | DETECTOR FUNCTION | Peak (PK) Average (AV) |
| ENVIRONMENTAL CONDITIONS | 23.0deg. C, 70.0%RH 1011hPa | TESTED BY | Lori Chiu |

| ANTENNA POLARITY & TEST DISTANCE: HORIZONTAL AT 3 M | | | | | | | | |
|---|-------------|-------------------------|----------------|-------------|--------------------|----------------------|------------------|--------------------------|
| NO. | FREQ. (MHz) | EMISSION LEVEL (dBuV/m) | LIMIT (dBuV/m) | MARGIN (dB) | ANTENNA HEIGHT (m) | TABLE ANGLE (Degree) | RAW VALUE (dBuV) | CORRECTION FACTOR (dB/m) |
| 1 | 2390.00 | 56.32 PK | 74.00 | -17.68 | 1.34 H | 327 | 24.03 | 32.29 |
| 2 | 2390.00 | 46.90 AV | 54.00 | -7.10 | 1.34 H | 327 | 14.61 | 32.29 |
| 3 | *2412.00 | 102.51 PK | | | 1.34 H | 327 | 70.13 | 32.38 |
| 4 | *2412.00 | 91.10 AV | | | 1.34 H | 327 | 58.72 | 32.38 |
| 5 | 4824.00 | 48.49 PK | 74.00 | -25.51 | 1.04 H | 139 | 9.92 | 38.56 |
| 6 | 4824.00 | 35.34 AV | 54.00 | -18.66 | 1.04 H | 139 | -3.23 | 38.56 |
| 7 | #7236.00 | 53.85 PK | 82.51 | -28.66 | 1.29 H | 245 | 9.34 | 44.51 |
| 8 | #7236.00 | 42.36 AV | 71.10 | -28.74 | 1.29 H | 245 | -2.15 | 44.51 |
| ANTENNA POLARITY & TEST DISTANCE: VERTICAL AT 3 M | | | | | | | | |
| NO. | FREQ. (MHz) | EMISSION LEVEL (dBuV/m) | LIMIT (dBuV/m) | MARGIN (dB) | ANTENNA HEIGHT (m) | TABLE ANGLE (Degree) | RAW VALUE (dBuV) | CORRECTION FACTOR (dB/m) |
| 1 | 2390.00 | 70.19 PK | 74.00 | -3.81 | 1.00 V | 4 | 37.90 | 32.29 |
| 2 | 2390.00 | 52.16 AV | 54.00 | -1.84 | 1.00 V | 4 | 19.87 | 32.29 |
| 3 | *2412.00 | 114.64 PK | | | 1.17 V | 352 | 82.26 | 32.38 |
| 4 | *2412.00 | 102.98 AV | | | 1.17 V | 352 | 70.60 | 32.38 |
| 5 | 4824.00 | 48.73 PK | 74.00 | -25.27 | 1.11 V | 83 | 10.16 | 38.56 |
| 6 | 4824.00 | 35.90 AV | 54.00 | -18.10 | 1.11 V | 83 | -2.67 | 38.56 |
| 7 | #7236.00 | 64.13 PK | 94.64 | -30.51 | 1.80 V | 41 | 19.62 | 44.51 |
| 8 | #7236.00 | 47.43 AV | 82.98 | -35.55 | 1.80 V | 41 | 2.92 | 44.51 |

- REMARKS:**
1. Emission level (dBuV/m) = Raw Value (dBuV) + Correction Factor (dB/m).
 2. Correction Factor (dB/m) = Antenna Factor (dB/m) + Cable Factor (dB).
 3. The other emission levels were very low against the limit.
 4. Margin value = Emission level – Limit value.
 5. “ * “: Fundamental frequency.
 6. “#”:The radiated frequency is out the restricted band.



A D T

| EUT TEST CONDITION | | MEASUREMENT DETAIL | |
|--------------------------|--------------------------------|--------------------|---------------------------|
| CHANNEL | Channel 6 | FREQUENCY RANGE | 1 ~ 25GHz |
| INPUT POWER | 120Vac, 60 Hz | DETECTOR FUNCTION | Peak (PK) Average (AV) |
| ENVIRONMENTAL CONDITIONS | 23.0deg. C, 70.0%RH 1011hPa | TESTED BY | Lori Chiu |

| ANTENNA POLARITY & TEST DISTANCE: HORIZONTAL AT 3 M | | | | | | | | |
|---|-------------|-------------------------|----------------|-------------|--------------------|----------------------|------------------|--------------------------|
| NO. | FREQ. (MHz) | EMISSION LEVEL (dBuV/m) | LIMIT (dBuV/m) | MARGIN (dB) | ANTENNA HEIGHT (m) | TABLE ANGLE (Degree) | RAW VALUE (dBuV) | CORRECTION FACTOR (dB/m) |
| 1 | *2437.00 | 104.29 PK | | | 1.32 H | 319 | 71.81 | 32.48 |
| 2 | *2437.00 | 93.77 AV | | | 1.32 H | 319 | 61.29 | 32.48 |
| 3 | 4874.00 | 47.69 PK | 74.00 | -26.31 | 1.00 H | 16 | 9.02 | 38.67 |
| 4 | 4874.00 | 35.35 AV | 54.00 | -18.65 | 1.00 H | 16 | -3.32 | 38.67 |
| 5 | 7311.00 | 57.54 PK | 74.00 | -16.46 | 1.08 H | 252 | 12.88 | 44.66 |
| 6 | 7311.00 | 43.65 AV | 54.00 | -10.35 | 1.08 H | 252 | -1.01 | 44.66 |
| ANTENNA POLARITY & TEST DISTANCE: VERTICAL AT 3 M | | | | | | | | |
| NO. | FREQ. (MHz) | EMISSION LEVEL (dBuV/m) | LIMIT (dBuV/m) | MARGIN (dB) | ANTENNA HEIGHT (m) | TABLE ANGLE (Degree) | RAW VALUE (dBuV) | CORRECTION FACTOR (dB/m) |
| 1 | *2437.00 | 115.97 PK | | | 1.15 V | 209 | 83.49 | 32.48 |
| 2 | *2437.00 | 104.08 AV | | | 1.15 V | 209 | 71.60 | 32.48 |
| 3 | 4874.00 | 47.73 PK | 74.00 | -26.27 | 1.13 V | 320 | 9.05 | 38.67 |
| 4 | 4874.00 | 35.40 AV | 54.00 | -18.60 | 1.13 V | 320 | -3.28 | 38.67 |
| 5 | 7311.00 | 67.01 PK | 74.00 | -6.99 | 1.55 V | 46 | 22.35 | 44.66 |
| 6 | 7311.00 | 50.59 AV | 54.00 | -3.41 | 1.55 V | 46 | 5.93 | 44.66 |

- REMARKS:**
1. Emission level (dBuV/m) = Raw Value (dBuV) + Correction Factor (dB/m).
 2. Correction Factor (dB/m) = Antenna Factor (dB/m) + Cable Factor (dB).
 3. The other emission levels were very low against the limit.
 4. Margin value = Emission level – Limit value.
 5. “ * “: Fundamental frequency.



A D T

| EUT TEST CONDITION | | MEASUREMENT DETAIL | |
|--------------------------|--------------------------------|--------------------|---------------------------|
| CHANNEL | Channel 11 | FREQUENCY RANGE | 1 ~ 25GHz |
| INPUT POWER | 120Vac, 60 Hz | DETECTOR FUNCTION | Peak (PK) Average (AV) |
| ENVIRONMENTAL CONDITIONS | 23.0deg. C, 70.0%RH 1011hPa | TESTED BY | Lori Chiu |

| ANTENNA POLARITY & TEST DISTANCE: HORIZONTAL AT 3 M | | | | | | | | |
|---|-------------|-------------------------|----------------|-------------|--------------------|----------------------|------------------|--------------------------|
| NO. | FREQ. (MHz) | EMISSION LEVEL (dBuV/m) | LIMIT (dBuV/m) | MARGIN (dB) | ANTENNA HEIGHT (m) | TABLE ANGLE (Degree) | RAW VALUE (dBuV) | CORRECTION FACTOR (dB/m) |
| 1 | *2462.00 | 104.35 PK | | | 1.33 H | 320 | 71.77 | 32.58 |
| 2 | *2462.00 | 93.89 AV | | | 1.33 H | 320 | 61.31 | 32.58 |
| 3 | 2483.50 | 57.12 PK | 74.00 | -16.88 | 1.33 H | 320 | 24.46 | 32.66 |
| 4 | 2483.50 | 47.20 AV | 54.00 | -6.80 | 1.33 H | 320 | 14.54 | 32.66 |
| 5 | 4924.00 | 47.78 PK | 74.00 | -26.22 | 1.14 H | 285 | 8.99 | 38.79 |
| 6 | 4924.00 | 35.68 AV | 54.00 | -18.32 | 1.14 H | 285 | -3.11 | 38.79 |
| 7 | 7386.00 | 57.60 PK | 74.00 | -16.40 | 1.53 H | 128 | 12.78 | 44.82 |
| 8 | 7386.00 | 43.72 AV | 54.00 | -10.28 | 1.53 H | 128 | -1.10 | 44.82 |
| ANTENNA POLARITY & TEST DISTANCE: VERTICAL AT 3 M | | | | | | | | |
| NO. | FREQ. (MHz) | EMISSION LEVEL (dBuV/m) | LIMIT (dBuV/m) | MARGIN (dB) | ANTENNA HEIGHT (m) | TABLE ANGLE (Degree) | RAW VALUE (dBuV) | CORRECTION FACTOR (dB/m) |
| 1 | *2462.00 | 116.07 PK | | | 1.15 V | 221 | 83.49 | 32.58 |
| 2 | *2462.00 | 104.14 AV | | | 1.15 V | 221 | 71.56 | 32.58 |
| 3 | 2483.50 | 67.25 PK | 74.00 | -6.75 | 1.10 V | 211 | 34.59 | 32.66 |
| 4 | 2483.50 | 52.59 AV | 54.00 | -1.41 | 1.10 V | 211 | 19.93 | 32.66 |
| 5 | 4924.00 | 48.14 PK | 74.00 | -25.86 | 1.03 V | 13 | 9.35 | 38.79 |
| 6 | 4924.00 | 35.79 AV | 54.00 | -18.21 | 1.03 V | 13 | -3.00 | 38.79 |
| 7 | 7386.00 | 69.11 PK | 74.00 | -4.89 | 1.87 V | 41 | 24.29 | 44.82 |
| 8 | 7386.00 | 50.43 AV | 54.00 | -3.57 | 1.87 V | 41 | 5.61 | 44.82 |

- REMARKS:**
1. Emission level (dBuV/m) = Raw Value (dBuV) + Correction Factor (dB/m).
 2. Correction Factor (dB/m) = Antenna Factor (dB/m) + Cable Factor (dB).
 3. The other emission levels were very low against the limit.
 4. Margin value = Emission level – Limit value.
 5. “ * “: Fundamental frequency.



A D T

DRAFT 802.11n (40MHz) OFDM MODULATION

| EUT TEST CONDITION | | MEASUREMENT DETAIL | |
|--------------------------|--------------------------------|--------------------|---------------------------|
| CHANNEL | Channel 1 | FREQUENCY RANGE | 1 ~ 25GHz |
| INPUT POWER | 120Vac, 60 Hz | DETECTOR FUNCTION | Peak (PK) Average (AV) |
| ENVIRONMENTAL CONDITIONS | 23.0deg. C, 70.0%RH 1011hPa | TESTED BY | Lori Chiu |

| ANTENNA POLARITY & TEST DISTANCE: HORIZONTAL AT 3 M | | | | | | | | |
|---|-------------|-------------------------|----------------|-------------|--------------------|----------------------|------------------|--------------------------|
| NO. | FREQ. (MHz) | EMISSION LEVEL (dBuV/m) | LIMIT (dBuV/m) | MARGIN (dB) | ANTENNA HEIGHT (m) | TABLE ANGLE (Degree) | RAW VALUE (dBuV) | CORRECTION FACTOR (dB/m) |
| 1 | 2390.00 | 57.59 PK | 74.00 | -16.41 | 1.06 H | 205 | 25.30 | 32.29 |
| 2 | 2390.00 | 46.99 AV | 54.00 | -7.01 | 1.06 H | 205 | 14.70 | 32.29 |
| 3 | *2422.00 | 98.27 PK | | | 1.06 H | 204 | 65.85 | 32.42 |
| 4 | *2422.00 | 85.36 AV | | | 1.06 H | 204 | 52.94 | 32.42 |
| 5 | 4844.00 | 48.74 PK | 74.00 | -25.26 | 1.12 H | 208 | 10.13 | 38.61 |
| 6 | 4844.00 | 35.98 AV | 54.00 | -18.02 | 1.12 H | 208 | -2.63 | 38.61 |
| ANTENNA POLARITY & TEST DISTANCE: VERTICAL AT 3 M | | | | | | | | |
| NO. | FREQ. (MHz) | EMISSION LEVEL (dBuV/m) | LIMIT (dBuV/m) | MARGIN (dB) | ANTENNA HEIGHT (m) | TABLE ANGLE (Degree) | RAW VALUE (dBuV) | CORRECTION FACTOR (dB/m) |
| 1 | 2390.00 | 72.11 PK | 74.00 | -1.89 | 1.15 V | 141 | 39.82 | 32.29 |
| 2 | 2390.00 | 51.46 AV | 54.00 | -2.54 | 1.15 V | 141 | 19.17 | 32.29 |
| 3 | *2422.00 | 110.11 PK | | | 1.16 V | 17 | 77.69 | 32.42 |
| 4 | *2422.00 | 96.53 AV | | | 1.16 V | 17 | 64.11 | 32.42 |
| 5 | 4844.00 | 48.86 PK | 74.00 | -25.14 | 1.10 V | 108 | 10.25 | 38.61 |
| 6 | 4844.00 | 35.87 AV | 54.00 | -18.13 | 1.10 V | 108 | -2.74 | 38.61 |

- REMARKS:**
1. Emission level (dBuV/m) = Raw Value (dBuV) + Correction Factor (dB/m).
 2. Correction Factor (dB/m) = Antenna Factor (dB/m) + Cable Factor (dB).
 3. The other emission levels were very low against the limit.
 4. Margin value = Emission level – Limit value.
 5. “ * “: Fundamental frequency.



A D T

| EUT TEST CONDITION | | MEASUREMENT DETAIL | |
|--------------------------|--------------------------------|--------------------|---------------------------|
| CHANNEL | Channel 4 | FREQUENCY RANGE | 1 ~ 25GHz |
| INPUT POWER | 120Vac, 60 Hz | DETECTOR FUNCTION | Peak (PK) Average (AV) |
| ENVIRONMENTAL CONDITIONS | 23.0deg. C, 70.0%RH 1011hPa | TESTED BY | Lori Chiu |

| ANTENNA POLARITY & TEST DISTANCE: HORIZONTAL AT 3 M | | | | | | | | |
|---|-------------|-------------------------|----------------|-------------|--------------------|----------------------|------------------|--------------------------|
| NO. | FREQ. (MHz) | EMISSION LEVEL (dBuV/m) | LIMIT (dBuV/m) | MARGIN (dB) | ANTENNA HEIGHT (m) | TABLE ANGLE (Degree) | RAW VALUE (dBuV) | CORRECTION FACTOR (dB/m) |
| 1 | *2437.00 | 99.58 PK | | | 1.06 H | 200 | 67.10 | 32.48 |
| 2 | *2437.00 | 86.74 AV | | | 1.06 H | 200 | 54.26 | 32.48 |
| 3 | 2483.50 | 61.21 PK | 74.00 | -12.79 | 1.06 H | 200 | 28.55 | 32.66 |
| 4 | 2483.50 | 47.55 AV | 54.00 | -6.45 | 1.06 H | 200 | 14.89 | 32.66 |
| 5 | 4874.00 | 48.47 PK | 74.00 | -25.53 | 1.01 H | 223 | 9.80 | 38.67 |
| 6 | 4874.00 | 35.66 AV | 54.00 | -18.34 | 1.01 H | 223 | -3.01 | 38.67 |
| ANTENNA POLARITY & TEST DISTANCE: VERTICAL AT 3 M | | | | | | | | |
| NO. | FREQ. (MHz) | EMISSION LEVEL (dBuV/m) | LIMIT (dBuV/m) | MARGIN (dB) | ANTENNA HEIGHT (m) | TABLE ANGLE (Degree) | RAW VALUE (dBuV) | CORRECTION FACTOR (dB/m) |
| 1 | *2437.00 | 110.90 PK | | | 1.13 V | 203 | 78.42 | 32.48 |
| 2 | *2437.00 | 98.13 AV | | | 1.13 V | 203 | 65.65 | 32.48 |
| 3 | 2483.50 | 65.58 PK | 74.00 | -8.42 | 1.11 V | 211 | 32.92 | 32.66 |
| 4 | 2483.50 | 51.32 AV | 54.00 | -2.68 | 1.11 V | 211 | 18.66 | 32.66 |
| 5 | 4874.00 | 48.97 PK | 74.00 | -25.03 | 1.15 V | 268 | 10.30 | 38.67 |
| 6 | 4874.00 | 35.88 AV | 54.00 | -18.12 | 1.15 V | 268 | -2.79 | 38.67 |

- REMARKS:**
1. Emission level (dBuV/m) = Raw Value (dBuV) + Correction Factor (dB/m).
 2. Correction Factor (dB/m) = Antenna Factor (dB/m) + Cable Factor (dB).
 3. The other emission levels were very low against the limit.
 4. Margin value = Emission level – Limit value.
 5. “ * “: Fundamental frequency.



A D T

| EUT TEST CONDITION | | MEASUREMENT DETAIL | |
|--------------------------|--------------------------------|--------------------|---------------------------|
| CHANNEL | Channel 7 | FREQUENCY RANGE | 1 ~ 25GHz |
| INPUT POWER | 120Vac, 60 Hz | DETECTOR FUNCTION | Peak (PK) Average (AV) |
| ENVIRONMENTAL CONDITIONS | 23.0deg. C, 70.0%RH 1011hPa | TESTED BY | Lori Chiu |

| ANTENNA POLARITY & TEST DISTANCE: HORIZONTAL AT 3 M | | | | | | | | |
|---|-------------|-------------------------|----------------|-------------|--------------------|----------------------|------------------|--------------------------|
| NO. | FREQ. (MHz) | EMISSION LEVEL (dBuV/m) | LIMIT (dBuV/m) | MARGIN (dB) | ANTENNA HEIGHT (m) | TABLE ANGLE (Degree) | RAW VALUE (dBuV) | CORRECTION FACTOR (dB/m) |
| 1 | *2452.00 | 98.76 PK | | | 1.05 H | 201 | 66.22 | 32.54 |
| 2 | *2452.00 | 85.62 AV | | | 1.05 H | 201 | 53.08 | 32.54 |
| 3 | 2483.50 | 61.45 PK | 74.00 | -12.55 | 1.06 H | 201 | 28.79 | 32.66 |
| 4 | 2483.50 | 47.67 AV | 54.00 | -6.33 | 1.06 H | 201 | 15.01 | 32.66 |
| 5 | 4904.00 | 48.34 PK | 74.00 | -25.66 | 1.11 H | 115 | 9.60 | 38.74 |
| 6 | 4904.00 | 35.71 AV | 54.00 | -18.29 | 1.11 H | 115 | -3.03 | 38.74 |
| ANTENNA POLARITY & TEST DISTANCE: VERTICAL AT 3 M | | | | | | | | |
| NO. | FREQ. (MHz) | EMISSION LEVEL (dBuV/m) | LIMIT (dBuV/m) | MARGIN (dB) | ANTENNA HEIGHT (m) | TABLE ANGLE (Degree) | RAW VALUE (dBuV) | CORRECTION FACTOR (dB/m) |
| 1 | *2452.00 | 110.01 PK | | | 1.14 V | 31 | 77.47 | 32.54 |
| 2 | *2452.00 | 96.70 AV | | | 1.14 V | 31 | 64.16 | 32.54 |
| 3 | 2483.50 | 69.99 PK | 74.00 | -4.01 | 1.11 V | 211 | 37.33 | 32.66 |
| 4 | 2483.50 | 52.19 AV | 54.00 | -1.81 | 1.11 V | 211 | 19.53 | 32.66 |
| 5 | 4904.00 | 48.97 PK | 74.00 | -25.03 | 1.20 V | 61 | 10.23 | 38.74 |
| 6 | 4904.00 | 35.90 AV | 54.00 | -18.10 | 1.20 V | 61 | -2.84 | 38.74 |

- REMARKS:**
1. Emission level (dBuV/m) = Raw Value (dBuV) + Correction Factor (dB/m).
 2. Correction Factor (dB/m) = Antenna Factor (dB/m) + Cable Factor (dB).
 3. The other emission levels were very low against the limit.
 4. Margin value = Emission level – Limit value.
 5. “ * “: Fundamental frequency.



A D T

BELOW 1GHz WORST-CASE DATA : DRAFT 802.11n (40MHz) OFDM MODULATION

| EUT TEST CONDITION | | MEASUREMENT DETAIL | |
|--------------------------|--------------------------------|--------------------|---------------|
| CHANNEL | Channel 4 | FREQUENCY RANGE | Below 1000MHz |
| INPUT POWER | 120Vac, 60 Hz | DETECTOR FUNCTION | Quasi-Peak |
| ENVIRONMENTAL CONDITIONS | 24.0deg. C, 64.0%RH 1013hPa | TESTED BY | Match Tsui |

| ANTENNA POLARITY & TEST DISTANCE: HORIZONTAL AT 3 M | | | | | | | | |
|---|-------------|-------------------------|----------------|-------------|--------------------|----------------------|------------------|--------------------------|
| NO. | FREQ. (MHz) | EMISSION LEVEL (dBuV/m) | LIMIT (dBuV/m) | MARGIN (dB) | ANTENNA HEIGHT (m) | TABLE ANGLE (Degree) | RAW VALUE (dBuV) | CORRECTION FACTOR (dB/m) |
| 1 | 88.23 | 35.41 QP | 43.50 | -8.09 | 2.00 H | 151 | 26.40 | 9.02 |
| 2 | 125.17 | 35.02 QP | 43.50 | -8.48 | 2.00 H | 259 | 23.07 | 11.95 |
| 3 | 189.33 | 34.66 QP | 43.50 | -8.84 | 1.25 H | 178 | 23.21 | 11.45 |
| 4 | 249.60 | 43.73 QP | 46.00 | -2.27 | 1.25 H | 256 | 30.91 | 12.81 |
| 5 | 374.04 | 40.31 QP | 46.00 | -5.69 | 1.00 H | 64 | 24.88 | 15.43 |
| 6 | 500.42 | 44.87 QP | 46.00 | -1.13 | 2.00 H | 346 | 25.62 | 19.25 |
| 7 | 624.85 | 41.40 QP | 46.00 | -4.60 | 1.25 H | 202 | 19.29 | 22.11 |
| 8 | 751.23 | 41.30 QP | 46.00 | -4.70 | 1.00 H | 187 | 17.32 | 23.98 |
| 9 | 875.67 | 37.41 QP | 46.00 | -8.59 | 1.50 H | 157 | 11.54 | 25.88 |

| ANTENNA POLARITY & TEST DISTANCE: VERTICAL AT 3 M | | | | | | | | |
|---|-------------|-------------------------|----------------|-------------|--------------------|----------------------|------------------|--------------------------|
| NO. | FREQ. (MHz) | EMISSION LEVEL (dBuV/m) | LIMIT (dBuV/m) | MARGIN (dB) | ANTENNA HEIGHT (m) | TABLE ANGLE (Degree) | RAW VALUE (dBuV) | CORRECTION FACTOR (dB/m) |
| 1 | 39.62 | 36.35 QP | 40.00 | -3.65 | 1.00 V | 88 | 23.90 | 12.45 |
| 2 | 249.60 | 43.11 QP | 46.00 | -2.89 | 1.50 V | 199 | 30.29 | 12.81 |
| 3 | 500.42 | 43.38 QP | 46.00 | -2.62 | 1.50 V | 226 | 24.12 | 19.25 |
| 4 | 624.85 | 39.67 QP | 46.00 | -6.33 | 1.00 V | 106 | 17.56 | 22.11 |
| 5 | 751.23 | 40.10 QP | 46.00 | -5.90 | 1.25 V | 304 | 16.12 | 23.98 |
| 6 | 875.67 | 39.47 QP | 46.00 | -6.53 | 1.25 V | 313 | 13.60 | 25.88 |

- REMARKS:**
1. Emission level (dBuV/m) = Raw Value (dBuV) + Correction Factor (dB/m).
 2. Correction Factor (dB/m) = Antenna Factor (dB/m) + Cable Factor (dB).
 3. The other emission levels were very low against the limit.
 4. Margin value = Emission level – Limit value.



A D T

4.2 CONDUCTED EMISSION MEASUREMENT

4.2.1 LIMITS OF CONDUCTED EMISSION MEASUREMENT

| FREQUENCY OF EMISSION (MHz) | CONDUCTED LIMIT (dB μ V) | |
|-----------------------------|------------------------------|----------|
| | Quasi-peak | Average |
| 0.15 ~ 0.5 | 66 to 56 | 56 to 46 |
| 0.5 ~ 5 | 56 | 46 |
| 5 ~ 30 | 60 | 50 |

- NOTE:** 1. The lower limit shall apply at the transition frequencies.
2. The limit decreases in line with the logarithm of the frequency in the range of 0.15 to 0.50MHz.
3. All emanations from a class A/B digital device or system, including any network of conductors and apparatus connected thereto, shall not exceed the level of field strengths specified above.

4.2.2 TEST INSTRUMENTS

| DESCRIPTION & MANUFACTURER | MODEL NO. | SERIAL NO. | DATE OF CALIBRATION | DUE DATE OF CALIBRATION |
|----------------------------------|---------------------|----------------|---------------------|-------------------------|
| Test Receiver ROHDE & SCHWARZ | ESCS30 | 100291 | Nov. 19, 2008 | Nov. 18, 2009 |
| RF signal cable Woken | 5D-FB | Cable-HYC01-01 | Dec. 31, 2008 | Dec. 30, 2009 |
| LISN ROHDE & SCHWARZ | ESH3-Z5 | 100312 | Jun. 13, 2008 | Jun. 12, 2009 |
| LISN ROHDE & SCHWARZ | ESH2-Z5 | 100104 | Dec. 04, 2008 | Dec. 03, 2009 |
| Software ADT | ADT_Cond_ V7.3.7 | NA | NA | NA |

- NOTE:** 1. The calibration interval of the above test instruments is 12 months and the calibrations are traceable to NML/ROC and NIST/USA.
2. The test was performed in HwaYa Shielded Room 1.
3. The VCCI Site Registration No. is C-2040.



A D T

4.2.3 TEST PROCEDURES

- a. The EUT was placed 0.4 meters from the conducting wall of the shielded room with EUT being connected to the power mains through a line impedance stabilization network (LISN). Other support units were connected to the power mains through another LISN. The two LISNs provide 50 ohm/ 50uH of coupling impedance for the measuring instrument.
- b. Both lines of the power mains connected to the EUT were checked for maximum conducted interference.
- c. The frequency range from 150kHz to 30MHz was searched. Emission levels under (Limit - 20dB) was not recorded.

NOTE: All modes of operation were investigated and the worst-case emissions are reported.

4.2.4 DEVIATION FROM TEST STANDARD

No deviation.

4.2.5 TEST SETUP

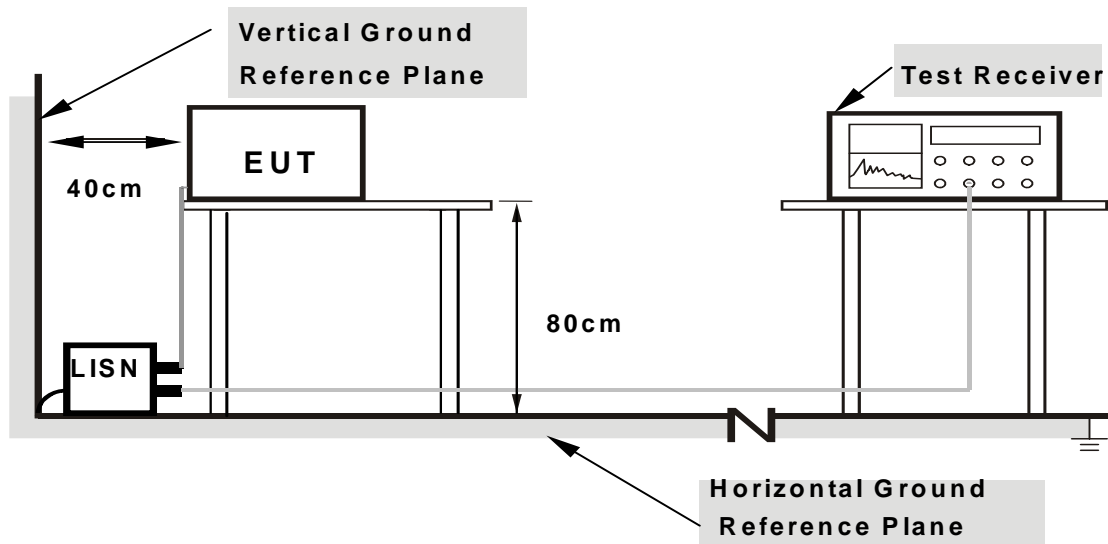

- Note:**
1. Support units were connected to second LISN.
 2. Both of LISNs (AMN) are 80 cm from EUT and at least 80 from other units and other metal planes

For the actual test configuration, please refer to the attached file (Test Setup Photo).

4.2.6 EUT OPERATING CONDITIONS

Same as 4.1.6.

4.2.7 TEST RESULTS

CONDUCTED WORST-CASE DATA : DRAFT 802.11n (40MHz) OFDM MODULATION

| EUT TEST CONDITION | | MEASUREMENT DETAIL | |
|--------------------------|--------------------------|--------------------|--------------|
| CHANNEL | Channel 4 | PHASE | Line 1 |
| MODULATION TYPE | BPSK | INPUT POWER | 120Vac, 60Hz |
| TRANSFER RATE | 15.0Mbps | 6dB BANDWIDTH | 9kHz |
| ENVIRONMENTAL CONDITIONS | 25deg. C, 65%RH, 1011hPa | TESTED BY | Mark Liao |

| No | Freq. [MHz] | Corr. Factor [dB] | Reading Value [dB (uV)] | | Emission Level [dB (uV)] | | Limit [dB (uV)] | | Margin (dB) | |
|----|-------------|-------------------|-------------------------|-------|--------------------------|-------|-----------------|-------|-------------|-------|
| | | | Q.P. | AV. | Q.P. | AV. | Q.P. | AV. | Q.P. | AV. |
| | | | 1 | 0.157 | 0.13 | 60.16 | 49.58 | 60.29 | 49.71 | 65.60 |
| 2 | 0.209 | 0.13 | 52.52 | - | 52.65 | - | 63.26 | 53.26 | -10.61 | - |
| 3 | 0.257 | 0.13 | 44.72 | - | 44.85 | - | 61.53 | 51.53 | -16.68 | - |
| 4 | 0.509 | 0.15 | 36.34 | - | 36.49 | - | 56.00 | 46.00 | -19.51 | - |
| 5 | 4.668 | 0.40 | 23.88 | - | 24.28 | - | 56.00 | 46.00 | -31.72 | - |
| 6 | 29.434 | 1.24 | 30.65 | - | 31.89 | - | 60.00 | 50.00 | -28.11 | - |

- REMARKS:**
1. Q.P. and AV. are abbreviations of quasi-peak and average individually.
 2. "-": The Quasi-peak reading value also meets average limit and measurement with the average detector is unnecessary.
 3. The emission levels of other frequencies were very low against the limit.
 4. Margin value = Emission level - Limit value
 5. Correction factor = Insertion loss + Cable loss
 6. Emission Level = Correction Factor + Reading Value.

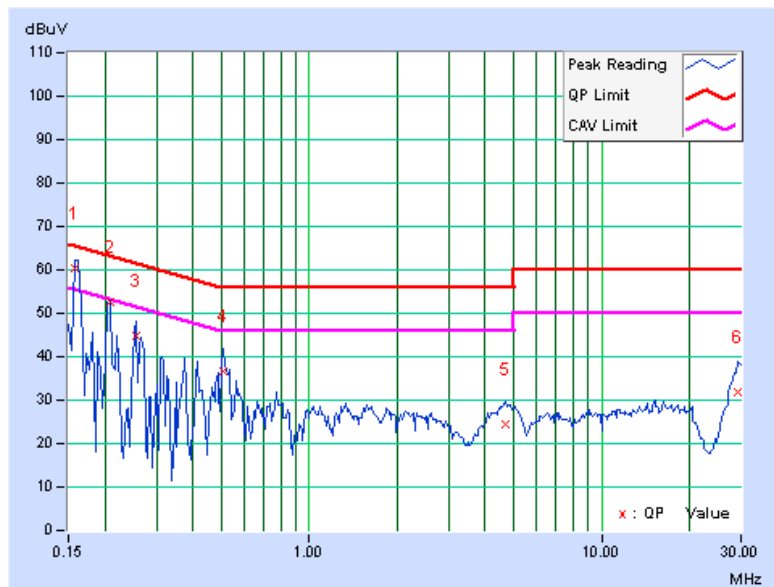

| EUT TEST CONDITION | | MEASUREMENT DETAIL | |
|--------------------------|--------------------------|--------------------|--------------|
| CHANNEL | Channel 4 | PHASE | Line 2 |
| MODULATION TYPE | BPSK | INPUT POWER | 120Vac, 60Hz |
| TRANSFER RATE | 15.0Mbps | 6dB BANDWIDTH | 9kHz |
| ENVIRONMENTAL CONDITIONS | 25deg. C, 65%RH, 1011hPa | TESTED BY | Mark Liao |

| No | Freq. [MHz] | Corr. Factor (dB) | Reading Value [dB (uV)] | | Emission Level [dB (uV)] | | Limit [dB (uV)] | | Margin (dB) | |
|----|-------------|-------------------|-------------------------|-------|--------------------------|-------|-----------------|-------|-------------|-------|
| | | | Q.P. | AV. | Q.P. | AV. | Q.P. | AV. | Q.P. | AV. |
| | | | 1 | 0.162 | 0.14 | 58.99 | 46.08 | 59.13 | 46.22 | 65.38 |
| 2 | 0.209 | 0.15 | 51.99 | - | 52.14 | - | 63.26 | 53.26 | -11.12 | - |
| 3 | 0.267 | 0.15 | 43.09 | - | 43.24 | - | 61.20 | 51.20 | -17.96 | - |
| 4 | 0.369 | 0.16 | 35.88 | - | 36.04 | - | 58.53 | 48.53 | -22.49 | - |
| 5 | 0.529 | 0.17 | 35.03 | - | 35.20 | - | 56.00 | 46.00 | -20.80 | - |
| 6 | 29.523 | 0.73 | 30.53 | - | 31.26 | - | 60.00 | 50.00 | -28.74 | - |

- REMARKS:**
1. Q.P. and AV. are abbreviations of quasi-peak and average individually.
 2. "-": The Quasi-peak reading value also meets average limit and measurement with the average detector is unnecessary.
 3. The emission levels of other frequencies were very low against the limit.
 4. Margin value = Emission level - Limit value
 5. Correction factor = Insertion loss + Cable loss
 6. Emission Level = Correction Factor + Reading Value.

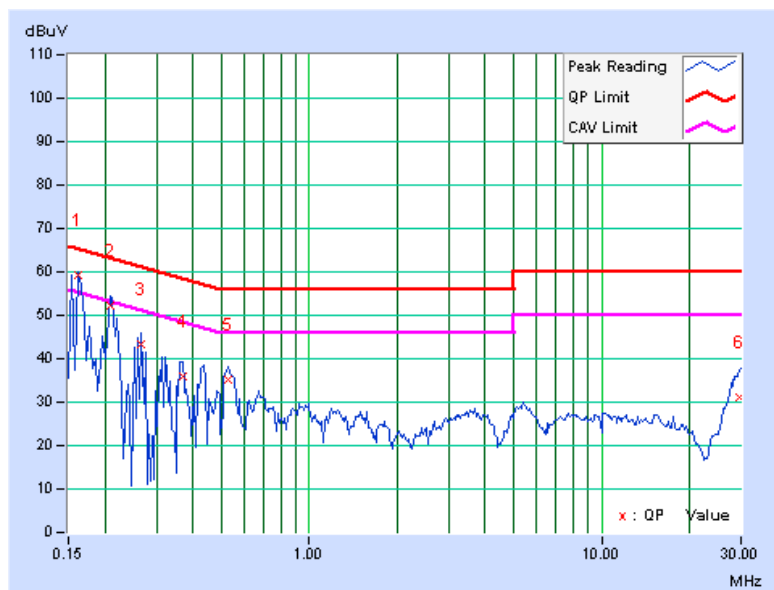



4.3 6dB BANDWIDTH MEASUREMENT

4.3.1 LIMITS OF 6dB BANDWIDTH MEASUREMENT

The minimum of 6dB Bandwidth Measurement is 0.5 MHz.

4.3.2 TEST INSTRUMENTS

| DESCRIPTION & MANUFACTURER | MODEL NO. | SERIAL NO. | DATE OF CALIBRATION | DUE DATE OF CALIBRATION |
|----------------------------|-----------|------------|---------------------|-------------------------|
| R&S SPECTRUM ANALYZER | FSP40 | 100040 | Jul. 04, 2008 | Jul. 03, 2009 |

NOTE: The calibration interval of the above test instruments is 12 months and the calibrations are traceable to NML/ROC and NIST/USA.

4.3.3 TEST PROCEDURE

The transmitter output was connected to the spectrum analyzer through an attenuator. The bandwidth of the fundamental frequency was measured by spectrum analyzer with 100kHz RBW and 300kHz VBW. The 6dB bandwidth is defined as the total spectrum the power of which is higher than peak power minus 6dB.

4.3.4 DEVIATION FROM TEST STANDARD

No deviation.

4.3.5 TEST SETUP

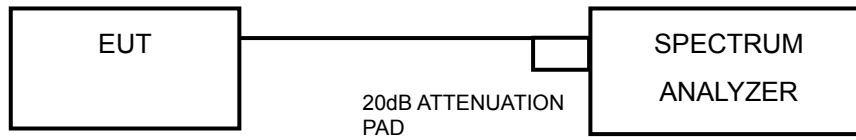

4.3.6 EUT OPERATING CONDITIONS

The software provided by client to enable the EUT under transmission condition continuously at lowest, middle and highest channel frequencies individually.



A D T

4.3.7 TEST RESULTS

802.11b DSSS MODULATION

| | | | |
|------------------------|--------------|---------------------------------|---------------------------|
| MODULATION TYPE | DBPSK | TRANSFER RATE | 1.0Mbps |
| INPUT POWER | 120Vac, 60Hz | ENVIRONMENTAL CONDITIONS | 23 deg.C, 70 %RH, 1009hPa |
| TESTED BY | Lori Chiu | | |

| CHANNEL | CHANNEL FREQUENCY (MHz) | 6dB BANDWIDTH (MHz) | | MINIMUM LIMIT (MHz) | PASS / FAIL |
|---------|-------------------------|---------------------|---------|---------------------|-------------|
| | | CHAIN 0 | CHAIN 1 | | |
| 1 | 2412 | 10.14 | 10.15 | 0.5 | PASS |
| 6 | 2437 | 12.08 | 12.07 | 0.5 | PASS |
| 11 | 2462 | 12.11 | 11.14 | 0.5 | PASS |



A D T

FOR CHAIN 0: CH 1

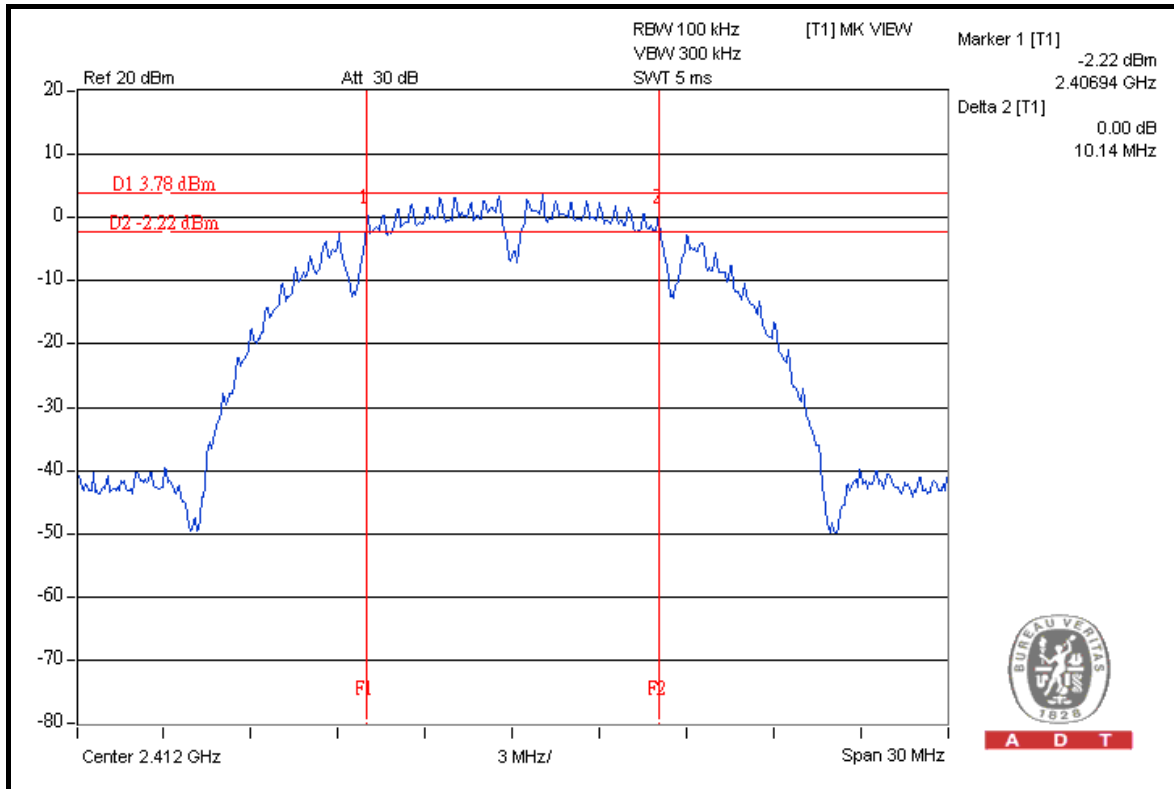

CH 6

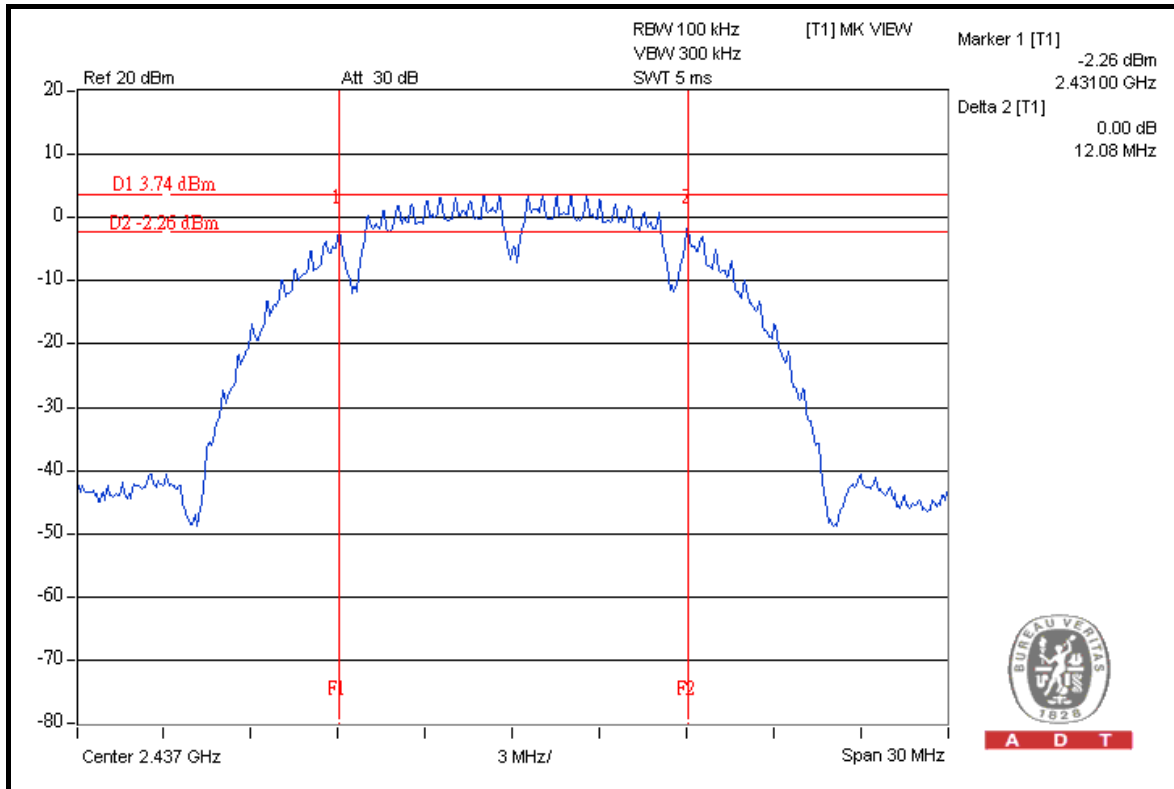



A D T

CH 11

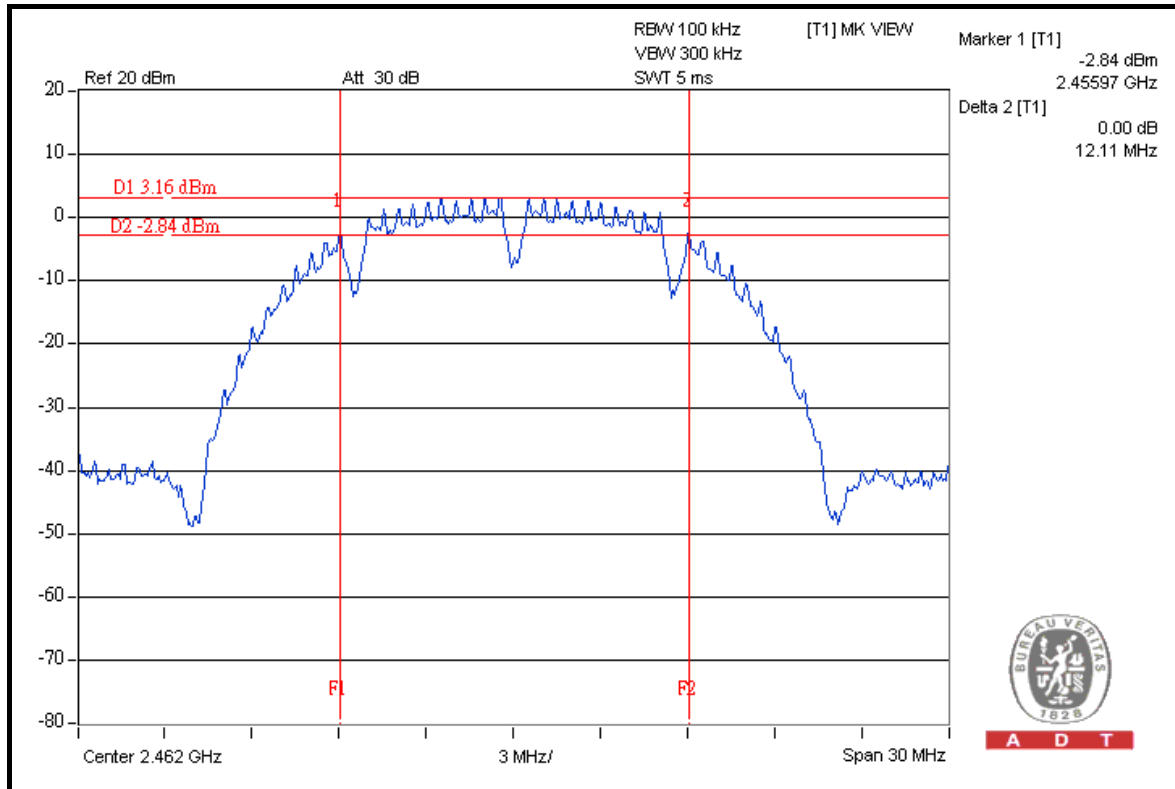

FOR CHAIN 1: CH 1

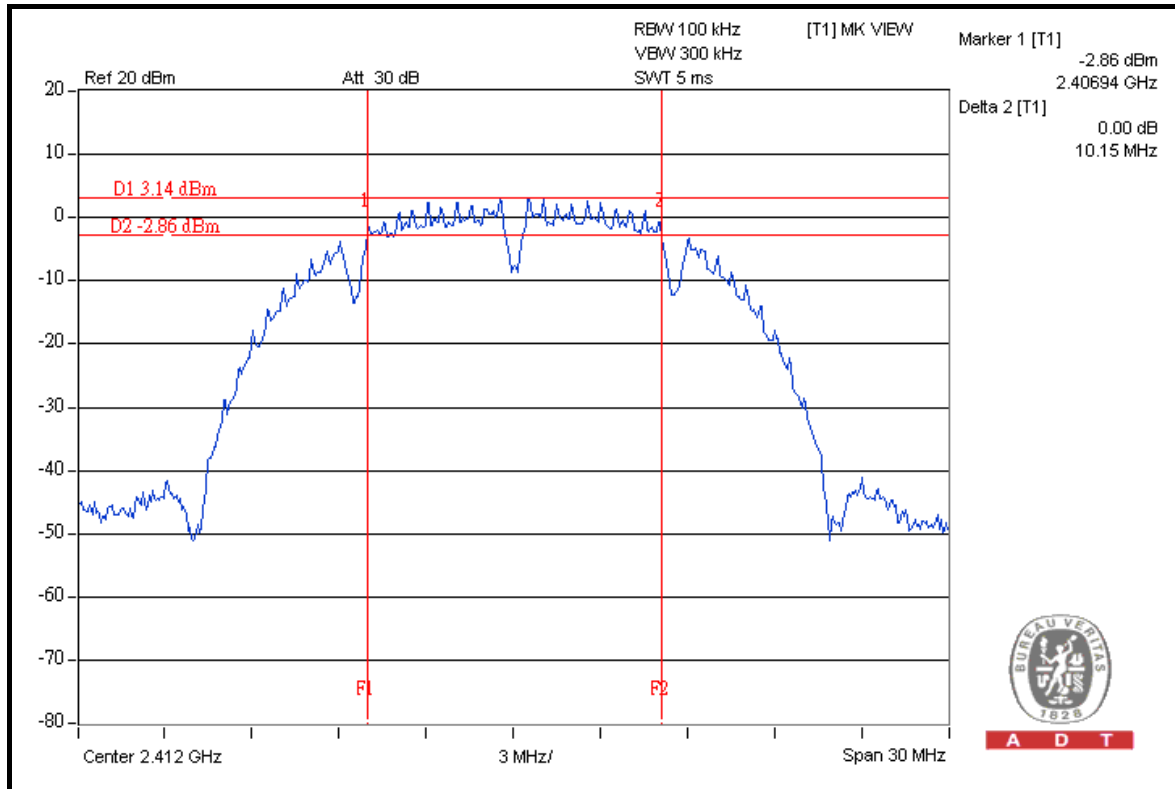



A D T

CH 6

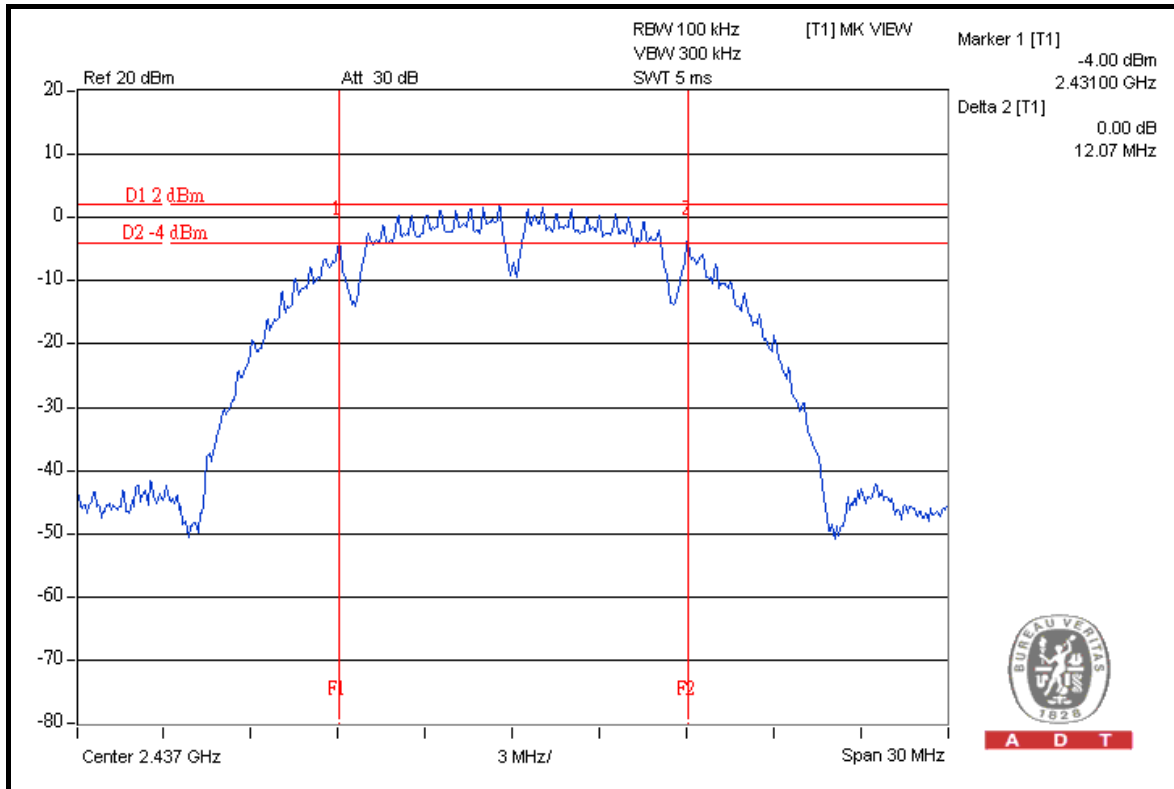

CH 11

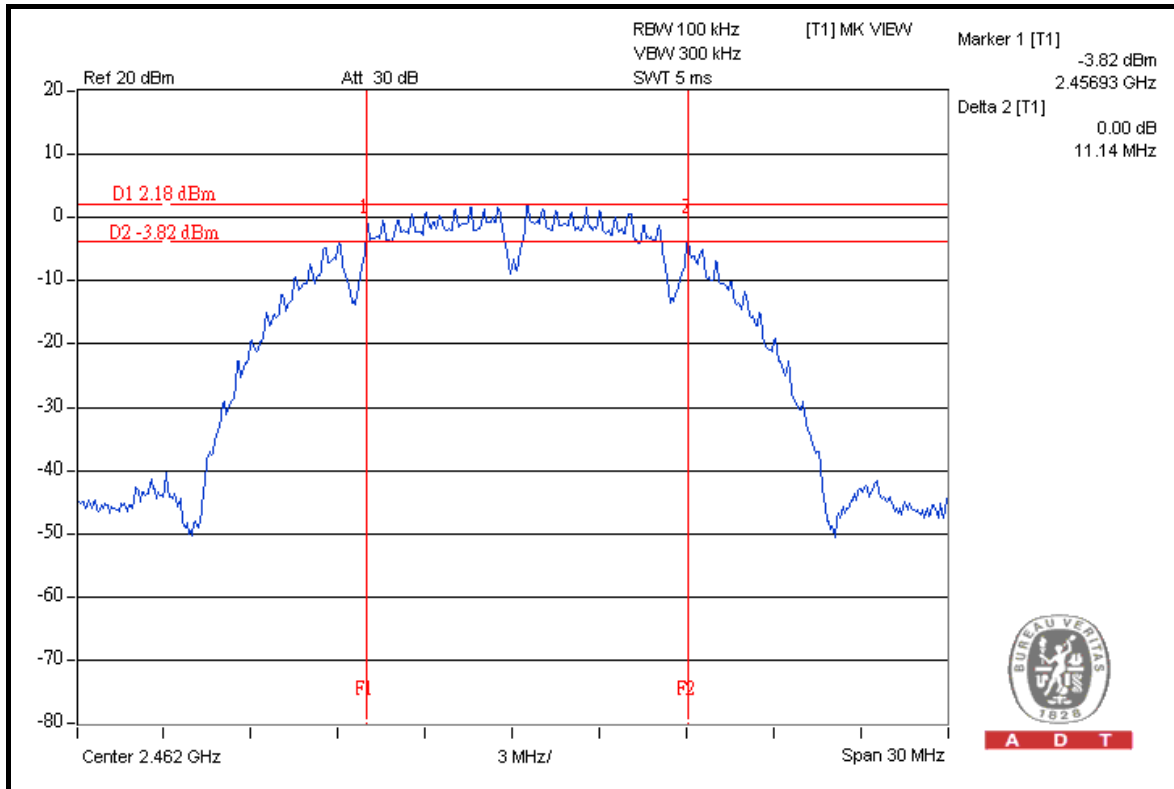



A D T

802.11g OFDM MODULATION

| | | | |
|------------------------|--------------|---------------------------------|---------------------------|
| MODULATION TYPE | BPSK | TRANSFER RATE | 6.0Mbps |
| INPUT POWER | 120Vac, 60Hz | ENVIRONMENTAL CONDITIONS | 23 deg.C, 70 %RH, 1009hPa |
| TESTED BY | Lori Chiu | | |

| CHANNEL | CHANNEL FREQUENCY (MHz) | 6dB BANDWIDTH (MHz) | | MINIMUM LIMIT (MHz) | PASS / FAIL |
|---------|-------------------------|---------------------|---------|---------------------|-------------|
| | | CHAIN 0 | CHAIN 1 | | |
| 1 | 2412 | 16.43 | 16.42 | 0.5 | PASS |
| 6 | 2437 | 16.44 | 16.40 | 0.5 | PASS |
| 11 | 2462 | 16.43 | 16.45 | 0.5 | PASS |



A D T

FOR CHAIN 0: CH 1

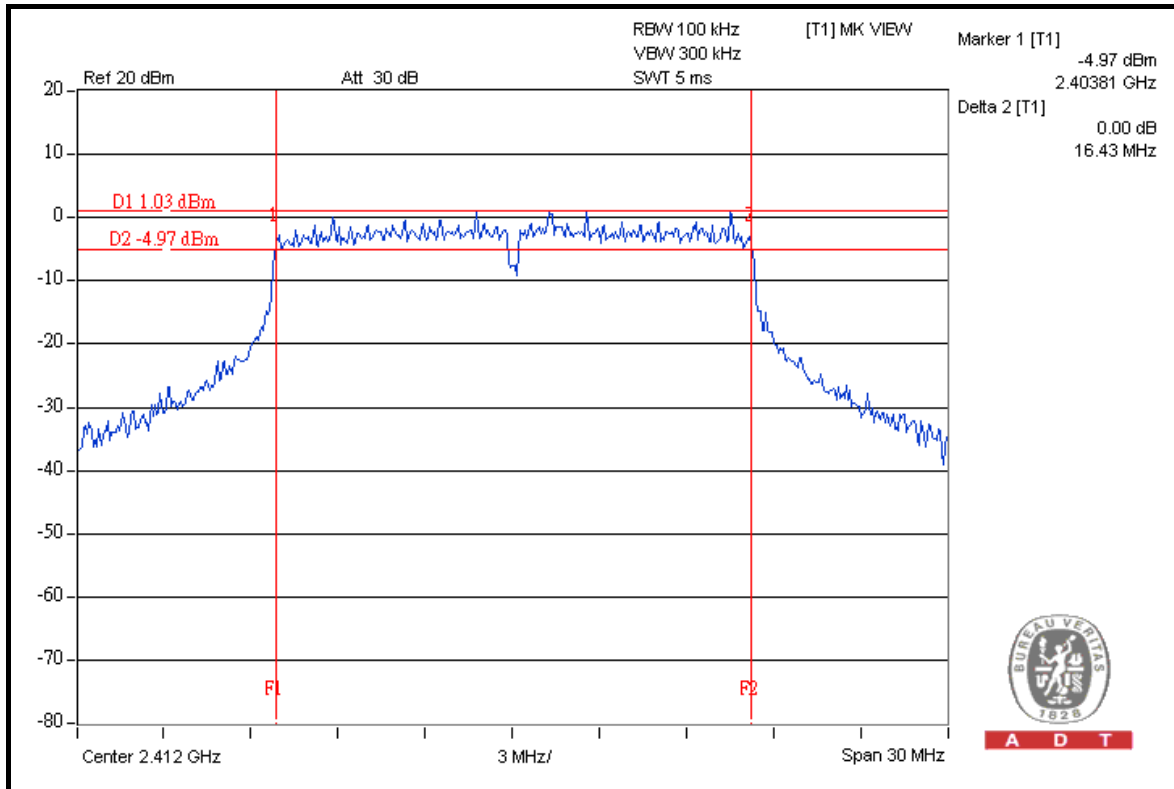

CH 6

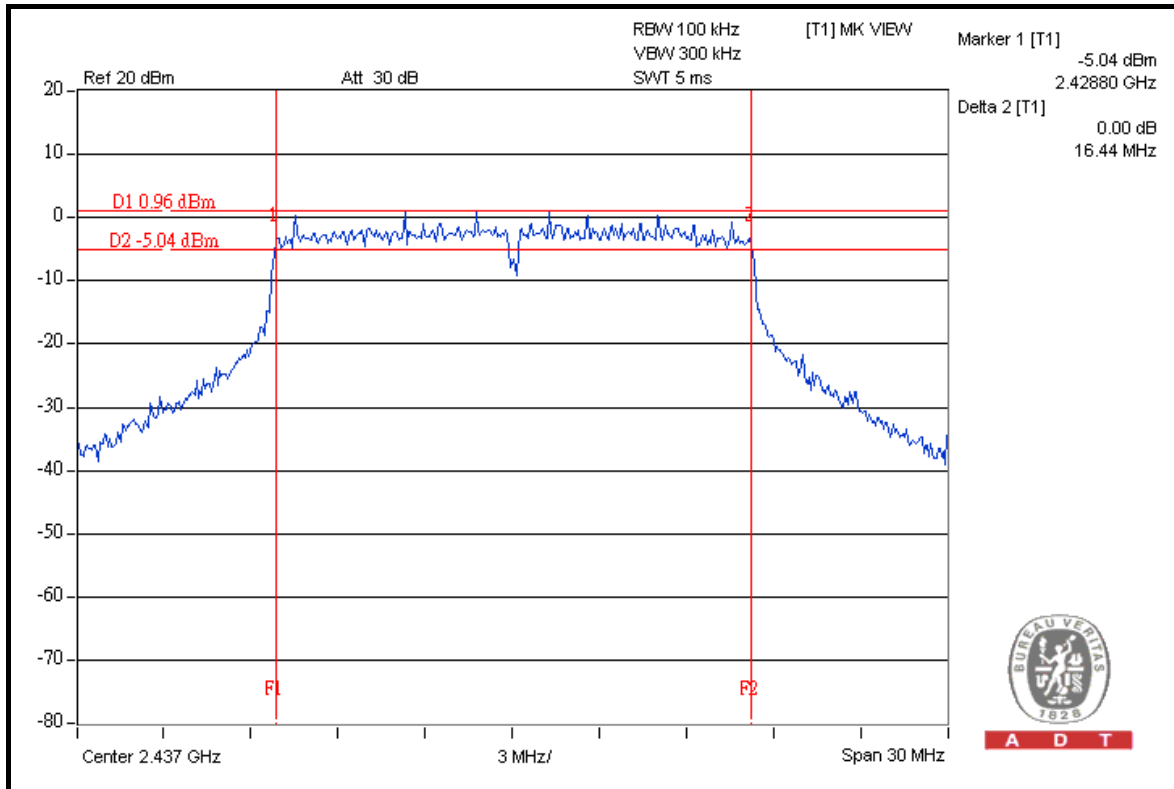



A D T

CH 11

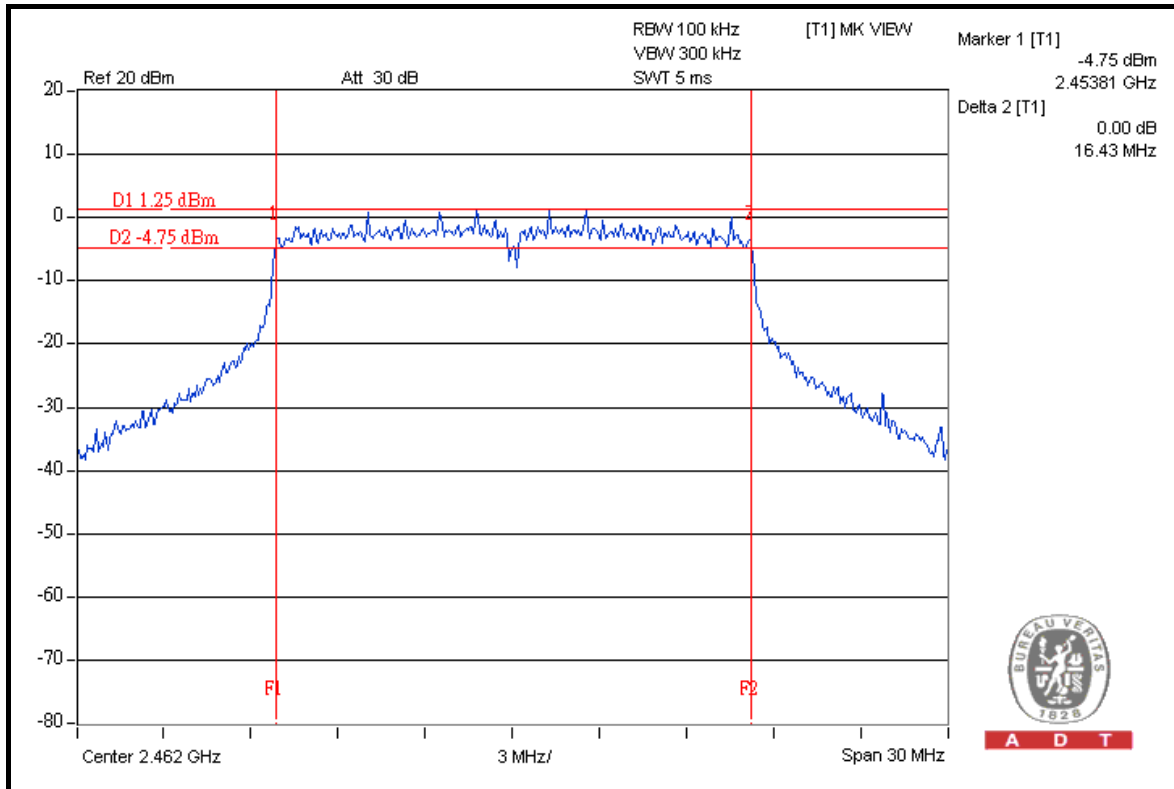

FOR CHAIN 1: CH 1

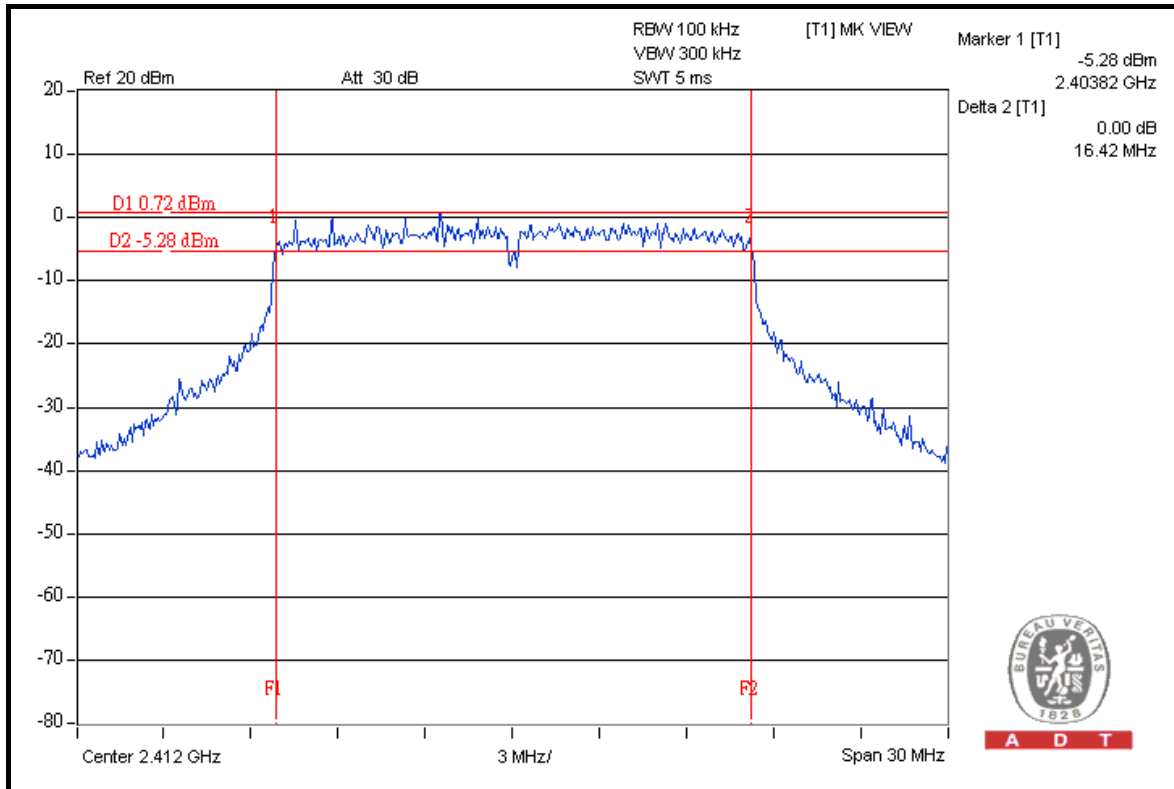



A D T

CH 6

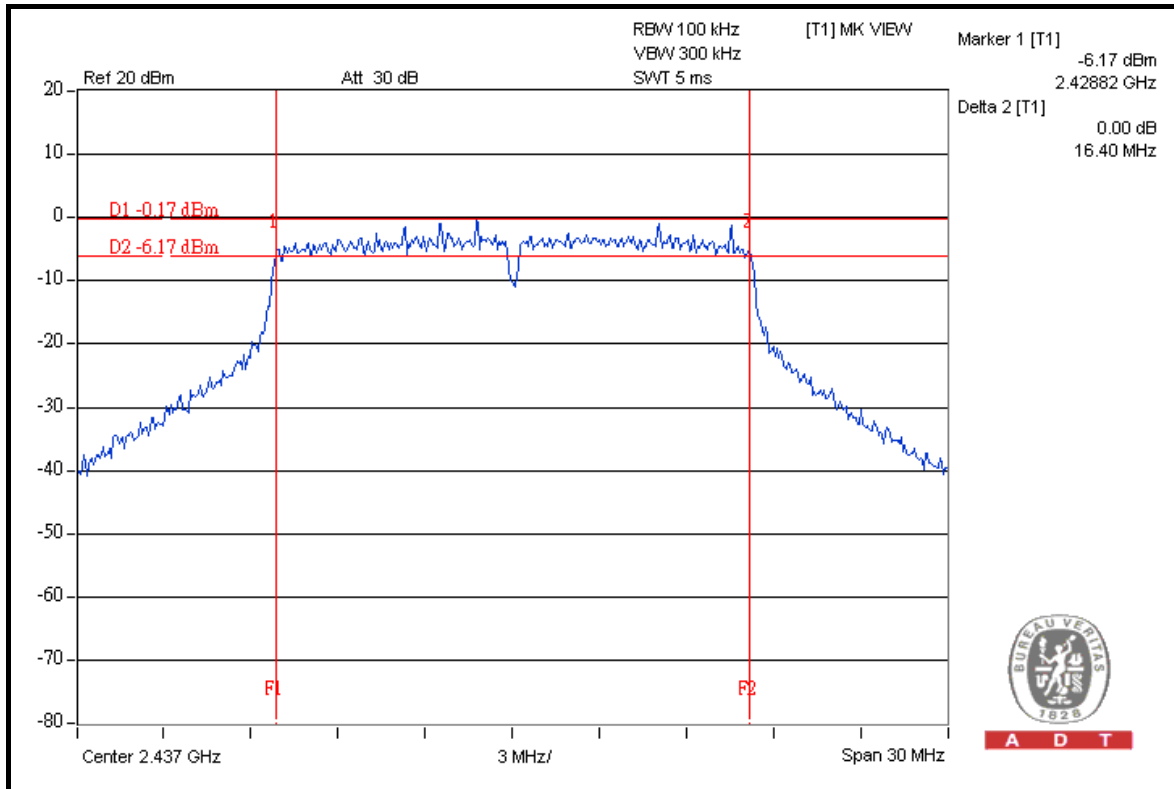

A D T

CH 11

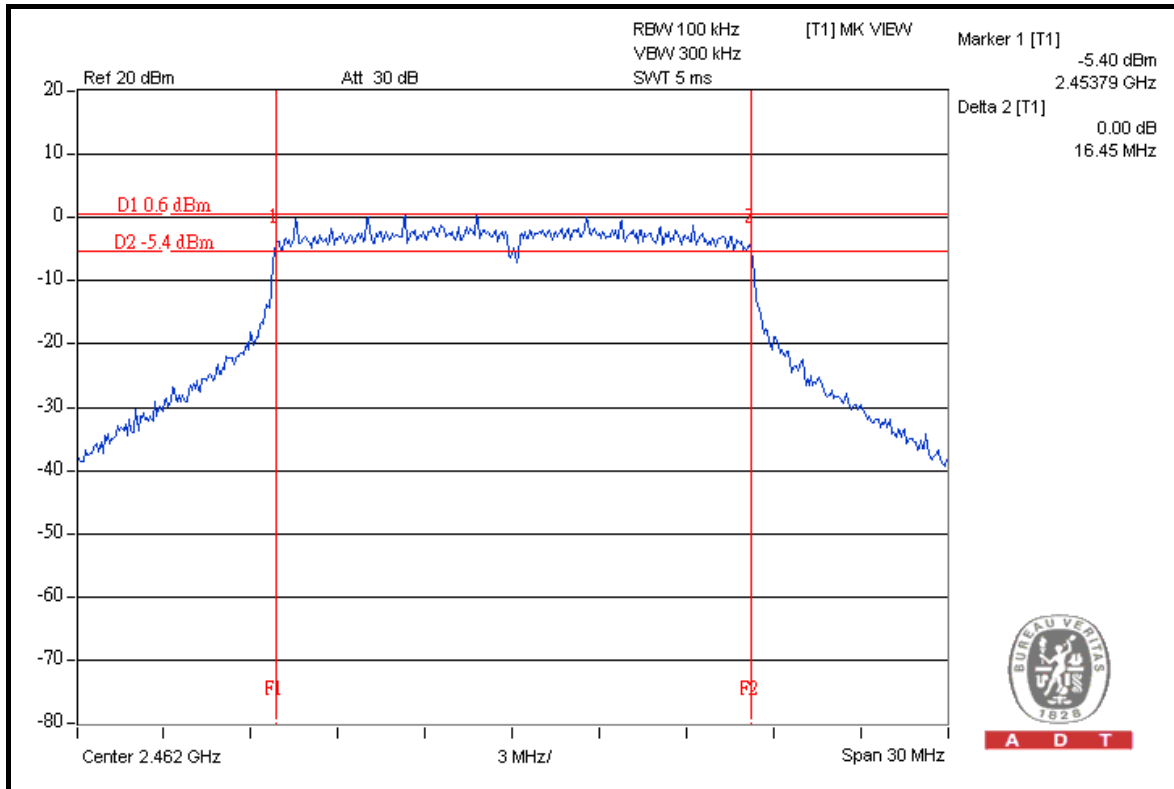

A D T



A D T

DRAFT 802.11n (20MHz) OFDM MODULATION

| | | | |
|------------------------|--------------|---------------------------------|---------------------------|
| MODULATION TYPE | BPSK | TRANSFER RATE | 7.2Mbps |
| INPUT POWER | 120Vac, 60Hz | ENVIRONMENTAL CONDITIONS | 23 deg.C, 70 %RH, 1009hPa |
| TESTED BY | Lori Chiu | | |

| CHANNEL | CHANNEL FREQUENCY (MHz) | 6dB BANDWIDTH (MHz) | | MINIMUM LIMIT (MHz) | PASS / FAIL |
|---------|-------------------------|---------------------|---------|---------------------|-------------|
| | | CHAIN 0 | CHAIN 1 | | |
| 1 | 2412 | 17.64 | 17.61 | 0.5 | PASS |
| 6 | 2437 | 17.62 | 17.60 | 0.5 | PASS |
| 11 | 2462 | 17.63 | 17.62 | 0.5 | PASS |



A D T

FOR CHAIN 0: CH 1

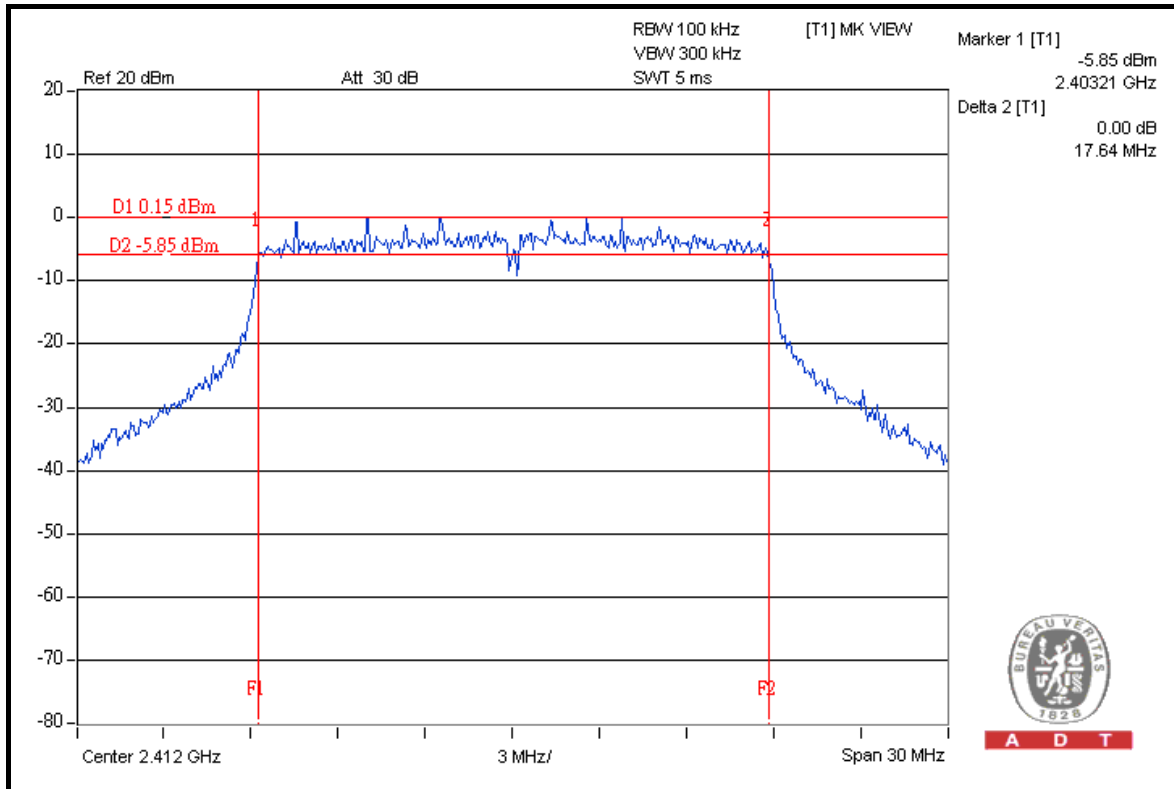

CH 6

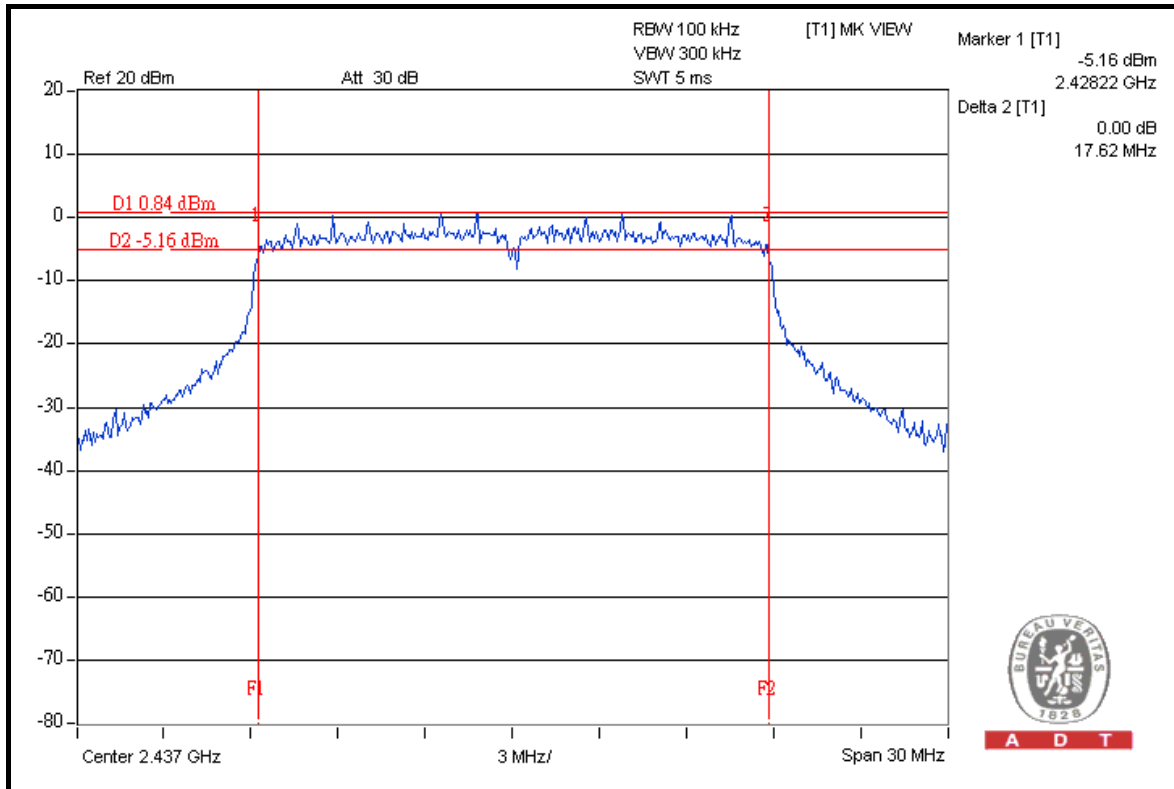



A D T

CH 11

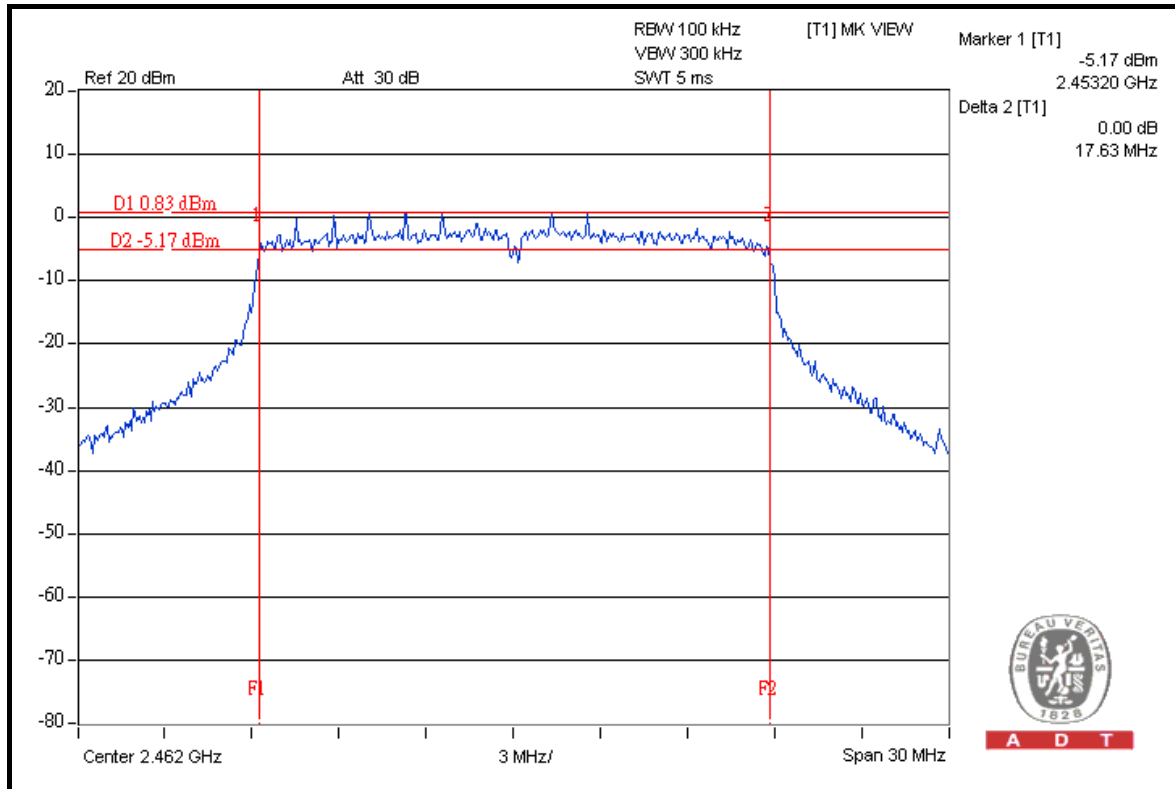

FOR CHAIN 1: CH 1

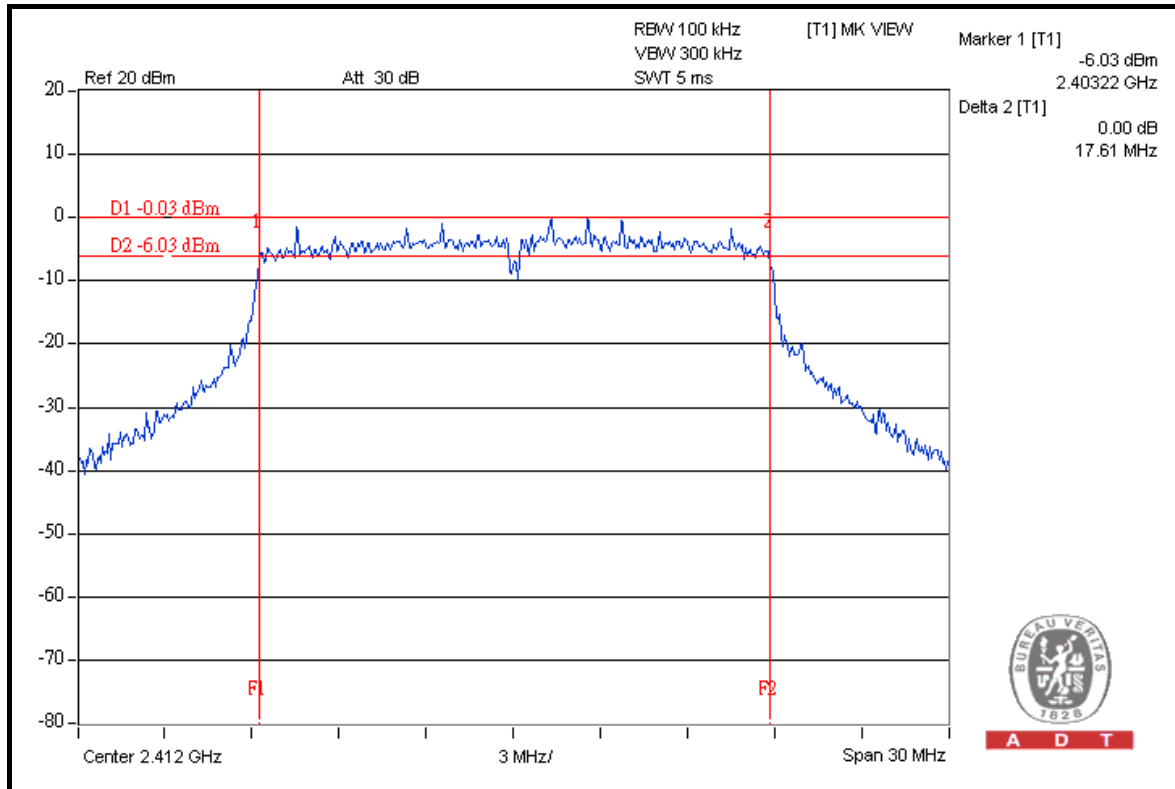



A D T

CH 6

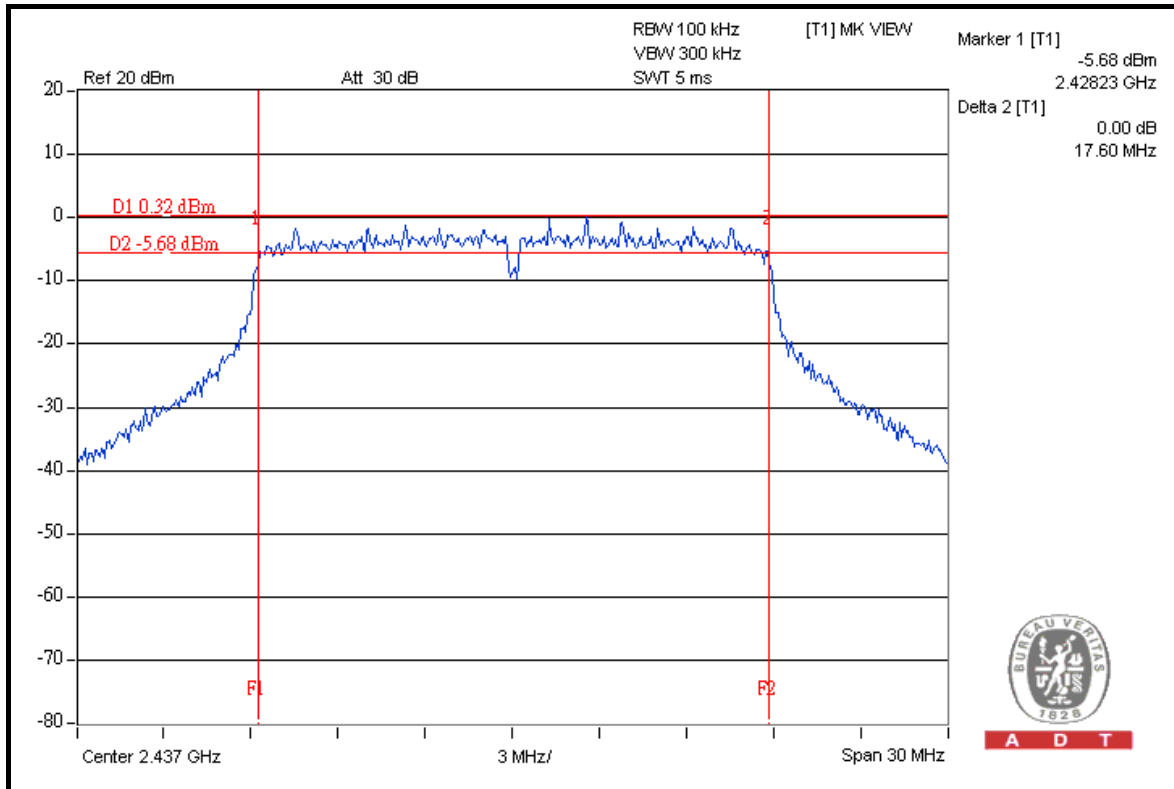

CH 11

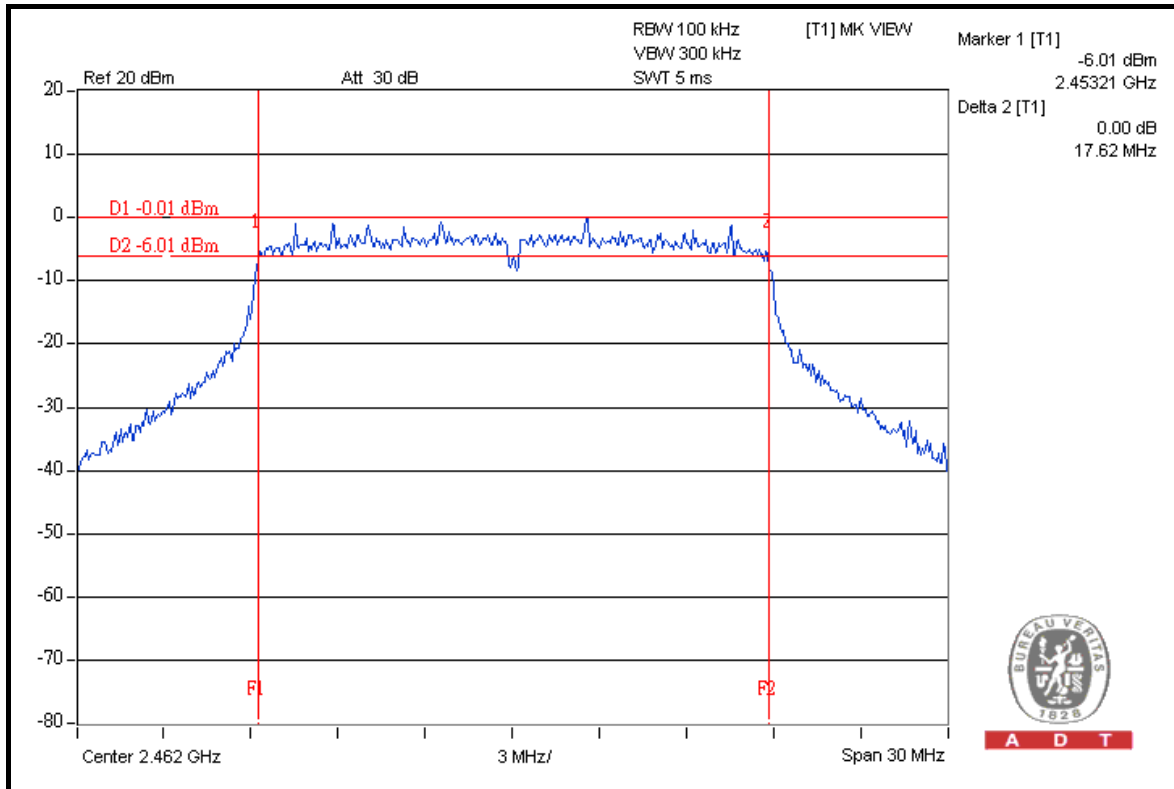



A D T

DRAFT 802.11n (40MHz) OFDM MODULATION

| | | | |
|------------------------|--------------|---------------------------------|---------------------------|
| MODULATION TYPE | BPSK | TRANSFER RATE | 15.0Mbps |
| INPUT POWER | 120Vac, 60Hz | ENVIRONMENTAL CONDITIONS | 23 deg.C, 70 %RH, 1009hPa |
| TESTED BY | Lori Chiu | | |

| CHANNEL | CHANNEL FREQUENCY (MHz) | 6dB BANDWIDTH (MHz) | | MINIMUM LIMIT (MHz) | PASS / FAIL |
|---------|-------------------------|---------------------|---------|---------------------|-------------|
| | | CHAIN 0 | CHAIN 1 | | |
| 1 | 2422 | 36.54 | 36.45 | 0.5 | PASS |
| 4 | 2437 | 36.53 | 36.54 | 0.5 | PASS |
| 7 | 2452 | 36.53 | 36.42 | 0.5 | PASS |



A D T

FOR CHAIN 0: CH 1

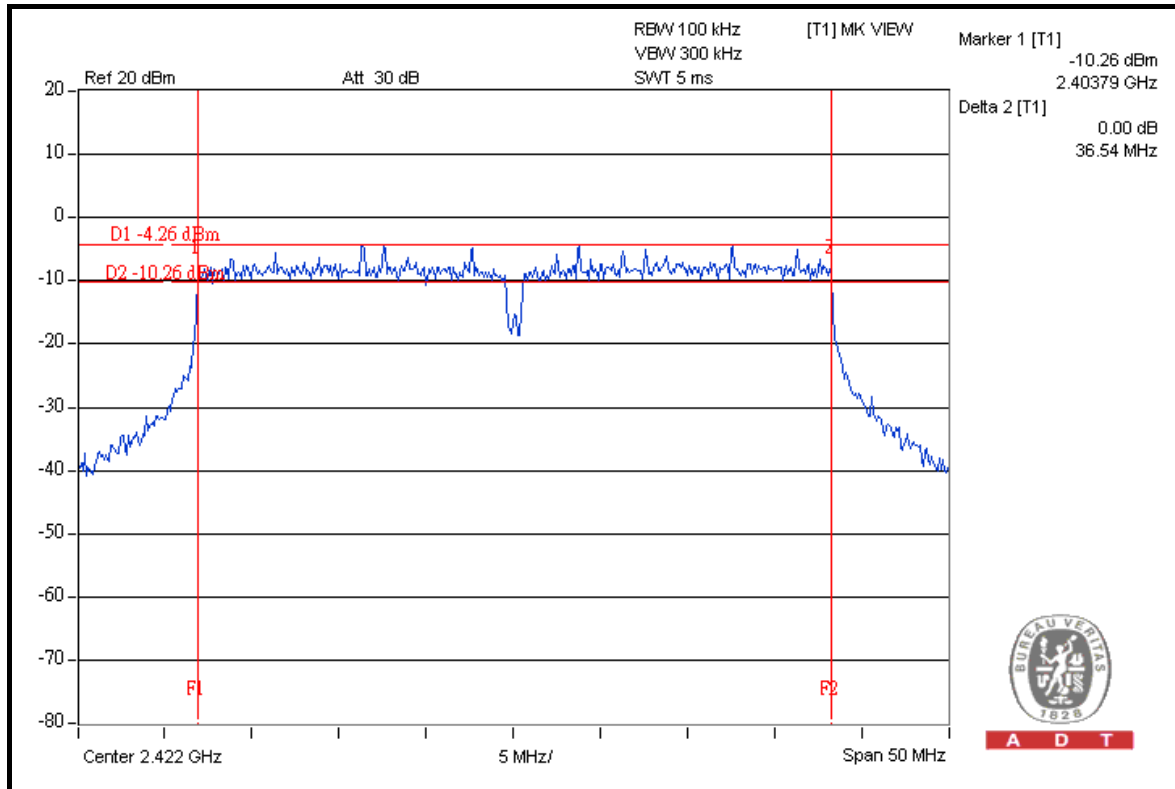

CH 4

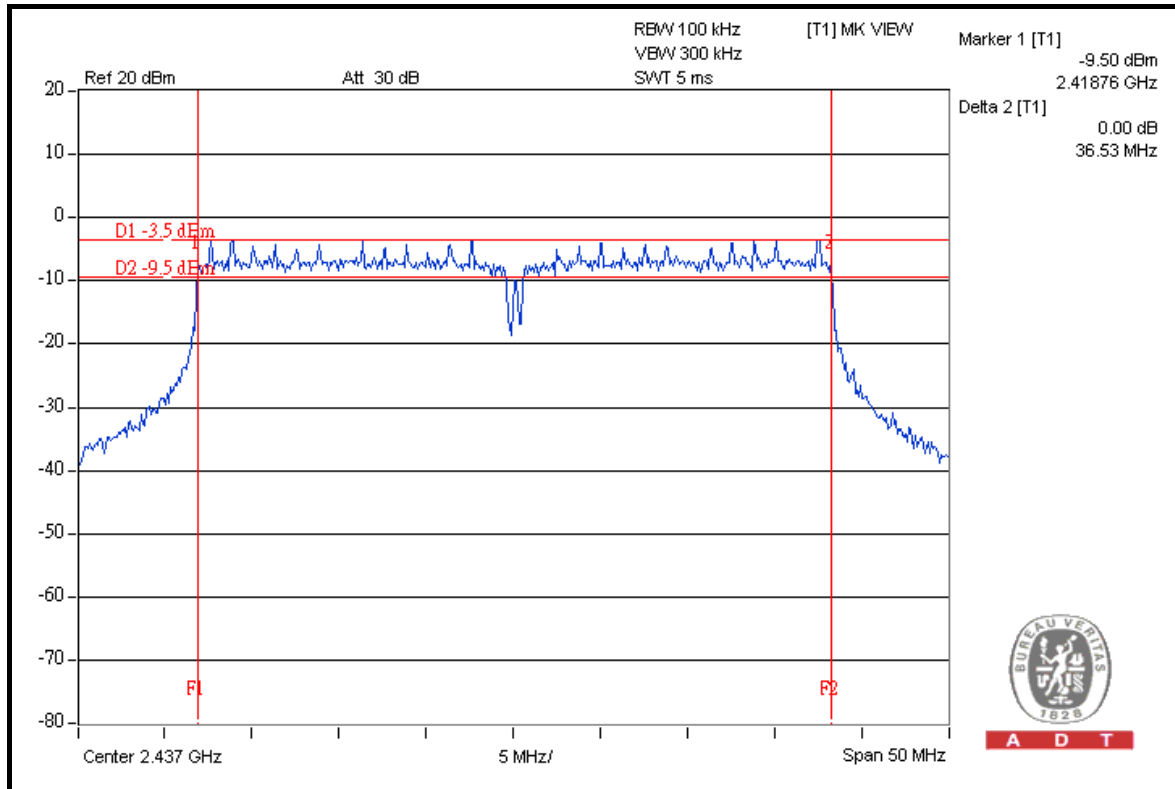



A D T

CH 7

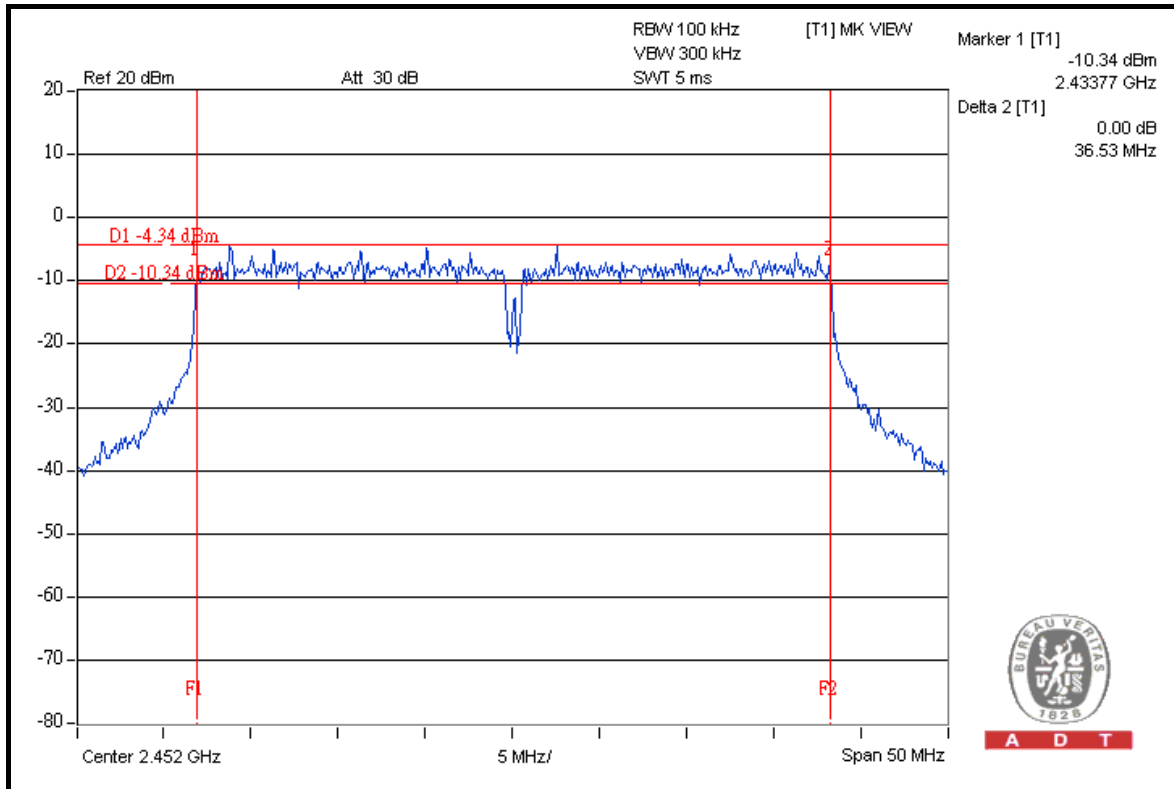

FOR CHAIN 1: CH 1

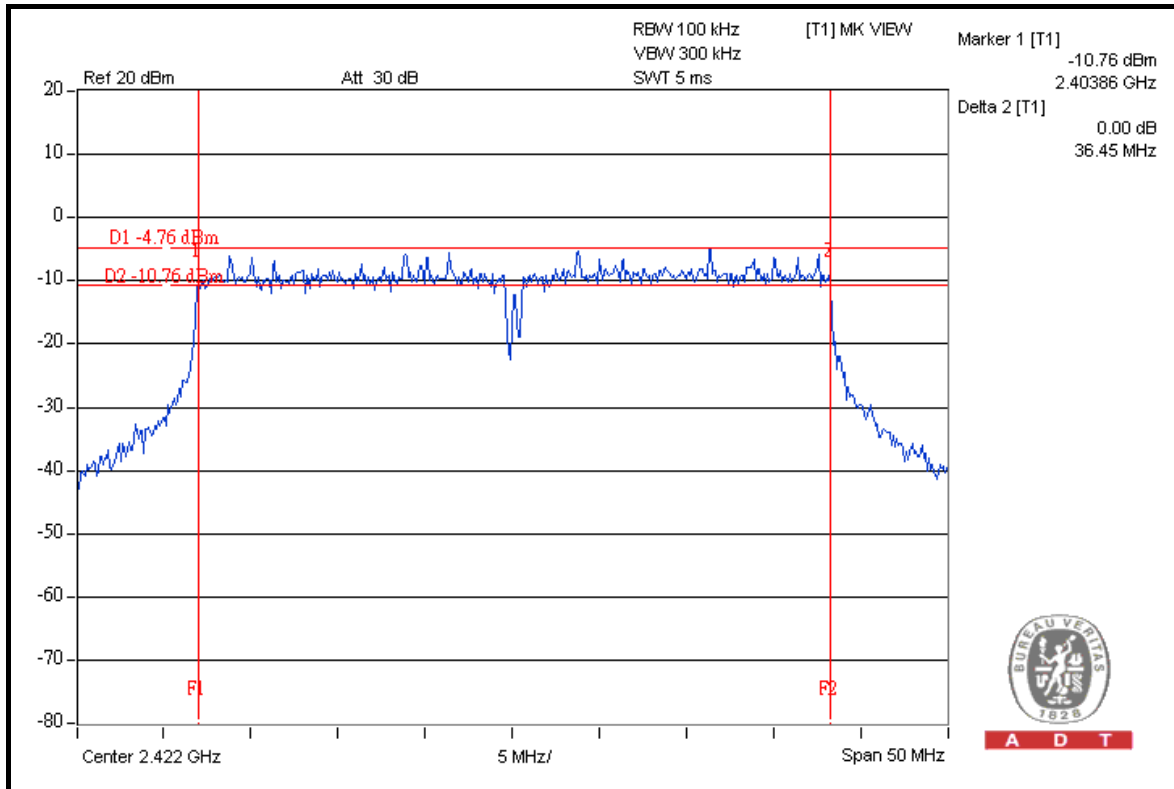



A D T

CH 4

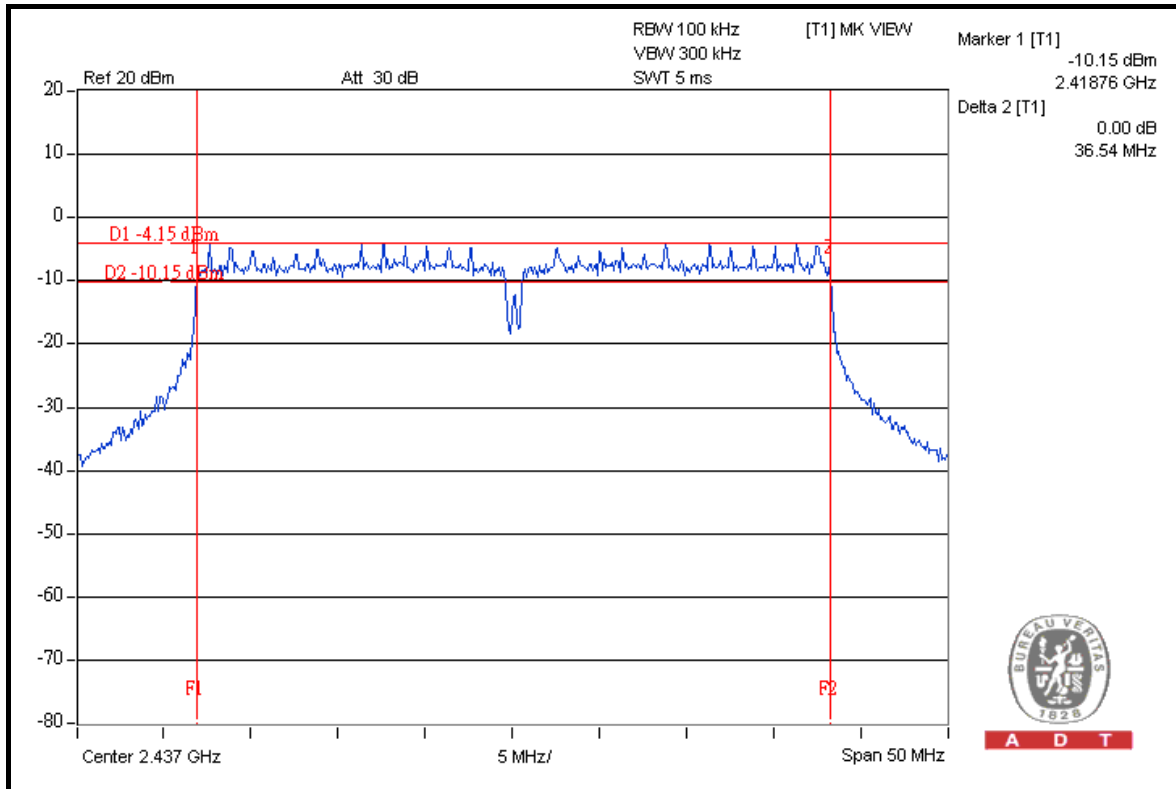

CH 7

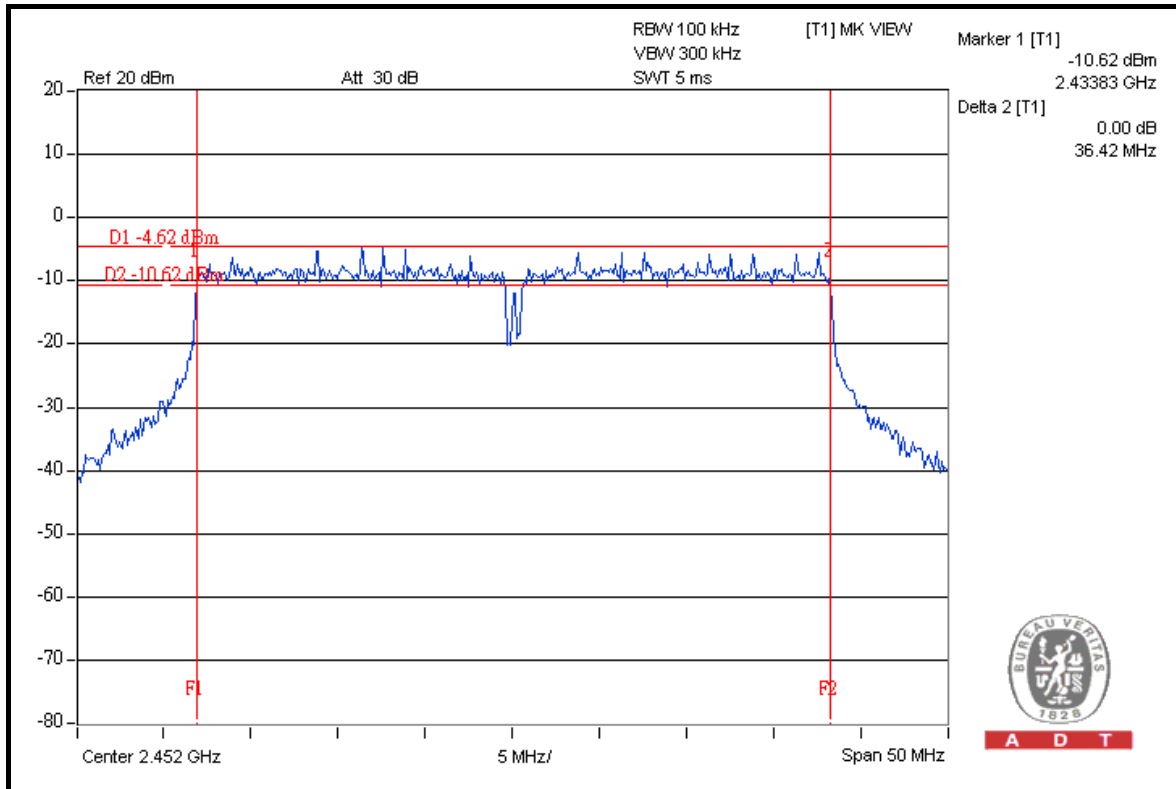



A D T

4.4 MAXIMUM PEAK OUTPUT POWER

4.4.1 LIMITS OF MAXIMUM PEAK OUTPUT POWER MEASUREMENT

The Maximum Peak Output Power Measurement is 30dBm.

4.4.2 INSTRUMENTS

| DESCRIPTION & MANUFACTURER | MODEL NO. | SERIAL NO. | DATE OF CALIBRATION | DUE DATE OF CALIBRATION |
|-----------------------------|-----------|------------|---------------------|-------------------------|
| High Speed Peak Power Meter | ML2495A | 0824012 | Aug. 04, 2008 | Aug. 03, 2009 |
| Power Sensor | MA2411B | 0738138 | Aug. 04, 2008 | Aug. 03, 2009 |

NOTE:

1. The calibration interval of the above test instruments is 12 months and the calibrations are traceable to NML/ROC and NIST/USA.
2. Measurement Bandwidth of ML2495A is 65MHz greater than 6dB bandwidth of emission.

4.4.3 TEST PROCEDURES

A power sensor was used on the output port of the EUT. A power meter was used to read the response of the power sensor. Record the power level.

4.4.4 DEVIATION FROM TEST STANDARD

No deviation.

4.4.5 TEST SETUP

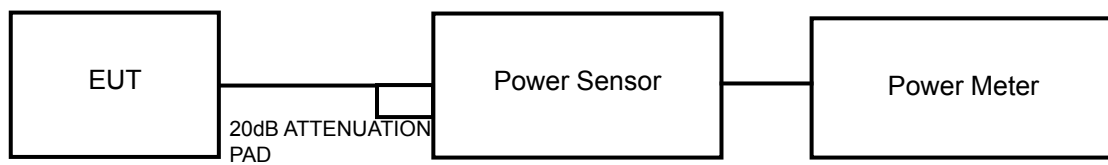

4.4.6 EUT OPERATING CONDITIONS

Same as Item 4.3.6.



A D T

4.4.7 TEST RESULTS

802.11b DSSS MODULATION

| | | | |
|------------------------|--------------|---------------------------------|---------------------------|
| MODULATION TYPE | DBPSK | TRANSFER RATE | 1.0Mbps |
| INPUT POWER | 120Vac, 60Hz | ENVIRONMENTAL CONDITIONS | 23 deg.C, 70 %RH, 1009hPa |
| TESTED BY | Lori Chiu | | |

| CHAN. | CHAN. FREQ. (MHz) | PEAK POWER OUTPUT (dBm) | | TOTAL PEAK POWER (mW) | TOTAL PEAK POWER (dBm) | PEAK POWER LIMIT (dBm) | PASS / FAIL |
|-------|-------------------|-------------------------|---------|-----------------------|------------------------|------------------------|-------------|
| | | CHAIN 0 | CHAIN 1 | | | | |
| 1 | 2412 | 17.05 | 16.52 | 95.574 | 19.80 | 30 | PASS |
| 6 | 2437 | 17.03 | 15.54 | 86.276 | 19.36 | 30 | PASS |
| 11 | 2462 | 16.64 | 15.76 | 83.802 | 19.23 | 30 | PASS |

802.11g OFDM MODULATION

| | | | |
|------------------------|--------------|---------------------------------|---------------------------|
| MODULATION TYPE | BPSK | TRANSFER RATE | 6.0Mbps |
| INPUT POWER | 120Vac, 60Hz | ENVIRONMENTAL CONDITIONS | 23 deg.C, 70 %RH, 1009hPa |
| TESTED BY | Lori Chiu | | |

| CHAN. | CHAN. FREQ. (MHz) | PEAK POWER OUTPUT (dBm) | | TOTAL PEAK POWER (mW) | TOTAL PEAK POWER (dBm) | PEAK POWER LIMIT (dBm) | PASS / FAIL |
|-------|-------------------|-------------------------|---------|-----------------------|------------------------|------------------------|-------------|
| | | CHAIN 0 | CHAIN 1 | | | | |
| 1 | 2412 | 22.53 | 22.54 | 358.534 | 25.55 | 30 | PASS |
| 6 | 2437 | 22.51 | 21.43 | 317.233 | 25.01 | 30 | PASS |
| 11 | 2462 | 22.75 | 22.47 | 364.969 | 25.62 | 30 | PASS |



A D T

DRAFT 802.11n (20MHz) OFDM MODULATION

| | | | |
|------------------------|--------------|---------------------------------|---------------------------|
| MODULATION TYPE | BPSK | TRANSFER RATE | 7.2Mbps |
| INPUT POWER | 120Vac, 60Hz | ENVIRONMENTAL CONDITIONS | 23 deg.C, 70 %RH, 1009hPa |
| TESTED BY | Lori Chiu | | |

| CHAN. | CHAN. FREQ. (MHz) | PEAK POWER OUTPUT (dBm) | | TOTAL PEAK POWER (mW) | TOTAL PEAK POWER (dBm) | PEAK POWER LIMIT (dBm) | PASS / FAIL |
|-------|-------------------|-------------------------|---------|-----------------------|------------------------|------------------------|-------------|
| | | CHAIN 0 | CHAIN 1 | | | | |
| 1 | 2412 | 22.04 | 21.81 | 311.661 | 24.94 | 30 | PASS |
| 6 | 2437 | 22.56 | 22.03 | 339.890 | 25.31 | 30 | PASS |
| 11 | 2462 | 22.55 | 22.07 | 340.952 | 25.33 | 30 | PASS |

DRAFT 802.11n (40MHz) OFDM MODULATION

| | | | |
|------------------------|--------------|---------------------------------|---------------------------|
| MODULATION TYPE | BPSK | TRANSFER RATE | 15.0Mbps |
| INPUT POWER | 120Vac, 60Hz | ENVIRONMENTAL CONDITIONS | 23 deg.C, 70 %RH, 1009hPa |
| TESTED BY | Lori Chiu | | |

| CHAN. | CHAN. FREQ. (MHz) | PEAK POWER OUTPUT (dBm) | | TOTAL PEAK POWER (mW) | TOTAL PEAK POWER (dBm) | PEAK POWER LIMIT (dBm) | PASS / FAIL |
|-------|-------------------|-------------------------|---------|-----------------------|------------------------|------------------------|-------------|
| | | CHAIN 0 | CHAIN 1 | | | | |
| 1 | 2422 | 22.44 | 21.82 | 327.443 | 25.15 | 30 | PASS |
| 4 | 2437 | 23.05 | 22.67 | 386.763 | 25.87 | 30 | PASS |
| 7 | 2452 | 22.46 | 22.11 | 338.752 | 25.30 | 30 | PASS |

4.5 POWER SPECTRAL DENSITY MEASUREMENT

4.5.1 LIMITS OF POWER SPECTRAL DENSITY MEASUREMENT

The Maximum of Power Spectral Density Measurement is 8dBm.

4.5.2 TEST INSTRUMENTS

| DESCRIPTION & MANUFACTURER | MODEL NO. | SERIAL NO. | DATE OF CALIBRATION | DUE DATE OF CALIBRATION |
|----------------------------|-----------|------------|---------------------|-------------------------|
| R&S SPECTRUM ANALYZER | FSP40 | 100040 | Jul. 04, 2008 | Jul. 03, 2009 |

NOTE: The calibration interval of the above test instruments is 12 months and the calibrations are traceable to NML/ROC and NIST/USA.

4.5.3 TEST PROCEDURE

The transmitter output was connected to the spectrum analyzer through an attenuator, the bandwidth of the fundamental frequency was measured with the spectrum analyzer using 3kHz RBW and 30kHz VBW, set sweep time = span/3kHz. The power spectral density was measured and recorded.

The sweep time is allowed to be longer than span/3kHz for a full response of the mixer in the spectrum analyzer.

4.5.4 DEVIATION FROM TEST STANDARD

No deviation.

4.5.5 TEST SETUP

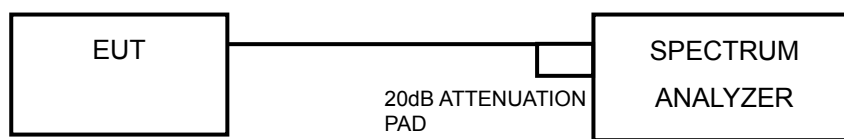

4.5.6 EUT OPERATING CONDITION

Same as Item 4.3.6



A D T

4.5.7 TEST RESULTS

802.11b DSSS MODULATION

| | | | |
|------------------------|--------------|---------------------------------|---------------------------|
| MODULATION TYPE | DBPSK | TRANSFER RATE | 1.0Mbps |
| INPUT POWER | 120Vac, 60Hz | ENVIRONMENTAL CONDITIONS | 23 deg.C, 70 %RH, 1009hPa |
| TESTED BY | Lori Chiu | | |

| CHAN. | CHAN. FREQ. (MHz) | RF POWER LEVEL IN 3kHz BW (dBm) | | TOTAL POWER DENSITY (mW) | TOTAL POWER DENSITY (dBm) | MAX. LIMIT (dBm) | PASS / FAIL |
|-------|-------------------|---------------------------------|---------|--------------------------|---------------------------|------------------|-------------|
| | | CHAIN 0 | CHAIN 1 | | | | |
| 1 | 2412 | -11.29 | -11.38 | 0.147 | -8.32 | 8 | PASS |
| 6 | 2437 | -11.27 | -12.47 | 0.131 | -8.82 | 8 | PASS |
| 11 | 2462 | -11.69 | -11.95 | 0.132 | -8.81 | 8 | PASS |



A D T

FOR CHAIN 0: CH 1

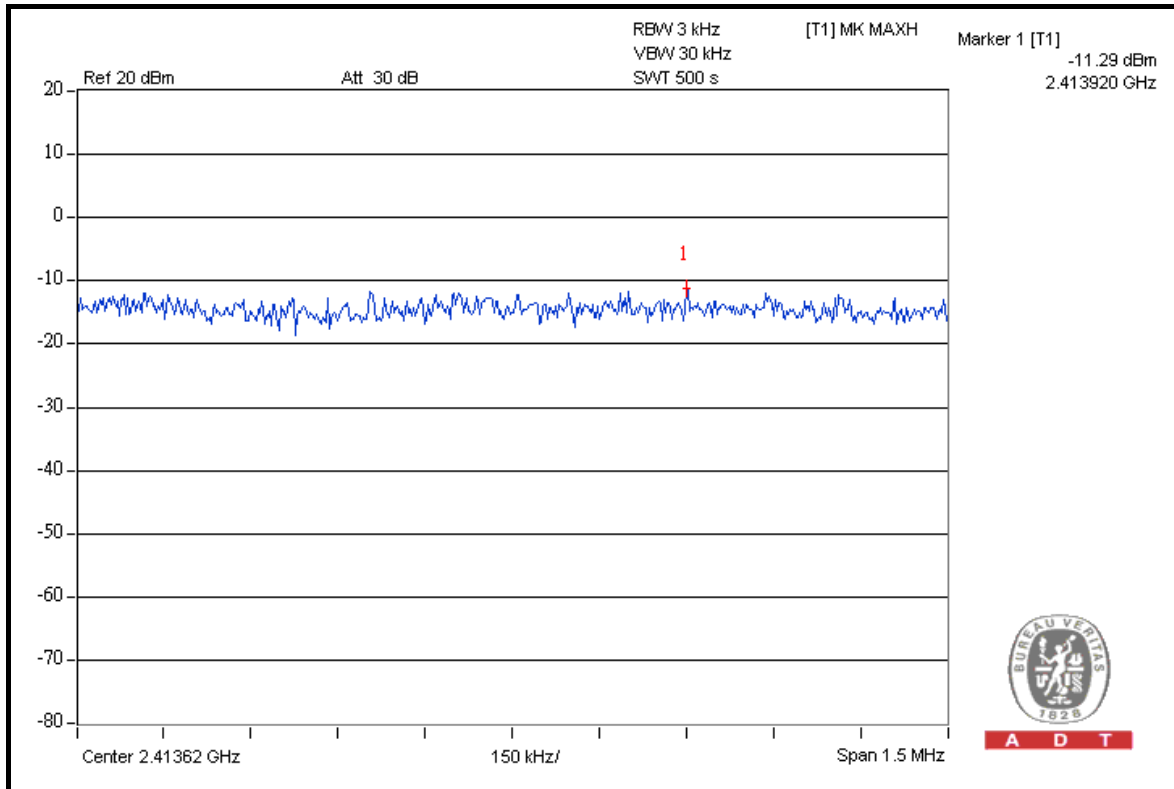

CH 6

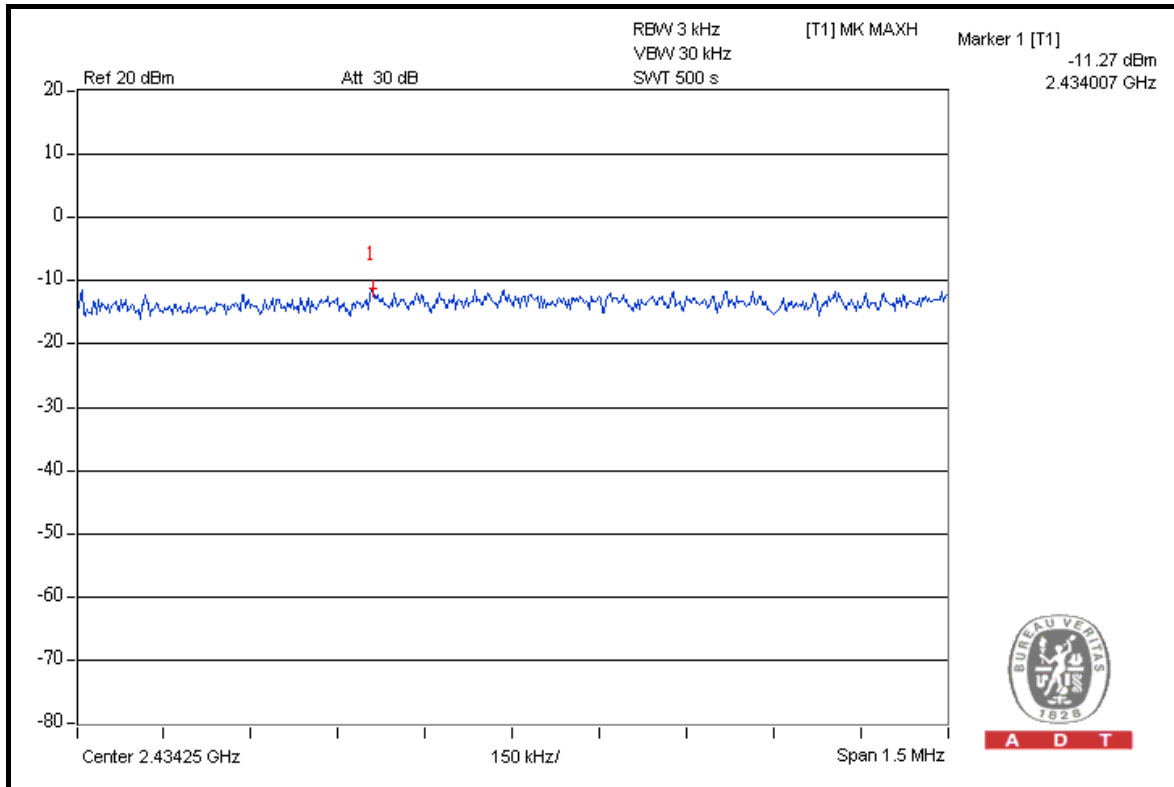



A D T

CH 11

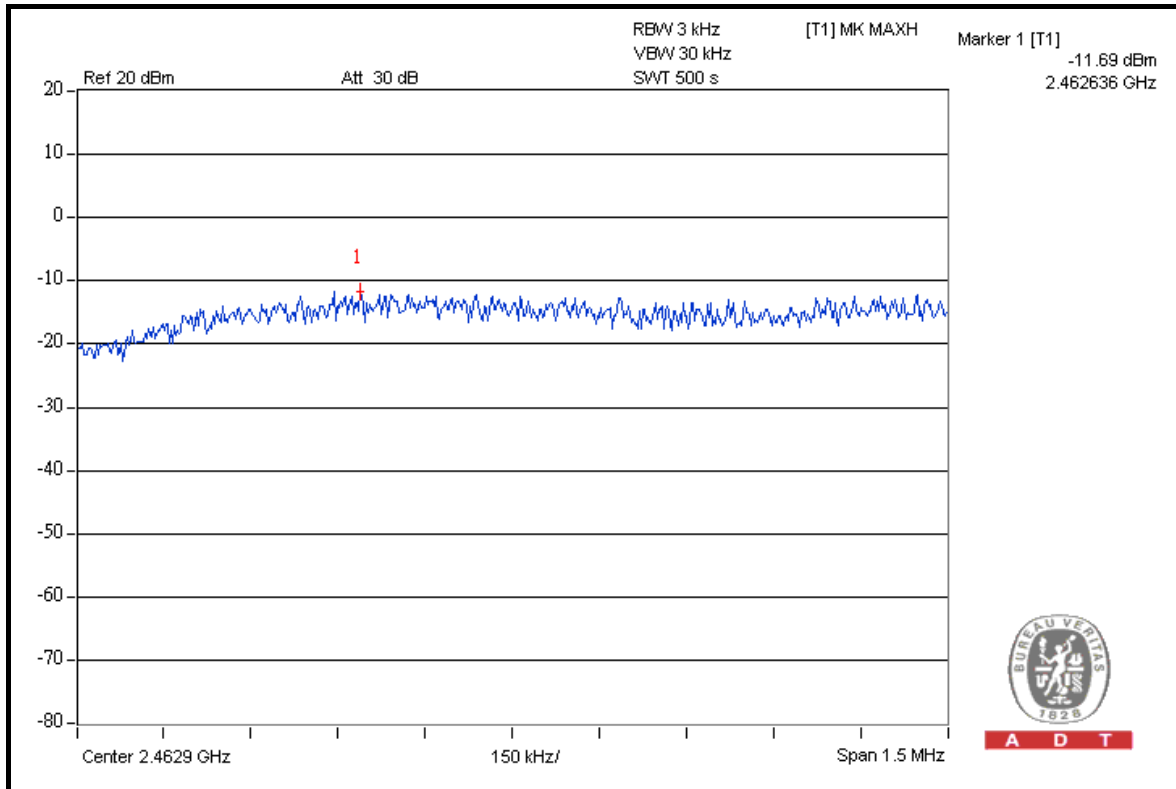

FOR CHAIN 1: CH 1

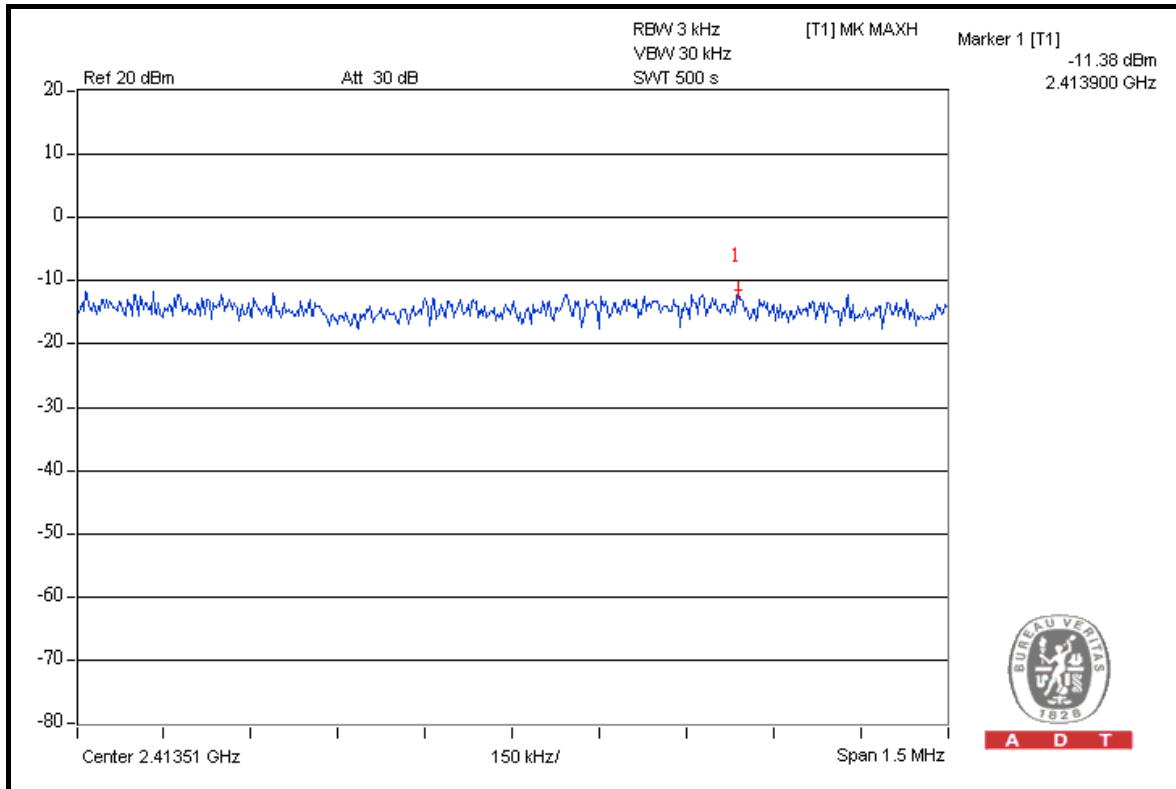



A D T

CH 6

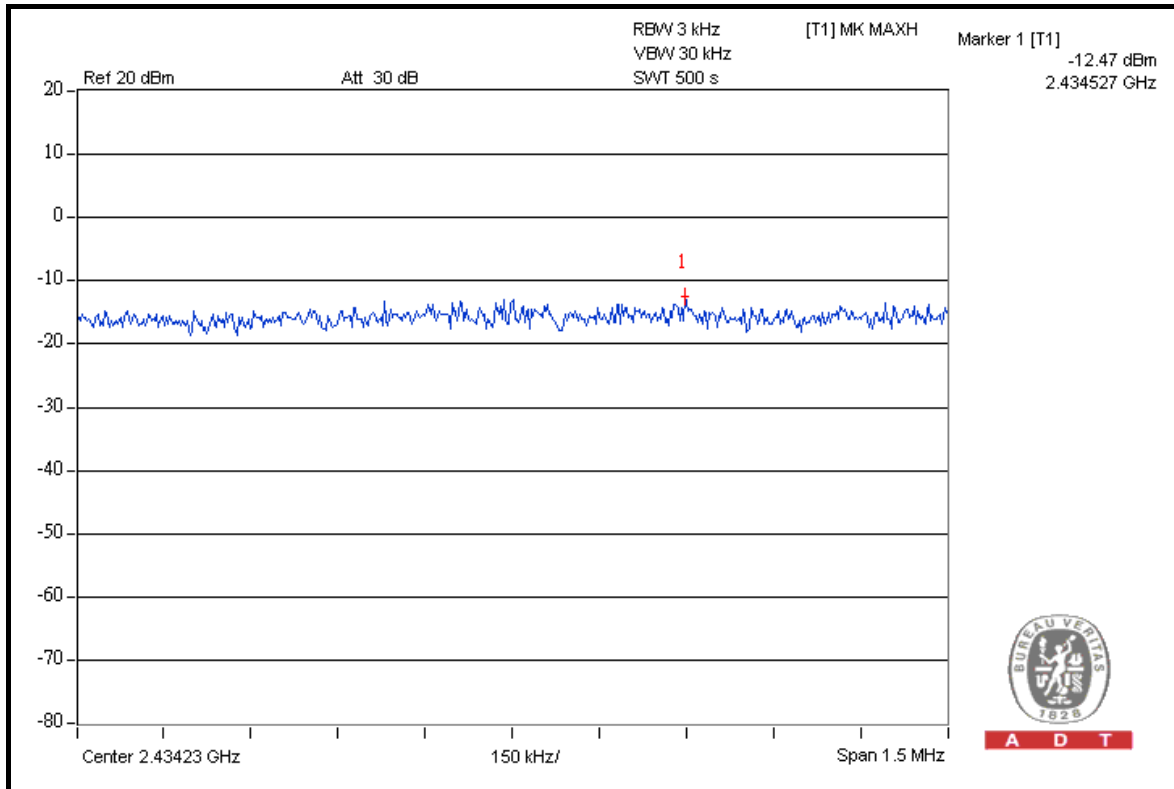

CH 11

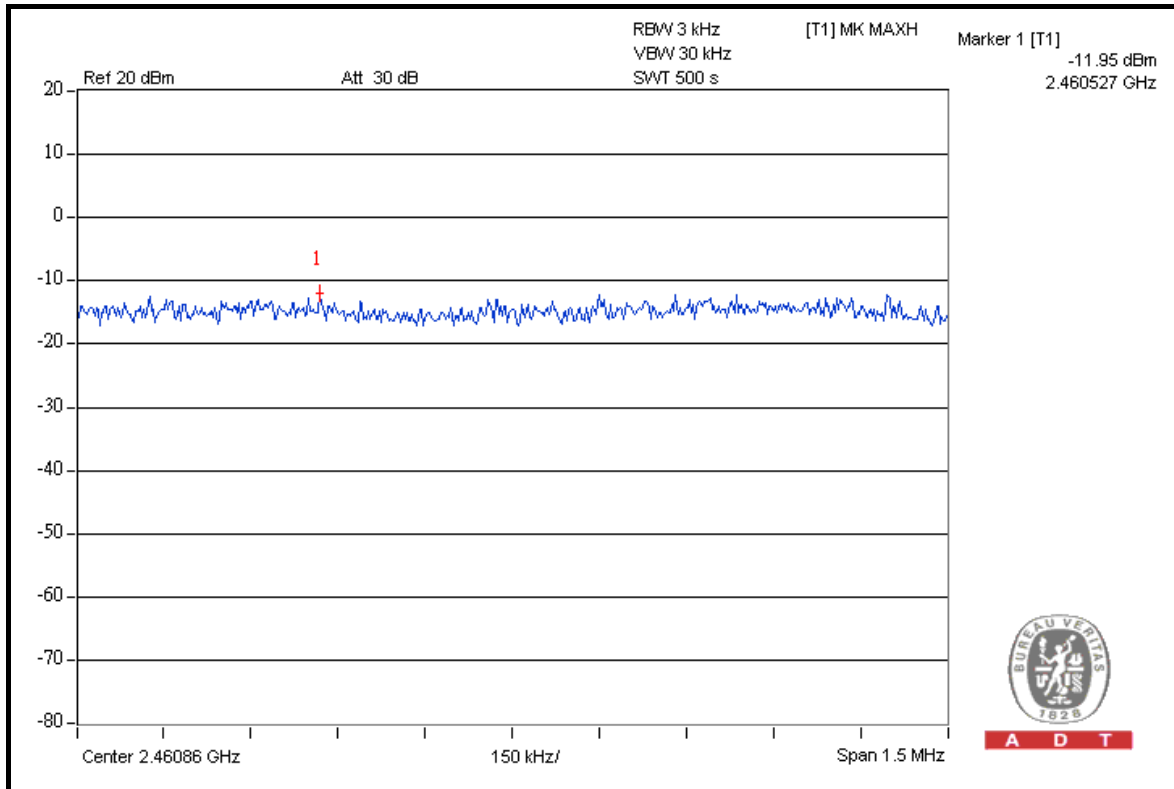



A D T

802.11g OFDM MODULATION

| | | | |
|------------------------|--------------|---------------------------------|---------------------------|
| MODULATION TYPE | BPSK | TRANSFER RATE | 6.0Mbps |
| INPUT POWER | 120Vac, 60Hz | ENVIRONMENTAL CONDITIONS | 23 deg.C, 70 %RH, 1009hPa |
| TESTED BY | Lori Chiu | | |

| CHAN. | CHAN. FREQ. (MHz) | RF POWER LEVEL IN 3kHz BW (dBm) | | TOTAL POWER DENSITY (mW) | TOTAL POWER DENSITY (dBm) | MAX. LIMIT (dBm) | PASS / FAIL |
|-------|-------------------|---------------------------------|---------|--------------------------|---------------------------|------------------|-------------|
| | | CHAIN 0 | CHAIN 1 | | | | |
| 1 | 2412 | -11.65 | -12.11 | 0.130 | -8.86 | 8 | PASS |
| 6 | 2437 | -11.66 | -13.02 | 0.118 | -9.28 | 8 | PASS |
| 11 | 2462 | -11.30 | -12.09 | 0.136 | -8.67 | 8 | PASS |



A D T

FOR CHAIN 0: CH 1

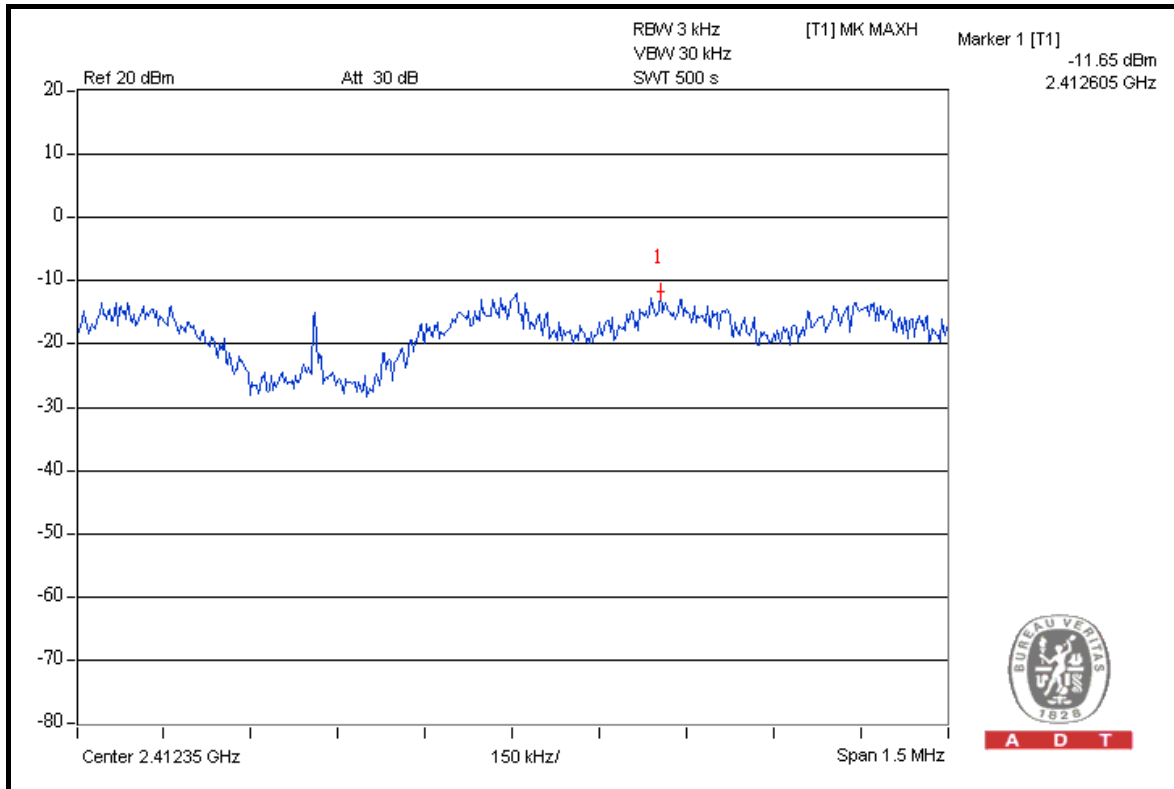

CH 6

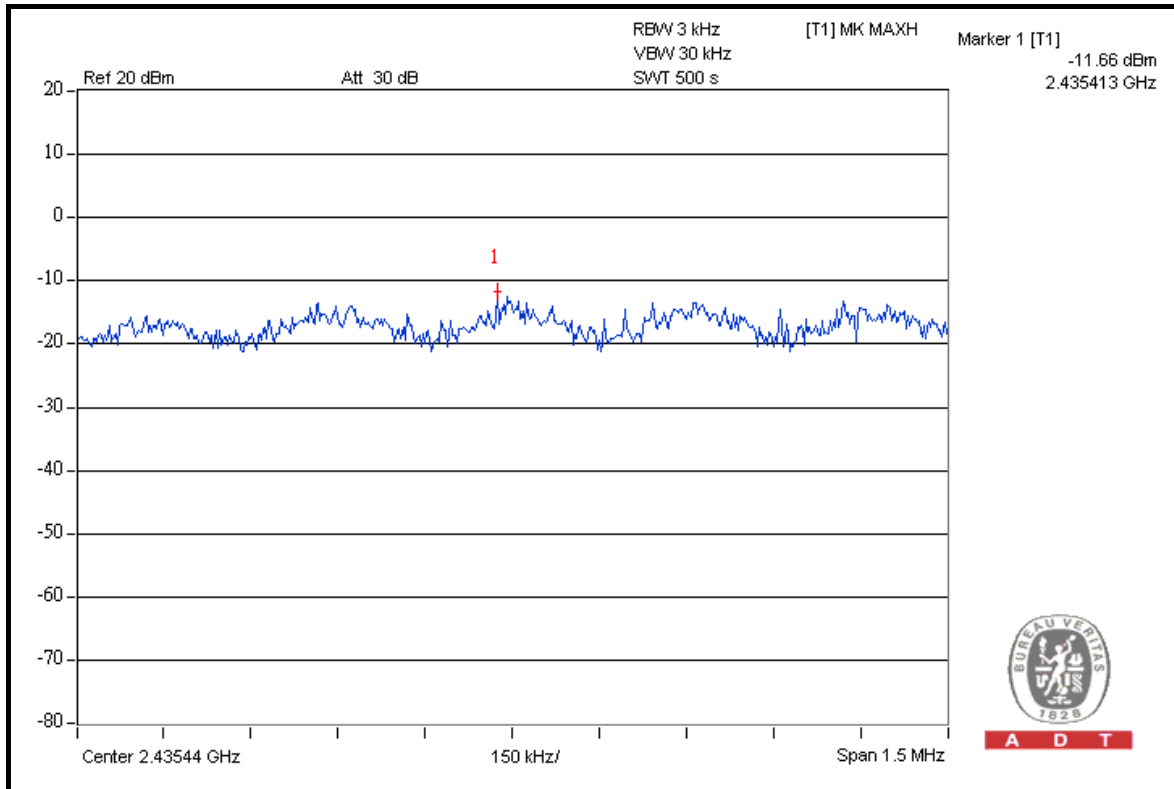



A D T

CH 11

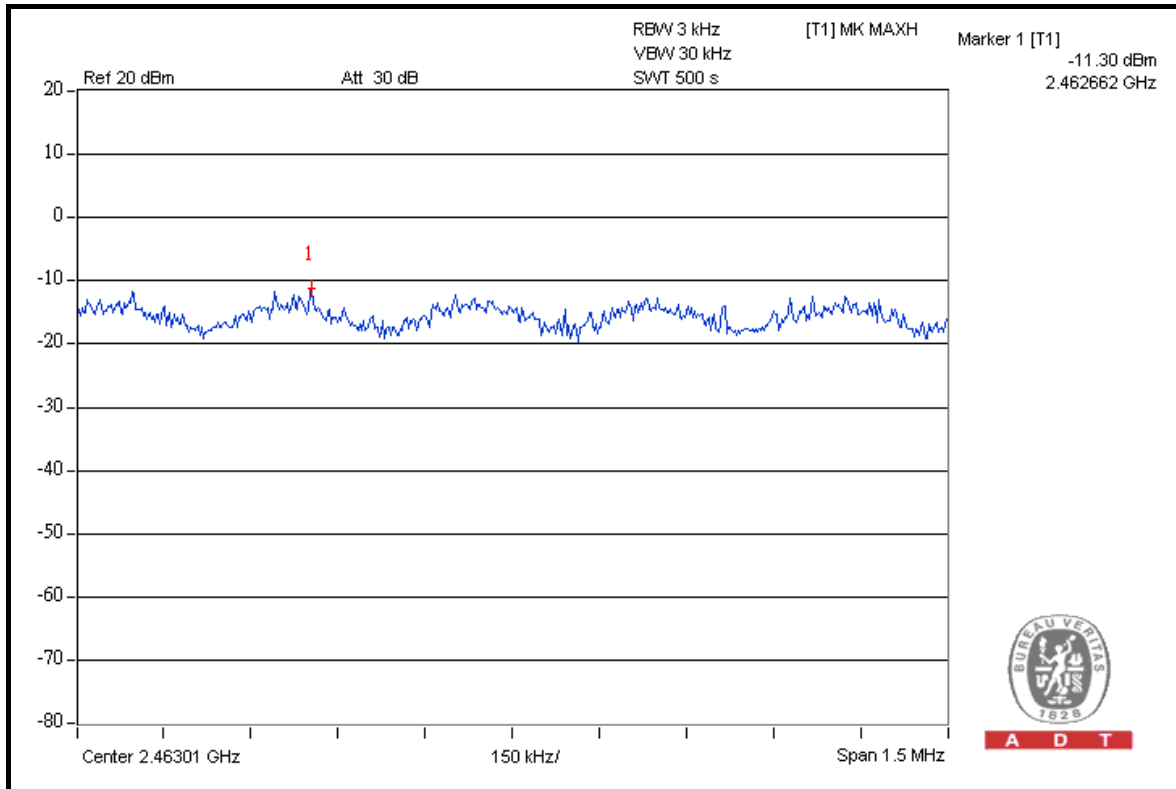

FOR CHAIN 1: CH 1

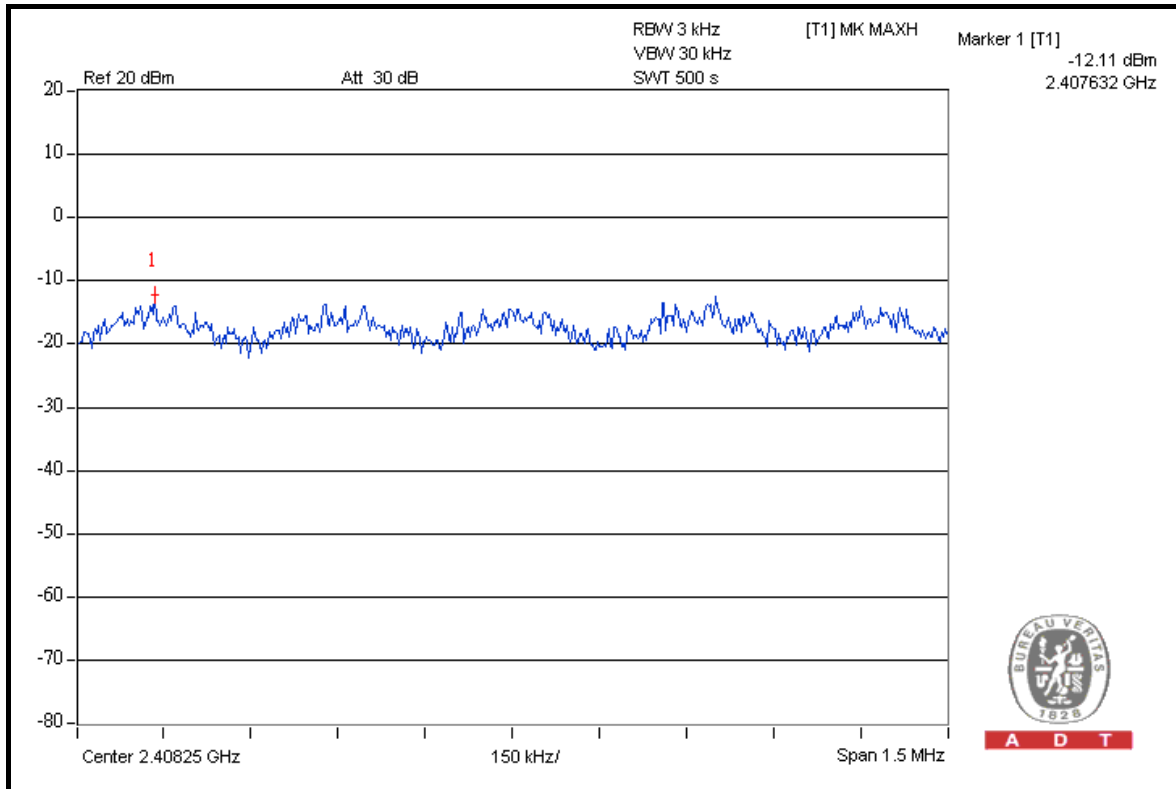



A D T

CH 6

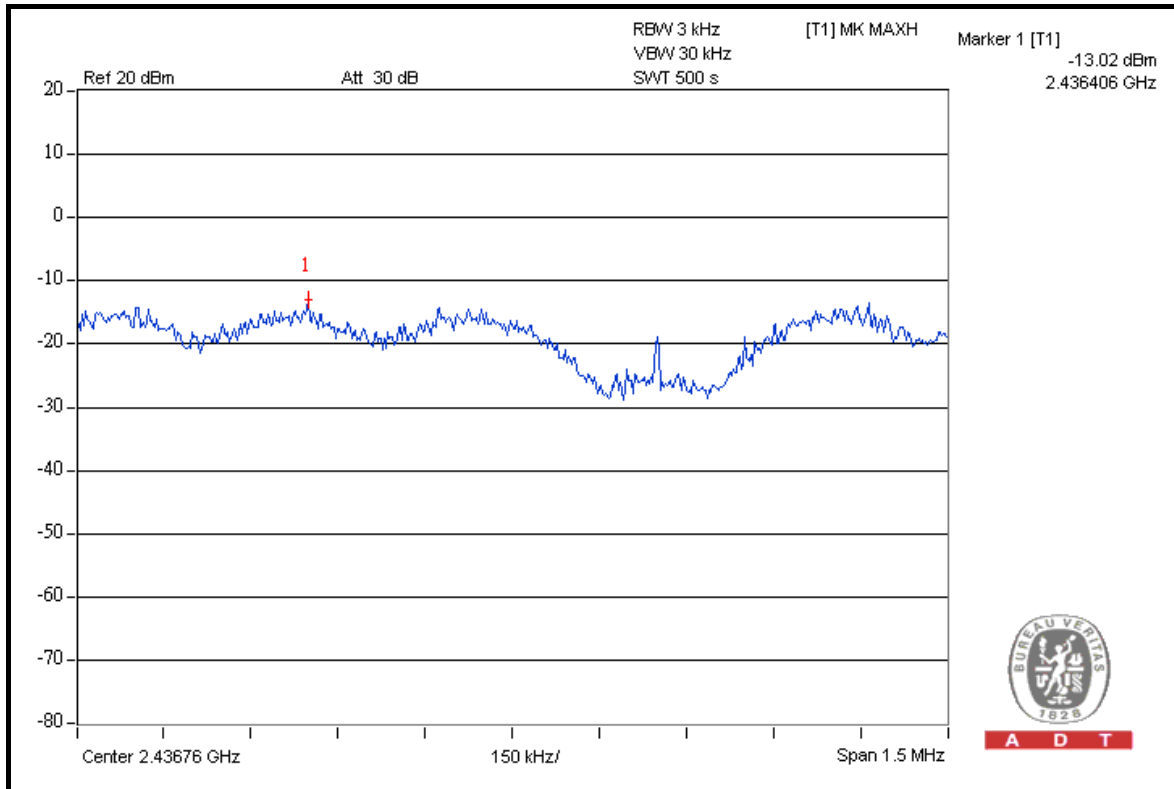

A D T

CH 11

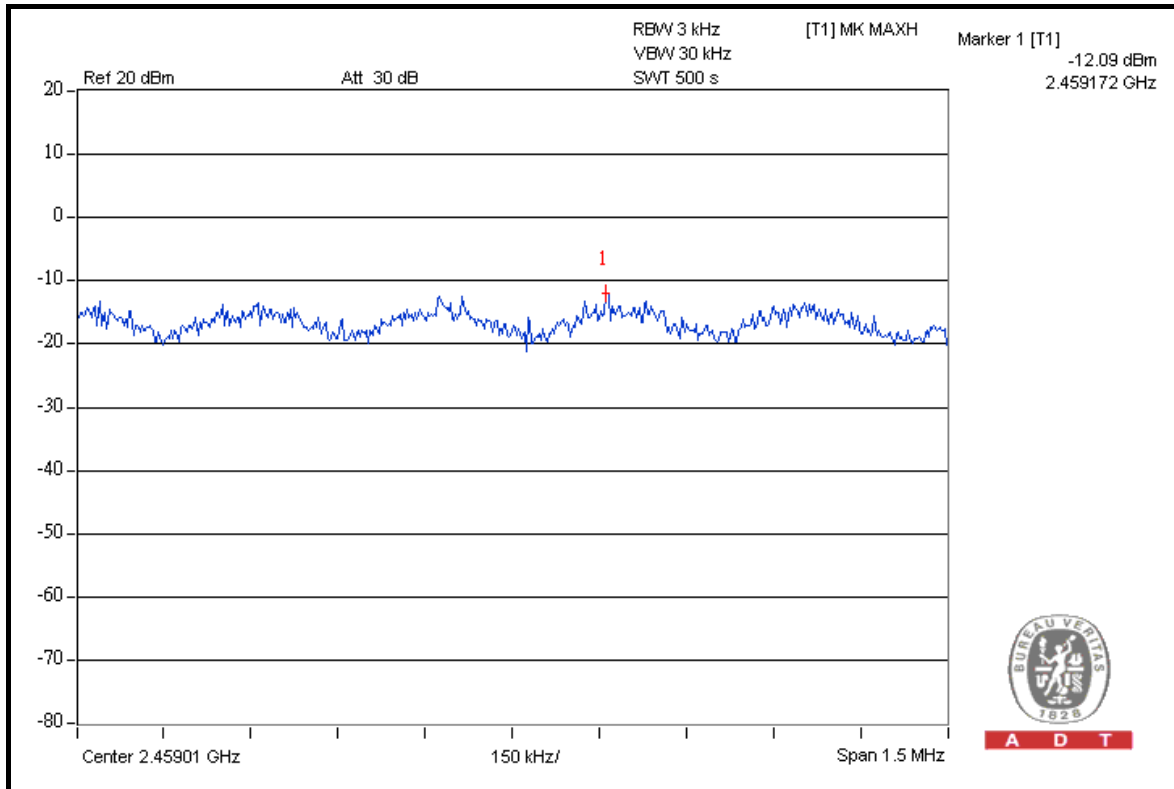

A D T



A D T

DRAFT 802.11n (20MHz) OFDM MODULATION

| | | | |
|------------------------|--------------|---------------------------------|---------------------------|
| MODULATION TYPE | BPSK | TRANSFER RATE | 7.2Mbps |
| INPUT POWER | 120Vac, 60Hz | ENVIRONMENTAL CONDITIONS | 23 deg.C, 70 %RH, 1009hPa |
| TESTED BY | Lori Chiu | | |

| CHAN. | CHAN. FREQ. (MHz) | RF POWER LEVEL IN 3kHz BW (dBm) | | TOTAL POWER DENSITY (mW) | TOTAL POWER DENSITY (dBm) | MAX. LIMIT (dBm) | PASS / FAIL |
|-------|-------------------|---------------------------------|---------|--------------------------|---------------------------|------------------|-------------|
| | | CHAIN 0 | CHAIN 1 | | | | |
| 1 | 2412 | -8.50 | -12.97 | 0.192 | -7.17 | 8 | PASS |
| 6 | 2437 | -7.91 | -12.93 | 0.213 | -6.72 | 8 | PASS |
| 11 | 2462 | -8.09 | -12.70 | 0.209 | -6.80 | 8 | PASS |



A D T

FOR CHAIN 0: CH 1

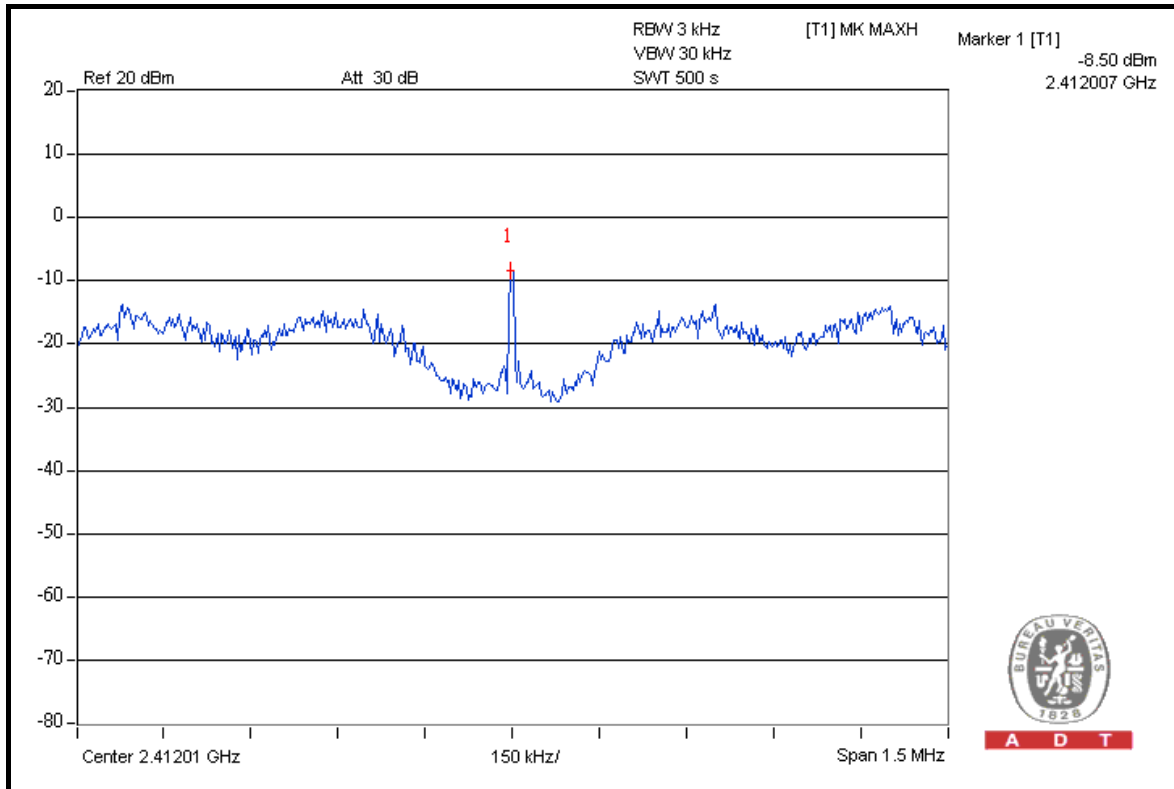

CH 6

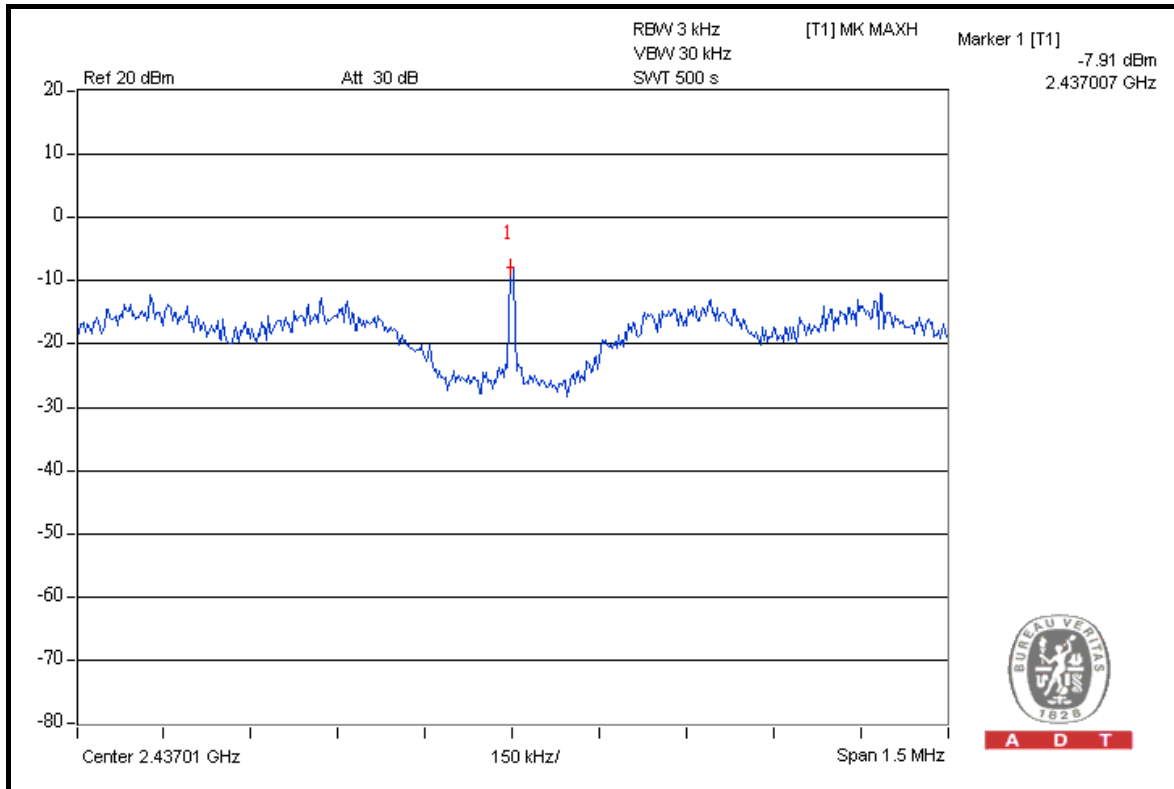



A D T

CH 11

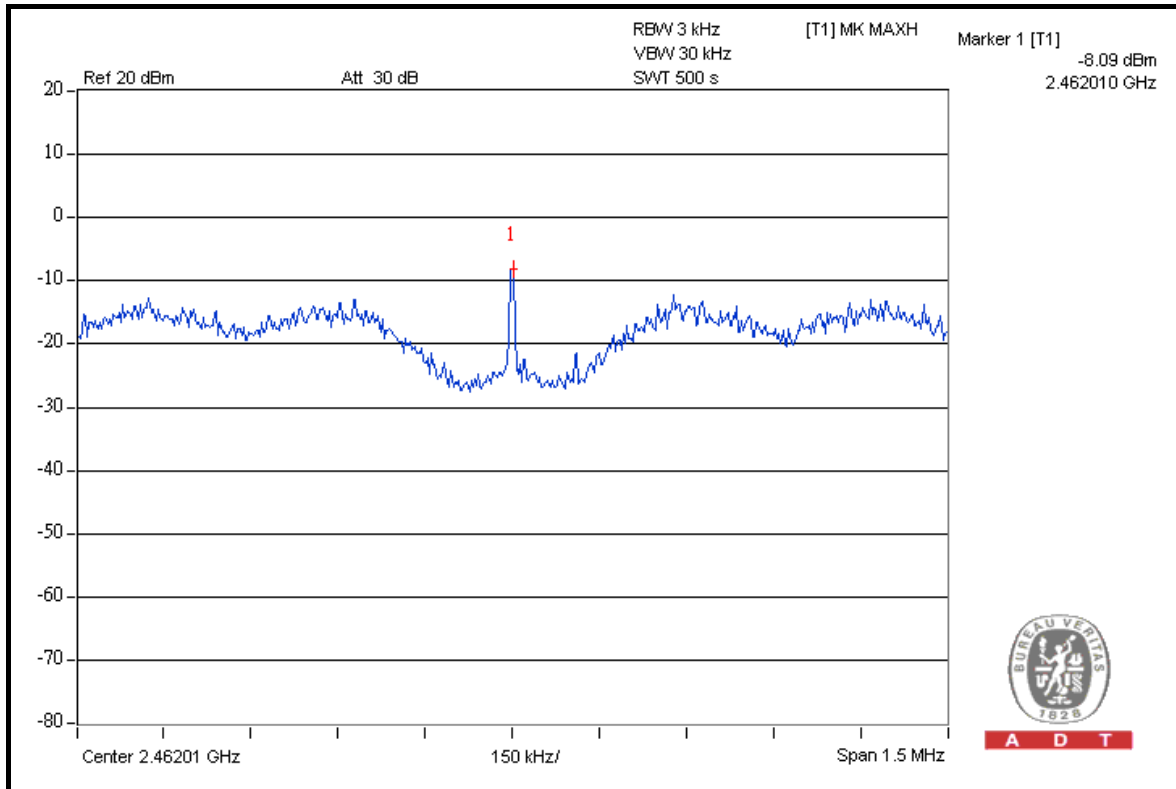

FOR CHAIN 1: CH 1

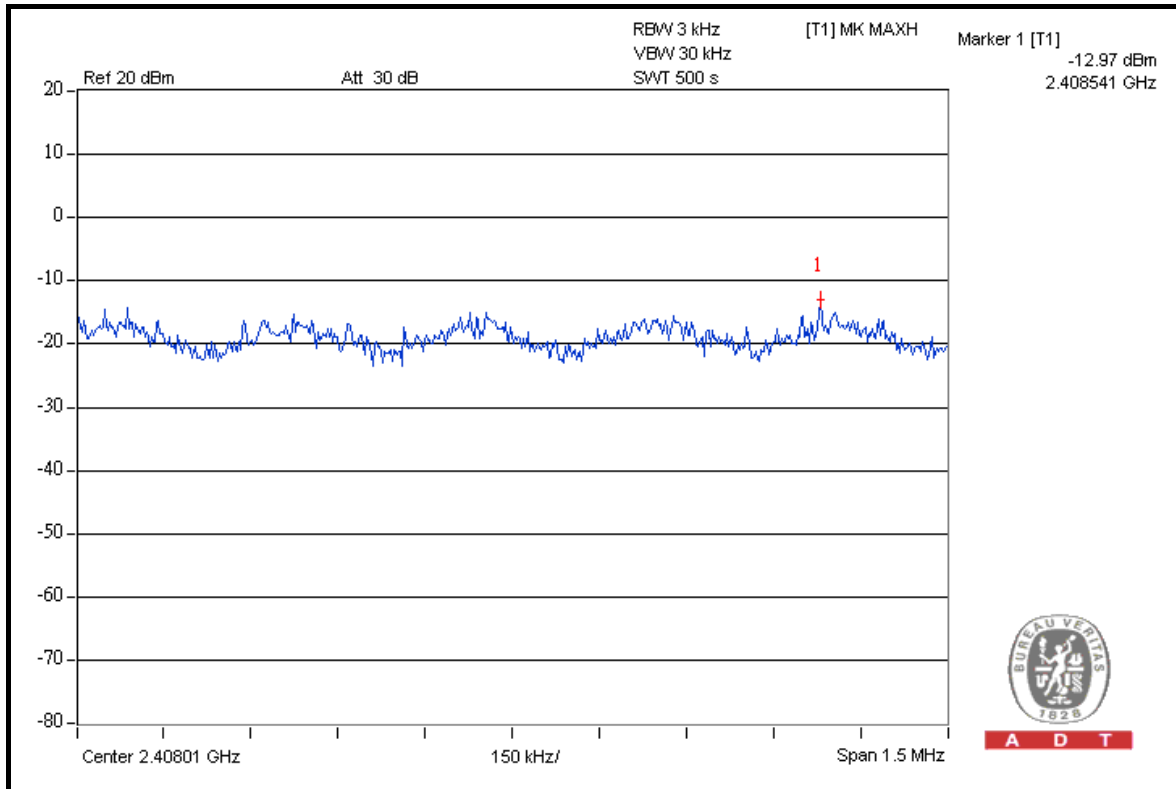



A D T

CH 6

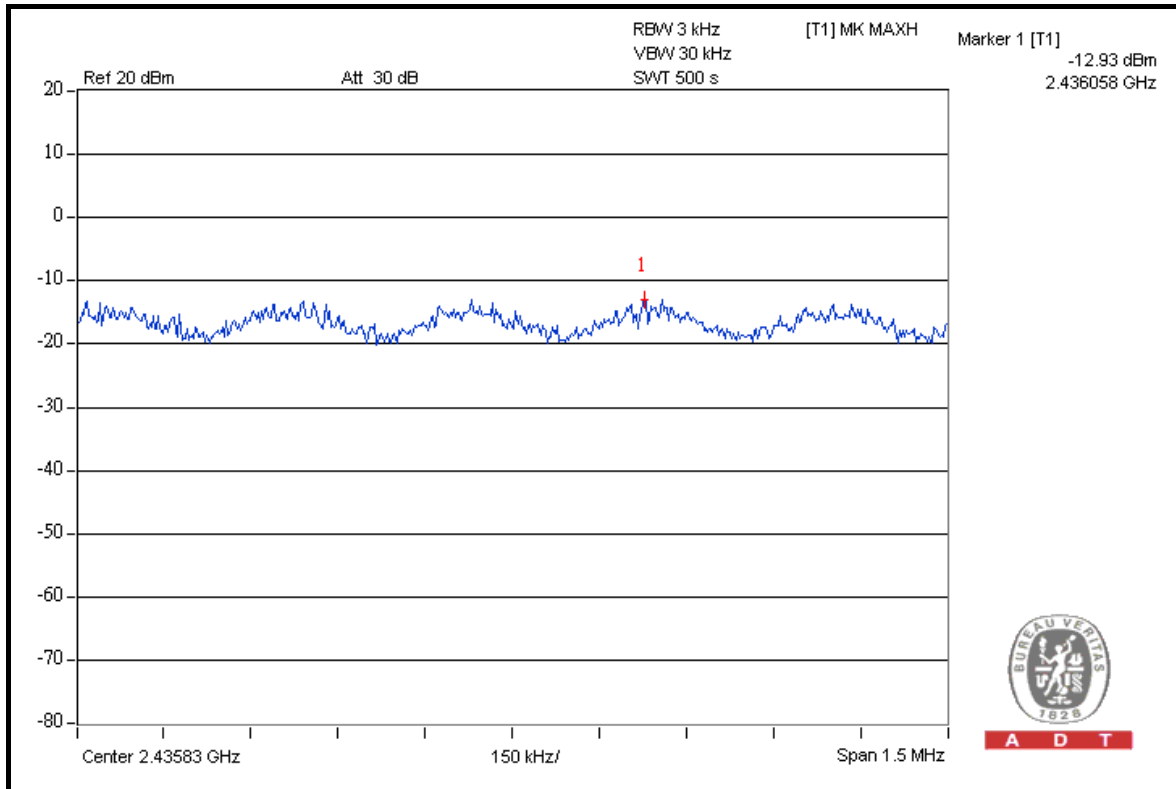

CH 11

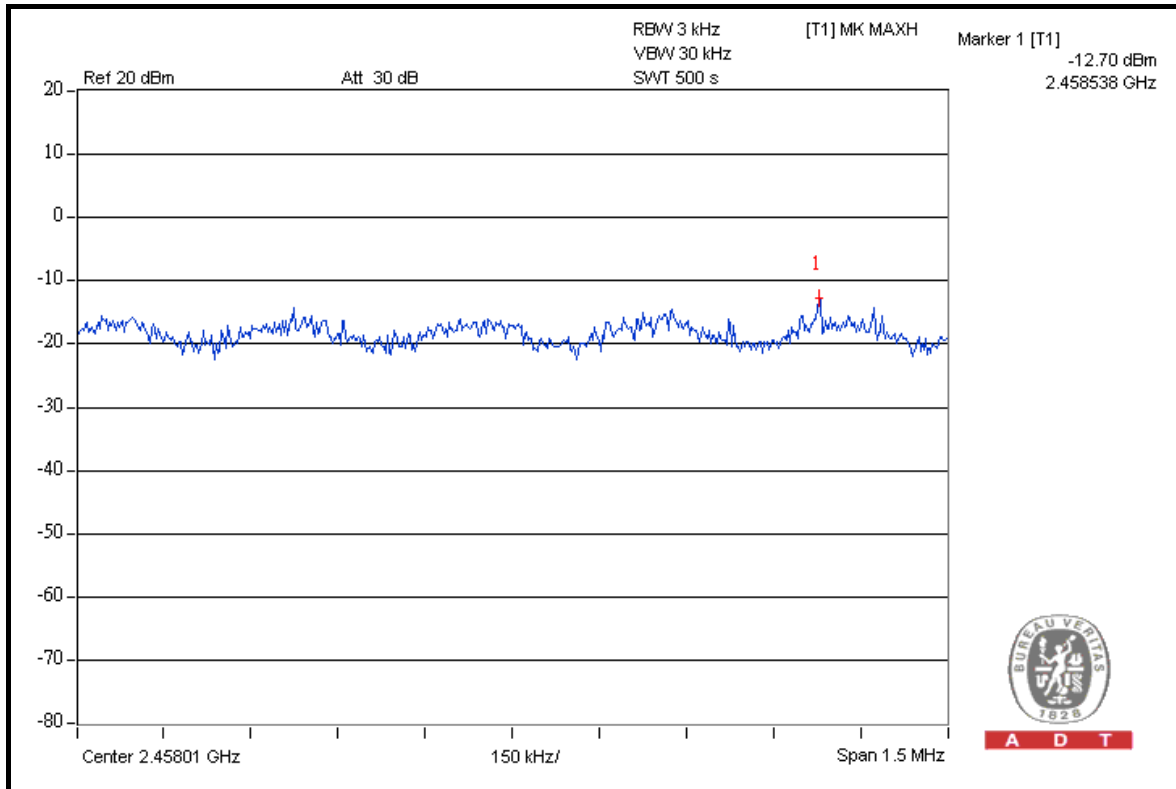



A D T

DRAFT 802.11n (40MHz) OFDM MODULATION

| | | | |
|------------------------|--------------|---------------------------------|---------------------------|
| MODULATION TYPE | BPSK | TRANSFER RATE | 15.0Mbps |
| INPUT POWER | 120Vac, 60Hz | ENVIRONMENTAL CONDITIONS | 23 deg.C, 70 %RH, 1009hPa |
| TESTED BY | Lori Chiu | | |

| CHAN. | CHAN. FREQ. (MHz) | RF POWER LEVEL IN 3kHz BW (dBm) | | TOTAL POWER DENSITY (mW) | TOTAL POWER DENSITY (dBm) | MAX. LIMIT (dBm) | PASS / FAIL |
|-------|-------------------|---------------------------------|---------|--------------------------|---------------------------|------------------|-------------|
| | | CHAIN 0 | CHAIN 1 | | | | |
| 1 | 2422 | -17.94 | -20.04 | 0.026 | -15.85 | 8 | PASS |
| 4 | 2437 | -17.22 | -19.09 | 0.031 | -15.04 | 8 | PASS |
| 7 | 2452 | -18.09 | -19.51 | 0.027 | -15.73 | 8 | PASS |



A D T

FOR CHAIN 0: CH 1

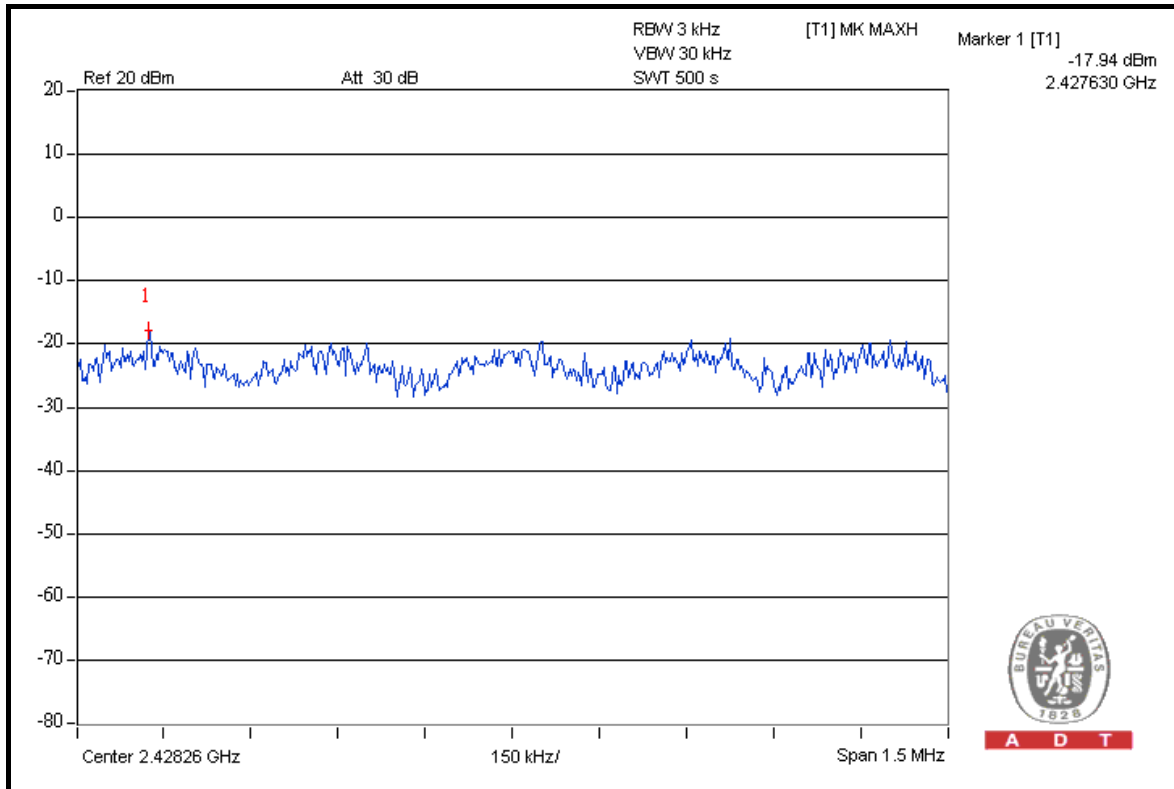

CH 4

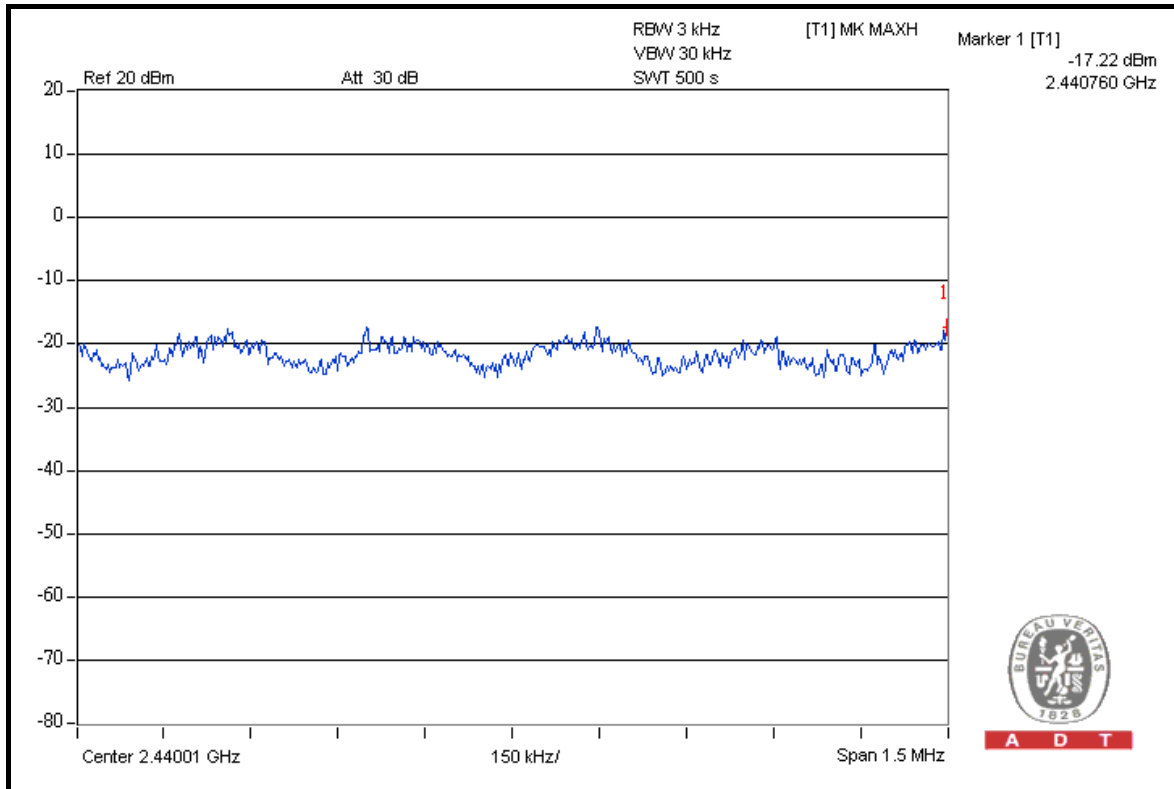



A D T

CH 7

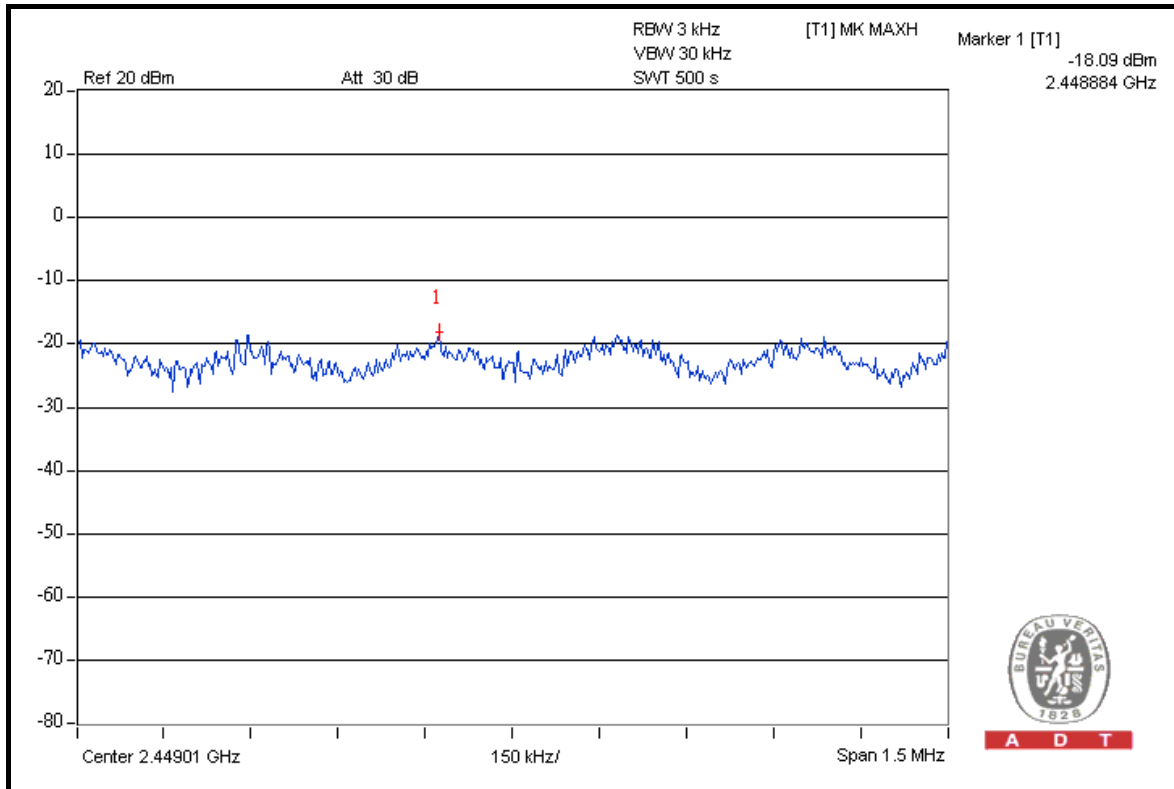

FOR CHAIN 1: CH 1

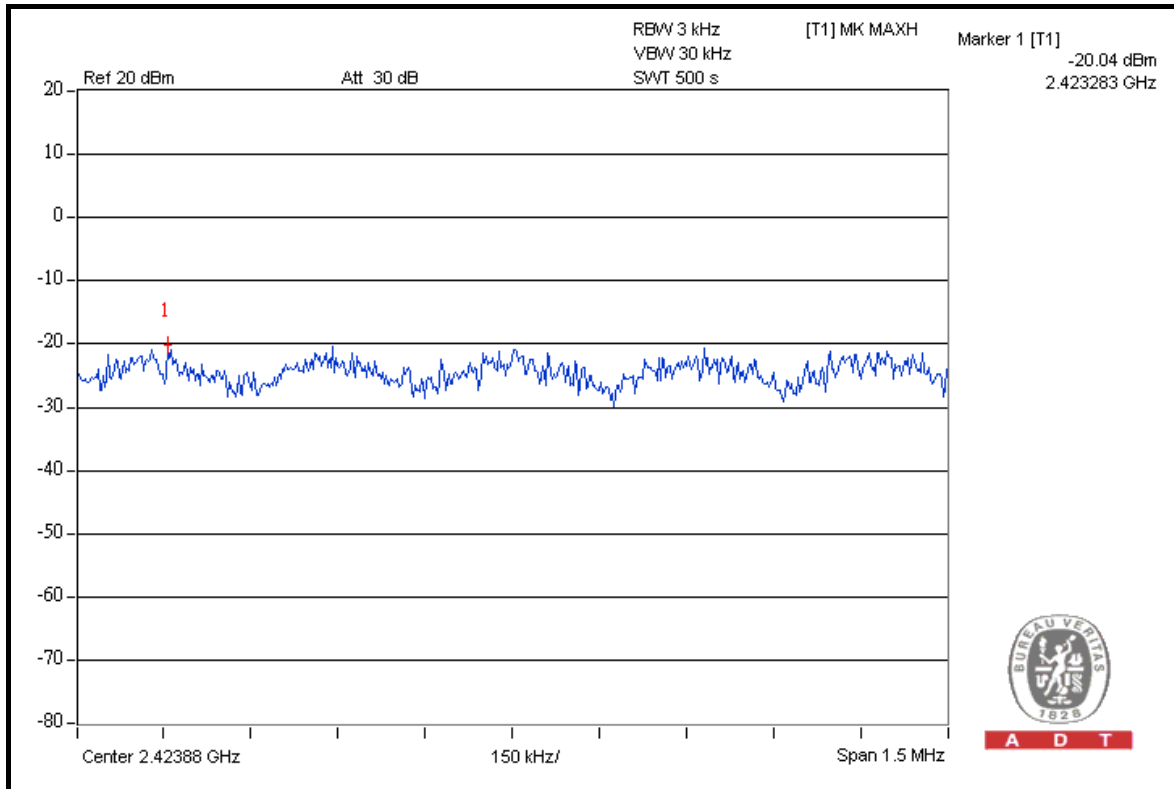



A D T

CH 4

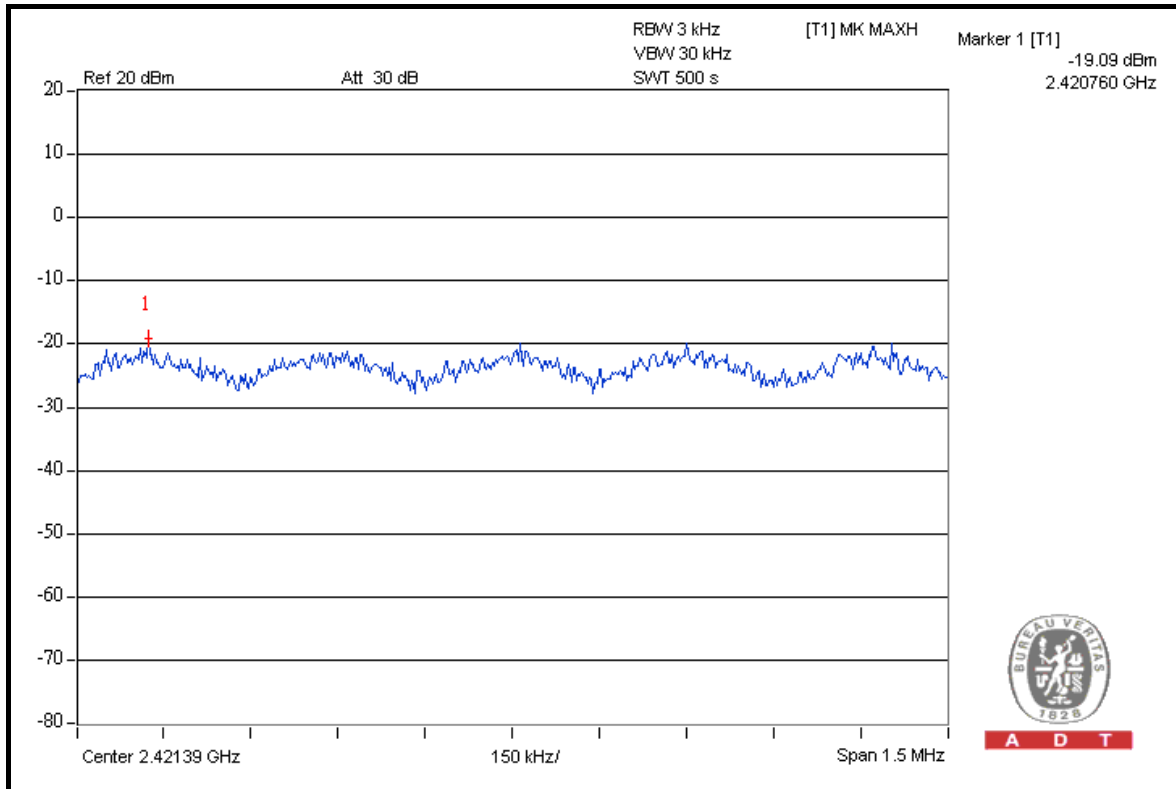

CH 7

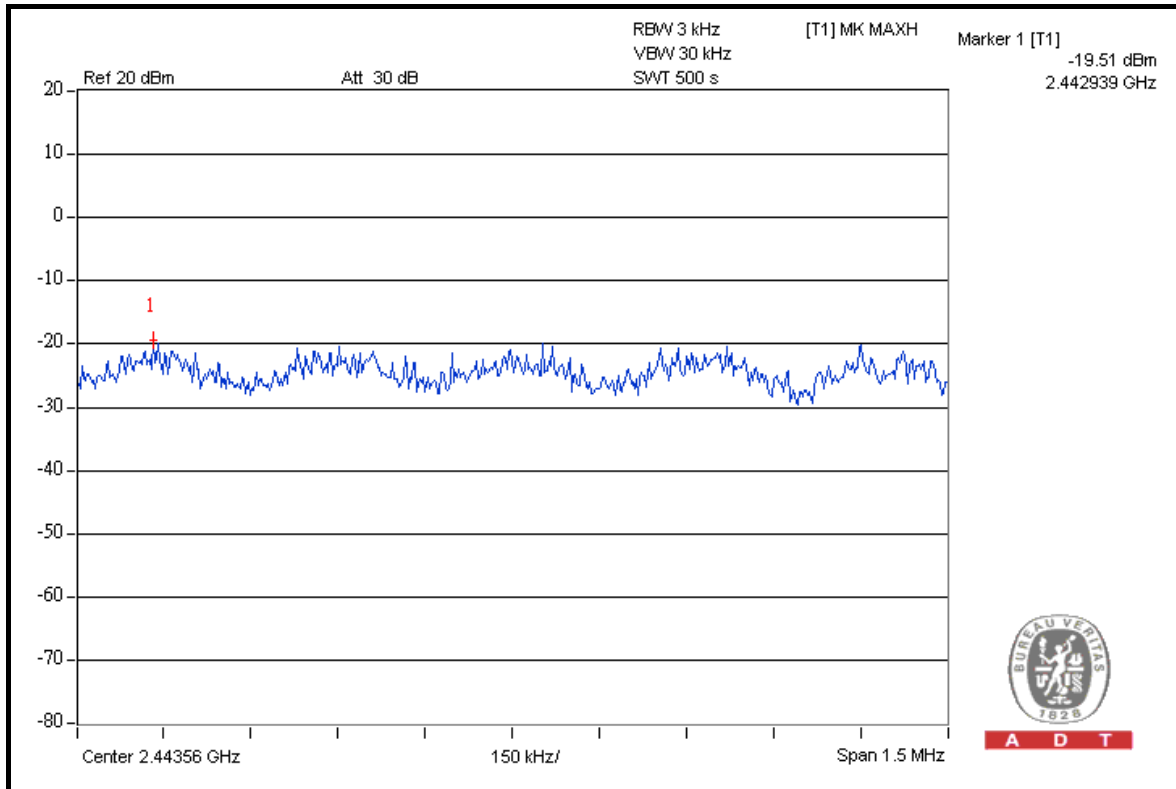

4.6 BAND EDGES MEASUREMENT

4.6.1 LIMITS OF BAND EDGES MEASUREMENT

Below -20dB of the highest emission level of operating band (in 100kHz Resolution Bandwidth).

4.6.2 TEST INSTRUMENTS

| DESCRIPTION & MANUFACTURER | MODEL NO. | SERIAL NO. | DATE OF CALIBRATION | DUE DATE OF CALIBRATION |
|--|------------------------------|-------------|---------------------|-------------------------|
| Test Receiver ROHDE & SCHWARZ | ESI7 | 838496/016 | Dec. 29, 2008 | Dec. 28, 2009 |
| Spectrum Analyzer ROHDE & SCHWARZ | FSP40 | 100039 | Dec. 08, 2008 | Dec. 07, 2009 |
| BILOG Antenna SCHWARZBECK | VULB9168 | 9168-155 | Apr. 30, 2008 | Apr. 28, 2010 |
| HORN Antenna SCHWARZBECK | BBHA 9120D | 9120D-408 | Dec. 29, 2008 | Dec. 28, 2009 |
| HORN Antenna SCHWARZBECK | BBHA 9170 | BBHA9170242 | Jan. 06, 2009 | Jan. 05, 2010 |
| Preamplifier Agilent | 8449B | 3008A01960 | Nov. 03, 2008 | Nov. 02, 2009 |
| Preamplifier Agilent | 8447D | 2944A10631 | Nov. 03, 2008 | Nov. 02, 2009 |
| RF signal cable HUBER+SUHNNER | SUCOFLEX 104 | 274041/4 | Aug. 21, 2008 | Aug. 20, 2009 |
| RF signal cable HUBER+SUHNNER | SUCOFLEX 104 | 283397/4 | Aug. 21, 2008 | Aug. 20, 2009 |
| Software ADT. | ADT_Radiated_ V7.6.15.9.2 | NA | NA | NA |
| Antenna Tower inn-co GmbH | MA 4000 | 010303 | NA | NA |
| Antenna Tower Controller inn-co GmbH | CO2000 | 019303 | NA | NA |
| Turn Table ADT. | TT100. | TT93021704 | NA | NA |
| Turn Table Controller ADT. | SC100. | SC93021704 | NA | NA |

NOTE: The calibration interval of the above test instruments is 12 months and the calibrations are traceable to NML/ROC and NIST/USA.



A D T

4.6.3 TEST PROCEDURE

- a. The EUT was placed on the top of a rotating table 0.8 meters above the ground at a 3 meter semi-anechoic chamber. The table was rotated 360 degrees to determine the position of the highest radiation.
- b. The EUT was set 3 meters away from the interference-receiving antenna, which was mounted on the top of a variable-height antenna tower.
- c. The antenna is a broadband antenna, and its height is varied from one meter to four meters above the ground to determine the maximum value of the field strength. Both horizontal and vertical polarizations of the antenna are set to make the measurement.
- d. For each suspected emission, the EUT was arranged to its worst case and then the antenna was tuned to heights from 1 meter to 4 meters and the rotatable table was turned from 0 degrees to 360 degrees to find the maximum reading.
- e. Set both RBW and VBW of spectrum analyzer to 100kHz and 300kHz with suitable frequency span including 100MHz bandwidth from band edge. The band edges was measured and recorded.

The spectrum plots (Peak RBW = 100kHz, VBW = 300kHz) are attached on the following pages.

NOTE: The resolution bandwidth of test receiver/spectrum analyzer is 1MHz and the video bandwidth is 10Hz for Average detection (AV) at frequency above 1GHz.

4.6.4 DEVIATION FROM TEST STANDARD

No deviation.

4.6.5 EUT OPERATING CONDITION

Same as Item 4.3.6.

4.6.6 TEST RESULTS

The spectrum plots are attached on the following pages. D1 line indicates the highest level, and D2 line indicates the 20dB offset below D1. It shows compliance with the requirement in part 15.247(d).

802.11b DSSS MODULATION

NOTE 1: The band edge emission plot on the next page shows 55.75dBc between carrier maximum power and local maximum emission in restrict band (2.34980GHz). The emission of carrier strength list in the test result of channel 1 at the item 4.1.7 is 113.40dBuV/m (Peak), so the maximum field strength in restrict band is $113.40 - 55.75 = 57.65$ dBuV/m which is under 74dBuV/m limit.

The band edge emission plot of on the next page shows 63.93dBc between carrier maximum power and local maximum emission in restrict band (2.38920GHz). The emission of carrier strength list in the test result of channel 1 at the item 4.1.7 is 108.73dBuV/m (Average), so the maximum field strength in restrict band is $108.73 - 63.93 = 44.80$ dBuV/m which is under 54dBuV/m limit.

NOTE 2: The band edge emission plot on the next second page shows 55.79dBc between carrier maximum power and local maximum emission in restrict band (2.49880GHz). The emission of carrier strength list in the test result of channel 11 at the item 4.1.7 is 112.00dBuV/m (Peak), so the maximum field strength in restrict band is $112.00 - 55.79 = 56.21$ dBuV/m which is under 74dBuV/m limit.

The band edge emission plot on the next third page shows 64.23dBc between carrier maximum power and local maximum emission in restrict band (2.50000GHz). The emission of carrier strength list in the test result of channel 11 at the item 4.1.7 is 107.49dBuV/m (Average), so the maximum field strength in restrict band is $107.49 - 64.23 = 43.26$ dBuV/m which is under 54dBuV/m limit.



A D T

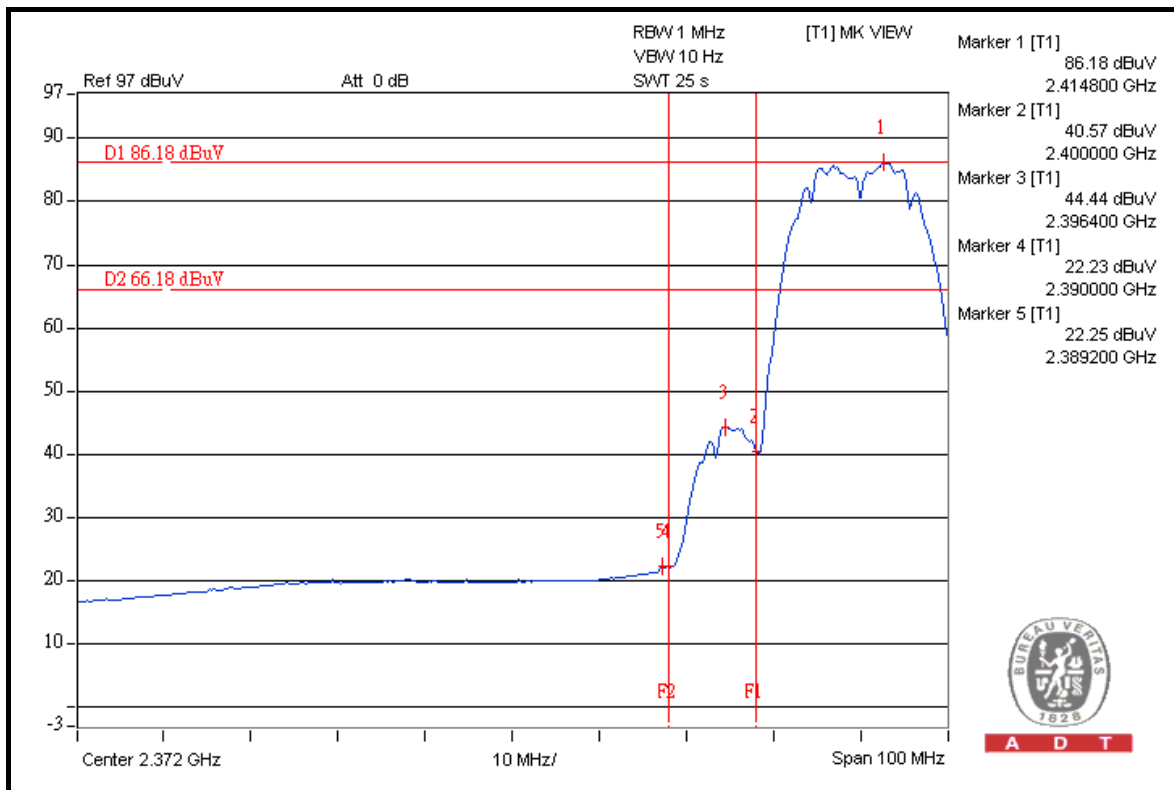
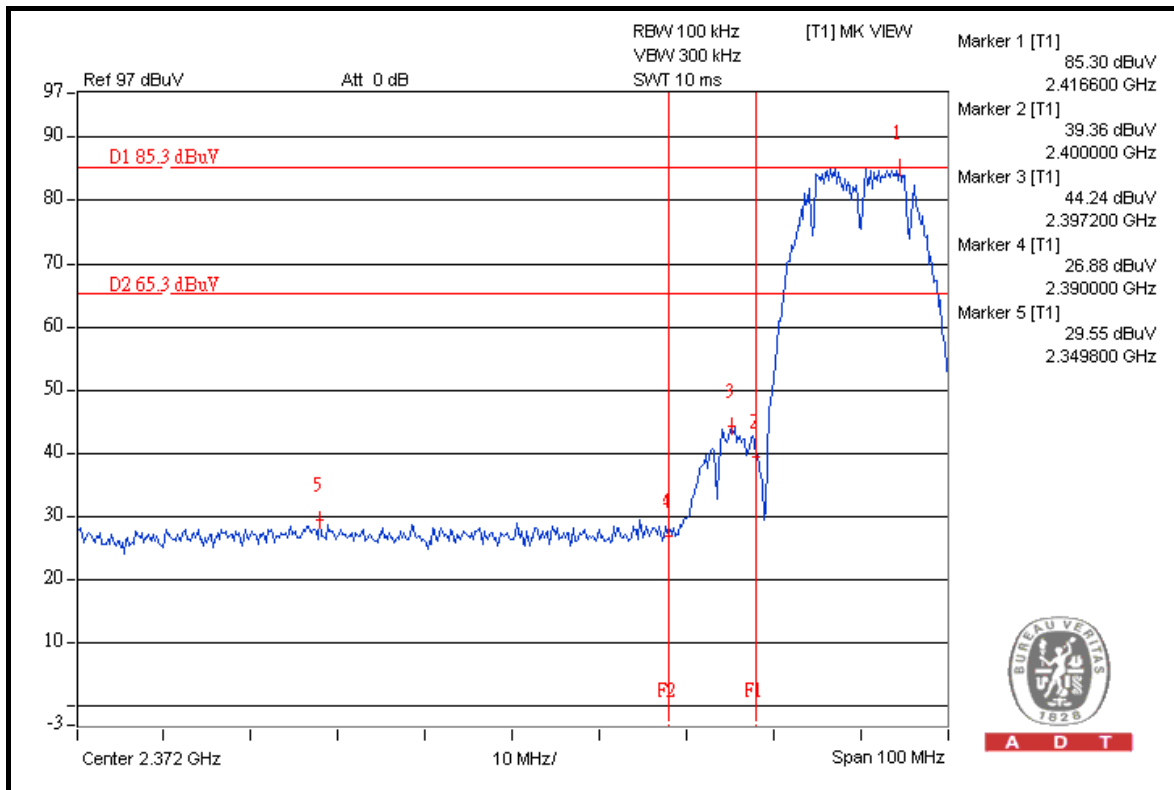



A D T

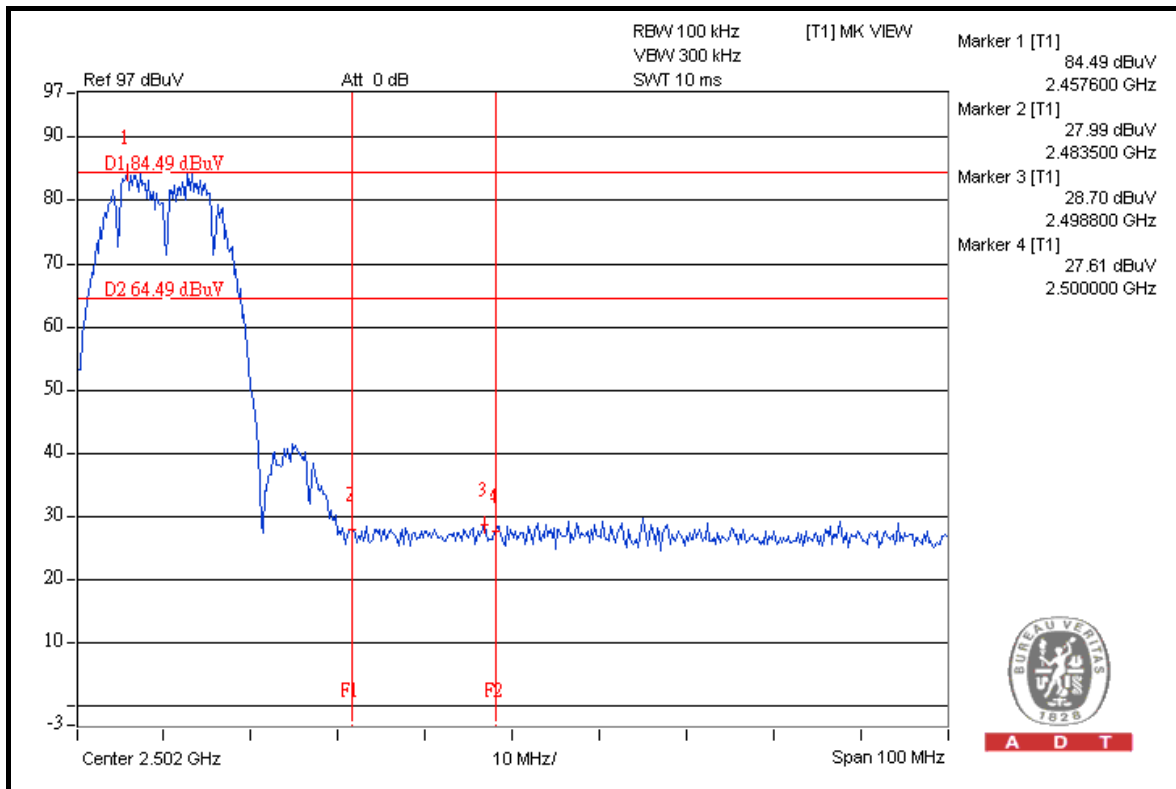
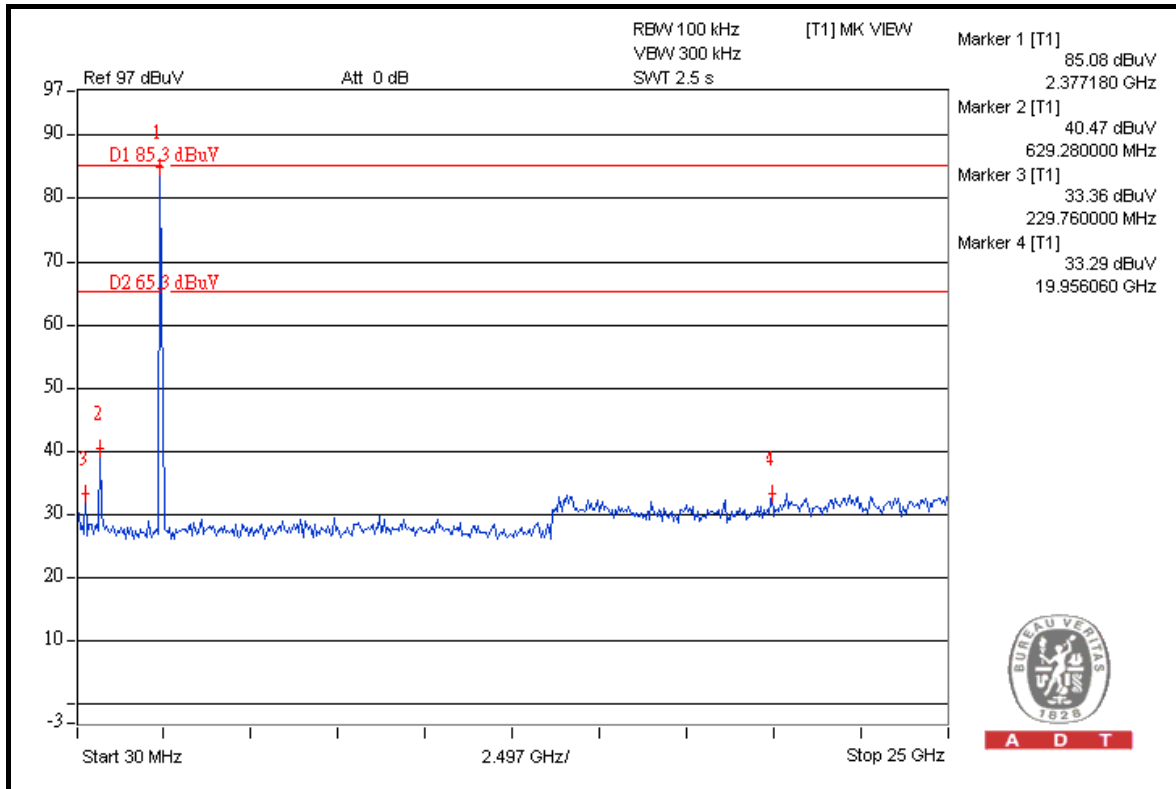



A D T

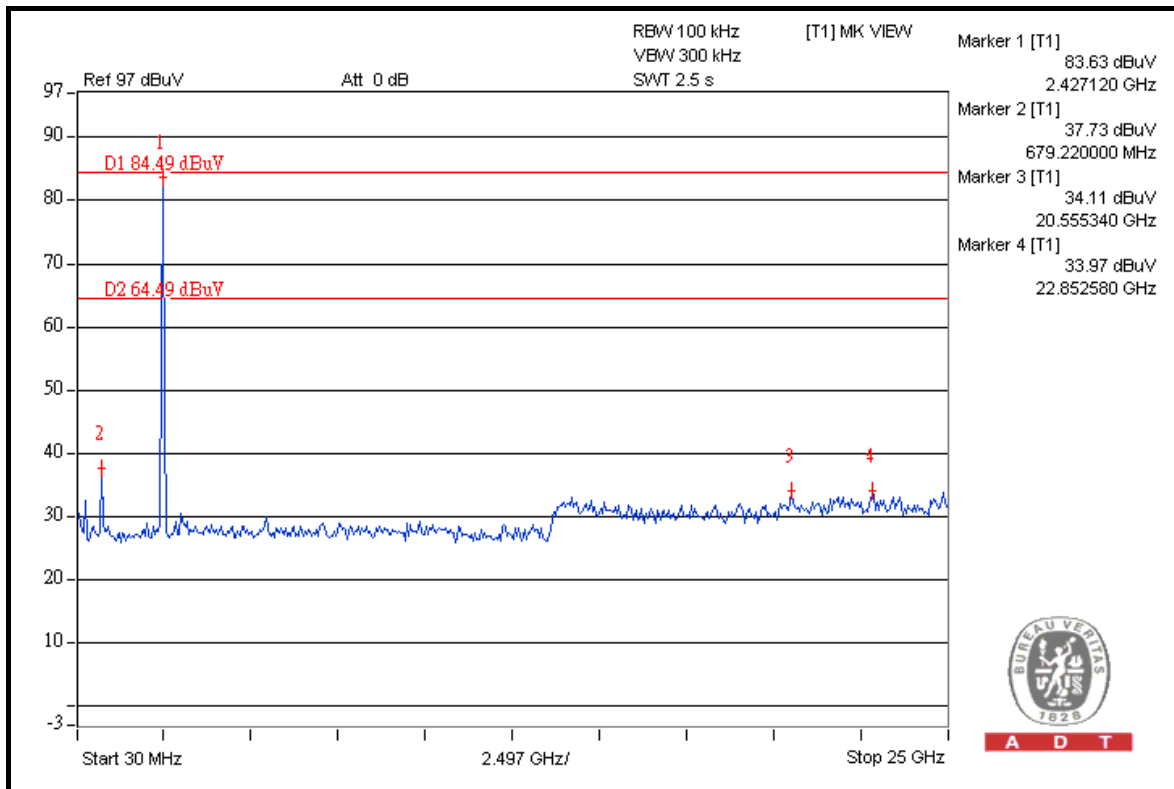
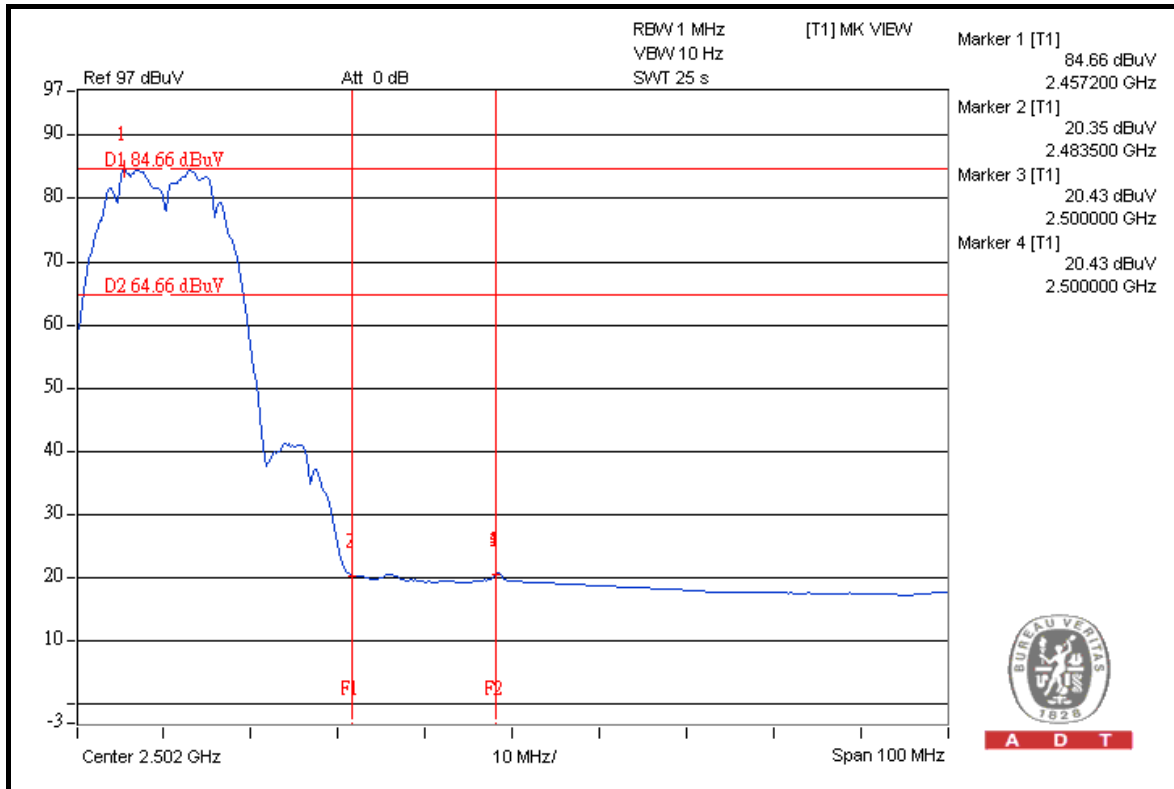



802.11g OFDM MODULATION

NOTE 1: The band edge emission plot on the next page shows 44.30dBc between carrier maximum power and local maximum emission in restrict band (2.39000GHz). The emission of carrier strength list in the test result of channel 1 at the item 4.1.7 is 116.82dBuV/m (Peak), so the maximum field strength in restrict band is $116.82 - 44.30 = 72.52$ dBuV/m which is under 74dBuV/m limit.

The band edge emission plot of on the next page shows 52.54dBc between carrier maximum power and local maximum emission in restrict band (2.39000GHz). The emission of carrier strength list in the test result of channel 1 at the item 4.1.7 is 105.47dBuV/m (Average), so the maximum field strength in restrict band is $105.47 - 52.54 = 52.93$ dBuV/m which is under 54dBuV/m limit.

NOTE 2: The band edge emission plot on the next second page shows 44.78dBc between carrier maximum power and local maximum emission in restrict band (2.48540GHz). The emission of carrier strength list in the test result of channel 11 at the item 4.1.7 is 115.73dBuV/m (Peak), so the maximum field strength in restrict band is $115.73 - 44.78 = 70.95$ dBuV/m which is under 74dBuV/m limit.

The band edge emission plot on the next third page shows 51.52dBc between carrier maximum power and local maximum emission in restrict band (2.48350GHz). The emission of carrier strength list in the test result of channel 11 at the item 4.1.7 is 104.43dBuV/m (Average), so the maximum field strength in restrict band is $104.43 - 51.52 = 52.91$ dBuV/m which is under 54dBuV/m limit.



A D T

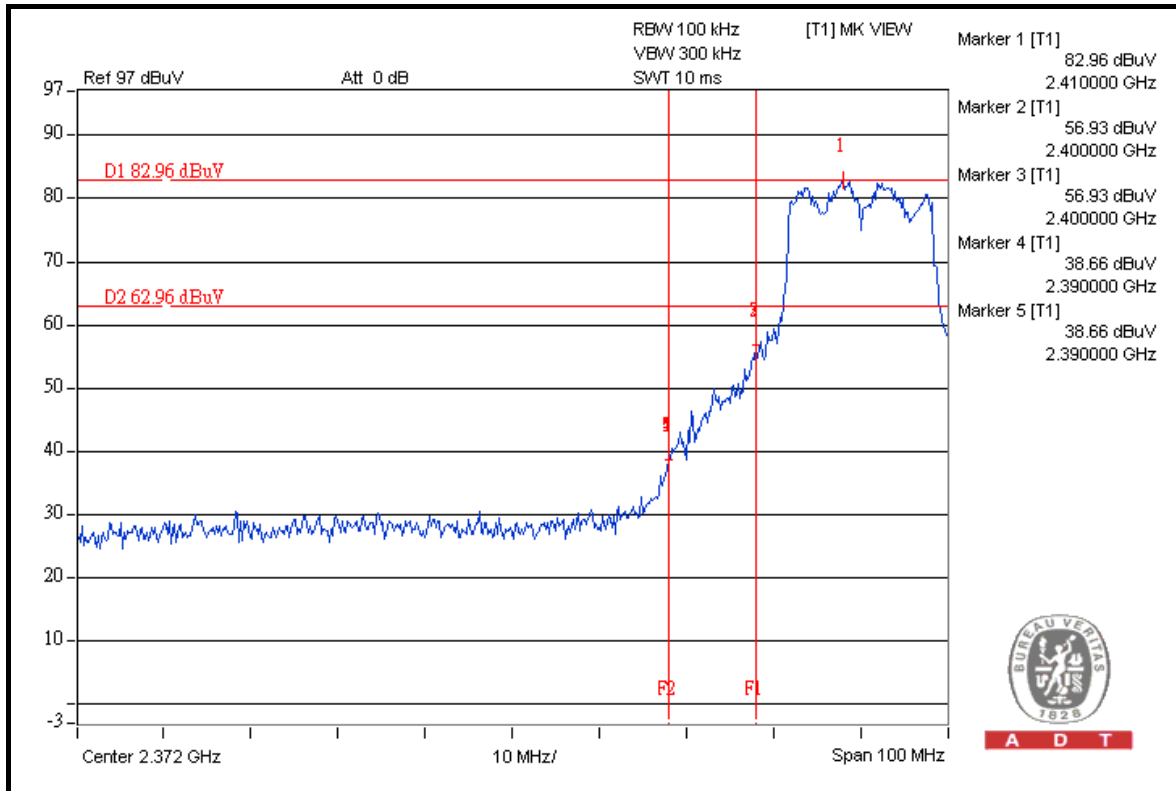

A D T

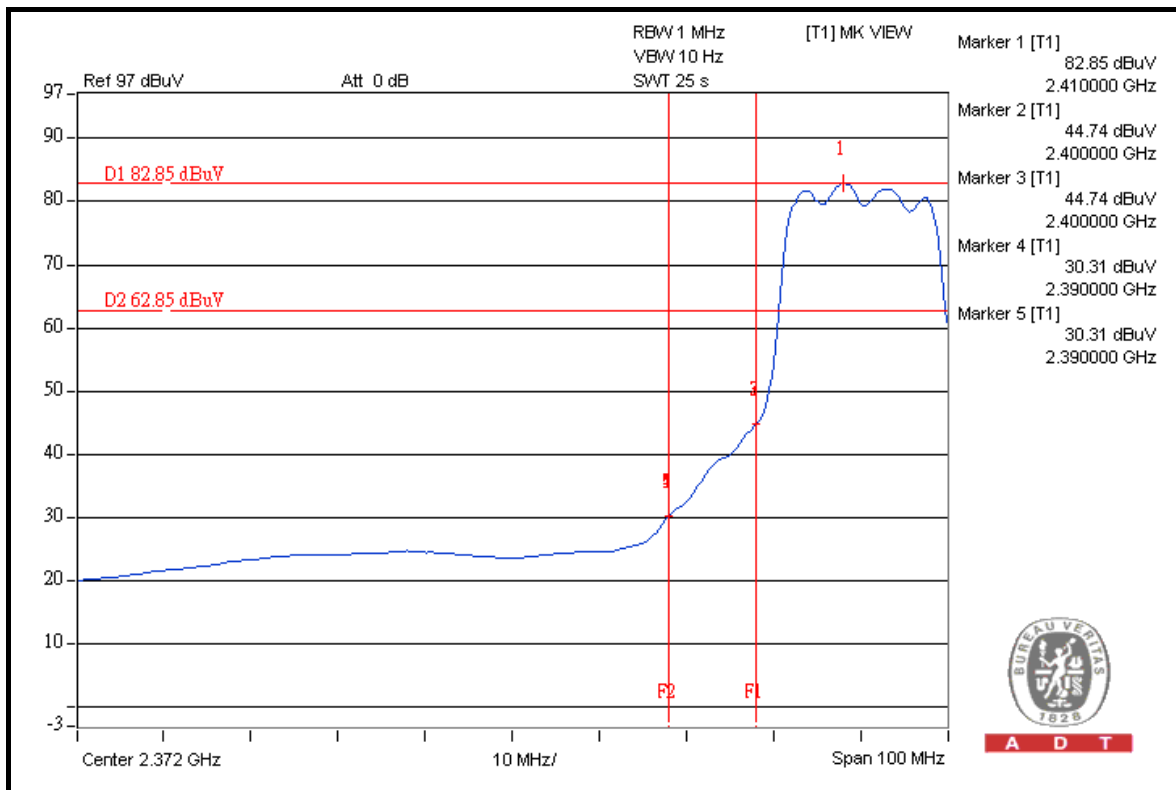

A D T



A D T

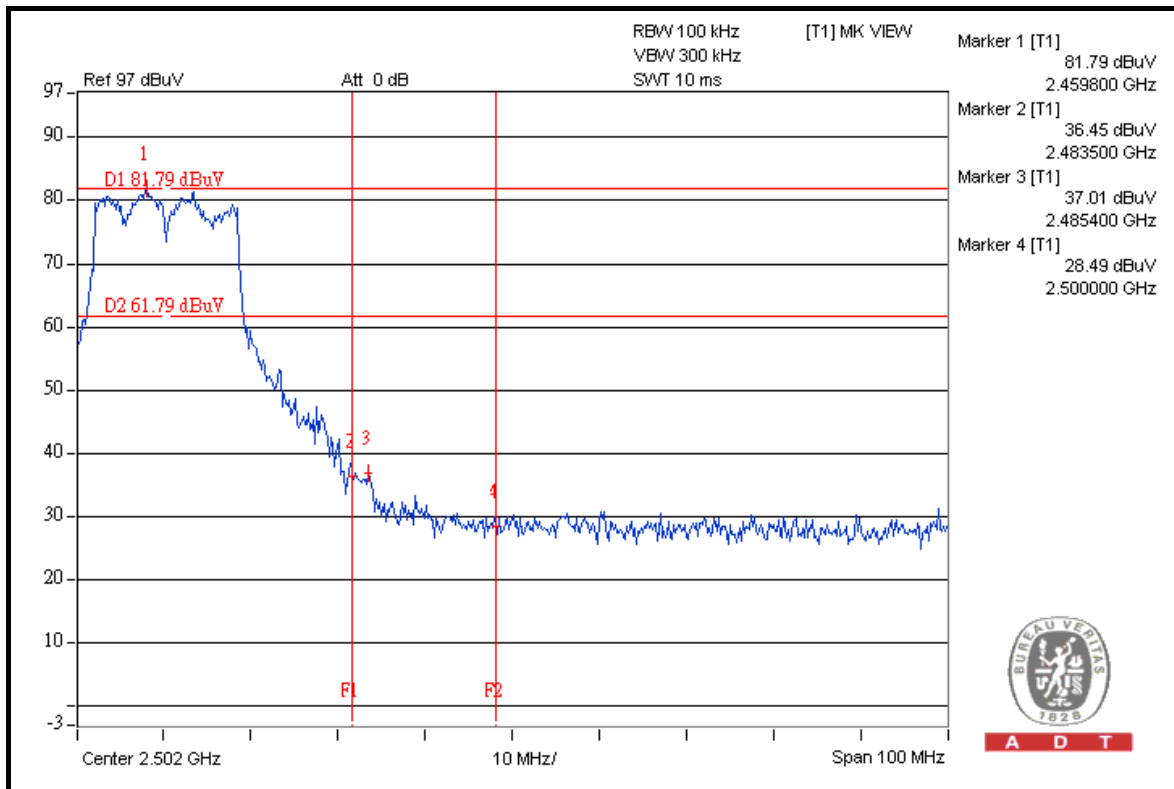
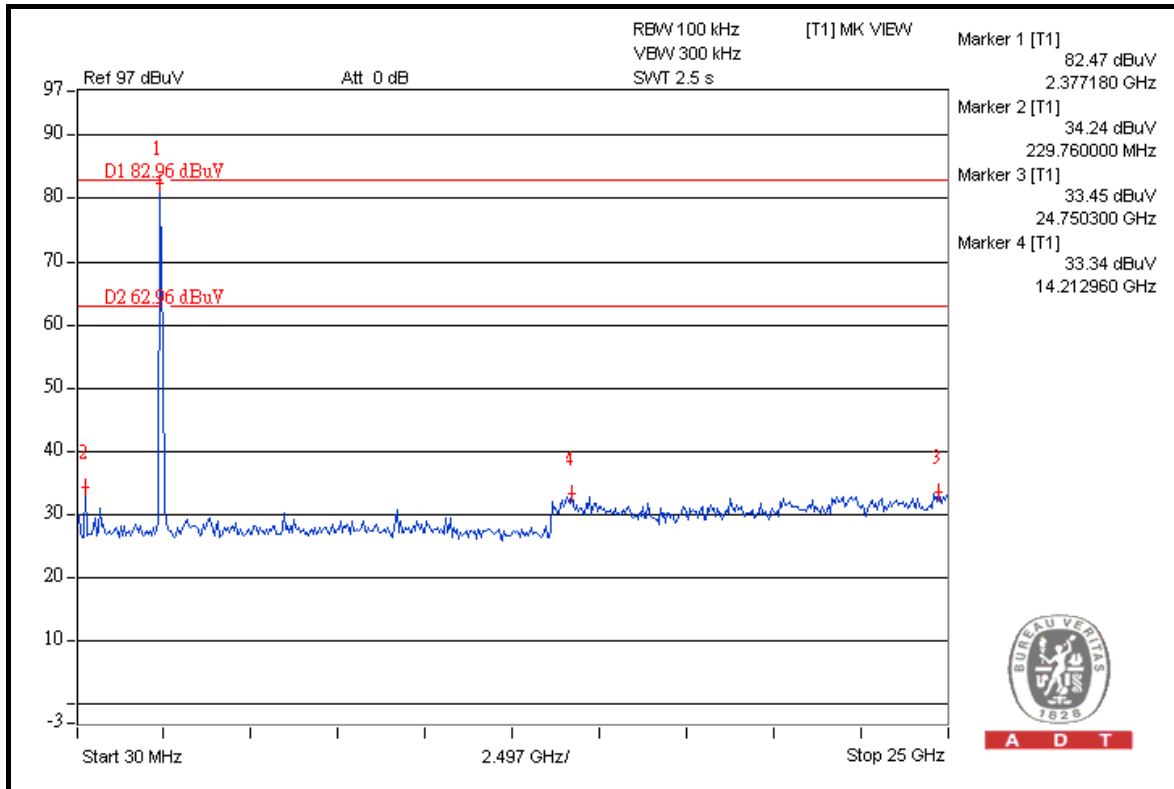



A D T

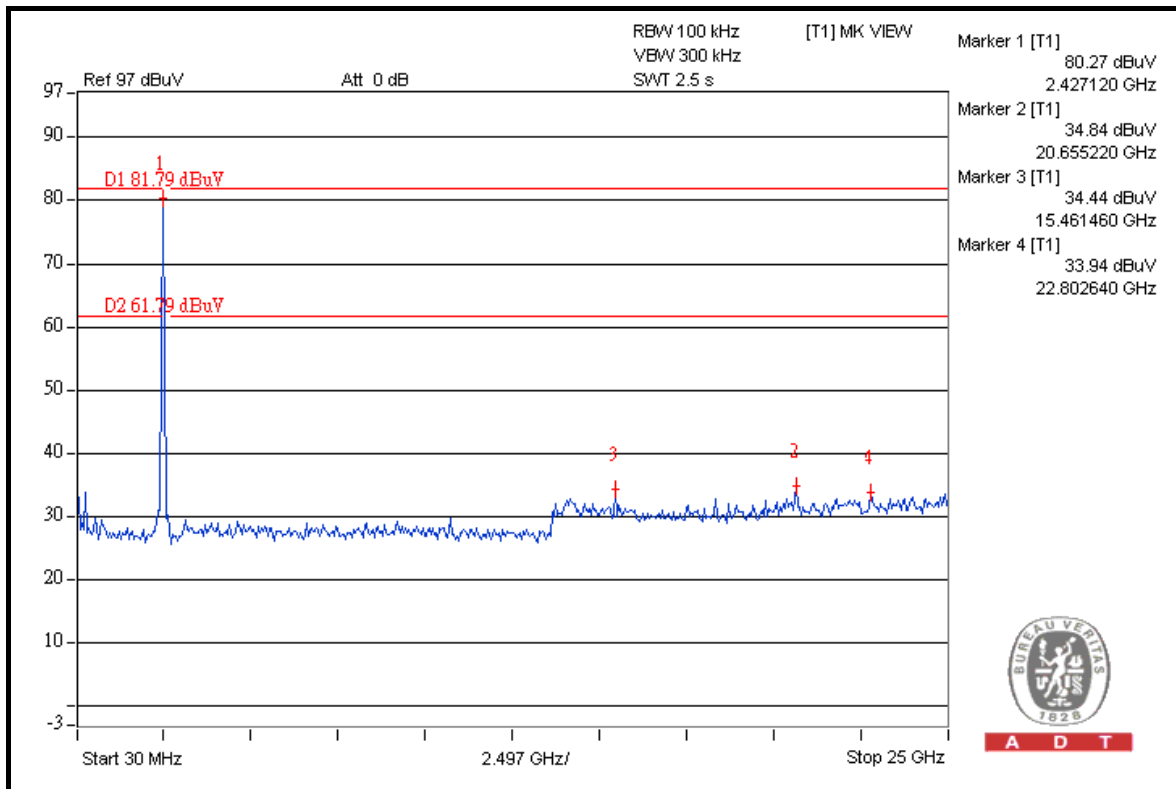
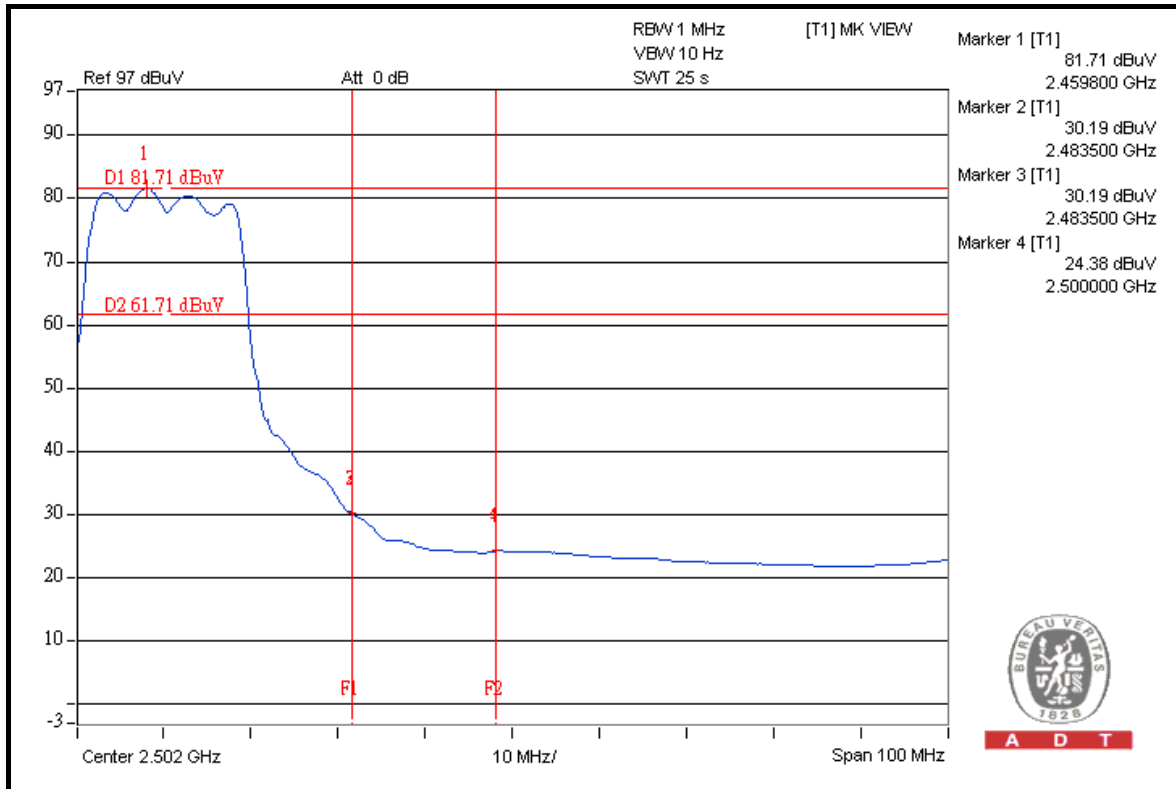



DRAFT 802.11n (20MHz) OFDM MODULATION

NOTE 1: The band edge emission plot on the next page shows 45.64dBc between carrier maximum power and local maximum emission in restrict band (2.38960GHz). The emission of carrier strength list in the test result of channel 1 at the item 4.1.7 is 114.64dBuV/m (Peak), so the maximum field strength in restrict band is $114.64 - 45.64 = 69.00$ dBuV/m which is under 74dBuV/m limit.

The band edge emission plot of on the next page shows 50.45dBc between carrier maximum power and local maximum emission in restrict band (2.39000GHz). The emission of carrier strength list in the test result of channel 1 at the item 4.1.7 is 102.98dBuV/m (Average), so the maximum field strength in restrict band is $102.98 - 50.45 = 52.53$ dBuV/m which is under 54dBuV/m limit.

NOTE 2: The band edge emission plot on the next second page shows 48.13dBc between carrier maximum power and local maximum emission in restrict band (2.48380GHz). The emission of carrier strength list in the test result of channel 11 at the item 4.1.7 is 116.07dBuV/m (Peak), so the maximum field strength in restrict band is $116.07 - 48.13 = 67.94$ dBuV/m which is under 74dBuV/m limit.

The band edge emission plot on the next third page shows 51.26dBc between carrier maximum power and local maximum emission in restrict band (2.48350GHz). The emission of carrier strength list in the test result of channel 11 at the item 4.1.7 is 104.14dBuV/m (Average), so the maximum field strength in restrict band is $104.14 - 51.26 = 52.88$ dBuV/m which is under 54dBuV/m limit.



A D T

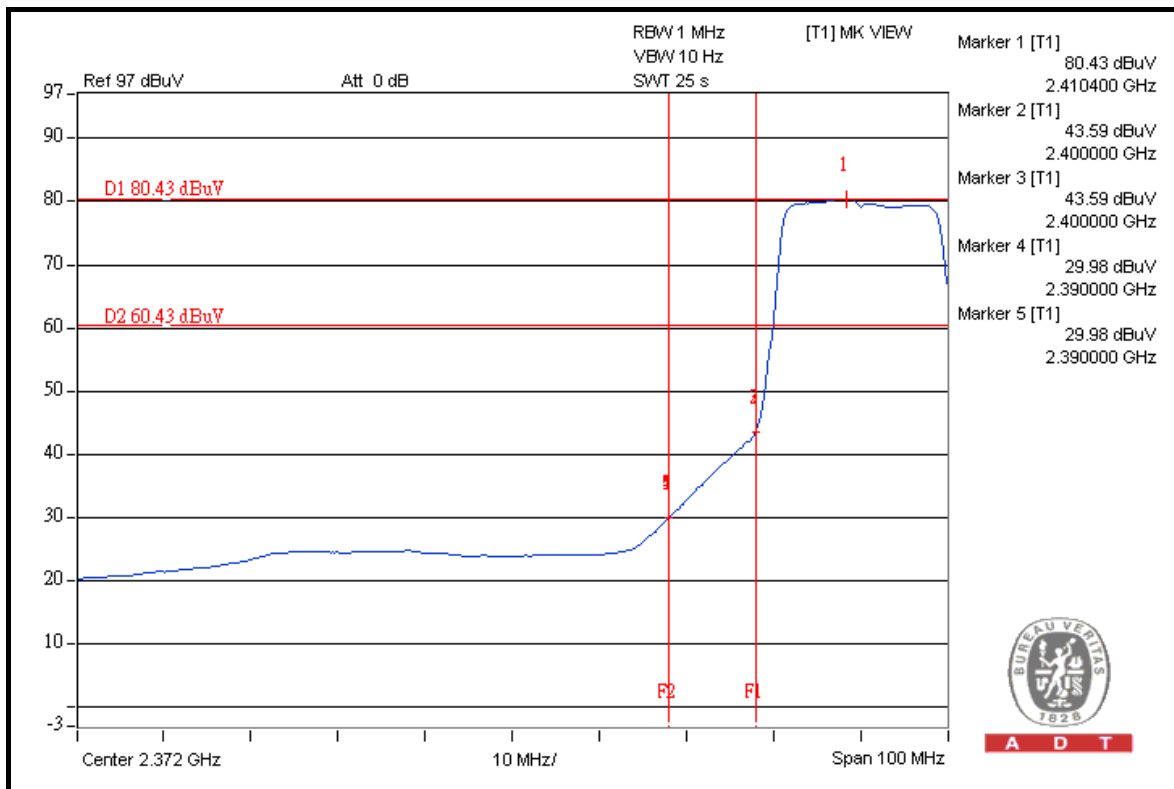
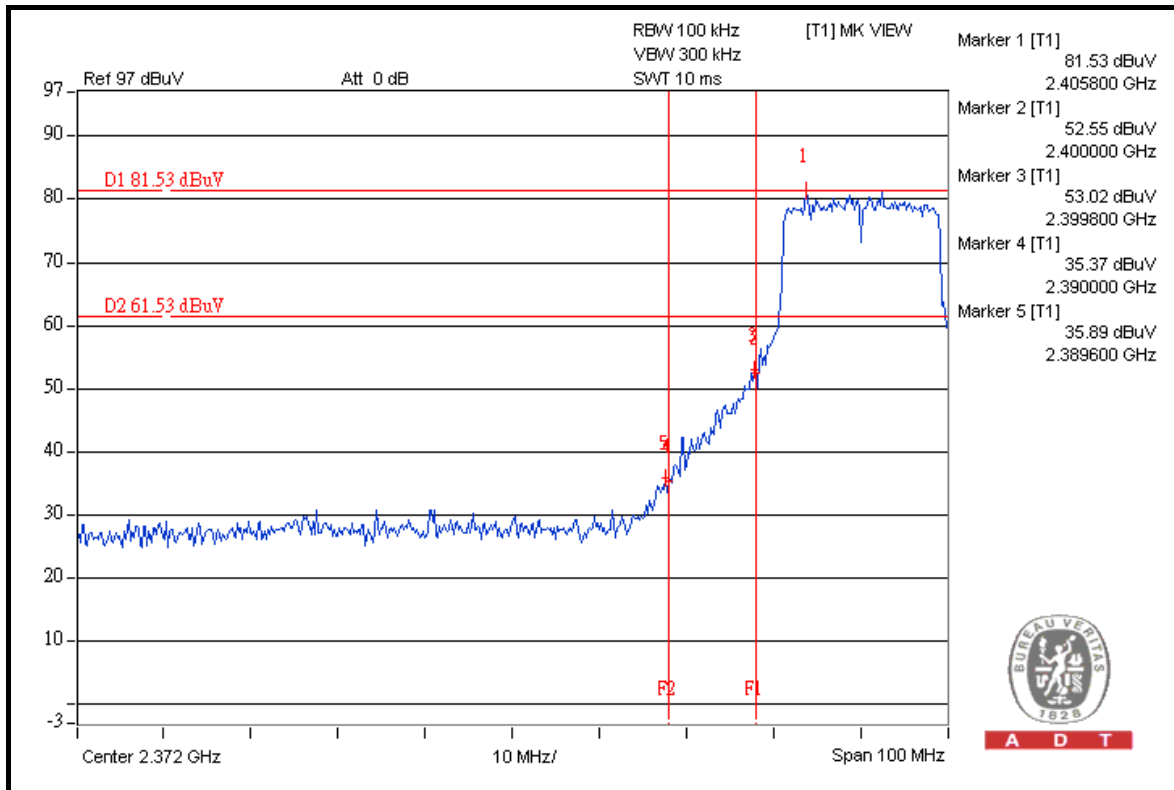



A D T

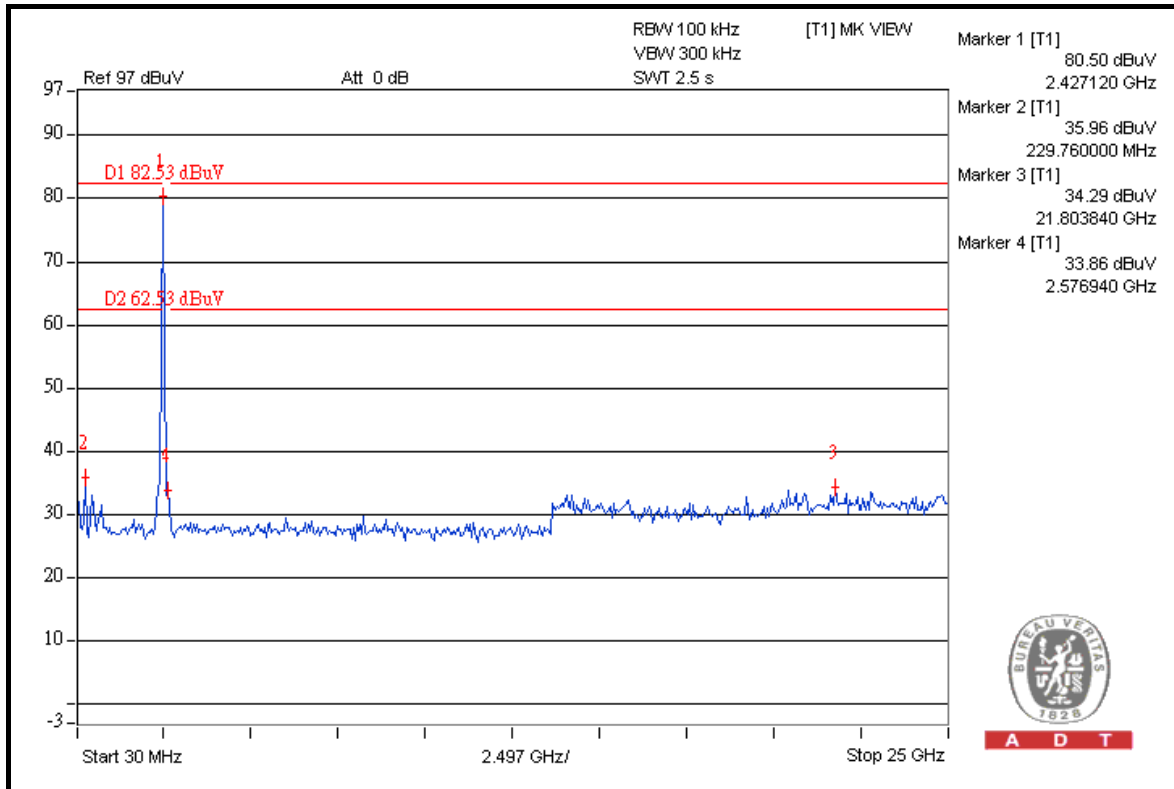

A D T

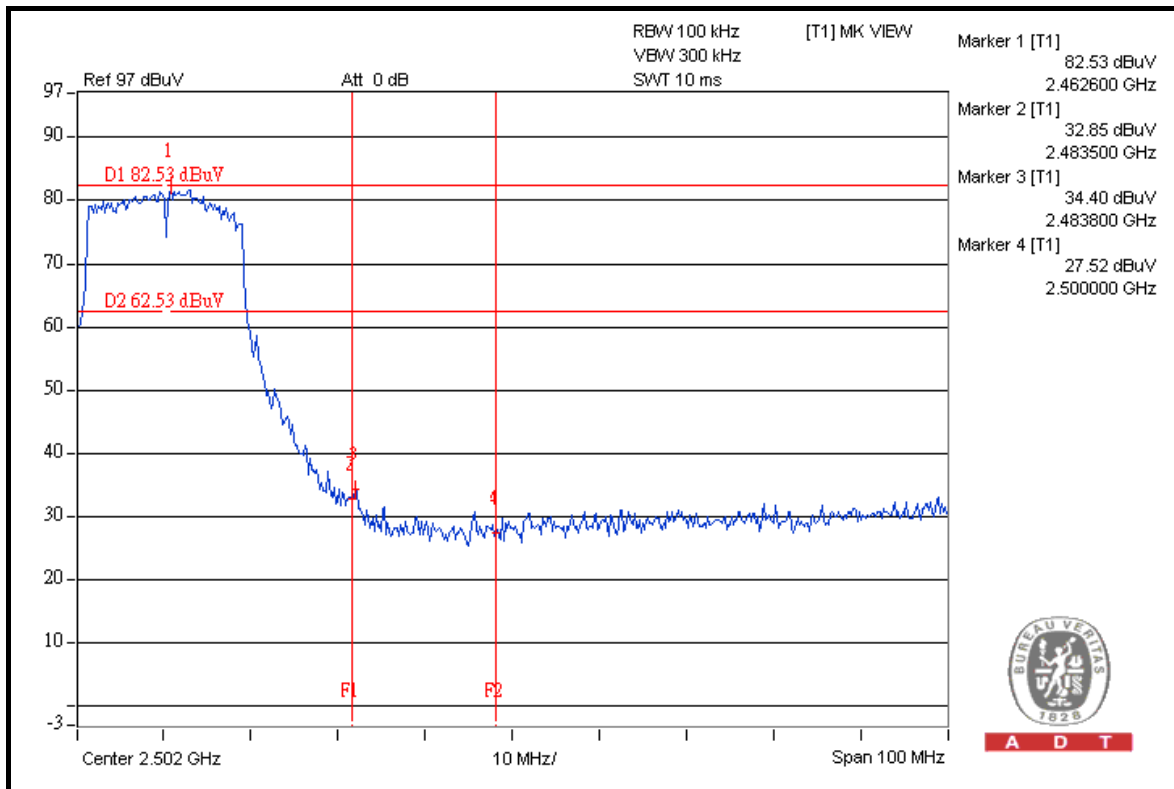

A D T



A D T

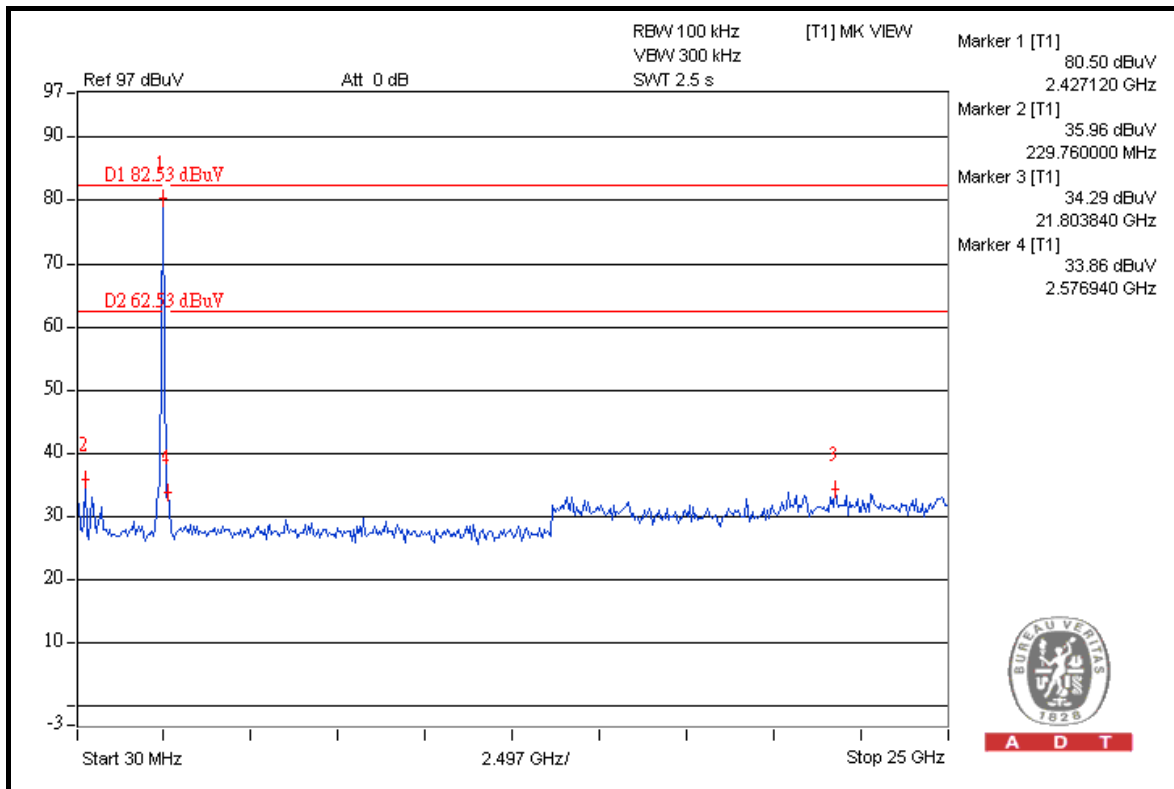
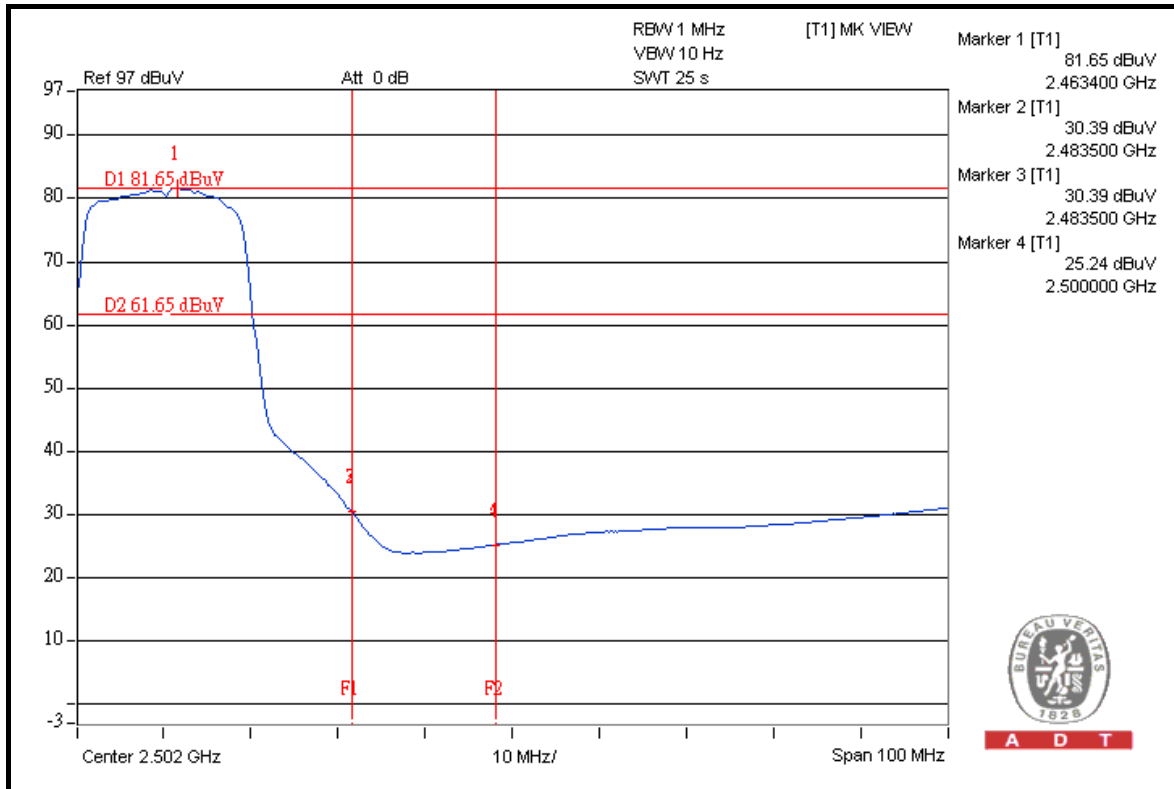



DRAFT 802.11n (40MHz) OFDM MODULATION

NOTE 1: The band edge emission plot on the next page shows 37.98dBc between carrier maximum power and local maximum emission in restrict band (2.38840GHz). The emission of carrier strength list in the test result of channel 1 at the item 4.1.7 is 110.11dBuV/m (Peak), so the maximum field strength in restrict band is $110.11 - 37.98 = 72.13$ dBuV/m which is under 74dBuV/m limit.

The band edge emission plot of on the next page shows 44.61dBc between carrier maximum power and local maximum emission in restrict band (2.39000GHz). The emission of carrier strength list in the test result of channel 1 at the item 4.1.7 is 96.53dBuV/m (Average), so the maximum field strength in restrict band is $96.53 - 44.61 = 51.92$ dBuV/m which is under 54dBuV/m limit.

NOTE 2: The band edge emission plot on the next second page shows 37.19dBc between carrier maximum power and local maximum emission in restrict band (2.48840GHz). The emission of carrier strength list in the test result of channel 7 at the item 4.1.7 is 110.01dBuV/m (Peak), so the maximum field strength in restrict band is $110.01 - 37.19 = 72.82$ dBuV/m which is under 74dBuV/m limit.

The band edge emission plot on the next third page shows 47.27dBc between carrier maximum power and local maximum emission in restrict band (2.48350GHz). The emission of carrier strength list in the test result of channel 7 at the item 4.1.7 is 96.70dBuV/m (Average), so the maximum field strength in restrict band is $96.70 - 47.27 = 49.43$ dBuV/m which is under 54dBuV/m limit.



A D T

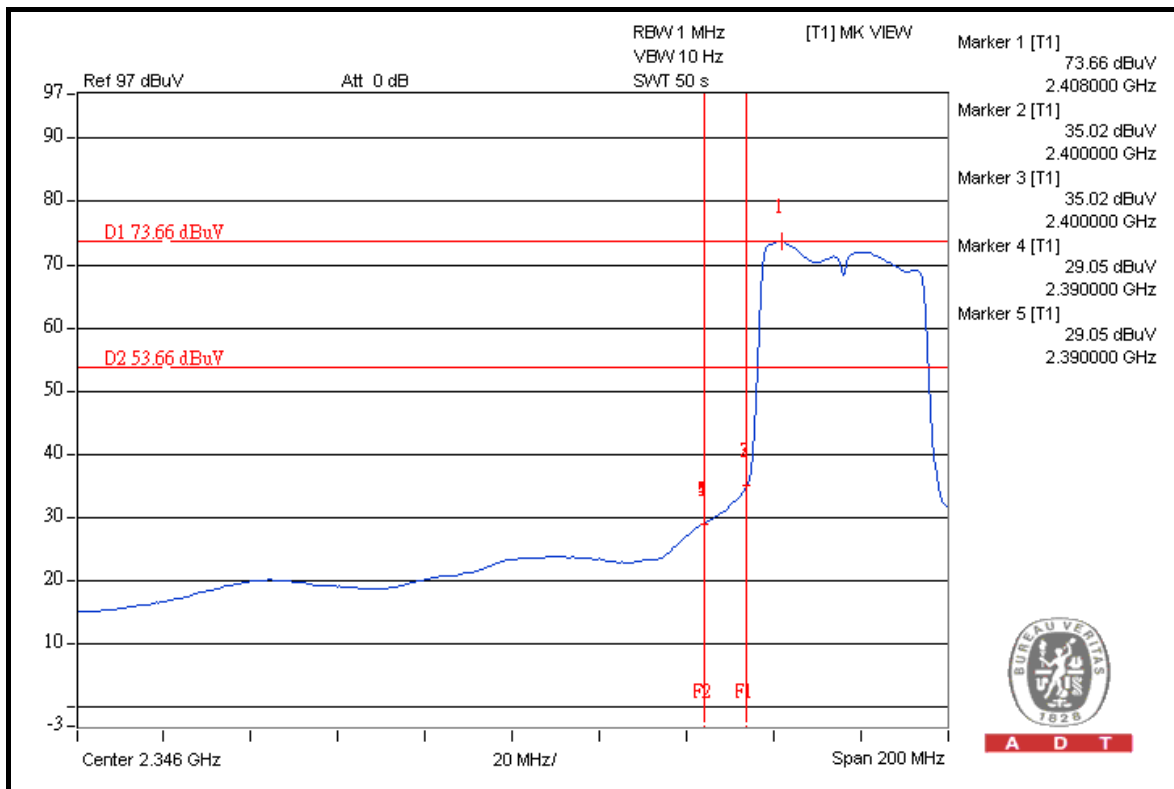
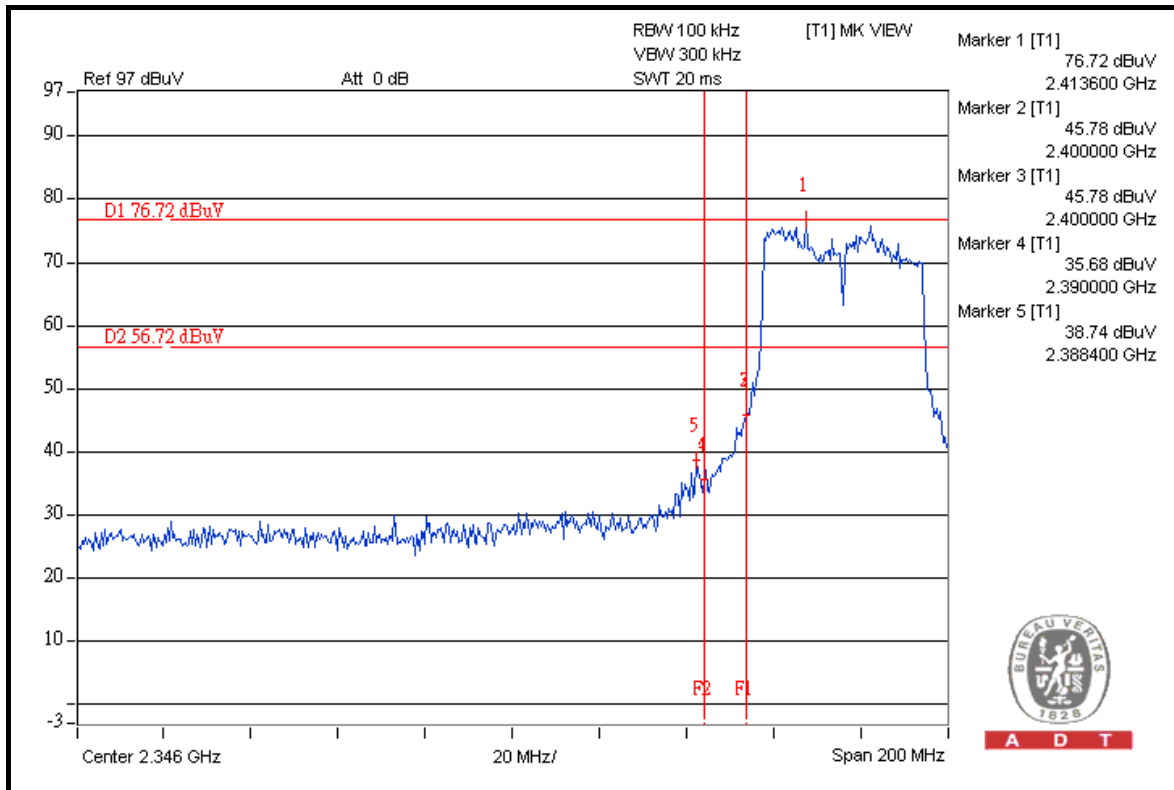



A D T

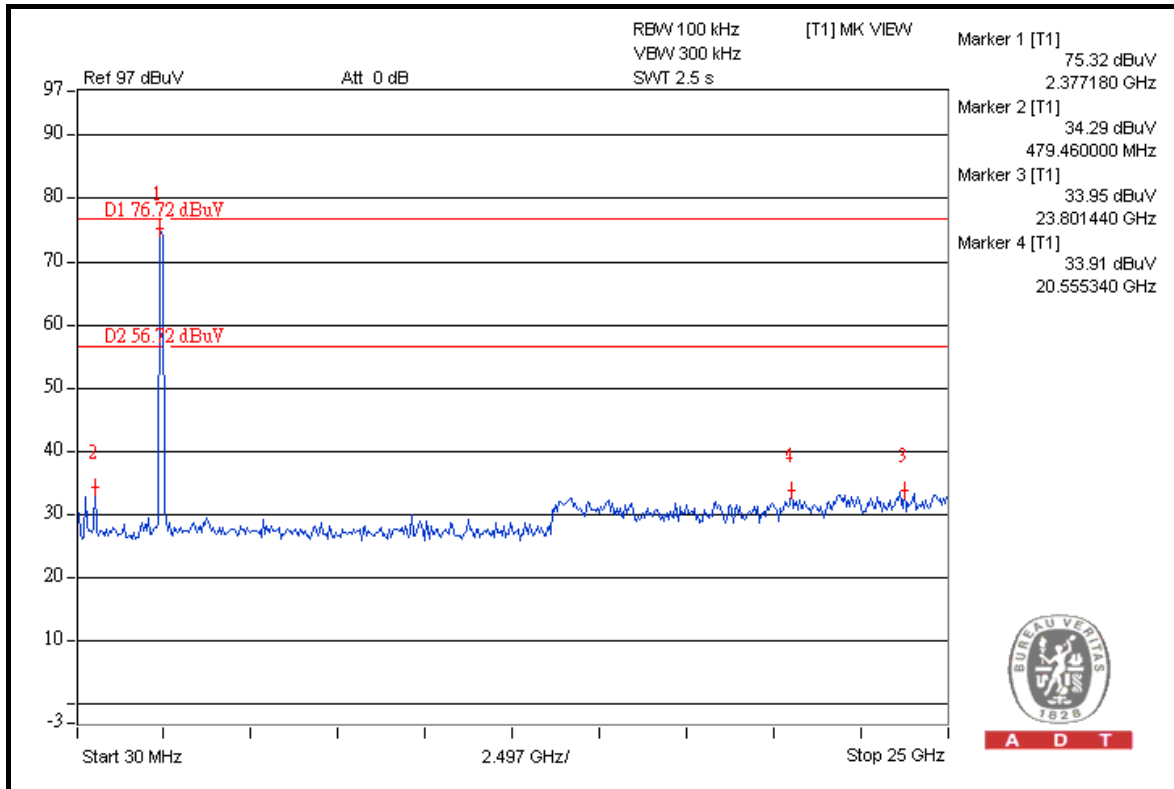

A D T

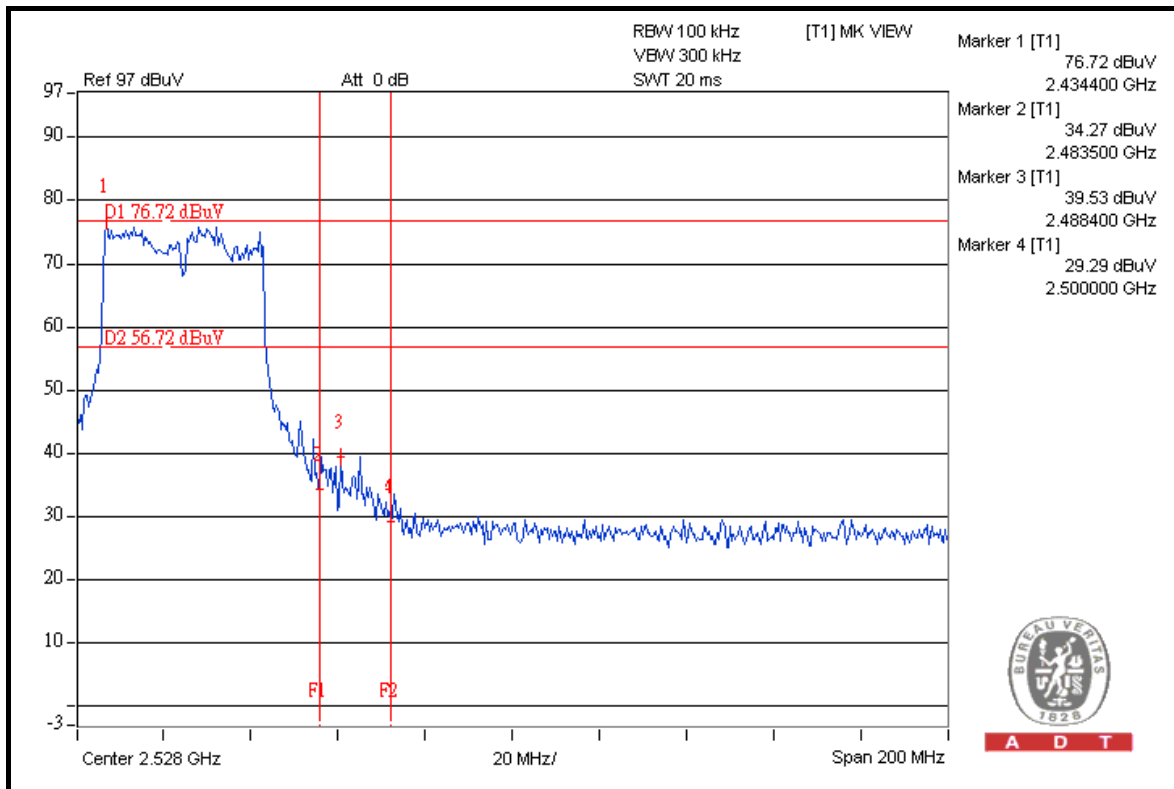

A D T



A D T

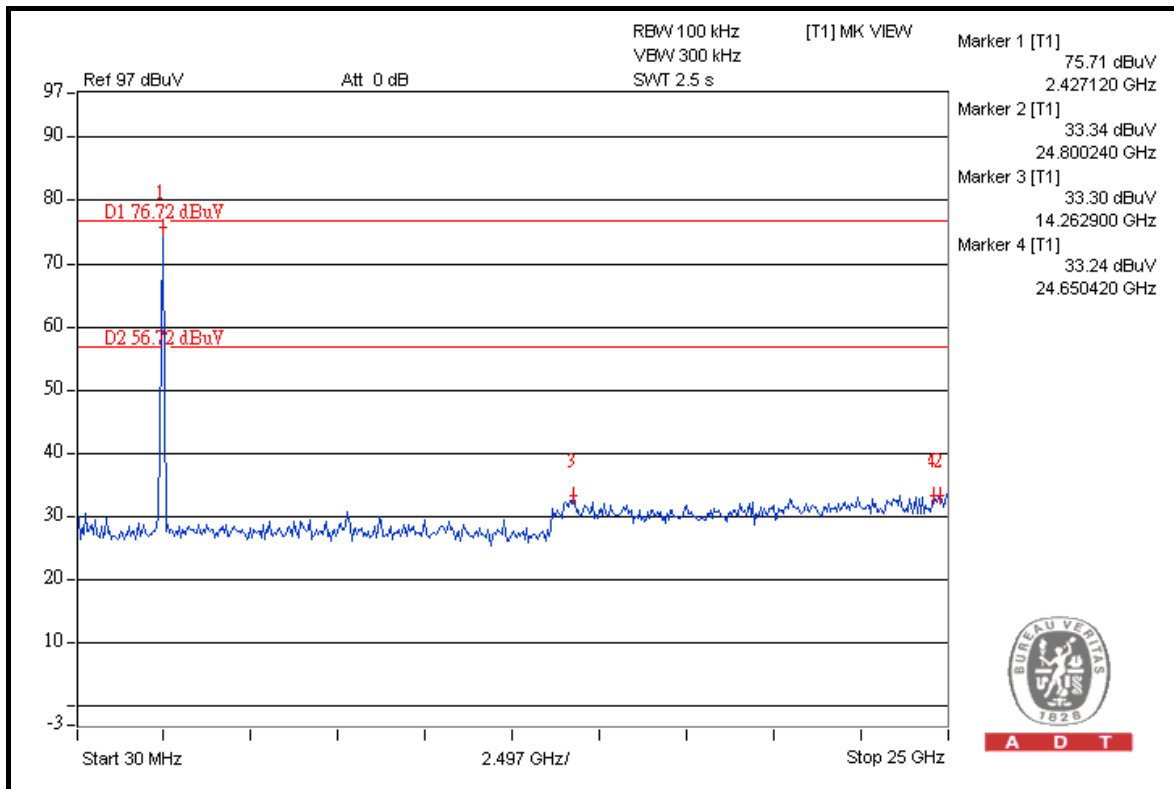
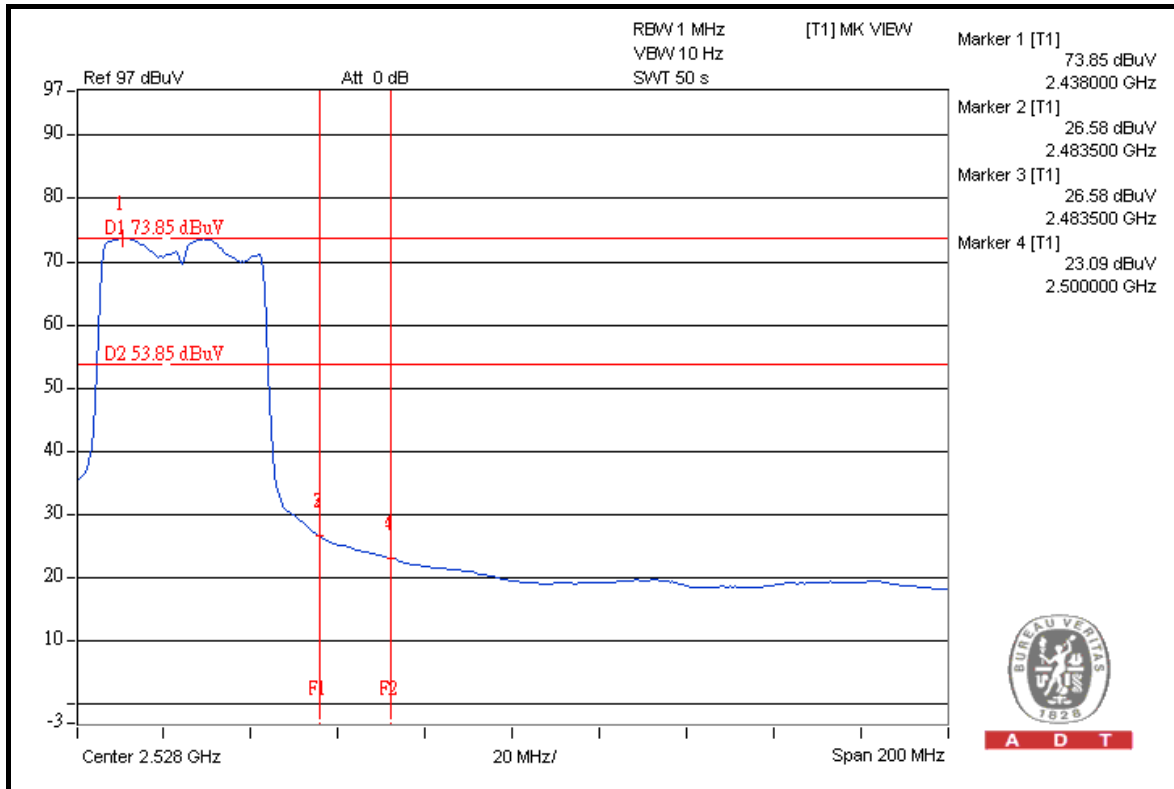



A D T

4.7 ANTENNA REQUIREMENT

4.7.1 STANDARD APPLICABLE

For intentional device, according to FCC 47 CFR Section 15.203, an intentional radiator shall be designed to ensure that no antenna other than that furnished by the responsible party shall be used with the device.

And according to FCC 47 CFR Section 15.247 (b), if transmitting antennas of directional gain greater than 6dBi are used, the power shall be reduced by the amount in dB that the directional gain of the antenna exceeds 6dBi.

4.7.2 ANTENNA CONNECTED CONSTRUCTION

The antenna used in this product is Dipole antenna with R-SMA connector. The maximum gain of the antenna is 2dBi.



A D T

5. PHOTOGRAPHS OF THE TEST CONFIGURATION

Please refer to the attached file (Test Setup Photo).



A D T

6. INFORMATION ON THE TESTING LABORATORIES

We, Bureau Veritas Consumer Products Services (H.K.) Ltd., Taoyuan Branch, were founded in 1988 to provide our best service in EMC, Radio, Telecom and Safety consultation. Our laboratories are accredited and approved by the following approval agencies according to ISO/IEC 17025.

| | |
|--------------------|----------------------|
| USA | FCC, NVLAP |
| Germany | TUV Rheinland |
| Japan | VCCI |
| Norway | NEMKO |
| Canada | INDUSTRY CANADA, CSA |
| R.O.C. | TAF, BSMI, NCC |
| Netherlands | Telefication |
| Singapore | GOST-ASIA(MOU) |
| Russia | CERTIS(MOU) |

Copies of accreditation certificates of our laboratories obtained from approval agencies can be downloaded from our web site:

www.adt.com.tw/index.5/phtml. If you have any comments, please feel free to contact us at the following:

Linko EMC/RF Lab:
Tel: 886-2-26052180
Fax: 886-2-26051924

Hsin Chu EMC/RF Lab:
Tel: 886-3-5935343
Fax: 886-3-5935342

Hwa Ya EMC/RF/Safety Telecom Lab:
Tel: 886-3-3183232
Fax: 886-3-3185050

Web Site: www.adt.com.tw

The address and road map of all our labs can be found in our web site also.



A D T

7. APPENDIX A - MODIFICATIONS RECORDERS FOR ENGINEERING CHANGES TO THE EUT BY THE LAB

No any modifications are made to the EUT by the lab during the test.

---END---