

MEASUREMENT REPORT of *802.11g Wireless Access Point*

Applicant : TRENDware International Inc.
EUT : 802.11g Wireless Access Point
Model : TEW-430APB
FCC ID : S9ZTEW430APB

Tested by :

Training Research Co., Ltd.

TEL : 886-2-26935155 FAX : 886-2-26934440

No. 255, Nanyang Street, Shijr, Taipei Hsien 221, Taiwan, R.O.C.

CERTIFICATION

We here by verify that:

The test data, data evaluation, test procedures and equipment configurations shown in this report were made mainly in accordance with the procedures given in ANSI C63.4 (2003) as a reference. All test were conducted by *Training Research Co., Ltd.*, 255 Nanyang Street, Shijr, Taipei Hsien 221, Taiwan, R.O.C. Also, we attest to the accuracy of each.

We further submit that the energy emitted by the sample EUT tested as described in the report is **in compliance with** the technical requirements set forth in the FCC Rules Part 15 Subpart B (Declaration of Conformity) and C Section 15.247.

Applicant : TRENDware International Inc.
Applicant address : 3135 Kashiwa Street, Torrance, CA 90505, United States
FCC ID : S9ZTEW430APB
Report No. : C5115050390
Test Date : October 27, 2004

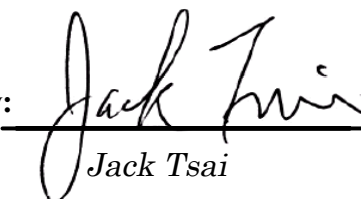
Prepared by: 
Jack Tsai

Approved by: 
Frank Tsai

Conditions of issue :

- (1) **This test report shall not be reproduced except in full, without written approval of TRC. And the test result contained within this report only relate to the sample submitted for testing.**
- (2) **This report must not be used by the client to claim product endorsement by NVLAP or any agency of U.S. Government.**
- (3) **This test report, measurements made by TRC are traceable to the NIST only Conducted and Radiated Method.**

★ NVLAP LAB CODE: 200174-0

Federal Communications Commission **Declaration of Conformity**

for the following equipment:

Product name : 802.11g Wireless Access Point
 Trade name : TRENDnet
 Model name : TEW-430APB

Is herewith confirmed and found to comply with the requirements of CFR 47 part15 Subpart B - Unintentional Radiators regulation. The results of electromagnetic mission evaluation are shown in the report number : C5115050390

This device complies with Part 15 of the FCC Rules. Operation is subject to the following two conditions:

- (1) This device may not cause harmful interference, and
- (2) This device must accept any interference received, including interference that may cause undesired operation

Manufacturer	USA local representative
Company name: CAMEO Communications, Inc.	To be determined
Computer address: 6F, No.22, Chung Shin Rd., Hsi-Chih, Taipei, Taiwan	
ZIP / Postal code: 221	
Contact person: Jason Chang	
Title: Wireless Comm RD Dept Manager	
Internet e-mail address: jason_chang@mail.cameo.com.tw	
Tel / Fax: 886-2-26499800 / 886-2-26499984	

Tables of Contents

I. GENERAL	6
1.1 Introduction	6
1.2 Description of EUT	6
1.3 Test method	7
1.4 Description of Support Equipment	7
1.5 Configuration of System Under Test	10
1.6 Verify the Frequency and Channel	12
1.7 Test Procedure	13
1.8 Location of the Test Site	13
1.9 General Test Condition	13
II. Section 15.101(a) : Equipment Authorization of Unintentional Radiators	14
III. Section 15.203 : Antenna Requirement	15
IV. Section 15.207 : Power Line Conducted Emissions for AC Powered Units	16
4.1 Test Condition & Setup	16
4.2 List of Test Instruments	17
4.3 Test Result of Conducted Emissions	18
DV-0751AS	18
DV-051A2S-B25	22
RH41-0751000DU	25
RH41-0501200DU	28
V. Section 15.247(a) : Technical Description of the EUT	31

VI. Section 15.247(a)(2) : Bandwidth for Direct Sequence System	32
6.1 Test Condition & Setup	32
6.2 Test Instruments Configuration	32
6.3 List of Test Instruments	32
6.4 Test Result of Bandwidth	32
Channel 01	33
Channel 06	34
Channel 11	35
VII. Section 15.247(b) : Power Output	36
7.1 Test Condition & Setup	36
7.2 List of Test Instruments	36
7.3 Test Result	36
VIII. Section 15.247(c) : Spurious Emissions (Radiated)	37
8.1 Test Condition & Setup	37
8.2 List of Test Instruments	39
8.3 Test Result of Spurious Radiated Emissions	40
Standby mode	40
IEEE 802.11b	42
IEEE 802.11g	48
8.4 Test Result of Bandedge	54
IEEE 802.11b	55
IEEE 802.11g	57
IX. Section 15.247(d) : Power Spectral Density	59
9.1 Test Condition & Setup	59
9.2 Test Instruments Configuration	59
9.3 List of Test Instruments	59
9.4 Test Result of Power Spectral Density	60
Channel 01	61
Channel 06	62
Channel 11	63

I . GENERAL

1.1 Introduction

The following measurement report is submitted on behalf of applicant in support that the certification in accordance with Part 2 Subpart J and Part 15 Subpart A, B and C of the Commission's Rules and Regulations.

1.2 Description of EUT

Granted FCC ID : S9ZTEW430APB

Product Name : 802.11g Wireless Access Point

Model Name : TEW-430APB

Frequency Range : 2.412 GHz ~ 2.462GHz

Support Channel : 11 Channels

Modulation Skill : DBPSK, DQPSK, CCK, OFDM

Power Type : Powered by the adapter,
a) Model: DV-751AS (Principal)
I/P: 120VAC, 60Hz, 16W
O/P: 7.5VDC, 1A
or b) Model: DV-051A2S-B25
I/P: 120VAC, 60Hz, 23W
O/P: 5VDC, 1.2A
or c) Model: RH41-0751000DU
I/P: 120VAC, 60Hz
O/P: 7.5VDC, 1000mA
or d) Model: RH41-0501200DU
I/P: 120VAC, 60Hz
O/P: 5VDC, 1200mA

Power Cable : 188cm length, non-shielded, no ferrite core

Data Cable : RJ45 cable, 1.5m length, non-shielded, no ferrite core

1.3 Test method

1. Connected the LAN port of EUT to the LAN card which installed in PC.
2. Using the PC and software provided by the manufacturer to control EUT, the test is performed under the specific conditions.
3. Set different data rate and channel (CH1/CH6/CH11) being tested and making EUT to the following modes:
 - (a) Radiated for Intentional test:
making EUT to the mode of continuous transmission
 - (b) Conducted test and Radiated for unintentional test:
making EUT to the linking (Rx/Tx) mode with far support equipments

1.4 Description of Support Equipment

In order to construct the minimum testing, following equipment were used as the support units.

Notebook : **IBM Think Pad X20**

Model No. : 2662-11T

Serial No. : FX-1192200/09

FCC ID : N/A, DoC Approved

BSMI : 3892B565

Adaptor : **IBM**

Model No. : PA2450U

Serial No. : 02K6654

FCC ID : N/A, DoC Approved

Power type : I/P: 100 ~ 240Vac, 50 ~ 60 Hz, 0.5A ~ 1.2A
O/P: 16Vdc, 4.5A

Power cord : Non-shielded, 1.80m long, Plastic, with ferrite core

WLAN Card : **Gemtek Technology Co., Ltd.**

Model No. : C911003

FCC ID : MXF-C911003

PC : HP; IBM 8434
Model No. : HP Pavilion t000; d330 uT, IVG
Serial No. : TWL33020051; SGH41508PJ, 99CCZG9
FCC ID : N/A, DoC (Declaration of Confirmation) Approved
BSMI : R33001, R33001, R33026
Power type : 100 ~ 127VAC/4A, 200 ~ 240VAC/2A, 50 ~ 60Hz, Switching (HP)
100 ~ 127VAC/6A, 200 ~ 240VAC/3A, 50 ~ 60Hz, Switching (IBM)
Power cord : Non-shielded, 1.90m length, Plastic hood, No ferrite core

Monitor : HP 15' Color Monitor, HP pavilion mx70
Model No. : D2827A, P1283A
Serial No. : KR91379759, TWTBQ00397
FCC ID : C5F7NFCMC1518X, DoC Approved
BSMI : 3872B039, 4872A167
Power type : 100 ~ 240 VAC / 50 ~ 60 Hz, Switching
Power cord : Shielded, 1.83m length, No ferrite core
Data cable : Shielded, 1.46m length, with two ferrite cores

PS/2 Keyboard : HP
Model No. : 5187-0343, KB0133
Serial No. : BE21700404, 265987-AB1 Tch 323686-AB1
FCC ID : DoC Approved
BSMI : 3892C981, R31310
Power type : By PC
Data cable : Shielded, 1.85m length, with ferrite core

PS/2 Mouse : HP
Model No. : M-UR89, M-S69
Serial No. : LZS21750238, 334684-002 323614-001
FCC ID : DoC Approved
BSMI : 3892D767, R41126
Power type : By PC
Power cord : Shielded, 1.80m (1.90m) length, No ferrite core

LAN Card : **D-Link**
Model No. : DFE-530TX
Serial No. : 0050BAE32FF3
FCC ID : N/A, DoC Approved

Printer : **EPSON**
Model No. : B241A
Serial No. : FAPY155090
FCC ID : N/A, DoC Approved
BSMI : R33126
Power type : Switching adaptor
Power cord : Non-shielded, 198cm length, No ferrite core
Data cable : Shielded, 1.80m length, No ferrite core

Modem : **ACEEX**
Model No. : XDM-56V14
FCC ID : IFAXDM-56V14
Power type : Linear
Power cord : Non-shielded, 1.9m length, No ferrite cord
Data cable : RS232, Shielded, 1.2m length, No ferrite core
RJ11C x 2, 7' length non-shielded, No ferrite core

USB gamepad : **Rockfire**
Model No. : QF-337uv
Serial No. : 10600545, KR91379759
FCC ID : None (CE approval)
BSMI : 3862A574
Power type : By computer
Data Cable : Shielded, 1.81m length, Plastic, with ferrite core

1.5 Configuration of System Under Test

1.5.1 Conducted and Radiated for Unintentional

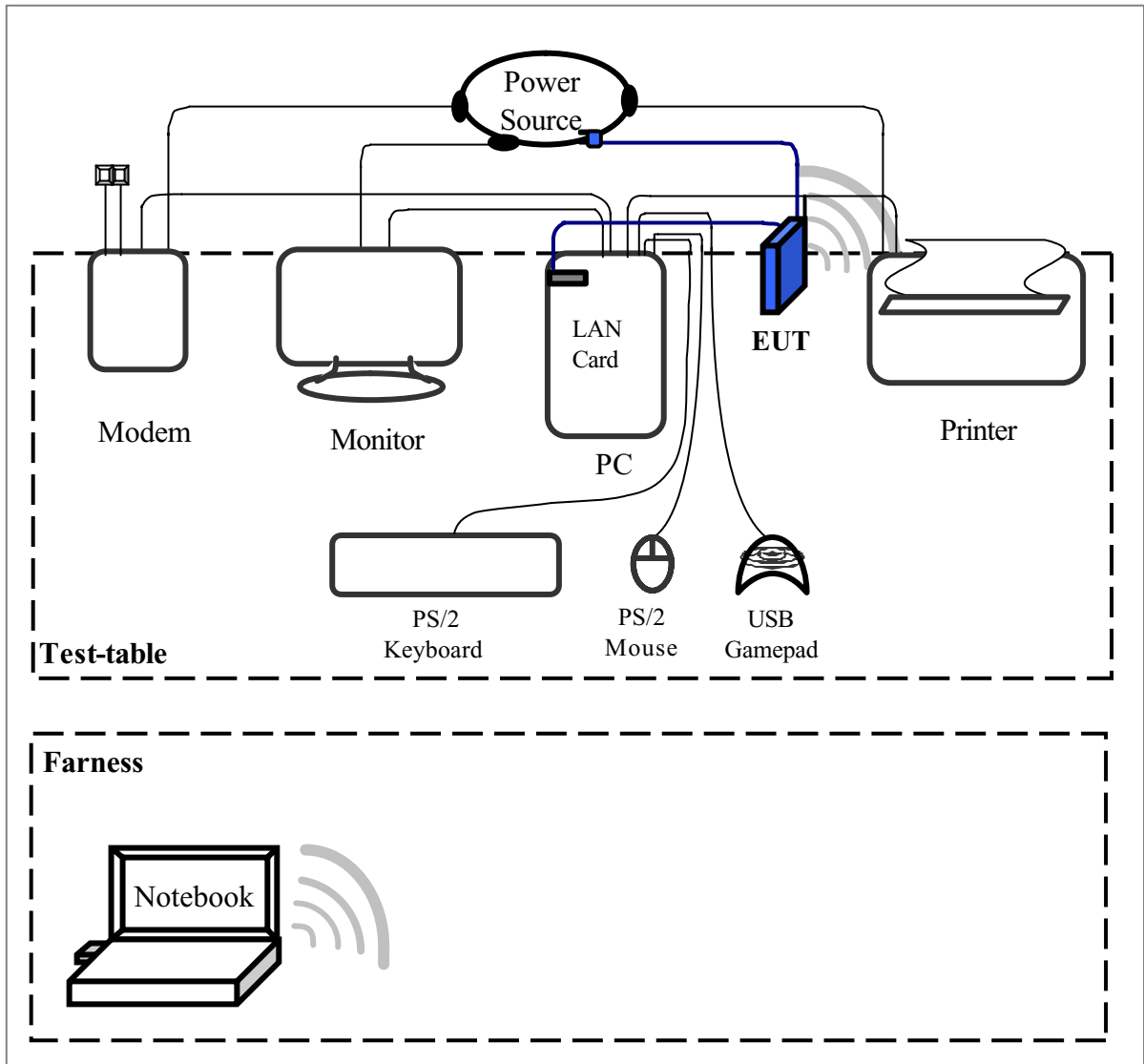

Connections of Equipment

- PC:**
- *Parallel Port --- a printer
 - *VGA Port --- a monitor
 - *Serial Port --- an external modem
 - *USB Port --- a USB gamepad
 - *LAN Interface --- EUT
 - *PS/2-key Port --- a PS/2 keyboard
 - *PS/2-mouse Port --- a PS/2 mouse

1.5.2 Radiated of intentional

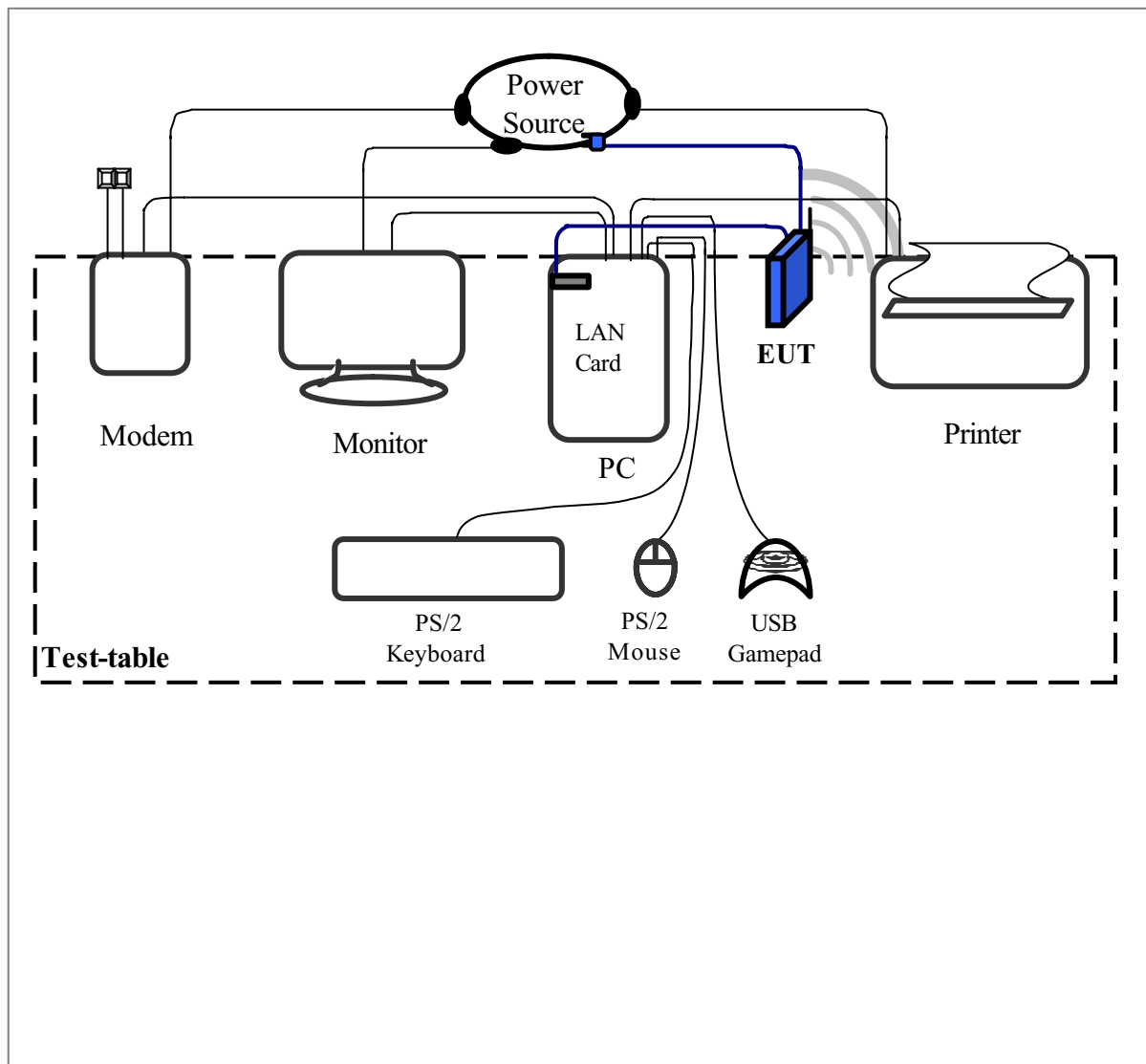

The tests below are carried with the EUT transmitter set at high power in TDD mode. The EUT is forced to select of output power level and channel number by computer.

The setting up procedure was recorded in 1.3 test method.

1.6 Verify the Frequency and Channel

Channel	Frequency (GHz)
1	2.412
2	2.417
3	2.422
4	2.427
5	2.432
6	2.437
7	2.442
8	2.447
9	2.452
10	2.457
11	2.462

Note:

1. This is for confirming that all frequencies are in 2.412GHz to 2.462GHz.
2. Section 15.31(m): Measurements on intentional radiators or receivers shall be performed at three frequencies for operating frequency range over 10 MHz.
(The locations of these frequencies one near the top, one near the middle and one near the bottom.)
3. After test, the EUT operating frequencies are in 2.412GHz to 2.462GHz. So all the items as followed in testing report are need to test these three frequencies:
Top: Channel – 1; Middle: Channel – 6; Bottom: Channel – 11.

1.7 Test Procedure

All measurements contained in this report were performed mainly according to the techniques described in ANSI C63.4 (2003) and the pre-setup was written on 1.3 test method, the detail setup was written on each test item.

1.8 Location of the Test Site

The radiated emissions measurements required by the rules were performed on the **three-meter, Anechoic Chamber (FCC Registration Number: 93906)** maintained by *Training Research Co., Ltd.* 1F, No. 255 Nanyang Street, Shijr, Taipei Hsien 221, Taiwan, R.O.C. Complete description and measurement data have been placed on file with the commission. The conducted power line emissions tests and other test items were performed in a anechoic chamber also located at Training Research Co., Ltd.

No. 255 Nanyang Street, Shijr, Taipei Hsien 221, Taiwan, R.O.C. *Training Research Co., Ltd.* is listed by the FCC as a facility available to do measurement work for others on a contract basis.

1.9 General Test Condition

The conditions under which the EUT operates were varied to determine their effect on the equipment's emission characteristics. The final configuration of the test system and the mode of operation used during these tests were chosen as that which produced the highest emission levels. However, only those conditions, which the EUT was considered likely to encounter in normal use were investigated.

In test, they were set in high power and continuously transmitting mode that controlled by computer. The ch01, ch06 and ch11 of EUT were all tested. The setting up procedure is recorded on 1.3 test method.

II. Section 15.101(a): Equipment authorization of unintentional radiators

The EUT equipped with a LAN interface and should be operated with the computer. It was categorized to *Class B personal computers and peripherals* as cannot be operated stand-alone. The authorization requires **Declaration of Conformity (DoC)** and the items required such as Section15.107 (Conducted limits) and Section15.109 (Radiated emission limits) is same as Section15.207 and 15.247(C).

III. Section 15.203: Antenna requirement

The EUT has a detachable antenna, the antenna is affixed to the EUT using a unique connector, which does not use a standard antenna jack or electrical connector. The antenna requirement stated in Section 15.203 is inapplicable to this EUT.

The custom antenna specification of list as below:

EUT Model	Antenna manufacturer / Antenna model	Antenna connector	Antenna type	Antenna gain
TEW-430APB	WHA YU INDUSTRIAL CO., LTD. C056-510170-A	Detachable Reverse SMA Plug	1 Dipole	1.0 dBi

VI. Section 15.207: Power Line Conducted Emissions for AC Powered Units

4.1 Test Condition & Setup

The power line conducted emission measurements were performed in an anechoic chamber. The EUT was assembled on a wooden table, which is 80 centimeters high, was placed 40 centimeters from the backwall and at least 1 meter from the sidewall.

Power was fed to the EUT from the public utility power grid through a line filter and Line Impedance Stabilization Networks (LISNs). The LISN housing, measuring instrumentation case, ground plane, etc., were electrically bonded together at the same RF potential. The Spectrum analyzer (or EMI receiver) was connected to the AC line through an isolation transformer. The 50-ohm output of the LISN was connected to the spectrum analyzer directly. Conducted emission levels were in the CISPR quasi-peak and average detection mode. The analyzer's 6 dB bandwidth was set to 9 KHz. No post-detector video filter was used.

The spectrum was scanned from 150 KHz to 30 MHz. The physical arrangement of the test system and associated cabling was varied (within the scope of arrangements likely to be encountered in actual use) to determine the effect on the unit's emanations in amplitude and frequency. All spurious emission frequencies were observed. The highest emission amplitudes relative to the appropriate limit were measured and have been recorded in paragraph 4.3

There is a test condition apply in this test item, the test procedure description as <1.3>. Three channels were tested, one in the top (CH01), one in the middle (CH06) and the other in bottom (CH11).

4.2 List of Test Instruments

				Calibration Date
Instrument Name	Model	Brand	Serial No.	Next time
EMI Receiver	8546A	HP	3520A00242	08/05/05
RF Filter Section	85460A	HP	3448A00217	08/05/05
LISN (EUT)	LISN-01	TRC	99-05	10/07/05
LISN (Support E.)	LISN-01	TRC	9912-03, 04	12/21/04
Pre-amplifier	15542 ZFL-500	Mini – Circuits	0 0117	05/20/05
6dB Attenuator	MCL BW-S6W2	Mini – Circuits	9915 – Conducted	05/20/05
10dB Attenuator	A5542 VAT010	Mini – Circuits	0215 – Conducted	05/20/05
Coaxial Cable (2 meter)	A30A30-0058-50FS-2M	Jyebao	SMA-08	05/20/05
Coaxial Cable (1.1 meter)	A30A30-0058-50FS-1M	Jyebao	SMA-09	05/20/05
Coaxial Cable (20 meter)	RG-214/U	Jyebao	NP-01	05/20/05
Coaxial Cable (20 meter)	RG-214/U	Jyebao	NP-02	05/20/05
Auto Switch Box (< 30MHz)	ASB-01	TRC	9904-01	05/20/05

4.3 Test Result of Power Line Conducted Emissions

The following table shows a summary of the highest emissions of power line conducted emissions on the LIVE and NETURAL conductors of the EUT power cord. Show as follows.

Test Conditions: Temperature : 25 °C Humidity : 73 % RH

Test mode: Standby mode (DV-0751AS)

<i>Power Connected Emissions</i>					<i>Class B</i>		
<i>Conductor</i>	<i>Frequency (KHz)</i>	<i>Peak (dBµV)</i>	<i>QP (dBµV)</i>	<i>Average (dBµV)</i>	<i>QP-limit (dBµV)</i>	<i>AVG-limit (dBµV)</i>	<i>Margin (dB)</i>
Line 1	158.000	51.33	---	---	65.77	55.77	-4.44
	274.000	46.50	---	---	62.46	52.46	-5.96
	363.000	44.01	---	---	59.91	49.91	-5.90
	490.000	42.01	---	---	56.29	46.29	-4.28
	1198.000	36.67	---	---	56.00	46.00	-9.33
	13290.000	38.46	---	---	60.00	50.00	-11.54
	19120.000	46.44	---	---	60.00	50.00	-3.56
Line 2	185.000	50.49	---	---	65.00	55.00	-4.51
	255.000	48.55	---	---	63.00	53.00	-4.45
	329.000	46.73	---	---	60.89	50.89	-4.16
	486.485	43.21	37.20	12.81	56.17	46.17	-18.97
	1102.000	37.00	---	---	56.00	46.00	-9.00
	13160.000	37.45	---	---	60.00	50.00	-12.55
	18419.670	48.15	43.56	32.51	60.00	50.00	-16.44

NOTE:

- (1)Margin = Peak Amplitude – Limit, *The reading amplitudes are all under limit.*
- (2)A "+" sign in the margin column means the emission is OVER the Class B Limit and "-" sign of means UNDER the Class B limit

Test mode: IEEE 802.11b, Channel 1 (DV-0751AS)

Power Connected Emissions					Class B		
Conductor	Frequency (KHz)	Peak (dBμV)	QP (dBμV)	Average (dBμV)	QP-limit (dBμV)	AVG-limit (dBμV)	Margin (dB)
Line 1	193.000	49.75	---	---	64.77	46.00	-5.60
	466.000	42.76	---	---	56.97	46.00	-4.01
	610.000	40.47	---	---	56.00	46.00	-6.04
	1155.000	36.60	---	---	56.00	46.00	-5.60
	13360.000	39.01	---	---	60.00	46.00	-5.74
	17800.000	45.77	---	---	60.00	46.00	-4.76
Line 2	177.000	51.60	---	---	65.23	55.23	-3.63
	233.000	49.28	---	---	63.63	53.63	-4.35
	331.000	47.03	---	---	60.83	50.83	-3.80
	569.000	42.46	---	---	56.00	46.00	-3.54
	1059.000	37.47	---	---	56.00	46.00	-8.53
	17530.000	45.87	---	---	60.00	50.00	-4.13

Test mode: IEEE 802.11b, Channel 6 (DV-0751AS)

Power Connected Emissions					Class B		
Conductor	Frequency (KHz)	Peak (dBμV)	QP (dBμV)	Average (dBμV)	QP-limit (dBμV)	AVG-limit (dBμV)	Margin (dB)
Line 1	175.000	50.84	---	---	65.29	46.00	-5.86
	226.000	48.43	---	---	63.83	46.00	-5.06
	461.000	43.16	---	---	57.11	46.00	-5.88
	633.000	39.64	---	---	56.00	46.00	-5.93
	1144.000	36.83	---	---	56.00	46.00	-5.06
	17980.000	45.53	---	---	60.00	46.00	-3.82
Line 2	197.000	50.51	---	---	64.66	54.66	-4.15
	231.000	49.35	---	---	63.69	53.69	-4.34
	311.000	47.39	---	---	61.40	51.40	-4.01
	528.000	42.79	---	---	56.00	46.00	-3.21
	1102.000	37.03	---	---	56.00	46.00	-8.97
	17350.000	46.14	---	---	60.00	50.00	-3.86

Test mode: IEEE 802.11b, Channel 11 (DV-0751AS)

Power Connected Emissions					Class B		
Conductor	Frequency (KHz)	Peak (dBμV)	QP (dBμV)	Average (dBμV)	QP-limit (dBμV)	AVG-limit (dBμV)	Margin (dB)
Line 1	171.000	50.37	---	---	65.40	55.40	-5.03
	220.000	48.30	---	---	64.00	54.00	-5.70
	363.000	43.94	---	---	59.91	49.91	-5.97
	504.000	41.66	---	---	56.00	46.00	-4.34
	1144.000	36.30	---	---	56.00	46.00	-9.70
	17800.000	45.08	---	---	60.00	50.00	-4.92
Line 2	163.000	51.88	---	---	65.63	55.63	-3.75
	236.000	48.98	---	---	63.54	53.54	-4.56
	338.000	46.57	---	---	60.63	50.63	-4.06
	490.000	43.27	---	---	56.29	46.29	-3.02
	703.000	38.48	---	---	56.00	46.00	-7.52
	17170.000	45.39	---	---	60.00	50.00	-4.61

Test mode: IEEE 802.11g, Channel 1 (DV-0751AS)

Power Connected Emissions					Class B		
Conductor	Frequency (KHz)	Peak (dBμV)	QP (dBμV)	Average (dBμV)	QP-limit (dBμV)	AVG-limit (dBμV)	Margin (dB)
Line 1	169.000	51.21	---	---	65.46	55.46	-4.25
	271.000	47.34	---	---	62.54	52.54	-5.20
	417.000	43.56	---	---	58.37	48.37	-4.81
	552.000	41.68	---	---	56.00	46.00	-4.32
	13040.000	39.83	---	---	60.00	50.00	-10.17
	17980.000	45.08	---	---	60.00	50.00	-4.92
Line 2	167.000	51.48	---	---	65.51	55.51	-4.03
	233.000	49.31	---	---	63.63	53.63	-4.32
	308.000	47.32	---	---	61.49	51.49	-4.17
	475.000	43.52	---	---	56.71	46.71	-3.19
	1081.000	37.14	---	---	56.00	46.00	-8.86
	17800.000	45.63	---	---	60.00	50.00	-4.37

Test mode: IEEE 802.11g, Channel 6 (DV-0751AS)

Power Connected Emissions					Class B		
Conductor	Frequency (KHz)	Peak (dBμV)	QP (dBμV)	Average (dBμV)	QP-limit (dBμV)	AVG-limit (dBμV)	Margin (dB)
Line 1	155.000	52.32	---	---	65.86	55.86	-3.54
	262.000	47.39	---	---	62.80	52.80	-5.41
	409.000	43.96	---	---	58.60	48.60	-4.64
	552.000	41.56	---	---	56.00	46.00	-4.44
	1091.000	36.74	---	---	56.00	46.00	-9.26
	17350.000	44.25	---	---	60.00	50.00	-5.75
Line 2	177.000	51.53	---	---	65.23	55.23	-3.70
	302.000	48.11	---	---	61.66	51.66	-3.55
	455.735	44.15	37.40	13.67	57.11	47.11	-19.71
	563.000	42.44	---	---	56.00	46.00	-3.56
	1038.000	37.76	---	---	56.00	46.00	-8.24
	17620.000	45.14	---	---	60.00	50.00	-4.86

Test mode: IEEE 802.11g, Channel 11 (DV-0751AS)

Power Connected Emissions					FCC Class B		
Conductor	Frequency (KHz)	Peak (dBμV)	QP (dBμV)	Average (dBμV)	QP-limit (dBμV)	AVG-limit (dBμV)	Margin (dB)
Line 1	164.000	51.24	---	---	65.60	55.60	-4.36
	212.000	49.33	---	---	64.23	54.23	-4.90
	430.000	43.61	---	---	58.00	48.00	-4.39
	558.000	41.28	---	---	56.00	46.00	-4.72
	1123.000	36.60	---	---	56.00	46.00	-9.40
	17980.000	44.64	---	---	60.00	50.00	-5.36
Line 2	185.000	51.35	---	---	65.00	55.00	-3.65
	214.000	50.35	---	---	64.17	54.17	-3.82
	294.000	48.09	---	---	61.89	51.89	-3.80
	575.000	42.34	---	---	56.00	46.00	-3.66
	1070.000	37.47	---	---	56.00	46.00	-8.53
	17710.000	46.03	---	---	60.00	50.00	-3.97

Test mode: IEEE 802.11b, Channel 1 (DV-051A2S-B25)

Power Connected Emissions					Class B		
Conductor	Frequency (KHz)	Peak (dBμV)	QP (dBμV)	Average (dBμV)	QP-limit (dBμV)	AVG-limit (dBμV)	Margin (dB)
Line 1	155.000	37.67	---	---	65.86	55.86	-18.19
	229.000	27.55	---	---	63.74	53.74	-26.19
	2351.000	21.93	---	---	56.00	46.00	-24.07
	11340.000	36.98	---	---	60.00	50.00	-13.02
	15340.000	37.92	---	---	60.00	50.00	-12.08
	23120.000	31.28	---	---	60.00	50.00	-18.72
Line 2	153.000	38.94	---	---	65.91	55.91	-16.97
	2351.000	23.21	---	---	56.00	46.00	-22.79
	5510.000	27.28	---	---	60.00	50.00	-22.72
	11340.000	41.24	---	---	60.00	50.00	-8.76
	16490.000	37.84	---	---	60.00	50.00	-12.16
	23120.000	31.07	---	---	60.00	50.00	-18.93

Test mode: IEEE 802.11b, Channel 6 (DV-051A2S-B25)

Power Connected Emissions					Class B		
Conductor	Frequency (KHz)	Peak (dBμV)	QP (dBμV)	Average (dBμV)	QP-limit (dBμV)	AVG-limit (dBμV)	Margin (dB)
Line 1	156.000	36.43	---	---	65.83	55.83	-19.40
	226.000	26.68	---	---	63.83	53.83	-27.15
	2351.000	22.62	---	---	56.00	46.00	-23.38
	11780.000	39.76	---	---	60.00	50.00	-10.24
	15040.000	38.15	---	---	60.00	50.00	-11.85
	23120.000	30.84	---	---	60.00	50.00	-19.16
Line 2	152.000	39.71	---	---	65.94	55.94	-16.23
	226.000	27.18	---	---	63.83	53.83	-26.65
	2351.000	23.51	---	---	56.00	46.00	-22.49
	11170.000	41.89	---	---	60.00	50.00	-8.11
	16660.000	39.55	---	---	60.00	50.00	-10.45
	23120.000	31.09	---	---	60.00	50.00	-18.91

Test mode: IEEE 802.11b, Channel 11 (DV-051A2S-B25)

<i>Power Connected Emissions</i>					<i>Class B</i>		
<i>Conductor</i>	<i>Frequency (KHz)</i>	<i>Peak (dBμV)</i>	<i>QP (dBμV)</i>	<i>Average (dBμV)</i>	<i>QP-limit (dBμV)</i>	<i>AVG-limit (dBμV)</i>	<i>Margin (dB)</i>
Line 1	155.000	37.07	---	---	65.86	55.86	-18.79
	231.000	26.72	---	---	63.69	53.69	-26.97
	2351.000	22.50	---	---	56.00	46.00	-23.50
	11780.000	39.73	---	---	60.00	50.00	-10.27
	15940.000	38.76	---	---	60.00	50.00	-11.24
	23120.000	29.37	---	---	60.00	50.00	-20.63
Line 2	155.000	37.05	---	---	65.86	55.86	-18.81
	231.000	27.53	---	---	63.69	53.69	-26.16
	2351.000	23.21	---	---	56.00	46.00	-22.79
	11170.000	41.17	---	---	60.00	50.00	-8.83
	16080.000	38.60	---	---	60.00	50.00	-11.40
	23120.000	31.61	---	---	60.00	50.00	-18.39

Test mode: IEEE 802.11g, Channel 1 (DV-051A2S-B25)

<i>Power Connected Emissions</i>					<i>Class B</i>		
<i>Conductor</i>	<i>Frequency (KHz)</i>	<i>Peak (dBμV)</i>	<i>QP (dBμV)</i>	<i>Average (dBμV)</i>	<i>QP-limit (dBμV)</i>	<i>AVG-limit (dBμV)</i>	<i>Margin (dB)</i>
Line 1	197.000	29.26	---	---	64.66	54.66	-25.40
	216.000	27.58	---	---	64.11	54.11	-26.53
	2351.000	22.20	---	---	56.00	46.00	-23.80
	11610.000	37.28	---	---	60.00	50.00	-12.72
	16830.000	42.51	---	---	60.00	50.00	-7.49
	23120.000	28.44	---	---	60.00	50.00	-21.56
Line 2	203.000	28.70	---	---	64.49	54.49	-25.79
	2351.000	23.21	---	---	56.00	46.00	-22.79
	8830.000	31.63	---	---	60.00	50.00	-18.37
	11500.000	41.17	---	---	60.00	50.00	-8.83
	16230.000	45.28	---	---	60.00	50.00	-4.72
	23120.000	30.23	---	---	60.00	50.00	-19.77

Test mode: IEEE 802.11g, Channel 6 (DV-051A2S-B25)

Power Connected Emissions					Class B		
Conductor	Frequency (KHz)	Peak (dBμV)	QP (dBμV)	Average (dBμV)	QP-limit (dBμV)	AVG-limit (dBμV)	Margin (dB)
Line 1	155.000	35.10	---	---	65.86	55.86	-20.76
	218.000	27.48	---	---	64.06	54.06	-26.58
	2351.000	23.00	---	---	56.00	46.00	-23.00
	11780.000	38.11	---	---	60.00	50.00	-11.89
	15640.000	40.42	---	---	60.00	50.00	-9.58
	23120.000	30.60	---	---	60.00	50.00	-19.40
Line 2	155.000	35.72	---	---	65.86	55.86	-20.14
	233.000	27.90	---	---	63.63	53.63	-25.73
	2351.000	23.46	---	---	56.00	46.00	-22.54
	11940.000	42.01	---	---	60.00	50.00	-7.99
	15790.000	41.68	---	---	60.00	50.00	-8.32
	23120.000	30.19	---	---	60.00	50.00	-19.81

Test mode: IEEE 802.11g, Channel 11 (DV-051A2S-B25)

Power Connected Emissions					FCC Class B		
Conductor	Frequency (KHz)	Peak (dBμV)	QP (dBμV)	Average (dBμV)	QP-limit (dBμV)	AVG-limit (dBμV)	Margin (dB)
Line 1	152.000	37.88	---	---	65.94	55.94	-18.06
	210.000	27.39	---	---	64.29	54.29	-26.90
	5740.000	23.05	---	---	60.00	50.00	-26.95
	11940.000	37.60	---	---	60.00	50.00	-12.40
	15490.000	37.92	---	---	60.00	50.00	-12.08
	23120.000	30.70	---	---	60.00	50.00	-19.30
Line 2	153.000	37.33	---	---	65.91	55.91	-18.58
	226.000	27.69	---	---	63.83	53.83	-26.14
	5510.000	25.70	---	---	60.00	50.00	-24.30
	11340.000	40.16	---	---	60.00	50.00	-9.84
	15790.000	41.54	---	---	60.00	50.00	-8.46
	23120.000	28.33	---	---	60.00	50.00	-21.67

Test mode: IEEE 802.11b, Channel 1 (RH41-0751000DU)

Power Connected Emissions					Class B		
Conductor	Frequency (KHz)	Peak (dBμV)	QP (dBμV)	Average (dBμV)	QP-limit (dBμV)	AVG-limit (dBμV)	Margin (dB)
Line 1	158.000	47.73	---	---	65.77	55.77	-8.04
	195.000	46.18	---	---	64.71	54.71	-8.53
	269.000	44.29	---	---	62.60	52.60	-8.31
	447.000	40.84	---	---	57.51	47.51	-6.67
	581.000	39.17	---	---	56.00	46.00	-6.83
	17170.000	41.73	---	---	60.00	50.00	-8.27
Line 2	161.000	47.06	---	---	65.69	55.69	-8.63
	203.000	45.04	---	---	64.49	54.49	-9.45
	269.000	42.14	---	---	62.60	52.60	-10.46
	348.000	40.03	---	---	60.34	50.34	-10.31
	592.000	35.38	---	---	56.00	46.00	-10.62
	18670.000	42.94	---	---	60.00	50.00	-7.06

Test mode: IEEE 802.11b, Channel 6 (RH41-0751000DU)

Power Connected Emissions					Class B		
Conductor	Frequency (KHz)	Peak (dBμV)	QP (dBμV)	Average (dBμV)	QP-limit (dBμV)	AVG-limit (dBμV)	Margin (dB)
Line 1	158.000	47.74	---	---	65.77	55.77	-8.03
	277.000	44.01	---	---	62.37	52.37	-8.36
	384.000	41.61	---	---	59.31	49.31	-7.70
	542.000	39.40	---	---	56.00	46.00	-6.60
	622.000	37.76	---	---	56.00	46.00	-8.24
	17170.000	41.15	---	---	60.00	50.00	-8.85
Line 2	164.000	47.01	---	---	65.60	55.60	-8.59
	203.000	45.04	---	---	64.49	54.49	-9.45
	338.000	40.14	---	---	60.63	50.63	-10.49
	598.000	35.43	---	---	56.00	46.00	-10.57
	13290.000	38.30	---	---	60.00	50.00	-11.70
	17800.000	41.86	---	---	60.00	50.00	-8.14

Test mode: IEEE 802.11b, Channel 11 (RH41-0751000DU)

Power Connected Emissions					Class B		
Conductor	Frequency (KHz)	Peak (dBμV)	QP (dBμV)	Average (dBμV)	QP-limit (dBμV)	AVG-limit (dBμV)	Margin (dB)
Line 1	179.000	46.99	---	---	65.17	55.17	-8.18
	297.000	43.63	---	---	61.80	51.80	-8.17
	421.000	41.35	---	---	58.26	48.26	-6.91
	480.000	40.44	---	---	56.57	46.57	-6.13
	13290.000	38.87	---	---	60.00	50.00	-11.13
	17000.000	41.34	---	---	60.00	50.00	-8.66
Line 2	166.000	46.59	---	---	65.54	55.54	-8.95
	205.000	44.69	---	---	64.43	54.43	-9.74
	329.000	40.08	---	---	60.89	50.89	-10.81
	598.000	35.08	---	---	56.00	46.00	-10.92
	12680.000	38.32	---	---	60.00	50.00	-11.68
	17800.000	43.63	---	---	60.00	50.00	-6.37

Test mode: IEEE 802.11g, Channel 1 (RH41-0751000DU)

Power Connected Emissions					Class B		
Conductor	Frequency (KHz)	Peak (dBμV)	QP (dBμV)	Average (dBμV)	QP-limit (dBμV)	AVG-limit (dBμV)	Margin (dB)
Line 1	164.000	47.76	---	---	65.60	55.60	-7.84
	208.000	46.25	---	---	64.34	54.34	-8.09
	285.000	43.94	---	---	62.14	52.14	-8.20
	447.000	41.38	---	---	57.51	47.51	-6.13
	587.000	39.10	---	---	56.00	46.00	-6.90
	17440.000	40.64	---	---	60.00	50.00	-9.36
Line 2	171.000	46.73	---	---	65.40	55.40	-8.67
	300.000	41.17	---	---	61.71	51.71	-10.54
	439.000	36.05	---	---	57.74	47.74	-11.69
	598.000	35.36	---	---	56.00	46.00	-10.64
	13780.000	38.17	---	---	60.00	50.00	-11.83
	17800.000	42.15	---	---	60.00	50.00	-7.85

Test mode: IEEE 802.11g, Channel 6 (RH41-0751000DU)

Power Connected Emissions					Class B		
Conductor	Frequency (KHz)	Peak (dBμV)	QP (dBμV)	Average (dBμV)	QP-limit (dBμV)	AVG-limit (dBμV)	Margin (dB)
Line 1	172.000	47.39	---	---	65.37	55.37	-7.98
	222.000	45.75	---	---	63.94	53.94	-8.19
	305.000	43.56	---	---	61.57	51.57	-8.01
	426.000	41.38	---	---	58.11	48.11	-6.73
	587.000	38.98	---	---	56.00	46.00	-7.02
	945.000	41.90	---	---	60.00	50.00	-8.10
Line 2	169.000	46.54	---	---	65.46	55.46	-8.92
	257.000	42.34	---	---	62.94	52.94	-10.60
	394.000	38.30	---	---	59.03	49.03	-10.73
	598.000	35.17	---	---	56.00	46.00	-10.83
	13430.000	38.25	---	---	60.00	50.00	-11.75
	17260.000	41.92	---	---	60.00	50.00	-8.08

Test mode: IEEE 802.11g, Channel 11 (RH41-0751000DU)

Power Connected Emissions					FCC Class B		
Conductor	Frequency (KHz)	Peak (dBμV)	QP (dBμV)	Average (dBμV)	QP-limit (dBμV)	AVG-limit (dBμV)	Margin (dB)
Line 1	172.000	47.41	---	---	65.37	55.37	-7.96
	259.000	44.99	---	---	62.89	52.89	-7.90
	370.000	42.16	---	---	59.71	49.71	-7.55
	452.000	40.77	---	---	57.37	47.37	-6.60
	13780.000	38.93	---	---	60.00	50.00	-11.07
	17260.000	41.69	---	---	60.00	50.00	-8.31
Line 2	153.000	47.27	---	---	65.91	55.91	-8.64
	216.000	44.29	---	---	64.11	54.11	-9.82
	370.000	38.98	---	---	59.71	49.71	-10.73
	587.000	35.48	---	---	56.00	46.00	-10.52
	13430.000	39.78	---	---	60.00	50.00	-10.22
	18320.000	43.08	---	---	60.00	50.00	-6.92

Test mode: IEEE 802.11b, Channel 1 (RH41-0501200DU)

Power Connected Emissions					Class B		
Conductor	Frequency (KHz)	Peak (dBμV)	QP (dBμV)	Average (dBμV)	QP-limit (dBμV)	AVG-limit (dBμV)	Margin (dB)
Line 1	155.000	48.27	---	---	65.86	55.86	-7.59
	174.000	47.78	---	---	65.31	55.31	-7.53
	226.000	45.09	---	---	63.83	53.83	-8.74
	447.000	38.11	---	---	57.51	47.51	-9.40
	12060.000	40.77	---	---	60.00	50.00	-9.23
	18920.000	32.53	---	---	60.00	50.00	-17.47
Line 2	158.000	47.48	---	---	65.77	55.77	-8.29
	185.000	46.21	---	---	65.00	55.00	-8.79
	308.000	41.19	---	---	61.49	51.49	-10.30
	569.000	34.02	---	---	56.00	46.00	-11.98
	12060.000	42.81	---	---	60.00	50.00	-7.19
	18920.000	34.88	---	---	60.00	50.00	-15.12

Test mode: IEEE 802.11b, Channel 6 (RH41-0501200DU)

Power Connected Emissions					Class B		
Conductor	Frequency (KHz)	Peak (dBμV)	QP (dBμV)	Average (dBμV)	QP-limit (dBμV)	AVG-limit (dBμV)	Margin (dB)
Line 1	169.000	47.66	---	---	65.46	55.46	-7.80
	236.000	44.81	---	---	63.54	53.54	-8.73
	345.000	41.40	---	---	60.43	50.43	-9.03
	421.000	38.92	---	---	58.26	48.26	-9.34
	12560.000	40.21	---	---	60.00	50.00	-9.79
	18410.000	33.63	---	---	60.00	50.00	-16.37
Line 2	164.000	47.10	---	---	65.60	55.60	-8.50
	187.000	46.04	---	---	64.94	54.94	-8.90
	311.000	40.84	---	---	61.40	51.40	-10.56
	563.000	33.92	---	---	56.00	46.00	-12.08
	12680.000	43.07	---	---	60.00	50.00	-6.93
	17440.000	35.46	---	---	60.00	50.00	-14.54

Test mode: IEEE 802.11b, Channel 11 (RH41-0501200DU)

Power Connected Emissions					Class B		
Conductor	Frequency (KHz)	Peak (dBμV)	QP (dBμV)	Average (dBμV)	QP-limit (dBμV)	AVG-limit (dBμV)	Margin (dB)
Line 1	164.000	47.74	---	---	65.60	55.60	-7.86
	233.000	44.69	---	---	63.63	53.63	-8.94
	297.000	43.02	---	---	61.80	51.80	-8.78
	387.000	40.01	---	---	59.23	49.23	-9.22
	12250.000	40.03	---	---	60.00	50.00	-9.97
	17980.000	33.37	---	---	60.00	50.00	-16.63
Line 2	158.000	47.36	---	---	65.77	55.77	-8.41
	222.000	44.17	---	---	63.94	53.94	-9.77
	308.000	40.89	---	---	61.49	51.49	-10.60
	558.000	33.99	---	---	56.00	46.00	-12.01
	12060.000	42.51	---	---	60.00	50.00	-7.49
	18150.000	35.21	---	---	60.00	50.00	-14.79

Test mode: IEEE 802.11g, Channel 1 (RH41-0501200DU)

Power Connected Emissions					Class B		
Conductor	Frequency (KHz)	Peak (dBμV)	QP (dBμV)	Average (dBμV)	QP-limit (dBμV)	AVG-limit (dBμV)	Margin (dB)
Line 1	163.000	47.90	---	---	65.63	55.63	-7.73
	216.000	45.36	---	---	64.11	54.11	-8.75
	320.000	42.07	---	---	61.14	51.14	-9.07
	645.000	34.66	---	---	56.00	46.00	-11.34
	11290.000	39.59	---	---	60.00	50.00	-10.41
	17710.000	31.87	---	---	60.00	50.00	-18.13
Line 2	166.000	46.94	---	---	65.54	55.54	-8.60
	218.000	43.94	---	---	64.06	54.06	-10.12
	300.000	41.73	---	---	61.71	51.71	-9.98
	563.000	33.99	---	---	56.00	46.00	-12.01
	12060.000	43.52	---	---	60.00	50.00	-6.48
	18580.000	32.83	---	---	60.00	50.00	-17.17

Test mode: IEEE 802.11g, Channel 6 (RH41-0501200DU)

Power Connected Emissions					Class B		
Conductor	Frequency (KHz)	Peak (dBμV)	QP (dBμV)	Average (dBμV)	QP-limit (dBμV)	AVG-limit (dBμV)	Margin (dB)
Line 1	169.000	47.74	---	---	65.46	55.46	-7.72
	243.000	44.64	---	---	63.34	53.34	-8.70
	326.000	41.96	---	---	60.97	50.97	-9.01
	417.000	39.31	---	---	58.37	48.37	-9.06
	12250.000	39.08	---	---	60.00	50.00	-10.92
	17080.000	32.84	---	---	60.00	50.00	-17.16
Line 2	163.000	46.92	---	---	65.63	55.63	-8.71
	187.000	45.77	---	---	64.94	54.94	-9.17
	291.000	41.19	---	---	61.97	51.97	-10.78
	558.000	33.83	---	---	56.00	46.00	-12.17
	11830.000	43.49	---	---	60.00	50.00	-6.51
	17890.000	33.67	---	---	60.00	50.00	-16.33

Test mode: IEEE 802.11g, Channel 11 (RH41-0501200DU)

Power Connected Emissions					FCC Class B		
Conductor	Frequency (KHz)	Peak (dBμV)	QP (dBμV)	Average (dBμV)	QP-limit (dBμV)	AVG-limit (dBμV)	Margin (dB)
Line 1	163.000	47.74	---	---	65.63	55.63	-7.89
	220.000	45.42	---	---	64.00	54.00	-8.58
	305.000	42.37	---	---	61.57	51.57	-9.20
	391.000	40.30	---	---	59.11	49.11	-8.81
	12380.000	39.29	---	---	60.00	50.00	-10.71
	17710.000	33.10	---	---	60.00	50.00	-16.90
Line 2	164.000	47.11	---	---	65.60	55.60	-8.49
	216.000	44.35	---	---	64.11	54.11	-9.76
	314.000	40.84	---	---	61.31	51.31	-10.47
	558.000	34.16	---	---	56.00	46.00	-11.84
	12680.000	42.69	---	---	60.00	50.00	-7.31
	17530.000	33.98	---	---	60.00	50.00	-16.02

V. Section 15.247 (a): Technical description of the EUT

Direct Sequence System is a spread spectrum system in which the carrier has been modulated by a high speed spreading code and an information data stream. The high speed code sequence dominates the “modulating function” and is the direct cause of the wide spreading of the transmitted signal. In the operational description demonstrates the operation principles of the Baseband processor employed by the EUT, shows that which is a complete DSSS baseband processor and meets the definition of the direct sequence spread spectrum system.

VI. Section 15.247(a)(2): Bandwidth for Direct Sequence System

6.1 Test Condition & Setup

The transmitter bandwidth measurements were performed by the contact manner. The EUT was set to transmit continuously, also various channels were investigated to find the maximum occupied bandwidth. The output of the EUT was connected to the spectrum analyzer. The bandwidth of the fundamental frequency is observed by the spectrum analyzer with 100kHz RBW and 100kHz VBW.

6.2 Test Instruments Configuration

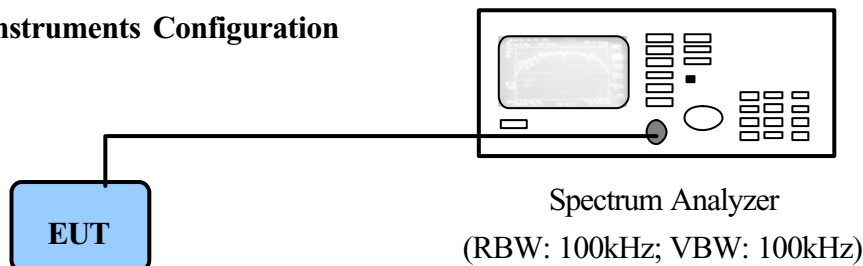

P.S.: PC to control the EUT at maximal power output and channel Number and set antenna kit

6.3 List of Test Instruments

Instrument Name	Model No.	Brand	Serial No.	Next time
Spectrum Analyzer	MS2665C	ANRITSU	6200175476	12/30/04

6.4 Test Result of Bandwidth

Channel	802.11b	802.11g
01	12.96 MHz	16.76 MHz
06	12.96 MHz	16.80 MHz
11	12.92 MHz	16.76 MHz

Note: 1. The data in the above table are summarizing the following attachment spectrum analyzer hard copy. According to the guidance, we'd made the measurement with the spectrum analyzer's resolution bandwidth (RBW)=100kHz and set the $span \gg RBW$. The results show the measured 6dB bandwidth comply with the minimum 500kHz requirement.

2. The attachments show these on the following pages.

6dB Bandwidth of Channel 1 (The minimum 6dB BW at least 500kHz)

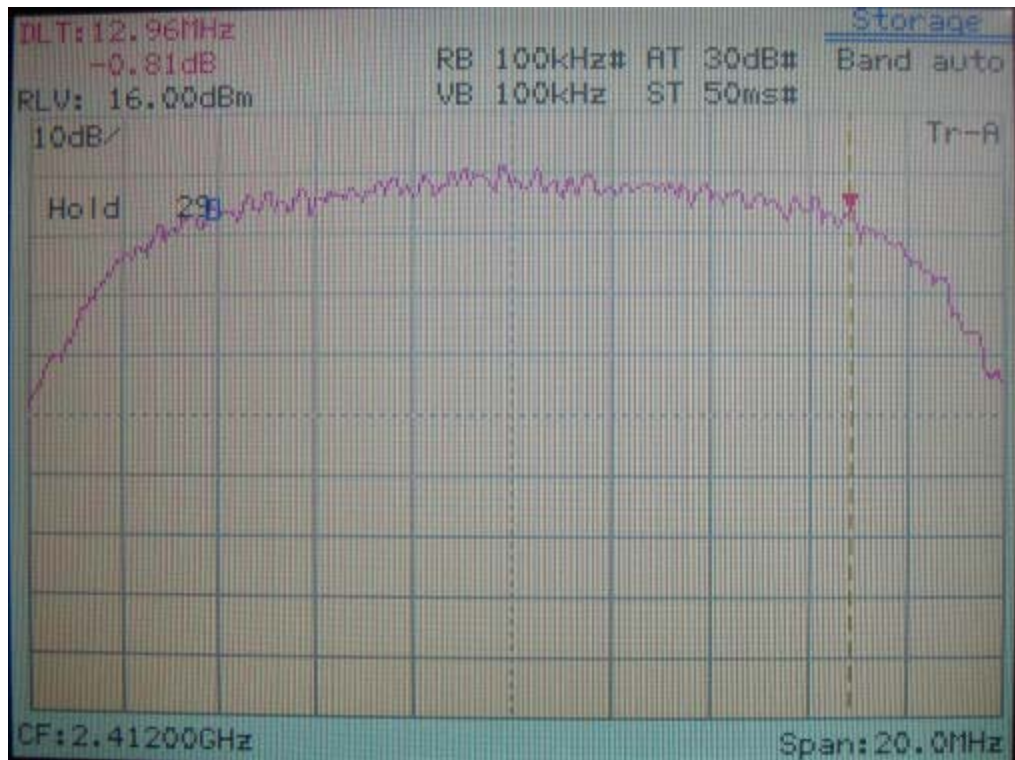

IEEE 802.11b

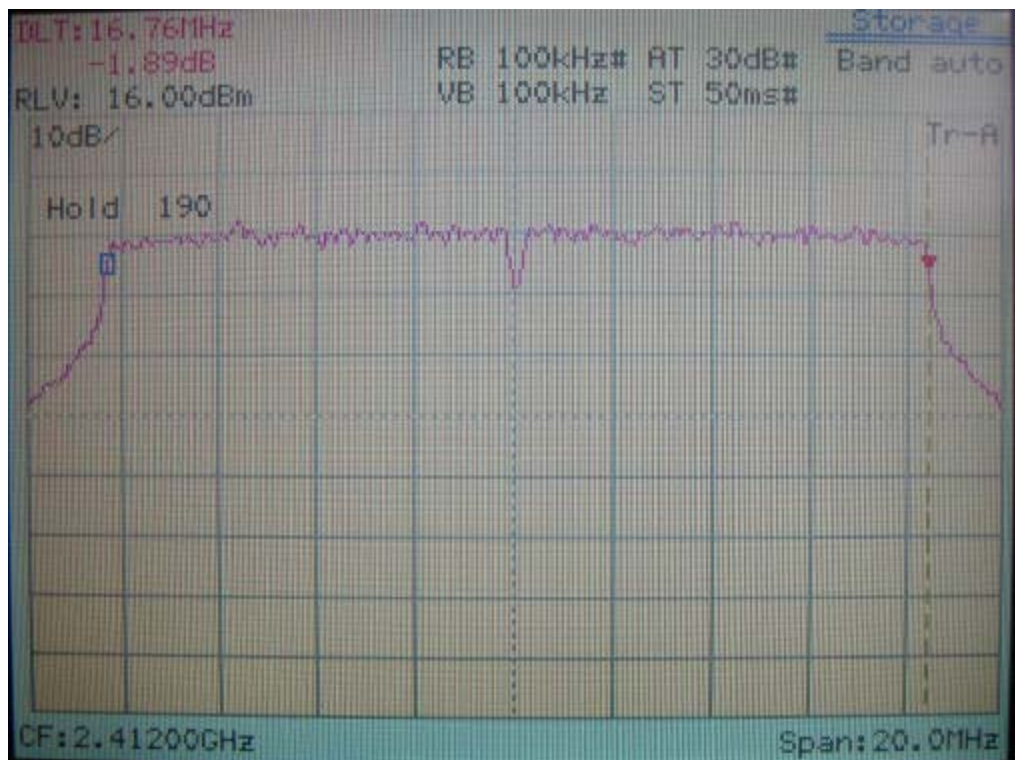

IEEE 802.11g

6dB Bandwidth of Channel 6 (The minimum 6dB BW at least 500kHz)

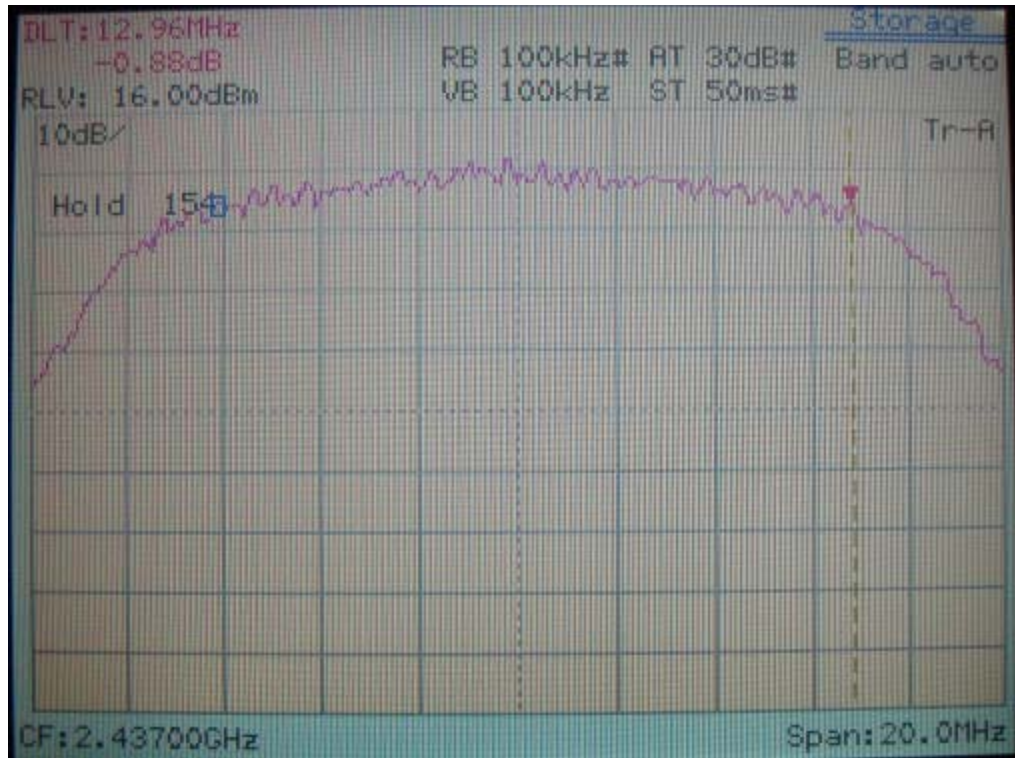

IEEE 802.11b

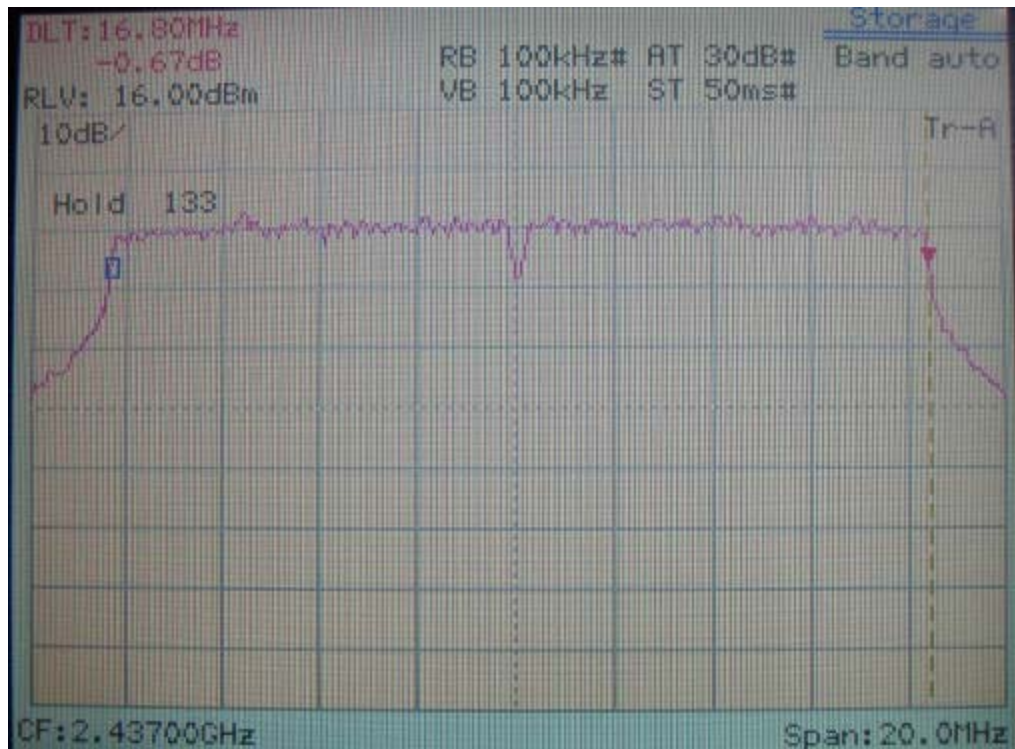

IEEE 802.11g

6dB Bandwidth of Channel 11 (The minimum 6dB BW at least 500kHz)

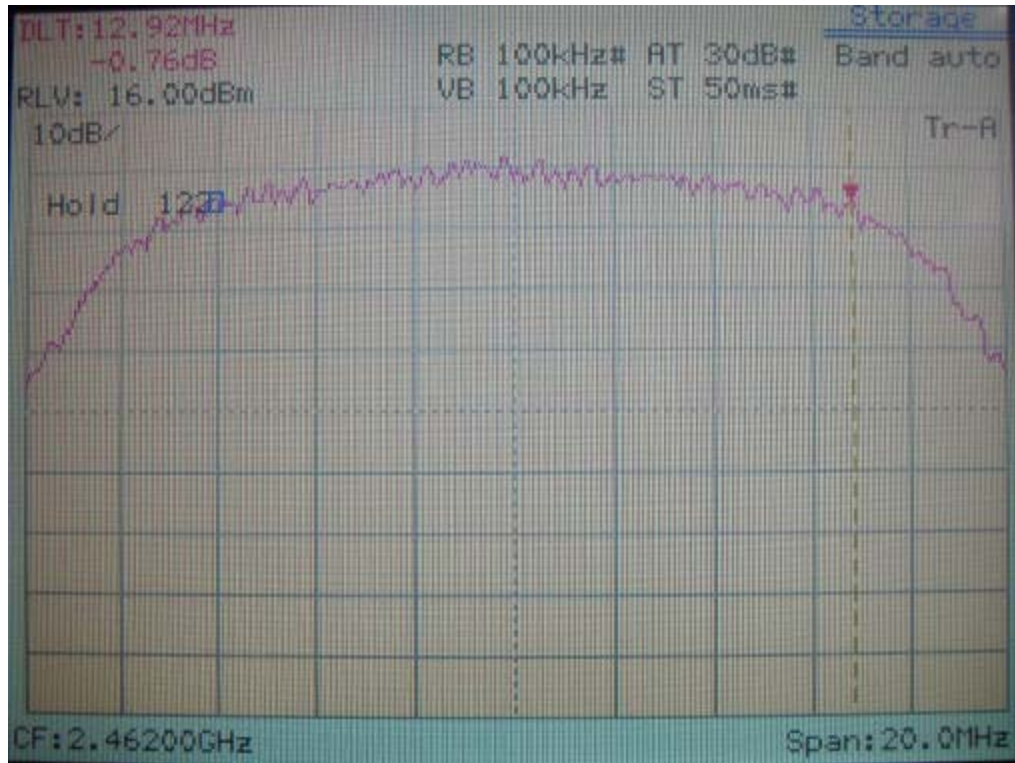

IEEE 802.11b

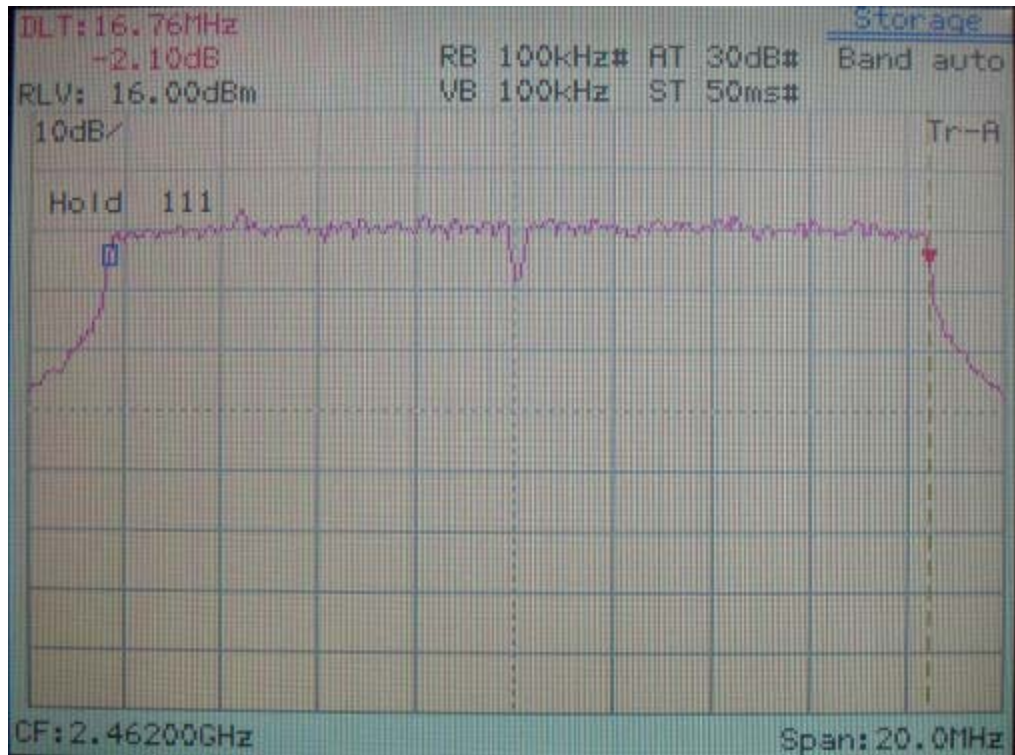

IEEE 802.11g

VII. Section 15.247(b): Power Output

7.1 Test Condition & Setup

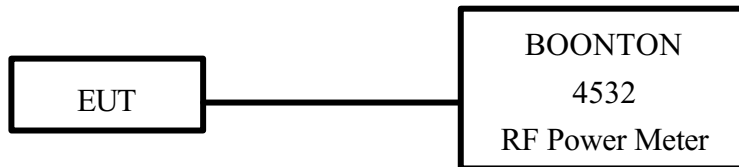

1. The output of the transmitter is connected to the BOONTON RF Power Meter.
2. The calibration is performed before every test. The values of the output power of the EUT will shown in the dBm directly are the transmitter output peak power. Recording as follows.

7.2 List of Test Instruments

Instrument Name	Model	Brand	Serial No.	Next time
RF Power Meter	4532	BOONTON	117501	04/16/05
Peak Power Sensor	57340	BOONTON	2696	04/16/05

7.3 Test Result

<p>Formula: $RF\ Output\ of\ EUT + Cable\ Loss = Output\ Peak\ Power$</p>
--

IEEE 802.11b

Channel	RF Output	Cable Loss	Output Peak Power	
	dBm	dBm	dBm	mW
CH 01	18.61	0.70	19.31	85.31
CH 06	19.01	0.70	19.71	93.54
CH 11	19.30	0.70	20.00	100.00

IEEE 802.11g

Channel	RF Output	Cable Loss	Output Peak Power	
	dBm	dBm	dBm	mW
CH 01	13.97	0.70	14.67	29.31
CH 06	14.45	0.70	15.15	32.73
CH 11	14.76	0.70	15.46	35.16

VIII. Section 15.247 (C): Spurious Emissions (Radiated)

8.1 Test Condition & Setup

We'd performed the test by the *radiated emission* skill: The EUT was placed in an anechoic chamber, and set the EUT transmitting continuously and scanned at 3-meter distance to determine its emission characteristics. The physical arrangement of the EUT was varied (within the scope of arrangements likely to be encountered in actual use) to determine the effect on the unit's emanations in amplitude, directivity, and frequency. The exact system configuration, which produced the highest emissions was noted so it could be reproduced later during the final tests. For the measurement above 1GHz, according to the guidance we'd set the spectrum analyzer's 6dB bandwidth RBW to 1MHz.

This was done to ensure that the final measurements would demonstrate the worst-case interference potential of the EUT.

Final radiation measurements were made on a three-meter, anechoic chamber. The EUT system was placed on a nonconductive turntable, which is 0.8 meters height, top surface 1.0 x 1.5 meter.

The spectrum was examined from 30 MHz to 1000 MHz using an Hewlett Packard 85460A EMI Receiver, SCHWARZECK whole range Small Biconical Antenna (Model No.: UBAA9114 & BBVU9135) is used to measure frequency from 30 MHz to 1GHz. The final test is used the HP 85460A spectrum and 8564E spectrum was examined from 1GHz to 25GHz using an Hewlett Packard Spectrum Analyzer, EMCO/HP Horn Antenna (Model 3115 / 84125-80008) for 1G - 25GHz.

At each frequency, the EUT was rotated 360 degrees, and the antenna was raised and lowered from one to four meters to find the maximum emission levels. Measurements were taken using both horizontal and vertical antenna polarization.

Appropriate preamplifiers were used for improving sensitivity and precautions were taken to avoid overloading or desensitizing the spectrum analyzer. There are two spectrum analyzers use on this testing, HP 85460A for frequency 30MHz to 1000MHz, and 8564E for frequency 1GHz to 25GHz. No post-detector video filters were used in the test. The spectrum analyzer's 6dB bandwidth was set to 120KHz (spectrum was examined from 30 MHz to 1000 MHz), the spectrum analyzer's 6 dB bandwidth was set to 1 MHz (spectrum was examined from 1GHz to 25GHz) and the analyzer was operated in the maximum hold mode. There is a test condition applies in this test item, the test procedure description as the following:

Three channels were tested, one in the top (CH01), one in the middle (CH06) and the other in bottom (CH11). The setting up procedure is recorded on <1.3>

With the transmitter operating from a AC source and using the internal of EUT, radiates spurious emissions falling within the restricted bands of 15.209 were measured at operating frequencies corresponding to upper, middle and bottom channels in the 2400 ~ 2483.5 MHz band.

The actual field intensity in decibels referenced to 1 microvolt per meter (dB μ V/m) is determined by algebraically adding the measured reading in dB μ V, the antenna factor (dB), and cable loss (dB) at the appropriate frequency. Since the EUT was set to transmit continuously, no *duty cycle* is present.

For frequency between 30MHz to 1000MHz

$$F_{Ia} \text{ (dB}\mu\text{V/m)} = F_{Ir} \text{ (dB}\mu\text{V)} + \text{Correction Factors}$$

F_{Ia} : Actual Field Intensity

F_{Ir} : Reading of the Field Intensity

$$\text{Correction Factors} = \text{Antenna Factor} + (\text{Cable Loss} - \text{Amplifier Gain}) + \text{Switching Box Loss}$$

For frequency between 1GHz to 25GHz

$$F_{Ia} \text{ (dB}\mu\text{V/m)} = F_{Ir} \text{ (dB}\mu\text{V)} + \text{Correction Factor}$$

F_{Ia} : Actual Field Intensity

F_{Ir} : Reading of the Field Intensity

$$\text{Correction Factors} = \text{Antenna Factor} + (\text{Cable Loss} - \text{Amplifier Gain}) + \text{Switching Box Loss}$$

8.2 List of Test Instruments

				Calibration Date
Instrument Name	Model	Brand	Serial No.	Next time
EMI Receiver	8546A	HP	3520A00242	08/05/05
RF Filter Section	85460A	HP	3448A00217	08/05/05
Small Biconical Antenna	UBAA9114 & BBVU9135	SCHWARZECK	127	10/11/05
Pre-amplifier	PA1F	TRC	1FAC	05/20/05
Auto Switch Box (>30MHz)	ASB-01	TRC	9904-01	05/20/05
Coaxial Cable (Double shielded, 15 meter)	A30A30-0058-50FS-15M	JYEBAO	SMA-01	05/20/05
Coaxial Cable (1.1 meter)	A30A30-0058-50FS-1M	JYEBAO	SMA-02	05/20/05
Spectrum Analyzer	8564E	HP	3720A00840	08/13/05
Microwave Preampfier	84125C	HP	US36433002	08/13/05
Horn Antenna	3115	EMCO	9104-3668	12/18/04
Standard Guide Horn Antenna	84125-80008	HP	18-26.5GHz	12/18/04
Standard Guide Horn Antenna	84125-80001	HP	26.5-40GHz	12/18/04
Horn Antenna	1196E (3115)	HP (EMCO)	9704-5178	12/12/04
Pre-amplifier	PA2F	TRC	2F1GZ	03/20/05
Coaxial Cable (3 miter)	A30A30-0058-50FST118	JYEBAO	MSA-05	03/20/05
Coaxial Cable (1 meter)	A30A30-0058-50FST118	JYEBAO	MSA-04	03/20/05

8.3 Test Result of Spurious Radiated Emissions

The highest peak values of radiated emissions from the EUT at various antenna heights, antenna polarizations, EUT orientation, etc. are recorded on the following.

Test Conditions: Temperature : 25 ° C Humidity : 73 % RH

Test mode: Standby mode for 30MHz to 1GHz [Horizontal]

Radiated Emission				Correction Factors <i>(dB)</i>	Corrected Amplitude <i>(dBμV/m)</i>	Class B (3 m)	
Frequency (MHz)	Amplitude (dBμV)	Ant. H. (m)	Table (°)			Limit (dBμV/m)	Margin (dB)
176.71	38.74	1.00	244	-3.77	34.97	43.50	-8.53
190.05	38.74	1.00	273	-3.66	35.08	43.50	-8.42
253.10	42.23	1.00	235	-4.08	38.15	46.00	-7.85
398.60	39.66	1.00	226	-1.05	38.61	46.00	-7.39
528.34	31.46	1.00	334	4.10	35.56	46.00	-10.44
750.23	25.72	1.00	252	10.42	36.14	46.00	-9.86

Test mode: Standby mode for 30MHz to 1GHz [Vertical]

Radiated Emission				Correction Factors <i>(dB)</i>	Corrected Amplitude <i>(dBμV/m)</i>	Class B (3 m)	
Frequency (MHz)	Amplitude (dBμV)	Ant. H. (m)	Table (°)			Limit (dBμV/m)	Margin (dB)
253.10	41.58	1.00	221	-4.08	37.50	46.00	-8.50
387.69	42.35	1.00	232	-1.43	40.92	46.00	-5.08
496.81	38.97	1.00	235	2.78	41.75	46.00	-4.25
660.50	31.29	1.00	310	8.70	39.99	46.00	-6.01
750.23	28.24	1.00	240	10.42	38.66	46.00	-7.34
792.66	29.24	1.00	322	11.43	40.67	46.00	-5.33

Note:

1. Margin = Amplitude – limit, *if margin is minus means under limit.*
2. Corrected Amplitude = Reading Amplitude + Correction Factors
3. Correction factor = Antenna factor + (Cable Loss – Amplitude gain) + Switching Box Loss

Test mode: Standby mode for 1GHz to 25GHz [Horizontal]

Frequency	Ant. H.	Table	Amplitude		Correction Factor	Corrected Amplitude		Limit		Margin
			Peak / Ave.			Peak / Ave.		Peak / Ave.		
MHz	m	degree	dBμV		dB/m	dBμV/m		dBμV/m		dB
3330.42	1.00	159	28.24	---	9.96	38.20	---	73.96	53.96	-15.76
4924.17	1.00	325	28.24	---	15.24	43.48	---	73.96	53.96	-10.48
9847.92	1.00	197	28.08	27.24	23.12	51.20	50.36	73.96	53.96	-3.60
12170.42	1.00	264	25.90	---	20.57	46.47	---	73.96	53.96	-7.49

Test mode: Standby mode for 1GHz to 25GHz [Vertical]

Frequency	Ant. H.	Table	Amplitude		Correction Factor	Corrected Amplitude		Limit		Margin
			Peak / Ave.			Peak / Ave.		Peak / Ave.		
MHz	m	degree	dBμV		dB/m	dBμV/m		dBμV/m		dB
3989.17	1.00	235	26.90	---	12.45	39.35	---	73.96	53.96	-14.61
4924.17	1.00	0	26.24	---	15.24	41.48	---	73.96	53.96	-12.48
7622.92	1.00	360	20.07	---	22.69	42.76	---	73.96	53.96	-11.20
12963.75	1.00	252	26.41	---	20.61	47.02	---	73.96	53.96	-6.94

Note:

1. Margin = Corrected - Limit.
2. The EUT utilizes a *permanently attached antenna*. In addition the spurious RF radiated emissions levels do comply with the *20dBc limit* both at its bandedges and other spurious emissions.
3. As stated in Section 15.35(b), for any frequencies above 1000MHz, radiated limits shown are based upon the use of measurement instrumentation employing an average detector function. As the results of our test, the peak amplitudes are already below the FCC limit. Thus the average amplitudes of the rest are omitted.

Test mode: IEEE 802.11b CH01 for 30MHz to 1GHz [Horizontal]

Radiated Emission				Correction Factors	Corrected Amplitude	Class B (3 m)	
Frequency (MHz)	Amplitude (dBµV)	Ant. H. (m)	Table (°)			Limit (dBµV/m)	Margin (dB)
179.14	39.19	1.00	144	-3.76	35.43	43.50	-8.07
254.31	41.72	1.00	225	-4.10	37.62	46.00	-8.38
267.65	40.93	1.00	107	-4.20	36.73	46.00	-9.27
399.81	39.50	1.00	228	-1.01	38.49	46.00	-7.51
498.02	34.49	1.00	219	2.83	37.32	46.00	-8.68
750.23	26.66	1.00	235	10.42	37.08	46.00	-8.92

Test mode: IEEE 802.11b CH01 for 30MHz to 1GHz [Vertical]

Radiated Emission				Correction Factors	Corrected Amplitude	Class B (3 m)	
Frequency (MHz)	Amplitude (dBµV)	Ant. H. (m)	Table (°)			Limit (dBµV/m)	Margin (dB)
154.31	40.72	1.00	221	-4.10	36.62	46.00	-9.38
376.77	44.02	1.00	253	-1.80	42.22	46.00	-3.78
442.25	39.80	1.00	215	0.70	40.50	46.00	-5.50
498.02	39.90	1.00	235	2.83	42.73	46.00	-3.27
660.50	30.05	1.00	322	8.70	38.75	46.00	-7.25
792.66	29.27	1.00	304	11.43	40.70	46.00	-5.30

Test mode: IEEE 802.11b CH01 for 1GHz to 25GHz [Horizontal]

Frequency	Ant. H.	Table	Amplitude		Correction Factor	Corrected Amplitude		Limit		Margin
			Peak / Ave.			Peak / Ave.		Peak / Ave.		
MHz	m	degree	dBμV		dB/m	dBμV/m		dBμV/m		dB
1820.80	1.00	345	40.83	34.67	10.89	51.72	45.56	73.96	53.96	-8.40
2447.92	1.00	135	38.67	---	9.34	48.01	---	73.96	53.96	-5.95
2595.83	1.00	309	36.83	---	9.67	46.50	---	73.96	53.96	-7.46
4823.12	1.00	160	42.27	---	3.76	46.03	---	73.96	53.96	-7.93
9647.92	1.00	88	41.78	39.44	11.46	53.24	50.90	73.96	53.96	-3.06
12061.04	1.00	260	38.10	---	9.81	47.91	---	73.96	53.96	-6.05

Test mode: IEEE 802.11b CH01 for 1GHz to 25GHz [Vertical]

Frequency	Ant. H.	Table	Amplitude		Correction Factor	Corrected Amplitude		Limit		Margin
			Peak / Ave.			Peak / Ave.		Peak / Ave.		
MHz	m	degree	dBμV		dB/m	dBμV/m		dBμV/m		dB
1820.79	1.00	223	42.50	36.17	10.89	53.39	47.06	73.96	53.96	-6.90
2456.76	1.00	22	43.84	32.33	9.37	53.21	41.70	73.96	53.96	-12.26
4823.12	1.00	157	45.10	---	3.76	48.86	---	73.96	53.96	-5.10
7233.75	1.00	167	36.11	---	10.07	46.18	---	73.96	53.96	-7.78
9650.42	1.00	39	35.27	---	11.47	46.74	---	73.96	53.96	-7.22
12061.04	1.00	96	37.44	---	9.81	47.25	---	73.96	53.96	-6.71

Test mode: IEEE 802.11b CH06 for 30MHz to 1GHz [Horizontal]

Radiated Emission				Correction Factors	Corrected Amplitude	Class B (3 m)	
Frequency (MHz)	Amplitude (dBµV)	Ant. H. (m)	Table (°)			Limit (dBµV/m)	Margin (dB)
176.71	38.58	1.00	244	-3.77	34.81	43.50	-8.69
253.10	40.91	1.00	226	-4.08	36.83	46.00	-9.17
266.44	40.50	1.00	87	-4.20	36.30	46.00	-9.70
399.81	40.12	1.00	229	-1.01	39.11	46.00	-6.89
599.87	31.87	1.00	224	6.67	38.54	46.00	-7.46
750.23	26.21	1.00	224	10.42	36.63	46.00	-9.37

Test mode: IEEE 802.11b CH06 for 30MHz to 1GHz [Vertical]

Radiated Emission				Correction Factors	Corrected Amplitude	Class B (3 m)	
Frequency (MHz)	Amplitude (dBµV)	Ant. H. (m)	Table (°)			Limit (dBµV/m)	Margin (dB)
253.10	41.54	1.00	204	-4.08	37.46	46.00	-8.54
387.69	43.45	1.00	236	-1.43	42.02	46.00	-3.98
442.25	39.85	1.00	228	0.70	40.55	46.00	-5.45
508.94	35.26	1.00	228	3.28	38.54	46.00	-7.46
660.50	30.00	1.00	305	8.70	38.70	46.00	-7.30
792.66	28.54	1.00	316	11.43	39.97	46.00	-6.03

Test mode: IEEE 802.11b CH06 for 1GHz to 25GHz [Horizontal]

Frequency	Ant. H.	Table	Amplitude		Correction Factor	Corrected Amplitude		Limit		Margin
			Peak / Ave.			Peak / Ave.		Peak / Ave.		
MHz	m	degree	dBµV		dB/m	dBµV/m		dBµV/m		dB
1820.79	1.00	87	40.33	33.33	10.89	51.22	44.22	73.96	53.96	-9.74
4871.46	1.00	77	42.94	---	3.95	46.89	---	73.96	53.96	-7.07
7312.29	1.00	161	35.61	---	10.30	45.91	---	73.96	53.96	-8.05
9747.93	1.00	110	41.60	38.61	11.89	53.49	50.50	73.96	53.96	-3.46
12187.92	1.00	127	38.60	---	9.74	48.34	---	73.96	53.96	-5.62

Test mode: IEEE 802.11b CH06 for 1GHz to 25GHz [Vertical]

Frequency	Ant. H.	Table	Amplitude		Correction Factor	Corrected Amplitude		Limit		Margin
			Peak / Ave.			Peak / Ave.		Peak / Ave.		
MHz	m	degree	dBµV		dB/m	dBµV/m		dBµV/m		dB
1820.82	1.00	93	41.16	37.17	10.89	52.05	48.06	73.96	53.96	-5.90
2566.67	1.00	174	40.66	---	9.62	50.28	---	73.96	53.96	-3.68
4871.46	1.00	183	45.60	---	3.95	49.55	---	73.96	53.96	-4.41
7312.29	1.00	83	35.27	---	10.30	45.57	---	73.96	53.96	-8.39
9747.08	1.00	58	34.60	---	11.89	46.49	---	73.96	53.96	-7.47
12187.92	1.00	31	38.10	---	9.74	47.84	---	73.96	53.96	-6.12

Test mode: IEEE 802.11b CH11 for 30MHz to 1GHz [Horizontal]

Radiated Emission				Correction Factors	Corrected Amplitude	Class B (3 m)	
Frequency (MHz)	Amplitude (dBµV)	Ant. H. (m)	Table (°)			Limit (dBµV/m)	Margin (dB)
177.92	39.08	1.00	255	-3.77	35.31	43.50	-8.19
188.84	41.59	1.00	285	-3.67	37.92	43.50	-5.58
253.10	42.59	1.00	238	-4.08	38.51	46.00	-7.49
398.60	38.36	1.00	229	-1.05	37.31	46.00	-8.69
750.23	25.74	1.00	224	10.42	36.16	46.00	-9.84
923.61	22.30	1.00	267	15.54	37.84	46.00	-8.16

Test mode: IEEE 802.11b CH11 for 30MHz to 1GHz [Vertical]

Radiated Emission				Correction Factors	Corrected Amplitude	Class B (3 m)	
Frequency (MHz)	Amplitude (dBµV)	Ant. H. (m)	Table (°)			Limit (dBµV/m)	Margin (dB)
253.10	41.68	1.00	226	-4.08	37.60	46.00	-8.40
376.77	44.33	1.00	247	-1.80	42.53	46.00	-3.47
442.25	38.66	1.00	218	0.70	39.36	46.00	-6.64
485.90	36.77	1.00	229	2.37	39.14	46.00	-6.86
660.50	30.71	1.00	311	8.70	39.41	46.00	-6.59
792.66	28.78	1.00	328	11.43	40.21	46.00	-5.79

Test mode: IEEE 802.11b CH11 for 1GHz to 25GHz [Horizontal]

<i>Frequency</i>	<i>Ant. H.</i>	<i>Table</i>	<i>Amplitude</i>		<i>Correction Factor</i>	<i>Corrected Amplitude</i>		<i>Limit</i>		<i>Margin</i>
			<i>Peak / Ave.</i>			<i>Peak / Ave.</i>		<i>Peak / Ave.</i>		
<i>MHz</i>	<i>m</i>	<i>degree</i>	<i>dBμV</i>		<i>dB/m</i>	<i>dBμV/m</i>		<i>dBμV/m</i>		<i>dB</i>
1820.83	1.00	242	39.33	---	10.89	50.22	---	73.96	53.96	-3.74
1954.17	1.00	175	38.16	---	8.81	46.97	---	73.96	53.96	-6.99
2283.33	1.00	167	37.34	---	8.88	46.22	---	73.96	53.96	-7.74
4925.83	1.00	302	40.44	---	4.13	44.57	---	73.96	53.96	-9.39
7384.79	1.00	182	37.28	---	10.42	47.70	---	73.96	53.96	-6.26
9849.79	1.00	103	38.78	---	11.93	50.71	---	73.96	53.96	-3.25
12308.75	1.00	165	38.77	---	9.56	48.33	---	73.96	53.96	-5.63

Test mode: IEEE 802.11b CH11 for 1GHz to 25GHz [Vertical]

<i>Frequency</i>	<i>Ant. H.</i>	<i>Table</i>	<i>Amplitude</i>		<i>Correction Factor</i>	<i>Corrected Amplitude</i>		<i>Limit</i>		<i>Margin</i>
			<i>Peak / Ave.</i>			<i>Peak / Ave.</i>		<i>Peak / Ave.</i>		
<i>MHz</i>	<i>m</i>	<i>degree</i>	<i>dBμV</i>		<i>dB/m</i>	<i>dBμV/m</i>		<i>dBμV/m</i>		<i>dB</i>
1820.73	1.00	337	42.83	36.00	10.89	53.72	46.89	73.96	53.96	-7.07
4925.83	1.00	188	45.27	---	4.13	49.40	---	73.96	53.96	-4.56
7384.79	1.00	74	36.78	---	10.42	47.20	---	73.96	53.96	-6.76
9849.79	1.00	294	35.11	---	11.93	47.04	---	73.96	53.96	-6.92
12308.75	1.00	291	37.44	---	9.56	47.00	---	73.96	53.96	-6.96

Test mode: IEEE 802.11g CH01 for 30MHz to 1GHz [Horizontal]

Radiated Emission				Correction Factors	Corrected Amplitude	Class B (3 m)	
Frequency (MHz)	Amplitude (dBµV)	Ant. H. (m)	Table (°)			Limit (dBµV/m)	Margin (dB)
190.05	40.48	1.00	278	-3.66	36.82	43.50	-6.68
253.10	42.30	1.00	231	-4.08	38.22	46.00	-7.78
266.44	41.07	1.00	100	-4.20	36.87	46.00	-9.13
398.60	40.15	1.00	225	-1.05	39.10	46.00	-6.90
496.81	34.63	1.00	217	2.78	37.41	46.00	-8.59
792.66	25.18	1.00	247	11.43	36.61	46.00	-9.39

Test mode: IEEE 802.11g CH01 for 30MHz to 1GHz [Vertical]

Radiated Emission				Correction Factors	Corrected Amplitude	Class B (3 m)	
Frequency (MHz)	Amplitude (dBµV)	Ant. H. (m)	Table (°)			Limit (dBµV/m)	Margin (dB)
376.77	42.91	1.00	248	-1.80	41.11	46.00	-4.89
398.60	41.32	1.00	228	-1.05	40.27	46.00	-5.73
442.25	39.85	1.00	230	0.70	40.55	46.00	-5.45
498.02	36.70	1.00	230	2.83	39.53	46.00	-6.47
660.50	30.90	1.00	334	8.70	39.60	46.00	-6.40
792.66	28.78	1.00	311	11.43	40.21	46.00	-5.79

Test mode: IEEE 802.11g CH01 for 1GHz to 25GHz [Horizontal]

Frequency	Ant. H.	Table	Amplitude		Correction Factor	Corrected Amplitude		Limit		Margin
			Peak / Ave.			Peak / Ave.		Peak / Ave.		
MHz	m	degree	dBµV		dB/m	dBµV/m		dBµV/m		dB
1820.83	1.00	116	39.66	---	10.89	50.55	---	73.96	53.96	-3.41
1952.08	1.00	138	36.00	---	8.84	44.84	---	73.96	53.96	-9.12
4823.12	1.00	197	38.44	---	3.76	42.20	---	73.96	53.96	-11.76
7233.75	1.00	85	35.28	---	10.07	45.35	---	73.96	53.96	-8.61
9647.94	1.00	88	42.62	39.61	11.46	54.08	51.07	73.96	53.96	-2.89
12061.04	1.00	108	37.44	---	9.81	47.25	---	73.96	53.96	-6.71

Test mode: IEEE 802.11g CH01 for 1GHz to 25GHz [Vertical]

Frequency	Ant. H.	Table	Amplitude		Correction Factor	Corrected Amplitude		Limit		Margin
			Peak / Ave.			Peak / Ave.		Peak / Ave.		
MHz	m	degree	dBµV		dB/m	dBµV/m		dBµV/m		dB
2185.42	1.00	352	38.83	---	8.61	47.44	---	73.96	53.96	-6.52
2477.51	1.00	27	44.17	31.83	9.43	53.60	41.26	73.96	53.96	-12.70
4823.12	1.00	273	39.10	---	3.76	42.86	---	73.96	53.96	-11.10
7233.75	1.00	89	35.94	---	10.07	46.01	---	73.96	53.96	-7.95
9650.42	1.00	52	35.27	---	11.47	46.74	---	73.96	53.96	-7.22
12061.04	1.00	34	37.60	---	9.81	47.41	---	73.96	53.96	-6.55

Test mode: IEEE 802.11g CH06 for 30MHz to 1GHz [Horizontal]

Radiated Emission				Correction Factors	Corrected Amplitude	Class B (3 m)	
Frequency (MHz)	Amplitude (dBµV)	Ant. H. (m)	Table (°)			Limit (dBµV/m)	Margin (dB)
177.92	37.46	1.00	235	-3.77	33.69	43.50	-9.81
202.17	37.73	1.00	289	-3.83	33.90	43.50	-9.60
253.10	43.05	1.00	228	-4.08	38.97	46.00	-7.03
376.77	38.61	1.00	10	-1.80	36.81	46.00	-9.19
409.51	39.12	1.00	222	-0.62	38.50	46.00	-7.50
750.23	26.18	1.00	217	10.42	36.60	46.00	-9.40

Test mode: IEEE 802.11g CH06 for 30MHz to 1GHz [Vertical]

Radiated Emission				Correction Factors	Corrected Amplitude	Class B (3 m)	
Frequency (MHz)	Amplitude (dBµV)	Ant. H. (m)	Table (°)			Limit (dBµV/m)	Margin (dB)
387.69	43.24	1.00	233	-1.43	41.81	46.00	-4.19
442.25	40.49	1.00	2236	0.70	41.19	46.00	-4.81
498.02	39.77	1.00	228	2.83	42.60	46.00	-3.40
528.34	36.94	1.00	12	4.10	41.04	46.00	-4.96
660.50	30.43	1.00	305	8.70	39.13	46.00	-6.87
792.66	28.68	1.00	328	11.43	40.11	46.00	-5.89

Test mode: IEEE 802.11g CH06 for 1GHz to 25GHz [Horizontal]

<i>Frequency</i>	<i>Ant. H.</i>	<i>Table</i>	<i>Amplitude</i>		<i>Correction Factor</i>	<i>Corrected Amplitude</i>		<i>Limit</i>		<i>Margin</i>
			<i>Peak / Ave.</i>			<i>Peak / Ave.</i>		<i>Peak / Ave.</i>		
<i>MHz</i>	<i>m</i>	<i>degree</i>	<i>dBμV</i>		<i>dB/m</i>	<i>dBμV/m</i>		<i>dBμV/m</i>		<i>dB</i>
1954.17	1.00	176	38.66	---	8.81	47.47	---	73.96	53.96	-6.49
4877.50	1.00	297	37.61	---	3.97	41.58	---	73.96	53.96	-12.38
7312.29	1.00	110	36.44	---	10.30	46.74	---	73.96	53.96	-7.22
9747.93	1.00	102	41.27	38.77	11.89	53.16	50.66	73.96	53.96	-3.30
12187.92	1.00	330	39.60	---	9.74	49.34	---	73.96	53.96	-4.62
21934.79	1.00	205	46.50	---	3.09	49.59	---	73.96	53.96	-4.37

Test mode: IEEE 802.11g CH06 for 1GHz to 25GHz [Vertical]

<i>Frequency</i>	<i>Ant. H.</i>	<i>Table</i>	<i>Amplitude</i>		<i>Correction Factor</i>	<i>Corrected Amplitude</i>		<i>Limit</i>		<i>Margin</i>
			<i>Peak / Ave.</i>			<i>Peak / Ave.</i>		<i>Peak / Ave.</i>		
<i>MHz</i>	<i>m</i>	<i>degree</i>	<i>dBμV</i>		<i>dB/m</i>	<i>dBμV/m</i>		<i>dBμV/m</i>		<i>dB</i>
2714.58	1.00	168	38.84	---	9.89	48.73	---	73.96	53.96	-5.23
4877.50	1.00	259	38.61	---	3.97	42.58	---	73.96	53.96	-11.38
7312.29	1.00	173	36.61	---	10.30	46.91	---	73.96	53.96	-7.05
9747.08	1.00	308	34.94	---	11.89	46.83	---	73.96	53.96	-7.13
12187.92	1.00	75	38.27	---	9.74	48.01	---	73.96	53.96	-5.95
21934.79	1.00	237	46.00	---	3.09	49.09	---	73.96	53.96	-4.87

Test mode: IEEE 802.11g CH11 for 30MHz to 1GHz [Horizontal]

Radiated Emission				Correction Factors	Corrected Amplitude	Class B (3 m)	
Frequency (MHz)	Amplitude (dBµV)	Ant. H. (m)	Table (°)			Limit (dBµV/m)	Margin (dB)
177.92	39.45	1.00	246	-3.77	35.68	43.50	-7.82
188.84	39.60	1.00	255	-3.67	35.93	43.50	-7.57
253.10	42.25	1.00	234	-4.08	38.17	46.00	-7.83
267.65	40.68	1.00	85	-4.20	36.48	46.00	-9.52
399.81	39.75	1.00	225	-1.01	38.74	46.00	-7.26
750.23	25.93	1.00	253	10.42	36.35	46.00	-9.65

Test mode: IEEE 802.11g CH11 for 30MHz to 1GHz [Vertical]

Radiated Emission				Correction Factors	Corrected Amplitude	Class B (3 m)	
Frequency (MHz)	Amplitude (dBµV)	Ant. H. (m)	Table (°)			Limit (dBµV/m)	Margin (dB)
377.99	44.35	1.00	255	-1.76	42.59	46.00	-3.41
443.46	39.28	1.00	225	0.75	40.03	46.00	-5.97
496.81	39.30	1.00	237	2.78	42.08	46.00	-3.92
660.50	29.41	1.00	334	8.70	38.11	46.00	-7.89
750.23	28.00	1.00	241	10.42	38.42	46.00	-7.58
792.66	29.13	1.00	322	11.43	40.56	46.00	-5.44

Test mode: IEEE 802.11g CH11 for 1GHz to 25GHz [Horizontal]

<i>Frequency</i>	<i>Ant. H.</i>	<i>Table</i>	<i>Amplitude</i>		<i>Correction Factor</i>	<i>Corrected Amplitude</i>		<i>Limit</i>		<i>Margin</i>
			<i>Peak / Ave.</i>			<i>Peak / Ave.</i>		<i>Peak / Ave.</i>		
<i>MHz</i>	<i>m</i>	<i>degree</i>	<i>dBμV</i>		<i>dB/m</i>	<i>dBμV/m</i>		<i>dBμV/m</i>		<i>dB</i>
1954.17	1.00	125	36.66	---	8.81	45.47	---	73.96	53.96	-8.49
2247.92	1.00	248	37.67	---	8.78	46.45	---	73.96	53.96	-7.51
4925.83	1.00	167	38.11	---	4.13	42.24	---	73.96	53.96	-11.72
7384.79	1.00	79	35.44	---	10.42	45.86	---	73.96	53.96	-8.10
9849.79	1.00	101	38.94	---	11.93	50.87	---	73.96	53.96	-3.09
12308.75	1.00	0	36.94	---	9.56	46.50	---	73.96	53.96	-7.46

Test mode: IEEE 802.11g CH11 for 1GHz to 25GHz [Vertical]

<i>Frequency</i>	<i>Ant. H.</i>	<i>Table</i>	<i>Amplitude</i>		<i>Correction Factor</i>	<i>Corrected Amplitude</i>		<i>Limit</i>		<i>Margin</i>
			<i>Peak / Ave.</i>			<i>Peak / Ave.</i>		<i>Peak / Ave.</i>		
<i>MHz</i>	<i>m</i>	<i>degree</i>	<i>dBμV</i>		<i>dB/m</i>	<i>dBμV/m</i>		<i>dBμV/m</i>		<i>dB</i>
2160.42	1.00	109	38.00	---	8.54	46.54	---	73.96	53.96	-7.42
2320.83	1.00	231	40.33	---	8.99	49.32	---	73.96	53.96	-4.64
7384.79	1.00	82	35.78	---	10.42	46.20	---	73.96	53.96	-7.76
9849.79	1.00	274	35.78	---	11.93	47.71	---	73.96	53.96	-6.25
12308.75	1.00	265	37.11	---	9.56	46.67	---	73.96	53.96	-7.29
24619.37	1.00	50	45.83	---	3.01	48.84	---	73.96	53.96	-5.12

8.5 Test Result of the Bandedge

If any 100 kHz bandwidth outside these frequency bands, the radio frequency power that is produced by the modulation products of the spreading sequence, the information sequence and the carrier frequency shall be either *at least 20 dB below that in any 100 kHz bandwidth within the band that contains the highest level of the desired power or shall not exceed the general levels specified in §15.209(a)*,

We perform this section by the *radiated manner*, the RBW is set to 100kHz and VBW>RBW. We'd made the observation *up to 10th harmonics and the criterion is all the harmonic/spurious emissions must be 20dB below the highest emission level measured*. If the emissions fall in the restricted bands stated in the Part15.205(a) must also *comply with the radiated emission limits specified in Part15.209(a)*. (Peak mode: RBW=VBW=1MHz, Average mode: RBW=1MHz; VBW=10Hz)

The following pages show our observations referring to the channel 1 and 11 respectively.

Test Condition & Setup: same as < 8.1 >

IEEE 802.11b CH01

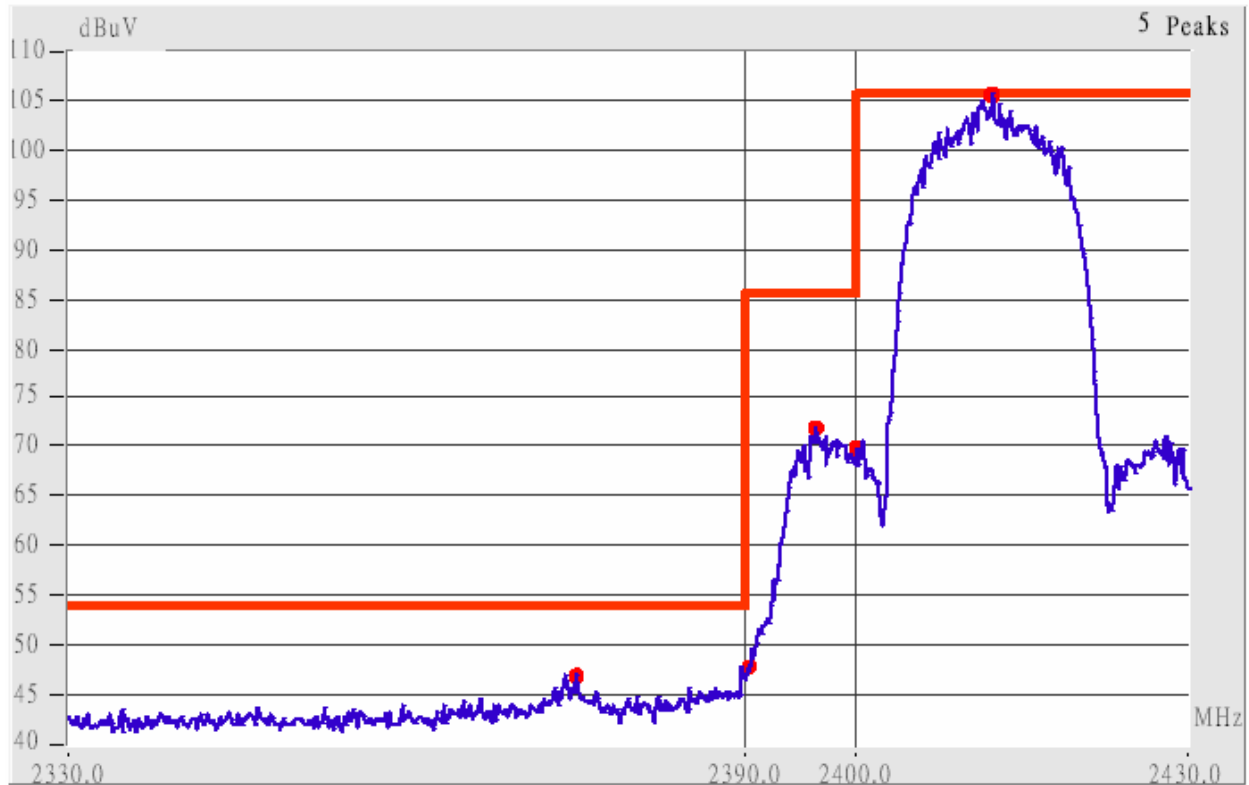

This is the hard copy of our bandedge measurement generated by our bandedge testing program. The plot shown above is the bandedge of channel 1.

1. The lobe left by the fundamental side is already 20dB below the highest emission level.
2. The emissions recorded in the restricted band is do comply with the Part 15.209(a) – as below.

<i>Radiated Emission</i>					<i>Corrected Amplitude</i>		<i>Class B (3m)</i>		
<i>Frequency (MHz)</i>	<i>Ant. P.</i>	<i>Ant. H. (m)</i>	<i>Table (°)</i>	<i>Factors (dB)</i>	<i>(dBµV/m)</i>		<i>Limit (dBµV/m)</i>		<i>Margin (dB)</i>
					<i>Peak</i>	<i>Average</i>	<i>Peak</i>	<i>Ave.</i>	
2373.44	Hor	1.00	191	9.14	49.47	---	74.00	53.96	-4.49
2378.32	Hor	1.00	191	9.15	48.82	---	74.00	53.96	-5.14
2390.66	Hor	1.00	188	9.18	52.35	43.51	74.00	53.96	-10.45
2373.54	Ver	1.00	229	9.14	53.14	42.64	74.00	53.96	-11.32
2376.64	Ver	1.00	126	9.14	53.64	40.81	74.00	53.96	-13.15
2390.94	Ver	1.00	134	9.18	58.18	50.51	74.00	53.96	-3.45

IEEE 802.11b CH11

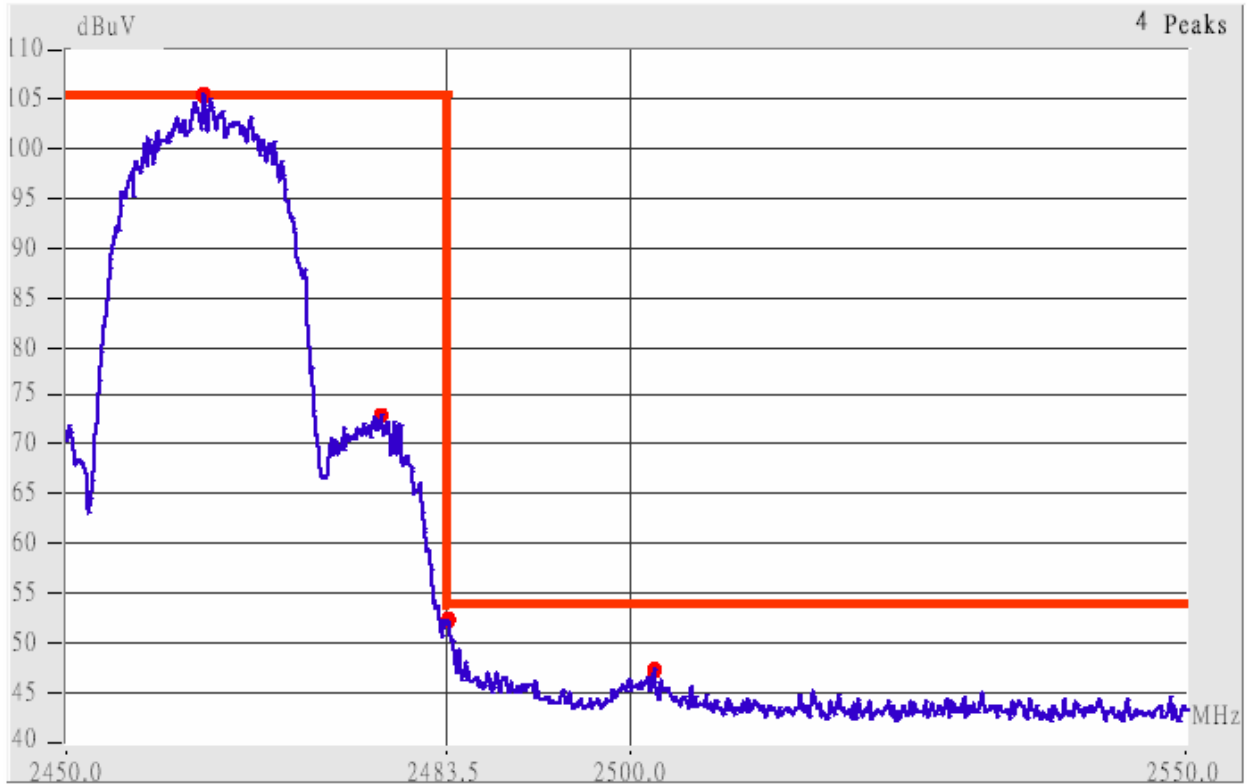

This is the hard copy of our bandedge measurement generated by our bandedge testing program. The plot shown above is the bandedge of channel 11.

3. The lobe right by the fundamental side is already 20dB below the highest emission level.
4. The emissions recorded in the restricted band is do comply with the Part 15.209(a) – as below

<i>Radiated Emission</i>					<i>Corrected Amplitude</i>		<i>Class B (3m)</i>		
<i>Frequency (MHz)</i>	<i>Ant. P.</i>	<i>Ant. H. (m)</i>	<i>Table (°)</i>	<i>Factors (dB)</i>	<i>(dBµV/m)</i>		<i>Limit (dBµV/m)</i>		<i>Margin (dB)</i>
					<i>Peak</i>	<i>Average</i>	<i>Peak</i>	<i>Ave.</i>	
2483.50	Hor	1.00	151	9.44	50.94	---	74.00	53.96	-3.02
2492.02	Hor	1.00	125	9.47	47.63	---	74.00	53.96	-6.33
2483.34	Ver	1.00	268	9.44	61.44	49.61	74.00	53.96	-4.35
2484.38	Ver	1.00	148	9.45	57.11	46.28	74.00	53.96	-7.68
2500.23	Ver	1.00	214	9.49	52.66	43.99	74.00	53.96	-9.97
2501.73	Ver	1.00	268	9.49	54.16	43.32	74.00	53.96	-10.64

IEEE 802.11g CH01

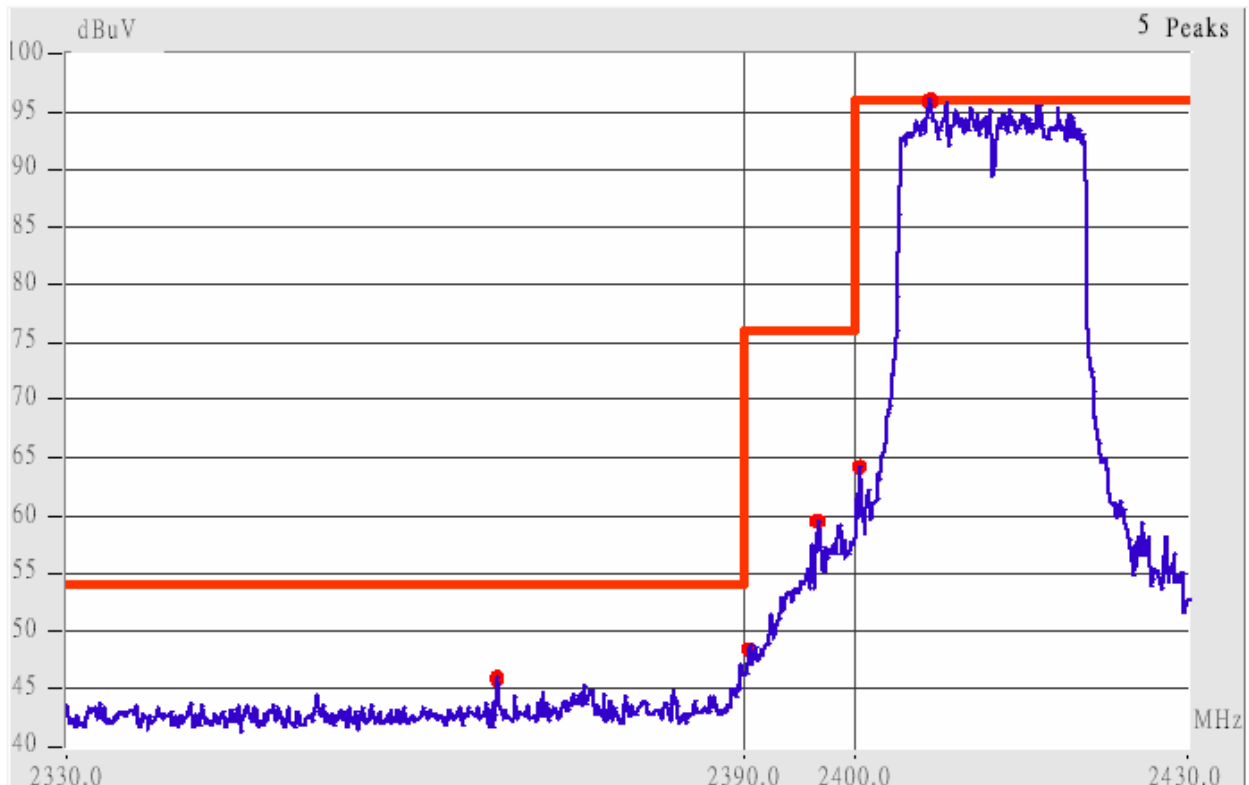

This is the hard copy of our bandedge measurement generated by our bandedge testing program. The plot shown above is the bandedge of channel 1.

- 5. The lobe left by the fundamental side is already 20dB below the highest emission level.
- 6. The emissions recorded in the restricted band is do comply with the Part 15.209(a) – as below.

<i>Radiated Emission</i>					<i>Corrected Amplitude</i>		<i>Class B (3m)</i>		
<i>Frequency (MHz)</i>	<i>Ant. P.</i>	<i>Ant. H. (m)</i>	<i>Table (°)</i>	<i>Factors (dB)</i>	<i>(dBµV/m)</i>		<i>Limit (dBµV/m)</i>		<i>Margin (dB)</i>
					<i>Peak</i>	<i>Average</i>	<i>Peak</i>	<i>Ave.</i>	
2375.82	Hor	1.00	177	9.14	48.64	---	74.00	53.96	-5.32
2389.72	Hor	1.00	298	9.18	53.18	37.51	74.00	53.96	-16.45
2390.02	Hor	1.00	191	9.18	51.35	---	74.00	53.96	-2.61
2375.79	Ver	1.00	131	9.14	52.98	41.97	74.00	53.96	-11.99
2389.51	Ver	1.00	132	9.18	59.51	42.68	74.00	53.96	-11.28
2390.41	Ver	1.00	114	9.18	58.68	44.18	74.00	53.96	-9.78

IEEE 802.11g CH11

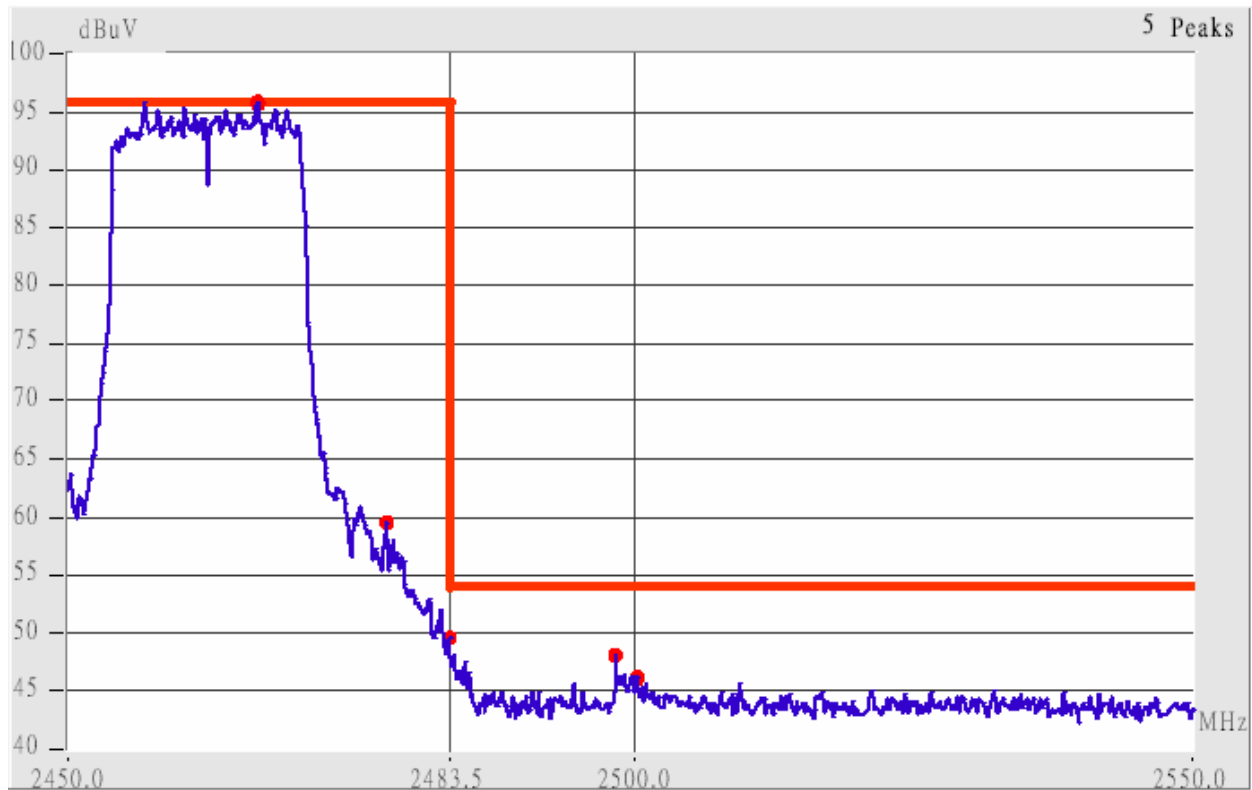

This is the hard copy of our bandedge measurement generated by our bandedge testing program. The plot shown above is the bandedge of channel 11.

- 7. The lobe right by the fundamental side is already 20dB below the highest emission level.
- 8. The emissions recorded in the restricted band is do comply with the Part 15.209(a) – as below

<i>Radiated Emission</i>					<i>Corrected Amplitude</i>		<i>Class B (3m)</i>		
<i>Frequency (MHz)</i>	<i>Ant. P.</i>	<i>Ant. H. (m)</i>	<i>Table (°)</i>	<i>Factors (dB)</i>	<i>(dBµV/m)</i>		<i>Limit (dBµV/m)</i>		<i>Margin (dB)</i>
					<i>Peak</i>	<i>Average</i>	<i>Peak</i>	<i>Ave.</i>	
2483.50	Hor	1.00	106	9.44	50.61	---	74.00	53.96	-3.35
2497.85	Hor	1.00	88	9.48	47.32	---	74.00	53.96	-6.64
2482.91	Ver	1.00	342	9.44	59.28	46.27	74.00	53.96	-7.69
2498.56	Ver	1.00	212	9.49	54.99	43.66	74.00	53.96	-10.30
2499.76	Ver	1.00	270	9.49	51.99	42.66	74.00	53.96	-11.30
2501.60	Ver	1.00	347	9.49	53.49	41.32	74.00	53.96	-12.64

IX. Section 15.247(d): Power Spectral Density

9.1 Test Condition & Setup

The tests below are running with the EUT transmitter set at high power in TDD mode. The EUT is needed to force selection of output power level and channel number. While testing, the EUT was set to transmit continuously and to be tested by the contact manner with the spectrum analyzer.

9.2 Test Instruments Configuration

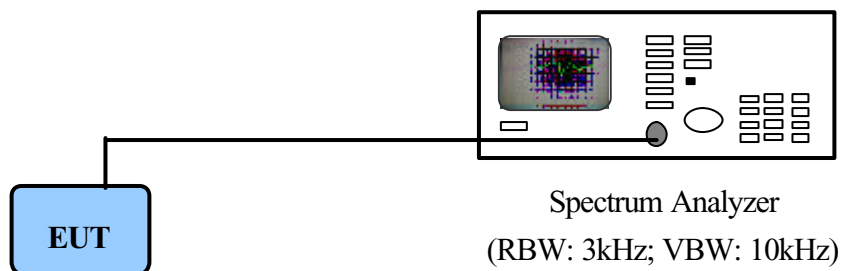

P.S.: PC to control the EUT at maximal power output and channel Number and set antenna kit

9.3 List of Test Instruments

Instrument Name	Model No.	Brand	Serial No.	Next time
Spectrum Analyzer	MS2665C	ANRITSU	6200175476	12/30/04

9.4 Test Result of Power spectral density

The following table shows a summary of the test results of the Power Spectral Density.

IEEE 802.11b

<i>Channel</i>	<i>Ppr (dBm)</i>	<i>Cable Loss (dB)</i>	<i>Ppq (dBm)</i>	<i>Limit (dB)</i>	<i>Margin (dB)</i>
CH 01	-6.78	0.70	-6.08	8.00	-14.08
CH 06	-7.06	0.70	-6.36	8.00	-14.36
CH 11	-6.80	0.70	-6.10	8.00	-14.10

IEEE 802.11g

<i>Channel</i>	<i>Ppr (dBm)</i>	<i>Cable Loss (dB)</i>	<i>Ppq (dBm)</i>	<i>Limit (dB)</i>	<i>Margin (dB)</i>
CH 01	-17.33	0.70	-16.63	8.00	-24.63
CH 06	-16.81	0.70	-16.11	8.00	-24.11
CH 11	-16.63	0.70	-15.93	8.00	-23.93

Note:

1. The following pages show the results of spectrum reading.
2. Ppr: spectrum read power density (using peak search mode),
Ppq: actual peak power density in the spread spectrum band.
3. $Ppq = Ppr + |Cable Loss|$

Power Spectral Density for Channel 01

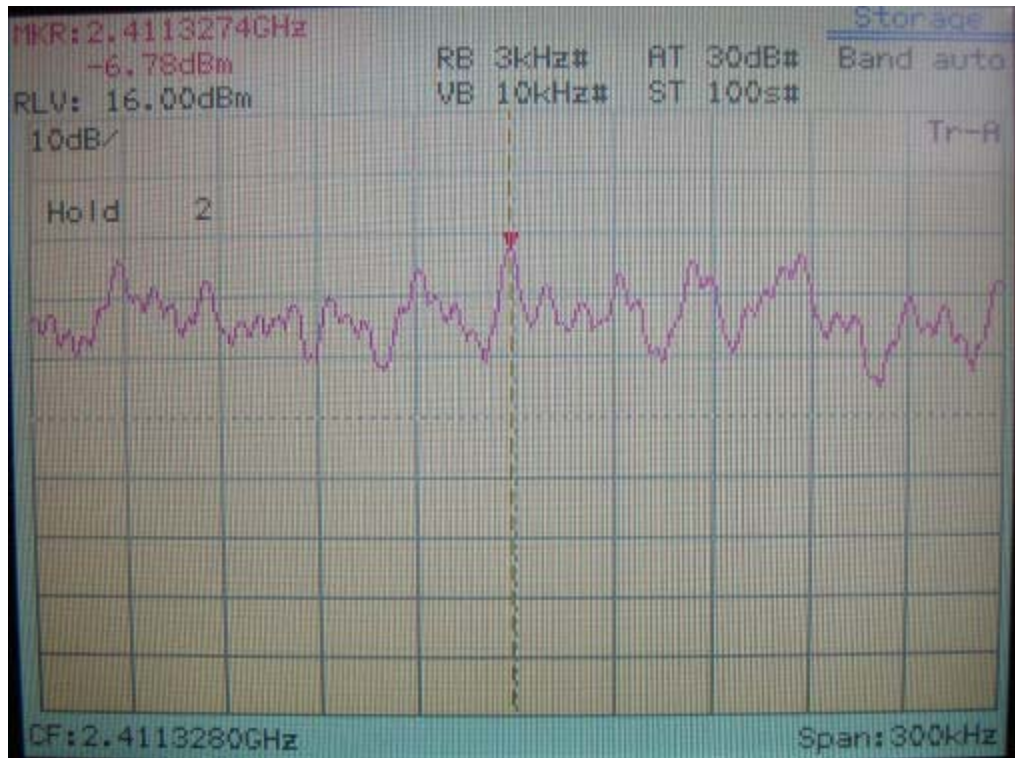

IEEE 802.11b

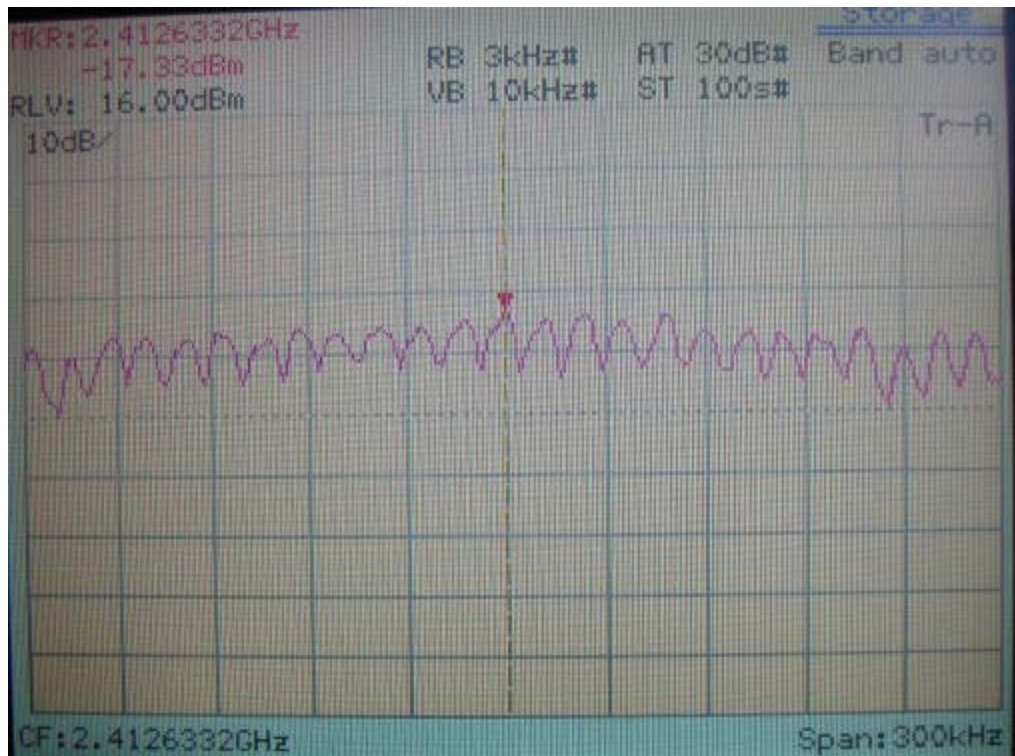

IEEE 802.11g

Power Spectral Density for Channel 06



IEEE 802.11b

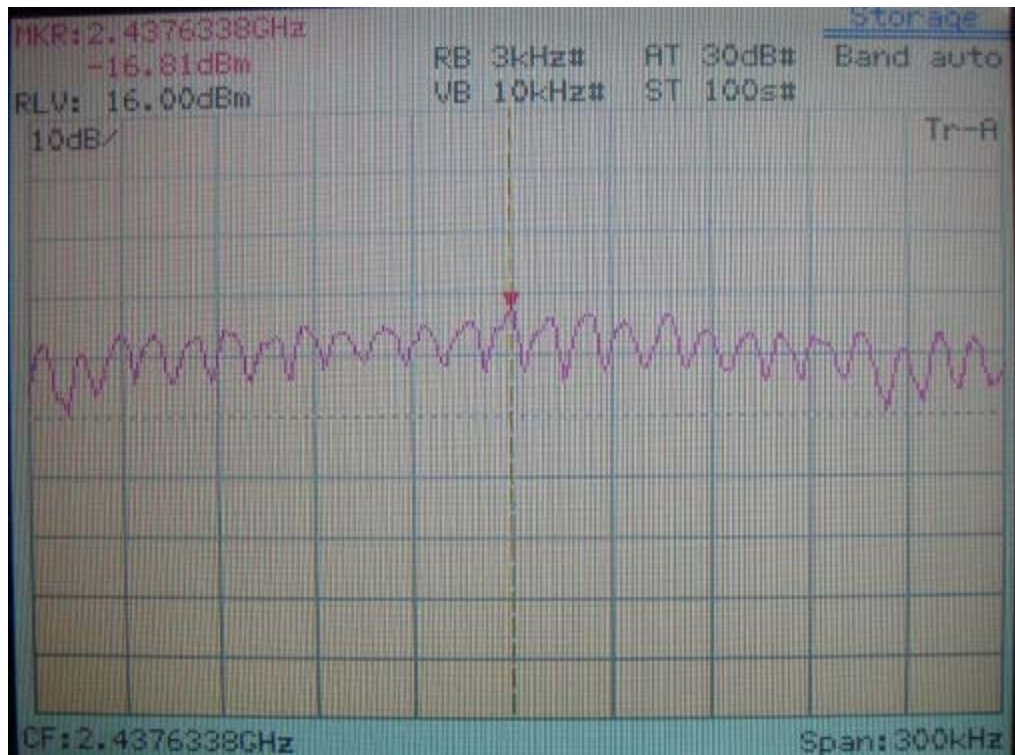

IEEE 802.11g

Power Spectral Density for Channel 11

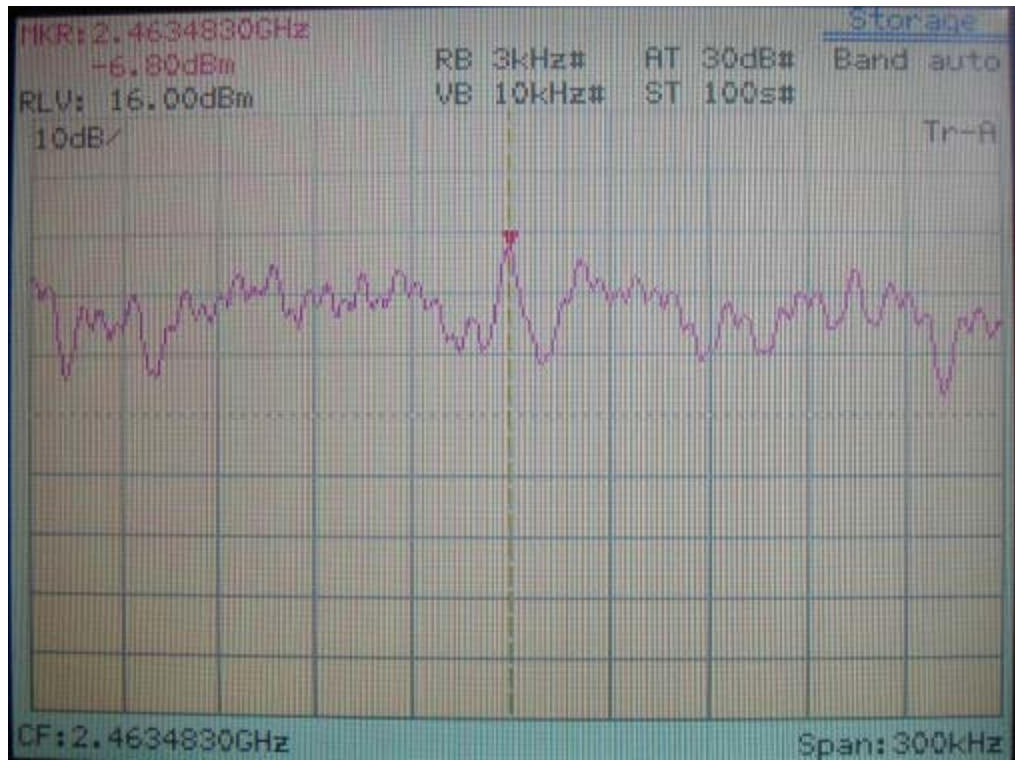

IEEE 802.11b

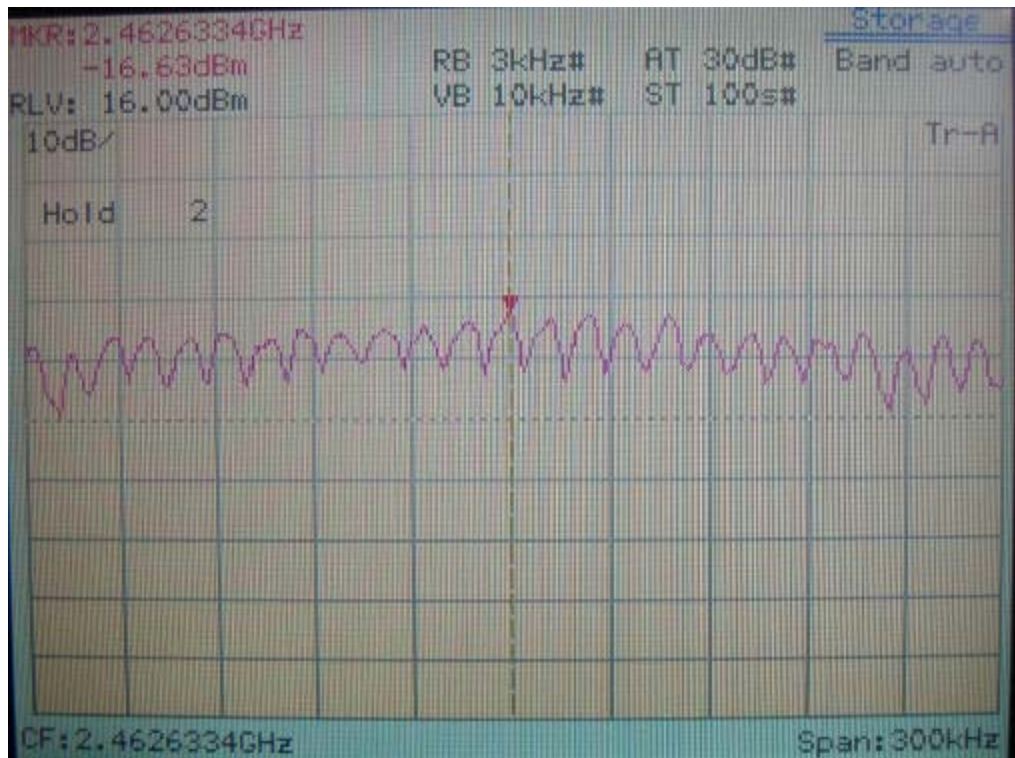

IEEE 802.11g