

FCC PART 15 SUBPART E
INDUSTRY CANADA RSS-210, ISSUE 7, JUNE 2007



MEASUREMENT AND TEST REPORT

For

Ruckus Wireless, Inc.

880 West Maude Ave., Suite 101
Sunnyvale, CA 94085, USA

Model: VF7811 & VF7111
FCC ID: S9GVF7XX1
IC: 5912A-VF7XX1

This Report Concerns:		Product type:	
<input checked="" type="checkbox"/> Original Report		Wi-Fi Access Point	
Test Engineer:	Xiao Ming Hu 		
Report No.:	R0803191-15E2		
Report Date:	2008-06-06		
Reviewed By:	Boni Baniqued, Sr. RF Test Engineer 		
Prepared By:	Bay Area Compliance Laboratories Corp. 1274 Anvilwood Ave. Sunnyvale, CA 94089, USA Tel: (408) 732-9162 Fax: (408) 732 9164		

Note: This test report is prepared for the customer shown above and for the device described herein. It may not be duplicated or used in part without prior written consent from Bay Area Compliance Laboratories Corp. This report **must not** be used by the customer to claim product certification, approval, or endorsement by NVLAP*, NIST, or any agency of the Federal Government.

* This report may contain data that are not covered by the NVLAP accreditation and are marked with an asterisk "*" Rev. 2

TABLE OF CONTENTS

1	GENERAL INFORMATION	5
1.1	PRODUCT DESCRIPTION FOR EQUIPMENT UNDER TEST (EUT)	5
1.2	EUT PHOTO	5
1.3	OBJECTIVE	5
1.4	RELATED SUBMITTAL(S)/GRANT(S)	5
1.5	TEST METHODOLOGY	6
1.6	MEASUREMENT UNCERTAINTY	6
1.7	TEST FACILITY	6
2	SYSTEM TEST CONFIGURATION	7
2.1	JUSTIFICATION	7
2.2	EUT EXERCISE SOFTWARE	7
2.3	SPECIAL ACCESSORIES	8
2.4	EQUIPMENT MODIFICATIONS	8
2.5	LOCAL SUPPORT EQUIPMENT LIST AND DETAILS	8
2.6	INTERFACE PORTS AND CABLING	8
2.7	POWER SUPPLY AND LINE FILTERS	8
3	SUMMARY OF TEST RESULTS	9
4	FCC §15.407 (f), §2.1091 & IC RSS-GEN 5.5, RSS-102 - RF EXPOSURE	10
4.1	APPLICABLE STANDARD	10
4.2	MPE PREDICTION	10
4.3	RESULTS	11
5	FCC §15.203 & IC RSS-GEN §7.1.4 - ANTENNA REQUIREMENT	12
5.1	APPLICABLE STANDARD	12
5.2	RESULT	12
6	FCC §15.207 (a) & IC RSS-GEN §7.2.2 - CONDUCTED EMISSIONS	13
6.1	SECTION 15.207 CONDUCTED LIMITS	13
6.2	TEST SETUP	13
6.3	TEST EQUIPMENT LIST AND DETAILS	13
6.4	TEST PROCEDURE	13
6.5	TEST SETUP DIAGRAM	14
6.6	ENVIRONMENTAL CONDITIONS	14
6.7	SUMMARY OF TEST RESULTS	14
6.8	TEST PLOT AND DATA	15
7	FCC §15.407(b) & RSS-210 § A9.3 - SPURIOUS EMISSIONS AT ANTENNA TERMINALS	19
7.1	APPLICABLE STANDARD	19
7.2	MEASUREMENT PROCEDURE	19
7.3	EQUIPMENT LISTS	19
7.4	TEST SETUP DIAGRAM	19
7.5	ENVIRONMENTAL CONDITIONS	19
7.6	MEASUREMENT RESULT	20
8	FCC §15.205, §15.209, §15.407(b) & IC RSS-210 §2.6, §A9.3 - SPURIOUS RADIATED EMISSIONS	46
8.1	APPLICABLE STANDARD	46
8.2	TEST SETUP	47
8.3	TEST EQUIPMENT LIST AND DETAILS	47

8.4	TEST PROCEDURE	47
8.5	CORRECTED AMPLITUDE & MARGIN CALCULATION	48
8.6	TEST SETUP DIAGRAM	48
8.7	ENVIRONMENTAL CONDITIONS	48
8.8	SUMMARY OF TEST RESULTS	49
8.9	TEST PLOT AND DATA	50
9	FCC §15.407(a) & RSS 210 A9.2 – 26 DB & 99% EMISSION BANDWIDTH	69
9.1	APPLICABLE STANDARD	69
9.2	MEASUREMENT PROCEDURE.....	69
9.3	EQUIPMENT LIST.....	69
9.4	TEST SETUP DIAGRAM	69
9.5	ENVIRONMENTAL CONDITIONS.....	69
9.6	TEST RESULTS:	70
10	FCC §15.407 (a) & RSS 210 A9.2 - MAXIMUM OUTPUT POWER.....	80
10.1	APPLICABLE STANDARD	80
10.2	MEASUREMENT PROCEDURE.....	80
10.3	EQUIPMENT LISTS	80
10.4	TEST SETUP DIAGRAM	81
10.5	ENVIRONMENTAL CONDITIONS.....	81
10.6	TEST RESULT	81
11	FCC 407 (a) & RSS 210 A9.2 - PEAK POWER SPECTRAL DENSITY.....	110
11.1	APPLICABLE STANDARD	110
11.2	MEASUREMENT PROCEDURE.....	110
11.3	EQUIPMENT LISTS	110
11.4	TEST SETUP DIAGRAM	111
11.5	ENVIRONMENTAL CONDITIONS.....	111
11.6	TEST RESULT	111
12	FCC §15.407(a) (6) – PEAK EXCURSION.....	122
12.1	APPLICABLE STANDARD	122
12.2	MEASUREMENT PROCEDURE.....	122
12.3	EQUIPMENT LISTS	122
12.4	TEST SETUP DIAGRAM	122
12.5	ENVIRONMENTAL CONDITIONS.....	122
12.6	TEST RESULT	123
13	FCC §15.407(h) & RSS 210 A9.4– DYNAMIC FREQUENCY SELECTION.....	138
13.1	APPLICABLE STANDARD	138
13.2	STATEMENT OF COMPLIANCE	141
14	EXHIBIT A – FCC & IC ID LABEL INFORMATION.....	142
14.1	FCC § 2.925 IDENTIFICATION OF EQUIPMENT.....	142
14.2	ID LABEL REQUIREMENTS AS PER FCC § 15.19.....	142
14.3	IC RSS GEN 5.2 EQUIPMENT LABELING:	142
14.4	PROPOSED FCC & IC ID LABEL	143
14.5	PROPOSED ID LABEL LOCATION ON THE REAR SIDE OF EUT	143
15	EXHIBIT B - TEST SETUP PHOTOGRAPHS	144
15.1	CONDUCTED EMISSIONS –FRONT VIEW	144
15.2	CONDUCTED EMISSIONS –SIDE VIEW	144
15.3	RADIATED EMISSIONS - FRONT VIEW	145
15.4	RADIATED EMISSIONS - REAR VIEW	145
16	EXHIBIT C - EUT PHOTOGRAPHS.....	146
16.1	EUT FRONT VIEW	146
16.2	EUT REAR VIEW	146

16.3	EUT PORT VIEW	147
16.4	ANTENNA VIEW	147
16.5	MAIN BOARD TOP COMPONENT VIEW	148
16.6	MAIN BOARD WITH RF MODULE SHIELD-CAN OPENED VIEW	148
16.7	MAIN BOARD BOTTOM COMPONENT VIEW	149
16.8	POWER SUPPLY 1 VIEW	149
16.9	POWER SUPPLY 2 VIEW	150

1 GENERAL INFORMATION

1.1 Product Description for Equipment under Test (EUT)

The Ruckus Wireless, Inc. product, VF7811 & VF7111, the "EUT" as referred to in this report is the Access Point and Ethernet to Wireless Adapter (802.11 a/n modes) which operates in 5150-5250 MHz, 5250-5350 MHz, 5470-5725 MHz and 5725-5850 MHz.

The EUT measures approximately 140 mm L x 120 mm W x 80 mm H

** The test data gathered are from typical production sample, serial number: 605 provided by the manufacturer.*

1.2 EUT Photo



Additional photos please refer to Appendix C

1.3 Objective

This type approval report is prepared on behalf of *Ruckus Wireless Inc.* in accordance with Part 2, Subpart J, Part 15, Subparts A, B, C and E of the Federal Communication Commissions rules and Industry Canada RSS-210 Issue 7, June 2007 standard.

The objective is to determine compliance with FCC/IC rules for Maximum Output Power, Antenna Requirements, 26 dB Bandwidth, peak power spectral density, Peak excursion, Band Edges Measurement, Conducted and Radiated Spurious Emissions.

1.4 Related Submittal(s)/Grant(s)

No Related Submittals.

1.5 Test Methodology

All measurements contained in this report were conducted in accordance with ANSI C63.4-2003, American National Standard for Methods of Measurement of Radio-Noise Emissions from Low-Voltage Electrical and Electronic Equipment in the range of 9 kHz to 40 GHz.

1.6 Measurement Uncertainty

All measurements involve certain levels of uncertainties, especially in field of EMC. The factors contributing to uncertainties are spectrum analyzer, cable loss, antenna factor calibration, antenna directivity, antenna factor variation with height, antenna phase center variation, antenna factor frequency interpolation, measurement distance variation, site imperfections, mismatch (average), and system repeatability.

Based on NIS 81, The Treatment of Uncertainty in EMC Measurements, the values range from ± 2.0 for Conducted Emissions tests and ± 4.0 dB for Radiated Emissions tests are the most accurate estimates pertaining to uncertainty of EMC measurements at BACL.

Detailed instrumentation measurement uncertainties can be found in BACL report QAP-018.

1.7 Test Facility

The Test site used by BACL Corp. to collect emissions measurement data is located at its facility in Sunnyvale, California, USA.

Test site at BACL has been fully described in reports submitted to the Federal Communication Commission (FCC) and Voluntary Control Council for Interference (VCCI). The details of these reports has been found to be in compliance with the requirements of Section 2.948 of the FCC Rules on February 11 and December 10, 1997 and Article 8 of the VCCI regulations on December 25, 1997. The facility also complies with the radiated and AC line conducted test site criteria set forth in ANSI C63.4-2003.

The Federal Communications Commission and Voluntary Control Council for Interference have the reports on file and is listed under FCC registration number: 90464 and VCCI Registration No.: C-1298 and R-1234. The test site has been approved by the FCC and VCCI for public use and is listed in the FCC Public Access Link (PAL) database.

Additionally, BACL is a National Institute of Standards and Technology (NIST) accredited laboratory, under the National Voluntary Laboratory Accredited Program (Lab Code 200167-0). The current scope of accreditations can be found at <http://ts.nist.gov/ts/htdocs/210/214/scopes/2001670.htm>

2 SYSTEM TEST CONFIGURATION

2.1 Justification

The host system was configured for testing according to ANSI C63.4-2003.

The EUT was tested in the testing mode to represent *worst*-case results during the final qualification test.

The worst-case data rates are determined to be as follows for each mode based upon investigation by measuring the average power, peak power and PPSD across all data rates bandwidths, and modulations.

2.2 EUT Exercise Software

The EUT is programmed with the following data rate settings that were used during testing:

For 5250 – 5350 MHz (W53)

Radio Mode	5260 MHz	5300 MHz	5320 MHz
802.11a 20MHz	6Mbps	6Mbps	6Mbps
802.11n 20MHz	6.5Mbps MCS0	6.5Mbps MCS0	6.5Mbps MCS0
Power Level setting	21dBm	21dBm	21dBm

Radio Mode	5270 MHz	5310 MHz
802.11n 40MHz	13Mbps MCS0	13Mbps MCS0
Power Level setting	21dBm	21dBm

For 5470 – 5725 MHz (W56)

Radio Mode	5500 MHz	5600 MHz	5700 MHz
802.11a 20MHz	6Mbps	6Mbps	6Mbps
802.11n 20MHz	6.5Mbps MCS0	6.5Mbps MCS0	6.5Mbps MCS0
Power Level setting	21dBm	21dBm	21dBm

Radio Mode	5510 MHz	5590 MHz	5670 MHz
802.11n 40MHz	13Mbps MCS0	13Mbps MCS0	13Mbps MCS0
Power Level setting	21dBm	21dBm	21dBm

2.3 Special Accessories

The unit was tested with OEM supplied cabling and accessories as would be normally supplied by the manufacturer to the customer; no special accessories were used.

2.4 Equipment Modifications

No modifications were made to the EUT.

2.5 Local Support Equipment List and Details

Manufacturer / Product Type	Model	Serial Number
Dell Laptop	Inspiron 2650	-

2.6 Interface Ports and Cabling

Cable Description	Length (M)	From	To
CAT6 Cable	1.5	EUT	Laptop

2.7 Power Supply and Line Filters

Manufacturer	Description	Model	Serial Number
Ruckus Wireless, Inc.	AC/DC Power Adapter	DSA-12R-12AUS	-
Ruckus Wireless, Inc.	AC/DC Power Adapter	MPB-1201250	-

3 SUMMARY OF TEST RESULTS

Results reported relate only to the product tested.

FCC/IC Rules	Description of Test	Result
§15.407 (f), §2.1091, IC RSS-Gen 5.5 & RSS-102	RF Exposure	Compliant
FCC §15.203, IC RSS-Gen §7.1.4	Antenna Requirement	Compliant
FCC §15.207, IC RSS-Gen §7.2.2	Conducted Emissions	Compliant
FCC § 15.407 (b) IC RSS210 A9.3	Spurious Emissions at Antenna Port	Compliant
FCC§15.205; §15.209 §15.407(b) IC RSS210 A9.3	Spurious Radiated Emissions	Compliant
FCC §15.247 (a) IC RSS210 A9.2	99% & 26 dB Bandwidth	Compliant
FCC §15.407 (a) IC RSS210 A9.2	Maximum Peak Output Power	Compliant
FCC § 15.407 (a)(6)	Peak Excursion	Compliant
FCC §15.407 (a) IC RSS210 A9.2	Power Spectral Density	Compliant
FCC §15.407 (h) IC RSS210 A9.4	DFS	Compliant (Refer to DFS report R0803191-DFS-FCC)

4 FCC§15.407 (f), §2.1091 & IC RSS-Gen 5.5, RSS-102 - RF Exposure

4.1 Applicable Standard

According to §15.407(f) and §1.1307(b)(1), systems operating under the provisions of this section shall be operated in a manner that ensures that the public is not exposed to radio frequency energy level in excess of the Commission's guidelines.

According to §1.1310 and §2.1091 RF exposure is calculated.

Limits for General Population/Uncontrolled Exposure

Limits for General Population/Uncontrolled Exposure				
Frequency Range (MHz)	Electric Field Strength (V/m)	Magnetic Field Strength (A/m)	Power Density (mW/cm ²)	Averaging Time (minutes)
0.3-1.34	614	1.63	*(100)	30
1.34-30	824/f	2.19/f	*(180/f ²)	30
30-300	27.5	0.073	0.2	30
300-1500	/	/	f/1500	30
1500-100,000	/	/	1.0	30

f = frequency in MHz

* = Plane-wave equivalent power density

According to RSS-102 Issue 2, November 2005 §2.5.2 exception from Routine Evaluation Limits- RF Exposure Evaluation:

RF exposure evaluation is required if the separation distance between the user and the device is greater than 20 cm, except when the device operates:

- 1) below 1.5 GHz and its e.i.r.p. is equal to or less than 2.5 W;
- 2) at or above 1.5 GHz and the e.i.r.p. of the device is equal to or less than 5 W.

4.2 MPE Prediction

Prediction of MPE limit at a given distance

Equation from page 18 of OET Bulletin 65, Edition 97-01

$$S = PG/4\pi R^2$$

Where: S = power density

P = power input to antenna

G = power gain of the antenna in the direction of interest relative to an isotropic radiator

R = distance to the center of radiation of the antenna

W53 Band:

<u>Maximum peak output power at antenna input terminal (dBm):</u>	<u>23.11</u>
<u>Maximum peak output power at antenna input terminal (mW):</u>	<u>204.64</u>
<u>Prediction distance (cm):</u>	<u>20</u>
<u>Prediction frequency (MHz):</u>	<u>5270</u>
<u>Maximum Antenna Gain, typical (dBi):</u>	<u>4.98</u>
<u>Maximum Antenna Gain (numeric):</u>	<u>3.15</u>
<u>Power density of prediction frequency at 20.0 cm (mW/cm²):</u>	<u>0.128</u>
<u>MPE limit for uncontrolled exposure at prediction frequency (mW/cm²):</u>	<u>1.0</u>

W56 Band:

<u>Maximum peak output power at antenna input terminal (dBm):</u>	<u>23.96</u>
<u>Maximum peak output power at antenna input terminal (mW):</u>	<u>248.89</u>
<u>Prediction distance (cm):</u>	<u>20</u>
<u>Prediction frequency (MHz):</u>	<u>5600</u>
<u>Maximum Antenna Gain, typical (dBi):</u>	<u>4.98</u>
<u>Maximum Antenna Gain (numeric):</u>	<u>3.15</u>
<u>Power density of prediction frequency at 20.0 cm (mW/cm²):</u>	<u>0.156</u>
<u>MPE limit for uncontrolled exposure at prediction frequency (mW/cm²):</u>	<u>1.0</u>

4.3 Results:**FCC§15.407 (f) and §2.1091:**

For W53, the power density level at 20 cm is 0.128 mW/cm², which is below the uncontrolled exposure limit of 1.0mW/cm² at 5270MHz.

For W56, the power density level at 20 cm is 0.156 mW/cm², which is below the uncontrolled exposure limit of 1.0mW/cm² at 5600MHz.

RSS-102 Issue 2:

The power of this device are 16.49 dBm (44.55mW) for W52; 23.11 dBm (204.49 mW) for W53; 23.96 dBm (248.96 mW) for W56 and the antenna gain used for evaluation was 4.98 dBi (representing the worst case), according to RSS-102 section 2.5.2, this device exempt the RF exposure evaluation

5 FCC §15.203 & IC RSS-Gen §7.1.4 - Antenna Requirement

5.1 Applicable Standard

According to § 15.203, an intentional radiator shall be designed to ensure that no antenna other than that furnished by the responsible party shall be used with the device. The use of a permanently attached antenna or of an antenna that uses a unique coupling to the intentional radiator shall be considered sufficient to comply with the provisions of this Section. The manufacturer may design the unit so that a broken antenna can be replaced by the user, but the use of a standard antenna jack or electrical connector is prohibited.

And according to § 15.407 (a)(1) and (a)(2), if transmitting antennas of directional gain greater than 6 dBi are used, the conducted output power and the peak power spectral density shall be reduced by the amount in dB that the directional gain of the antenna exceeds 6 dBi.

As per IC RSS-Gen §7.1.4: Transmitter Antenna, a transmitter can only be sold or operated with antennas with which it was certified. A transmitter may be certified with multiple antenna types. An antenna type comprises antennas having similar in-band and out-of-band radiation patterns. Testing shall be performed using the highest-gain antenna of each combination of transmitter and antenna type for which certification is being sought, with the transmitter output power set at the maximum level. Any antenna of the same type and having equal or lesser gain as an antenna that had been successfully tested for certification with the transmitter, will also be considered certified with the transmitter, and may be used and marketed with the transmitter. The manufacturer shall include with the application for certification a list of acceptable antenna types to be used with the transmitter.

5.2 Result:

Antenna Photos is required confidentiality

Antenna Pattern is required
confidentiality

The antenna is capable of 64 different element combinations with the peak gain of each individual pattern of 4.98dBi, the lowest peak gain is -2.53dBi. It is not possible for both chains to point in the same direction. The highest gain for which both antennas point in the same direction is 1.5dBi.

6 FCC §15.207 (a) & IC RSS-Gen §7.2.2 - Conducted Emissions

6.1 Section 15.207 Conducted limits:

For an intentional radiator that is designed to be connected to the public utility (AC) power line, the radio frequency voltage that is conducted back onto the AC power line on any frequency or frequencies within the band 150 kHz to 30 MHz shall not exceed the limits in the following table, as measured using a 50 μ H/50 ohms line impedance stabilization network (LISN). Compliance with the provisions of this paragraph shall be based on the measurement of the radio frequency voltage between each power line and ground at the power terminal. The lower limit applies at the boundary between the frequency ranges.

Frequency of Emission (MHz)	Conducted Limit (dBuV)	
	Quasi-peak	Average
0.15-0.5	66 to 56 *	56 to 46 *
0.5-5	56	46
5-30	60	50

* Decreases with the logarithm of the frequency.

6.2 Test Setup

The measurement was performed at shield room, using the setup per ANSI C63.4 – 2003 measurement procedure. The specification used was FCC Class B limits.

External I/O cables were draped along the edge of the test table and bundle when necessary.

The EUT was connected with LISN-1.

6.3 Test Equipment List and Details

Manufacturer	Description	Model	Serial Number	Calibration Date
Rohde & Schwarz	Artificial-Mains Network	ESH2-Z5	871884/039	2007-11-14
Rohde & Schwarz	EMI Test Receiver	ESCS30	100176	2008-03-31

* **Statement of Traceability:** BACL Corp. attests that all calibrations have been performed per the NVLAP requirements, traceable to the NIST.

6.4 Test Procedure

During the conducted emissions test, the power cord of the EUT was connected to the mains outlet of the LISN-1.

Maximizing procedure was performed on the six (6) highest emissions of the EUT.

All data was recorded in the peak detection mode, quasi-peak and average. Quasi-Peak readings are distinguished with a “QP”. Average readings are distinguished with an “Ave”.

6.5 Test Setup Diagram

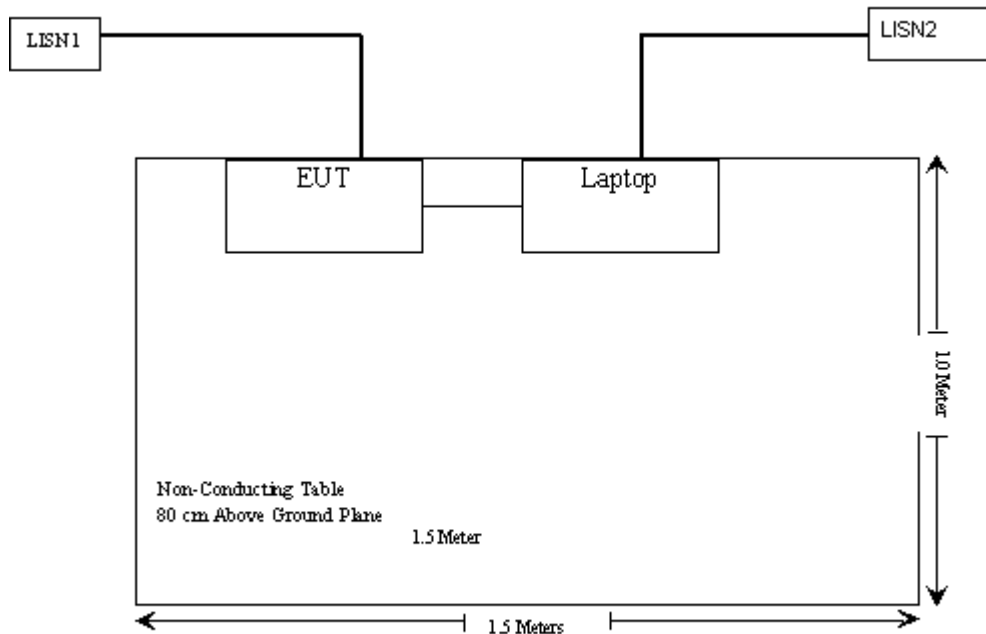

6.6 Environmental Conditions

Temperature:	20° C
Relative Humidity:	40%
ATM Pressure:	1019 mbar

**The testing was performed by Xiao Ming Hu from 2008-05-08 to 2008-05-14*

6.7 Summary of Test Results

According to the recorded data in following table, the EUT complied with the FCC 15.207 and IC RSS-Gen with the *worst* margin reading of:

-9.96 dB at 0.258 MHz in the Neutral conductor mode for Power Supply DSA-12R-12AUS
-2.4 dB at 0.683 MHz in the Live conductor mode for Power Supply MPB-1201250

6.8 Test Plot and Data

For Power Supply DSA-12R-12AUS

120V/60 Hz Line:

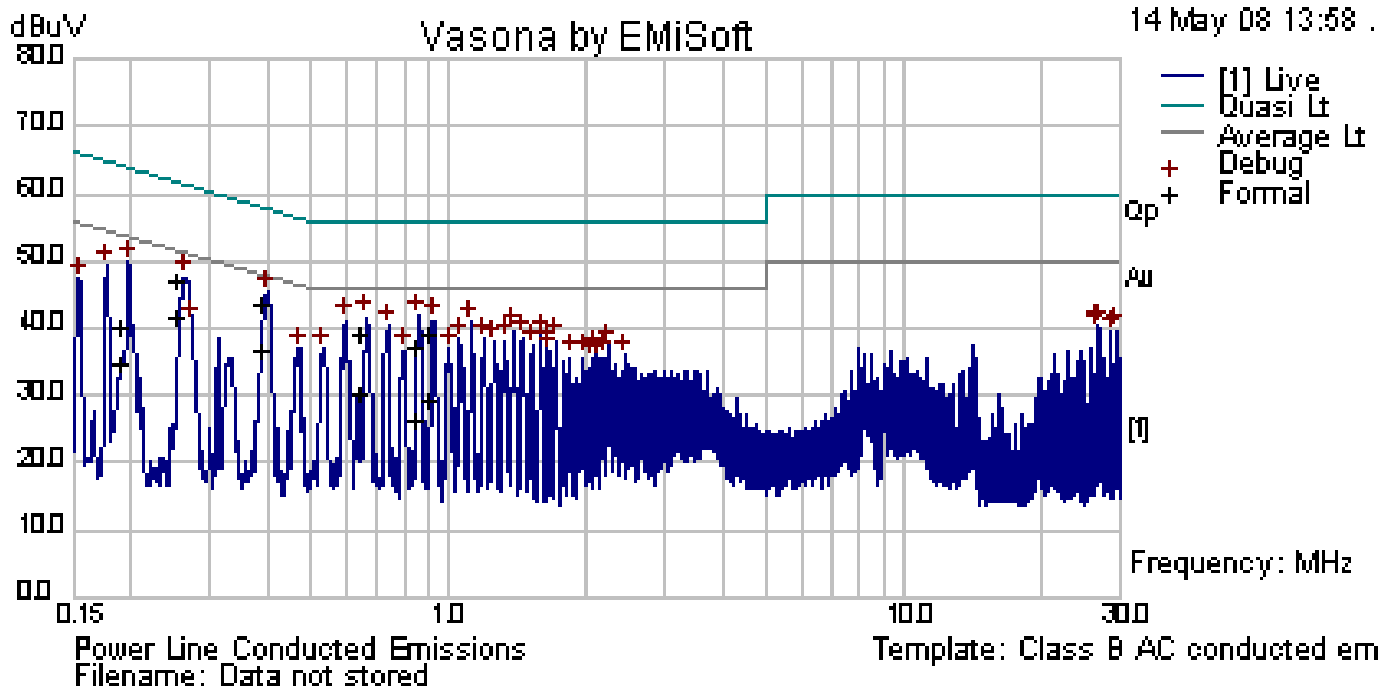

Quasi-Peak and Average Measurements:

Frequency (MHz)	Raw data (dBuV)	Cable Loss (dB)	Corrected Reading (dBuV)	Measurement Type	Line (N/L)	Limit (dBuV)	Margin (dB)
0.257	27.38	12.2	39.58	Average	Live	51.53	-11.95
0.396	21.83	12.39	34.22	Average	Live	47.94	-13.72
0.396	28.72	12.39	41.11	Quasi Peak	Live	57.94	-16.83
0.257	32.49	12.2	44.69	Quasi Peak	Live	61.53	-16.84
0.644	15.89	12.3	28.19	Average	Live	46	-17.81
0.912	14.82	12.3	27.12	Average	Live	46	-18.88
0.644	24.64	12.3	36.94	Quasi Peak	Live	56	-19.06
0.912	24.36	12.3	36.66	Quasi Peak	Live	56	-19.34
0.854	22.84	12.3	35.14	Quasi Peak	Live	56	-20.86
0.194	20.27	12.09	32.36	Average	Live	53.86	-21.50
0.854	11.84	12.3	24.14	Average	Live	46	-21.86
0.194	25.58	12.09	37.66	Quasi Peak	Live	63.86	-26.19

120V/60 Hz Neutral:

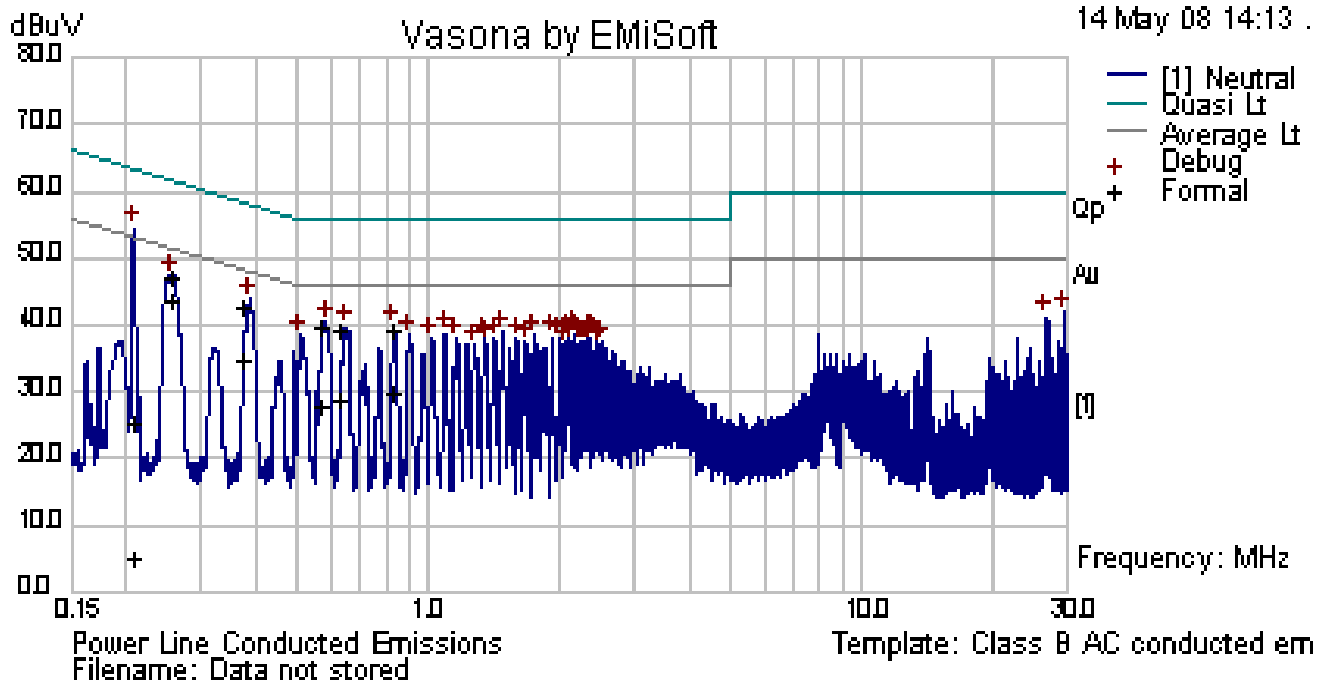

Quasi-Peak and Average Measurements:

Frequency (MHz)	Raw data (dBuV)	Cable Loss (dB)	Corrected Reading (dBuV)	Measurement Type	Line (L/N)	Limit (dBuV)	Margin (dB)
0.258	29.34	12.2	41.54	Average	Neutral	51.5	-9.96
0.383	20.15	12.37	32.52	Average	Neutral	48.21	-15.68
0.258	32.68	12.2	44.88	Quasi Peak	Neutral	61.5	-16.62
0.383	28.15	12.37	40.52	Quasi Peak	Neutral	58.21	-17.69
0.838	15.35	12.3	27.65	Average	Neutral	46	-18.35
0.575	25.28	12.3	37.58	Quasi Peak	Neutral	56	-18.42
0.641	24.82	12.3	37.12	Quasi Peak	Neutral	56	-18.88
0.838	24.63	12.3	36.93	Quasi Peak	Neutral	56	-19.07
0.641	14.28	12.3	26.58	Average	Neutral	46	-19.42
0.575	13.32	12.3	25.62	Average	Neutral	46	-20.38
0.215	10.97	12.2	23.17	Quasi Peak	Neutral	63.03	-39.85
0.215	-9.41	12.2	2.79	Average	Neutral	53.03	-50.23

For Power SupplyMPB-1201250

120V/60 Hz Line:

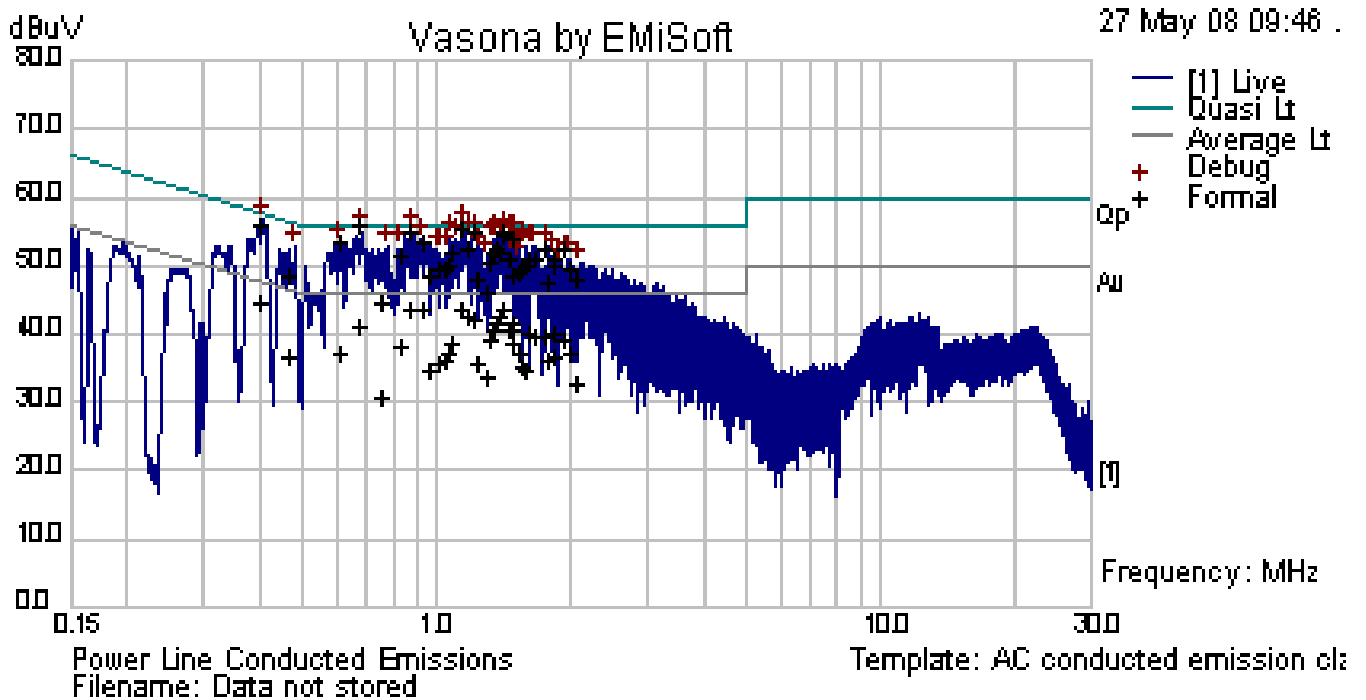

Quasi-Peak and Average Measurements:

Frequency (MHz)	Raw data (dBuV)	Cable Loss (dB)	Corrected Reading (dBuV)	Measurement Type	Line (L/N)	Limit (dBuV)	Margin (dB)
0.683	43.3	10.3	53.6	Quasi Peak	Live	56	-2.40
1.164	42.68	10.3	52.98	Quasi Peak	Live	56	-3.02
1.229	42.65	10.3	52.95	Quasi Peak	Live	56	-3.05
0.888	42.41	10.3	52.71	Quasi Peak	Live	56	-3.29
1.435	42.27	10.24	52.51	Quasi Peak	Live	56	-3.49
1.436	42.12	10.24	52.35	Quasi Peak	Live	56	-3.65
0.888	31.27	10.3	41.57	Average	Live	46	-4.43
1.435	31.08	10.24	41.32	Average	Live	46	-4.68
1.164	31.01	10.3	41.31	Average	Live	46	-4.69
0.944	30.9	10.3	41.2	Average	Live	46	-4.80
1.436	30.92	10.24	41.15	Average	Live	46	-4.85
0.408	32.05	10.39	42.44	Average	Live	47.69	-5.25

120V/60 Hz Neutral:

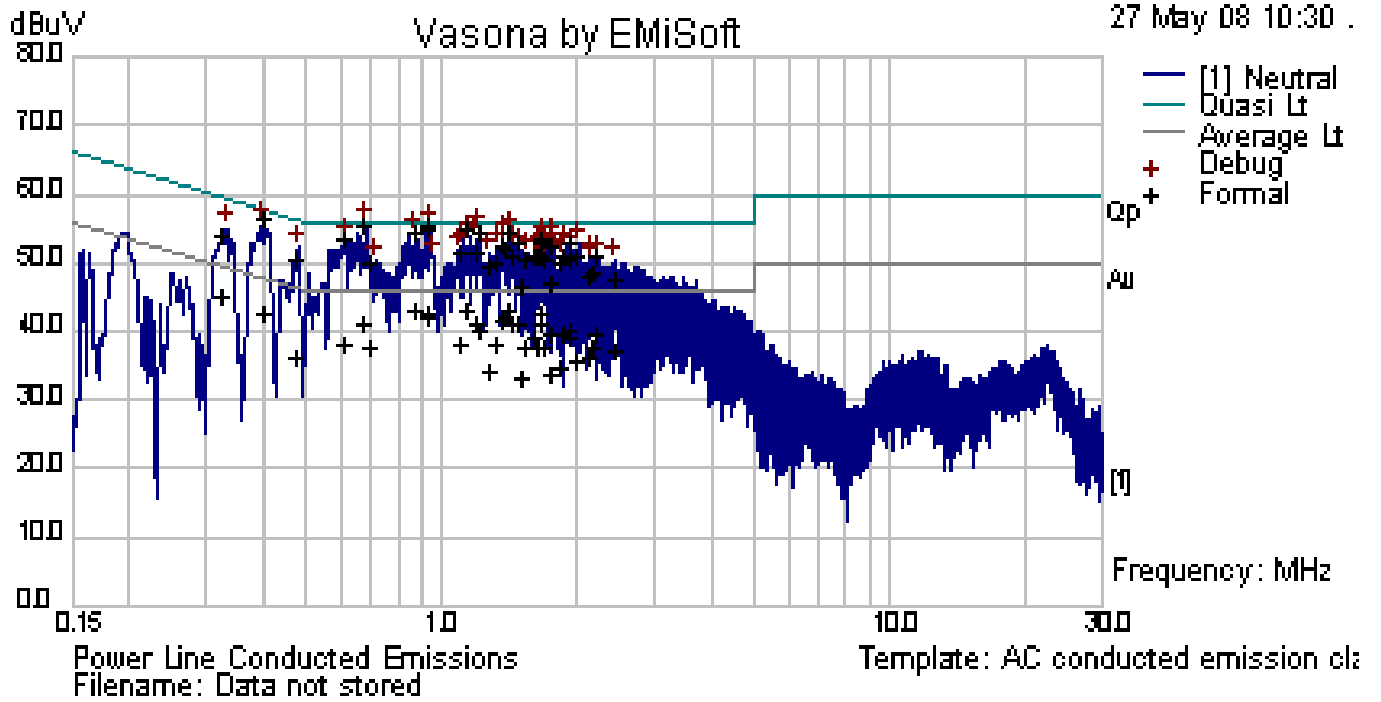

Quasi-Peak and Average Measurements:

Frequency (MHz)	Raw data (dBuV)	Cable Loss (dB)	Corrected Reading (dBuV)	Measurement Type	Line (L/N)	Limit (dBuV)	Margin (dB)
0.681	42.94	10.3	53.24	Quasi Peak	Neutral	56	-2.76
0.954	42.67	10.3	52.97	Quasi Peak	Neutral	56	-3.03
0.955	42.62	10.3	52.92	Quasi Peak	Neutral	56	-3.08
1.159	42.49	10.3	52.79	Quasi Peak	Neutral	56	-3.21
0.409	43.72	10.23	54.11	Quasi Peak	Neutral	57.66	-3.55
0.886	42.14	10.3	52.44	Quasi Peak	Neutral	56	-3.56
1.159	30.63	10.28	40.93	Average	Neutral	46	-5.07
0.886	30.49	10.25	40.79	Average	Neutral	46	-5.21
1.432	30.53	10.25	40.76	Average	Neutral	46	-5.24
1.705	30.16	10.3	40.46	Average	Neutral	46	-5.54
1.705	30.08	10.3	40.38	Average	Neutral	46	-5.62
0.955	29.98	10.3	40.28	Average	Neutral	46	-5.72

7 FCC §15.407(b) & RSS-210 § A9.3 - Spurious Emissions at Antenna Terminals

7.1 Applicable Standard

For §15.407 (b) (1) & (b) (2) and RSS210 A9.3 (1) (2), transmitters operating in the 5.15-5.35 GHz band: all emissions outside 5.15 – 5.35 GHz band shall not exceed an EIRP of -27 dBm/MHz

For §15.407 (b) (1) & (b)(2) and RSS210 A9.3 (3), transmitters operating in the 5.47 -5.725 GHz band: all emissions outside 5.47 – 5.725 GHz band shall not exceed an EIRP of -27 dBm/MHz

The spectrum was to be investigated to the tenth harmonics of the highest fundamental frequency as specified in §2.1057.

7.2 Measurement Procedure

The RF output of the EUT was connected to a spectrum analyzer through appropriate attenuation. The resolution bandwidth of the spectrum analyzer was set at 1 MHz. sufficient scans were taken to show any out of band emissions up to 10th harmonic.

7.3 Equipment Lists

Manufacturer	Description	Model	Serial Number	Calibration Date
Agilent	Analyzer, Spectrum	E4446A	US44300386	2008-03-19

* **Statement of Traceability: BACL Corp.** attests that all calibrations have been performed per the NVLAP requirements, traceable to the NIST.

7.4 Test Setup Diagram



7.5 Environmental Conditions

Temperature:	20° C
Relative Humidity:	40%
ATM Pressure:	1019 mbar

*The testing was performed by Xiao Ming Hu from 2008-05-28.

7.6 Measurement Result

Please refer to following pages for plots of spurious emissions.

7.6.1 5250-5350 MHz Band (W53)

802.11n 20MHz

Low Channel

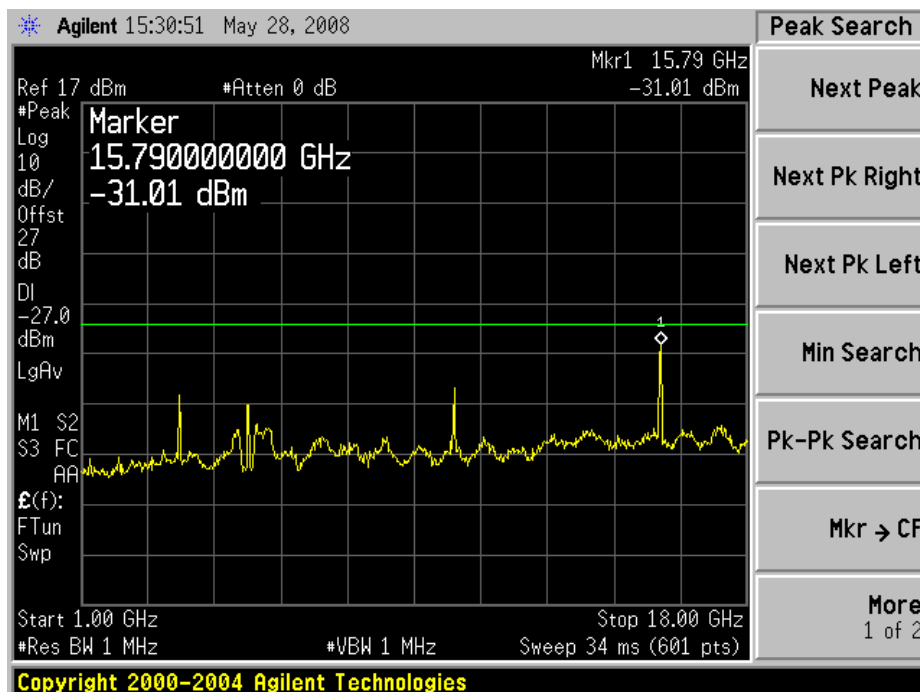
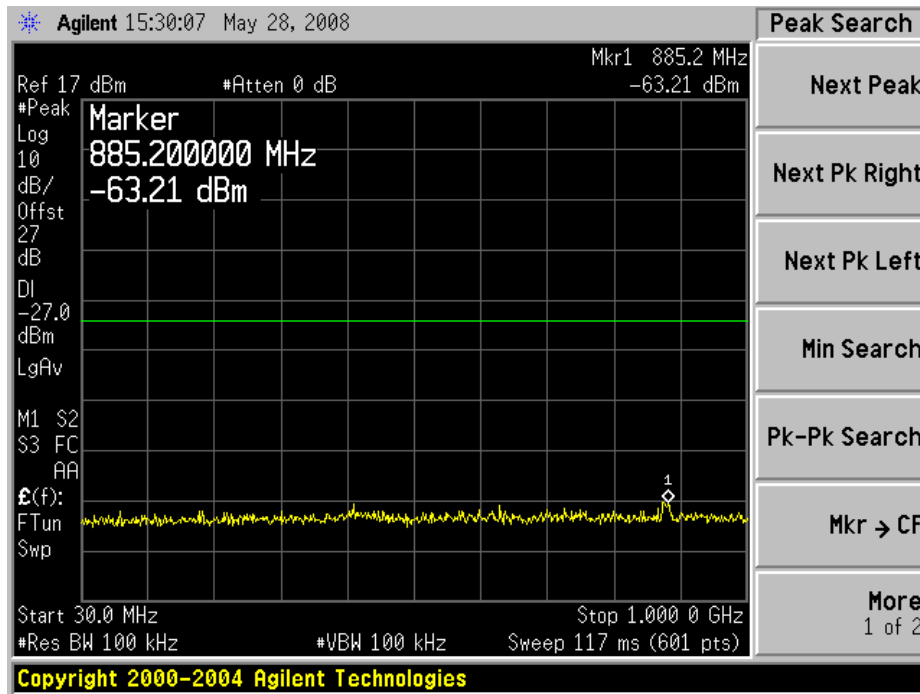



Middle Channel

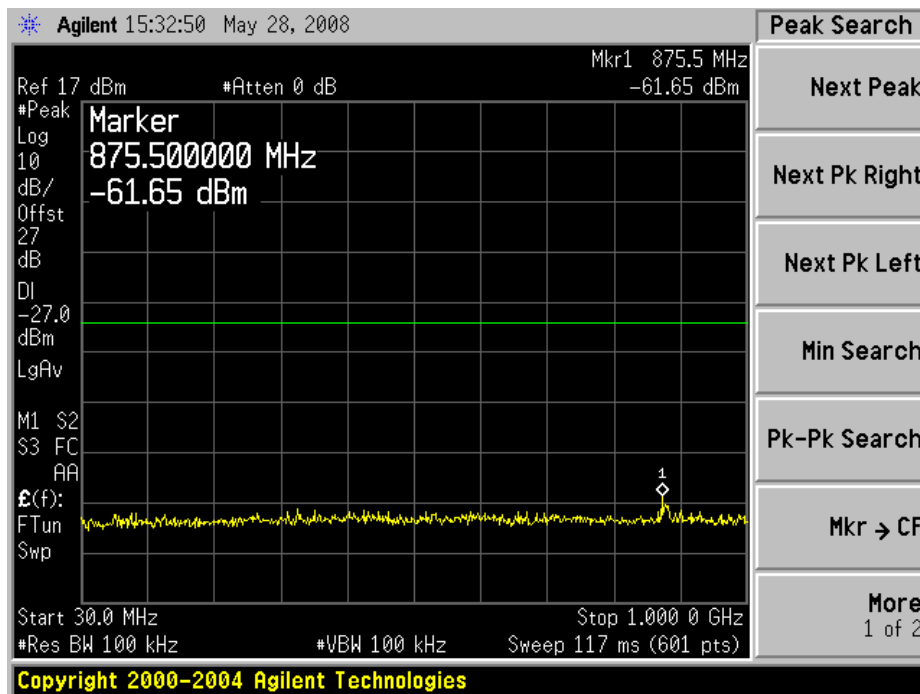

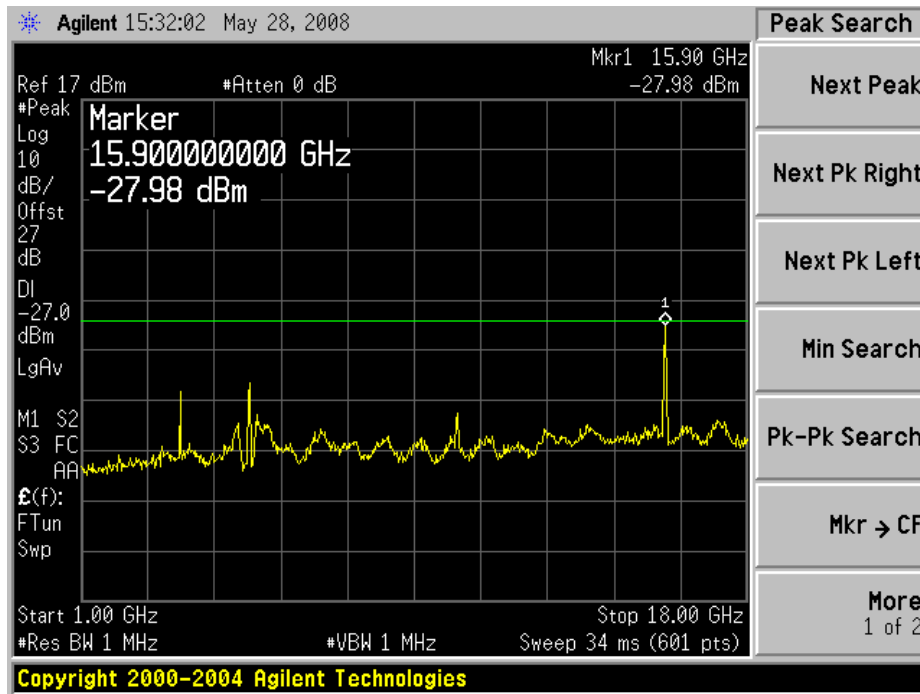

High Channel

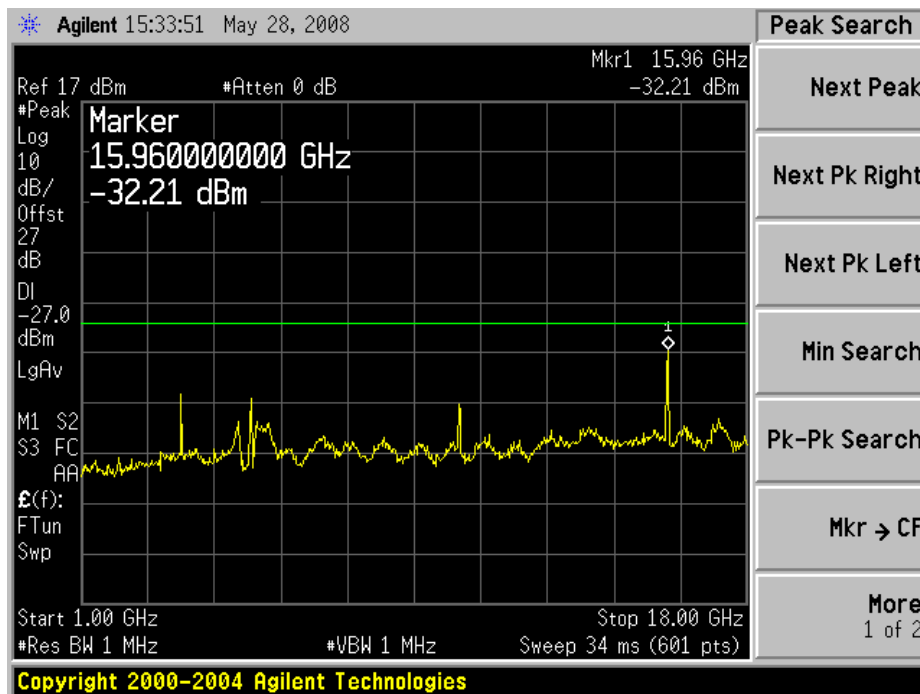
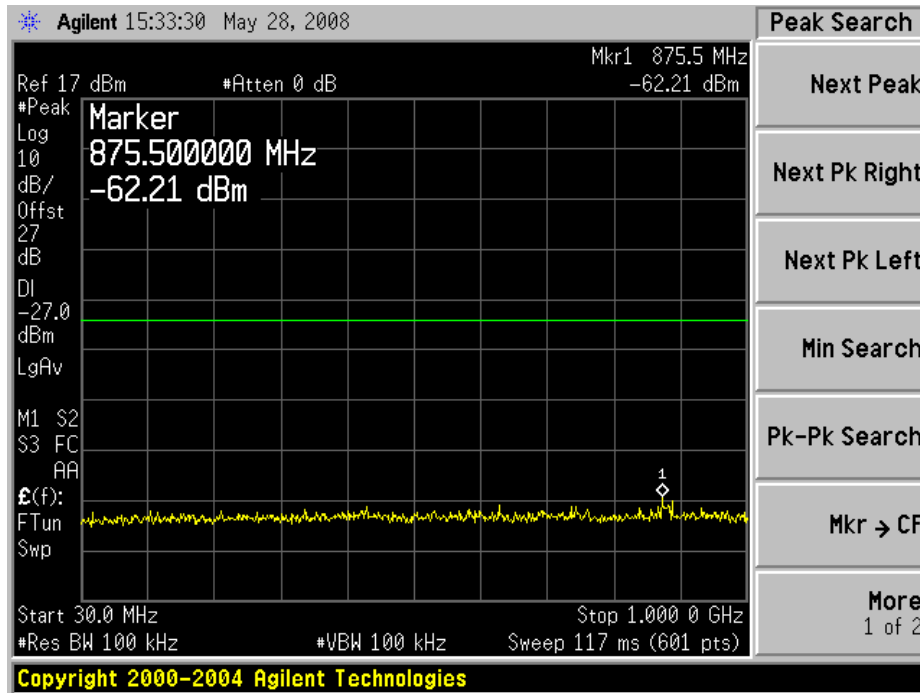



802.11a 20MHz

Low Channel

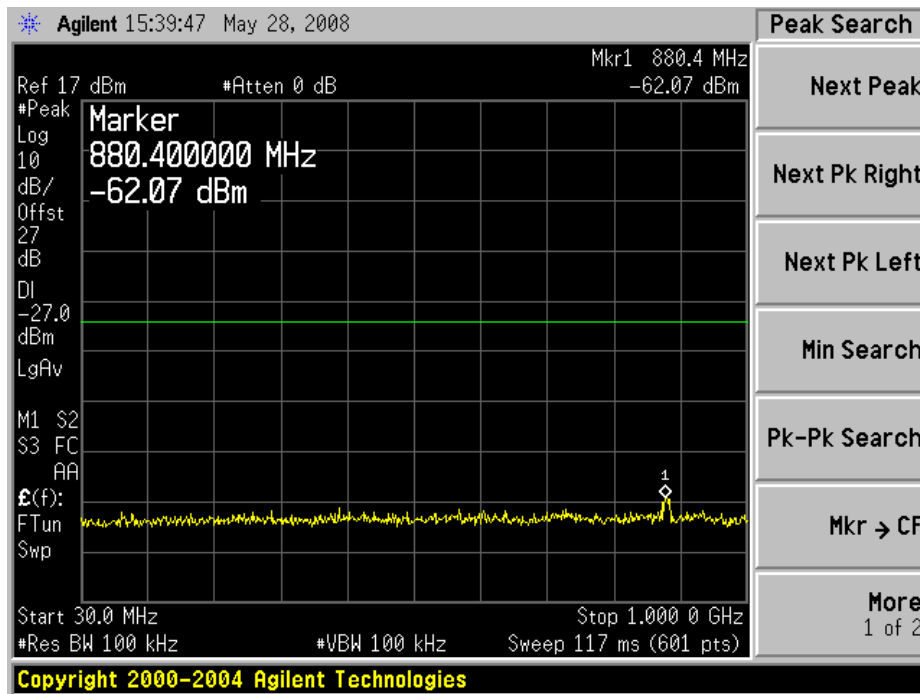

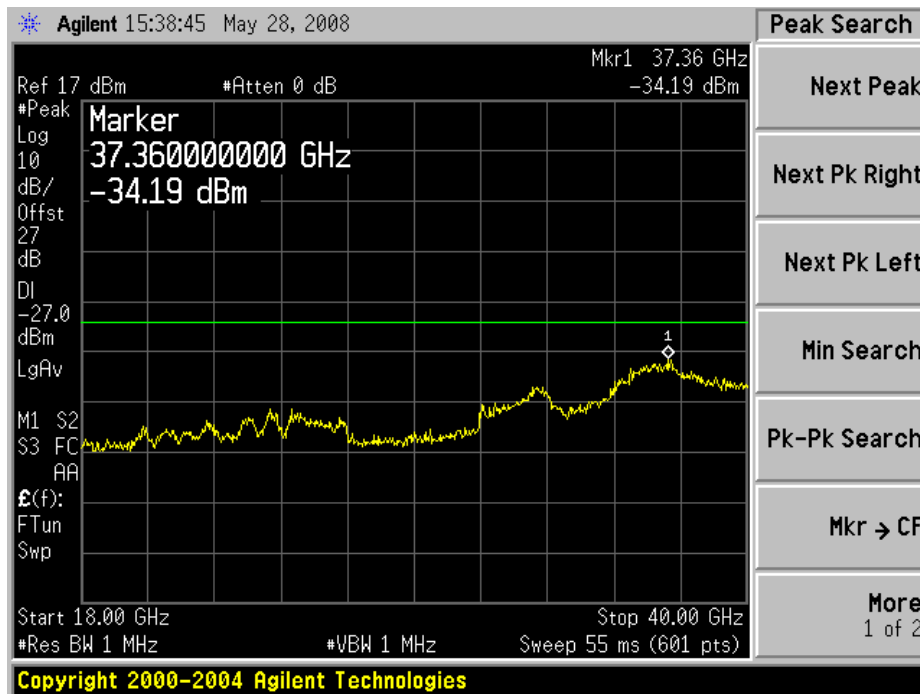
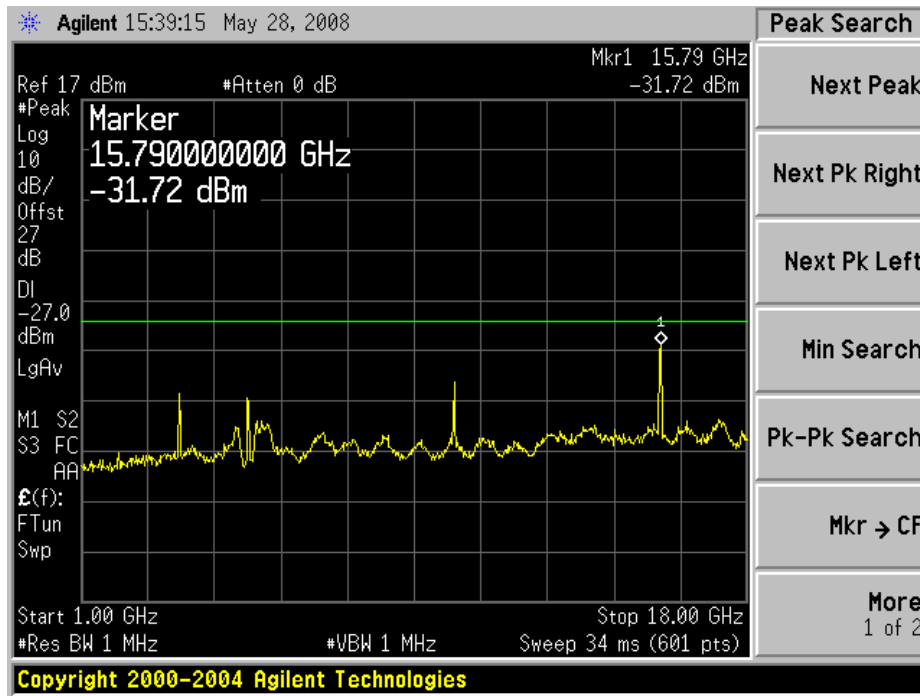

Middle Channel

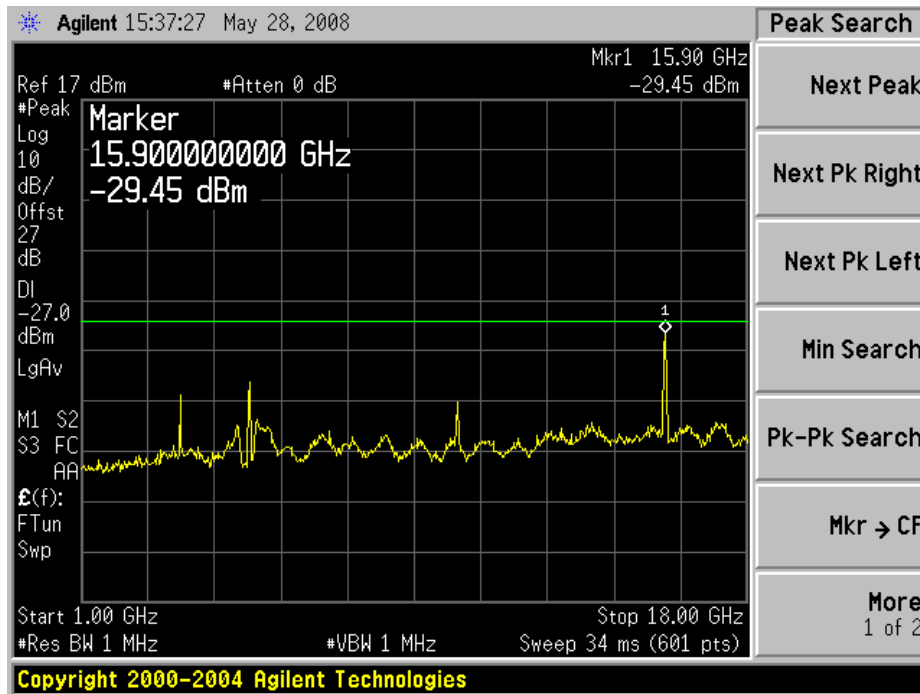
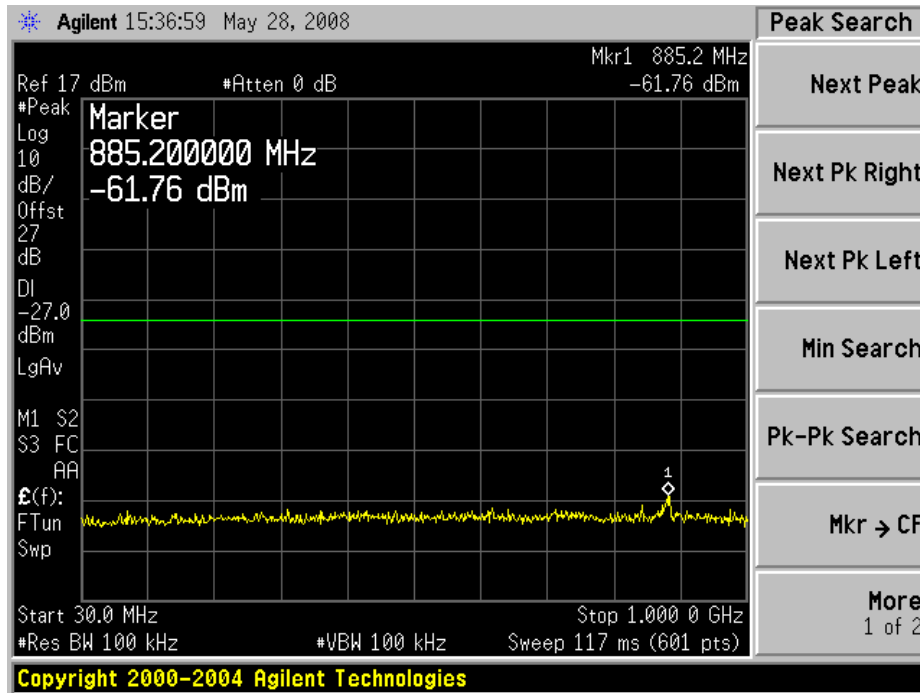



High Channel

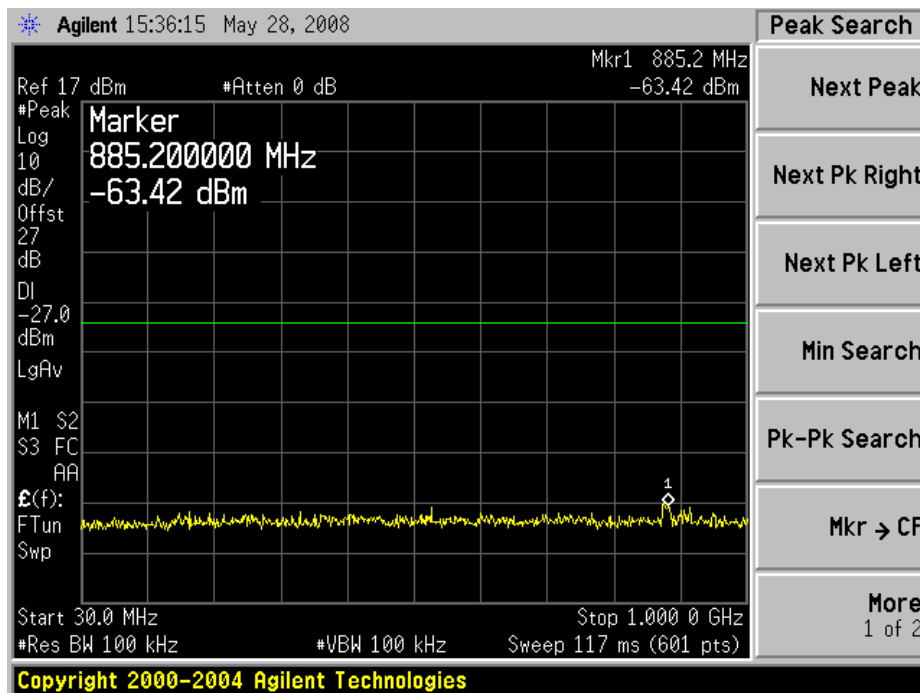

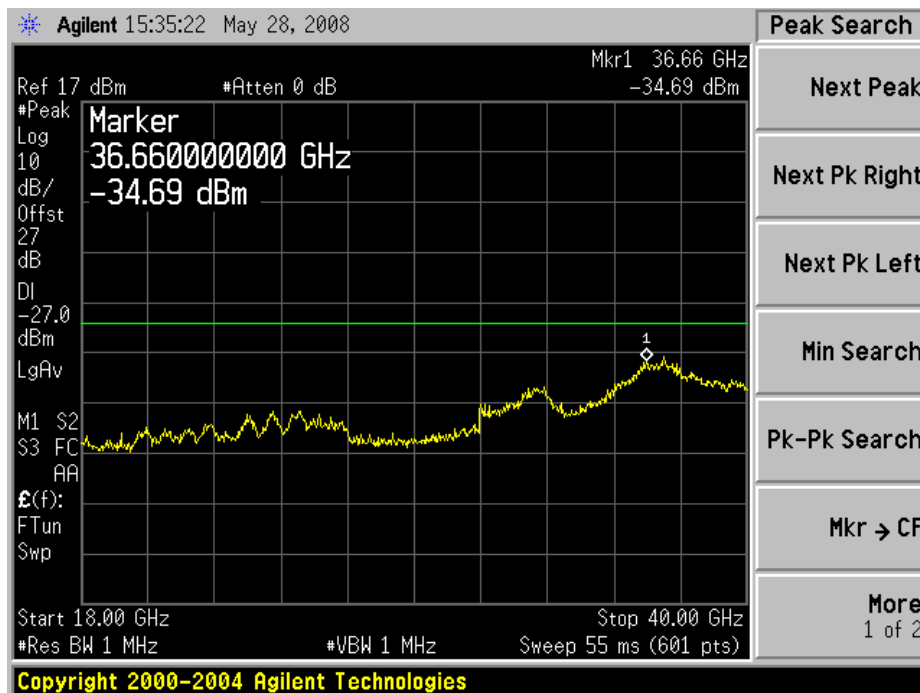
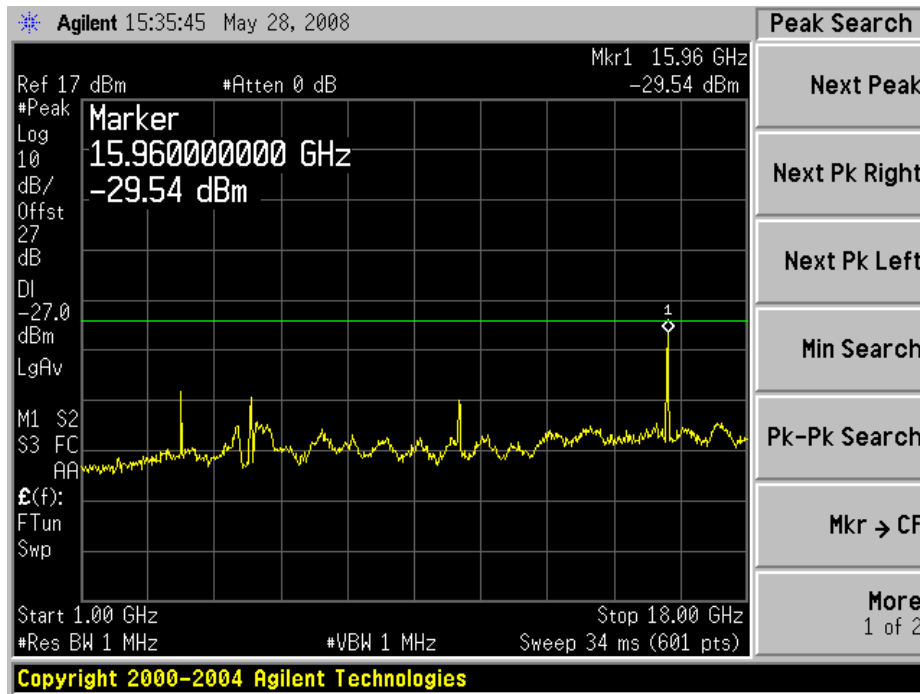

802.11n 40MHz

Low Channel

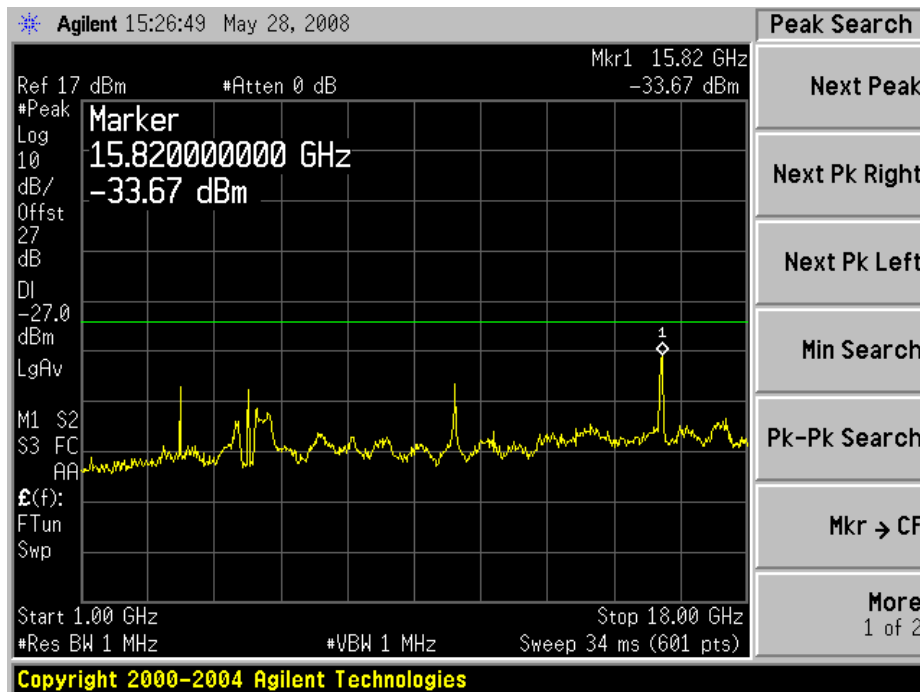
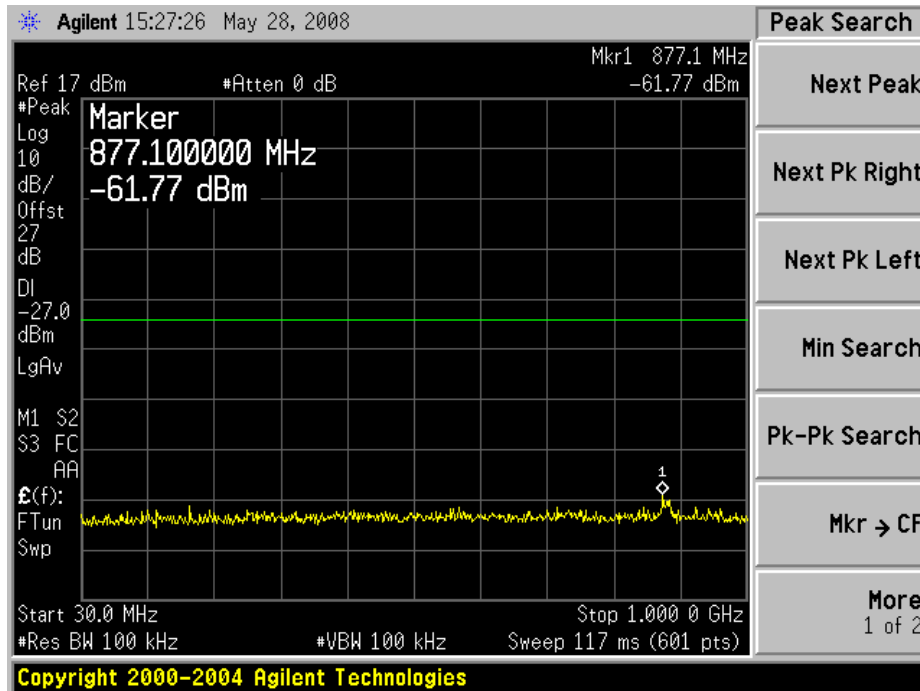



High Channel

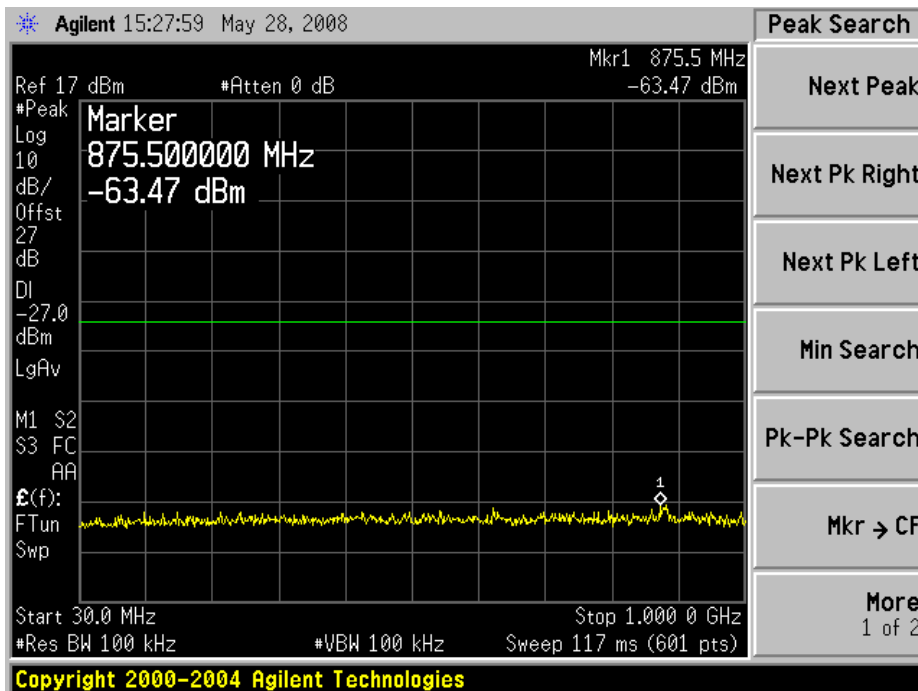

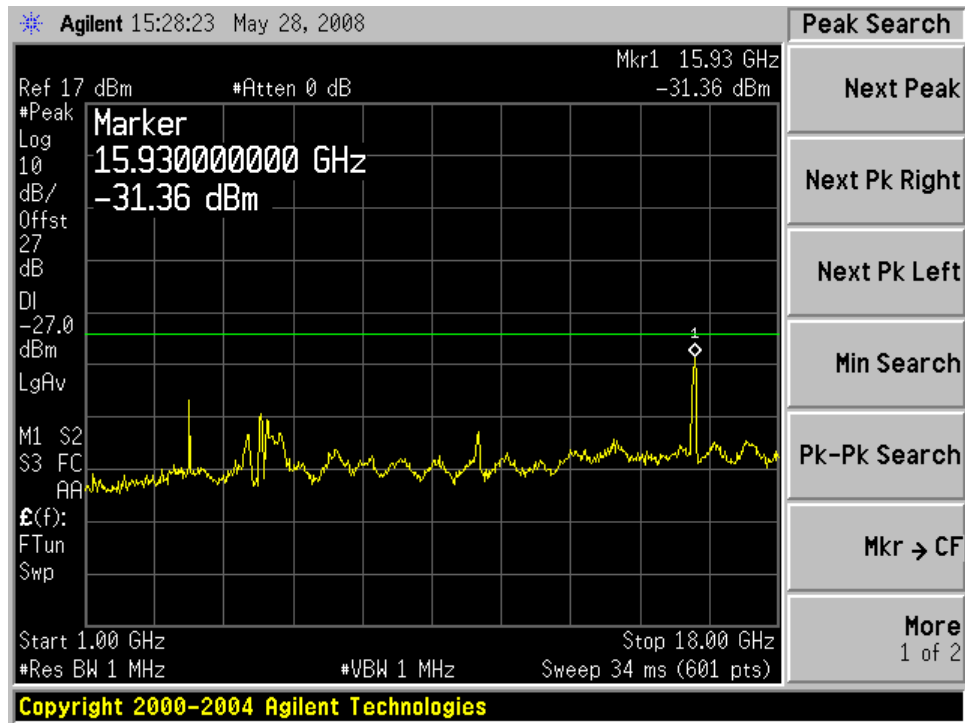

7.6.3 5470-5725 MHz Band (W56)

802.11n 20MHz

Low Channel

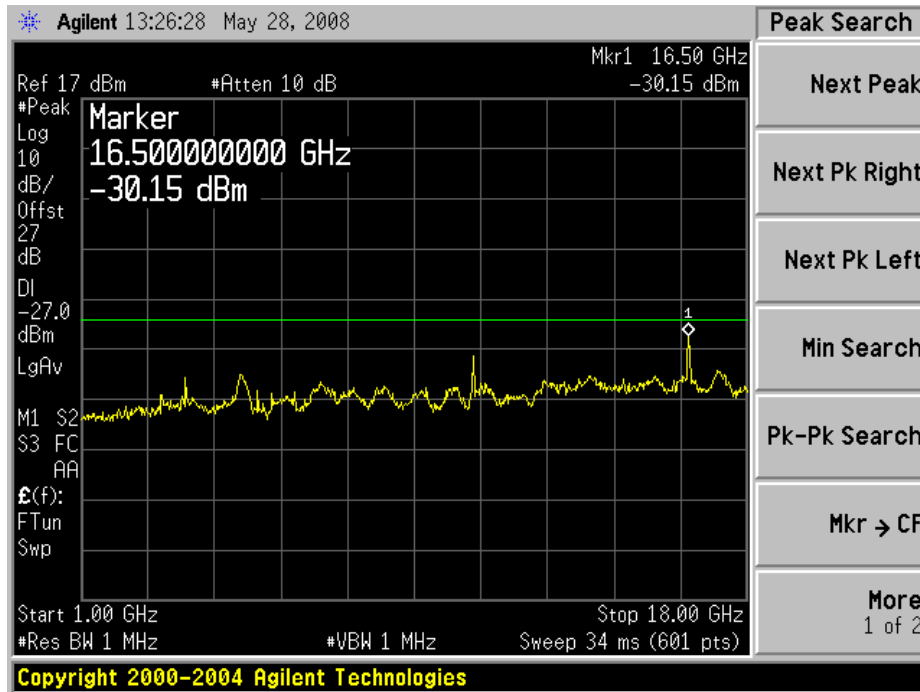
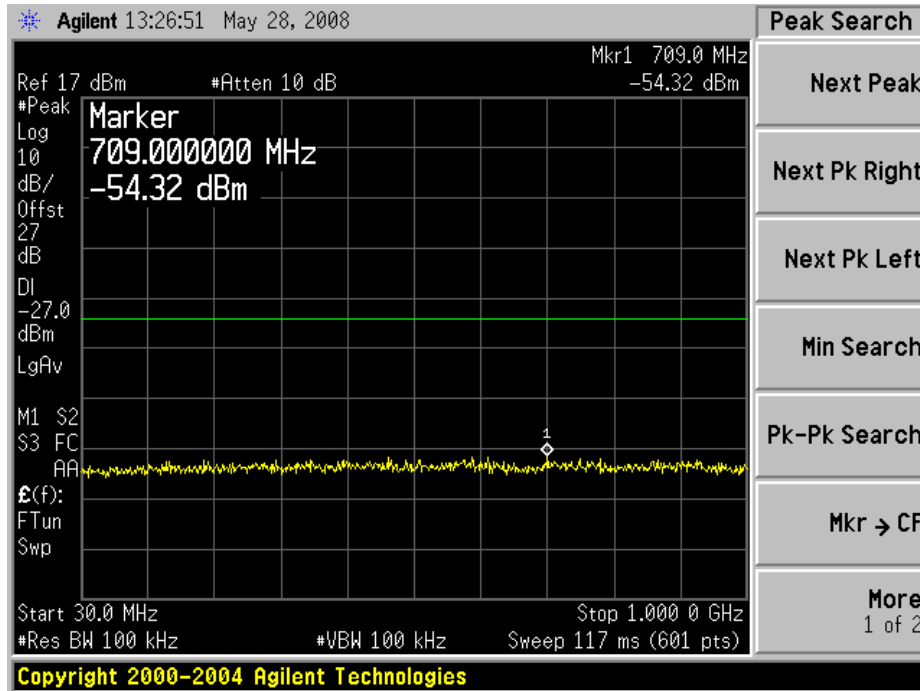



Middle Channel

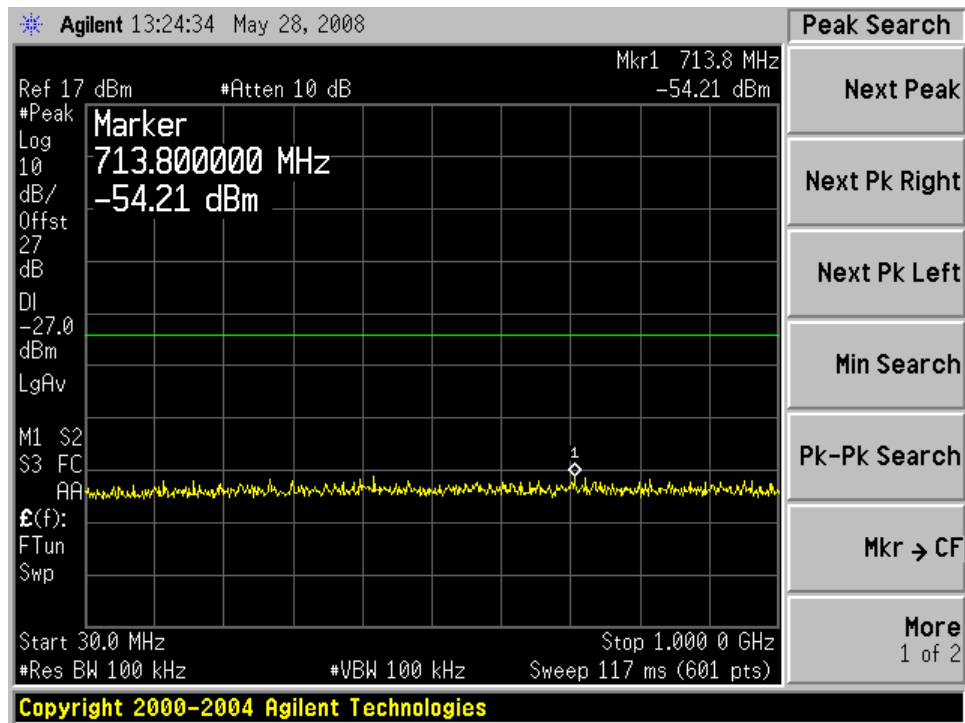

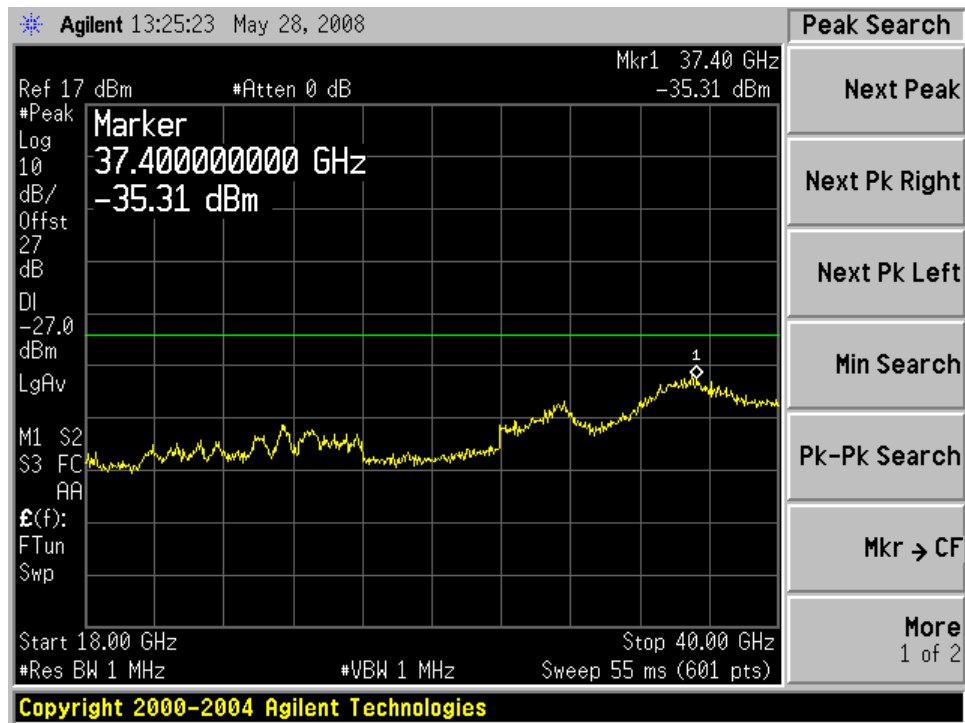
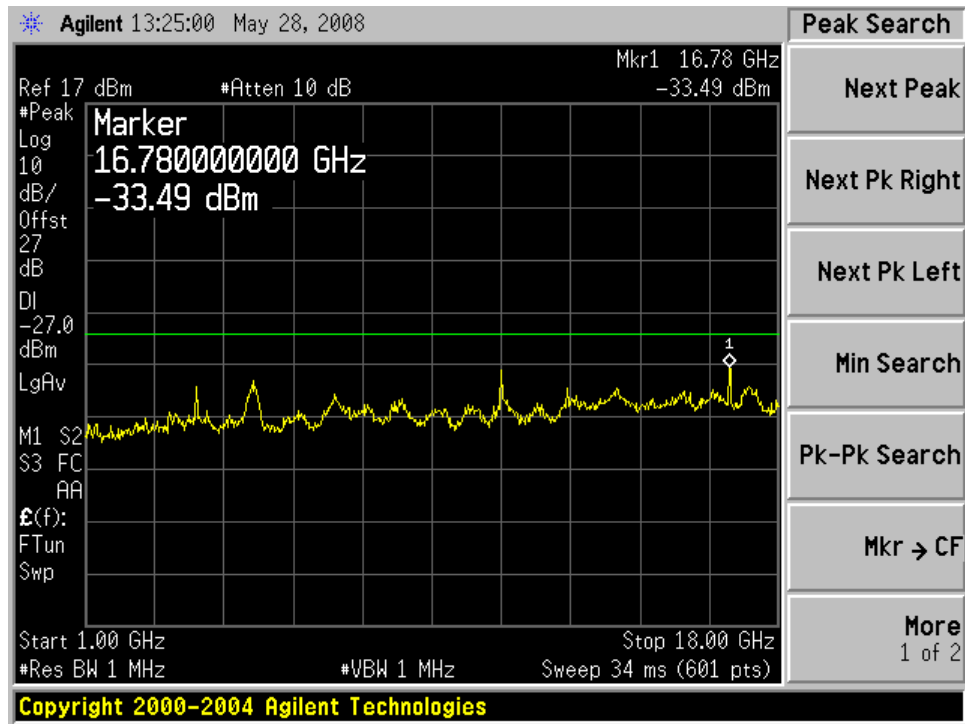

High Channel

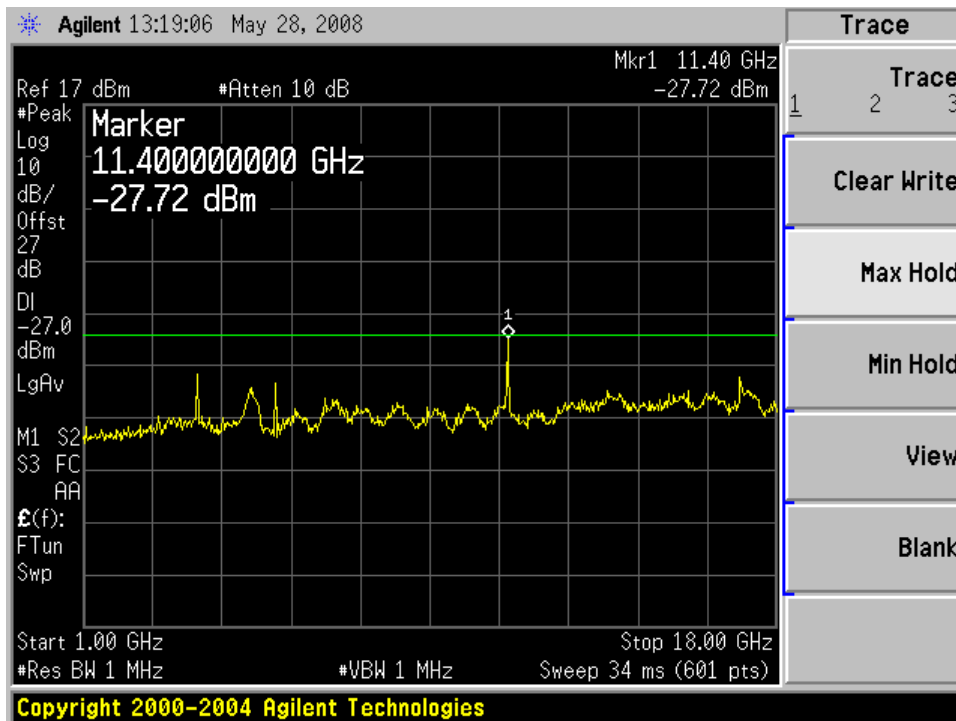
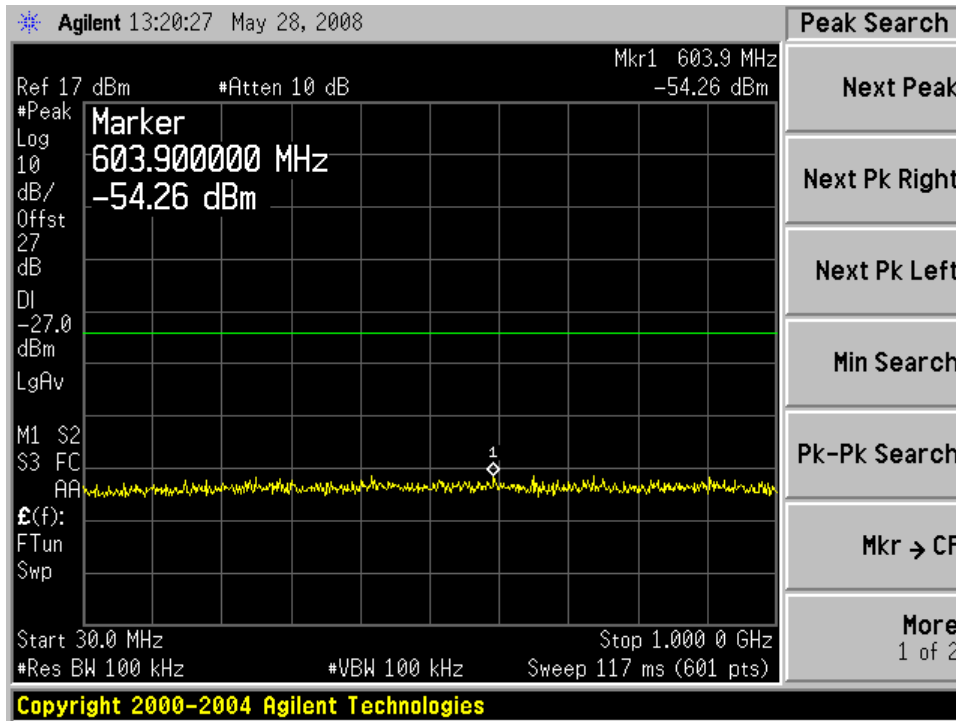

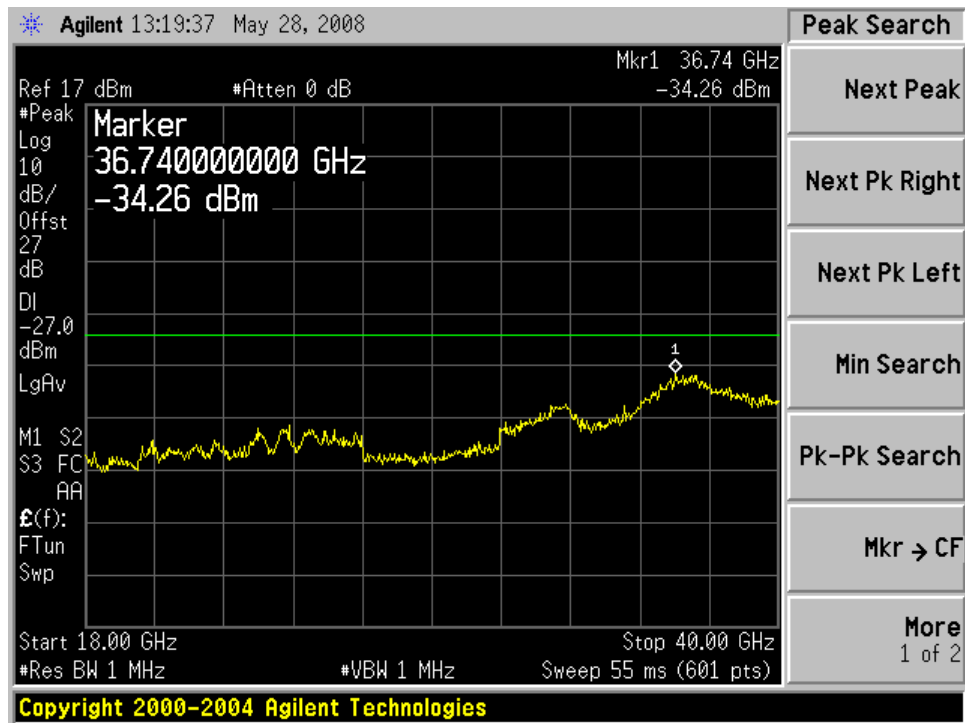

802.11a 20MHz

Low Channel

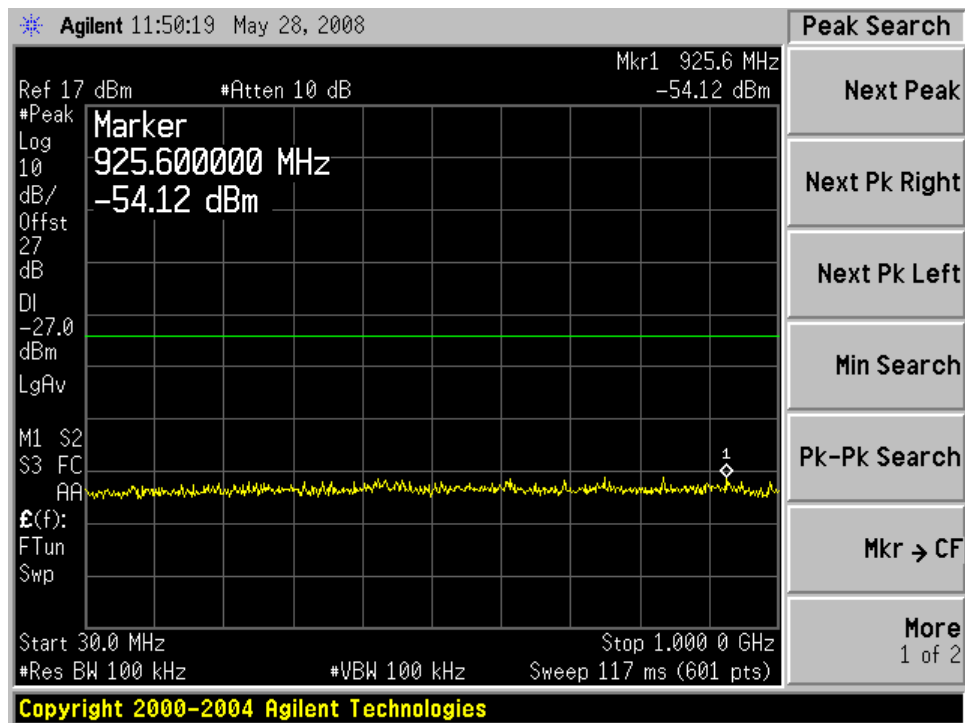

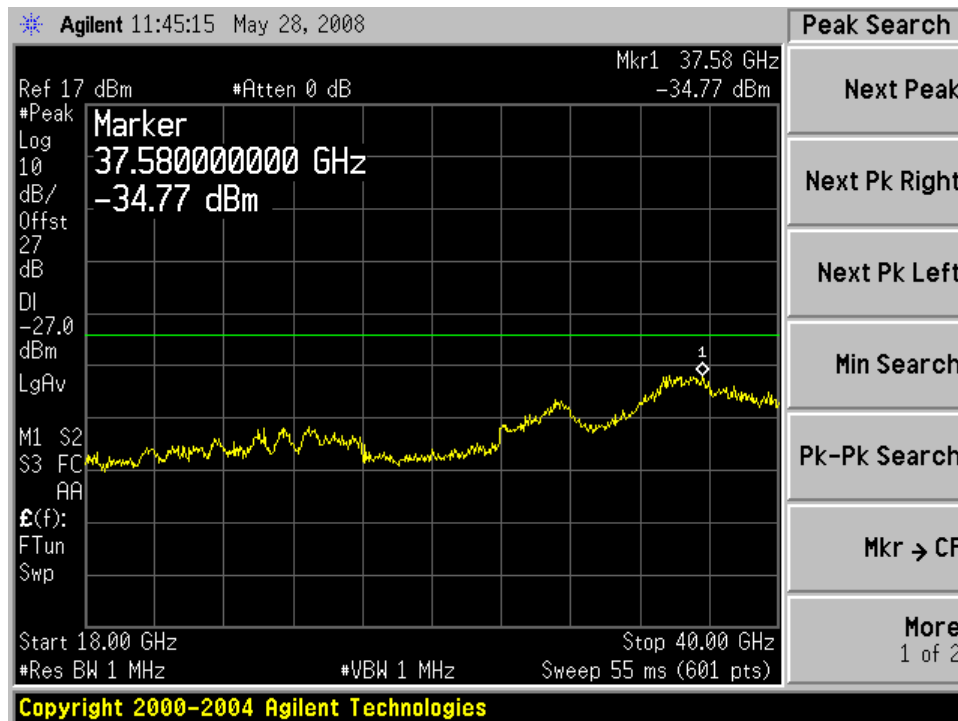
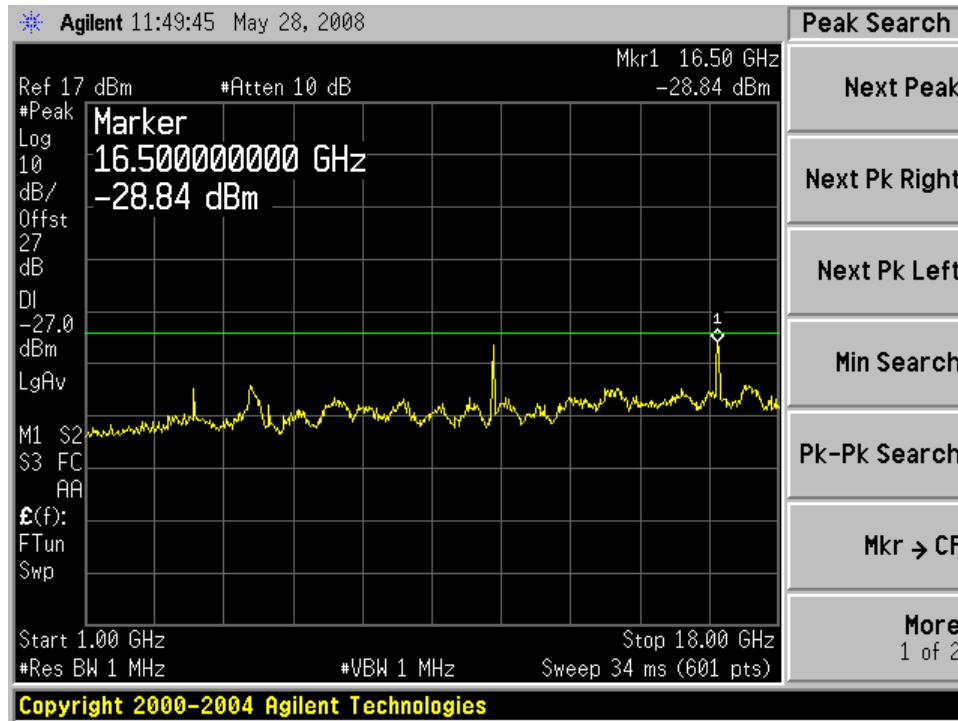

Middle Channel

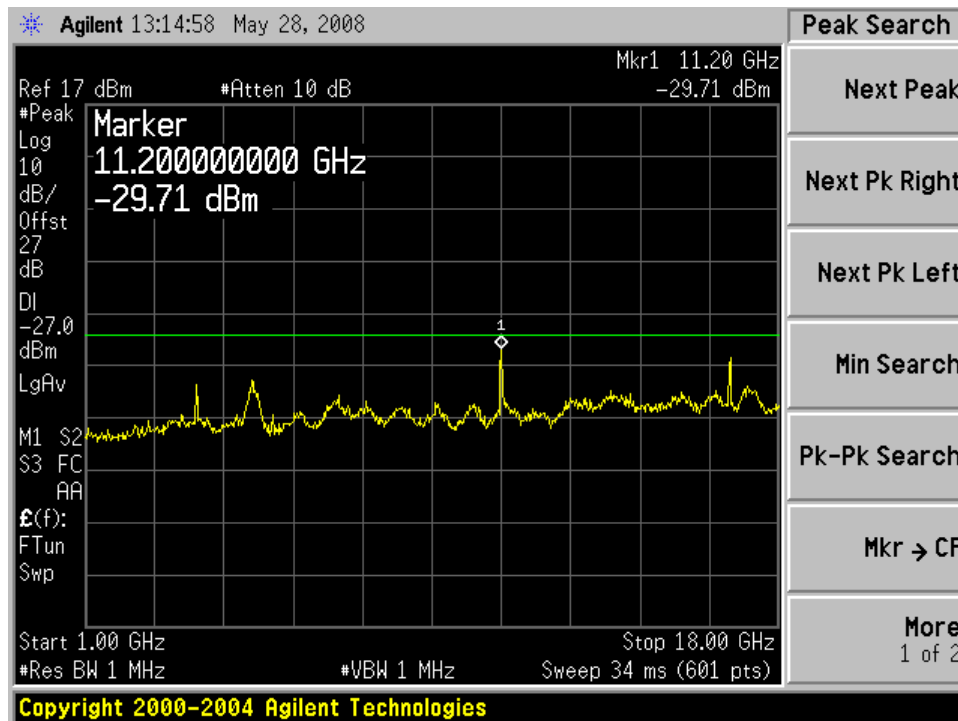
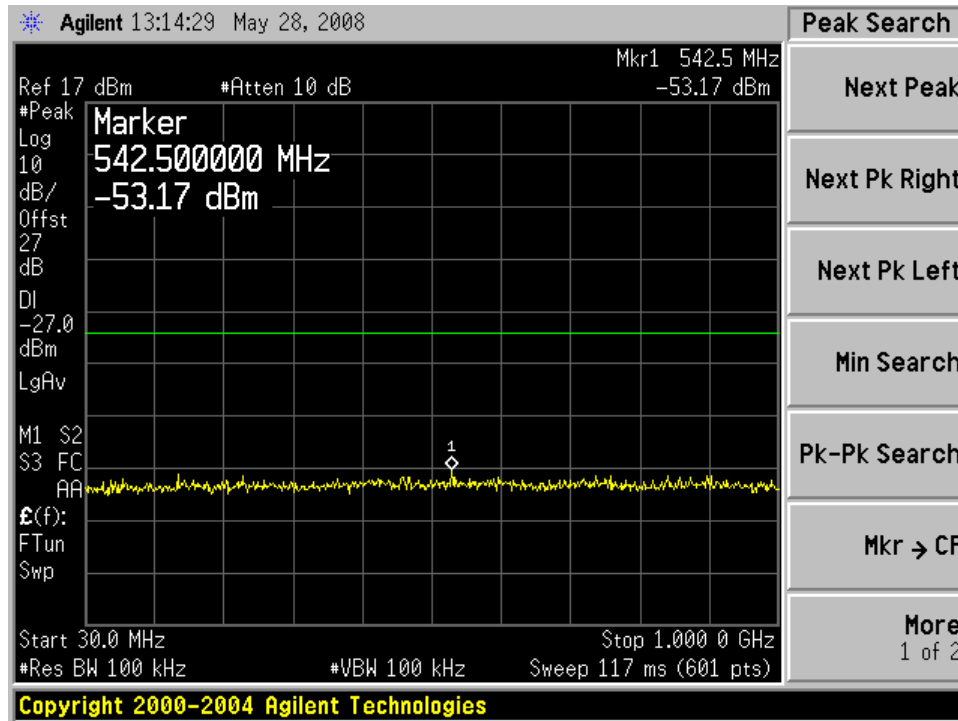

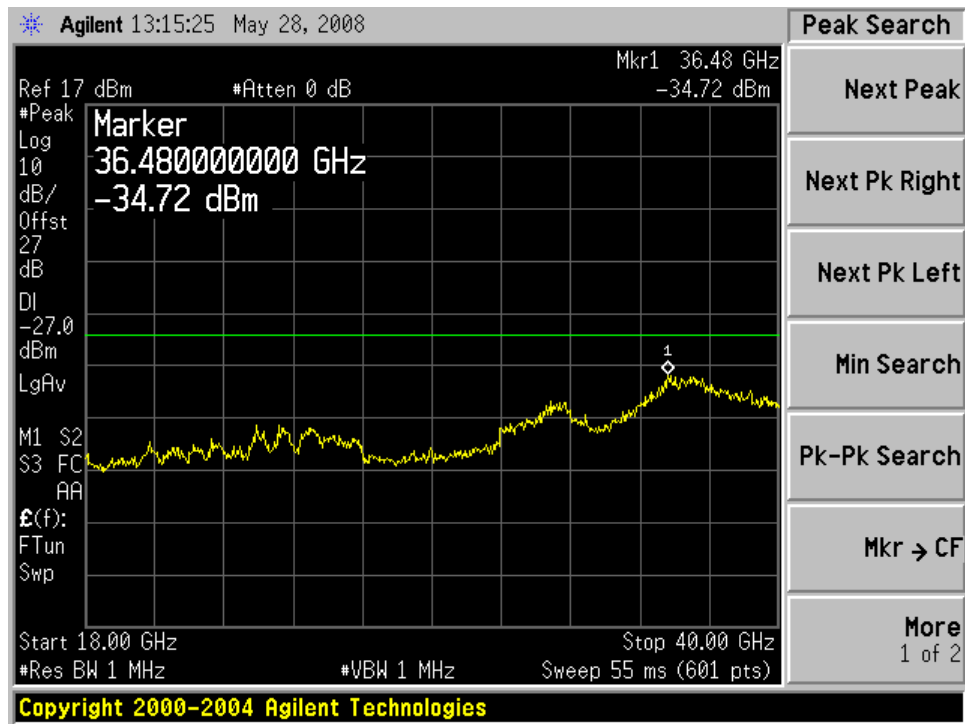

High Channel

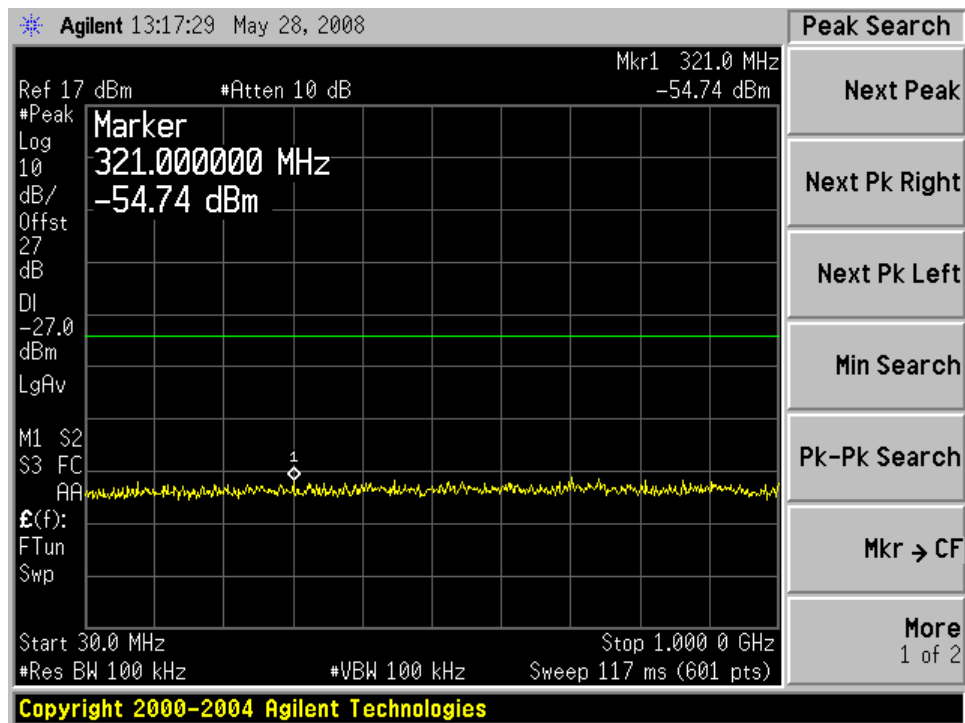

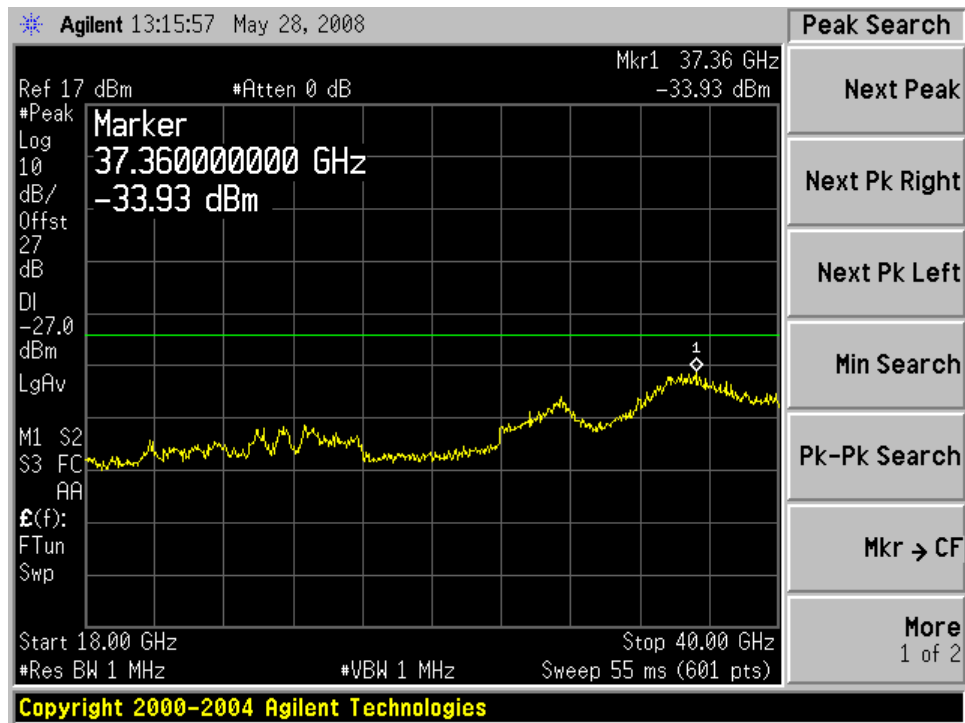
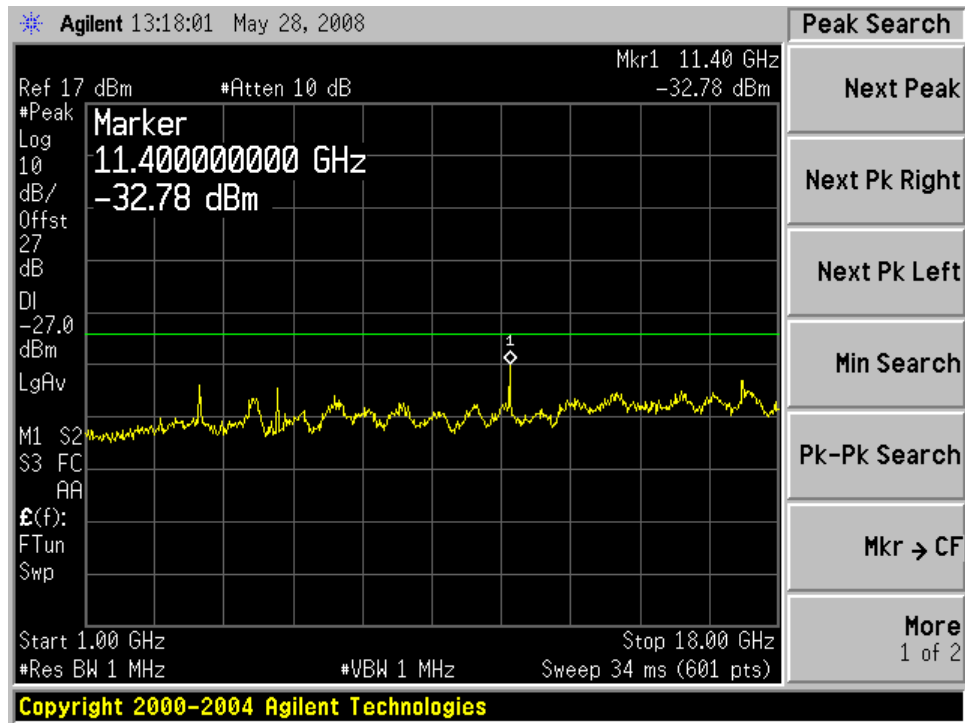

802.11n 40MHz

Low Channel

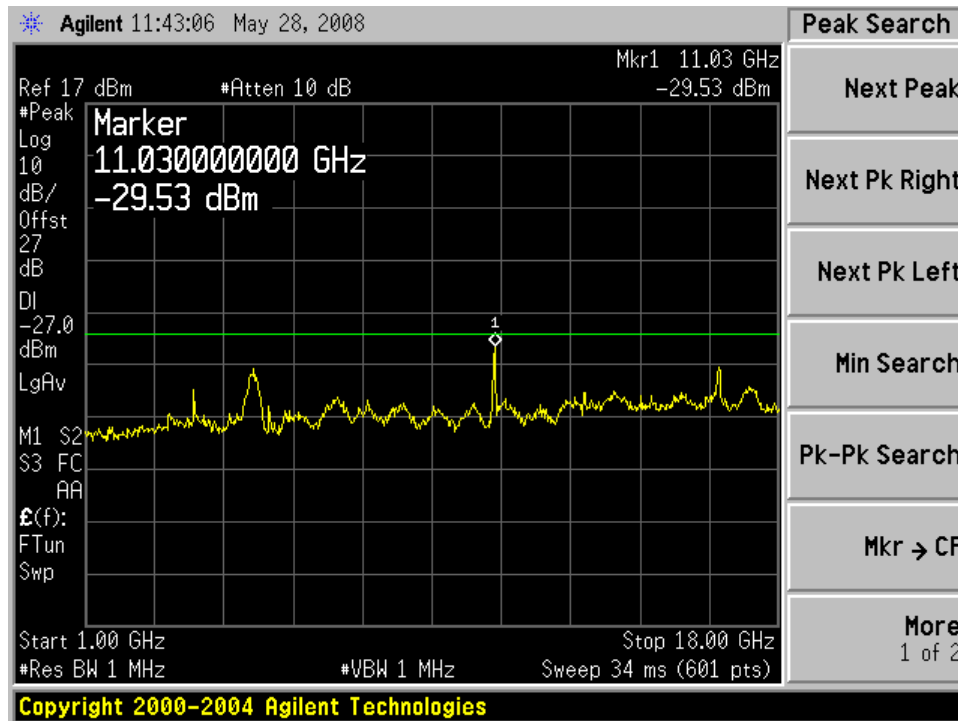
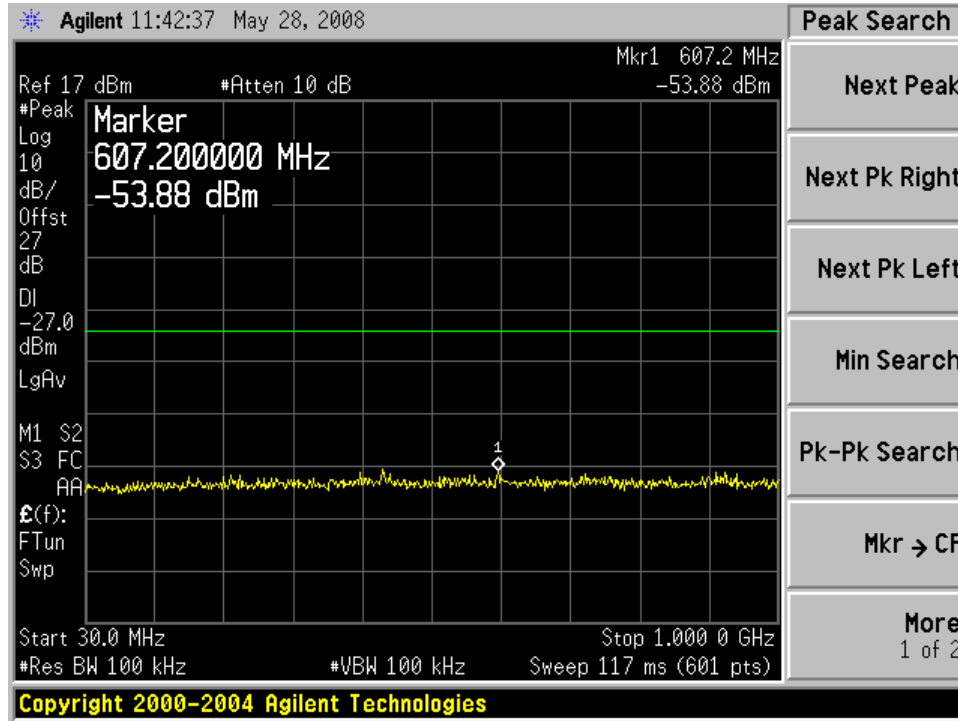



Middle Channel

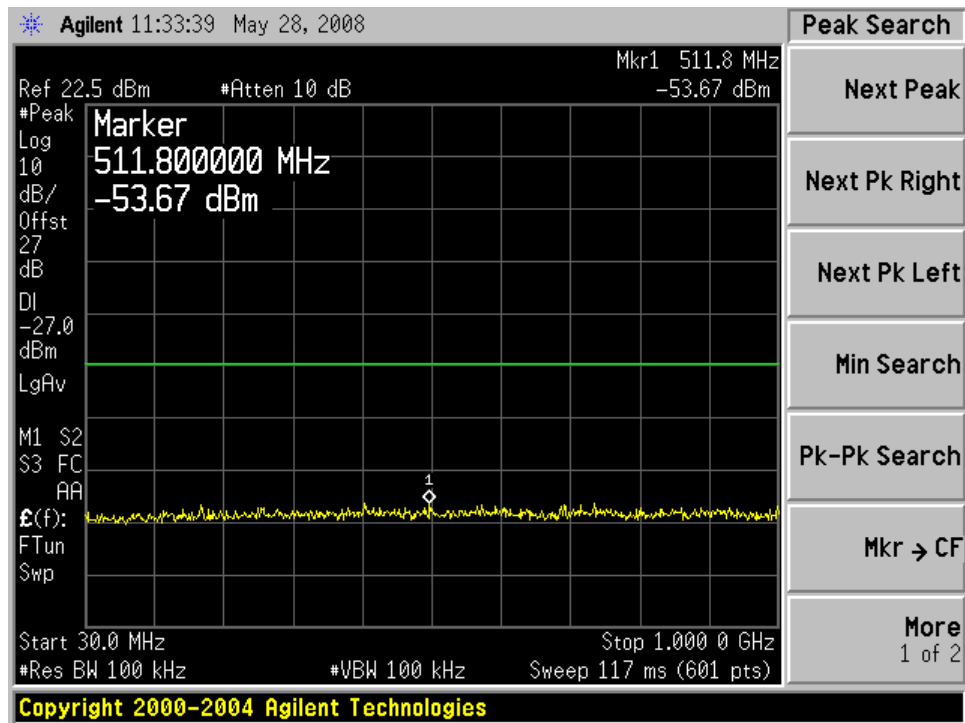

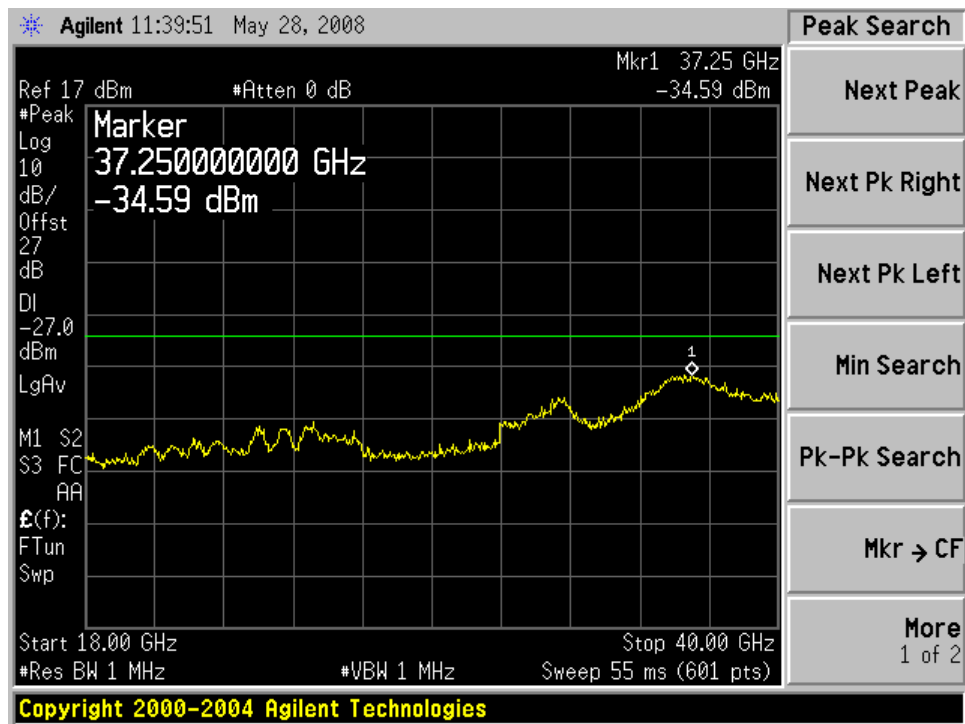
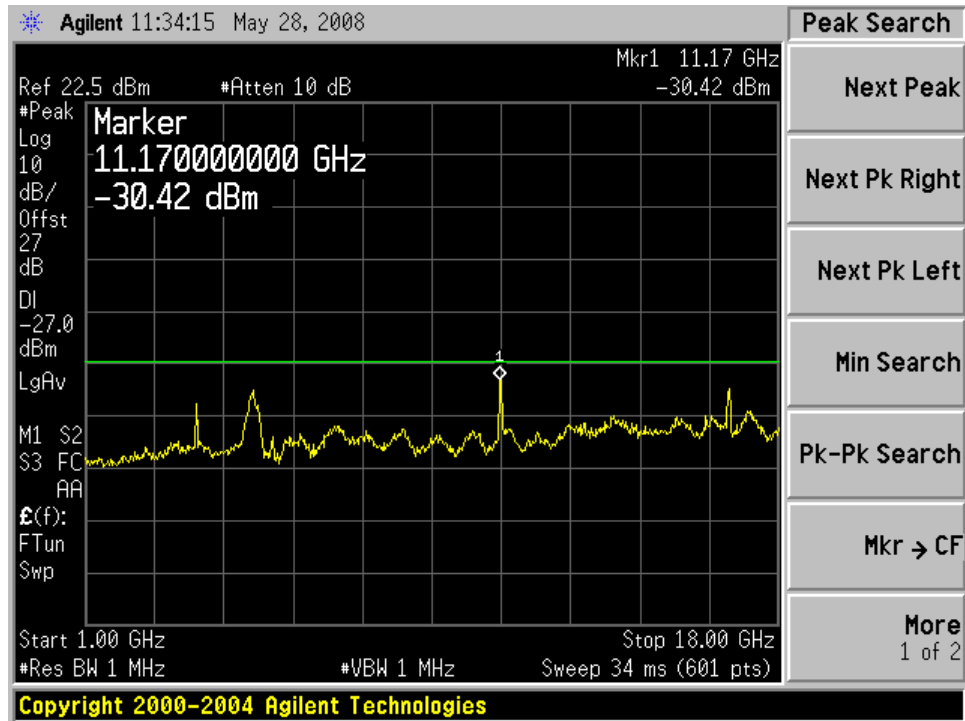

High Channel

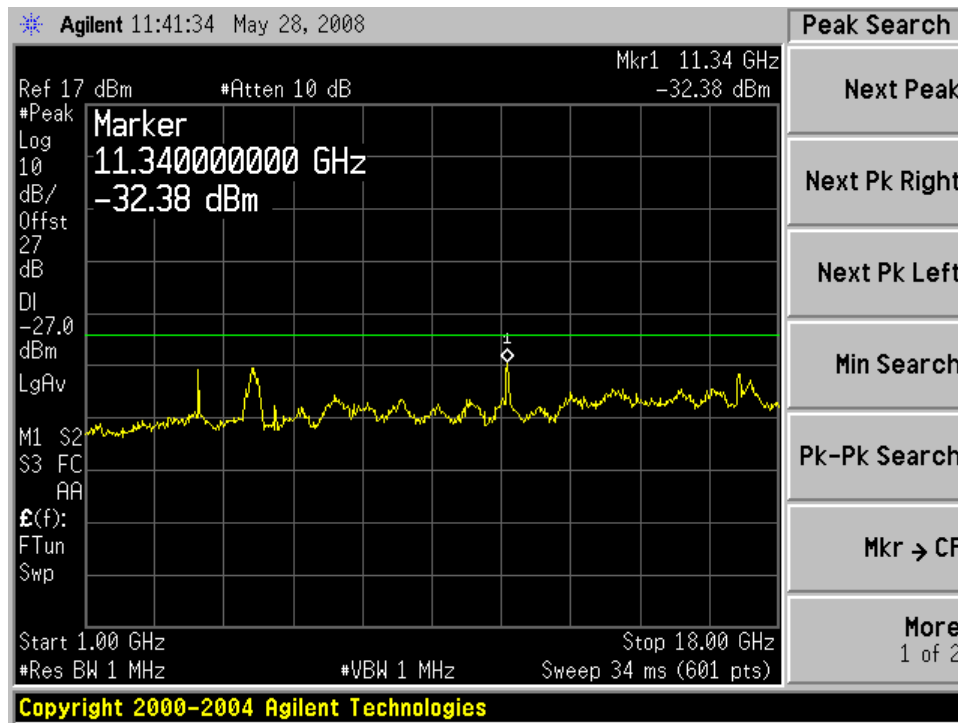
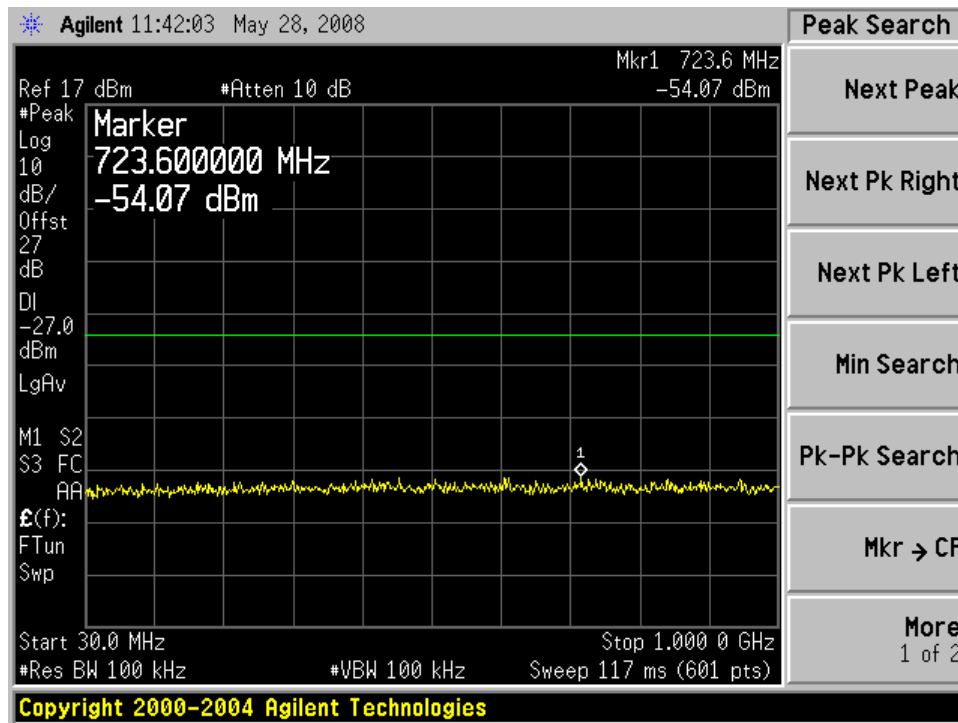

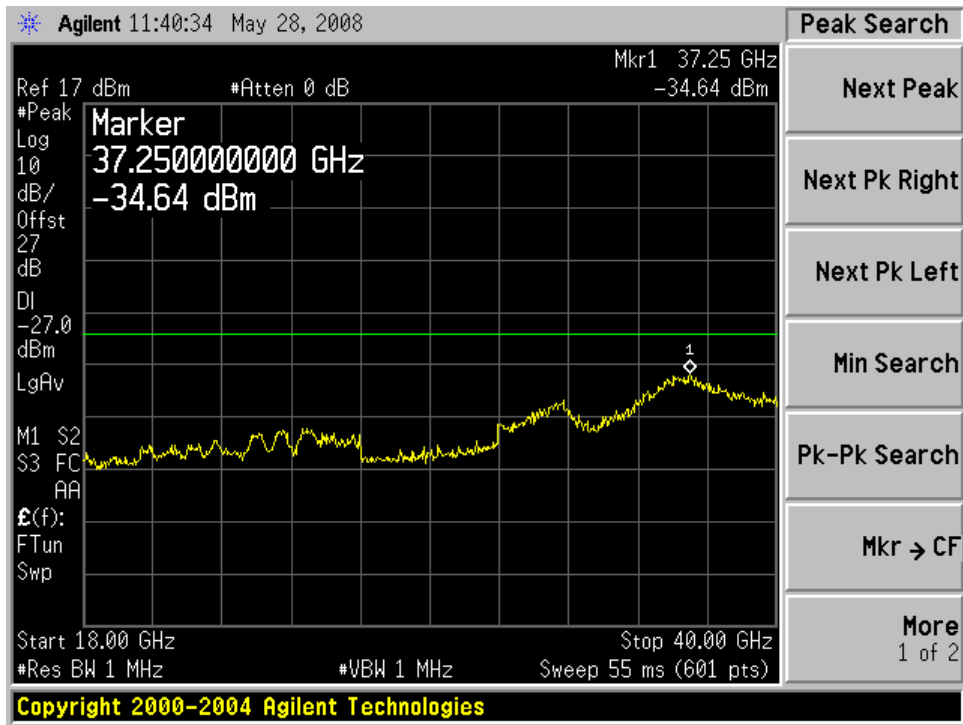

8 FCC §15.205, §15.209, §15.407(b) & IC RSS-210 §2.6, §A9.3 - Spurious Radiated Emissions

8.1 Applicable Standard

FCC §15.407(b) & IC RSS210 §A9.3

As per 15.35(d): Unless otherwise specified, on any frequency or frequencies above 1000 MHz, the radiated emission limits are based on the use of measurement instrumentation employing an average detector function. Unless otherwise specified, measurements above 1000 MHz shall be performed using a minimum resolution bandwidth of 1 MHz.

As per 15.209(a): Except as provided elsewhere in this Subpart, the emissions from an intentional radiator shall not exceed the field strength levels specified in the following table

Frequency (MHz)	Field Strength (microvolts/meter)	Measurement Distance (meters)
0.009 - 0.490	2400/F(kHz)	300
0.490 - 1.705	24000/F(kHz)	30
1.705 - 30.0	30	30
30 - 88	100**	3
88 - 216	150**	3
216 - 960	200**	3
Above 960	500	3

** Except as provided in paragraph (g), fundamental emissions from intentional radiators operating under this Section shall not be located in the frequency bands 54-72 MHz, 76-88 MHz, 174-216 MHz or 470-806 MHz. However, operation within these frequency bands is permitted under other sections of this Part, e.g., Sections 15.231 and 15.241.

As Per 15.205(a) except as show in paragraph (d) of this section, only spurious emissions are permitted in any of the frequency bands listed below:

MHz	MHz	MHz	GHz
0.090 – 0.110	16.42 – 16.423	960 – 1240	4.5 – 5.15
0.495 – 0.505	16.69475 – 16.69525	1300 – 1427	5.35 – 5.46
2.1735 – 2.1905	25.5 – 25.67	1435 – 1626.5	7.25 – 7.75
4.125 – 4.128	37.5 – 38.25	1645.5 – 1646.5	8.025 – 8.5
4.17725 – 4.17775	73 – 74.6	1660 – 1710	9.0 – 9.2
4.20725 – 4.20775	74.8 – 75.2	1718.8 – 1722.2	9.3 – 9.5
6.215 – 6.218	108 – 121.94	2200 – 2300	10.6 – 12.7
6.26775 – 6.26825	123 – 138	2310 – 2390	13.25 – 13.4
6.31175 – 6.31225	149.9 – 150.05	2483.5 – 2500	14.47 – 14.5
8.291 – 8.294	156.52475 – 156.52525	2690 – 2900	15.35 – 16.2
8.362 – 8.366	156.7 – 156.9	3260 – 3267	17.7 – 21.4
8.37625 – 8.38675	162.0125 – 167.17	3.332 – 3.339	22.01 – 23.12
8.41425 – 8.41475	167.72 – 173.2	3 3458 – 3 358	23.6 – 24.0
12.29 – 12.293	240 – 285	3.600 – 4.400	31.2 – 31.8
12.51975 – 12.52025	322 – 335.4		36.43 – 36.5
12.57675 – 12.57725	399.9 – 410		Above 38.6
13.36 – 13.41	608 – 614		

IC RSS-210 §2.6 General Field Strength Limits

Tables 2 and 3 show the general field strength limits of unwanted emissions, where applicable, for transmitters and receivers operating in accordance with the provisions specified in this RSS. Transmitters whose wanted emissions are also within the limits shown in Tables 2 and 3 may operate in any of the frequency bands of Tables 2 and 3, other than the restricted bands of Table 1 and the TV bands, and shall be certified under RSS-210. (**Note:** Devices operating below 490 kHz all of whose emissions are at least 40 dB below the limit given in Table 3 are Category II devices subject to RSS-310.) Unwanted emissions of transmitters and receivers are permitted to fall into Table 1 and TV frequencies but intentional emissions are prohibited. See the note of Table 2 for further details.

8.2 Test Setup

The radiated emissions tests were performed in the 3-meter open area test site, using the setup in accordance with ANSI C63.4-2003. The specification used was the FCC 15 Subpart C and E limits.

The spacing between the peripherals was 10 centimeters.

External I/O cables were draped along the edge of the test table and bundle when necessary.

8.3 Test Equipment List and Details

Manufacturer	Description	Model	Serial Number	Cal Date
HP	Pre amplifier	8447D	2944A07030	2007-11-12
Agilent	Pre amplifier	8449B	3008A01978	2007-11-02
Sunol Science	Combination Antenna	JB1 Antenna	A013105-3	2008-03-25
Antenna Research Associates, Inc.	Horn Antenna	DRG-118/A	1132	2007-06-18
Rohde & Schwarz	EMI Test Receiver	ESCI 1166.595 0K03	1000337	2008-04-21
Sunol Science	System Controller	SC99V	122303-1	NR
Agilent	Spectrum analyzer	E4440A	MY44303352	2008-04-28

* **Statement of Traceability:** BACL attests that all calibrations have been performed per the NVLAP requirements, traceable to NIST.

8.4 Test Procedure

For the radiated emissions test, the EUT, and all support equipment power cords was connected to the AC floor outlet.

Maximizing procedure was performed on the highest emissions to ensure that the EUT complied with all installation combinations.

The EUT is set 3 meter away from the testing antenna, which is varied from 1-4 mete, and the EUT is placed on a turntable, which is 0.8 meter above ground plane, the table shall be rotated for 360 degrees to find out the highest emission. The receiving antenna should be changed the polarization both of horizontal and vertical.

The spectrum analyzer or receiver is set as:

Below 1000MHz:

$$\text{RBW} = 100 \text{ kHz} / \text{VBW} = 300 \text{ kHz} / \text{Sweep} = \text{Auto}$$

Above 1000MHz:

$$(1) \text{ Peak: RBW} = 1\text{MHz} / \text{VBW} = 1\text{MHz} / \text{Sweep} = \text{Auto}$$

Average: $\text{RBW} = 1\text{MHz} / \text{VBW} = 10\text{Hz} / \text{Sweep} = \text{Auto}$

8.5 Corrected Amplitude & Margin Calculation

The Corrected Amplitude is calculated by adding the Antenna Factor and Cable Factor, and subtracting the Amplifier Gain from the Amplitude reading. The basic equation is as follows:

$$\text{Corrected Amplitude} = \text{Indicated Reading} + \text{Antenna Factor} + \text{Cable Factor} - \text{Amplifier Gain}$$

The “**Margin**” column of the following data tables indicates the degree of compliance with the applicable limit. For example, a margin of -7dB means the emission is 7dB below the maximum limit. The equation for margin calculation is as follows:

$$\text{Margin} = \text{Corrected Amplitude} - \text{FCC Limit}$$

8.6 Test Setup Diagram

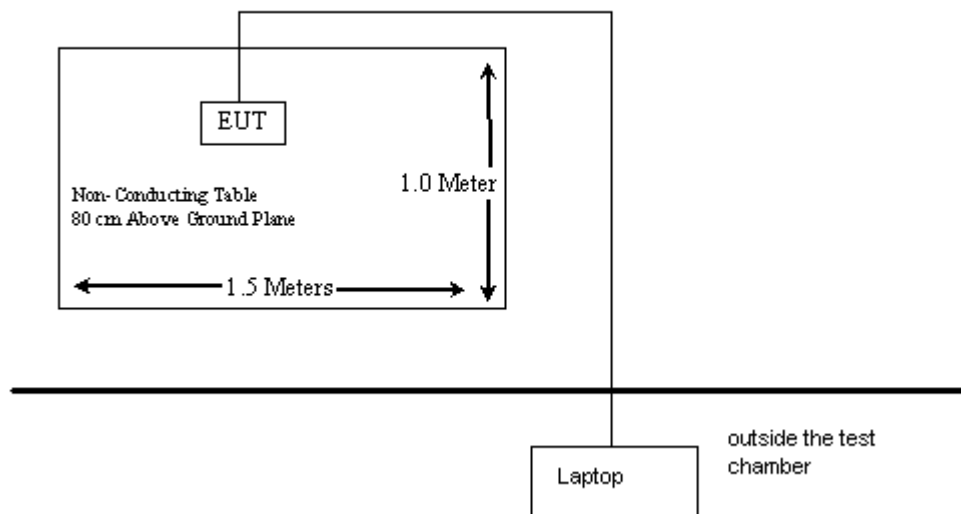

8.7 Environmental Conditions

Temperature:	20° C -23° C
Relative Humidity:	30% - 63%
ATM Pressure:	1011mbar - 1019 mbar

**The testing was performed by Xiao Ming Hu from 2008-05-14 to 2008-05-22*

8.8 Summary of Test Results

According to the data hereinafter, the EUT complied with the FCC Part 15.205, 15.209, 15.407 and IC RSS-210 §2.6, A9.3, had the worst margin of:

5250-5350 MHz Band (W53)

802.11n 20MHz:

- 1.7 dB at 10520.00 MHz in the Vertical polarization for Low Channel, 1GHz – 40 GHz
- 3.85 dB at 10600.83 MHz in the Vertical polarization for Middle Channel, 1GHz – 40 GHz
- 6.2 dB at 10644.11 MHz in the Vertical polarization for High Channel, 1GHz – 40 GHz

802.11n 40MHz:

- 4.44 dB at 10543.68 MHz in the Vertical polarization for Low Channel, 1GHz – 40 GHz
- 8.92 dB at 10612.66 MHz in the Vertical polarization for High Channel, 1GHz – 40 GHz

802.11a 20MHz:

- 3.28 dB at 10523.91 MHz in the Vertical polarization for Low Channel, 1GHz – 40 GHz
- 4.95 dB at 10598.96 MHz in the Vertical polarization for Middle Channel, 1GHz – 40 GHz
- 6.2 dB at 10644.11 MHz in the Vertical polarization for High Channel, 1GHz – 40 GHz

5470-5725 MHz Band (W56)

802.11n 20MHz:

- 0.63 dB at 3666.848 MHz in the Horizontal polarization for Low Channel, 1GHz – 40 GHz
- 0.3 dB at 3733.253 MHz in the Horizontal polarization for Middle Channel, 1GHz – 40 GHz
- 1.75 dB at 3799.966 MHz in the Horizontal polarization for High Channel, 1GHz – 40 GHz

802.11n 40MHz:

- 0.35 dB at 3673.279 MHz in the Horizontal polarization for Low Channel, 1GHz – 40 GHz
- 8.01 dB at 5118.147 MHz in the Horizontal polarization for High Channel, 1GHz – 40 GHz
- 0.09 dB at 3779.953 MHz in the Horizontal polarization for Low Channel, 1GHz – 40 GHz

802.11a 20MHz:

- 3.52 dB at 16492.70 MHz in the Vertical polarization for Low Channel, 1GHz – 40 GHz
- 1.72 dB at 11198.99 MHz in the Horizontal polarization for Middle Channel, 1GHz – 40 GHz
- 0.08 dB at 3800.086 MHz in the Horizontal polarization for High Channel, 1GHz – 40GHz

8.9 Test Plot and Data

Radiated Spurious Emissions Worst-case scan below 1 GHz

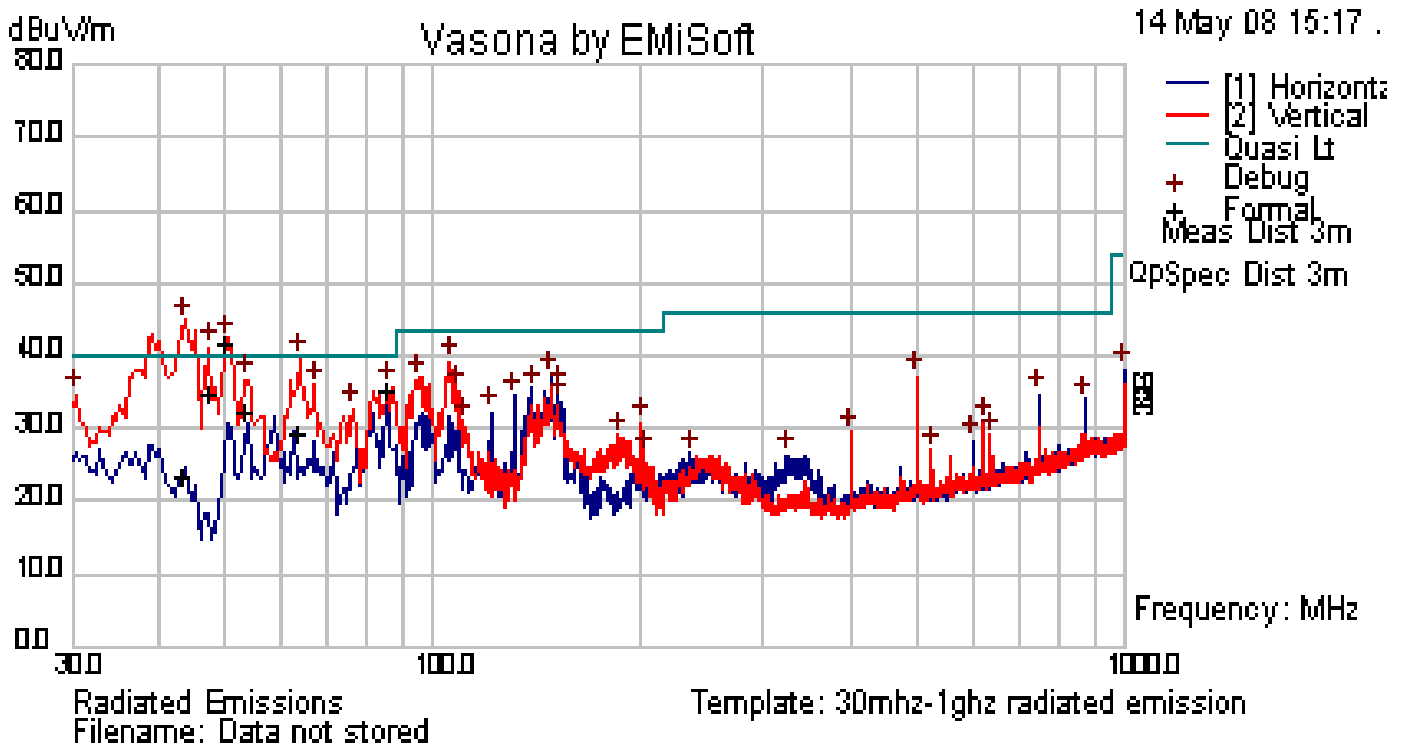

Quasi-Peak Measurements:

Frequency (MHz)	Raw data (dBuV)	Cable Loss (dB)	AF+ P-A (dB)	Corrected Reading (dBuV/m)	Measurement Type	Ant. Pol. (H/V)	Hgt (cm)	Azt Deg	Limit (dBuV/m)	Margin (dB)
50.432	48.84	10.4	-19.83	39.41	Quasi -Peak	V	110	313	40	-0.59
86.014	42.32	10.56	-20.14	32.74	Quasi -Peak	V	266	22	40	-7.26
47.582	40.88	10.4	-18.69	32.59	Quasi -Peak	V	109	287	40	-7.41
53.976	39.85	10.4	-20.46	29.8	Quasi -Peak	V	151	177	40	-10.2
64.137	36.6	10.44	-20.19	26.86	Quasi -Peak	V	138	-5	40	-13.14
43.785	27.13	10.4	-16.65	20.87	Quasi -Peak	V	317	253	40	-19.13

8.9.1 5250-5350 MHz (W53)**802.11n 20MHz:**

Low channel

Frequency (MHz)	Raw data (dBuV)	Cable Loss (dB)	AF+ P-A (dB)	Corrected Reading (dBuV)	Measurement Type	Ant. Pol. (V/H)	Hgt (cm)	Azt (Deg)	Limit (dBuV)	Margin (dB)
10520	45	3.7	3.5	52.3	Average	V	136	281	54	-1.7
5263.31	51.45	2.45	-5.59	48.31	Average	V	133	197	54	-5.69
17642.11	24.51	5.46	9.64	39.61	Average	V	185	130	54	-14.39
14924.36	25.47	4.73	6.25	36.45	Average	V	174	217	54	-17.55
5526.931	29.3	2.56	-4.67	27.18	Average	H	158	207	54	-26.82
1888.262	28.85	1.25	-10.86	19.25	Average	V	191	70	54	-34.75

Mid channel

Frequency (MHz)	Raw data (dBuV)	Cable Loss (dB)	AF+ P-A (dB)	Corrected Reading (dBuV)	Measurement Type	Ant. Pol. (V/H)	Hgt (cm)	Azt (Deg)	Limit (dBuV)	Margin (dB)
10600.83	42.85	3.8	3.5	50.15	Average	V	136	281	54	-3.85
5301.056	47.48	2.46	-5.45	44.49	Average	H	132	0	54	-9.51
17502.77	24.69	5.44	10.22	40.35	Average	V	99	360	54	-13.65
14493.29	25.72	4.63	6.53	36.88	Average	V	185	206	54	-17.12
1874.761	42.32	1.25	-10.87	32.7	Average	H	134	150	54	-21.3
4930.922	29.16	2.38	-6.88	24.66	Average	H	99	130	54	-29.34

High channel

Frequency (MHz)	Raw data (dBuV)	Cable Loss (dB)	AF+ P-A (dB)	Corrected Reading (dBuV)	Measurement Type	Ant. Pol. (V/H)	Hgt (cm)	Azt (Deg)	Limit (dBuV)	Margin (dB)
10644.11	39.3	3.8	4.7	47.8	Average	V	202	266	54	-6.2
3546.807	53.79	1.97	-9.06	46.7	Average	H	134	0	54	-7.3
17657.85	26.42	5.46	9.6	41.48	Average	H	194	115	54	-12.52
15962.11	29.61	5.06	4.36	39.03	Average	H	110	0	54	-14.97
5553.197	34.21	2.56	-2.85	33.92	Average	H	114	207	54	-20.08

Restricted Band Edge

High channel

Peak, Horizontal

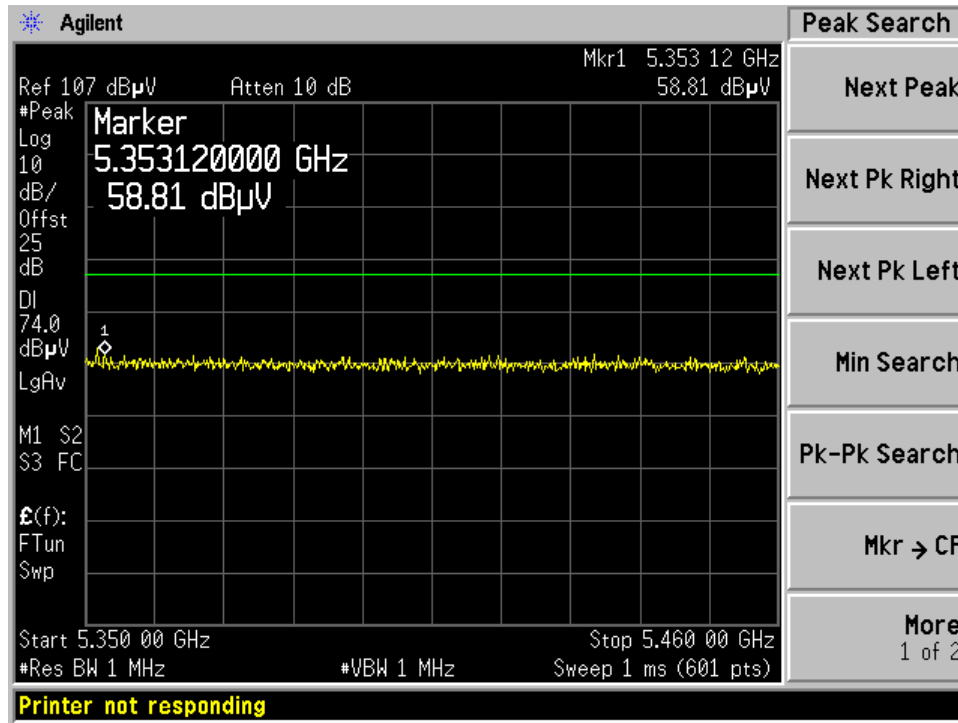

Average, Horizontal

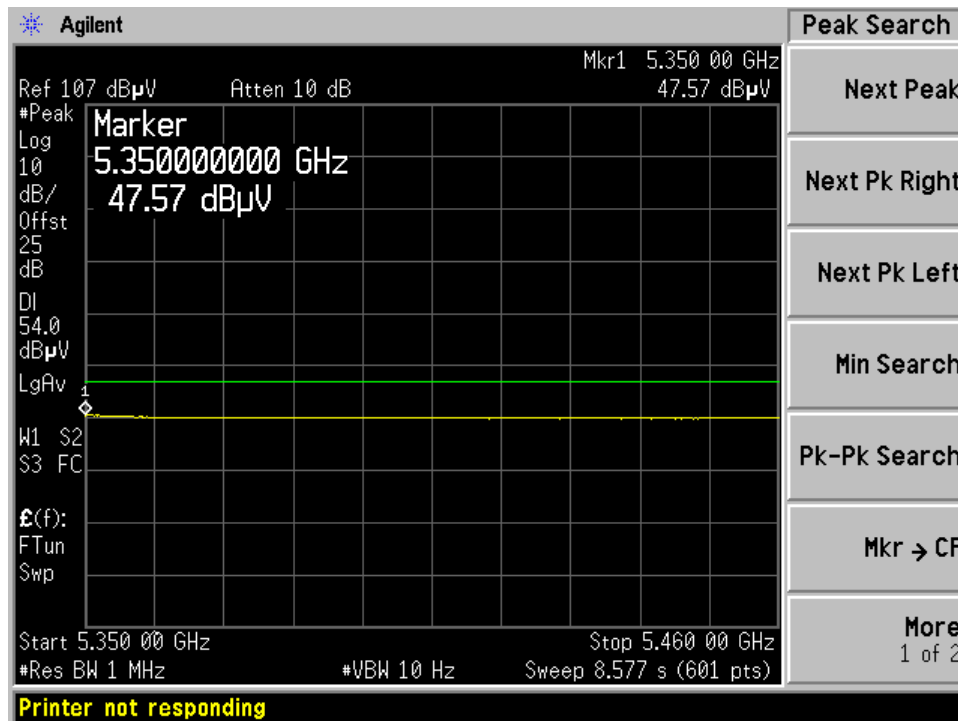

Peak, Vertical

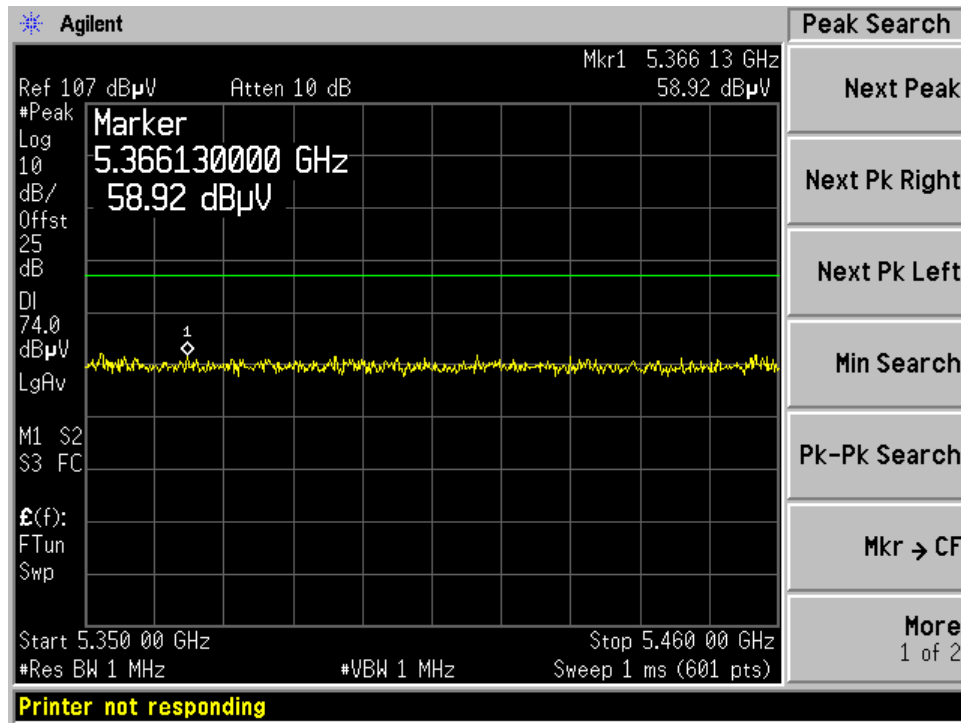

Average, Vertical

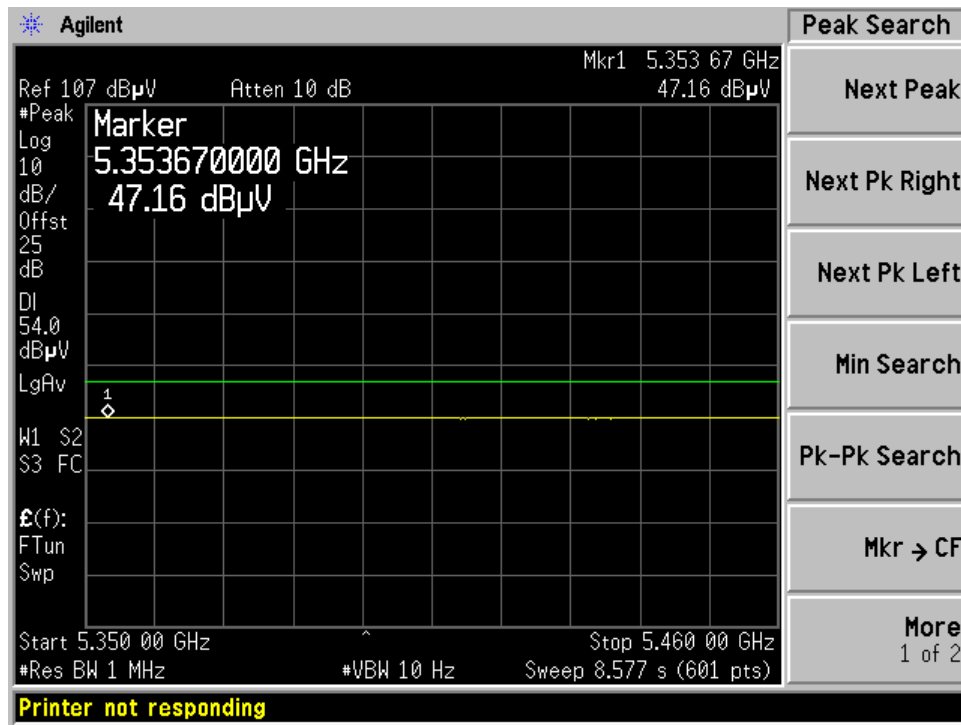

5250-5350 MHz (W53)**802.11a 20MHz:**

Low channel

Frequency (MHz)	Raw data (dBuV)	Cable Loss (dB)	AF+ P-A (dB)	Corrected Reading (dBuV)	Measurement Type	Ant. Pol. (V/H)	Hgt (cm)	Azt (Deg)	Limit (dBuV)	Margin (dB)
10523.91	42.21	3.73	4.77	50.72	Average	V	166	216	54	-3.28
10533.54	39.91	3.74	4.77	48.41	Average	V	127	360	54	-5.59
15783.19	34.28	4.95	3.95	43.18	Average	H	119	6	54	-10.82
17526.53	26.24	5.44	10.07	41.75	Average	H	137	320	54	-12.25
1889.673	35.63	1.25	-10.1	26.79	Average	V	202	226	54	-27.21

Mid channel

Frequency (MHz)	Raw data (dBuV)	Cable Loss (dB)	AF+ P-A (dB)	Corrected Reading (dBuV)	Measurement Type	Ant. Pol. (V/H)	Hgt (cm)	Azt (Deg)	Limit (dBuV)	Margin (dB)
10598.96	40.56	3.75	4.74	49.05	Average	V	154	357	54	-4.95
15898.28	31.77	5	4.2	40.97	Average	V	98	244	54	-13.03
17819.15	26.36	5.53	9.03	40.91	Average	H	130	342	54	-13.09
1890.11	38.62	1.26	-10.1	29.78	Average	H	202	22	54	-24.22
1883.129	31.67	1.25	-10.12	22.81	Average	H	145	162	54	-31.19

High channel

Frequency (MHz)	Raw data (dBuV)	Cable Loss (dB)	AF+ P-A (dB)	Corrected Reading (dBuV)	Measurement Type	Ant. Pol. (V/H)	Hgt (cm)	Azt (Deg)	Limit (dBuV)	Margin (dB)
10644.11	39.3	3.8	4.7	47.8	Average	V	202	266	54	-6.2
3546.807	53.79	1.97	-9.06	46.7	Average	H	134	0	54	-7.3
17657.85	26.42	5.46	9.6	41.48	Average	H	194	115	54	-12.52
15962.11	29.61	5.06	4.36	39.03	Average	H	110	0	54	-14.97
5553.197	34.21	2.56	-2.85	33.92	Average	H	114	207	54	-20.08

Restricted Band Edge

High channel

Peak, Horizontal

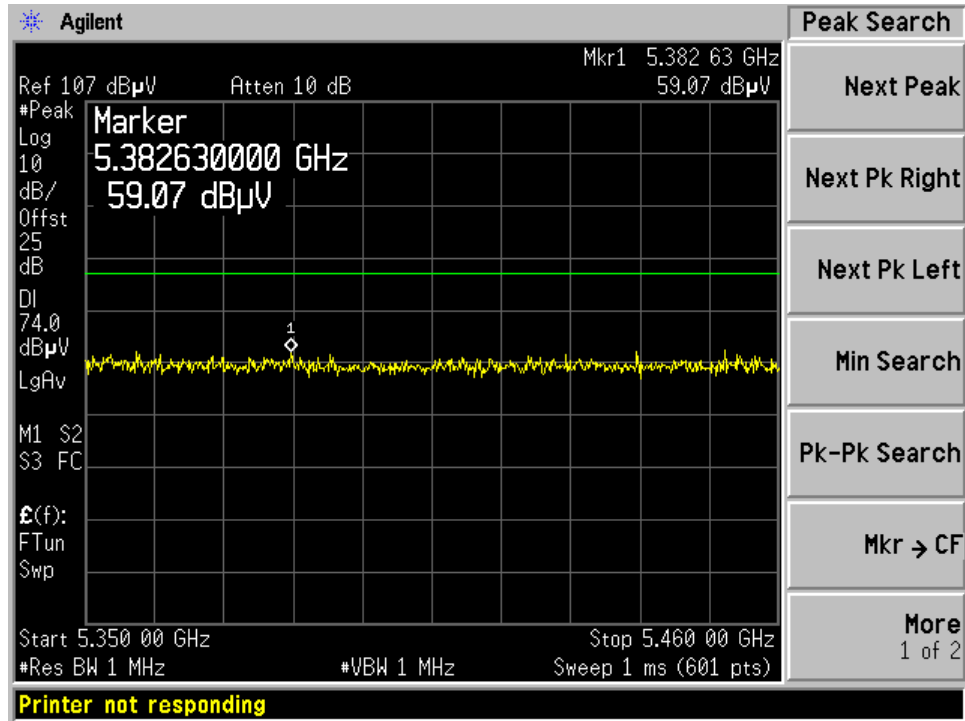

Average, Horizontal

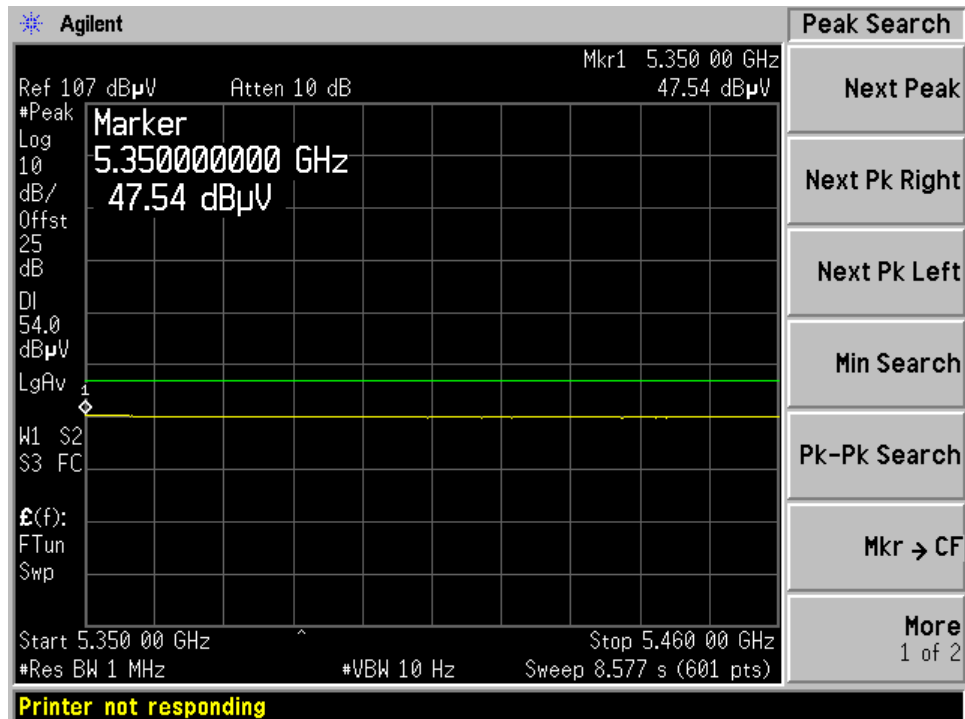

Peak, Vertical

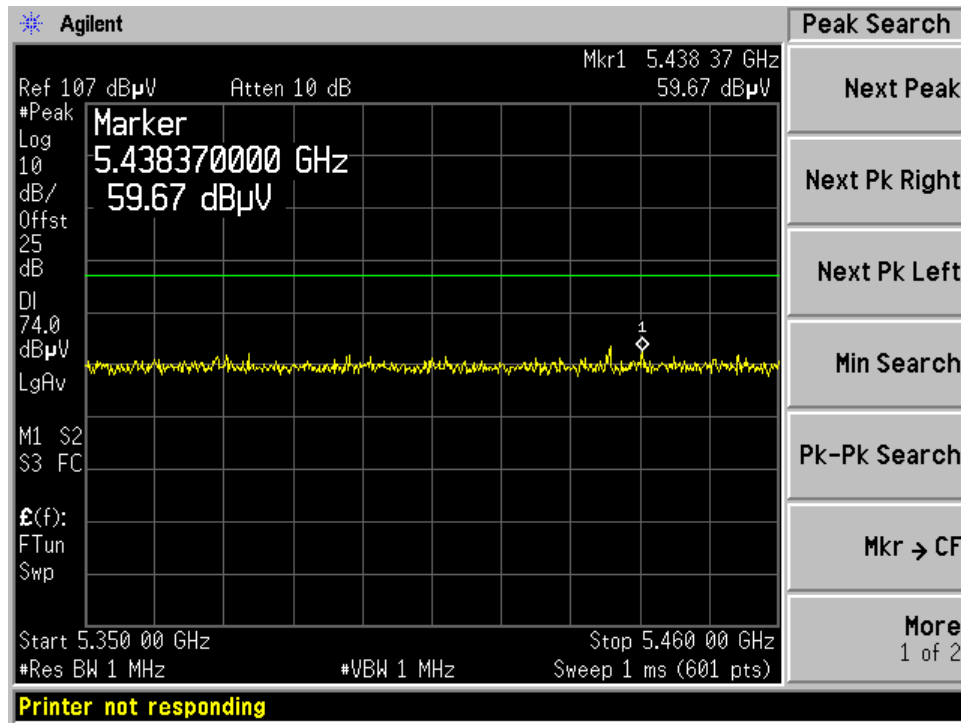

Average, Vertical

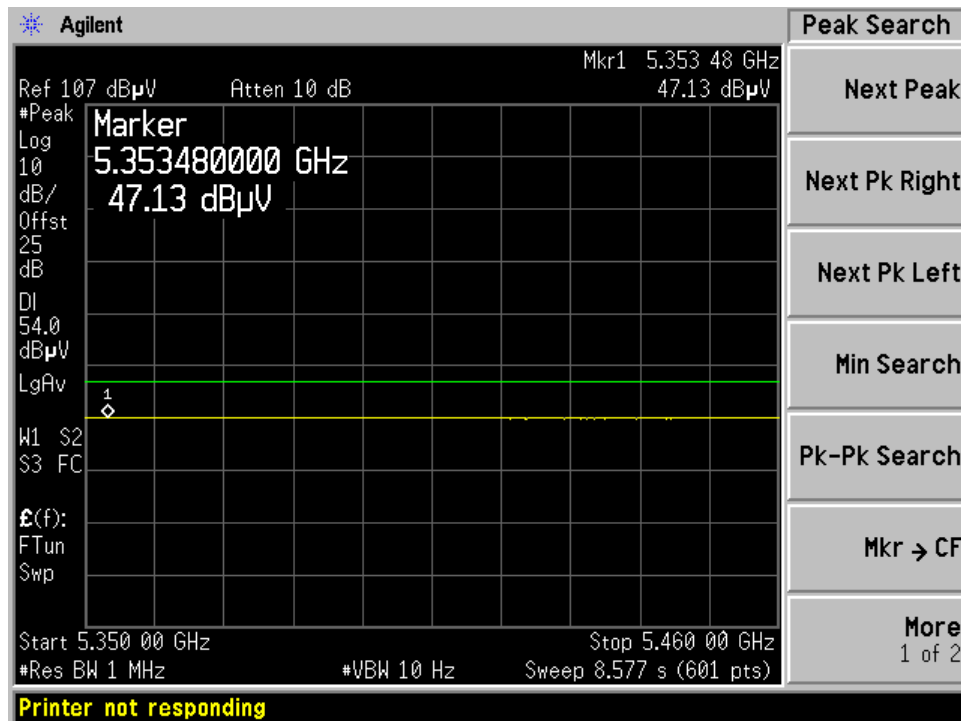

5250-5350 MHz (W53)**802.11n 40MHz:**

Low channel

Frequency (MHz)	Raw data (dBuV)	Cable Loss (dB)	AF+ P-A (dB)	Corrected Reading (dBuV)	Measurement Type	Ant. Pol. (V/H)	Hgt (cm)	Azt (Deg)	Limit (dBuV)	Margin (dB)
10543.68	41.06	3.74	4.76	49.56	Average	V	127	360	54	-4.44
17550.38	26.2	5.45	9.99	41.63	Average	V	112	360	54	-12.37
15819	32.5	4.97	4.03	41.5	Average	H	152	222	54	-12.5
10561.22	28.55	3.74	4.76	37.05	Average	V	135	360	54	-16.95
5563.274	33.72	2.56	-2.83	33.45	Average	H	144	360	54	-20.55

High channel

Frequency (MHz)	Raw data (dBuV)	Cable Loss (dB)	AF+ P-A (dB)	Corrected Reading (dBuV)	Measurement Type	Ant. Pol. (V/H)	Hgt (cm)	Azt (Deg)	Limit (dBuV)	Margin (dB)
10612.66	36.59	3.75	4.73	45.08	Average	V	139	318	54	-8.92
15927.62	33.3	5.02	4.27	42.6	Average	H	100	0	54	-11.4
17654.94	26.5	5.46	9.61	41.58	Average	H	154	208	54	-12.42
5455.064	38.93	2.53	-3.09	38.38	Average	H	135	38	54	-15.62
15959.97	28.79	5.05	4.36	38.2	Average	H	162	205	54	-15.8

Restricted Band Edge

High channel

Peak, Horizontal

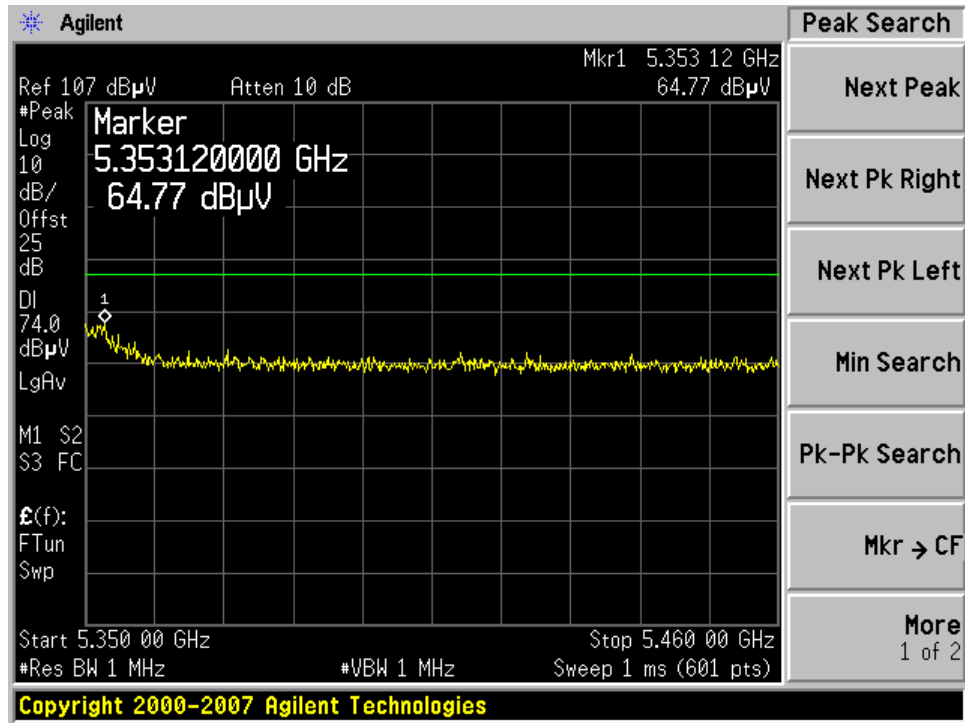

Average, Horizontal

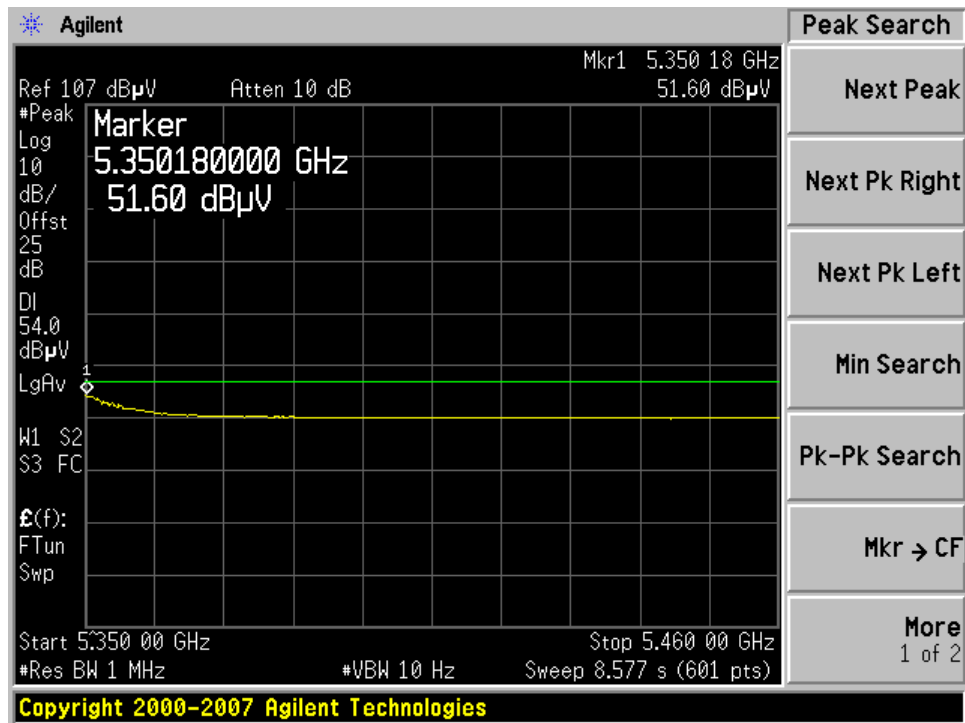

Peak, Vertical

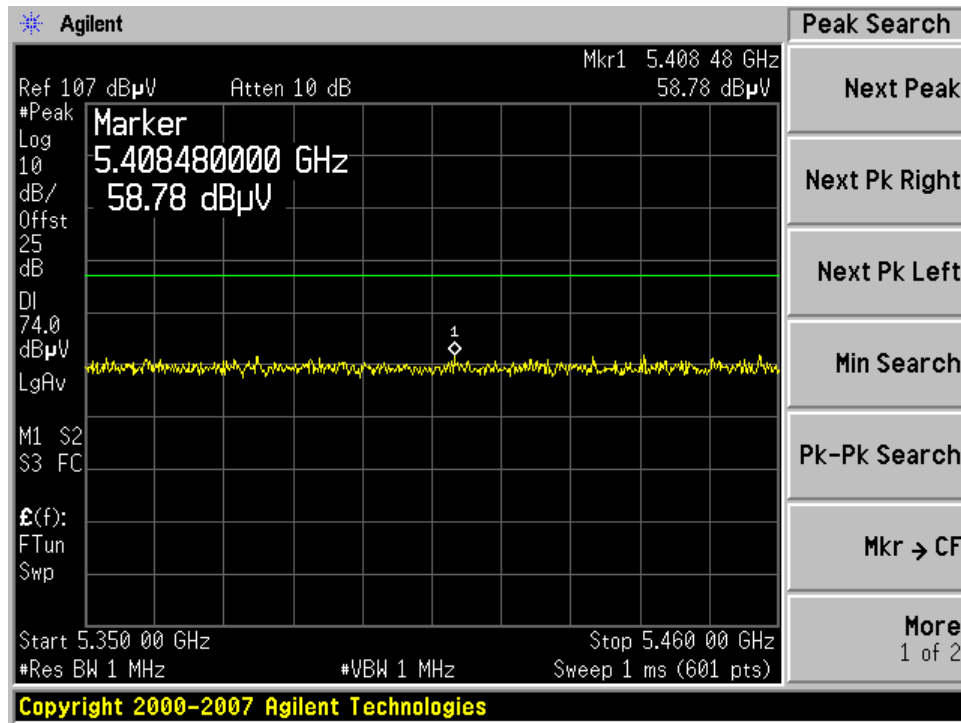

Average, Vertical

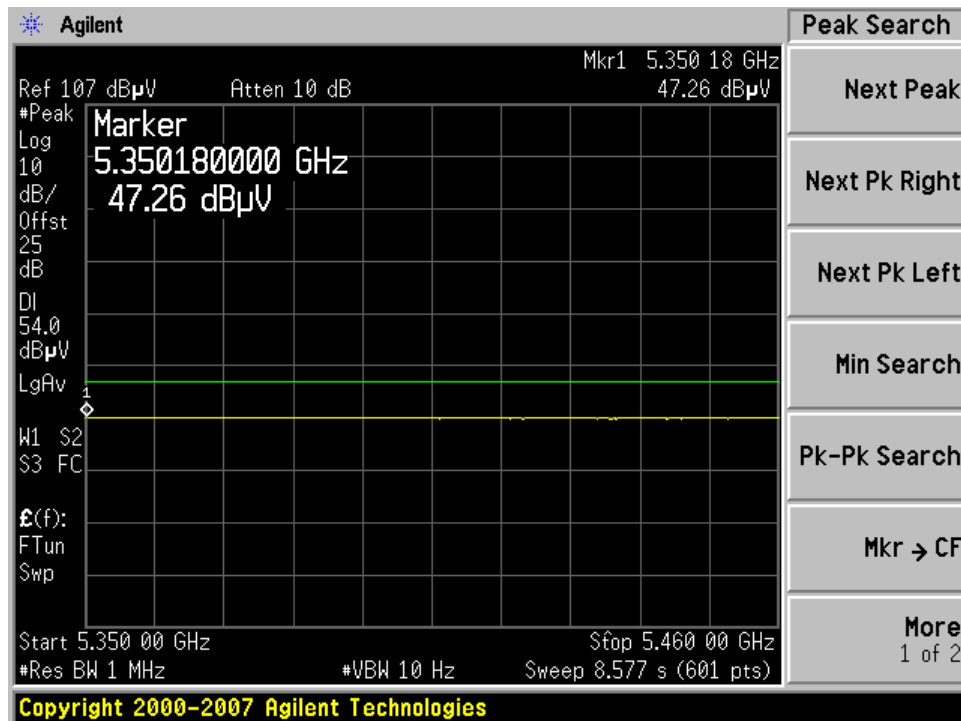

8.9.2 5470-5725 MHz (W56)**802.11n 20MHz:**

Low channel

Frequency (MHz)	Raw data (dBuV)	Cable Loss (dB)	AF+ P-A (dB)	Corrected Reading (dBuV)	Measurement Type	Ant. Pol. (V/H)	Hgt (cm)	Azt (Deg)	Limit (dBuV)	Margin (dB)
3666.848	60.31	2	-8.95	53.37	Average Max	H	161	142	54	-0.63
16491.61	35.16	5.26	3.44	43.85	Average Max	V	99	222	54	-10.15
17332.89	26.2	5.4	9.05	40.66	Average Max	H	162	0	54	-13.34
16516.08	30.64	5.26	3.53	39.44	Average Max	V	97	156	54	-14.56
11000	28.09	3.84	4.59	36.52	Average Max	V	136	281	54	-17.48

Mid channel

Frequency (MHz)	Raw data (dBuV)	Cable Loss (dB)	AF+ P-A (dB)	Corrected Reading (dBuV)	Measurement Type	Ant. Pol. (V/H)	Hgt (cm)	Azt (Deg)	Limit (dBuV)	Margin (dB)
3733.253	60.56	2	-8.86	53.7	Average Max	H	153	143	54	-0.3
17541.09	25.95	5.44	10.02	41.41	Average Max	V	168	0	54	-12.59
16801.29	30.26	5.29	5.54	41.09	Average Max	V	118	181	54	-12.91
11200	29.66	3.88	5.03	38.57	Average Max	V	136	281	54	-15.43
14724.16	26.95	4.65	6.41	38	Average Max	V	136	334	54	-16

High channel

Frequency (MHz)	Raw data (dBuV)	Cable Loss (dB)	AF+ P-A (dB)	Corrected Reading (dBuV)	Measurement Type	Ant. Pol. (V/H)	Hgt (cm)	Azt (Deg)	Limit (dBuV)	Margin (dB)
3799.966	59	2.01	-8.77	52.25	Average Max	H	121	360	54	-1.75
11400	38.92	3.93	5.39	48.24	Average Max	V	136	281	54	-5.76
5120.761	46.41	2.42	-4.21	44.61	Average Max	H	147	360	54	-9.39
5240.338	44.57	2.45	-3.83	43.19	Average Max	H	145	359	54	-10.81
17089.74	28.55	5.36	7.43	41.34	Average Max	V	147	269	54	-12.66
17656.18	26.16	5.46	9.61	41.23	Average Max	H	176	356	54	-12.77

Restricted Band Edge

High channel

Peak, Horizontal

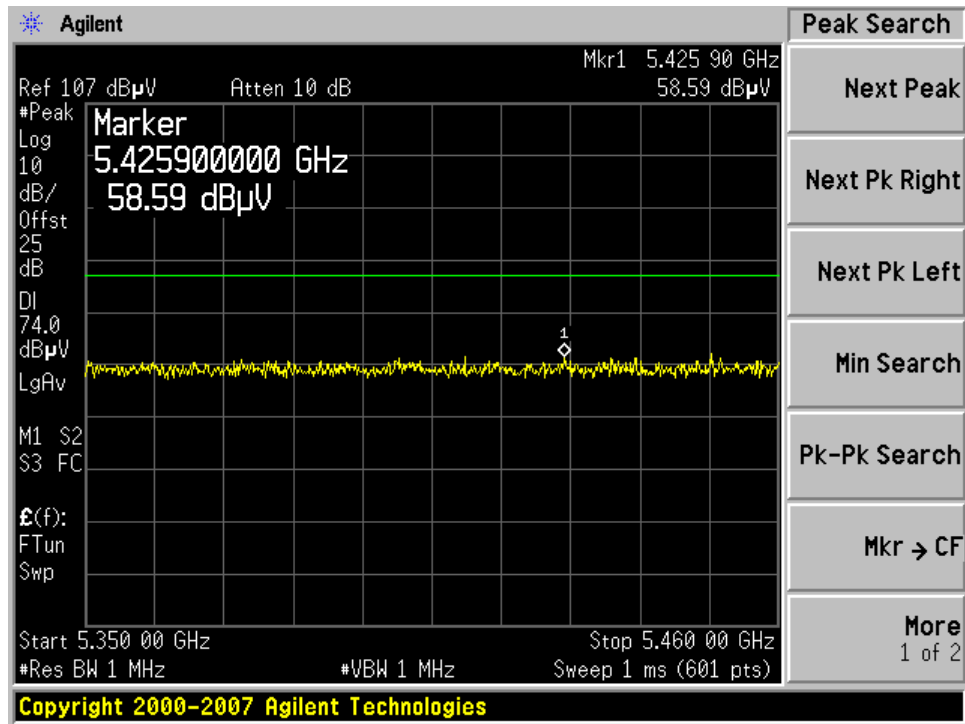

Average, Horizontal

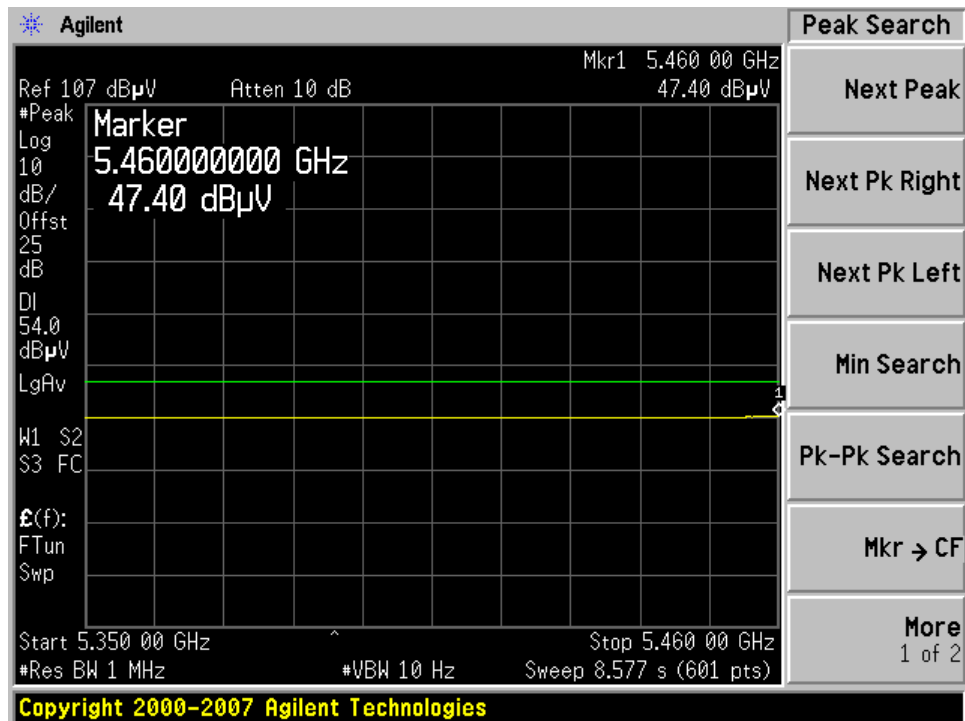

Peak, Vertical

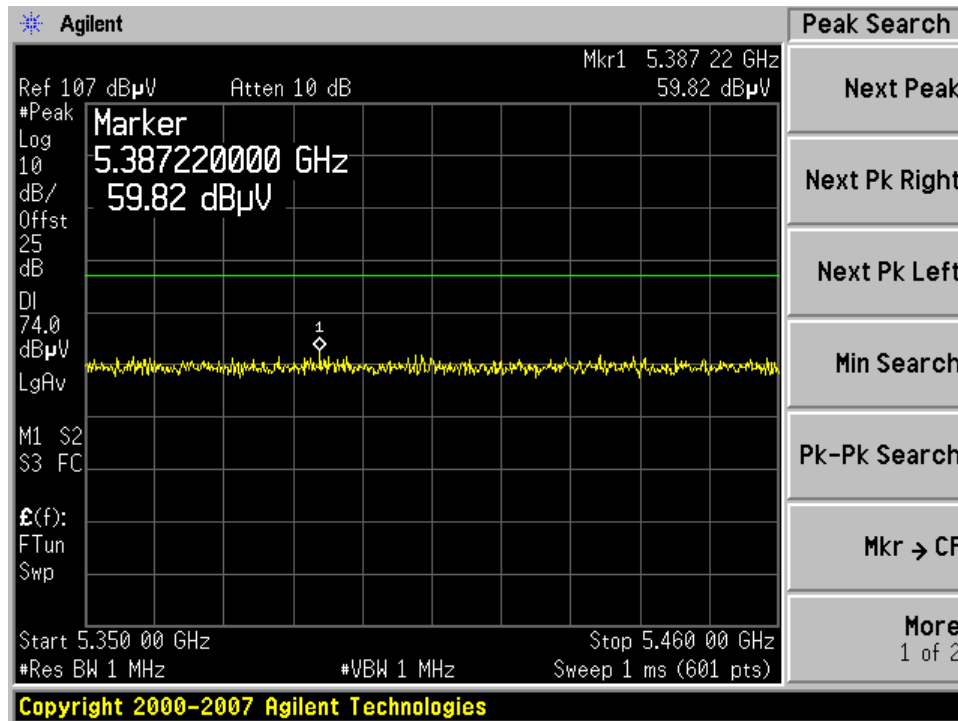

Average, Vertical

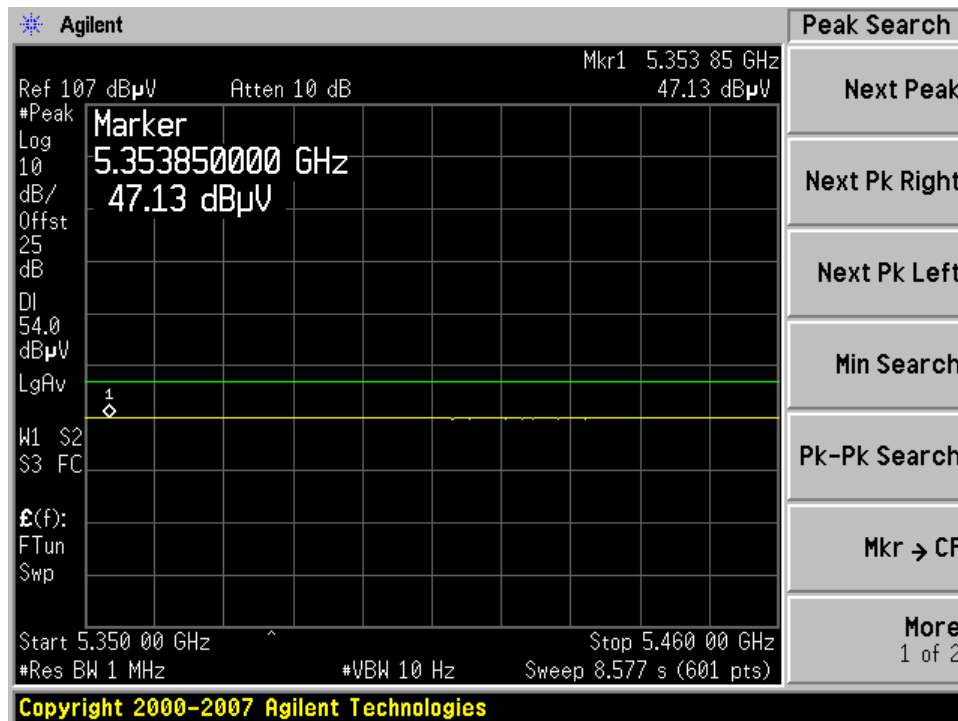

5470-5725 MHz (W56)**802.11a 20MHz:**

Low channel

Frequency (MHz)	Raw data (dBuV)	Cable Loss (dB)	AF+ P-A (dB)	Corrected Reading (dBuV)	Measurement Type	Ant. Pol. (V/H)	Hgt (cm)	Azt (Deg)	Limit (dBuV)	Margin (dB)
16492.7	41.79	5.26	3.44	50.48	Average Max	V	114	38	54	-3.52
5153.401	45.47	2.43	-4.11	43.79	Average Max	H	148	230	54	-10.21
17465.47	25.52	5.44	9.94	40.89	Average Max	H	187	199	54	-13.11
11006.96	31.91	3.84	4.6	40.36	Average Max	V	125	0	54	-13.64
14972.27	27.09	4.75	6.13	37.96	Average Max	V	110	130	54	-16.04

Mid channel

Frequency (MHz)	Raw data (dBuV)	Cable Loss (dB)	AF+ P-A (dB)	Corrected Reading (dBuV)	Measurement Type	Ant. Pol. (V/H)	Hgt (cm)	Azt (Deg)	Limit (dBuV)	Margin (dB)
11198.99	43.37	3.88	5.03	52.28	Average Max	H	105	129	54	-1.72
16804.68	35.19	5.29	5.57	46.05	Average Max	V	129	206	54	-7.95
5182.148	44.45	2.43	-4.02	42.86	Average Max	H	133	220	54	-11.14
5285.047	42.71	2.46	-3.68	41.48	Average Max	H	133	313	54	-12.52
17443.99	25.5	5.43	9.8	40.73	Average Max	V	175	348	54	-13.27
14196.07	26.72	4.63	5.98	37.33	Average Max	V	184	360	54	-16.67

High channel

Frequency (MHz)	Raw data (dBuV)	Cable Loss (dB)	AF+ P-A (dB)	Corrected Reading (dBuV)	Measurement Type	Ant. Pol. (V/H)	Hgt (cm)	Azt (Deg)	Limit (dBuV)	Margin (dB)
3800.086	60.68	2.01	-8.77	53.92	Average Max	H	162	194	54	-0.08
11399.86	37.01	3.93	5.39	46.33	Average Max	H	188	157	54	-7.67
5144.993	44.68	2.42	-4.13	42.97	Average Max	H	112	144	54	-11.03
17099.87	29.5	5.36	7.5	42.36	Average Max	V	137	37	54	-11.64
5269.949	43.29	2.45	-3.73	42.02	Average Max	H	148	353	54	-11.98
17518.72	26.16	5.44	10.1	41.69	Average Max	H	186	57	54	-12.31

Restricted Band Edge

High channel

Peak, Horizontal

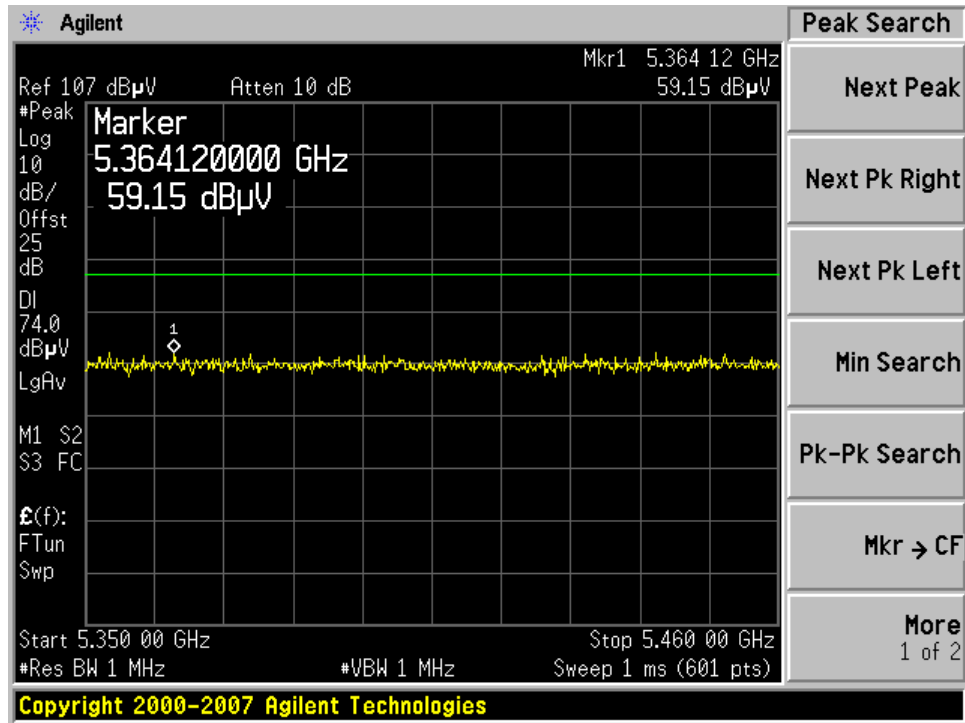

Average, Horizontal

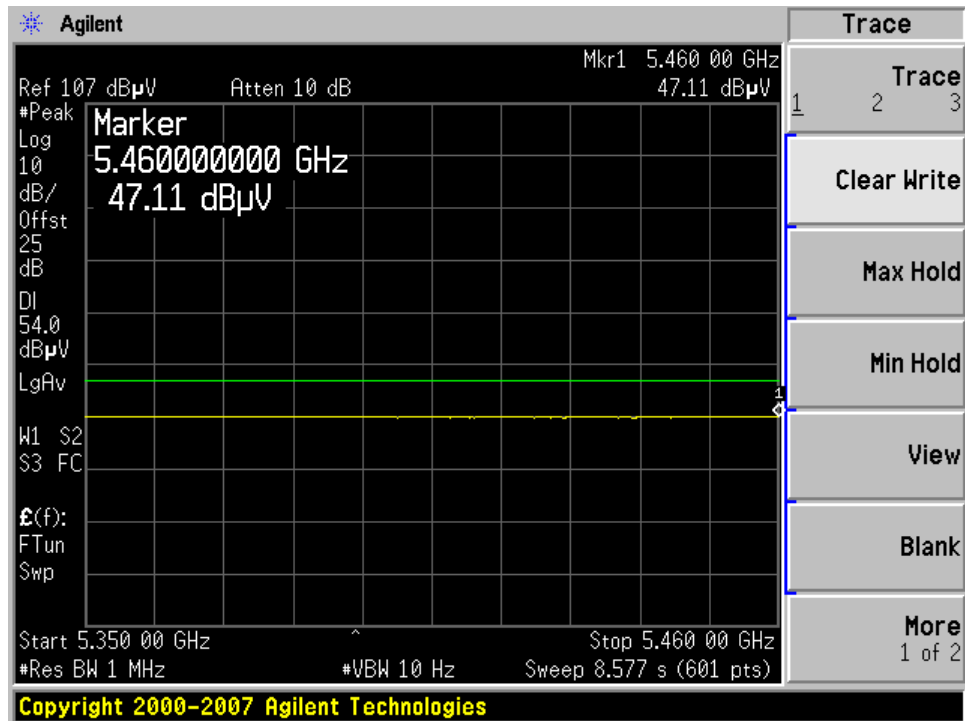

Peak, Vertical

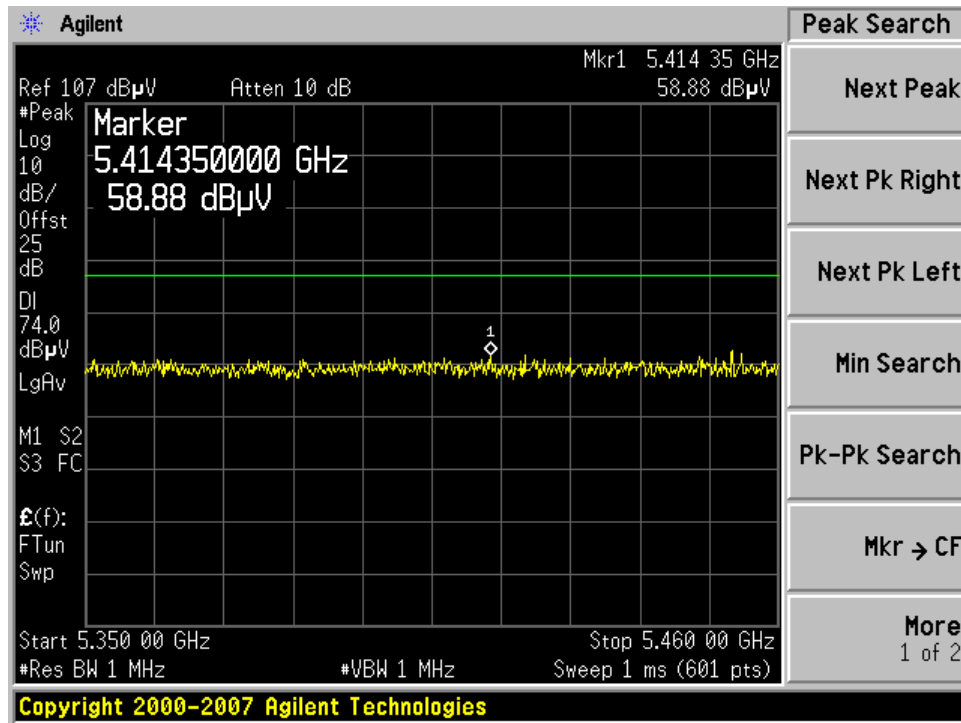

Average, Vertical

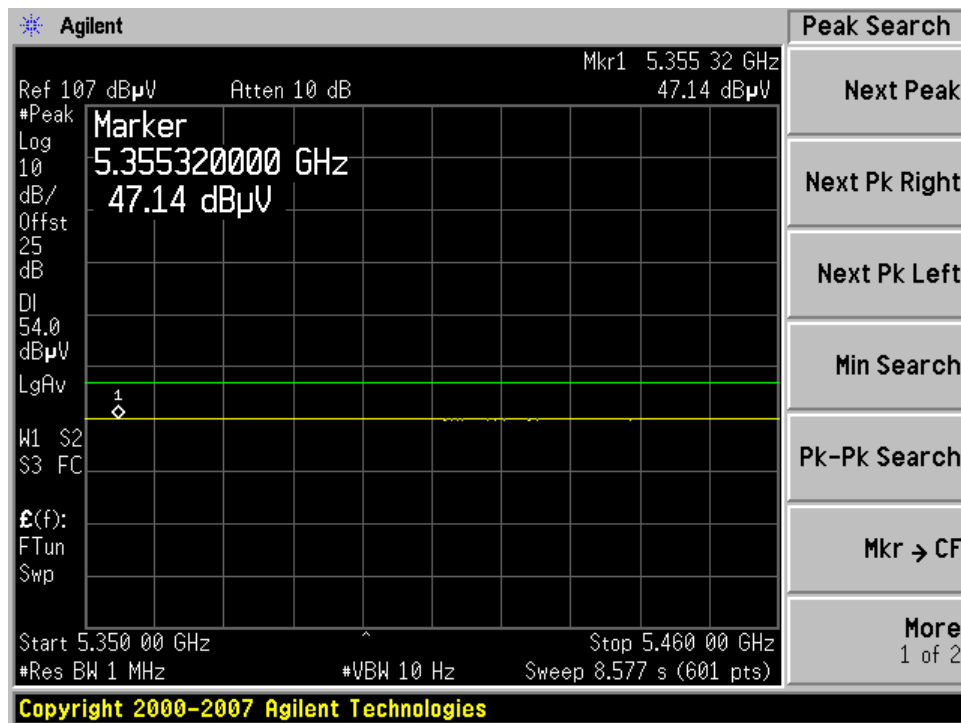

5470-5725 MHz (W56)**802.11n 40MHz:**

Low channel

Frequency (MHz)	Raw data (dBuV)	Cable Loss (dB)	AF+ P-A (dB)	Corrected Reading (dBuV)	Measurement Type	Ant. Pol. (V/H)	Hgt (cm)	Azt (Deg)	Limit (dBuV)	Margin (dB)
3673.279	60.59	2	-8.94	53.65	Average Max	H	151	47	54	-0.35
16519.79	35.13	5.26	3.56	43.95	Average Max	V	100	168	54	-10.05
17558.69	26.01	5.45	9.96	41.41	Average Max	H	118	122	54	-12.59
14506.74	26.69	4.63	6.65	37.98	Average Max	H	103	352	54	-16.02
11020	27.14	3.85	4.65	35.64	Average Max	V	136	281	54	-18.36

Mid channel

Frequency (MHz)	Raw data (dBuV)	Cable Loss (dB)	AF+ P-A (dB)	Corrected Reading (dBuV)	Measurement Type	Ant. Pol. (V/H)	Hgt (cm)	Azt (Deg)	Limit (dBuV)	Margin (dB)
5118.147	47.79	2.42	-4.22	45.99	Average Max	H	159	0	54	-8.01
11177.09	36.88	3.88	4.98	45.74	Average Max	V	99	65	54	-8.26
5579.769	43.8	2.57	-2.81	43.55	Average Max	V	99	280	54	-10.45
5284.795	43.97	2.46	-3.68	42.75	Average Max	H	99	220	54	-11.25
16773.54	31.53	5.29	5.35	42.17	Average Max	V	139	201	54	-11.83
17740.48	26.49	5.49	9.3	41.28	Average Max	V	164	228	54	-12.72

High channel

Frequency (MHz)	Raw data (dBuV)	Cable Loss (dB)	AF+ P-A (dB)	Corrected Reading (dBuV)	Measurement Type	Ant. Pol. (V/H)	Hgt (cm)	Azt (Deg)	Limit (dBuV)	Margin (dB)
3779.953	60.69	2.01	-8.79	53.91	Average Max	H	139	30	54	-0.09
5151.652	49.29	2.43	-4.11	47.6	Average Max	H	129	360	54	-6.4
11329.22	34.01	3.9	5.29	43.2	Average Max	V	142	288	54	-10.8
16997.52	30.79	5.35	6.84	42.99	Average Max	V	189	187	54	-11.01
5298.659	43.29	2.46	-3.63	42.12	Average Max	H	99	220	54	-11.88
17057.49	26.12	5.36	7.23	38.7	Average Max	V	120	315	54	-15.3

Restricted Band Edge

High channel

Peak, Horizontal

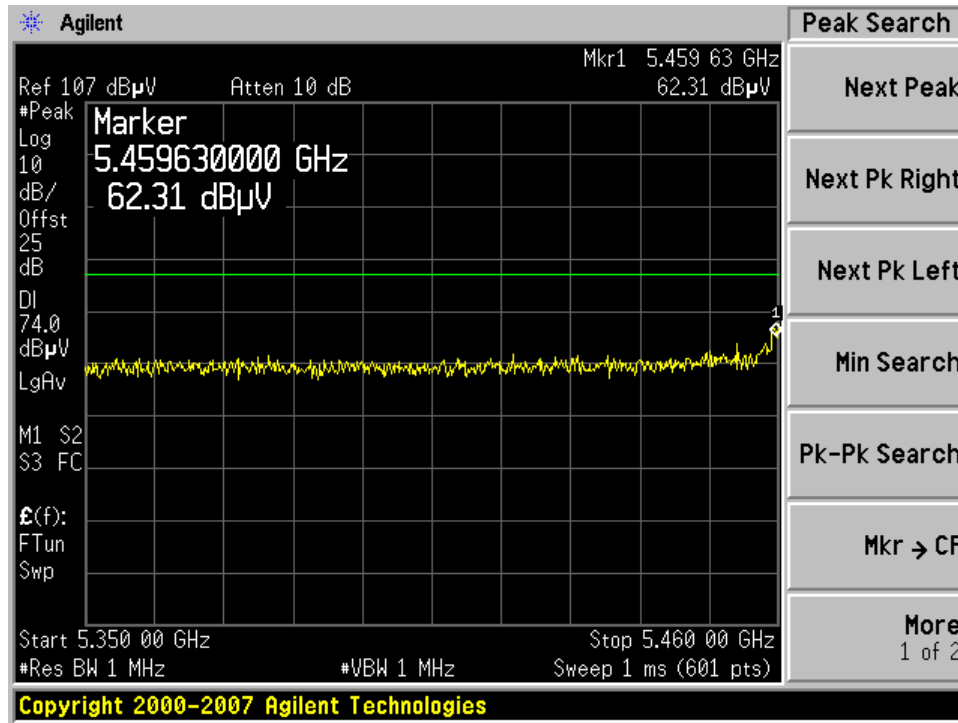

Average, Horizontal

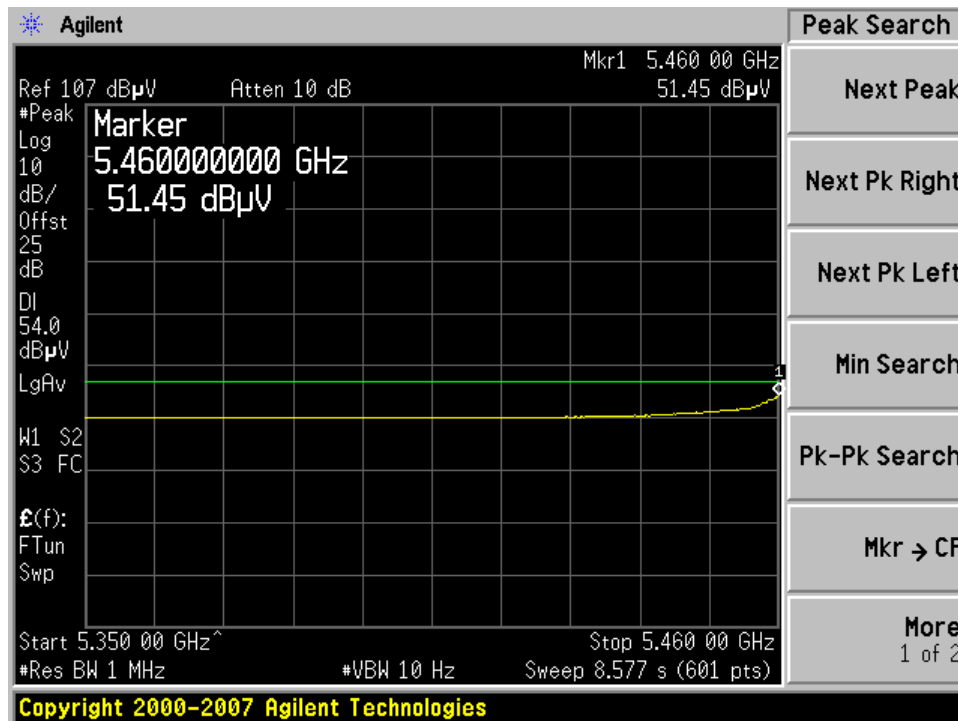

Peak, Vertical

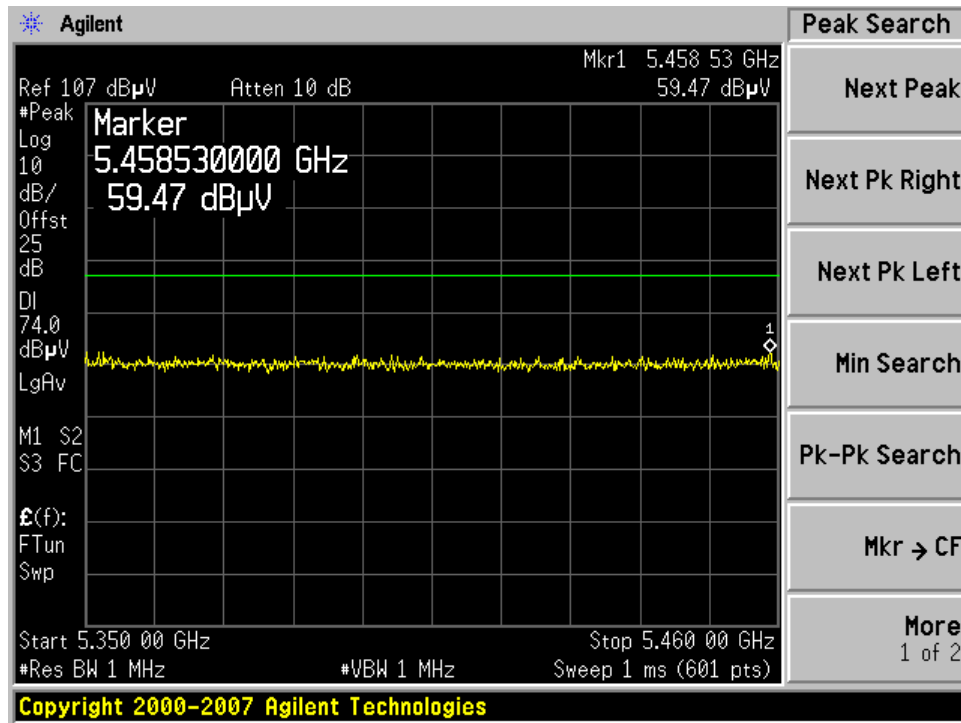

Average, Vertical

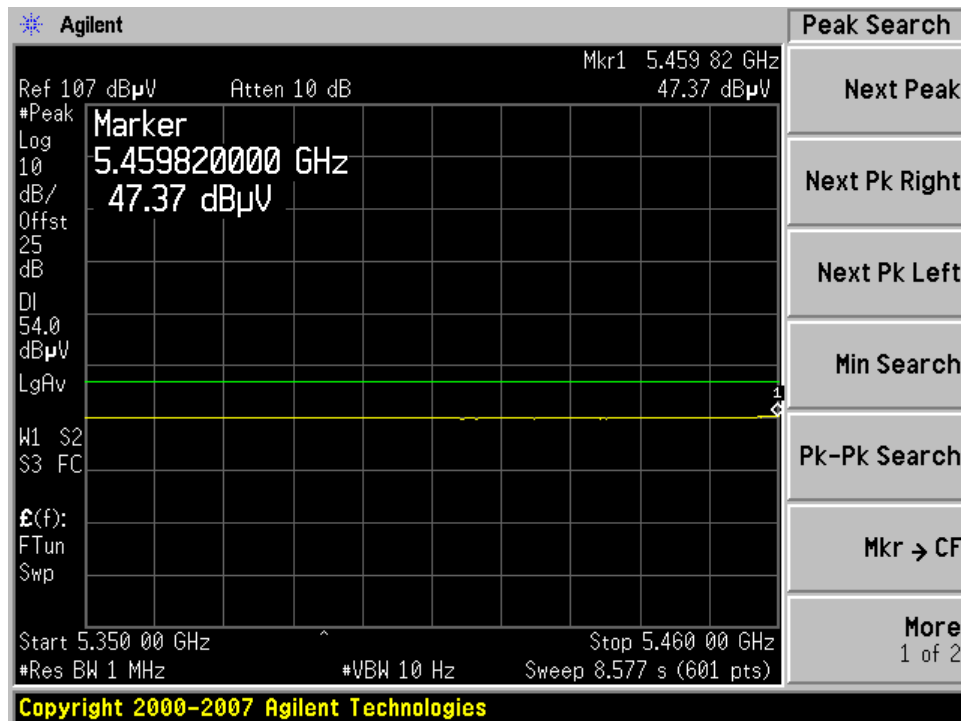

9 FCC §15.407(a) & RSS 210 A9.2 – 26 dB & 99% Emission Bandwidth

9.1 Applicable Standard

None, for power limit determination only.

9.2 Measurement Procedure

1. Check the calibration of the measuring instrument using either an internal calibrator or a known signal from an external generator.
2. Position the EUT without connection to measurement instrument. Turn on the EUT and connect it to measurement instrument. Then set it to any one convenient frequency within its operating range. Set a reference level on the measuring instrument equal to the highest peak value.
3. Measure the frequency difference of two frequencies that were attenuated 26 dB from the reference level. Record the frequency difference as the emissions bandwidth.
4. Repeat above procedures until all frequencies measured were complete.

9.3 Equipment List

Manufacturer	Description	Model	Serial Number	Cal. Date
Agilent	Spectrum analyzer	E4440A	MY44303352	2008-04-28

* **Statement of Traceability:** **BACL Corp.** attests that all calibrations have been performed per the NVLAP requirements, traceable to the NIST.

9.4 Test Setup Diagram

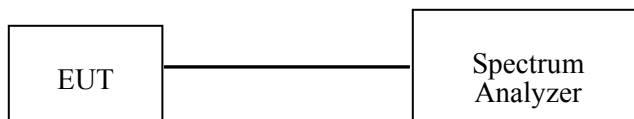

9.5 Environmental Conditions

Temperature:	20° C
Relative Humidity:	40%
ATM Pressure:	1019 mbar

*The testing was performed by Xiao Ming Hu from 2008-05-15.

9.6 Test Results:**5250-5350 MHz Band (W53)**

Channel	Frequency (MHz)	26 dB BW (kHz)	99% BW (MHz)
802.11 n 20MHz			
Low	5260	24429	17.6885
Middle	5300	22987	17.7034
High	5320	21861	17.6627
802.11 n 40MHz			
Low	5270	42014	36.3058
High	5310	42446	36.3170
802.11 a 20 MHz			
Low	5260	25317	16.7108
Middle	5300	25937	16.7047
High	5320	20884	15.8849

5470-5725 MHz Band (W56)

Channel	Frequency (MHz)	26 dB BW (kHz)	99% BW (MHz)
802.11 n 20MHz			
Low	5500	27911	17.7506
Middle	5600	36033	18.7996
High	5700	33292	18.5037
802.11 n 40MHz			
Low	5510	45099	36.3775
Middle	5590	47601	36.4463
High	5670	53178	36.4654
802.11 a 20 MHz			
Low	5500	31048	17.3816
Middle	5600	35652	19.3607
High	5700	35119	18.1364

9.6.1 5250-5350 MHz Band (W53)

802.11n 20MHz:

Low Channel

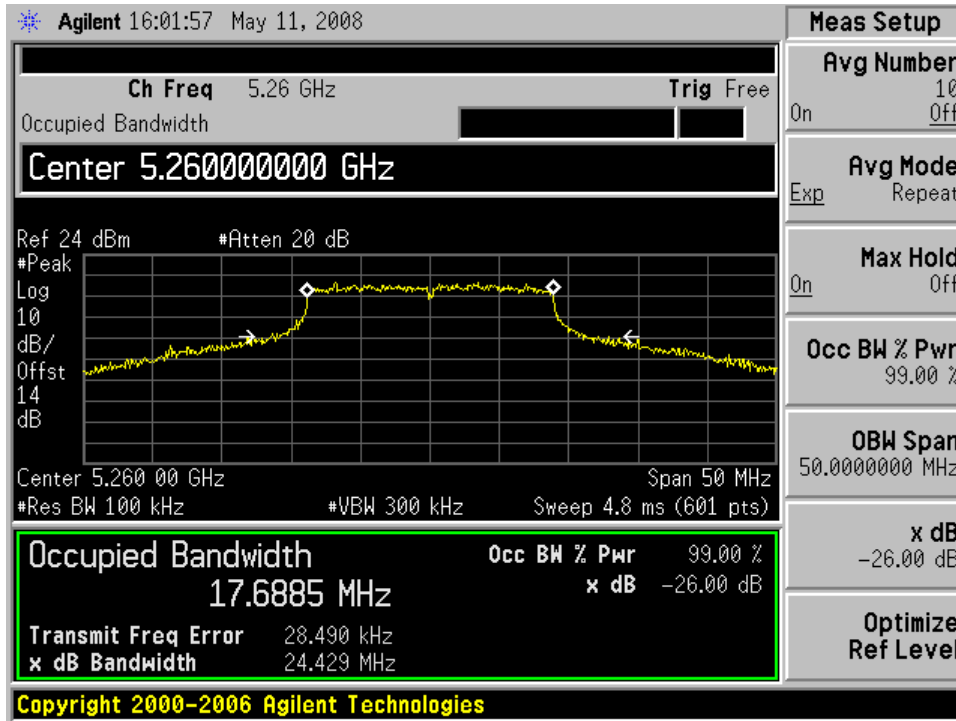

Middle Channel

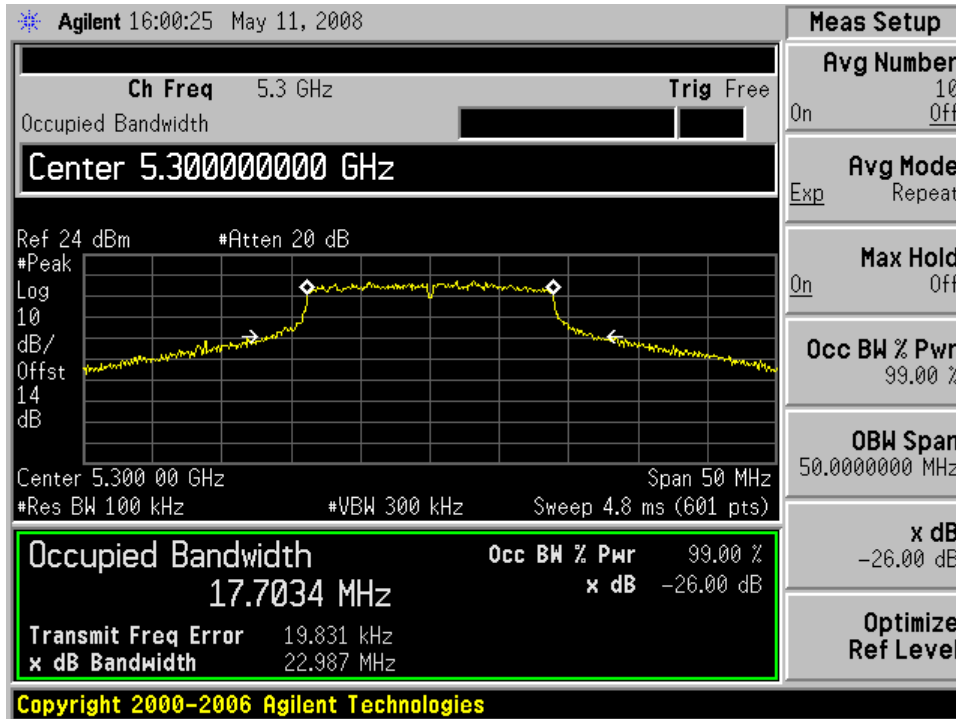

High Channel

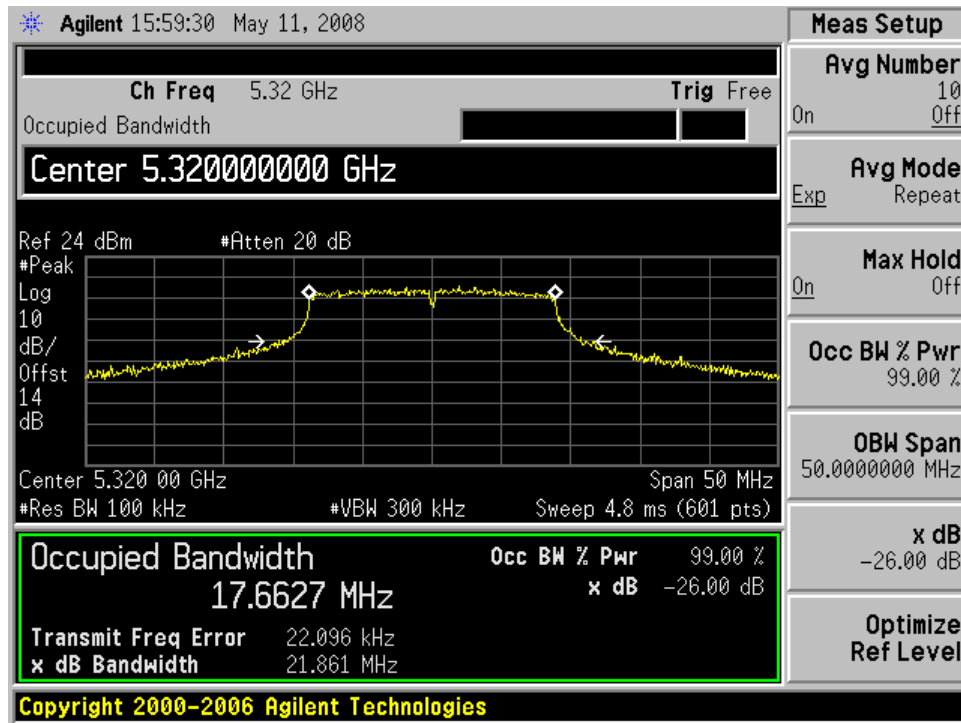

802.11a 20MHz:

Low Channel

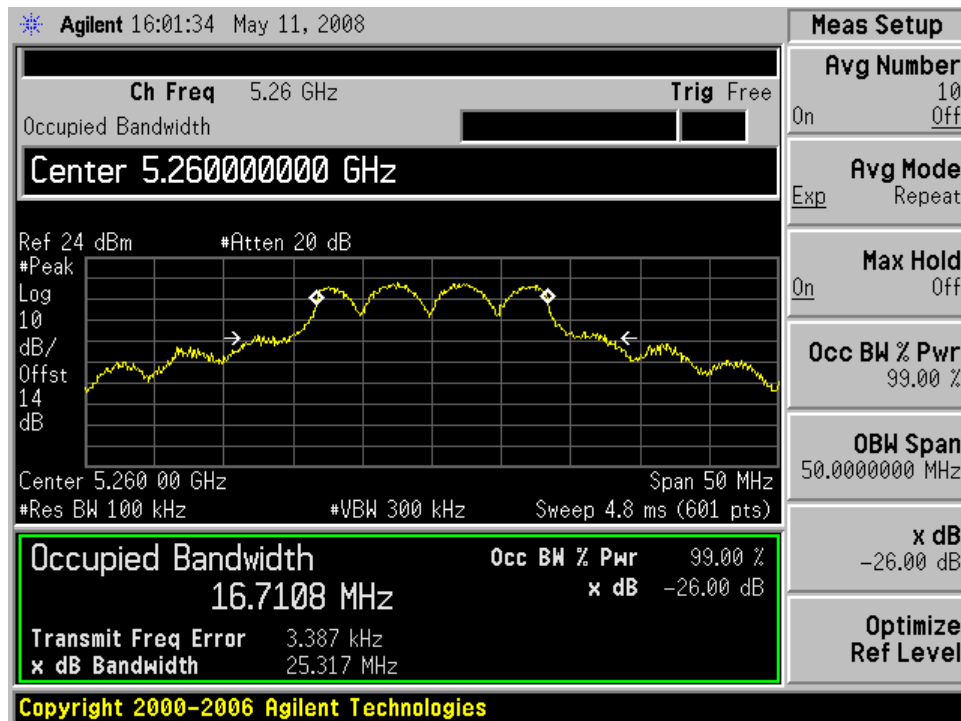

Middle Channel

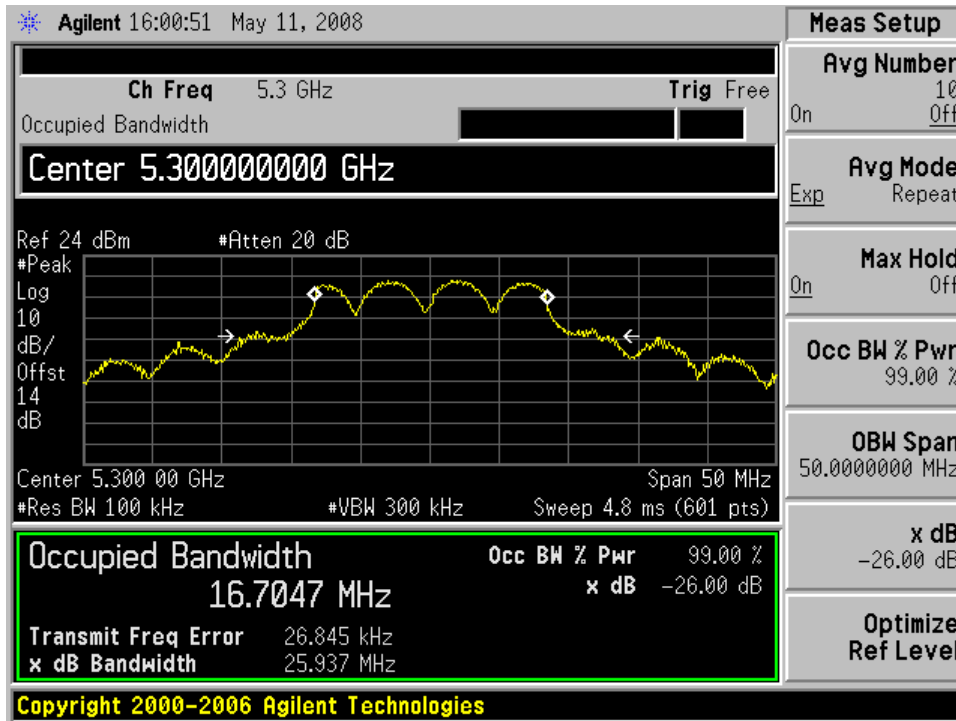

High Channel

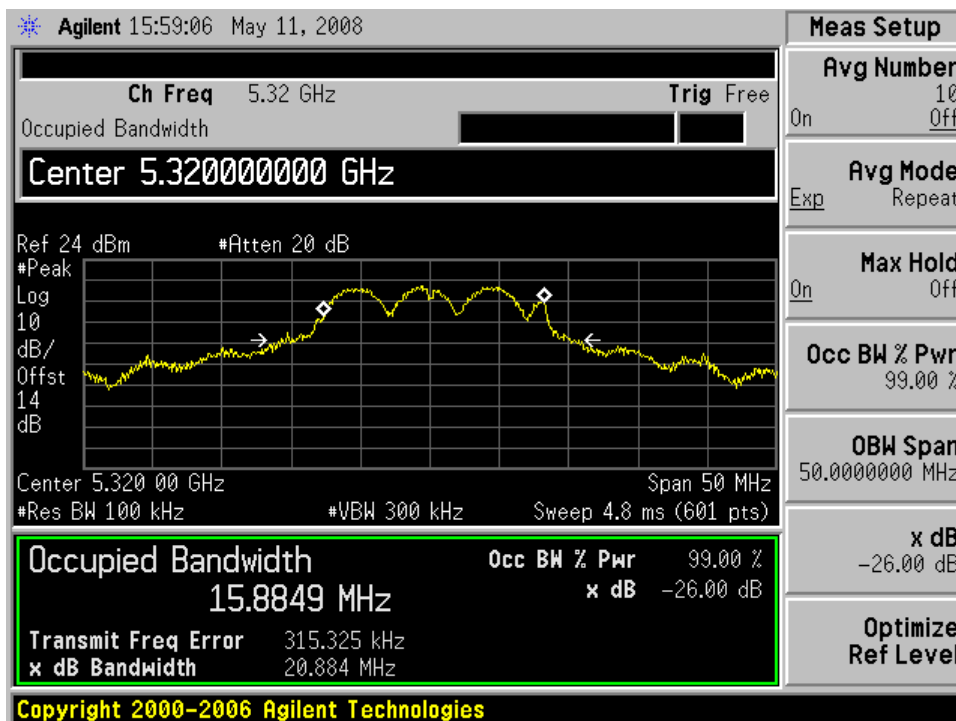

802.11n 40MHz:

Low Channel

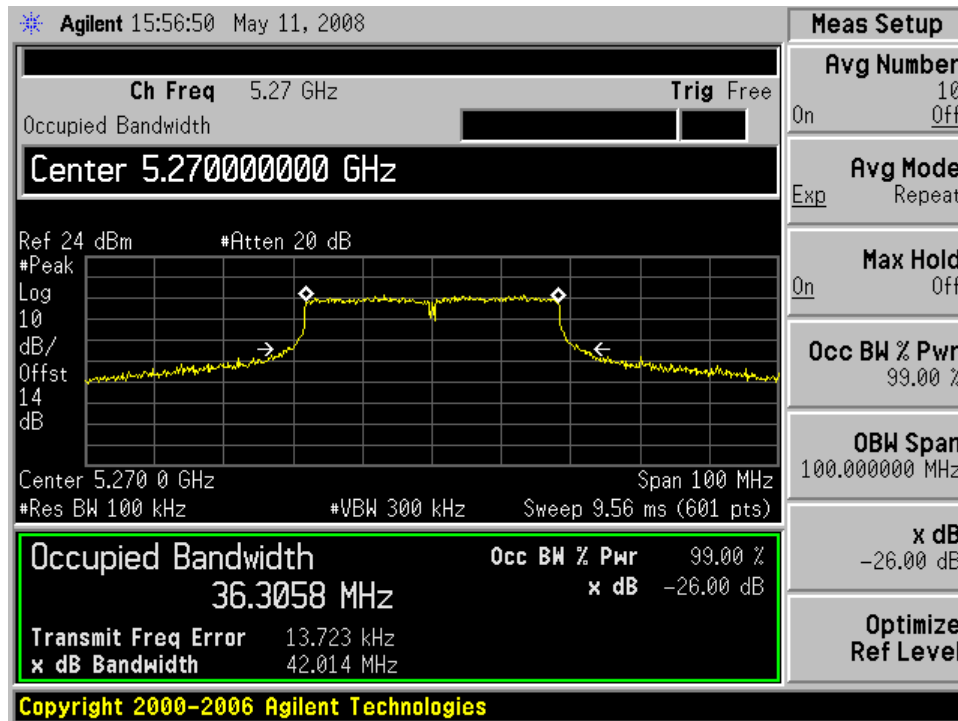

High Channel

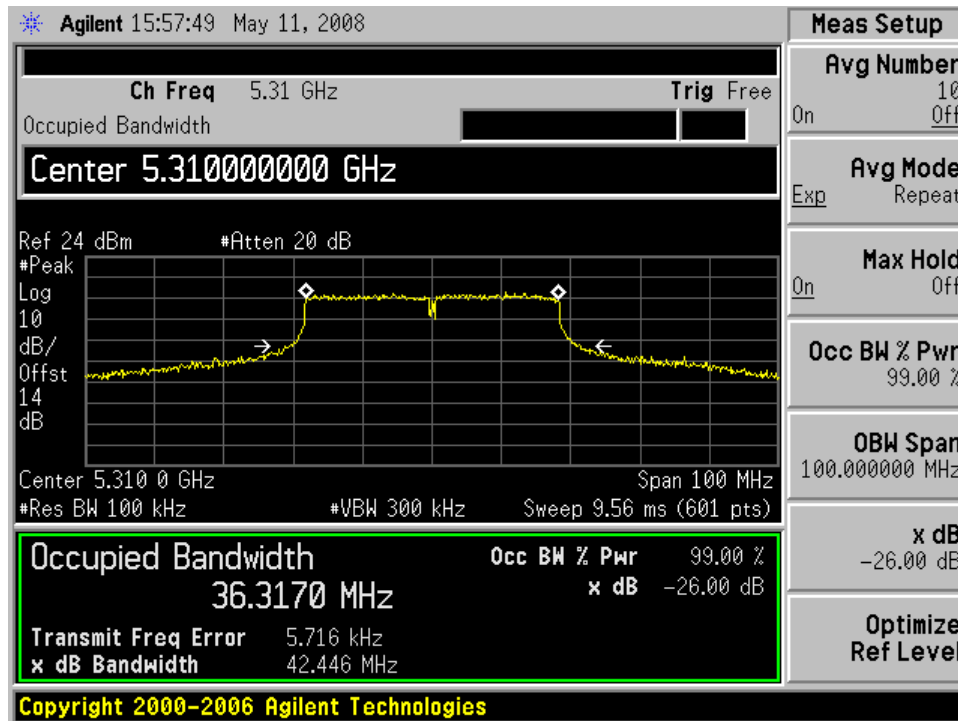

9.6.2 5470-5725 MHz Band (W56)

802.11n 20MHz:

Low Channel

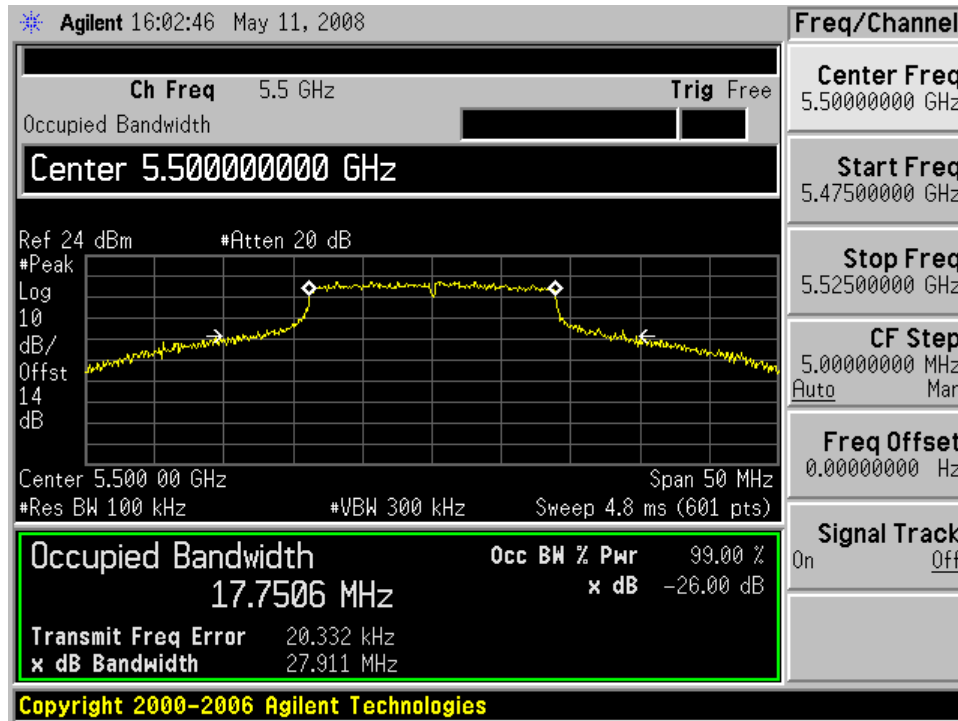

Middle Channel

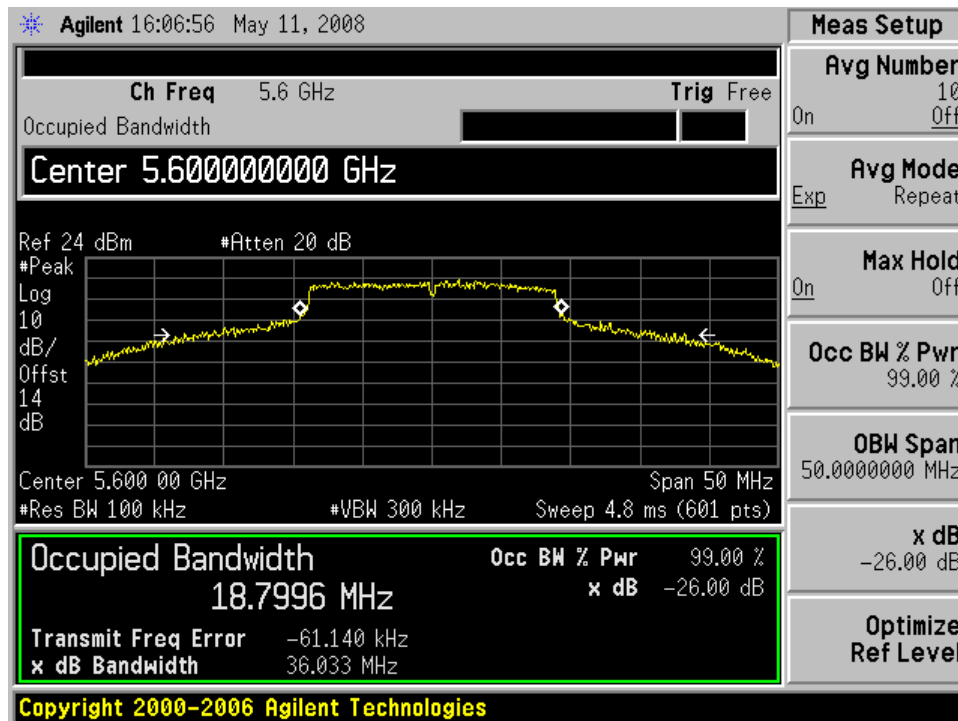

High Channel

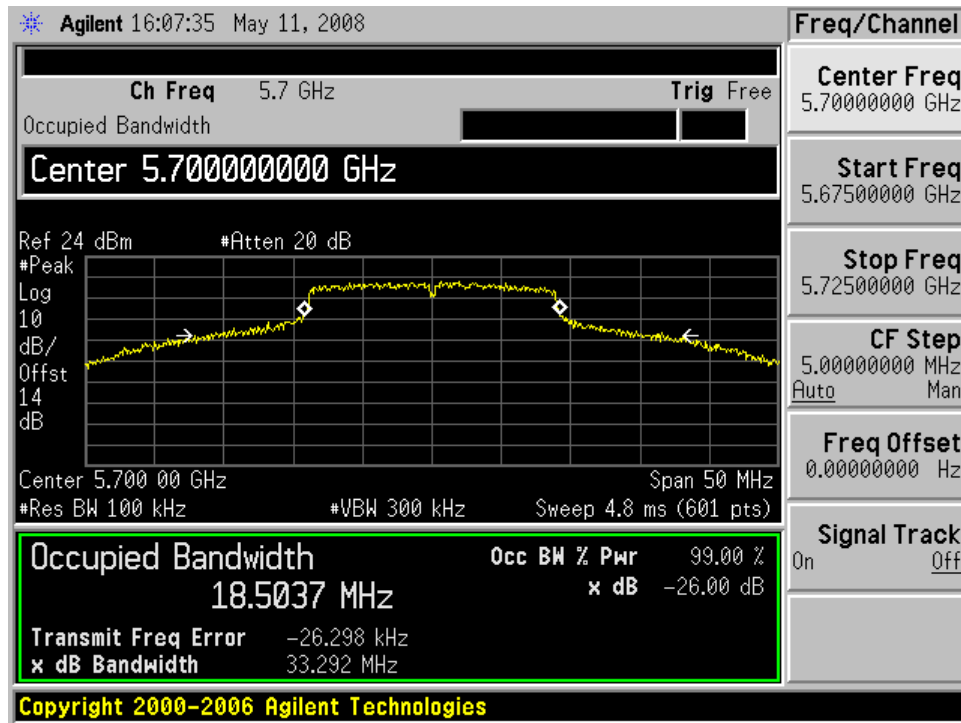

802.11a 20MHz:

Low Channel

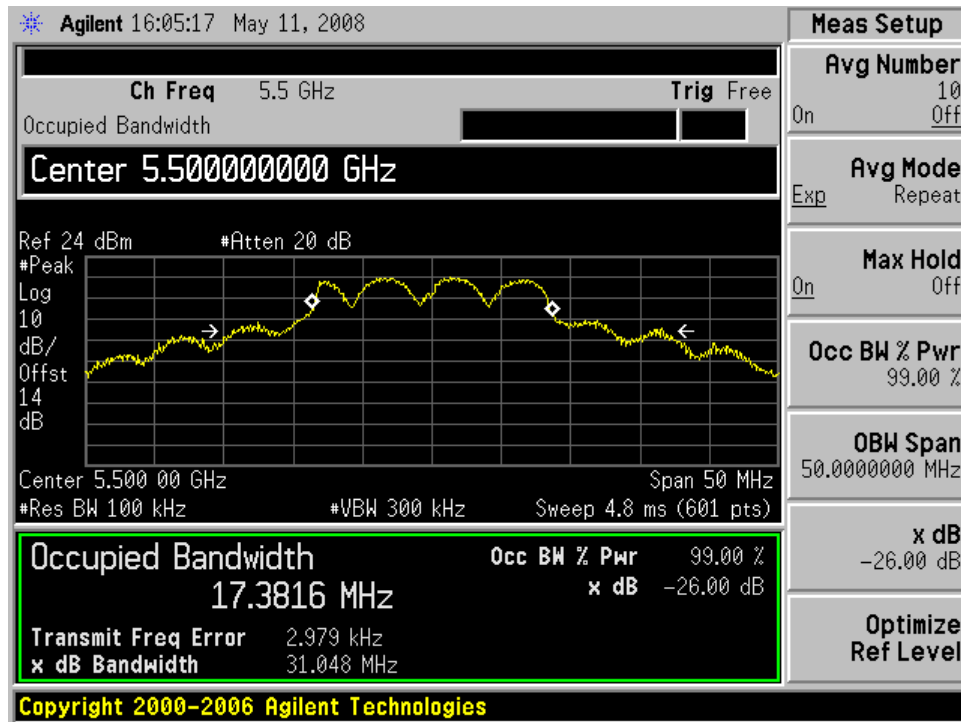

Middle Channel

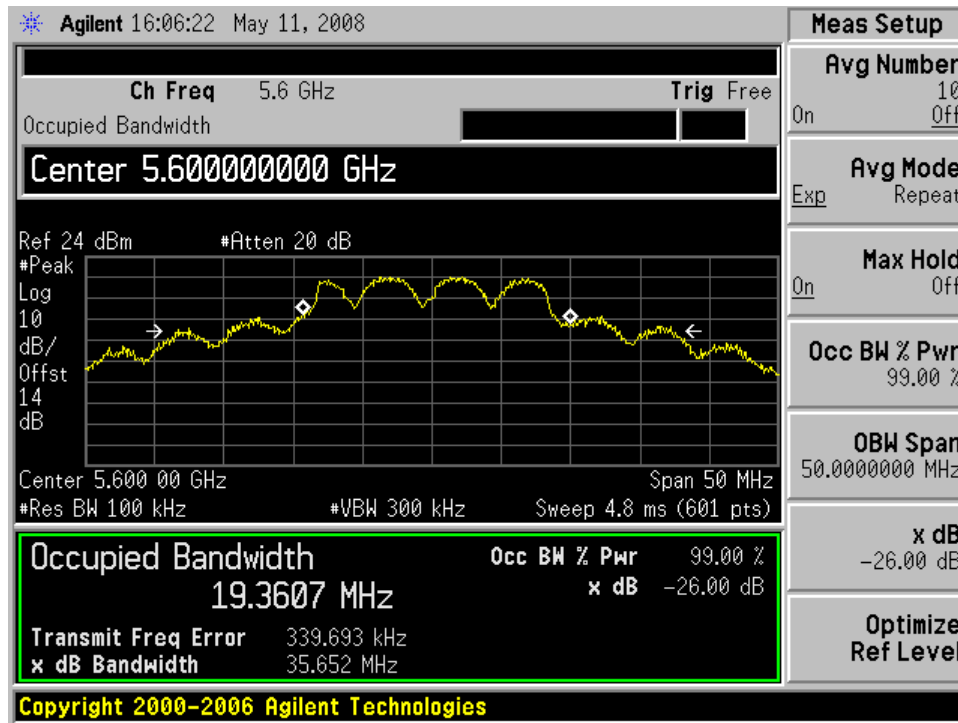

High Channel

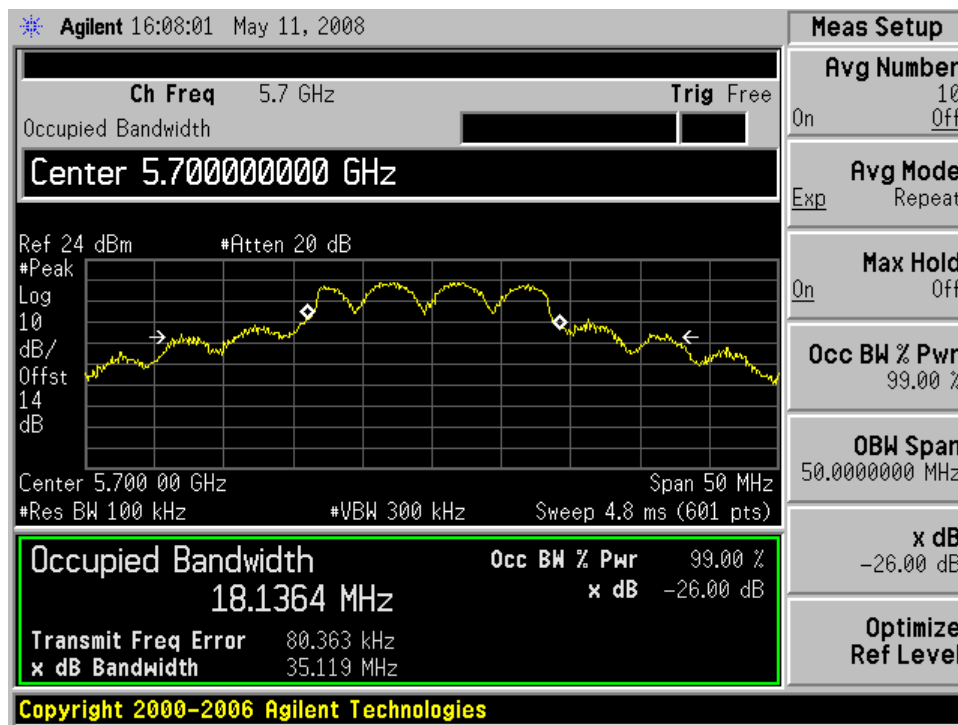

802.11n 40MHz:

Low Channel

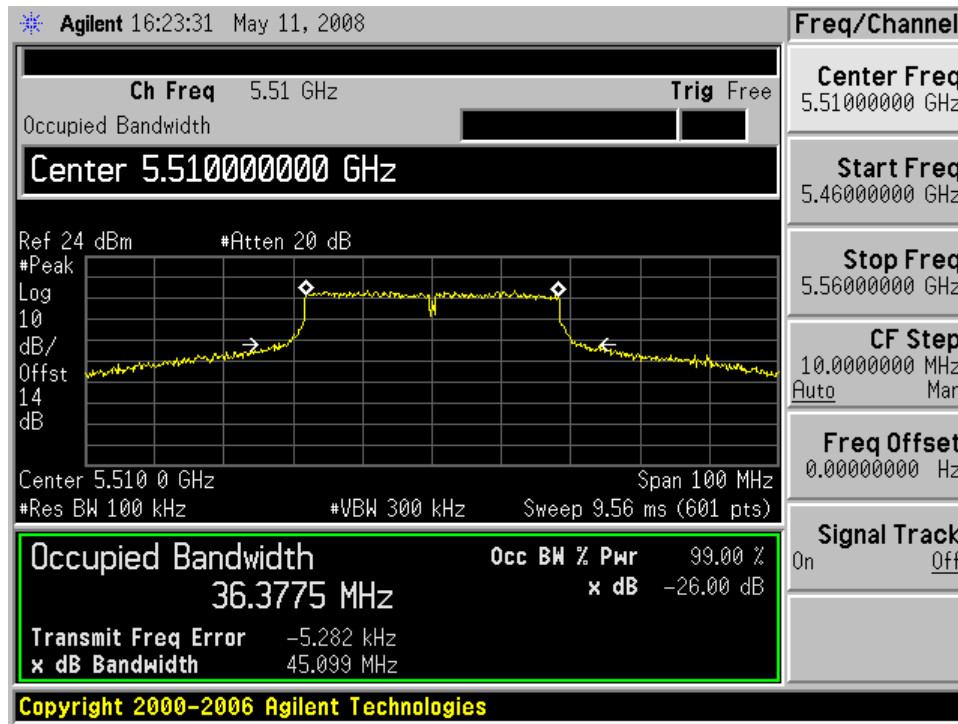

Middle Channel

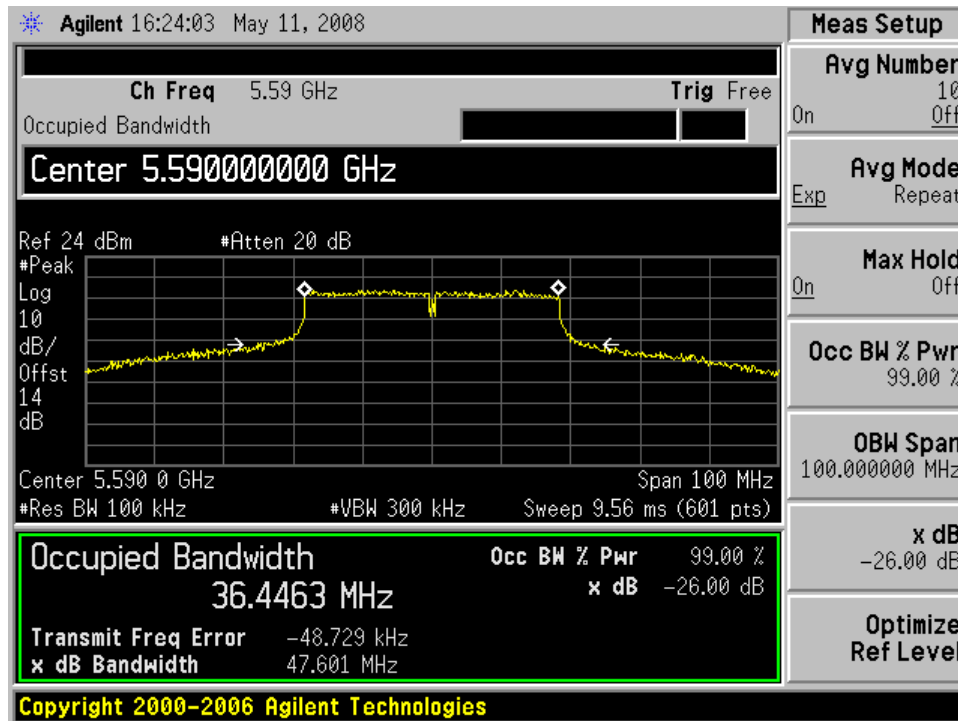

High Channel

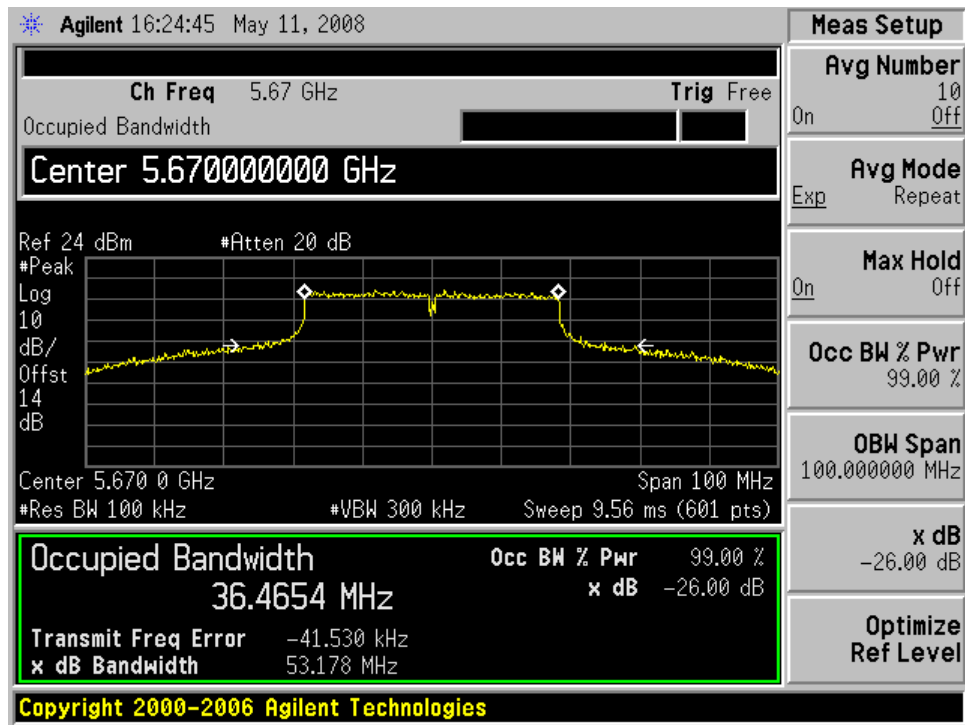

10 FCC §15.407 (a) & RSS 210 A9.2 - Maximum Output Power

10.1 Applicable Standard

§15.407 (a)(1) For the band 5.15 – 5.25 GHz, the maximum conducted output power over the frequency band of operation shall not exceed the lesser of 50 mW or $4 \text{ dBm} + 10 \log B$, where B is the 26 dB emission bandwidth in MHz. If transmitting antennas of directional gain greater than 6 dBi are used, the conducted output power and the peak power spectral density shall be reduced by the amount in dB that the directional gain of the antenna exceeds 6 dBi.

§15.407 (a)(2) For the band 5.25 – 5.35 GHz, the maximum conducted output power over the frequency band of operation shall not exceed the lesser of 250 mW or $11 \text{ dBm} + 10 \log B$, where B is the 26 dB emission bandwidth in MHz. If transmitting antennas of directional gain greater than 6 dBi are used, the conducted output power and the peak power spectral density shall be reduced by the amount in dB that the directional gain of the antenna exceeds 6 dBi.

RSS-210 §A9.2 Transmitter Power and e.i.r.p. Limits

(1) For the band 5150-5250 MHz, the maximum equivalent isotropically radiated power (e.i.r.p.) shall not exceed 200 mW or $10 + 10 \log_{10} B$, dBm, whichever power is less. B is the 99% emission bandwidth in MHz. The e.i.r.p. spectral density shall not exceed 10 dBm in any 1.0 MHz band.

(2) For the bands 5250-5350 MHz and 5470-5725 MHz, the maximum conducted output power shall not exceed 250 mW or $11 + 10 \log_{10} B$, dBm, whichever power is less. The power spectral density shall not exceed 11 dBm in any 1.0 MHz band. The maximum e.i.r.p. shall not exceed 1.0 W or $17 + 10 \log_{10} B$, dBm, whichever power is less. B is the 99% emission bandwidth in MHz.

10.2 Measurement Procedure

1. Place the EUT on a bench and set it in transmitting mode.
2. Remove the antenna from the EUT and then connect a low loss RF cable from the antenna port to a spectrum analyzer.
3. Add a correction factor to the display.

Each chain is measured separately and the total power is calculated using the following formula:

$$\text{Total Power} = 10 \log (10^{(\text{Chain A Power} / 10)} + 10^{(\text{Chain B Power} / 10)})$$

$$\text{Effective Antenna Gain} = \text{Antenna Gain} + 10 \log (\text{Number Tx Chains})$$

10.3 Equipment Lists

Manufacturer	Description	Model	Serial Number	Cal. Date
Agilent	Spectrum analyzer	E4440A	MY44303352	2008-04-28

* **Statement of Traceability: BACL Corp.** attests that all calibrations have been performed per the NVLAP requirements, traceable to the NIST.

10.4 Test Setup Diagram

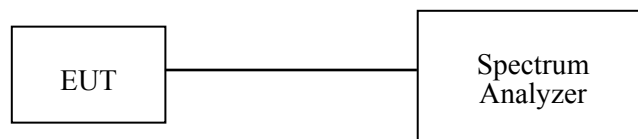

10.5 Environmental Conditions

Temperature:	20° C -23° C
Relative Humidity:	30% - 63%
ATM Pressure:	1011mbar - 1019 mbar

**The testing was performed by Xiao Ming Hu from 2008-05-16 to 2008-05-19.*

10.6 Test Result

10.6.1 5250-5350 MHz Band (W53)

802.11n 20MHz

Frequency (MHz)/BW	Fixed Limit (dBm)	26 dB BW (MHz)	4+10log B limit (dBm)	Limit (dBm)
5260/20	24	24.429	24.88	24.00
5300/20	24	22.987	24.61	24.00
5320/20	24	21.861	24.40	24.00

Frequency (MHz)/BW	J4 (dBm)	J5 (dBm)	J4 (mW)	J5 (mW)	Total Power (mW)	Total Power (dBm)	Limit (dBm)	Margin (dB)
5260/20	20.51	18.83	112.46	76.38	188.84	22.76	24	-1.24
5300/20	20.45	18.30	110.92	67.61	178.53	22.52	24	-1.48
5320/20	20.21	19.85	104.95	96.61	201.56	23.04	24	-0.96

802.11a 20MHz

Frequency (MHz)/BW	Fixed Limit (dBm)	26 dB BW (MHz)	4+10log B limit (dBm)	Limit (dBm)
5260/20	24	25.317	25.03	24.00
5300/20	24	25.937	25.14	24.00
5320/20	24	20.884	24.20	24.00

Frequency (MHz)/BW	J4 (dBm)	J5 (dBm)	J4 (mW)	J5 (mW)	Total Power (mW)	Total Power (dBm)	Limit (dBm)	Margin (dB)
5260/20	17.46	16.73	55.72	47.10	102.82	20.12	24	-3.88
5300/20	19.01	18.43	79.62	69.66	149.28	21.74	24	-2.26
5320/20	18.88	18.31	77.27	67.76	145.03	21.61	24	-2.39

802.11n 40MHz

Frequency (MHz)/BW	Fixed Limit (dBm)	26 dB BW (MHz)	4+10log B limit (dBm)	Limit (dBm)
5270/40	24	42.014	27.23	24.00
5310/40	24	42.446	27.28	24.00

Frequency (MHz)/BW	J4 (dBm)	J5 (dBm)	J4 (mW)	J5 (mW)	Total Power (mW)	Total Power (dBm)	Limit (dBm)	Margin (dB)
5270/40	19.77	20.40	94.84	109.65	204.49	23.11	24	-0.89
5310/40	20.66	19.16	116.41	82.41	198.83	22.98	24	-1.02

10.6.2 5470-5725 MHz Band (W56)**802.11n 20MHz**

Frequency (MHz)/BW	Fixed Limit (dBm)	26 dB BW (MHz)	4+10log B limit (dBm)	Limit (dBm)
5500/20	24	27.911	25.46	24.00
5600/20	24	36.033	26.57	24.00
5700/20	24	33.292	26.22	24.00

Frequency (MHz)/BW	J4 (dBm)	J5 (dBm)	J4 (mW)	J5 (mW)	Total Power (mW)	Total Power (dBm)	Limit (dBm)	Margin (dB)
5500/20	21.00	19.86	125.89	96.83	222.72	23.48	24	-0.52
5600/20	21.69	20.06	147.57	101.39	248.96	23.96	24	-0.04
5700/20	20.24	20.02	105.68	100.46	206.14	23.14	24	-0.86

802.11a 20MHz

Frequency (MHz)/BW	Fixed Limit (dBm)	26 dB BW (MHz)	4+10log B limit (dBm)	Limit (dBm)
5500/20	24	31.048	25.92	24.00
5600/20	24	35.652	26.52	24.00
5700/20	24	35.119	26.46	24.00

Frequency (MHz)/BW	J4 (dBm)	J5 (dBm)	J4 (mW)	J5 (mW)	Total Power (mW)	Total Power (dBm)	Limit (dBm)	Margin (dB)
5500/20	18.58	21.31	72.11	135.21	207.32	23.17	24	-0.83
5600/20	18.80	20.76	75.86	119.12	194.98	22.90	24	-1.10
5700/20	19.59	19.82	90.99	95.94	186.93	22.72	24	-1.28

802.11n 40MHz

Frequency (MHz)/BW	Fixed Limit (dBm)	26 dB BW (MHz)	4+10log B limit (dBm)	Limit (dBm)
5510/40	24	45.099	27.54	24.00
5590/40	24	47.601	27.78	24.00
5670/40	24	53.178	28.26	24.00

Frequency (MHz)/BW	J4 (dBm)	J5 (dBm)	J4 (mW)	J5 (mW)	Total Power (mWatts)	Total Power (dBm)	Limit (dBm)	Margin (dB)
5510/40	21.44	19.63	139.32	91.83	231.15	23.64	24	-0.36
5590/40	19.73	20.83	93.97	121.06	215.03	23.33	24	-0.67
5670/40	20.11	20.19	102.57	104.47	207.04	23.16	24	-0.84

10.6.3 5150-5250 MHz Band (W52)

802.11n 20MHz, Chain j4

Low Channel

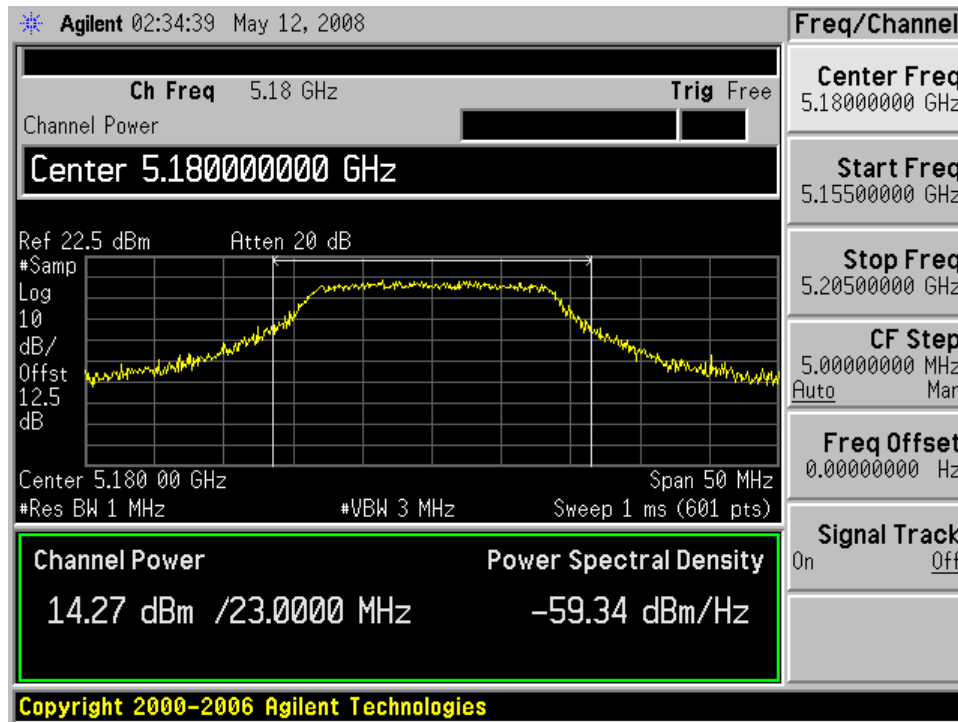

Middle Channel

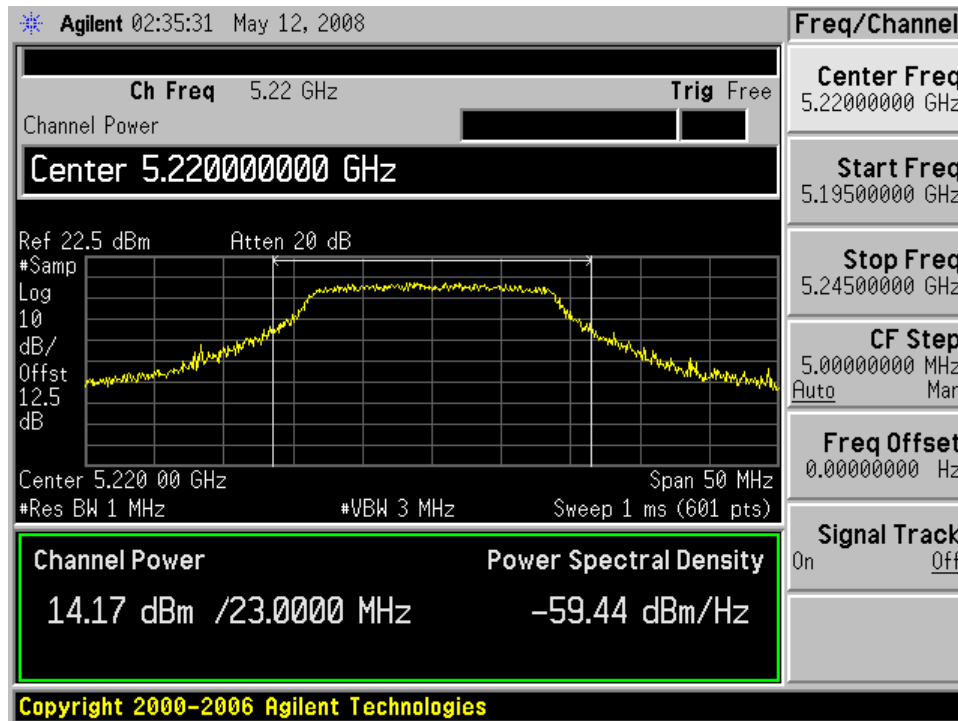

High Channel

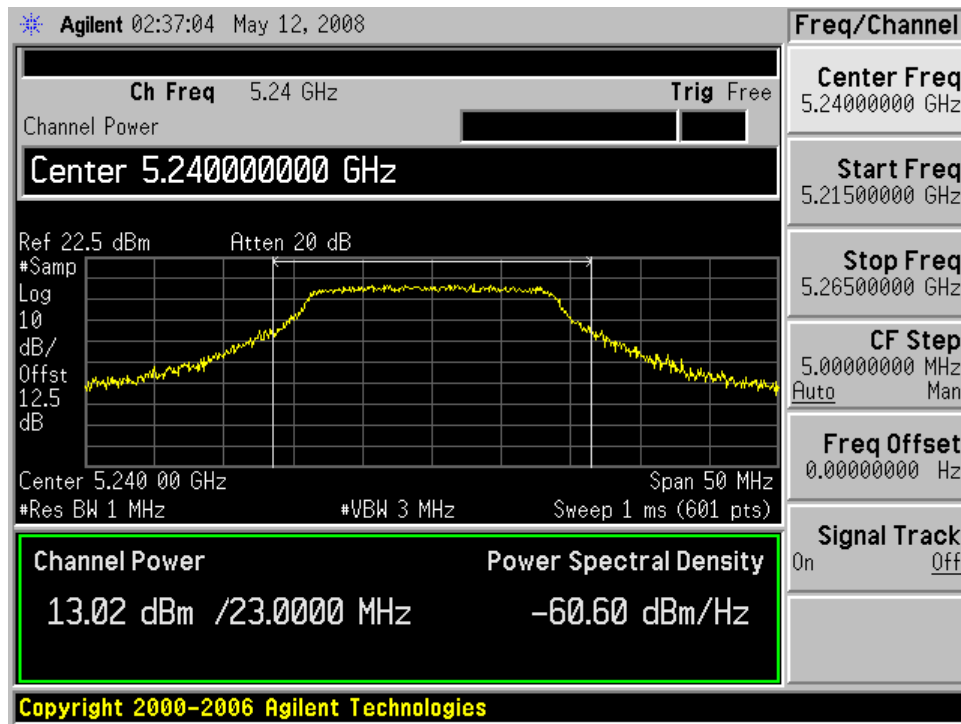

802.11n 20MHz, Chain j5

Low Channel

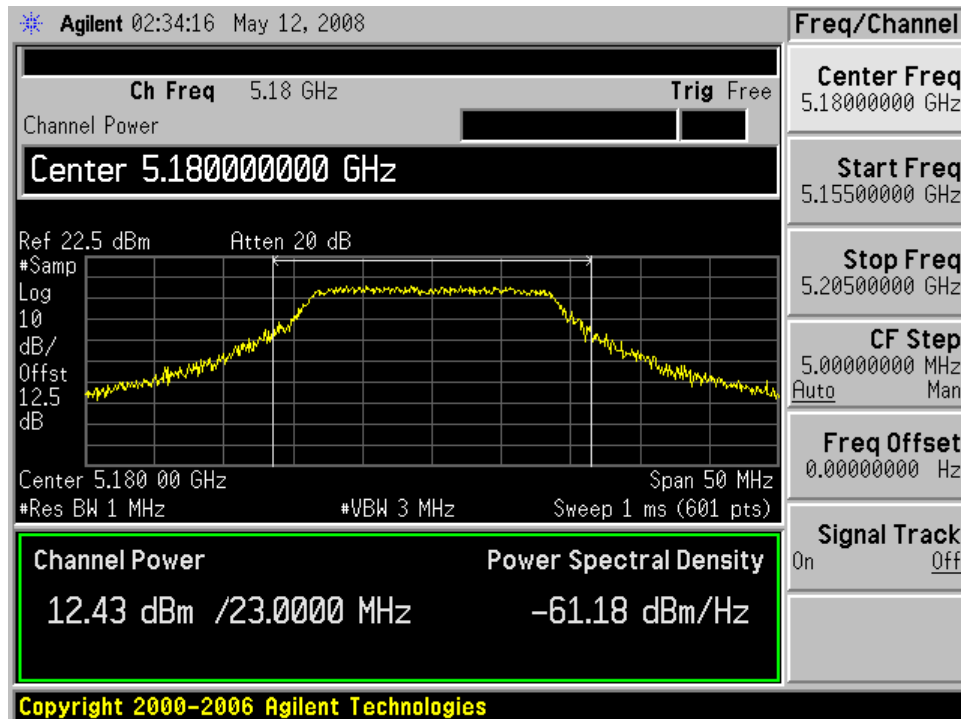

Middle Channel

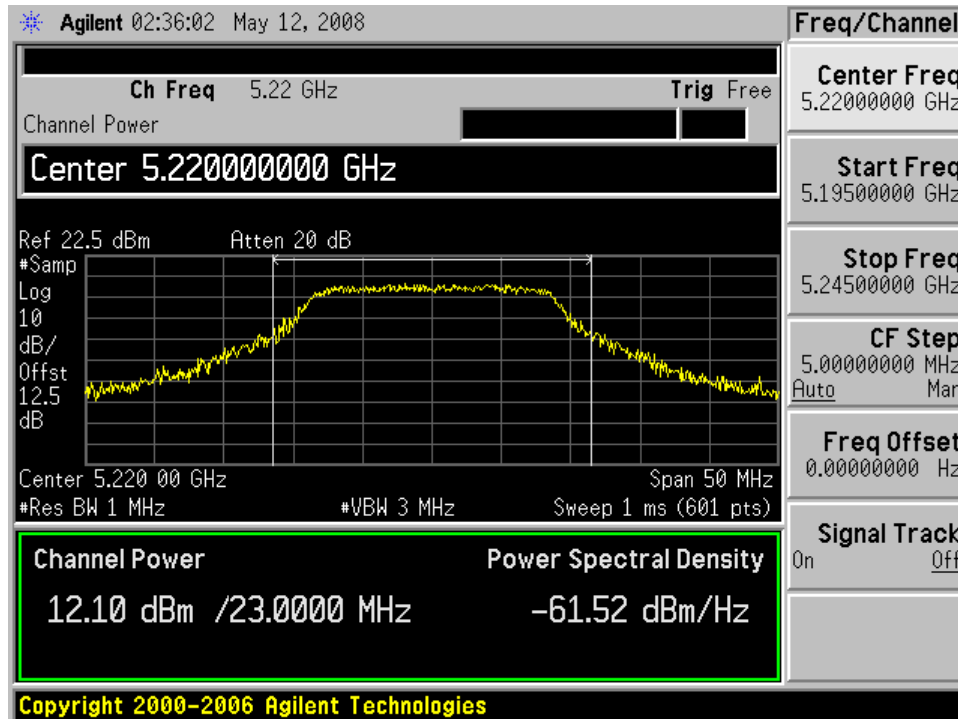

High Channel

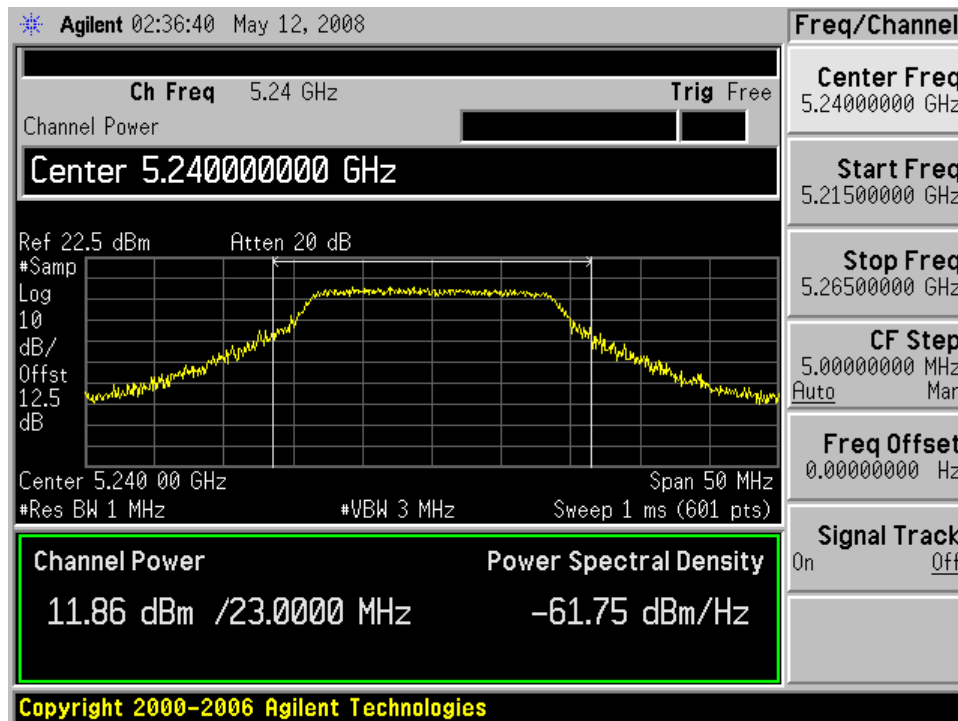

802.11n 40MHz, Chain j4

Low Channel

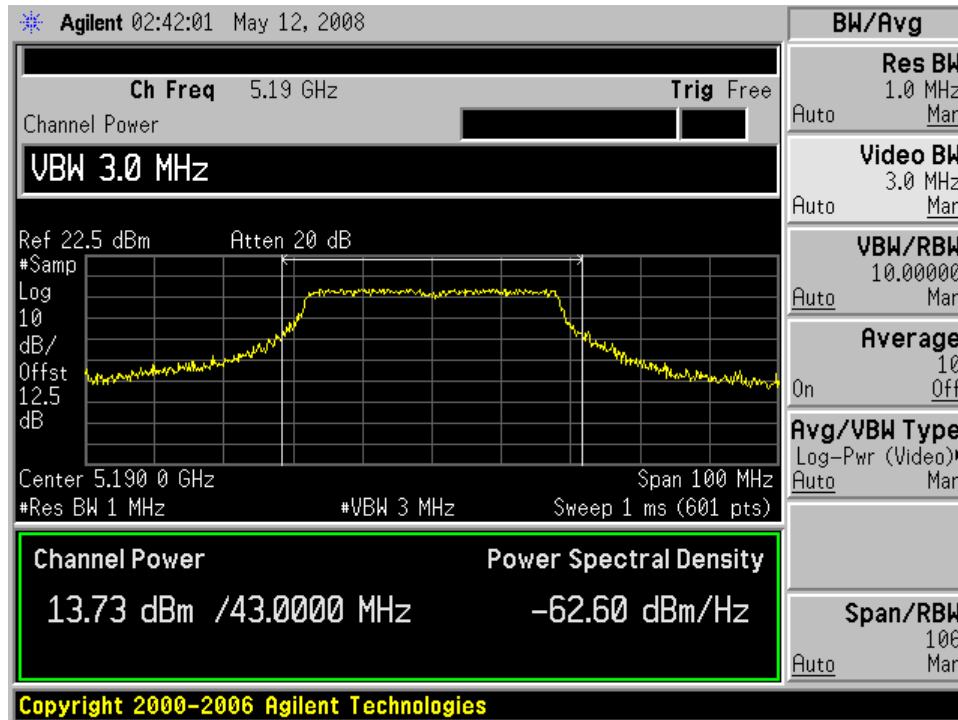

High Channel

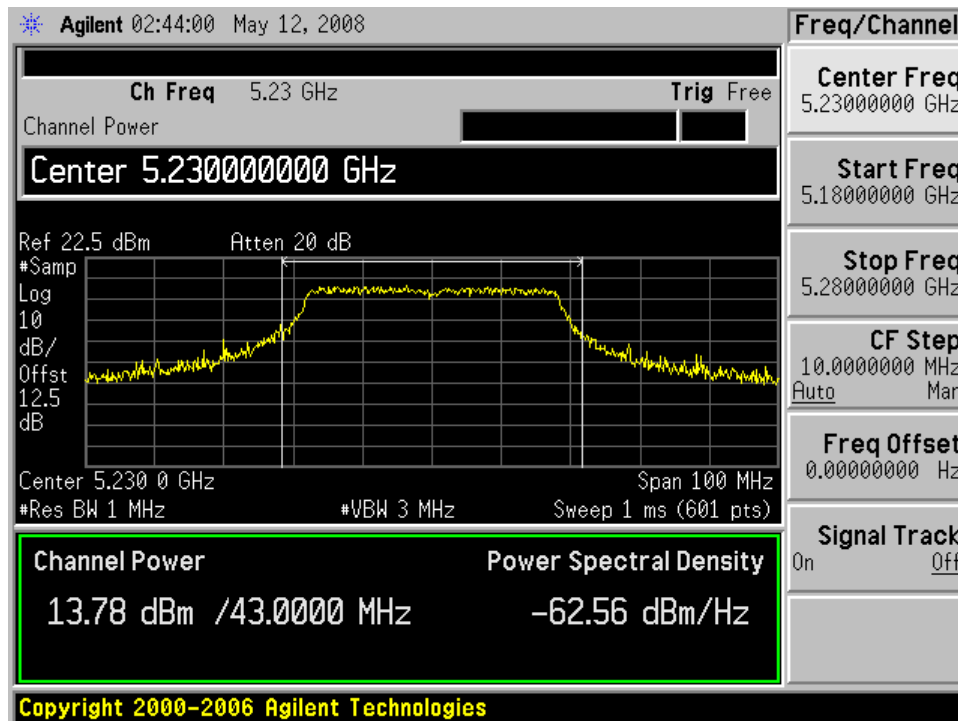

802.11n 40MHz, Chain j5

Low Channel

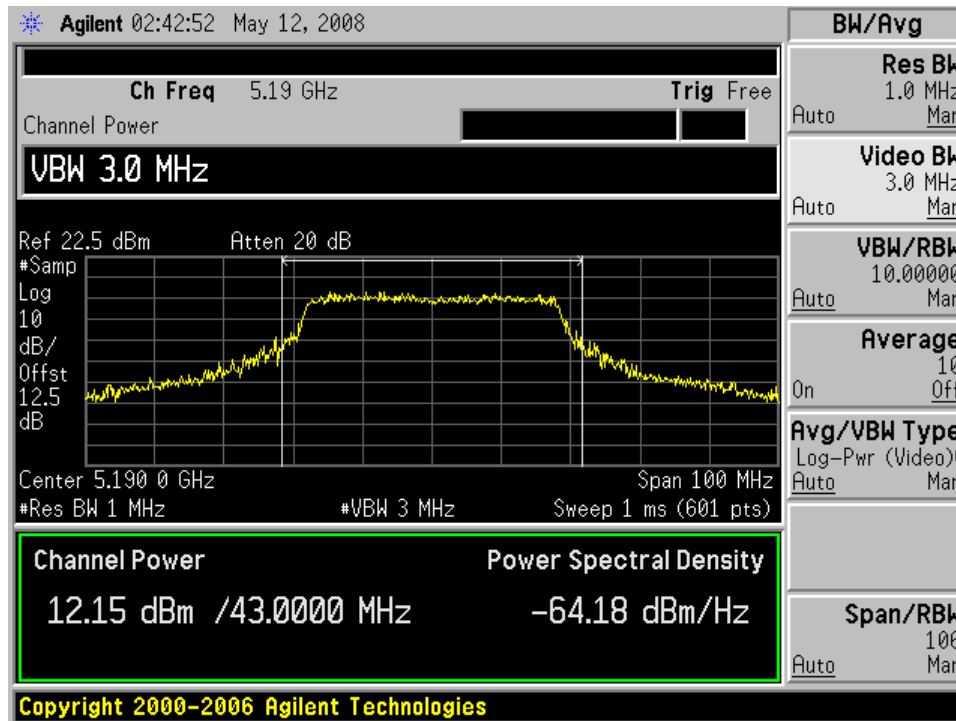

High Channel

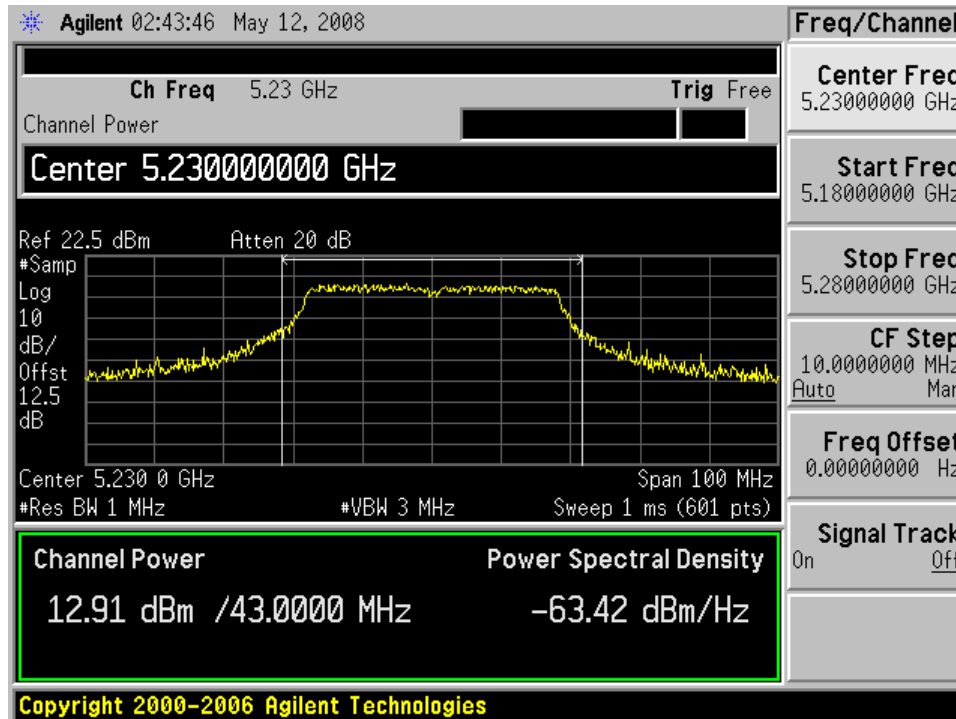

802.11a 20MHz, Chain j4

Low Channel

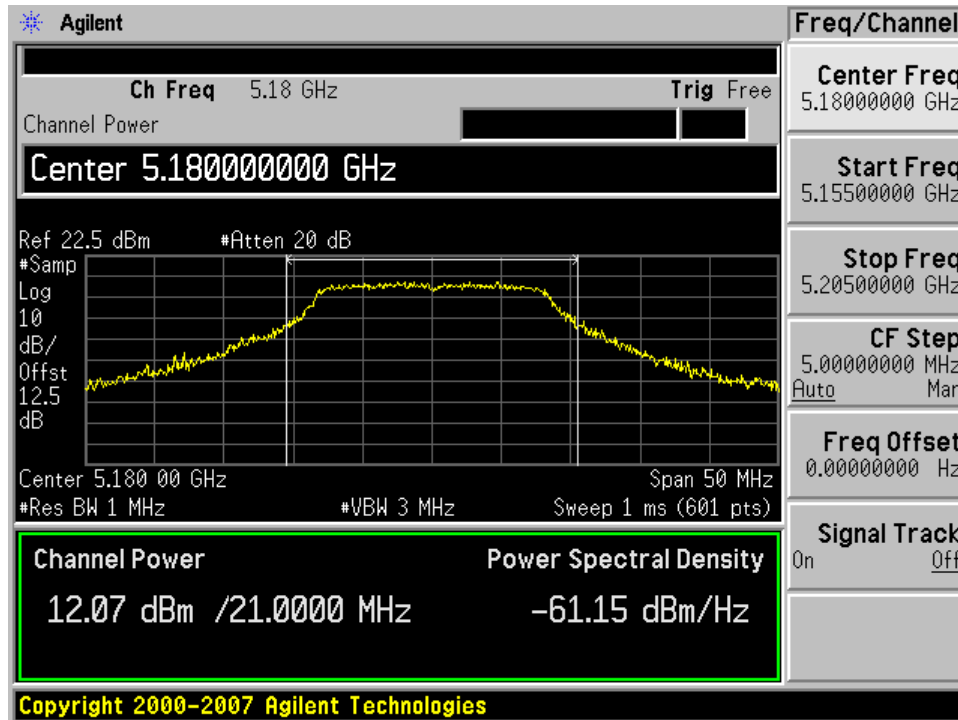

Middle Channel

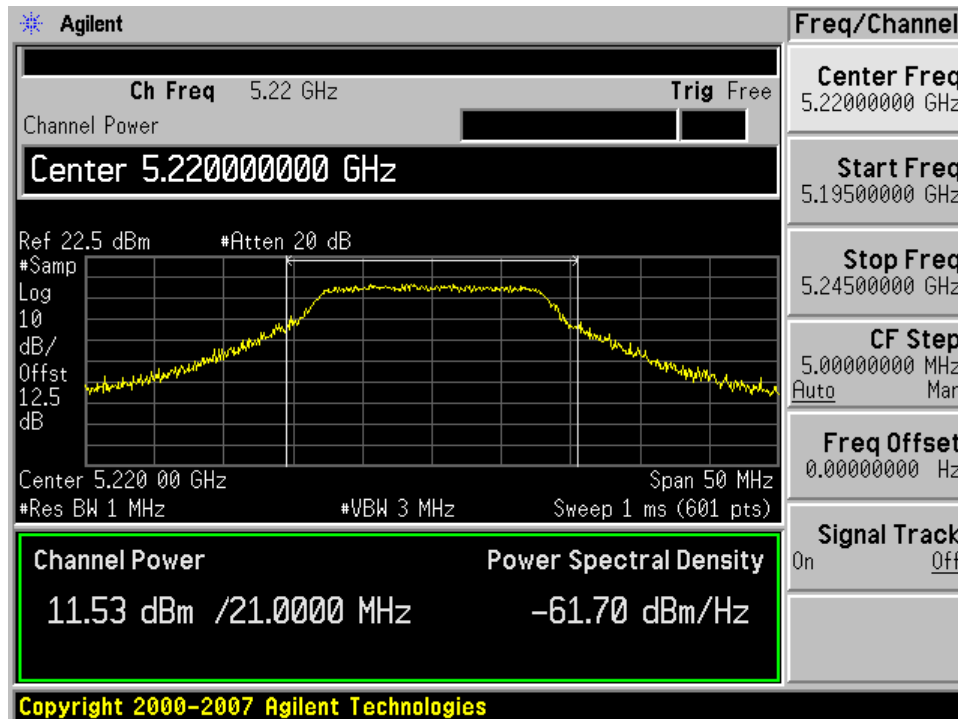

High Channel

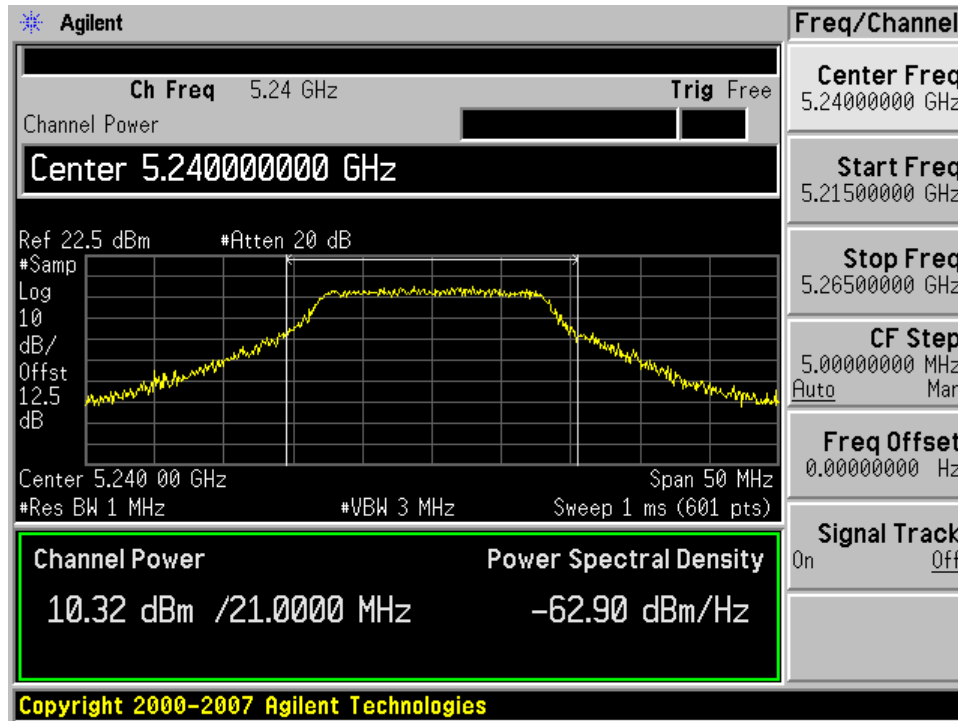

802.11a 20MHz, Chain j5

Low Channel

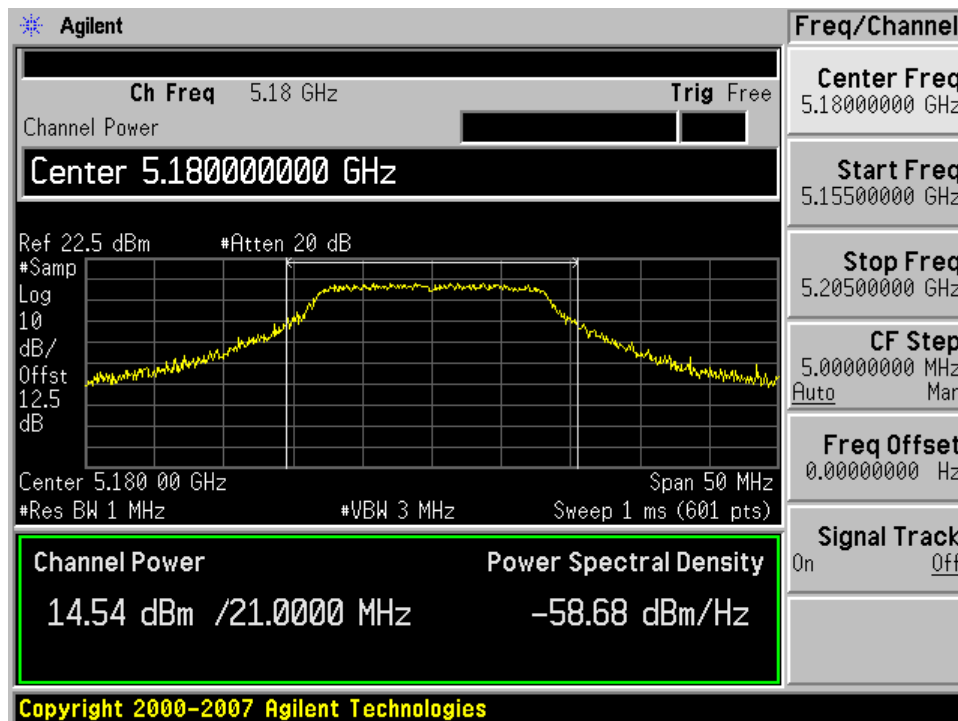

Middle Channel

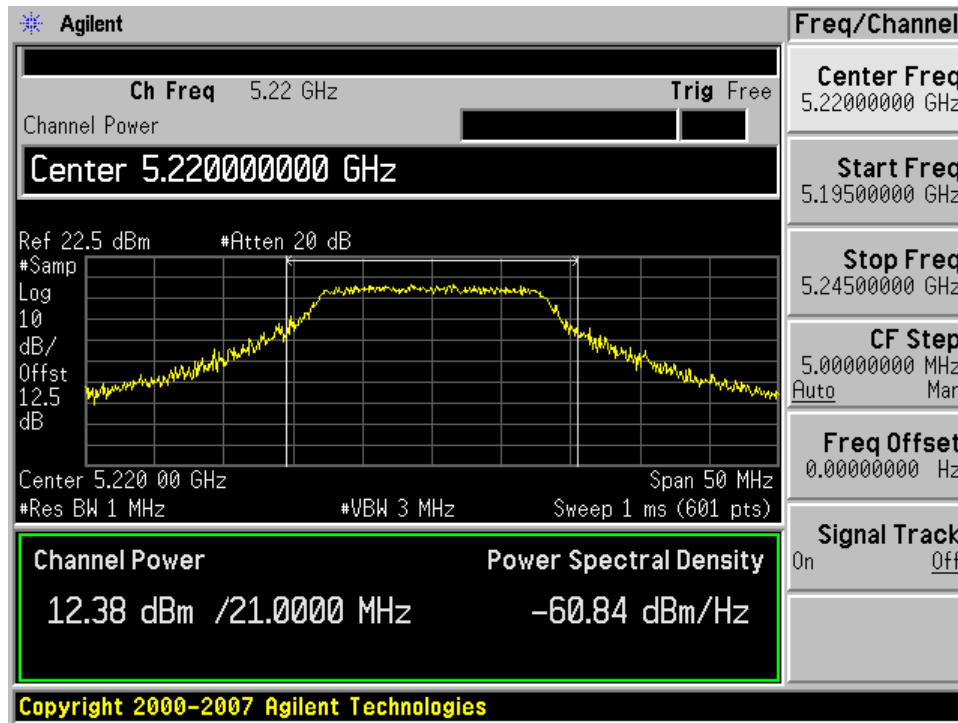

High Channel

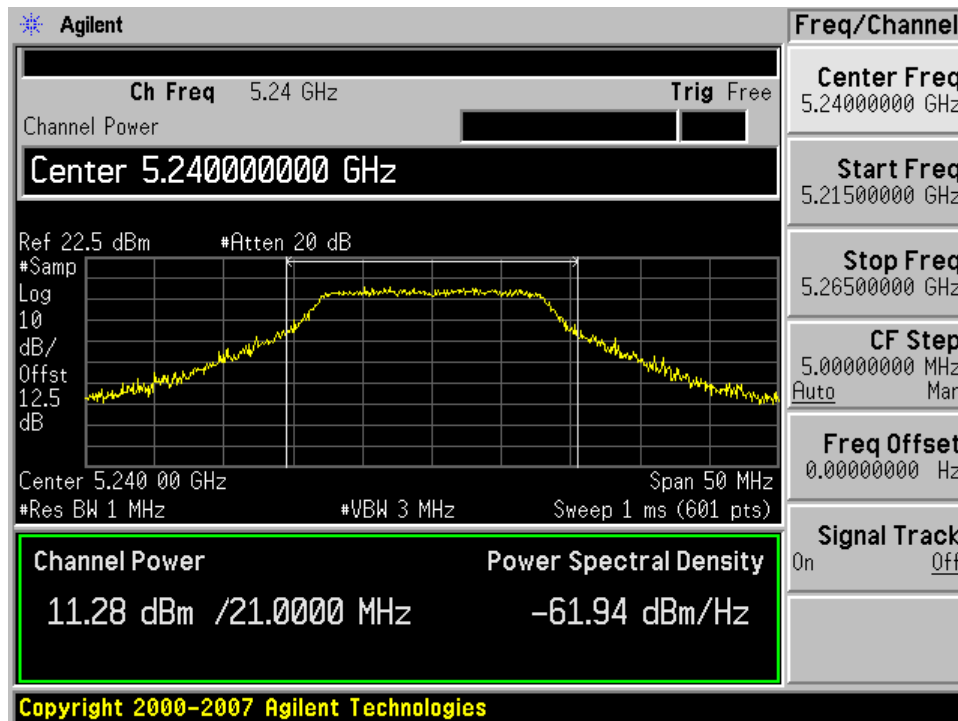

10.6.4 5250-5350 MHz Band (W53)

802.11n 20MHz, Chain j4

Low Channel

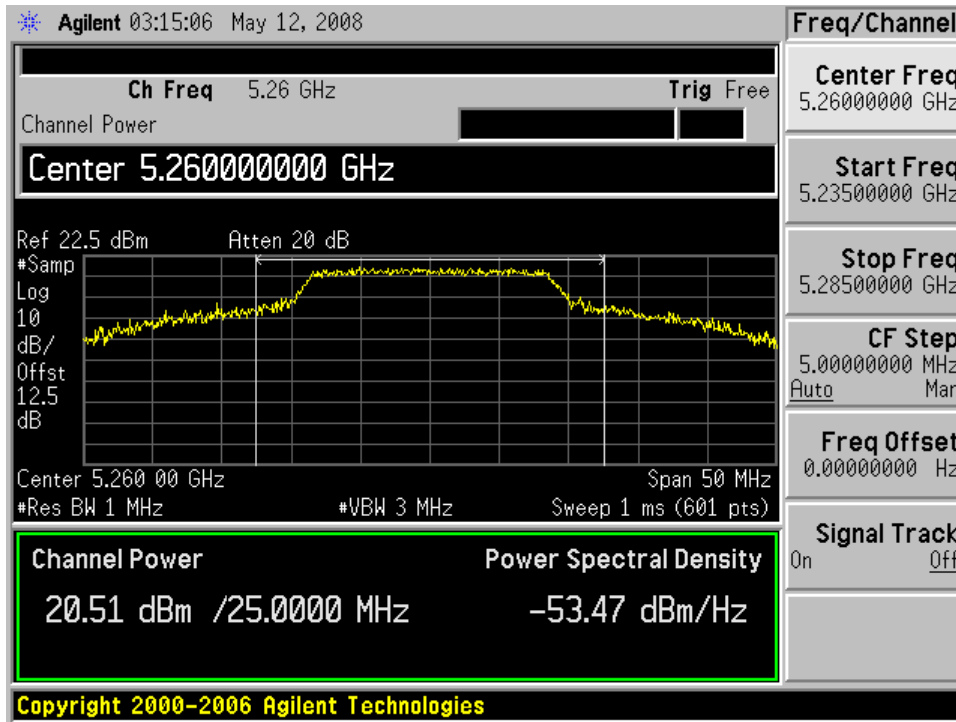

Middle Channel

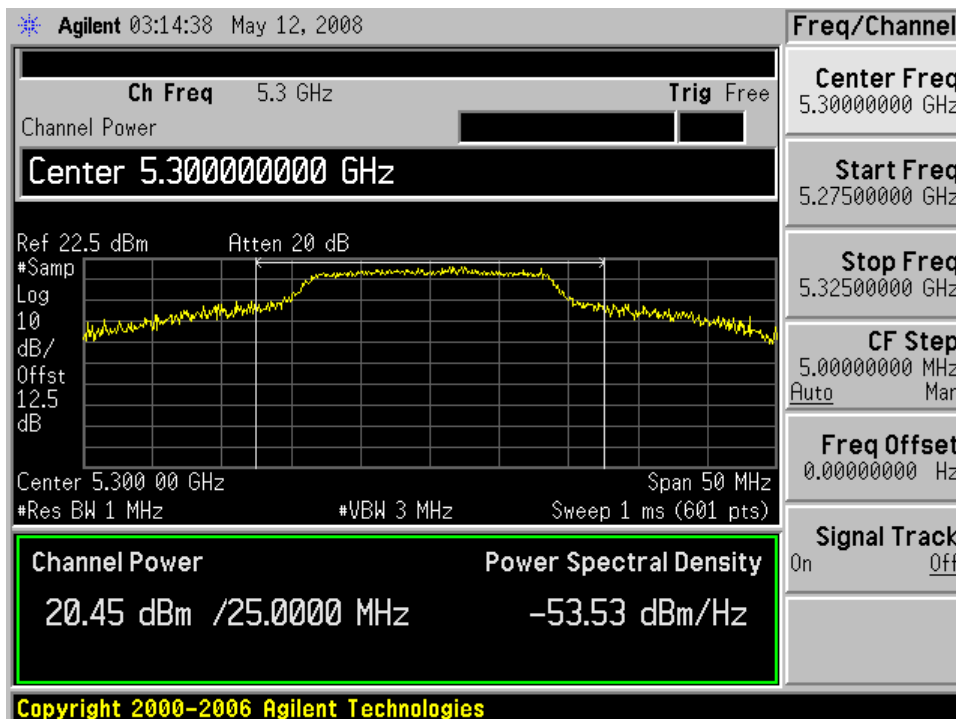

High Channel

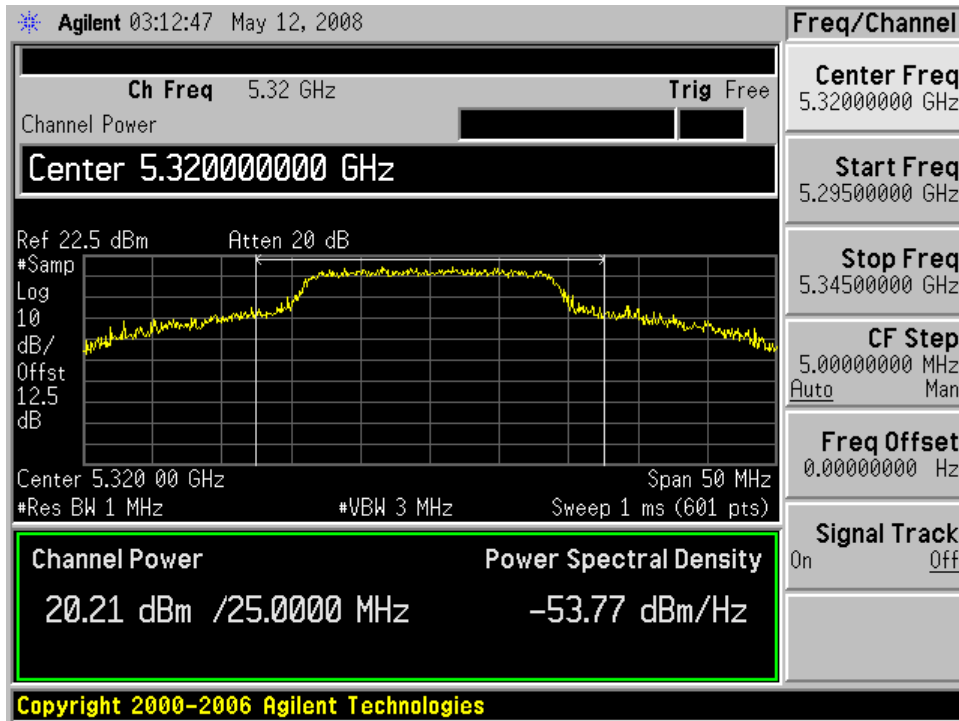

802.11n 20MHz, Chain j5

Low Channel

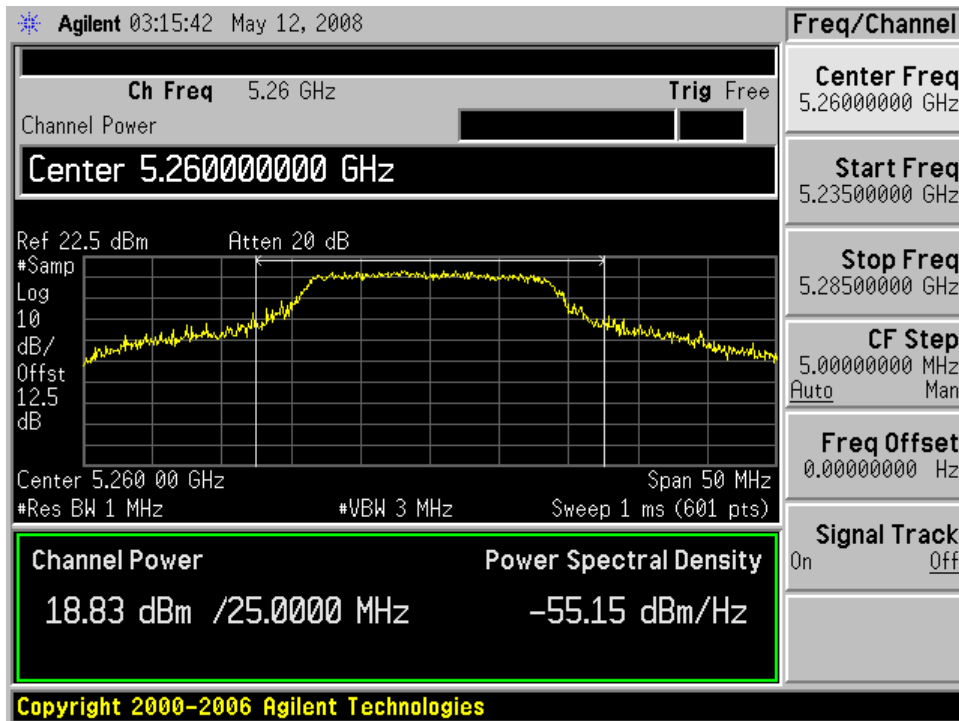

Middle Channel

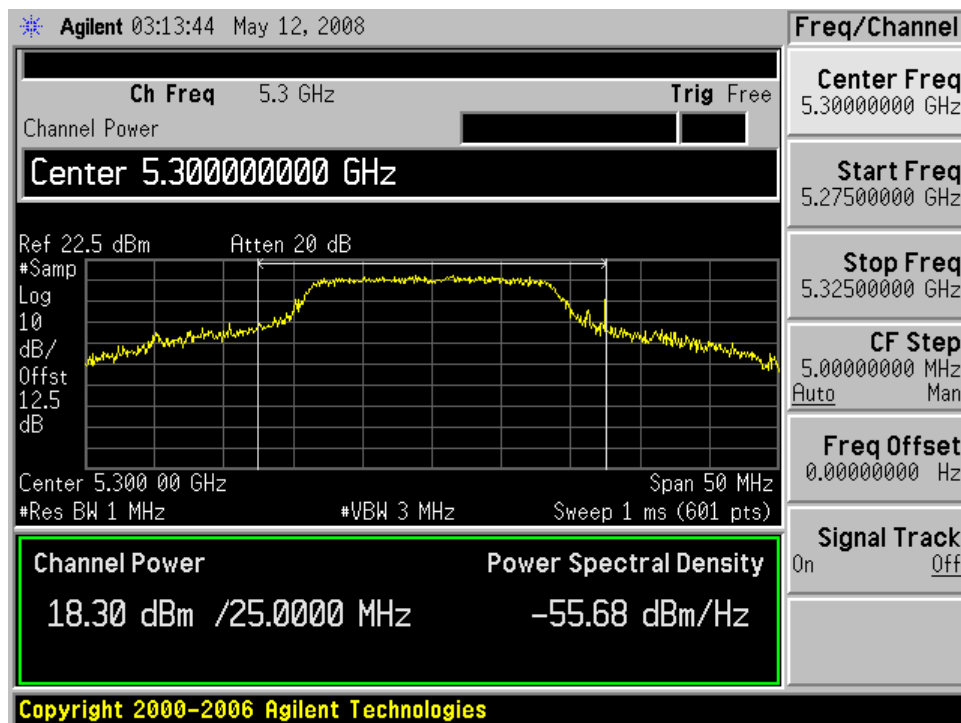

High Channel

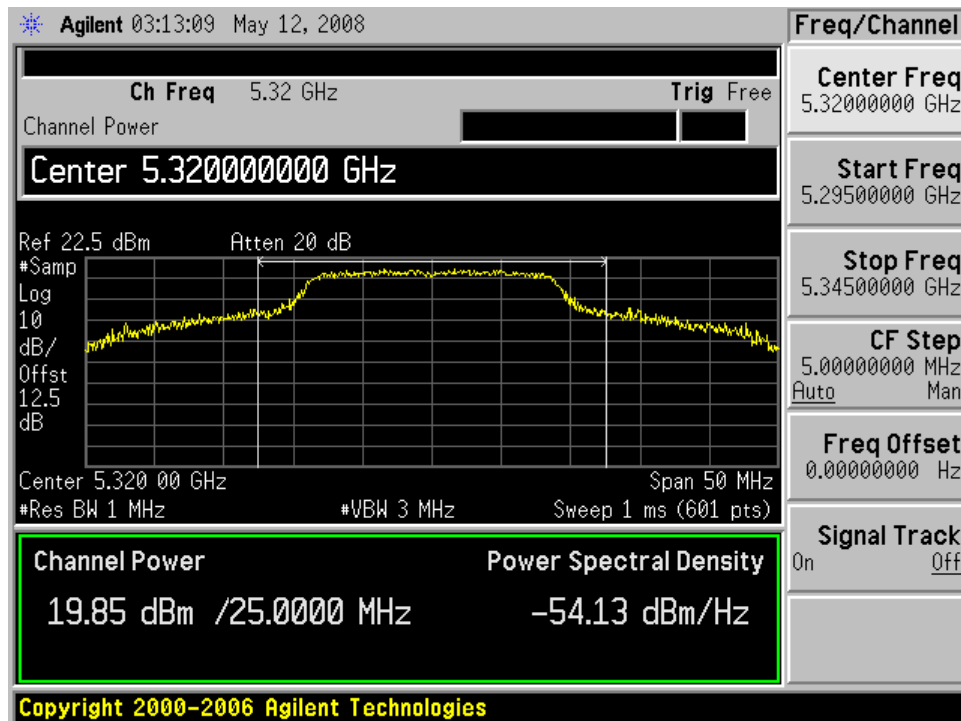

802.11n 40MHz, Chain j4

Low Channel

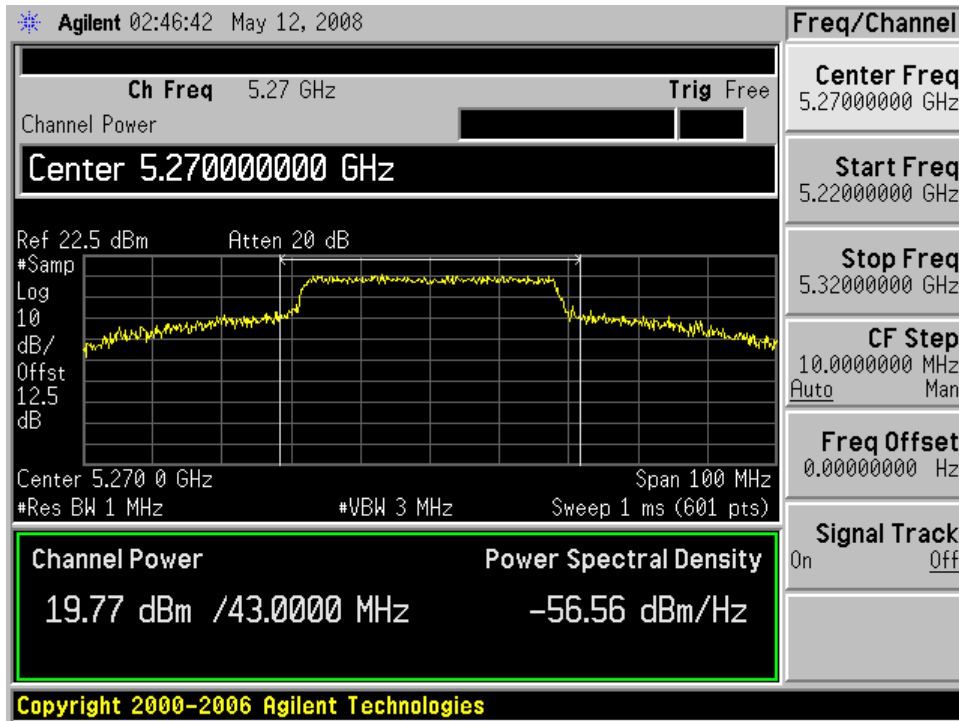

High Channel

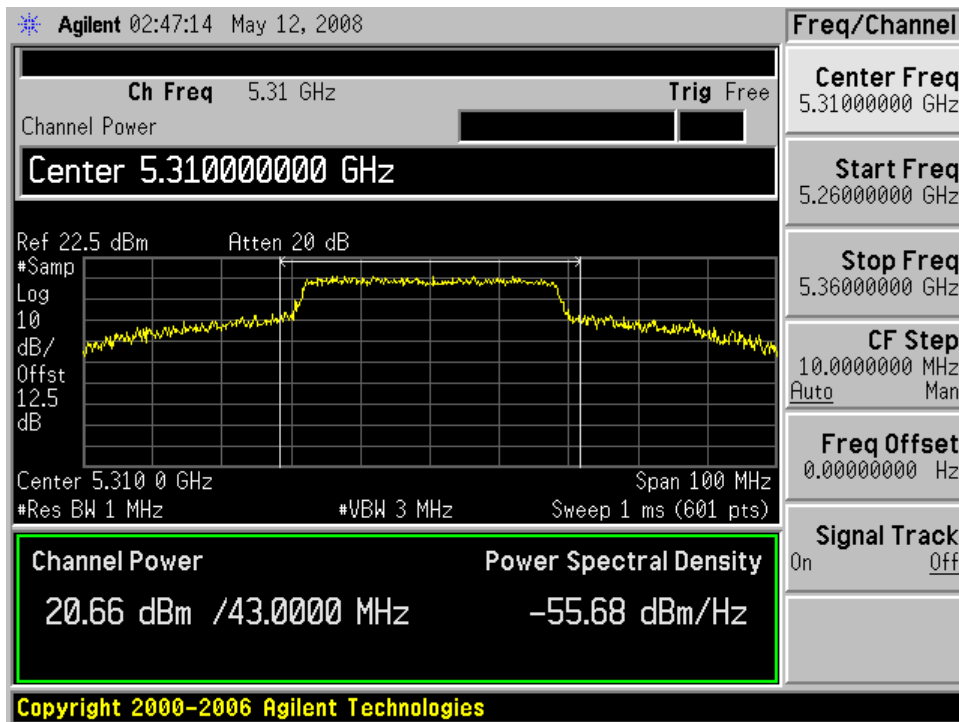

802.11n 40MHz, Chain j5

Low Channel

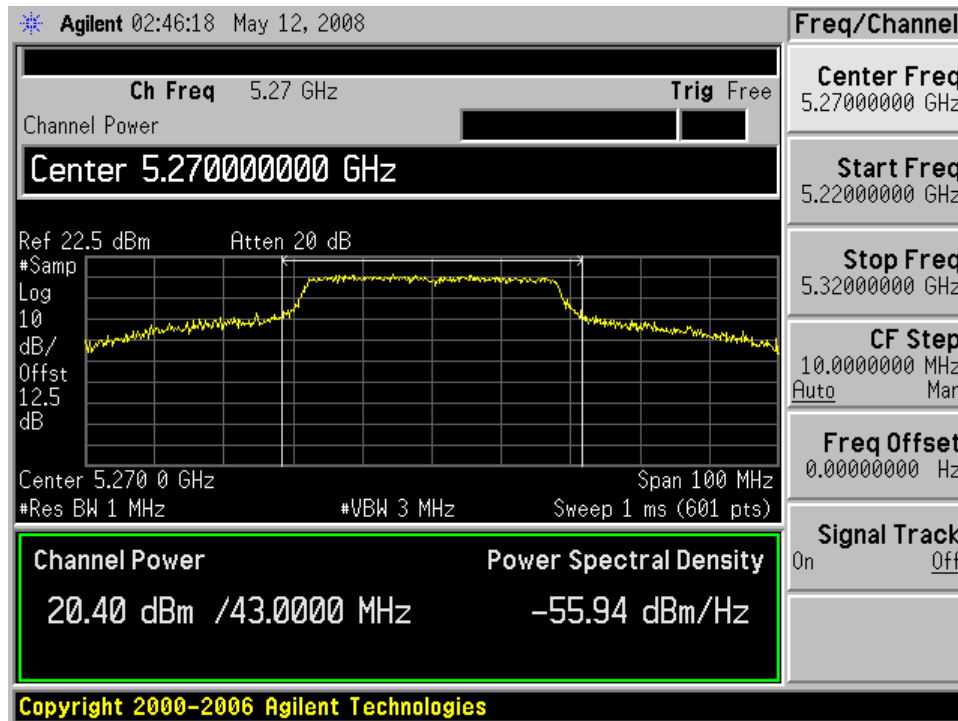

High Channel

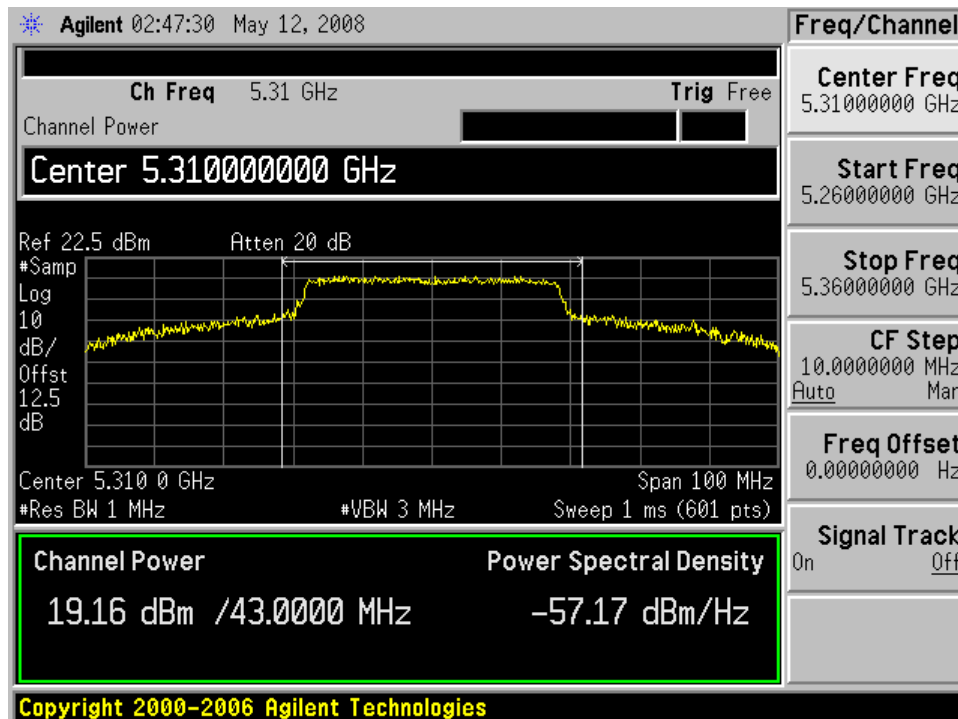

802.11a 20MHz, Chain j4

Low Channel

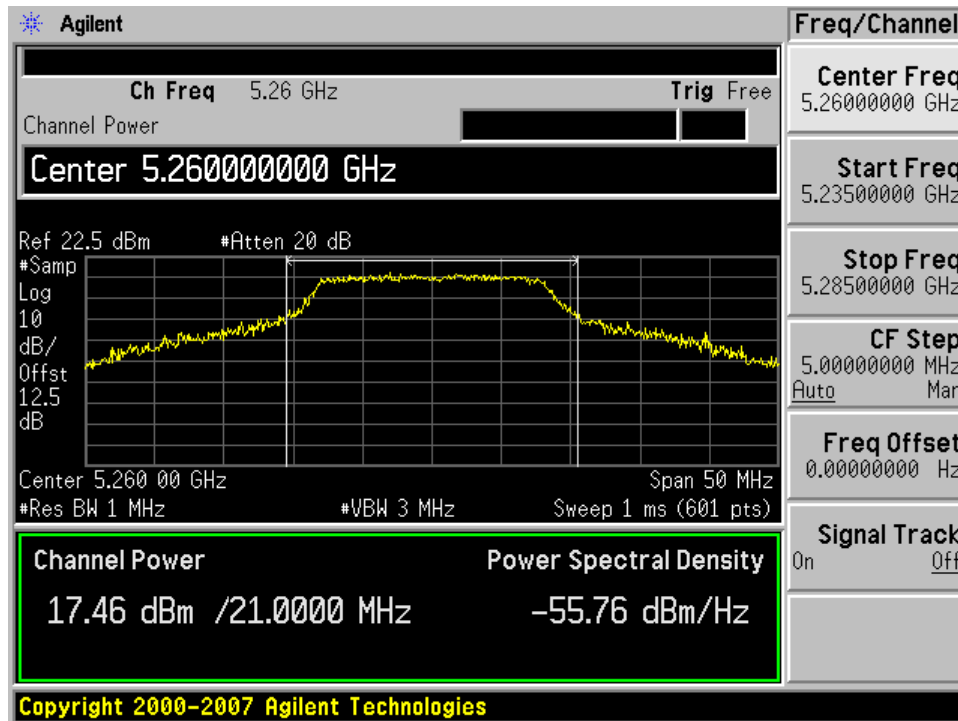

Middle Channel

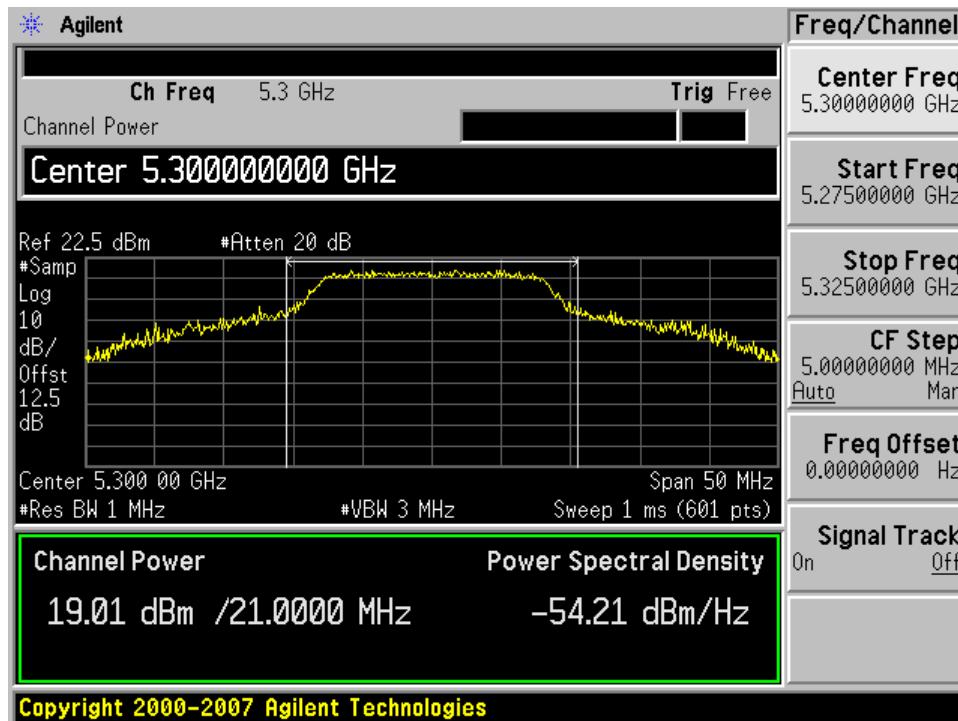

High Channel

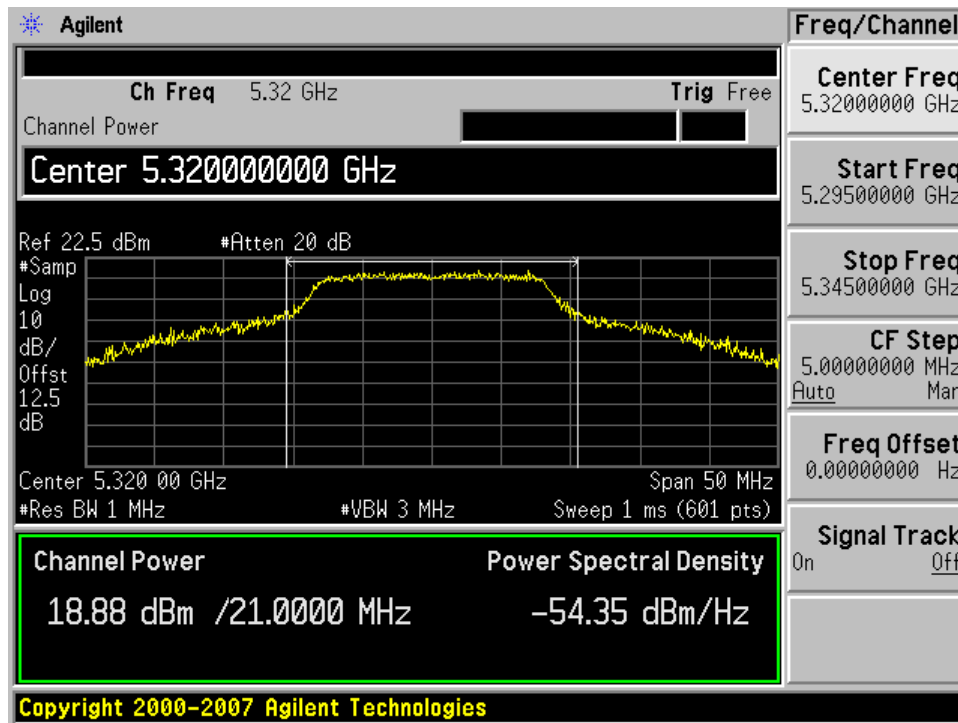

802.11a 20MHz, Chain j5

Low Channel

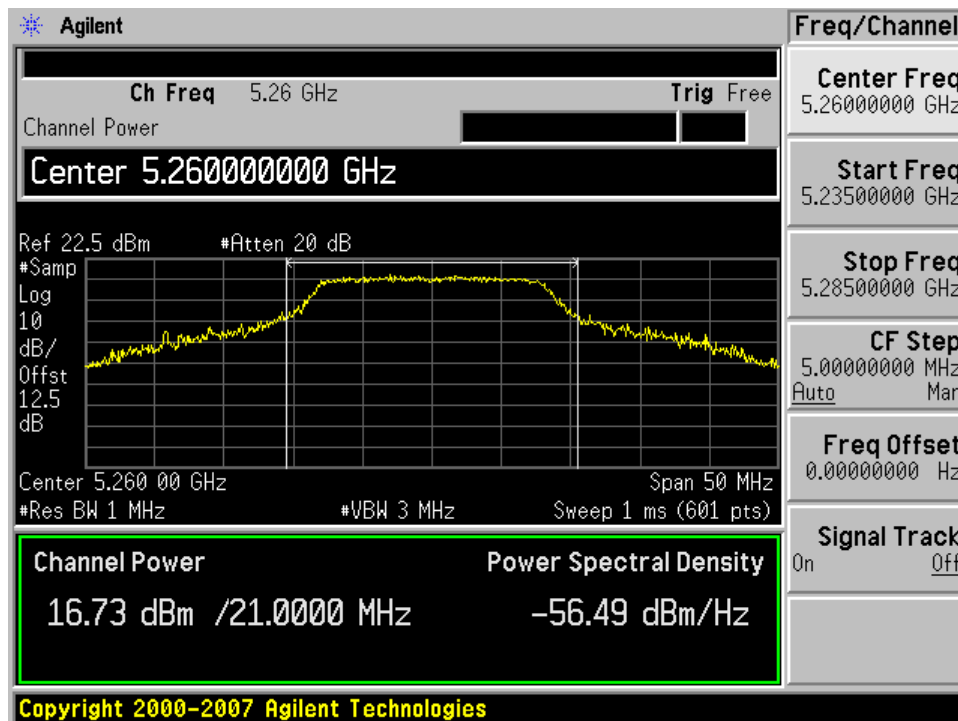

Middle Channel

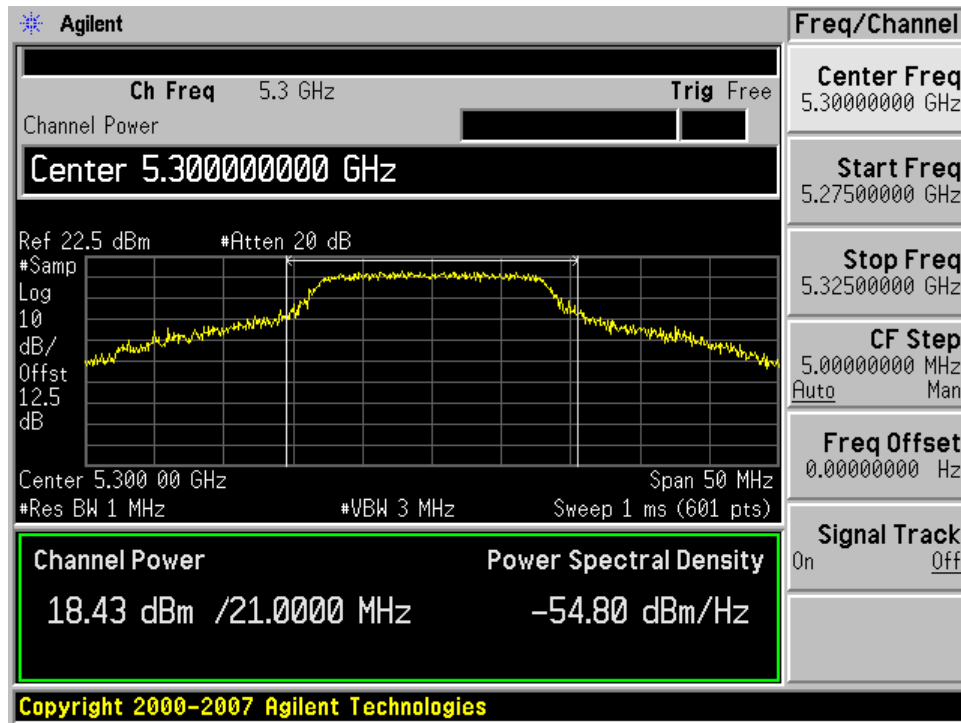

High Channel

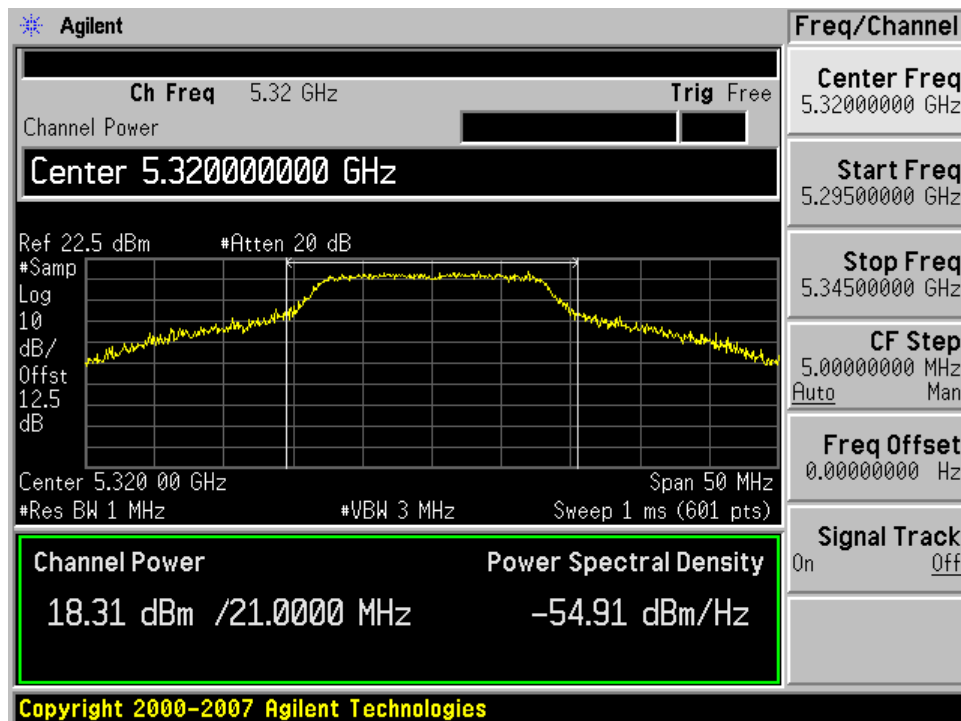

10.6.5 5470-5725 MHz Band (W56)

802.11n 20MHz, Chain j4

Low Channel

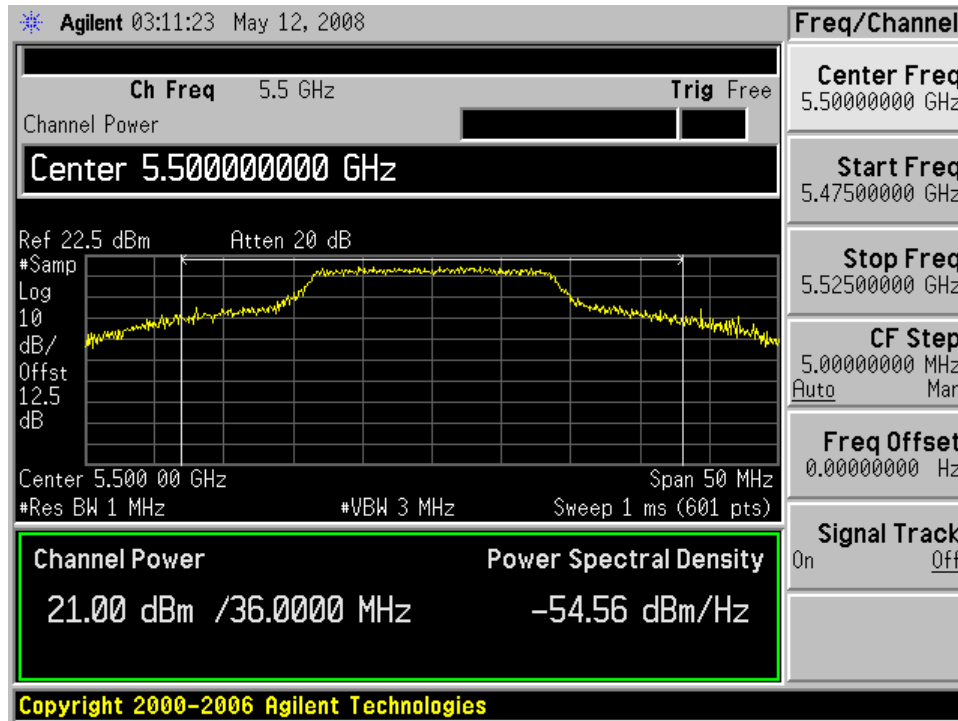

Middle Channel

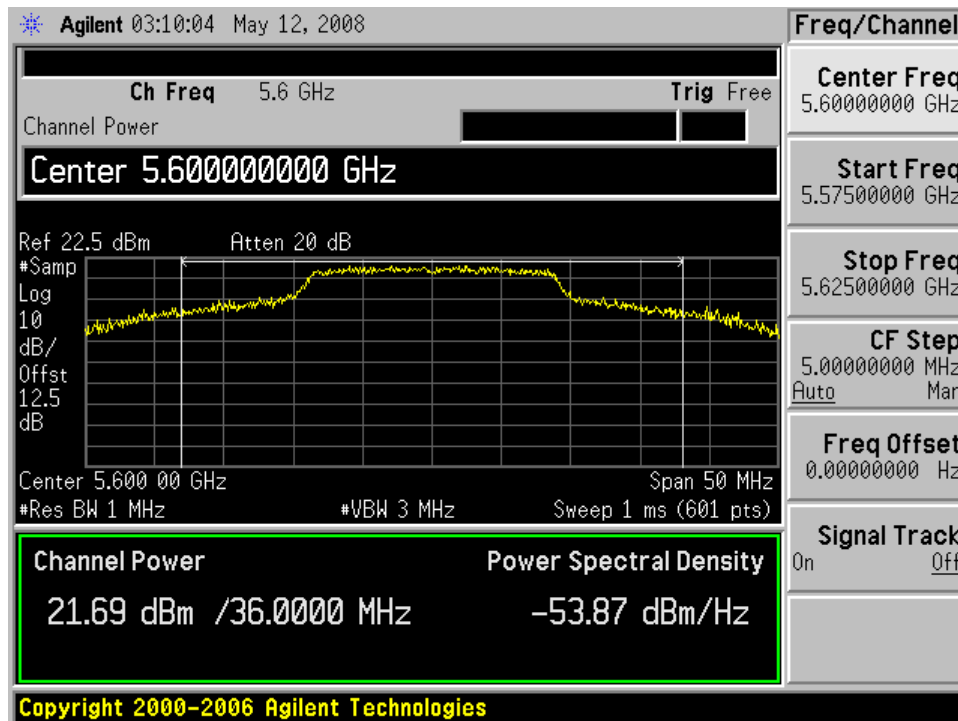

High Channel

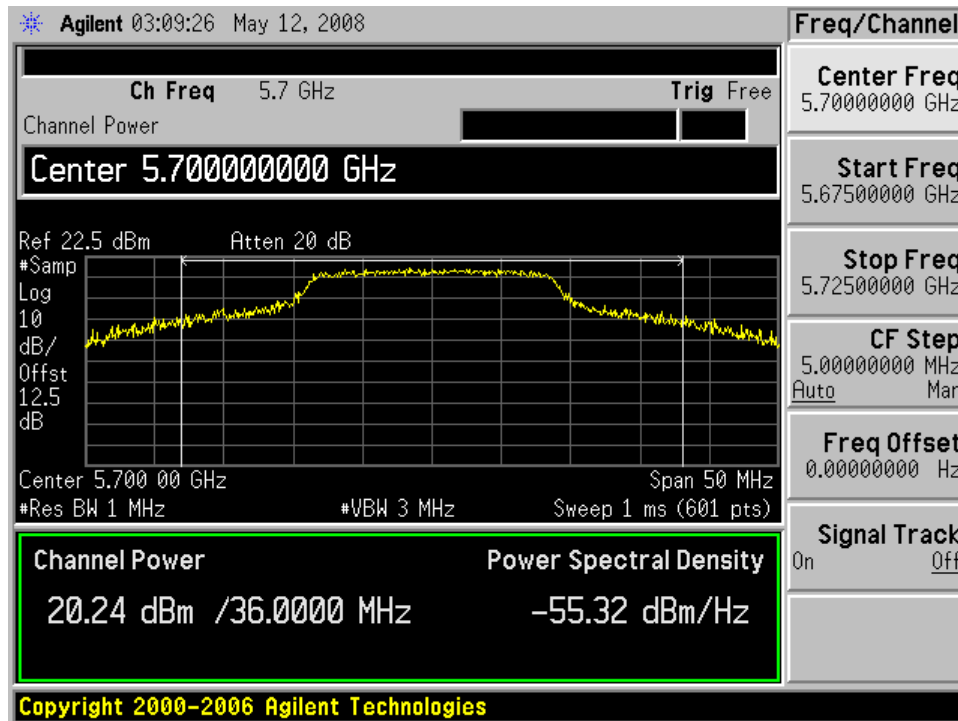

802.11n 20MHz, Chain j5

Low Channel

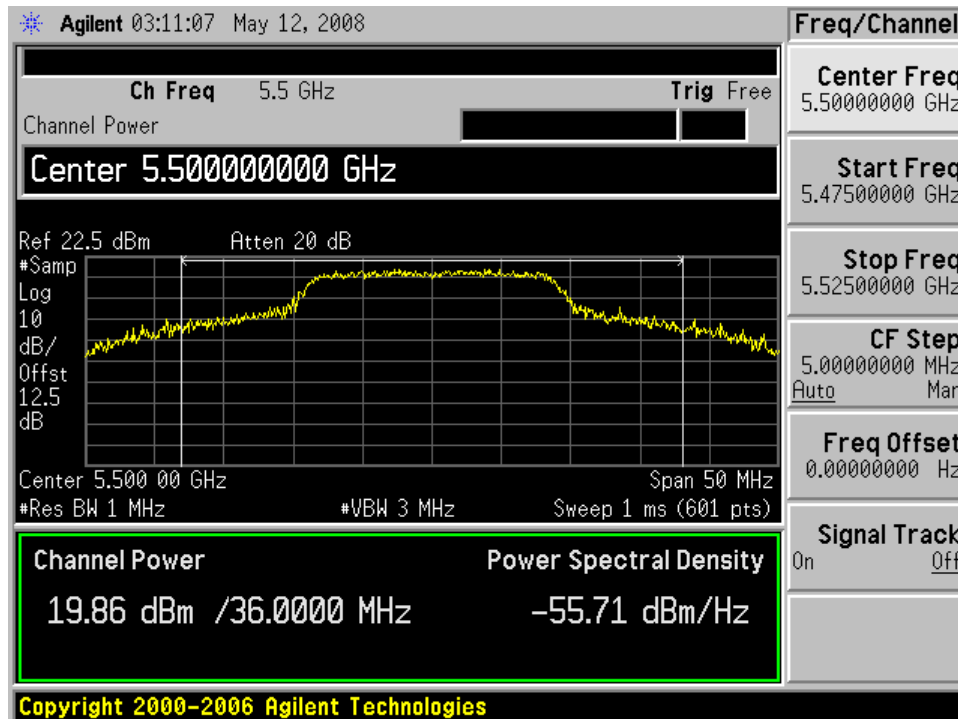

Middle Channel

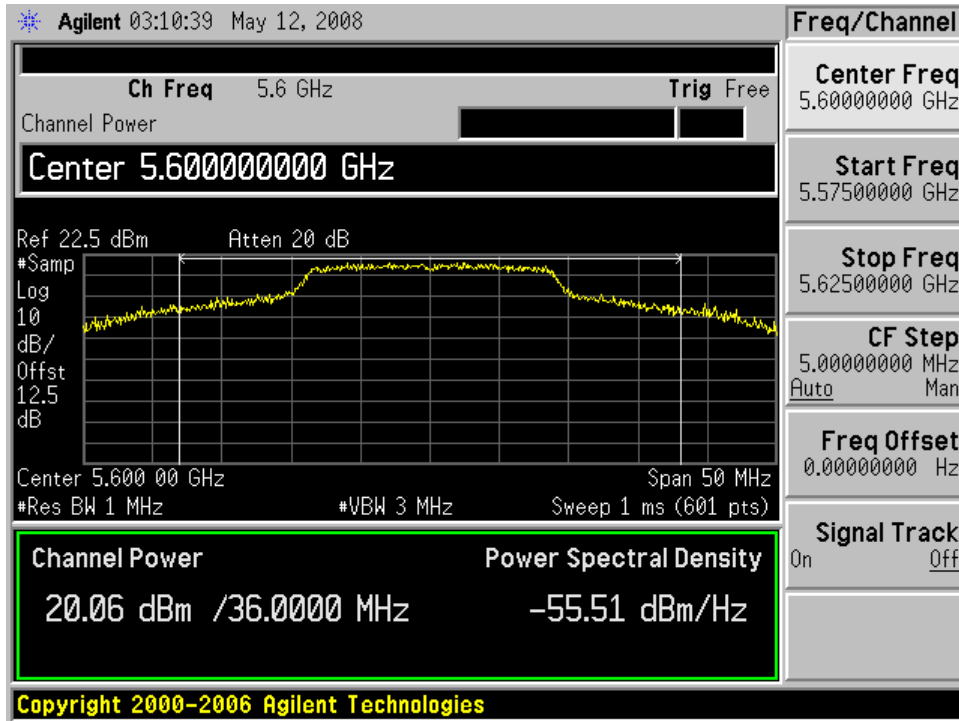

High Channel

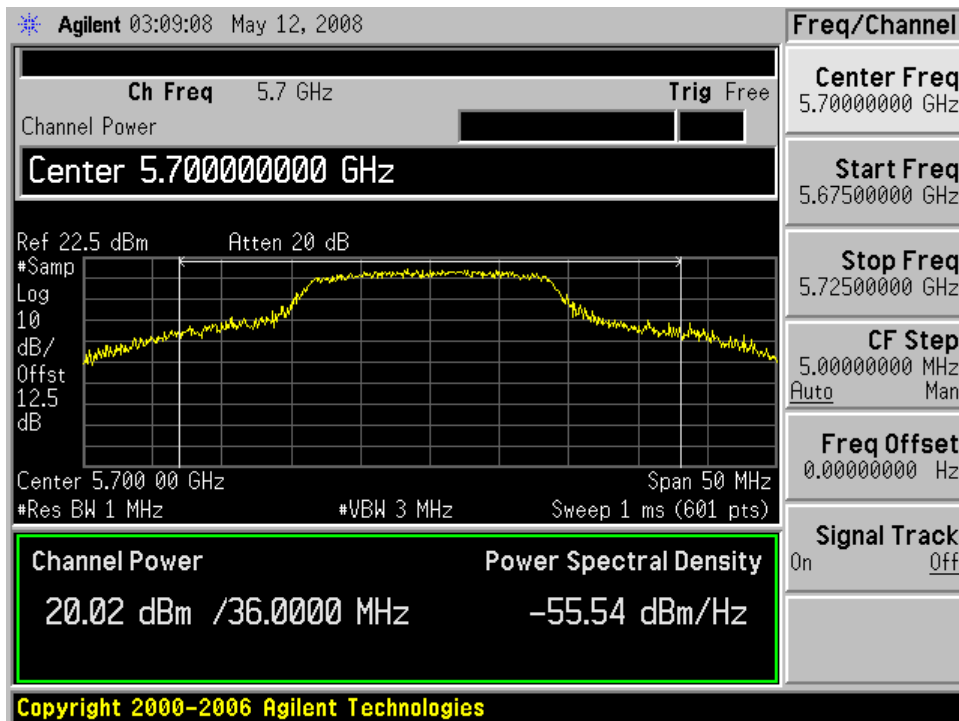

802.11n 40MHz, Chain j4

Low Channel

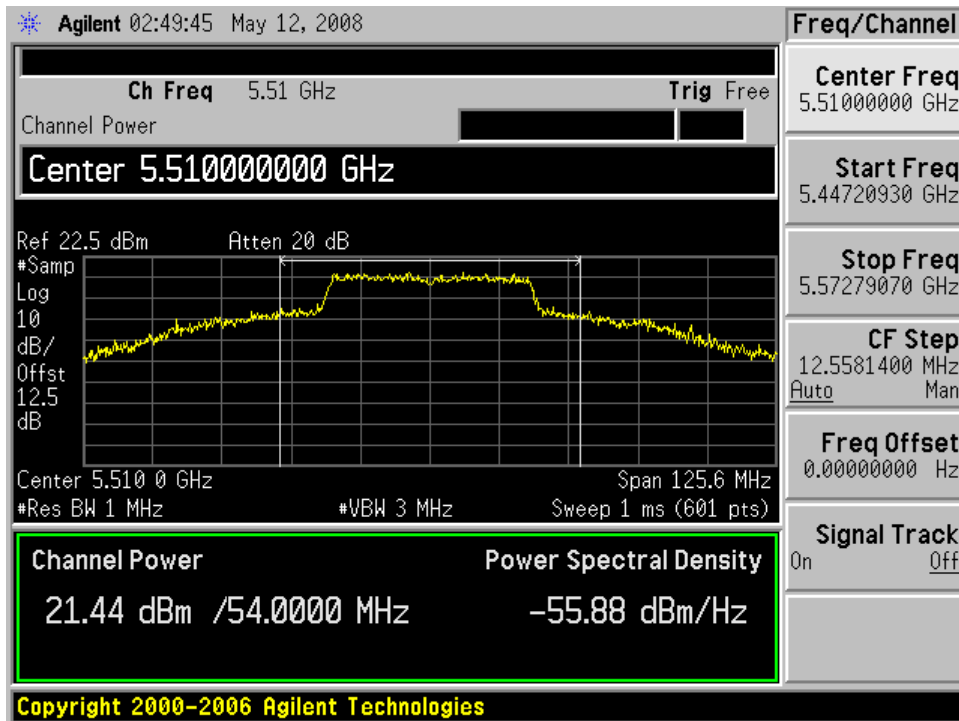

Middle Channel

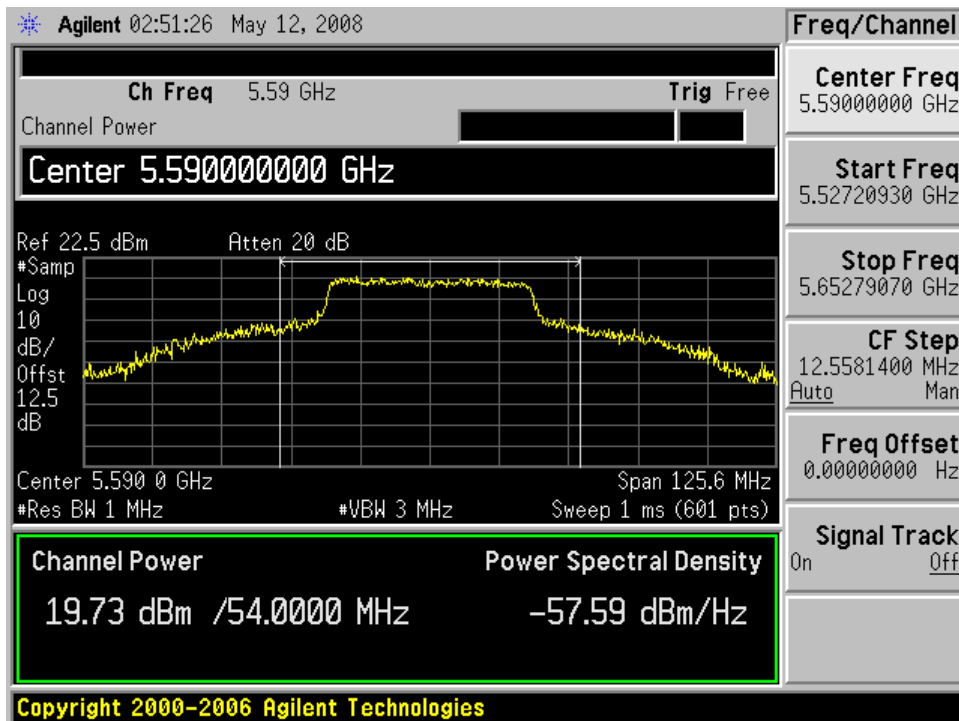

High Channel

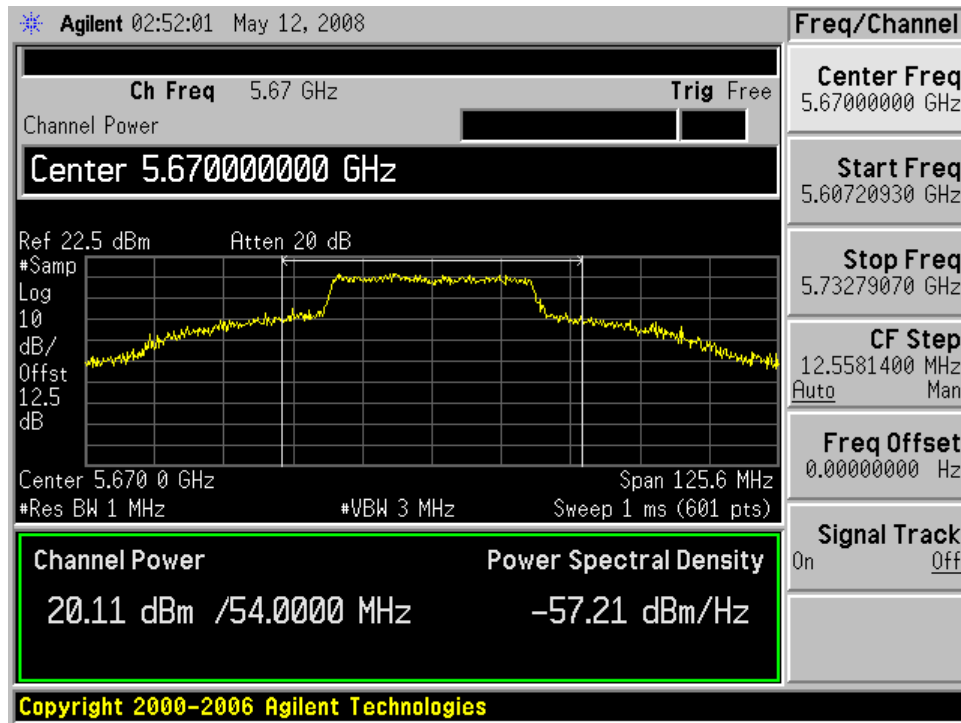

802.11n 40MHz, Chain j5

Low Channel

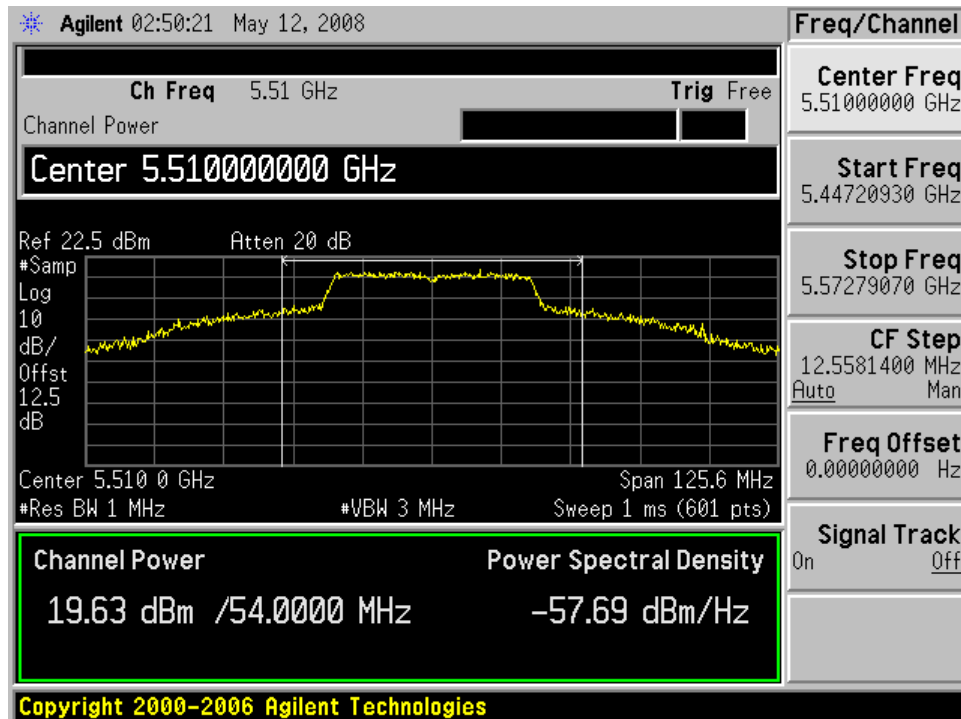

Middle Channel

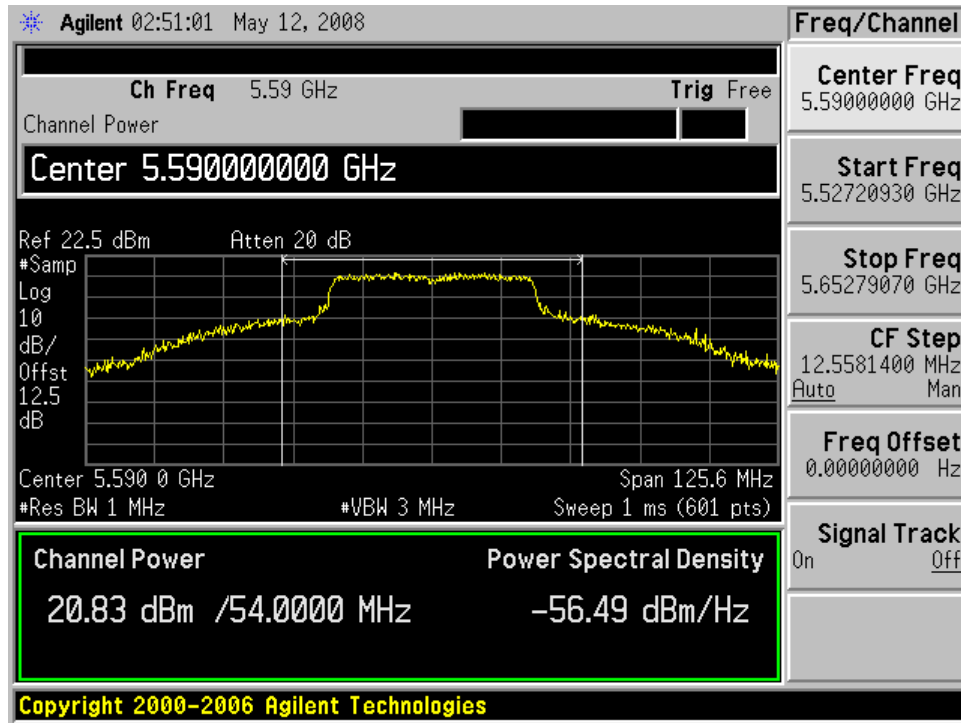

High Channel

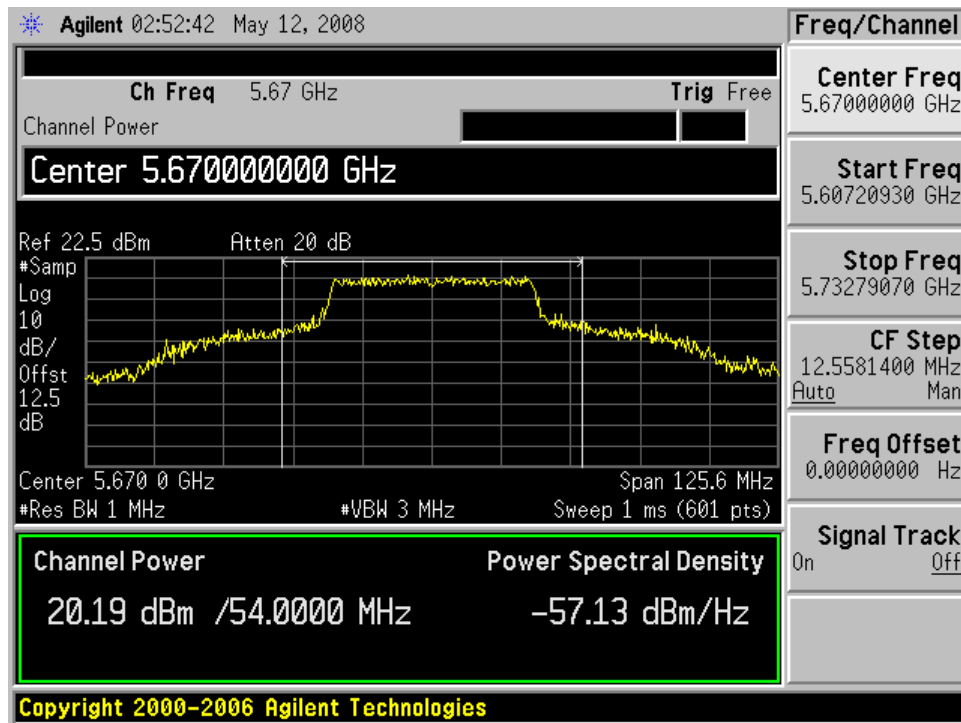

802.11a 20MHz, Chain j4

Low Channel

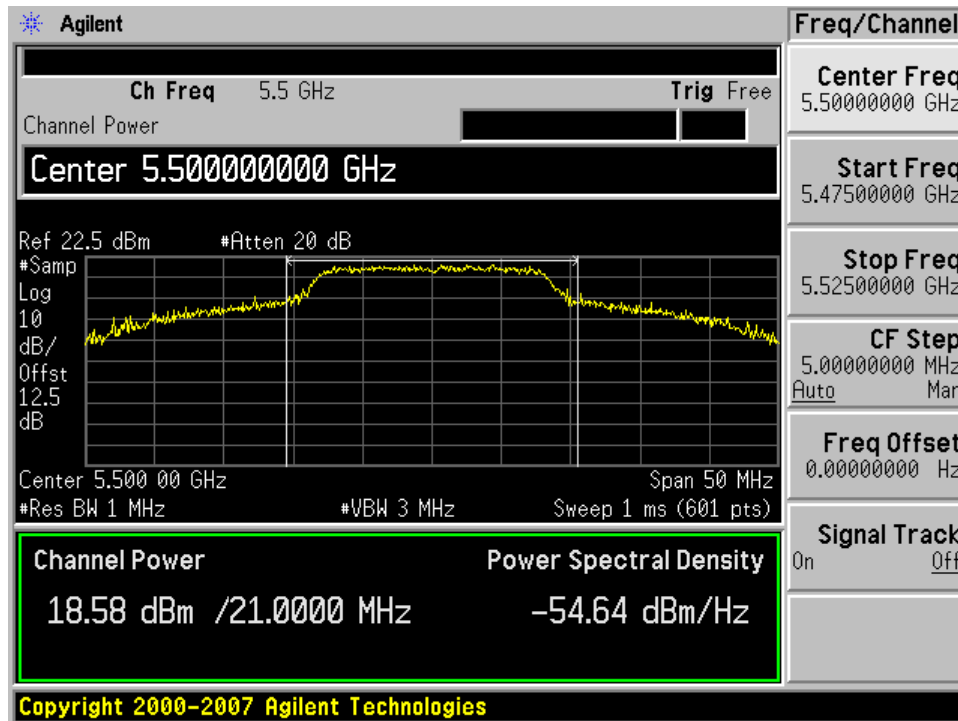

Middle Channel

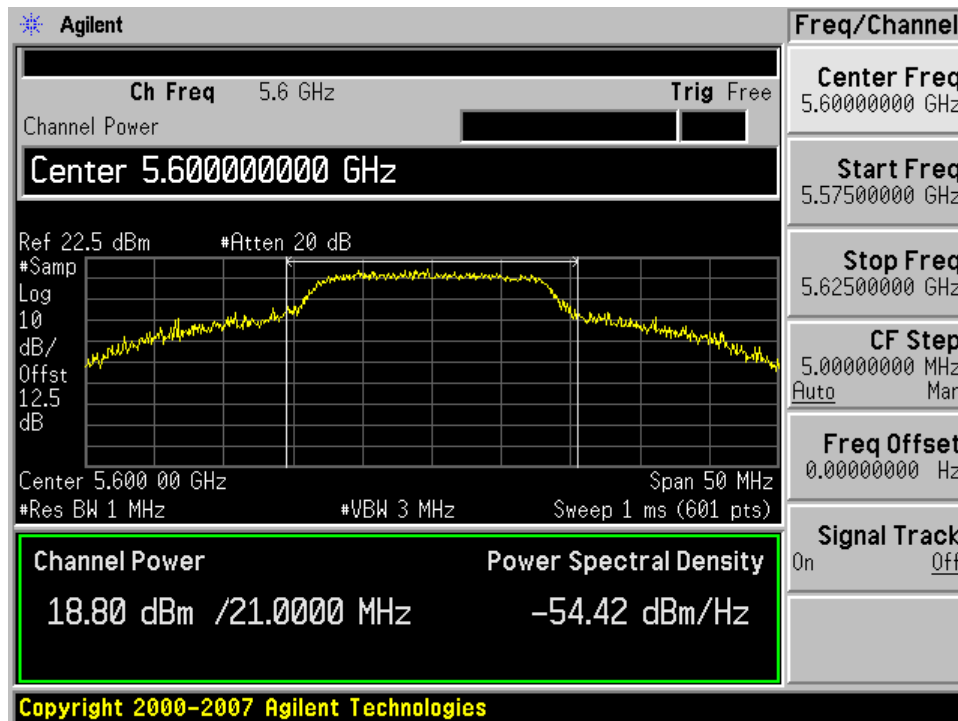

High Channel

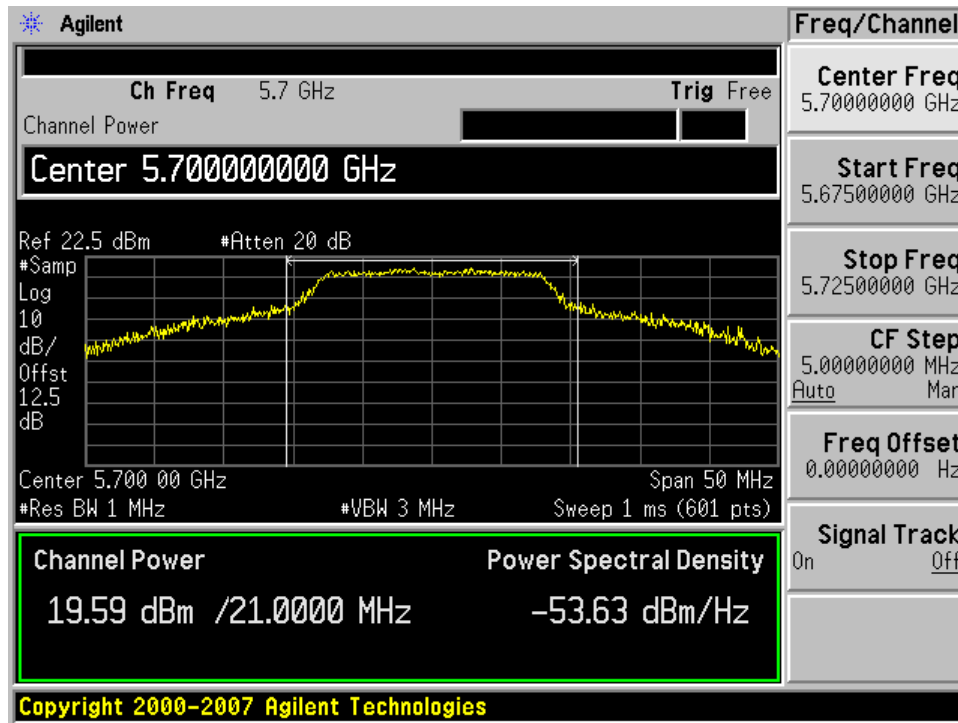

802.11a 20MHz, Chain j5

Low Channel

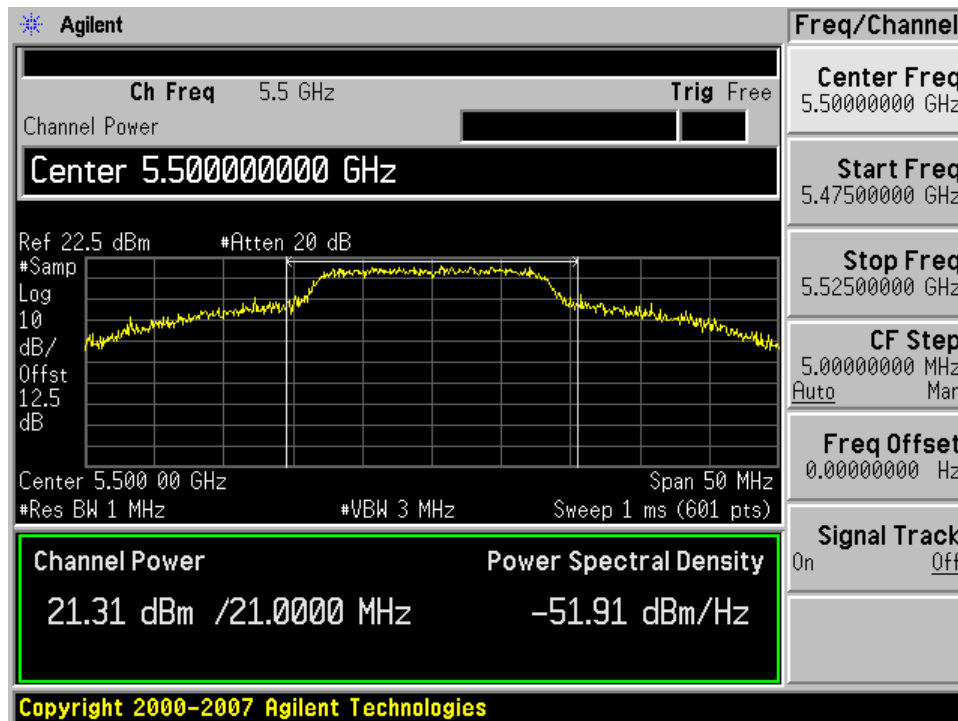

Middle Channel

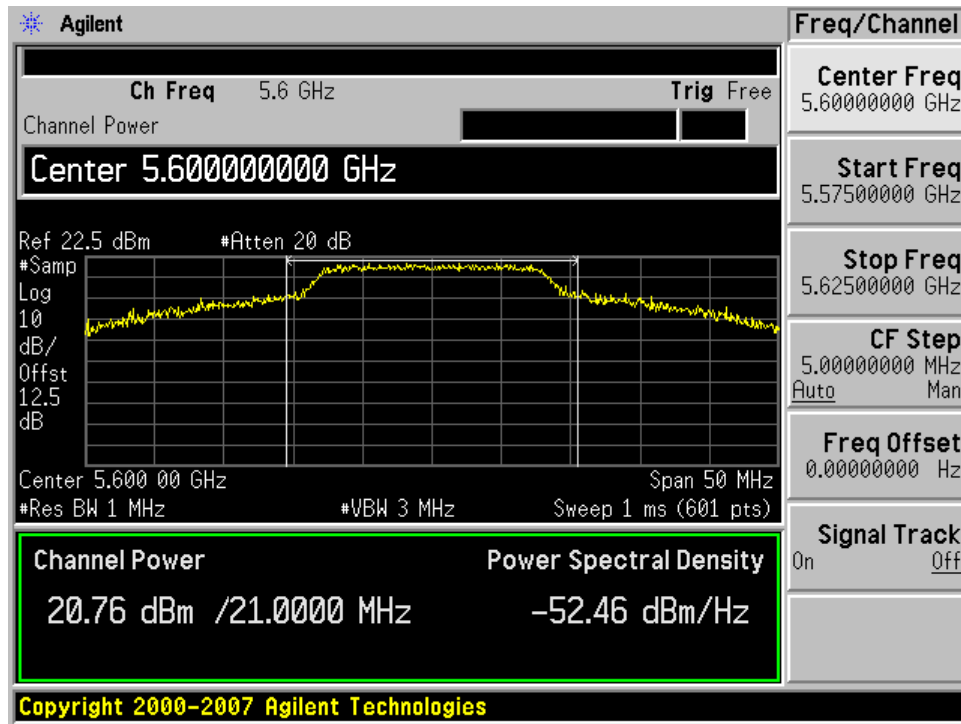

High Channel

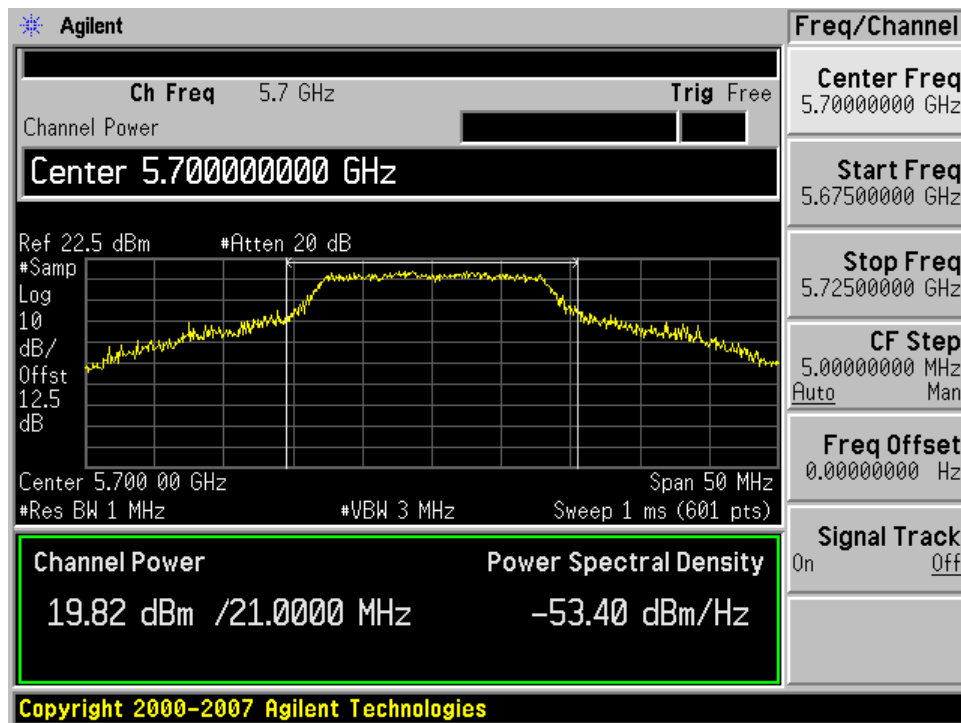

11 FCC 407 (a) & RSS 210 A9.2 - PEAK POWER SPECTRAL DENSITY

11.1 Applicable Standard

§15.407 (a)(1) For the band 5.15 – 5.25 GHz, the peak power spectral density shall not exceed 4 dBm in any 1-MHz band. If transmitting antennas of directional gain greater than 6 dBi are used, the conducted output power and the peak power spectral density shall be reduced by the amount in dB that the directional gain of the antenna exceeds 6 dBi.

§15.407 (a)(2) For the band 5.25 – 5.35 GHz, the peak power spectral density shall not exceed 11 dBm in any 1-MHz band. If transmitting antennas of directional gain greater than 6 dBi are used, the conducted output power and the peak power spectral density shall be reduced by the amount in dB that the directional gain of the antenna exceeds 6 dBi.

RSS-210 §A9.2

(1) For the band 5150-5250 MHz, the maximum equivalent isotropically radiated power (e.i.r.p.) shall not exceed 200 mW or $10 + 10 \log_{10} B$, dBm, whichever power is less. B is the 99% emission bandwidth in MHz. The e.i.r.p. spectral density shall not exceed 10 dBm in any 1.0 MHz band.

(2) For the bands 5250-5350 MHz and 5470-5725 MHz, the maximum conducted output power shall not exceed 250 mW or $11 + 10 \log_{10} B$, dBm, whichever power is less. The power spectral density shall not exceed 11 dBm in any 1.0 MHz band. The maximum e.i.r.p. shall not exceed 1.0 W or $17 + 10 \log_{10} B$, dBm, whichever power is less. B is the 99% emission bandwidth in MHz.

11.2 Measurement Procedure

1. Using sample detector and power averaging mode, set RBW=1 MHz and VBW > 1 MHz.
2. PSD is the highest level found across the emission in any 1-MHz band after 100 sweeps of averaging.
3. When the emission bandwidth is less than 1 MHz, a measurement bandwidth equal to the emission bandwidth is used in accordance with section 15.407(a)(5).

Each chain is measured separately and the total PPSD is calculated using the following formula:

$$\text{Total PPSD} = 10 \log (10^{(\text{Chain A PPSD} / 10)} + 10^{(\text{Chain B PPSD} / 10)})$$

11.3 Equipment Lists

Manufacturer	Description	Model	Serial Number	Cal. Date
Agilent	Spectrum analyzer	E4440A	MY44303352	2008-04-28

* **Statement of Traceability:** **BACL Corp.** attests that all calibrations have been performed per the NVLAP requirements, traceable to the NIST.

11.4 Test Setup Diagram

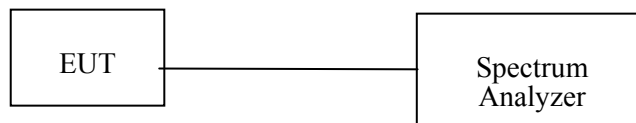

11.5 Environmental Conditions

Temperature:	20° C
Relative Humidity:	40%
ATM Pressure:	1019 mbar

**The testing was performed by Xiao Ming Hu from 2008-06-02.*

11.6 Test Result

11.6.1 5250-5350 MHz Band (W53)

802.11n 20MHz

Frequency (MHz)/BW	PSD with Combiner (dBm)	Limit (dBm)	Margin (dB)
5260/20	9.733	11	-1.267
5300/20	9.533	11	-1.467
5320/20	10.730	11	-0.270

802.11n 40MHz

Frequency (MHz)/BW	PSD with Combiner (dBm)	Limit (dBm)	Margin (dB)
5270/40	7.958	11	-3.042
5310/40	8.698	11	-2.302

802.11a: 20MHz rate/channel

Frequency (MHz)/BW	PSD with Combiner (dBm)	Limit (dBm)	Margin (dB)
5260/20	10.400	11	-0.600
5300/20	10.219	11	-0.781
5320/20	10.110	11	-0.890

11.6.2 5470-5725 MHz Band (W56)**802.11n 20MHz**

Frequency (MHz)/BW	PSD with Combiner (dBm)	Limit (dBm)	Margin (dB)
5500/20	7.114	11	-3.886
5600/20	7.741	11	-3.259
5700/20	9.860	11	-1.140

802.11n: 40MHz rate/channel

Frequency (MHz)/BW	PSD with Combiner (dBm)	Limit (dBm)	Margin (dB)
5510/40	8.884	11	-2.116
5590/40	10.194	11	-0.806
5670/40	8.965	11	-2.035

802.11a: 20MHz rate/channel

Frequency (MHz)/BW	PSD with Combiner (dBm)	Limit (dBm)	Margin (dB)
5500/20	8.163	11	-2.837
5600/20	8.792	11	-2.208
5700/20	9.974	11	-1.026

11.6.3 5250-5350 MHz Band (W53)

802.11n 20MHz

Low Channel

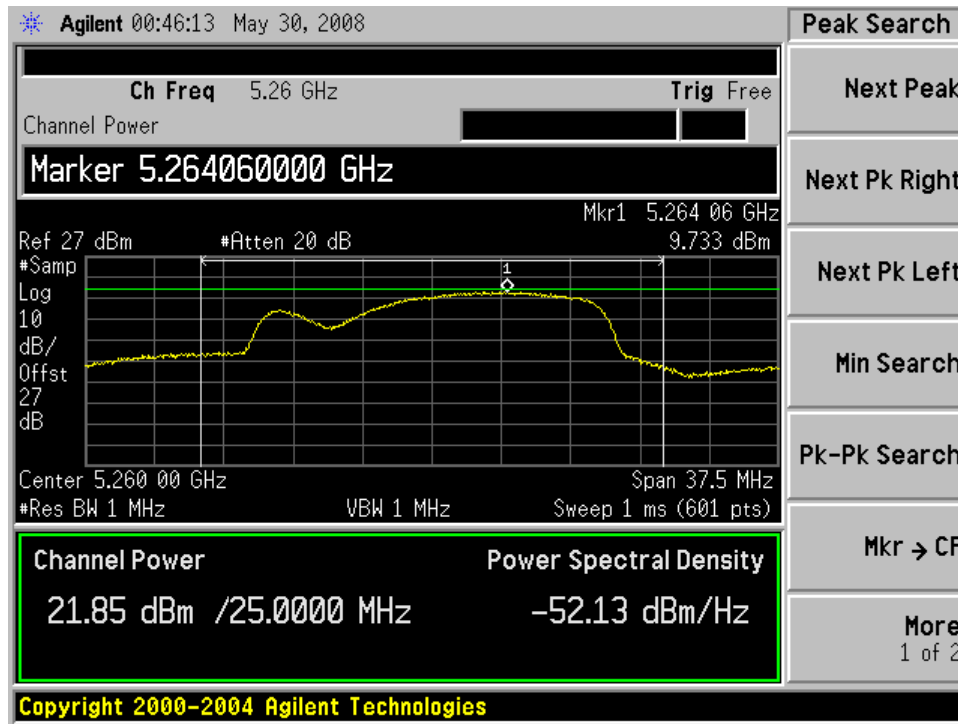

Middle Channel

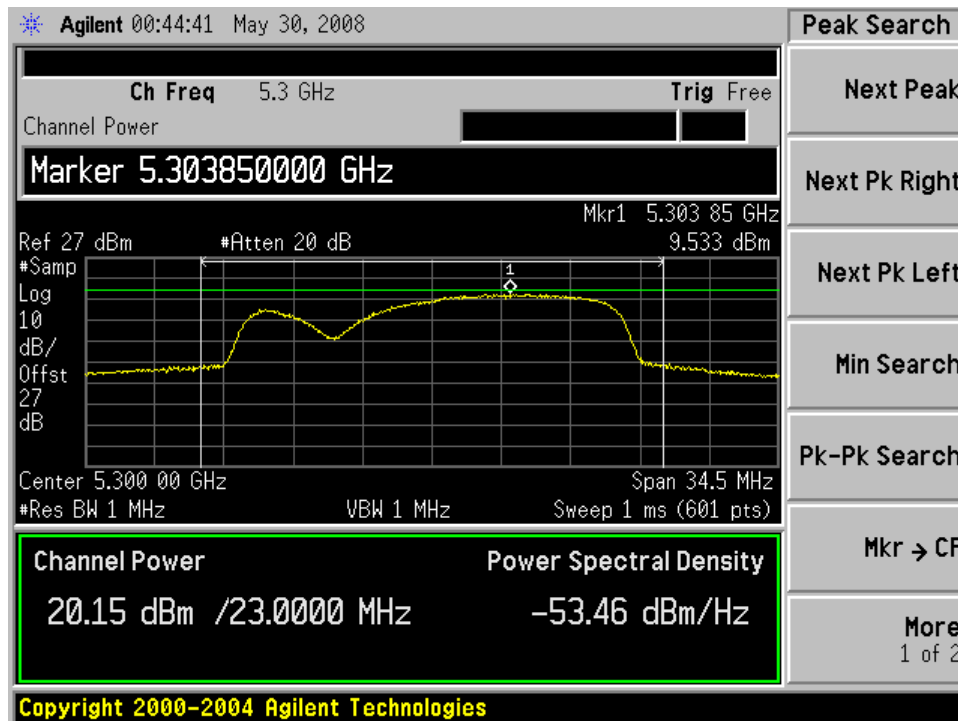

High Channel

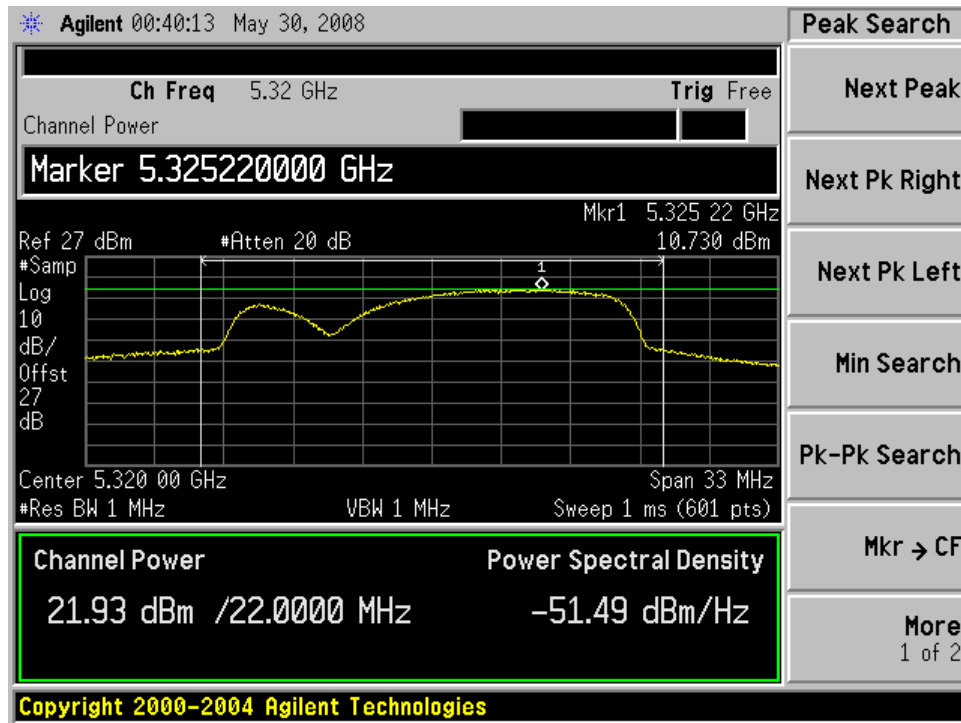

802.11a 20MHz

Low Channel

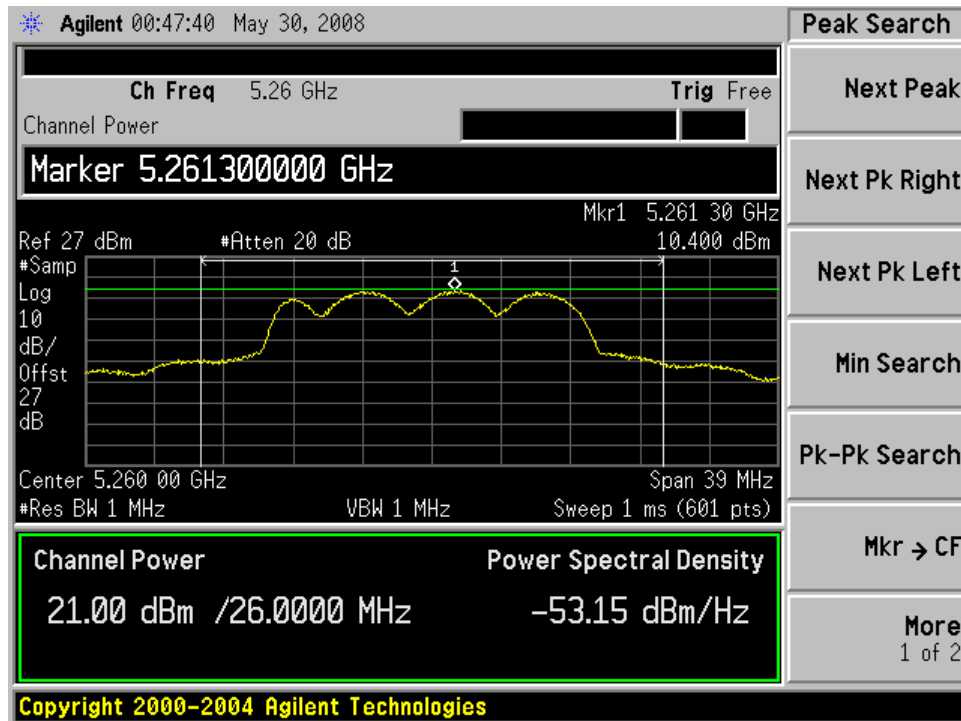

Middle Channel

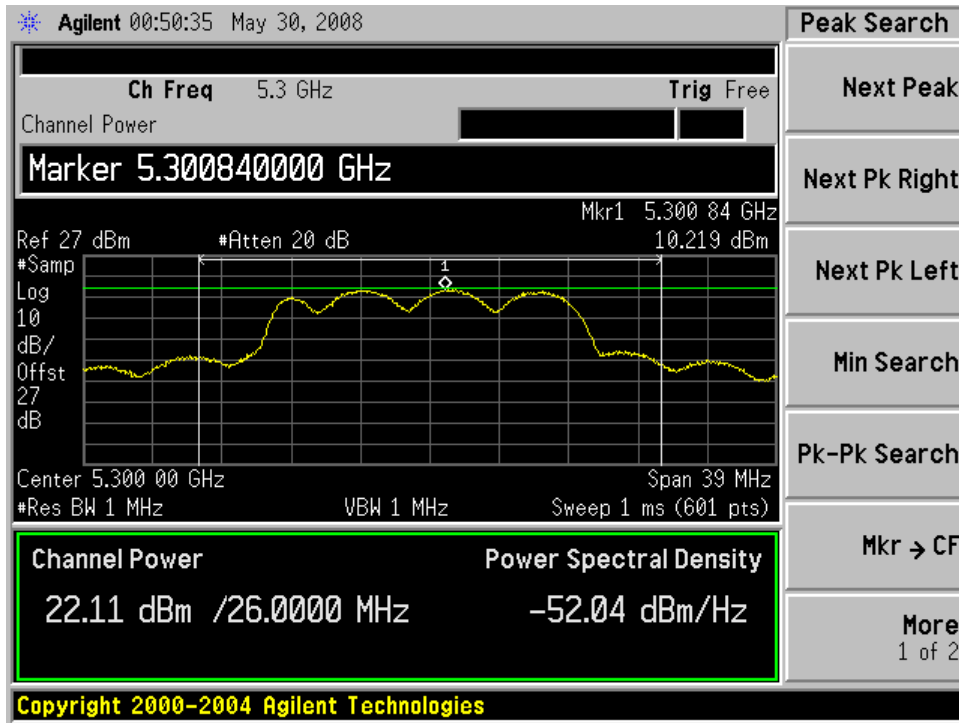

High Channel

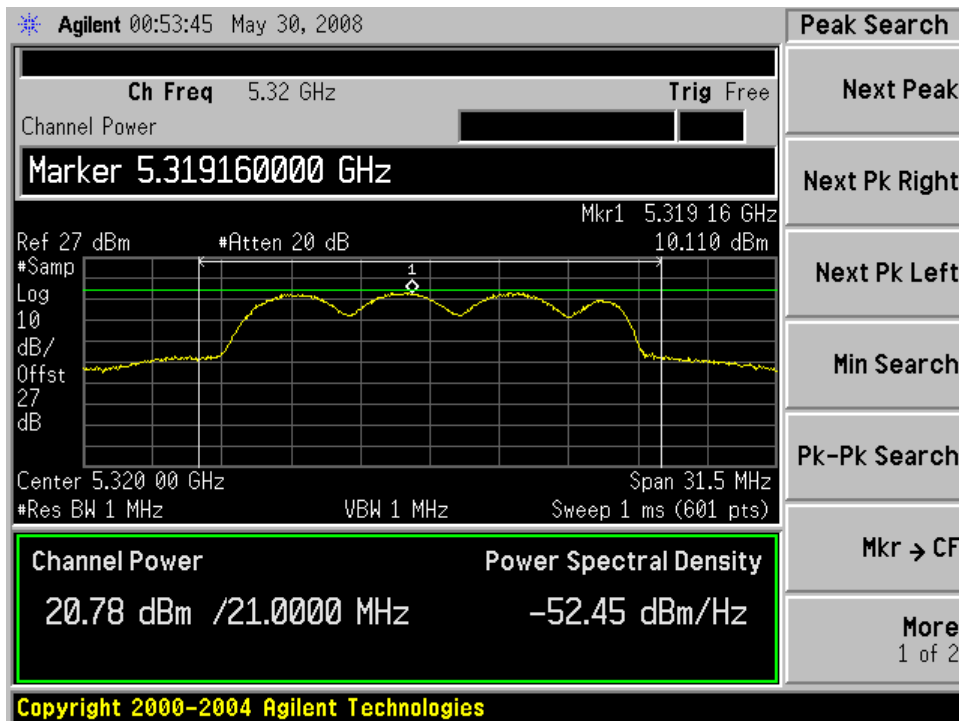

802.11n 40MHz

Low Channel

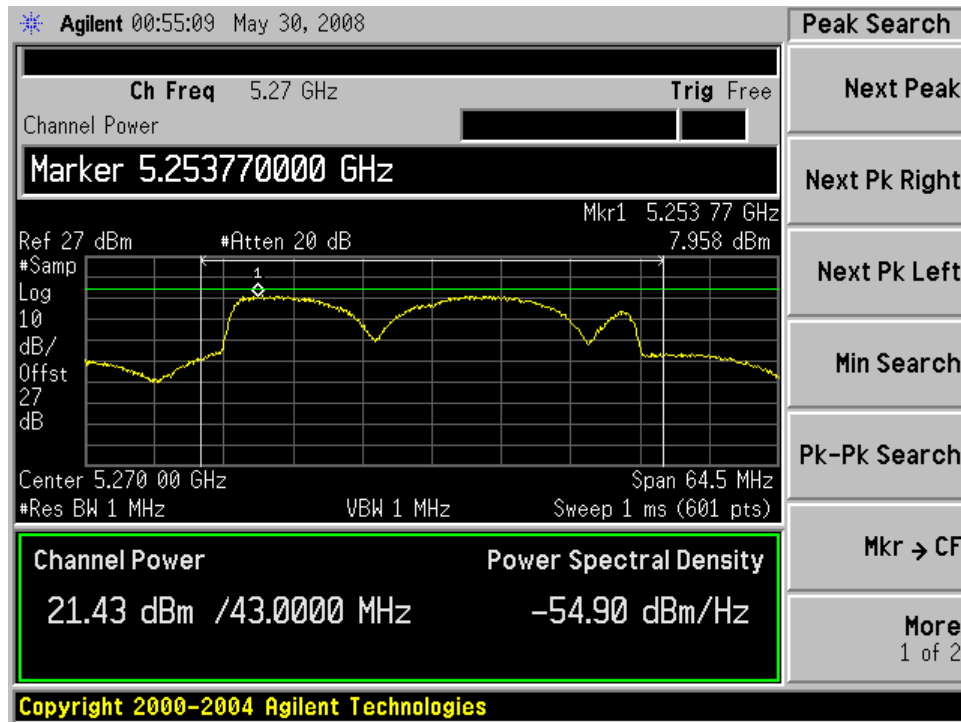

High Channel

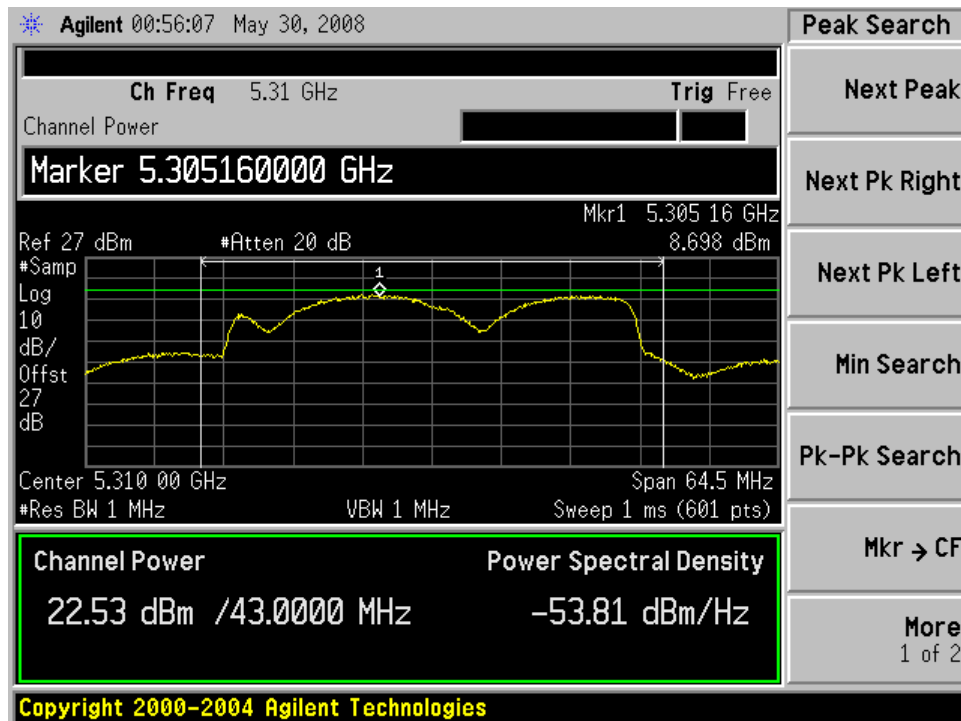

11.6.4 5470-5725 MHz Band (W56)

802.11n 20MHz

Low Channel

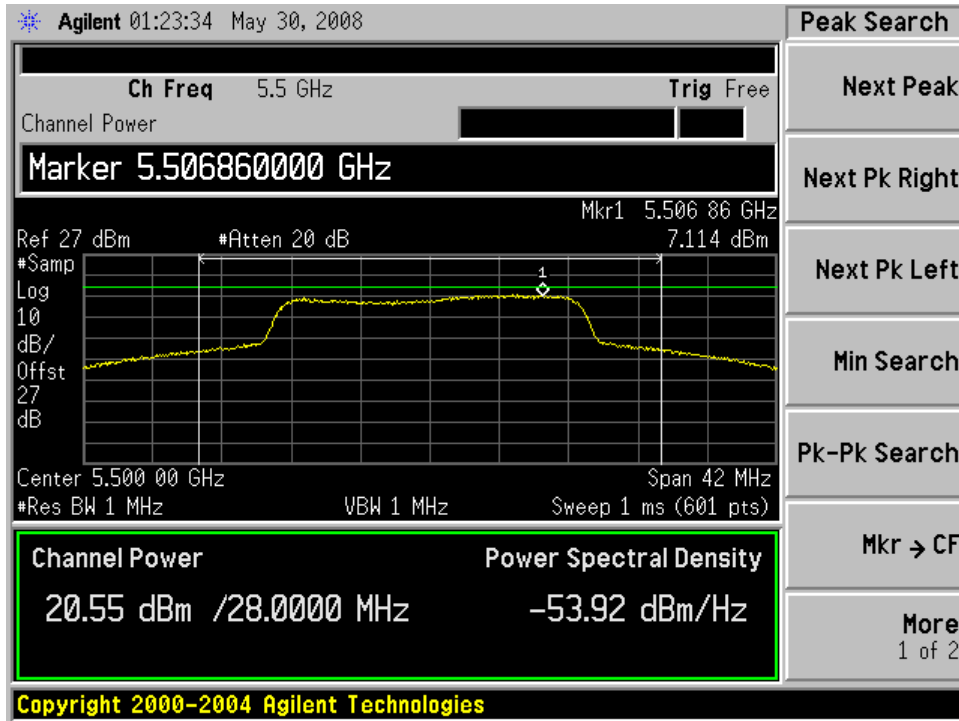

Middle Channel

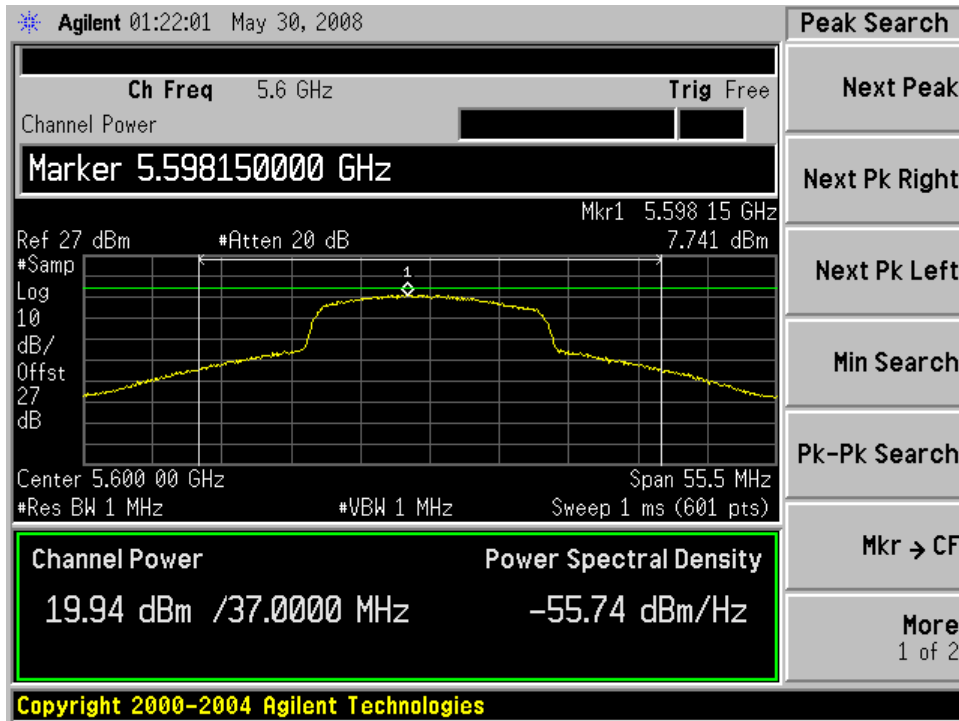

High Channel

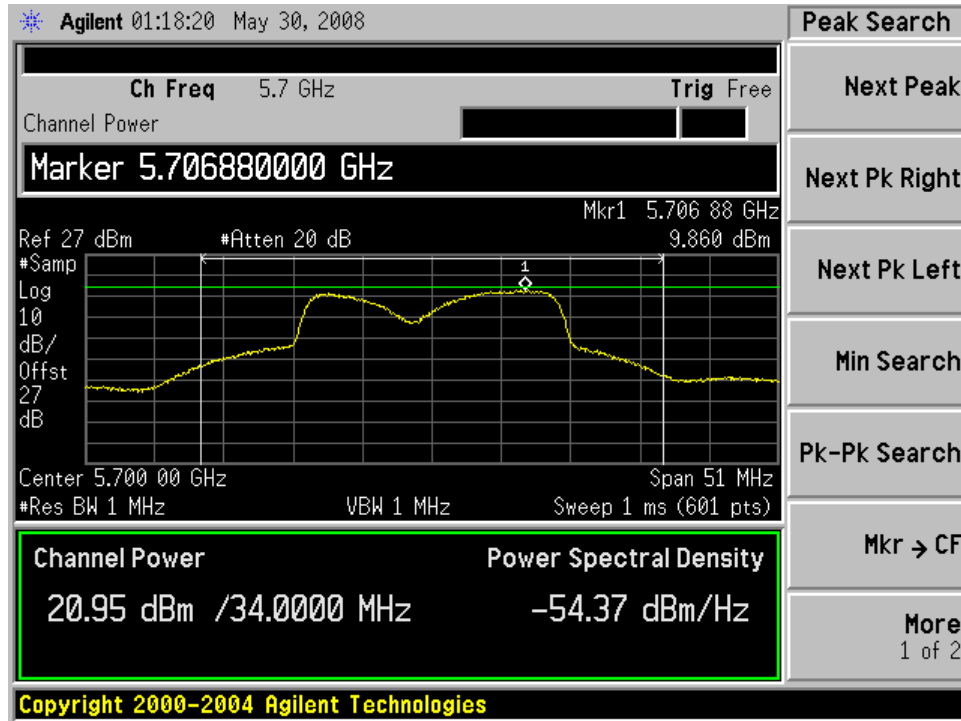

802.11a 20MHz

Low Channel

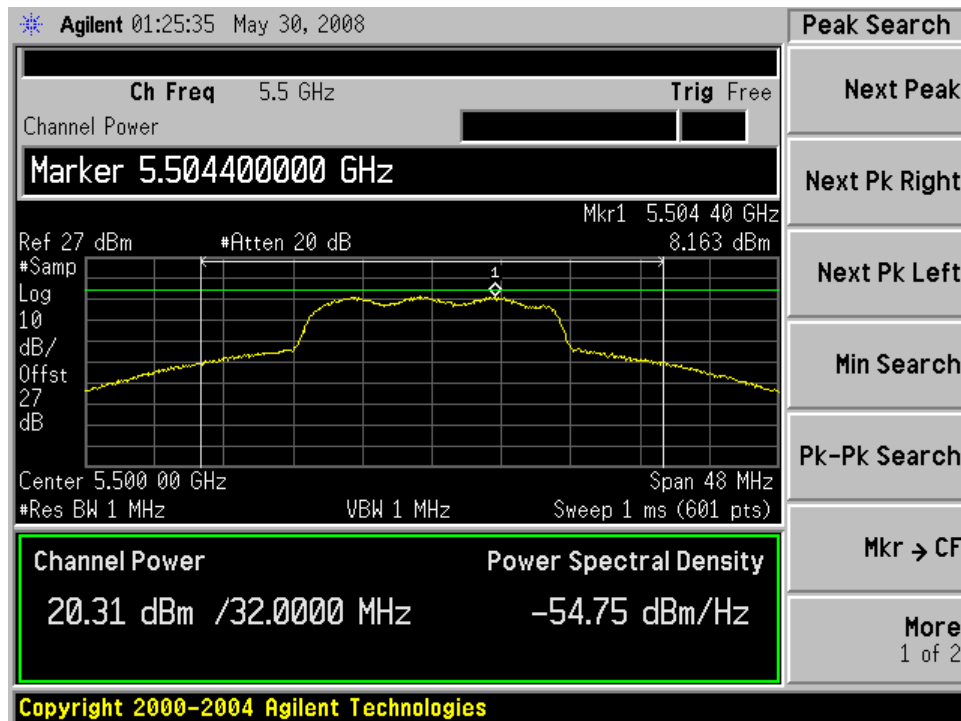

Middle Channel

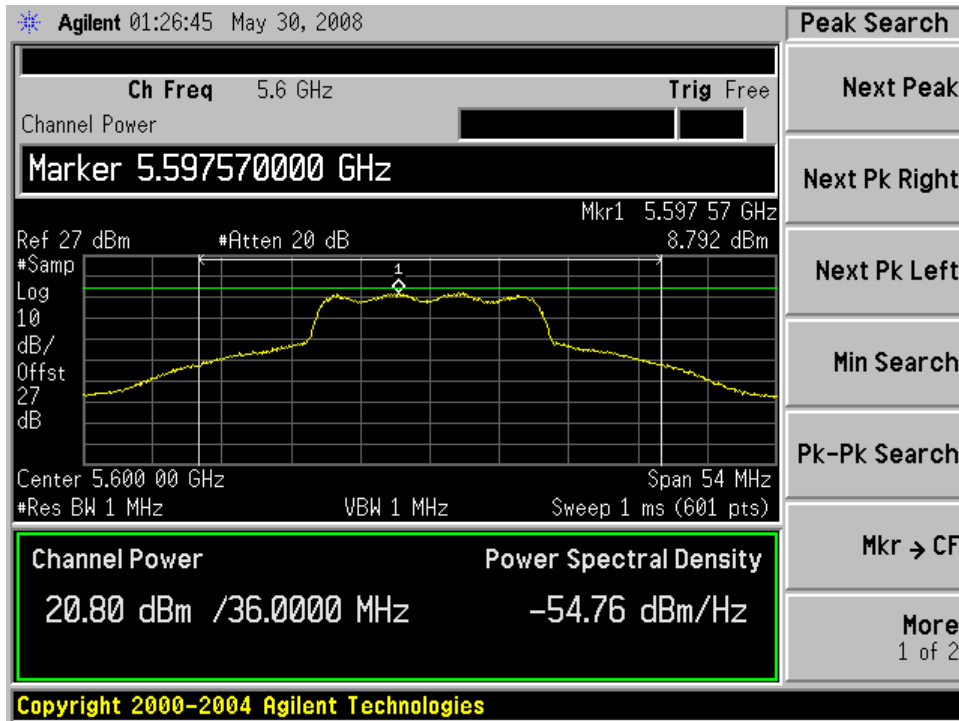

High Channel

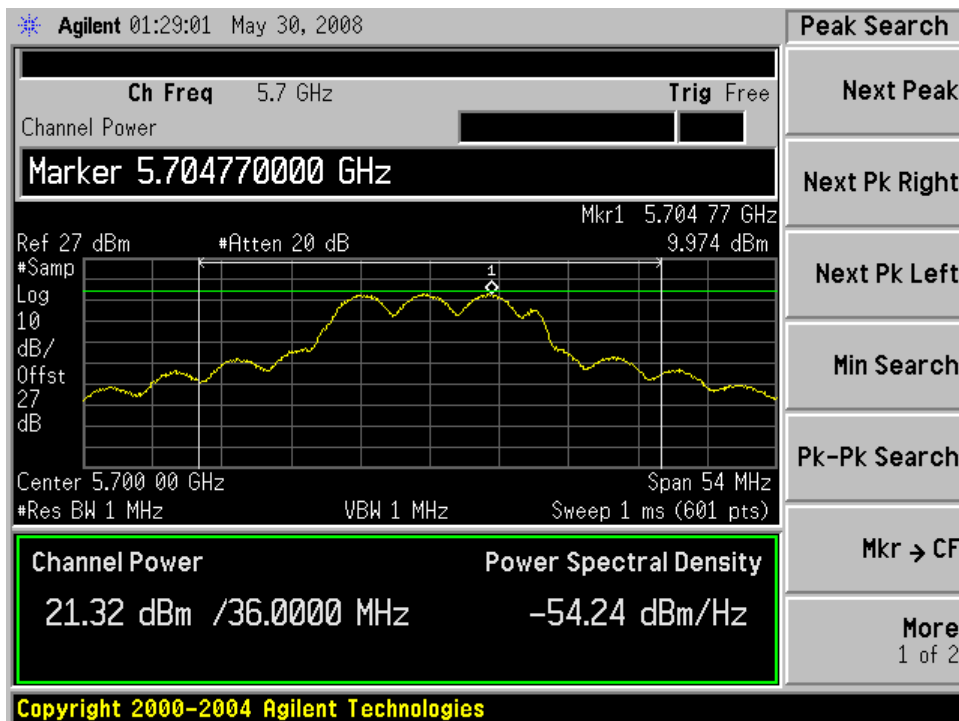

802.11n 40MHz

Low Channel

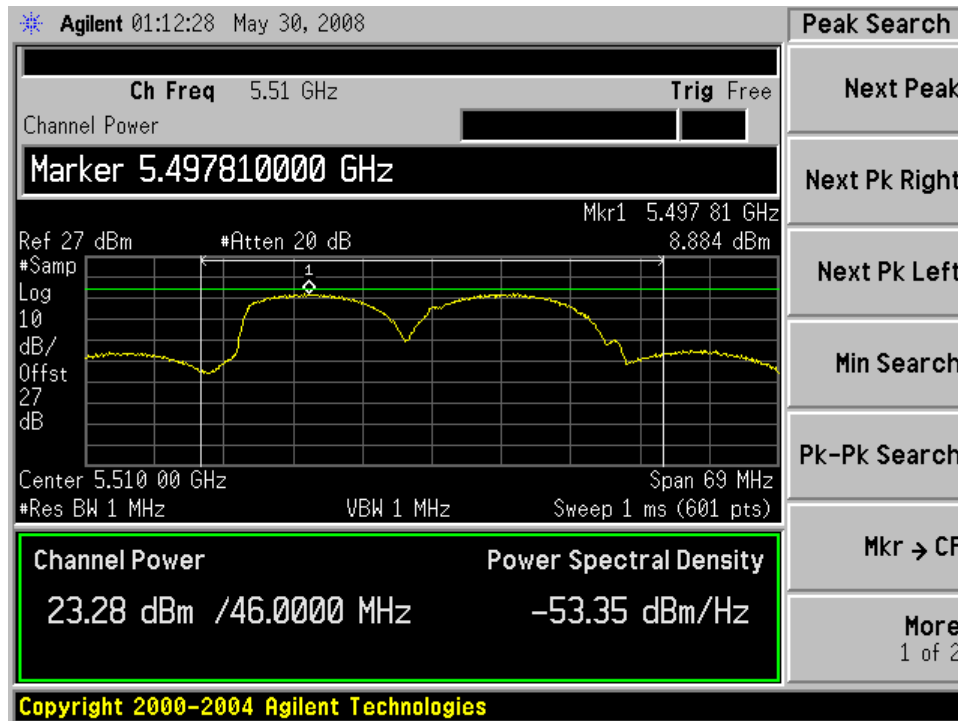

Middle Channel

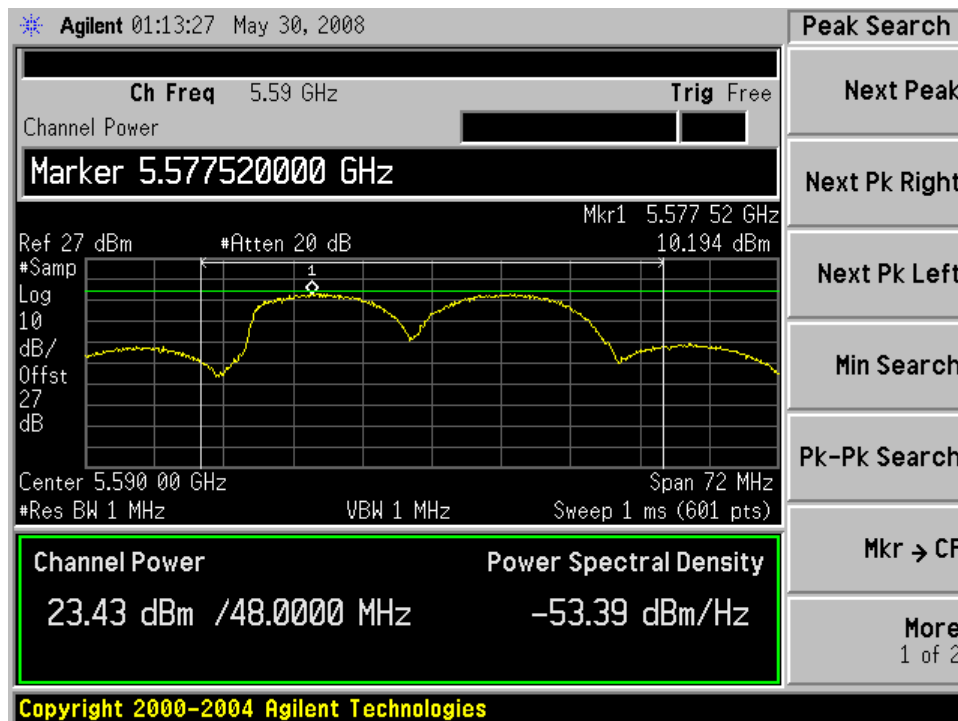

High Channel

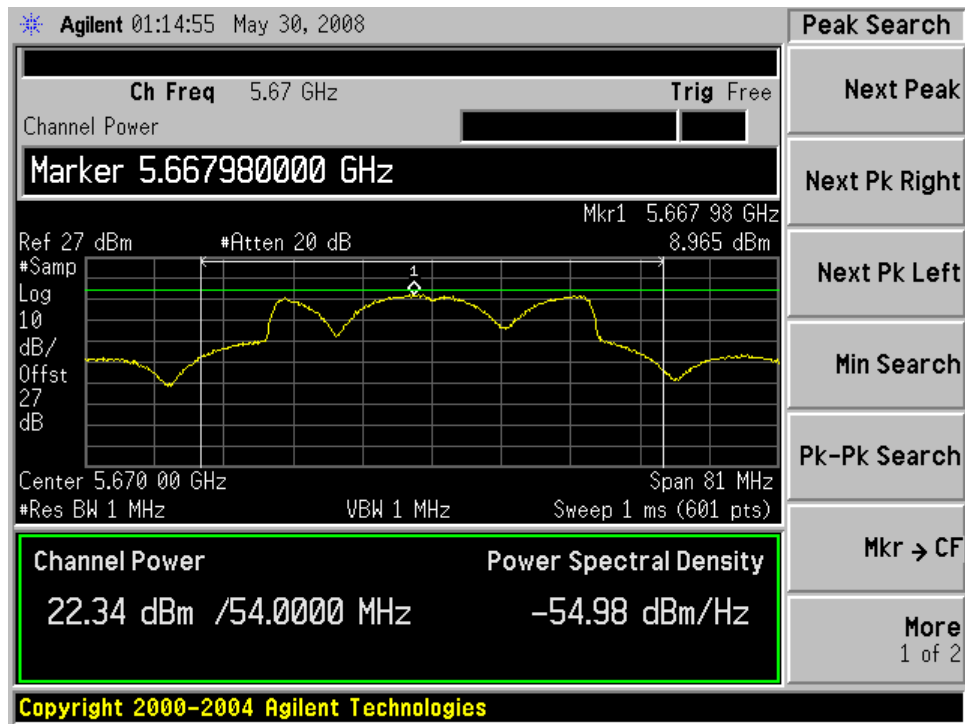

12 FCC §15.407(a) (6) – Peak Excursion

12.1 Applicable Standard

According to §15.407 (a) (6), the ratio of the peak excursion of the modulation envelope (measured using a peak hold function) to the maximum conducted output power (measured as specified above) shall not exceed 13 dB across any 1 MHz bandwidth or the emission bandwidth whichever is less.

12.2 Measurement Procedure

1. Set the SA span to view the entire emission bandwidth. The largest difference between the following two traces must be less than or equal to 13 dB for all frequencies across the emission bandwidth.
2. For the first trace, set RBW = 1MHz and VBW greater or equal to 3MHz utilizing the peak detector and max-hold function.
3. Second trace is created using the setting as described in method # 3 as used in measuring conducted peak output power under FCC Public Notice for U-NII devices August 30, 2002.

12.3 Equipment Lists

Manufacturer	Description	Model	Serial Number	Cal. Date
Agilent	Spectrum analyzer	E4440A	MY44303352	2008-04-28

* **Statement of Traceability:** **BACL Corp.** attests that all calibrations have been performed per the NVLAP requirements, traceable to the NIST.

12.4 Test Setup Diagram

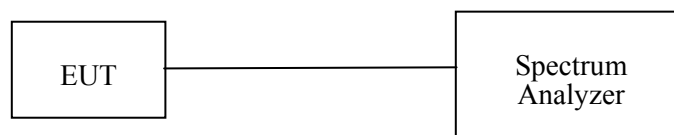

12.5 Environmental Conditions

Temperature:	20° C
Relative Humidity:	40 %
ATM Pressure:	1019 mbar

*The testing was performed by Xiao Ming Hu from 2008-05-28.

12.6 Test Result**12.6.1 5250-5350 MHz Band (W53)****802.11n 20MHz**

Frequency (MHz)	Peak Excursion Both Chains (dB)	Limit (dB)	Result
5260	8.82	13	Pass
5300	11.405	13	Pass
5320	12.578	13	Pass

802.11n 40MHz

Frequency (MHz)	Peak Excursion Both Chains (dB)	Limit (dB)	Result
5270	12.238	13	Pass
5310	12.083	13	Pass

802.11a 20MHz

Frequency (MHz)	Peak Excursion Both Chains (dB)	Limit (dB)	Result
5260	11.185	13	Pass
5300	9.411	13	Pass
5320	8.889	13	Pass

12.6.2 5470-5725 MHz Band (W56)**802.11n 20MHz**

Frequency (MHz)	Peak Excursion Both Chains (dB)	Limit (dB)	Result
5500	12.464	13	Pass
5600	12.501	13	Pass
5700	11.946	13	Pass

802.11n 40MHz

Frequency (MHz)	Peak Excursion Both Chains (dB)	Limit (dB)	Result
5510	11.713	13	Pass
5590	12.249	13	Pass
5670	10.990	13	Pass

802.11a 20MHz

Frequency (MHz)	Peak Excursion Both Chains (dB)	Limit (dB)	Result
5500	8.427	13	Pass
5600	9.779	13	Pass
5700	10.305	13	Pass

12.6.3 5150-5250 MHz Band (W52)

802.11n 20MHz

Low Channel

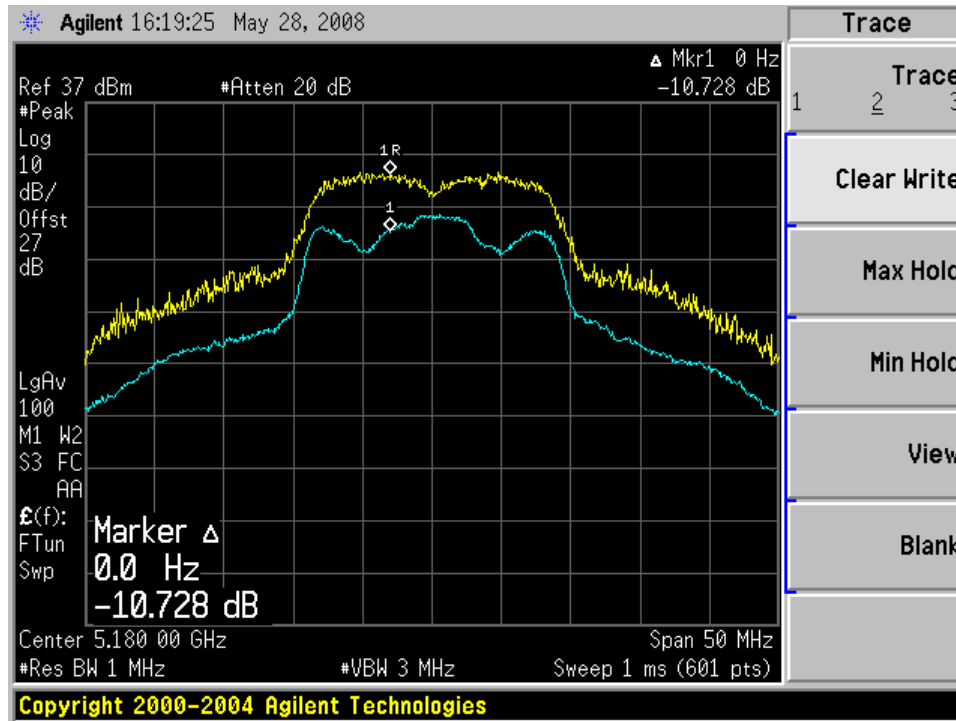

Middle Channel

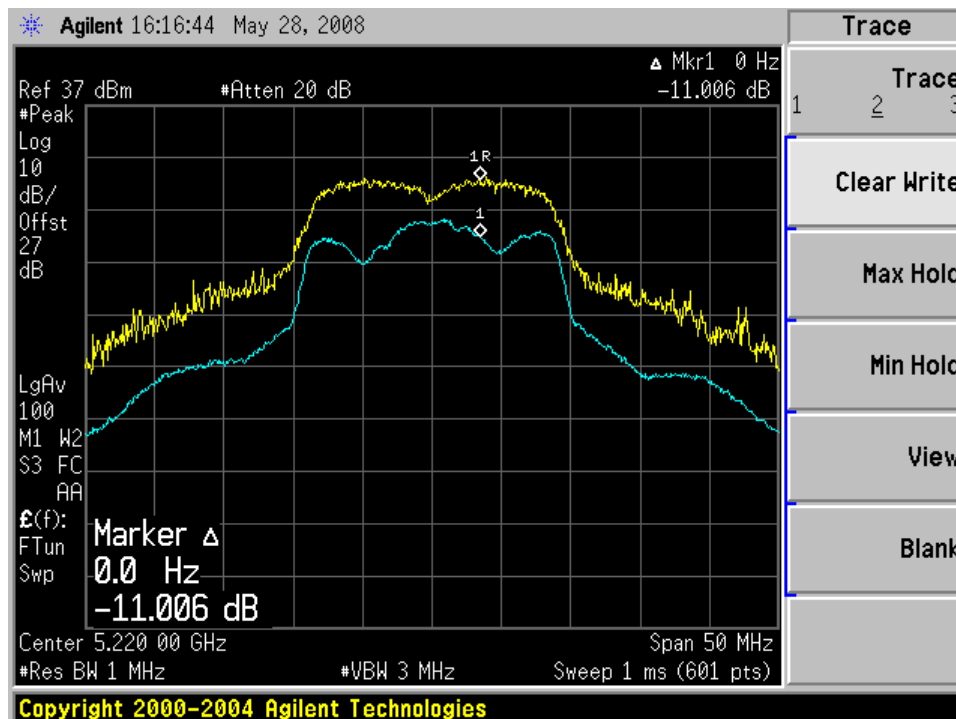

High Channel

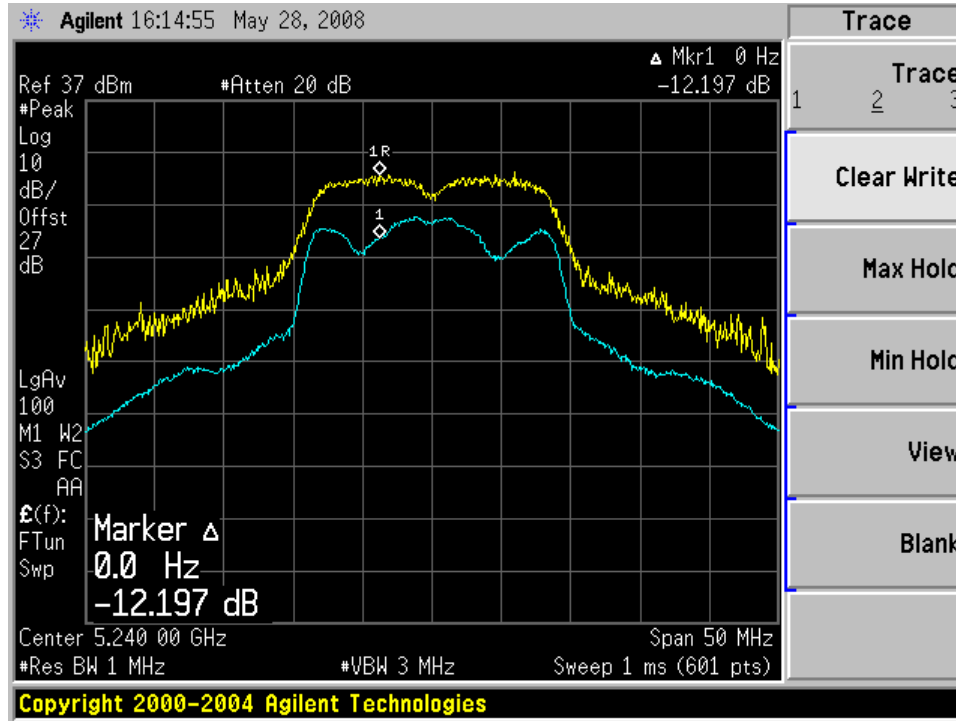

802.11a 20MHz

Low Channel

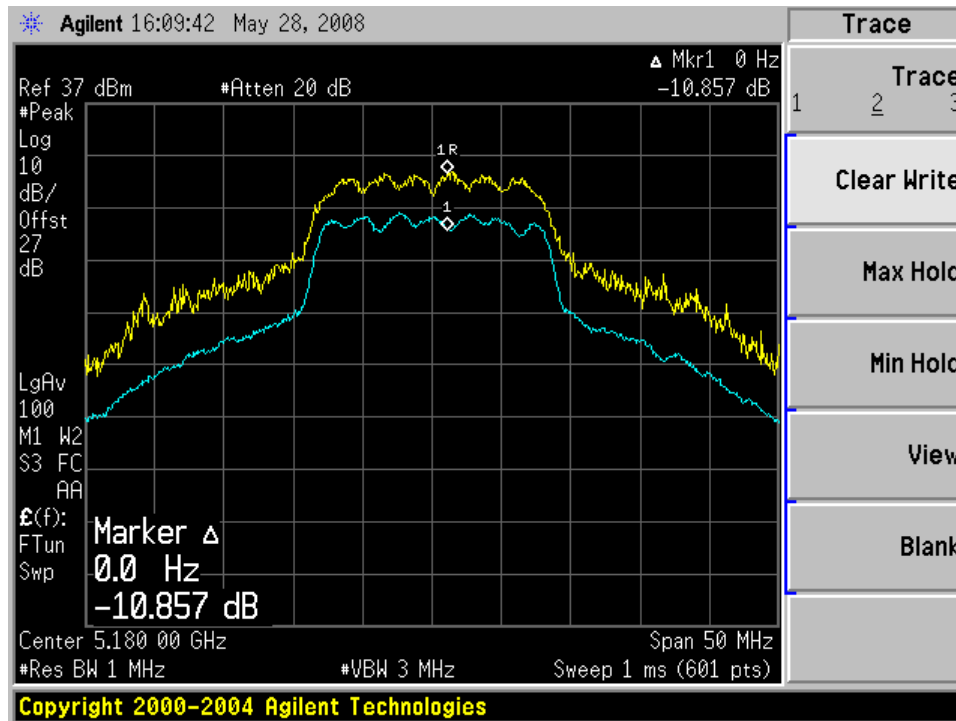

Middle Channel

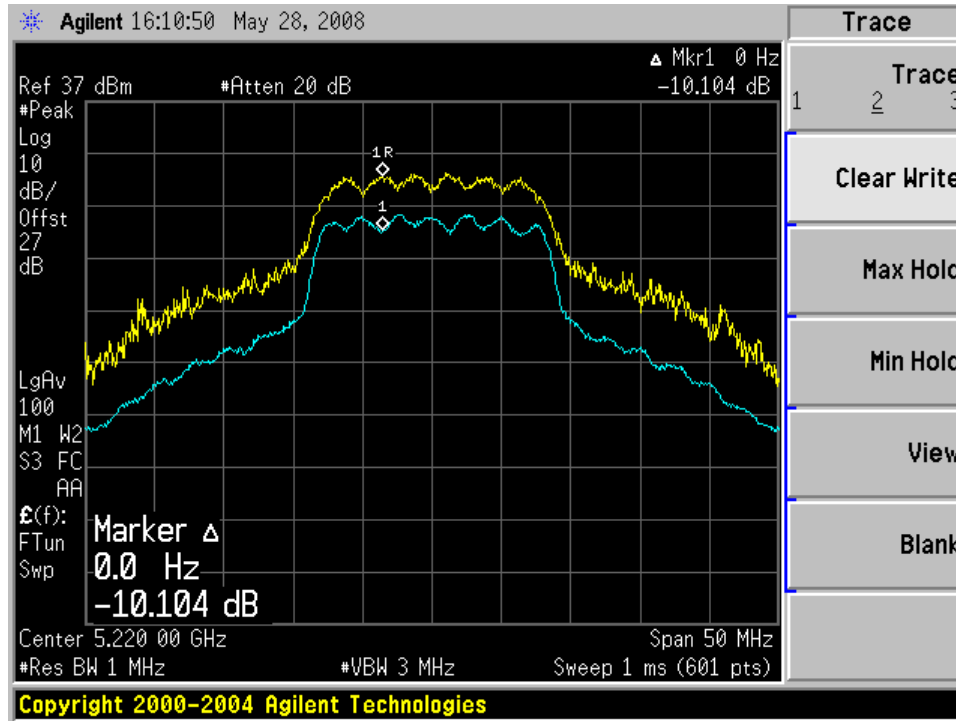

High Channel

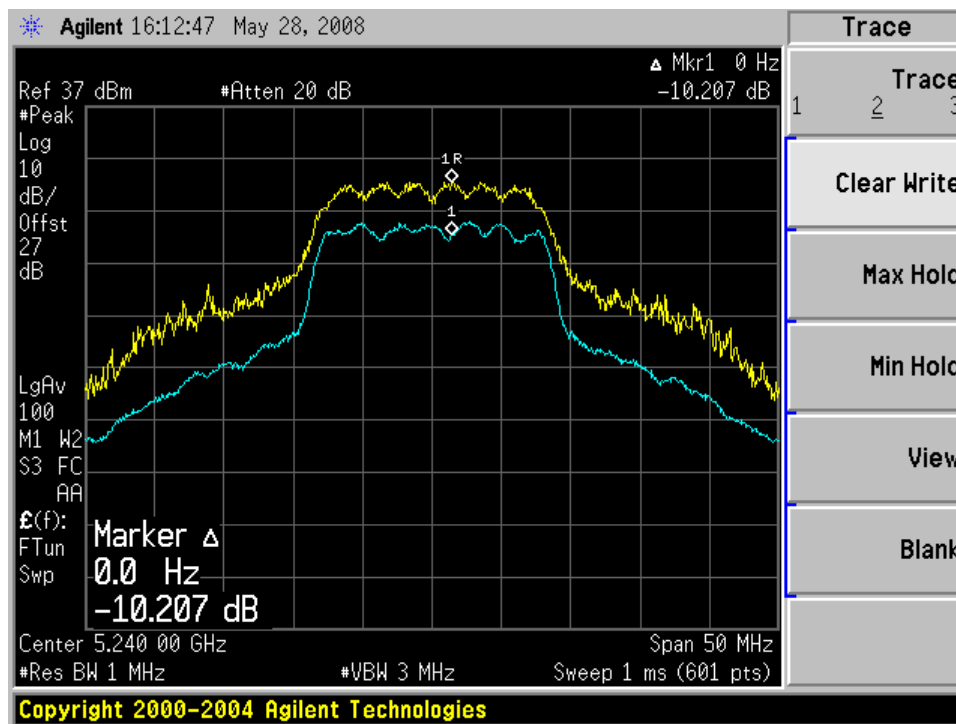

802.11n 40MHz

Low Channel

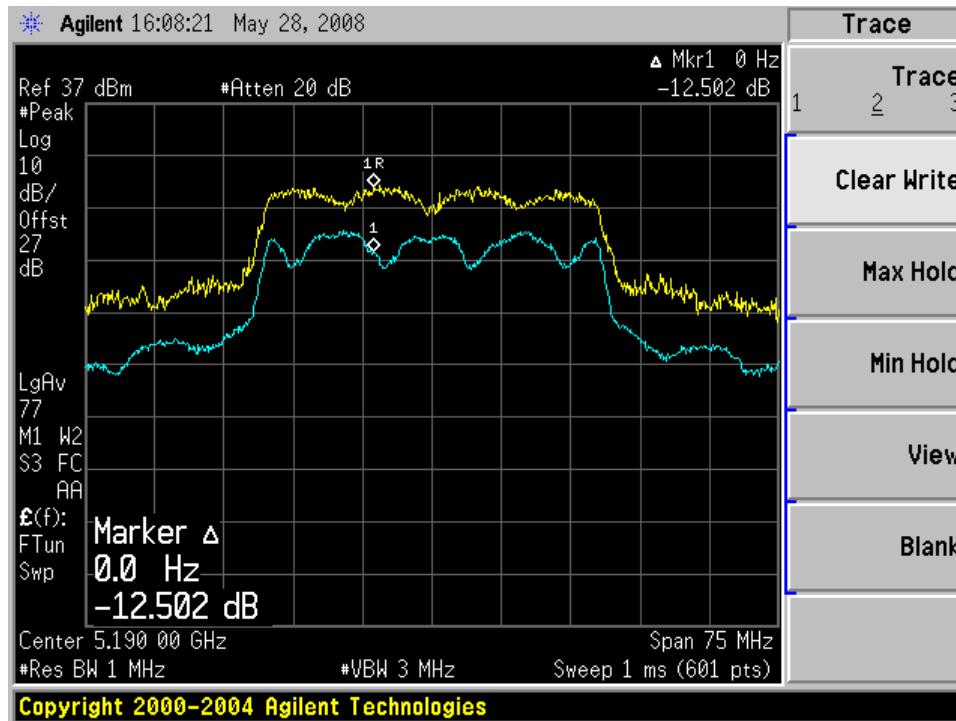

High Channel

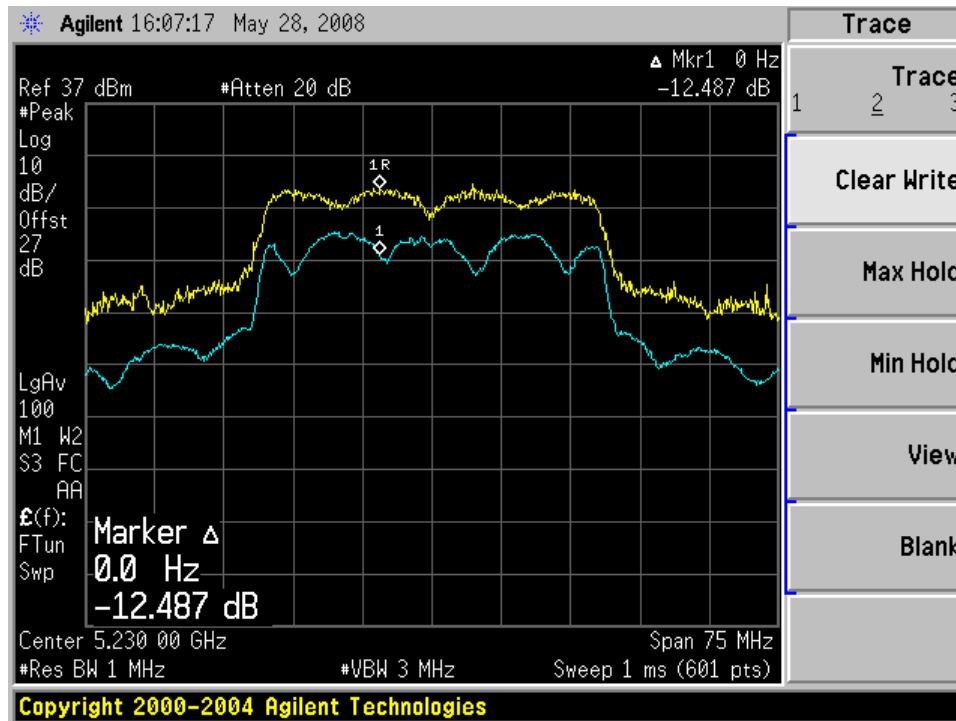

12.6.4 5250-5350 MHz Band (W53)

802.11n 20MHz

Low Channel

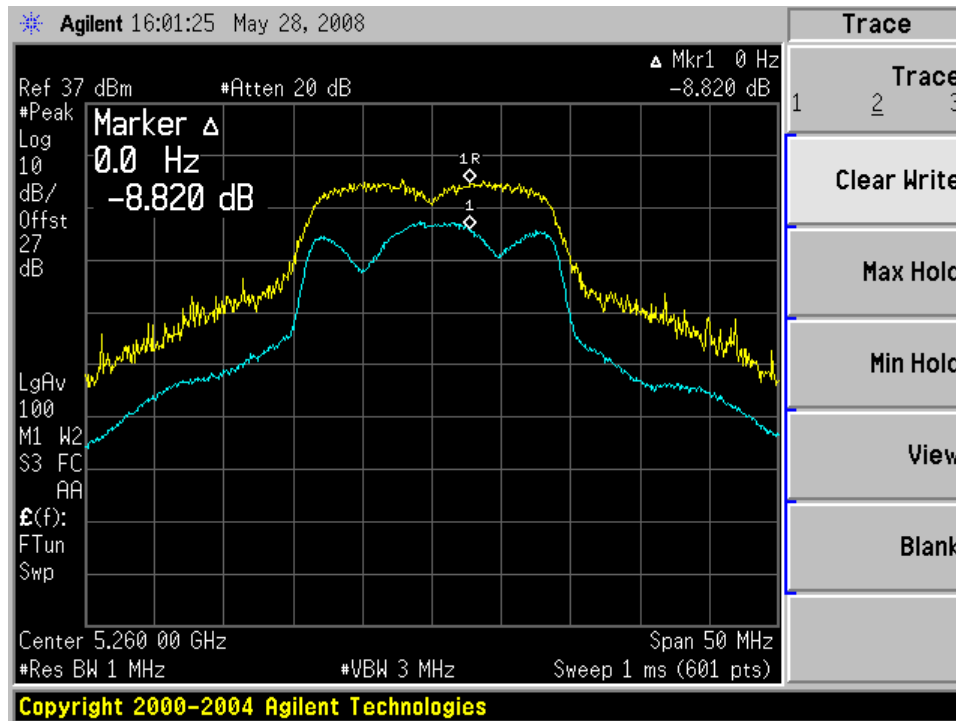

Middle Channel

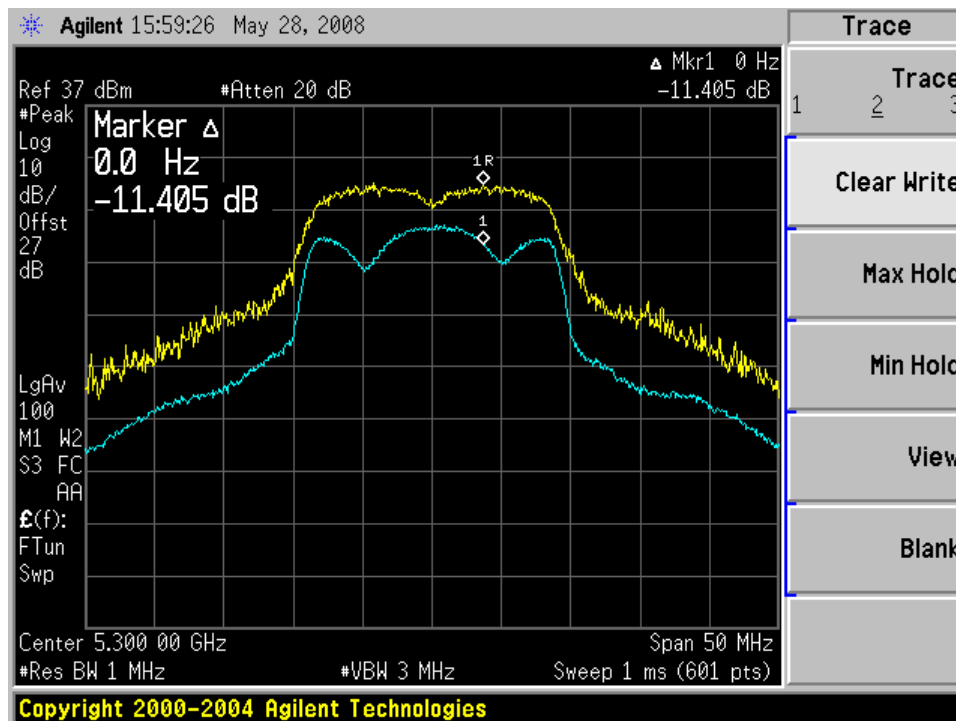

High Channel

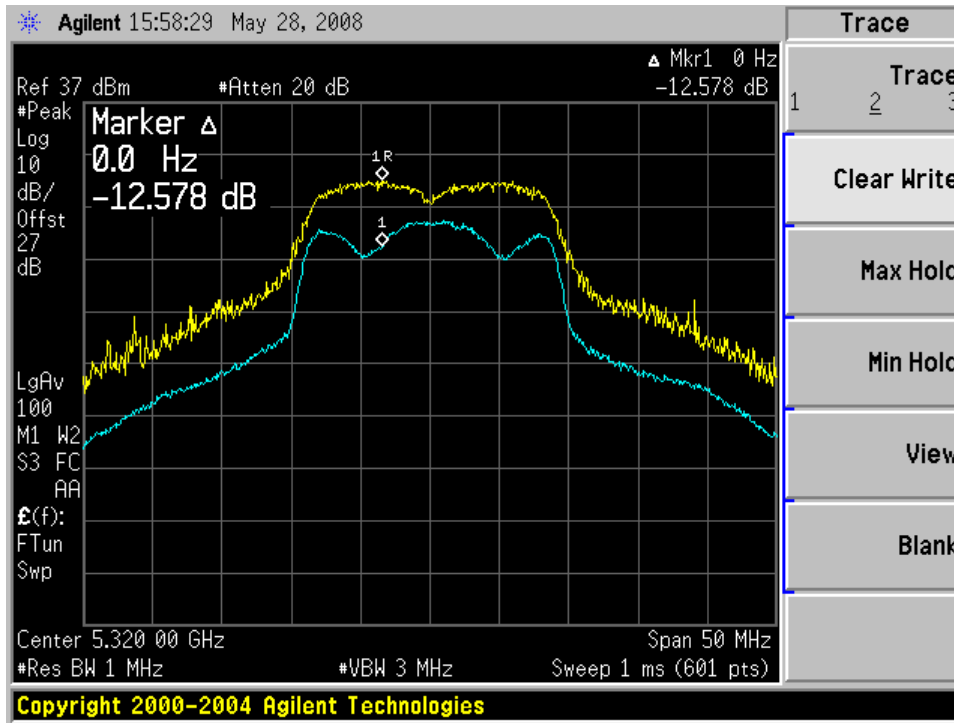

802.11a 20MHz

Low Channel

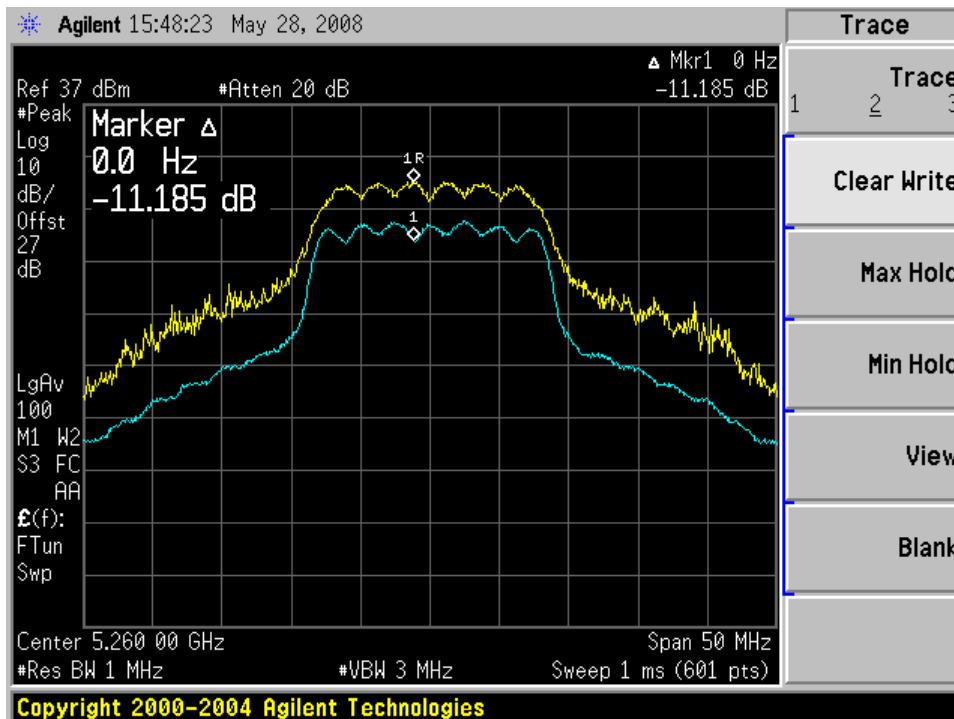

Middle Channel

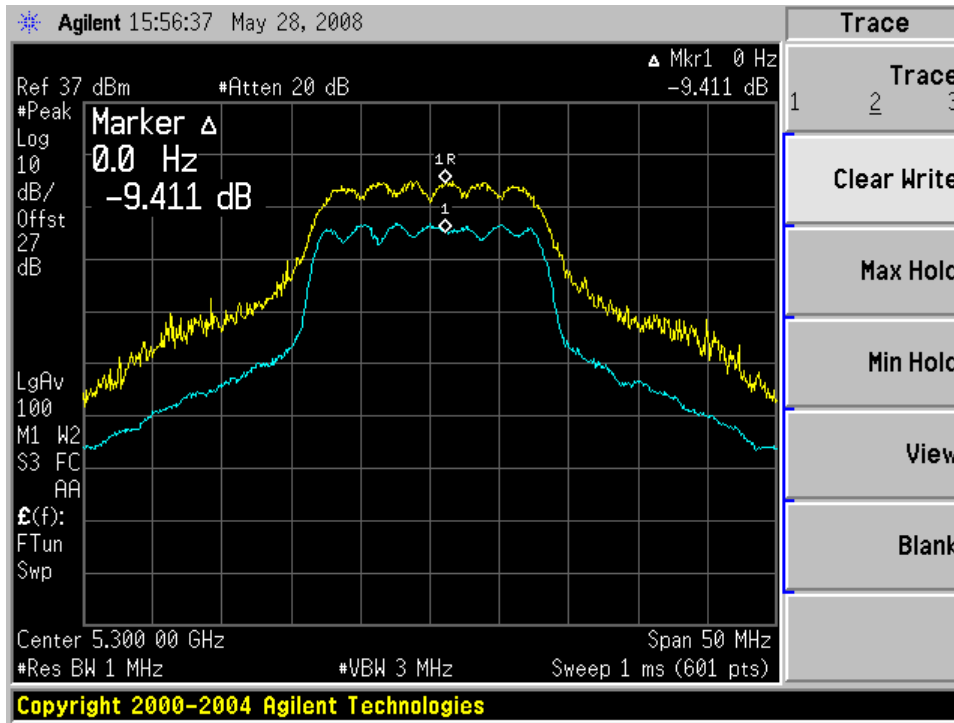

High Channel

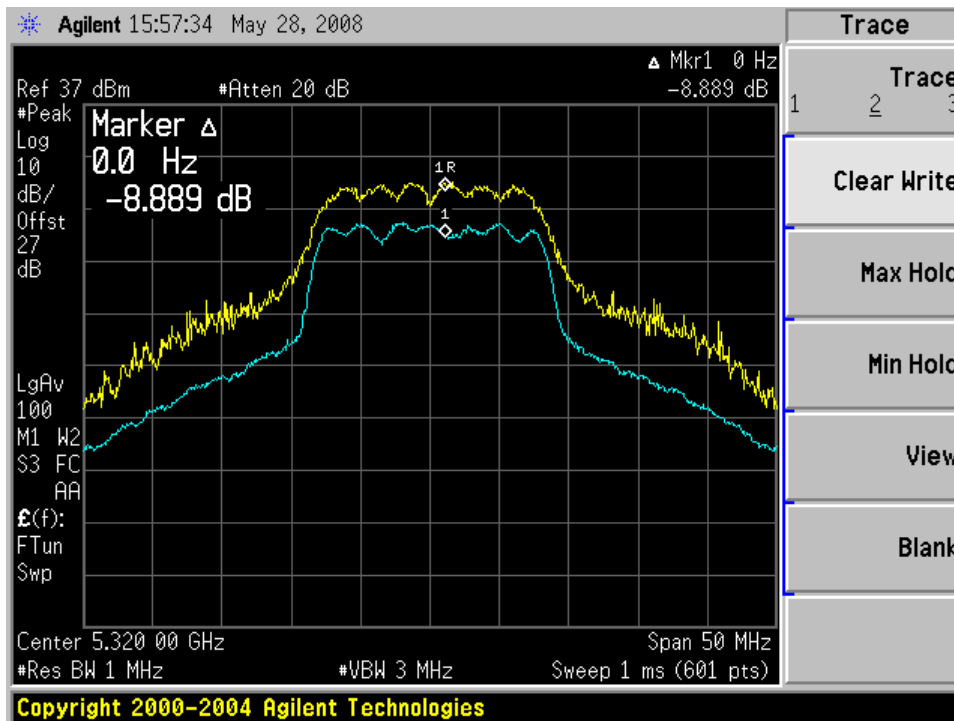

802.11n 40MHz

Low Channel

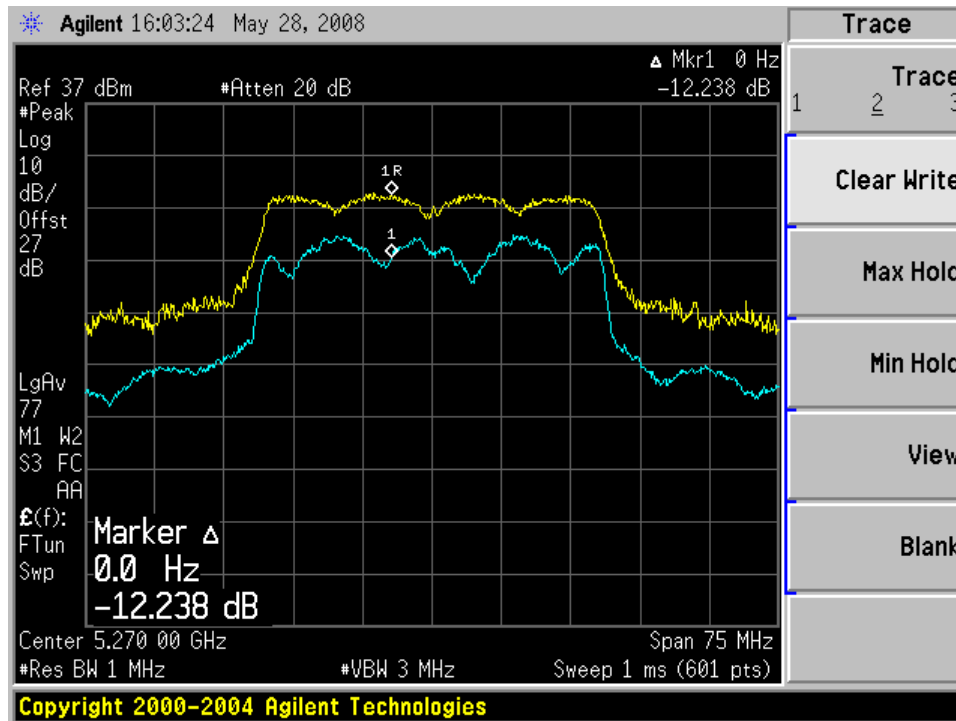

High Channel

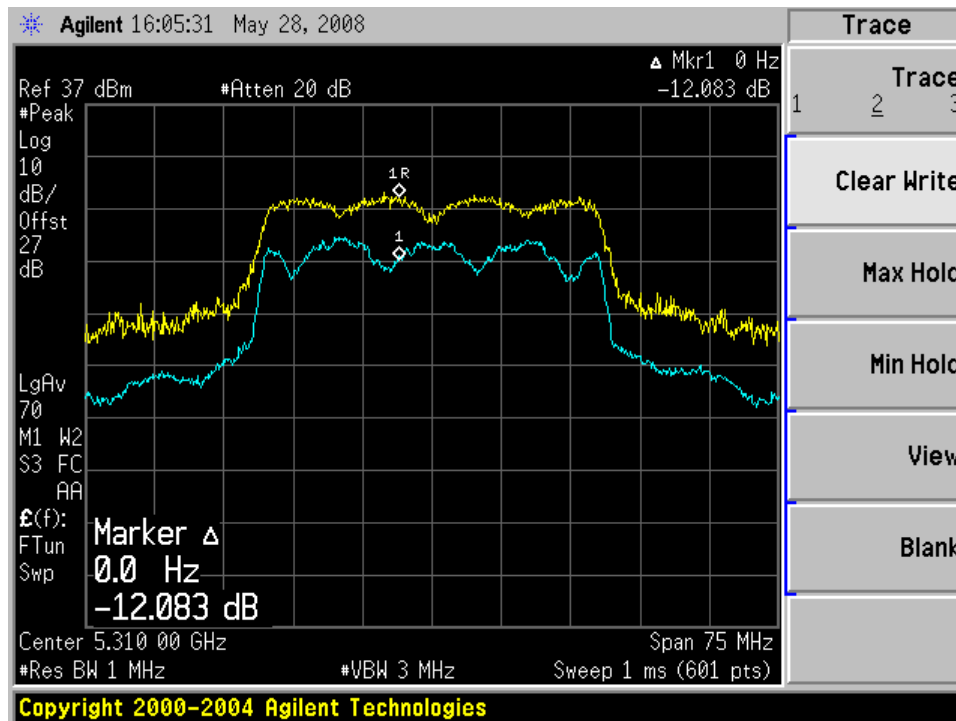

12.6.5 5470-5725 MHz Band (W56)

802.11n 20MHz

Low Channel

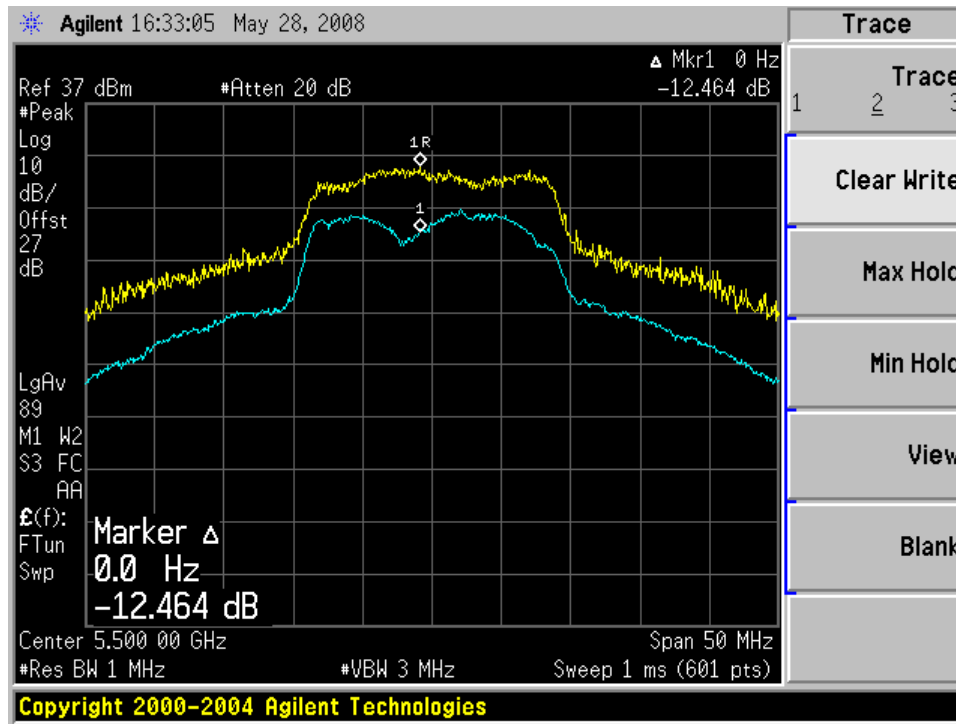

Middle Channel

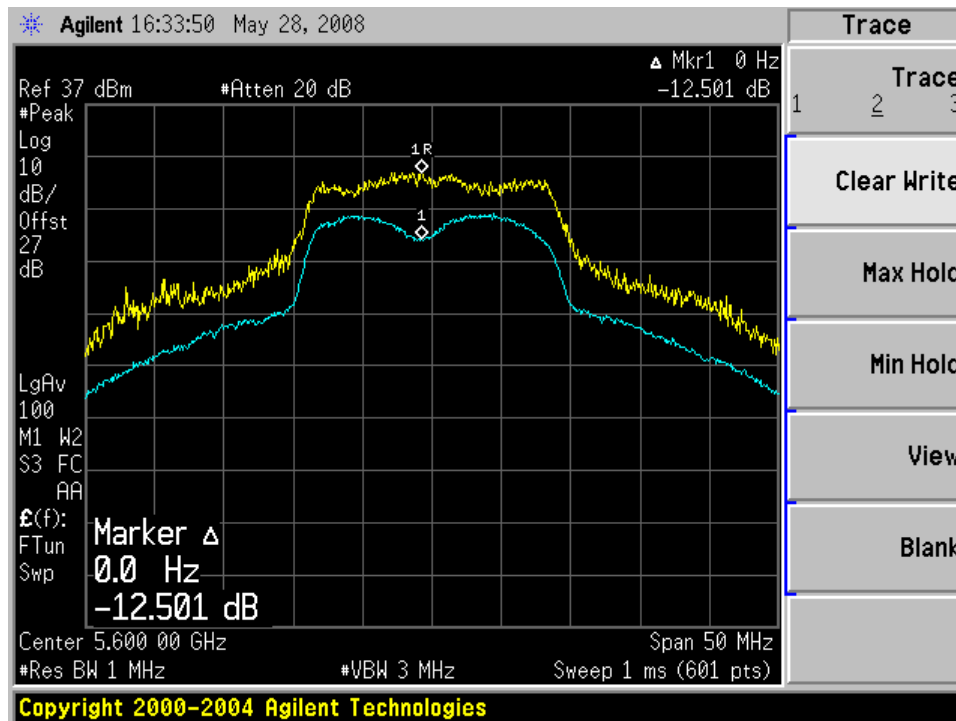

High Channel

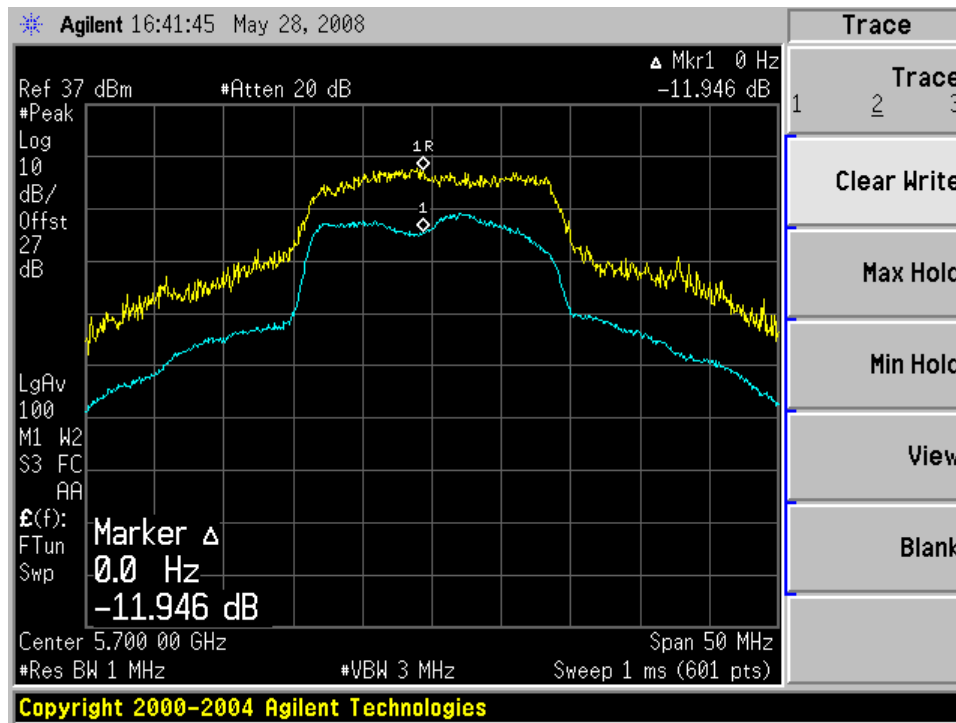

802.11a 20MHz

Low Channel

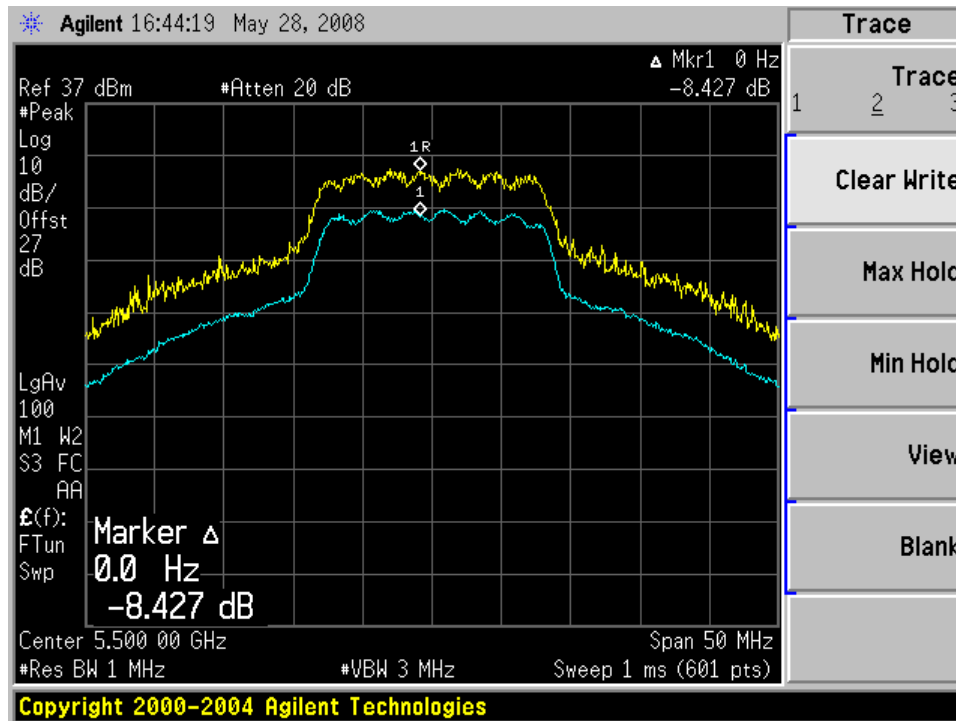

Middle Channel

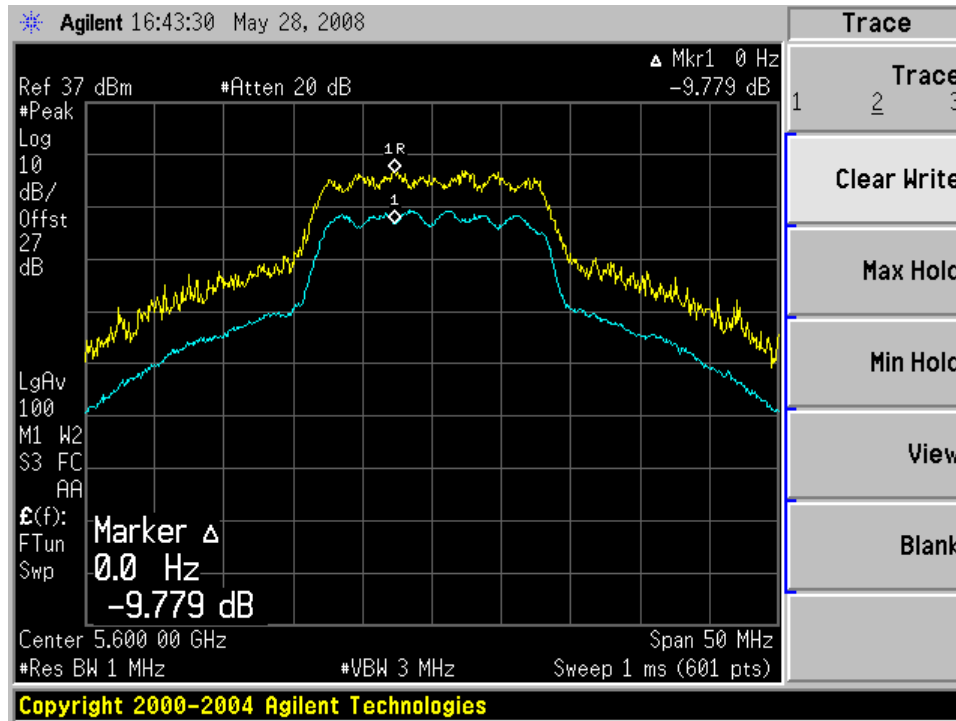

High Channel

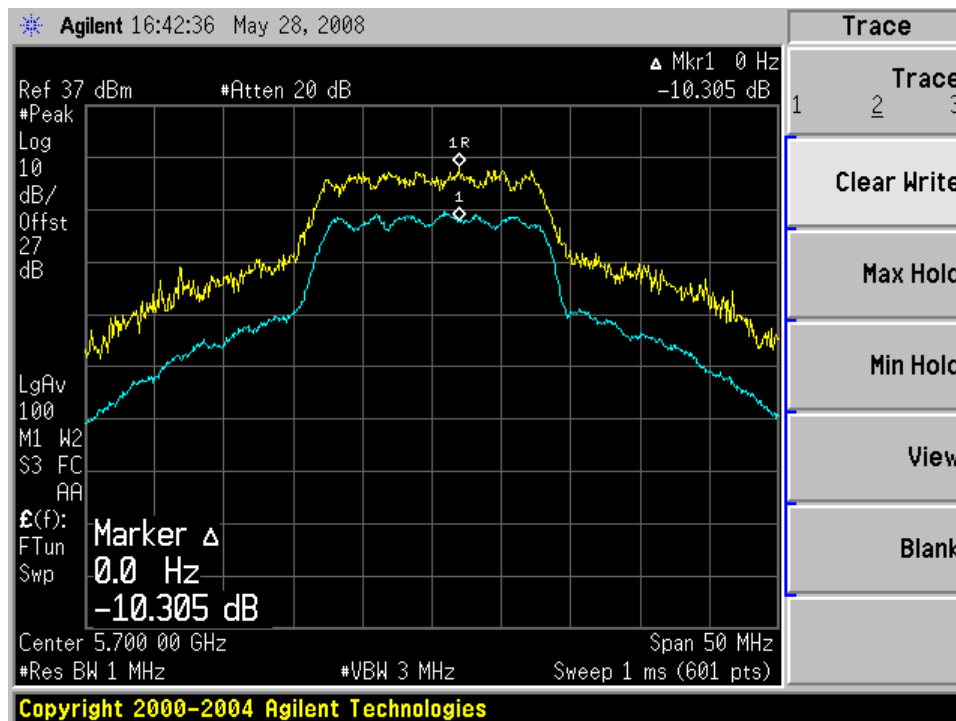

802.11n 40MHz

Low Channel

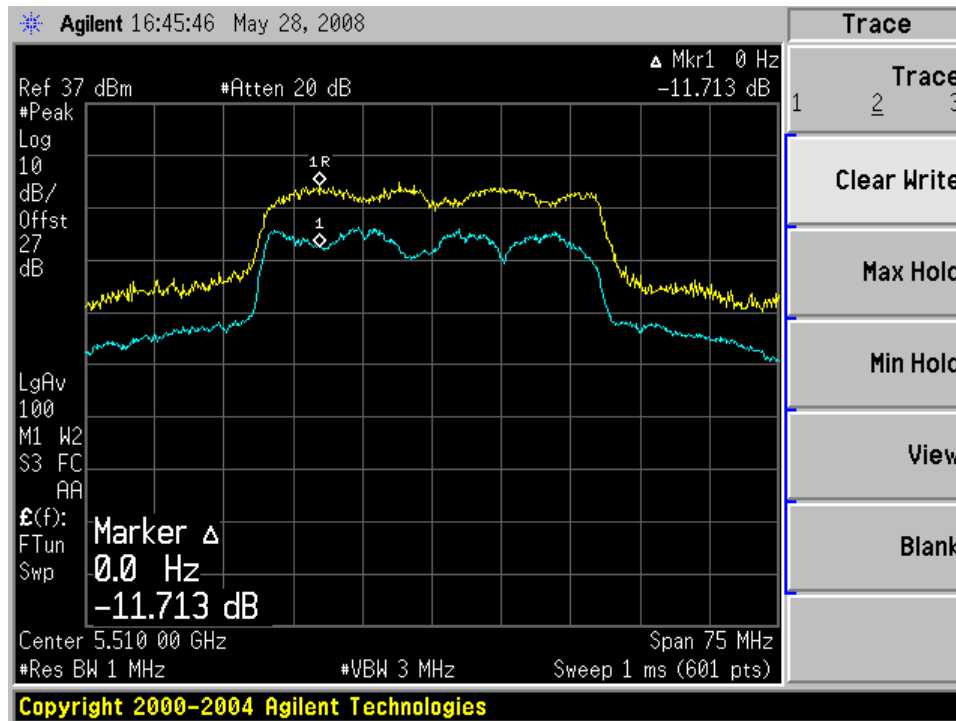

Middle Channel

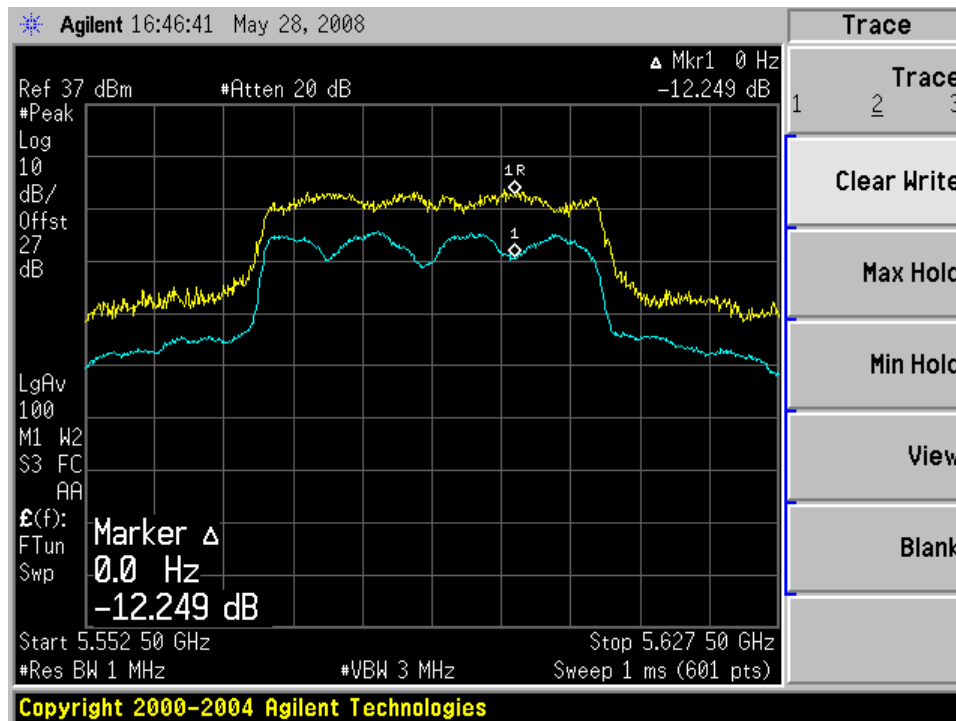

High Channel

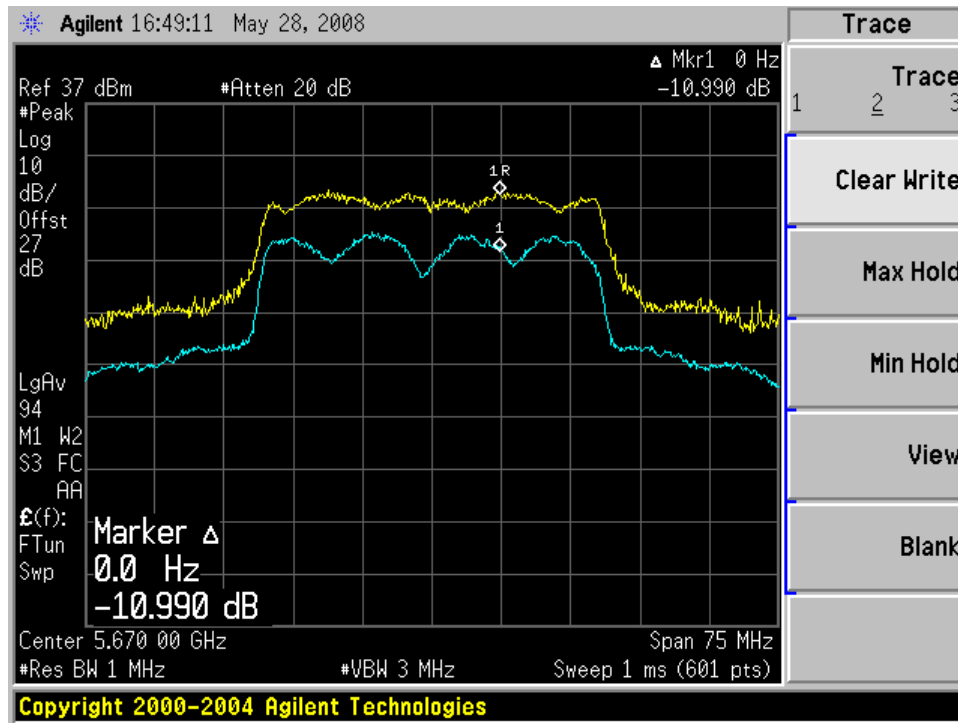

13 FCC §15.407(h) & RSS 210 A9.4– Dynamic Frequency Selection

13.1 Applicable Standard

§15.407 (h) and FCC 06-96.

Table 1: Applicability of DFS requirements prior to use of a channel

Requirement	Operational Mode		
	Master	Client (Without radar detection)	Client (With radar detection)
<i>Non-Occupancy Period</i>	Yes	Not Required	Yes
<i>DFS Detection Threshold</i>	Yes	Not Required	Yes
<i>Channel Availability Check Time</i>	Yes	Not Required	Not Required
<i>Uniform Spreading</i>	Yes	Not Required	Not Required
<i>U-NII Detection Bandwidth</i>	Yes	Not Required	Yes

Table 2: Applicability of DFS requirements during normal operation

Requirement	Operational Mode		
	Master	Client (Without DFS)	Client (With DFS)
<i>DFS Detection Threshold</i>	Yes	Not Required	Yes
<i>Channel Closing Transmission Time</i>	Yes	Yes	Yes
<i>Channel Move Time</i>	Yes	Yes	Yes

Table 3: Interference Threshold values, Master or Client incorporating In-Service Monitoring

Maximum Transmit Power	Value (See Notes 1 and 2)
≥ 200 milliwatt	-64 dBm
< 200 milliwatt	-62 dBm

Note 1: This is the level at the input of the receiver assuming a 0 dBi receive antenna.
Note 2: Throughout these test procedures an additional 1 dB has been added to the amplitude of the test transmission waveforms to account for variations in measurement equipment. This will ensure that the test signal is at or above the detection threshold level to trigger a DFS response.

Table 4: DFS Response requirement values

Parameter	Value
<i>Non-occupancy period</i>	Minimum 30 minutes
<i>Channel Availability Check Time</i>	60 seconds
<i>Channel Move Time</i>	10 seconds See Note 1.
<i>Channel Closing Transmission Time</i>	200 milliseconds + an aggregate of 60 milliseconds over remaining 10 second period. See Notes 1 and 2.
<i>U-NII Detection Bandwidth</i>	Minimum 80% of the UNII 99% transmission power bandwidth. See Note 3.

Note 1: The instant that the *Channel Move Time* and the *Channel Closing Transmission Time* begins is as follows:

- For the Short Pulse Radar Test Signals this instant is the end of the *Burst*.
- For the Frequency Hopping radar Test Signal, this instant is the end of the last radar *Burst* generated.
- For the Long Pulse Radar Test Signal this instant is the end of the 12 second period defining the *Radar Waveform*.

Note 2: The *Channel Closing Transmission Time* is comprised of 200 milliseconds starting at the beginning of the *Channel Move Time* plus any additional intermittent control signals required to facilitate a *Channel* move (an aggregate of 60 milliseconds) during the remainder of the 10 second period. The aggregate duration of control signals will not count quiet periods in between transmissions.

Note 3: During the *U-NII Detection Bandwidth* detection test, radar type 1 is used and for each frequency step the minimum percentage of detection is 90 percent. Measurements are performed with no data traffic.

Table 5: Short Pulse Radar Test Waveforms

Radar Type	Pulse Width (Microseconds)	PRI (Microseconds)	Pulses	Minimum Percentage of Successful Detection	Minimum Number of Trials
1	1	1428	18	60%	30
2	1-5	150-230	23-29	60%	30
3	6-10	200-500	16-18	60%	30
4	11-20	200-500	12-16	60%	30
Aggregate (Radar Types 1-4)				80%	120

Table 6: Long Pulse Radar Test Signal

Radar Type	Bursts	Chirp Width (MHz)	PRI (usec)	Number of Pulses per Burst	Number of Bursts	Minimum Percentage of Successful Detection	Minimum Number of Trials
5	50-100	5-20	1000-2000	1-3	8-20	80%	30

Table 7: Frequency Hopping Radar Test Signal

Radar Type	Pulse Width (usec)	PRI (usec)	Pulses per Hop	Hopping Rate (kHz)	Hopping Sequence Length (msec)	Minimum Percentage of Successful Detection	Minimum Number of Trials
6	1	333	9	0.333	300	70%	30

13.2 Statement of Compliance

The test sample of Ruckus Wireless, Inc. model VF7811 and VF7111 complied with the DFS requirements of:

FCC Part 15.407.

Please refer to the DFS test report DFS report R0803191-DFS-FCC.