

802.11a-5240MHz

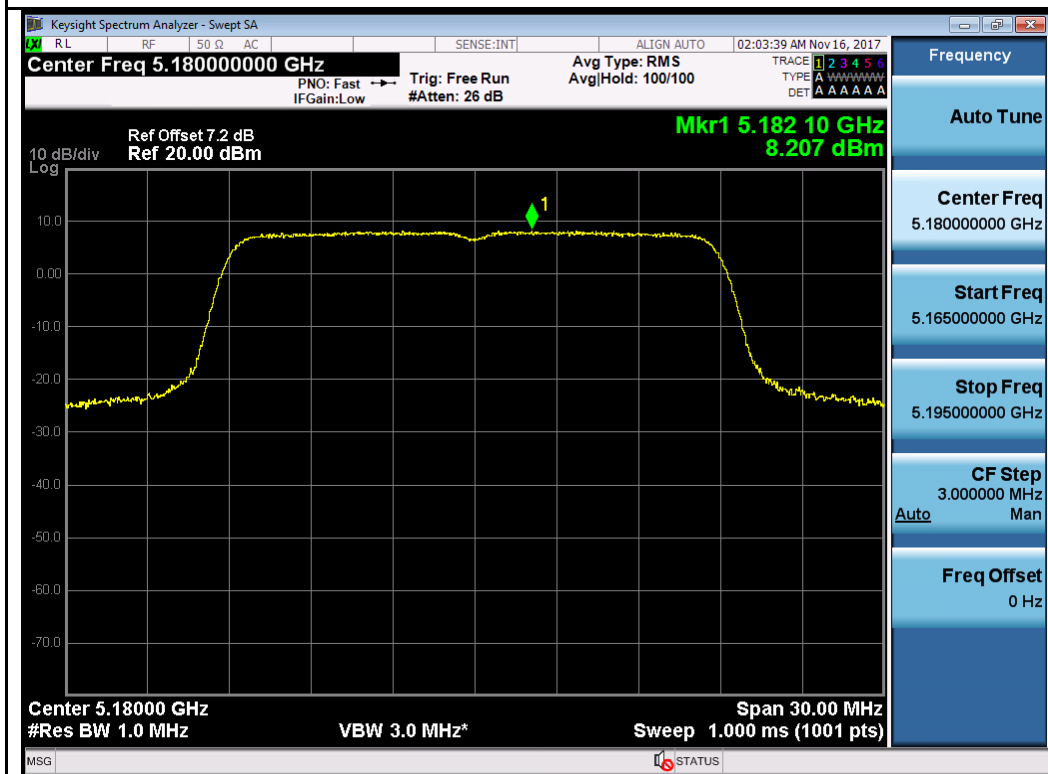

802.11n-HT20-5180MHz

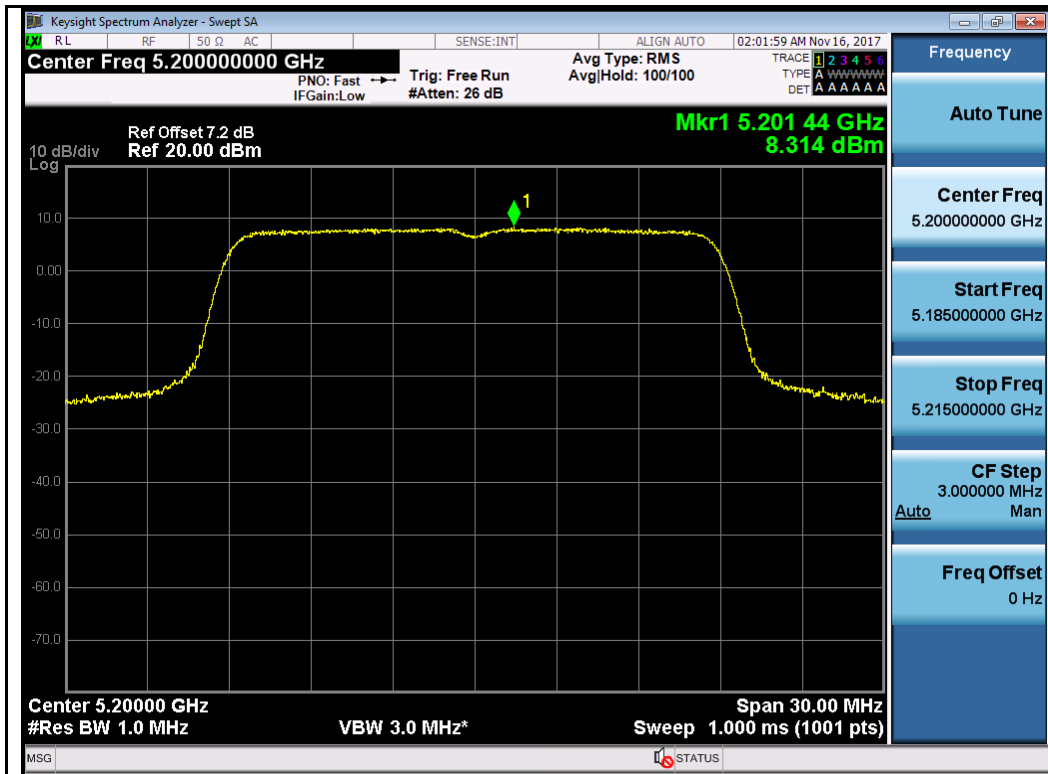

802.11n-HT20-5200MHz

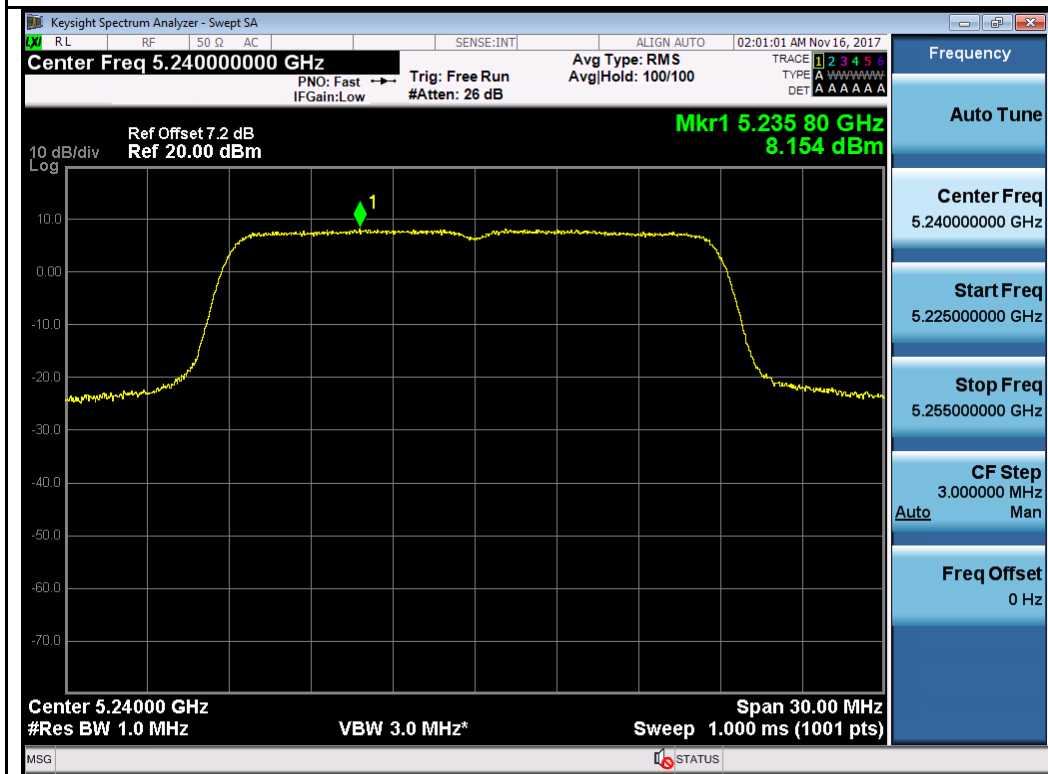

802.11n-HT20-5240MHz

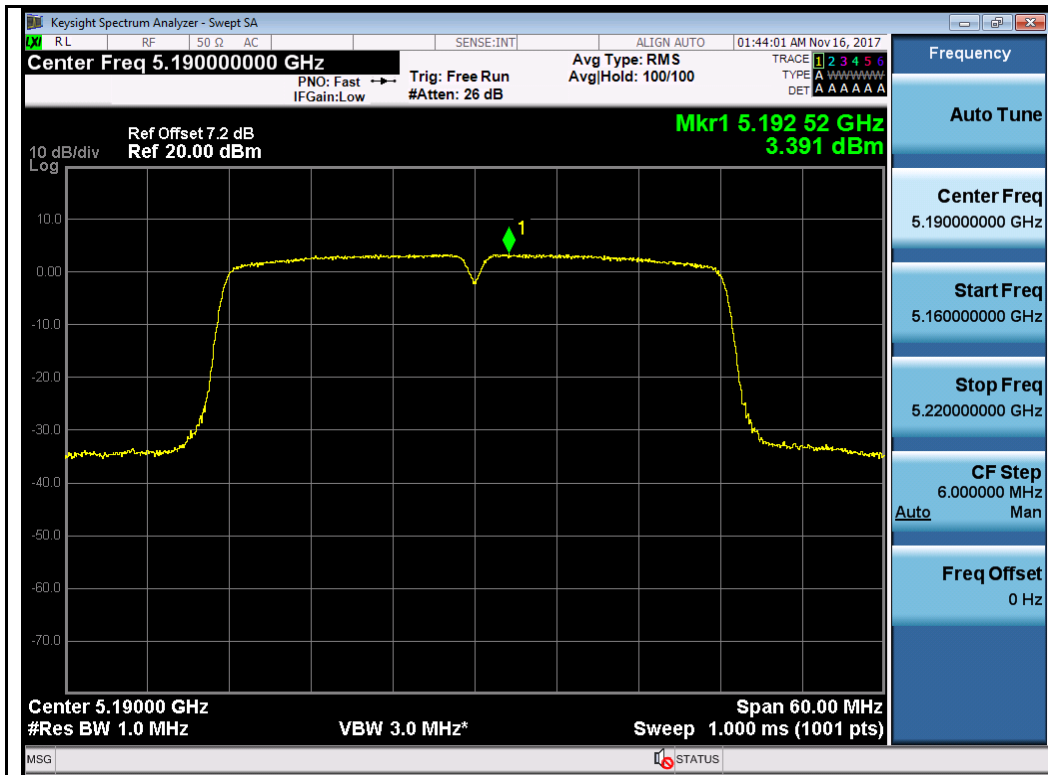

802.11n-HT40-5190MHz

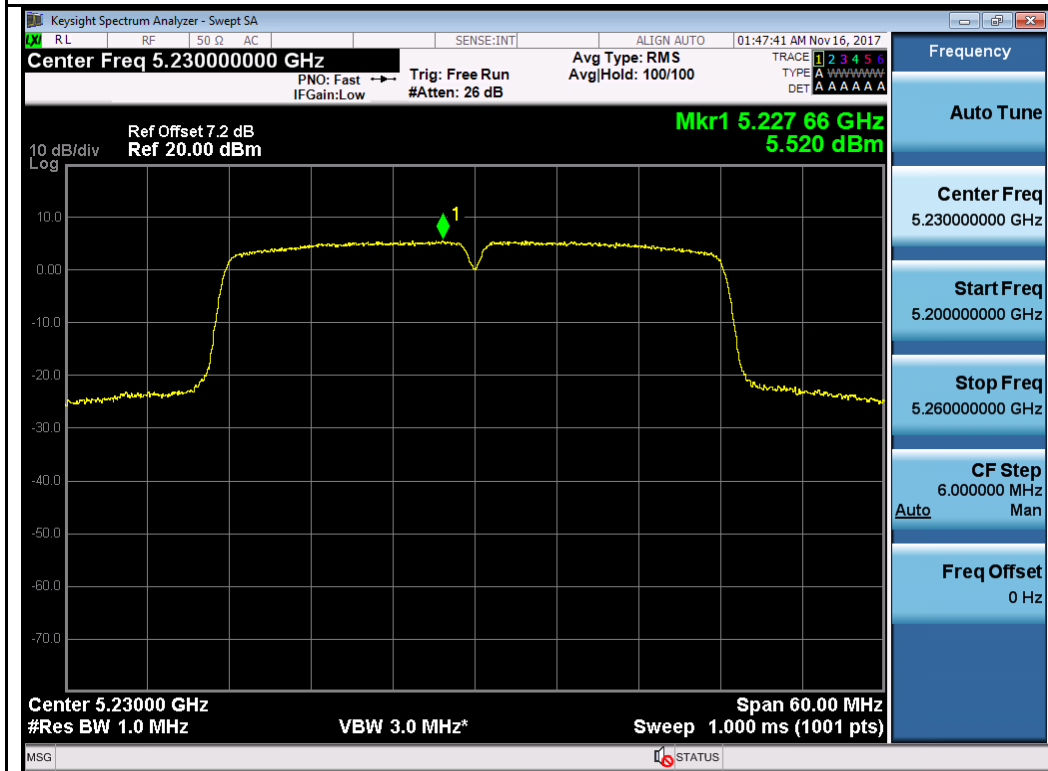

802.11n-HT40-5230MHz

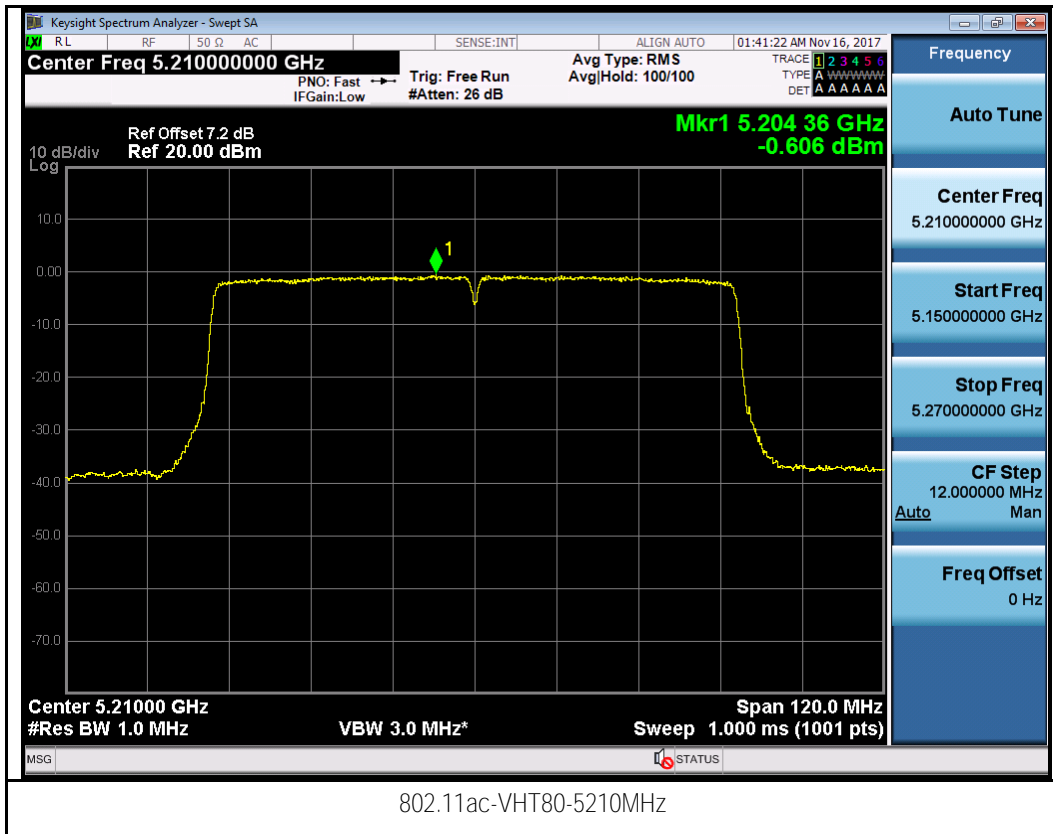

Chain 1:

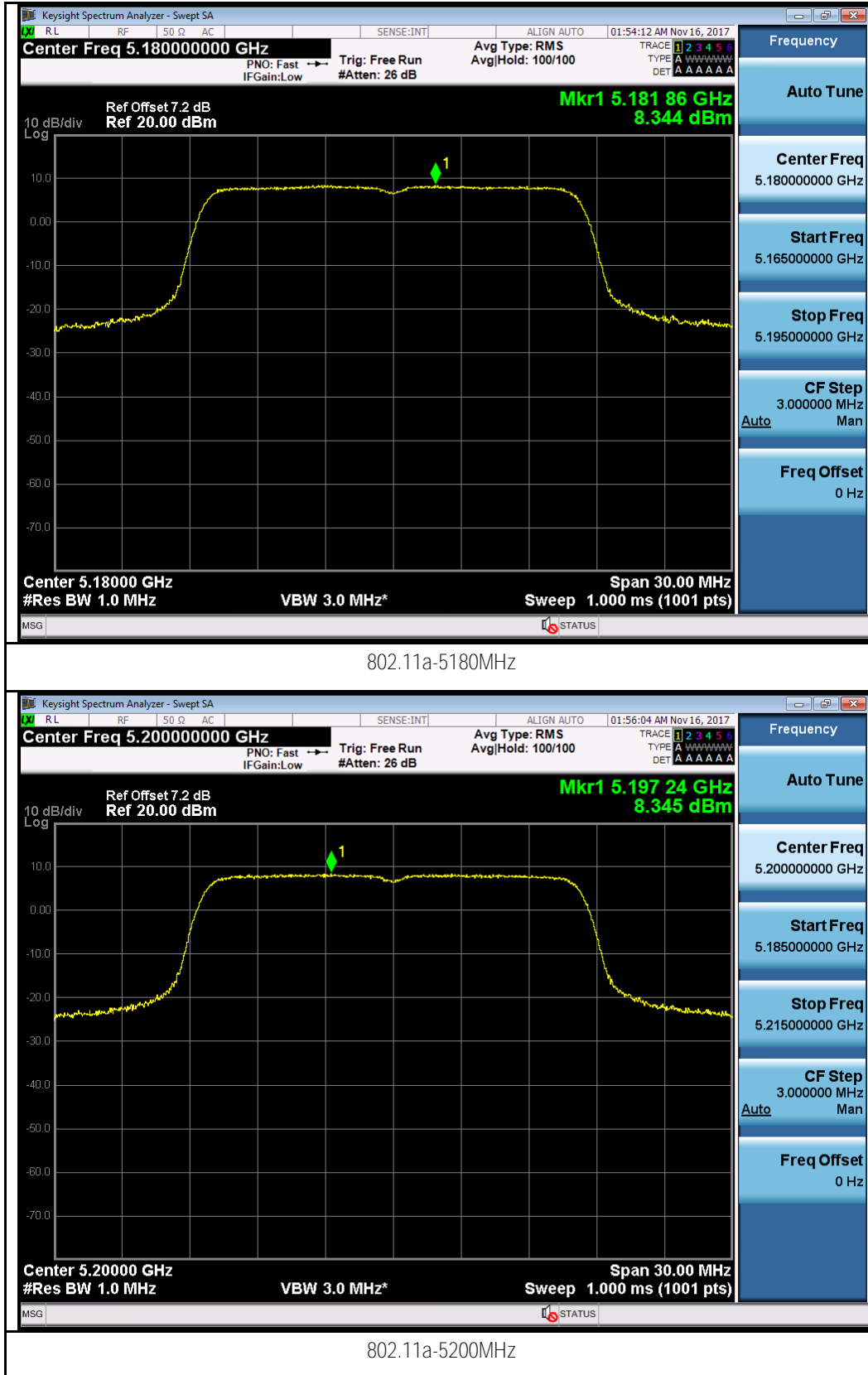

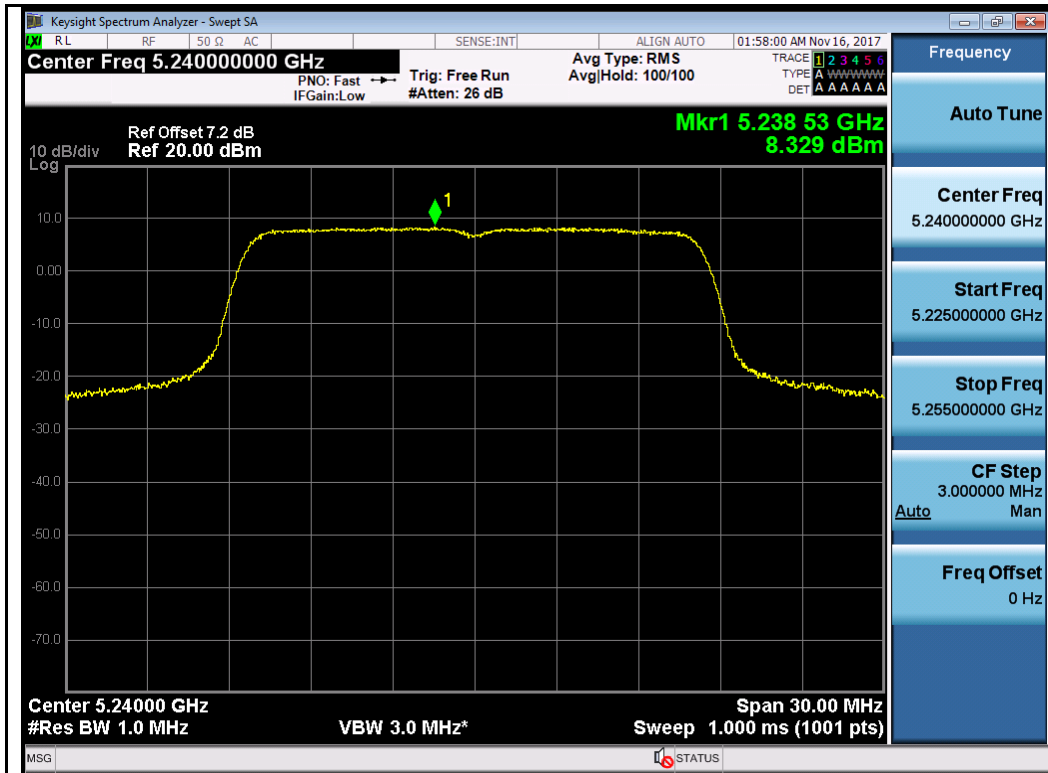

802.11a-5240MHz

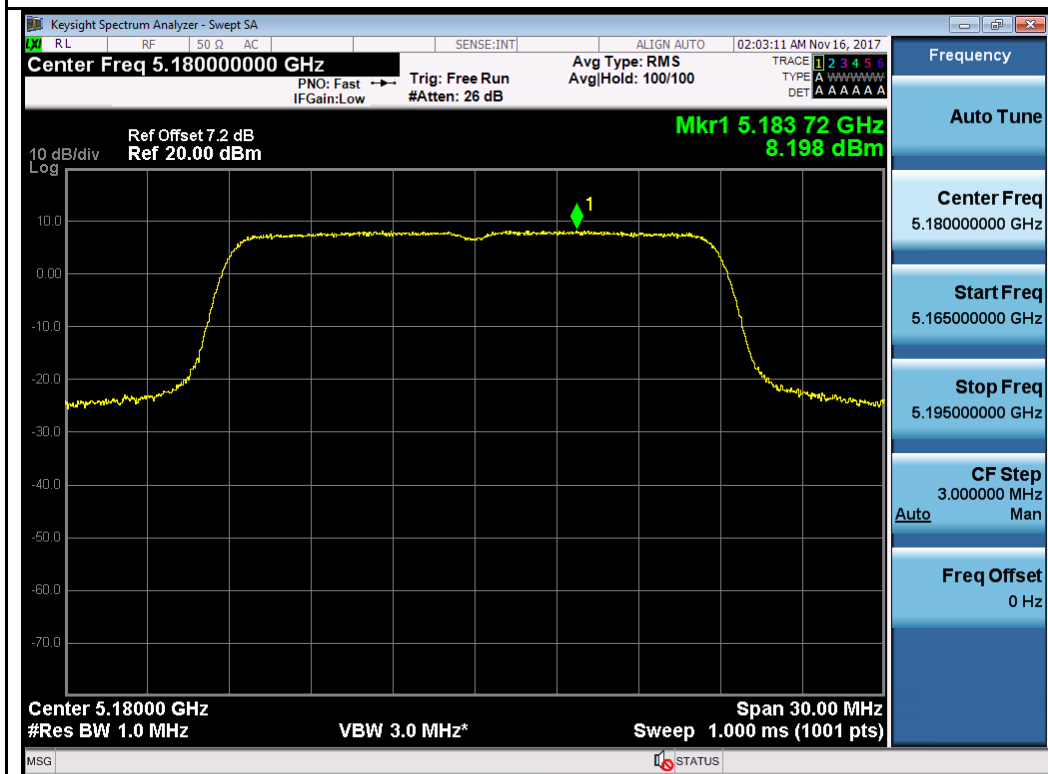

802.11n-HT20-5180MHz

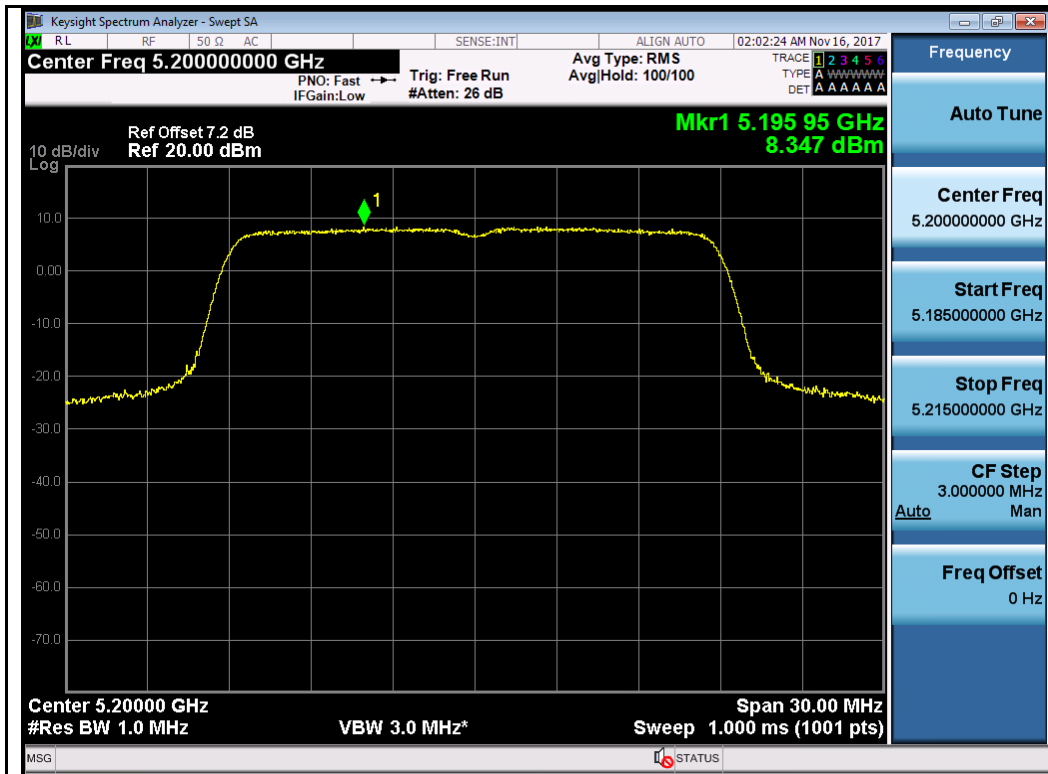

802.11n-HT20-5200MHz

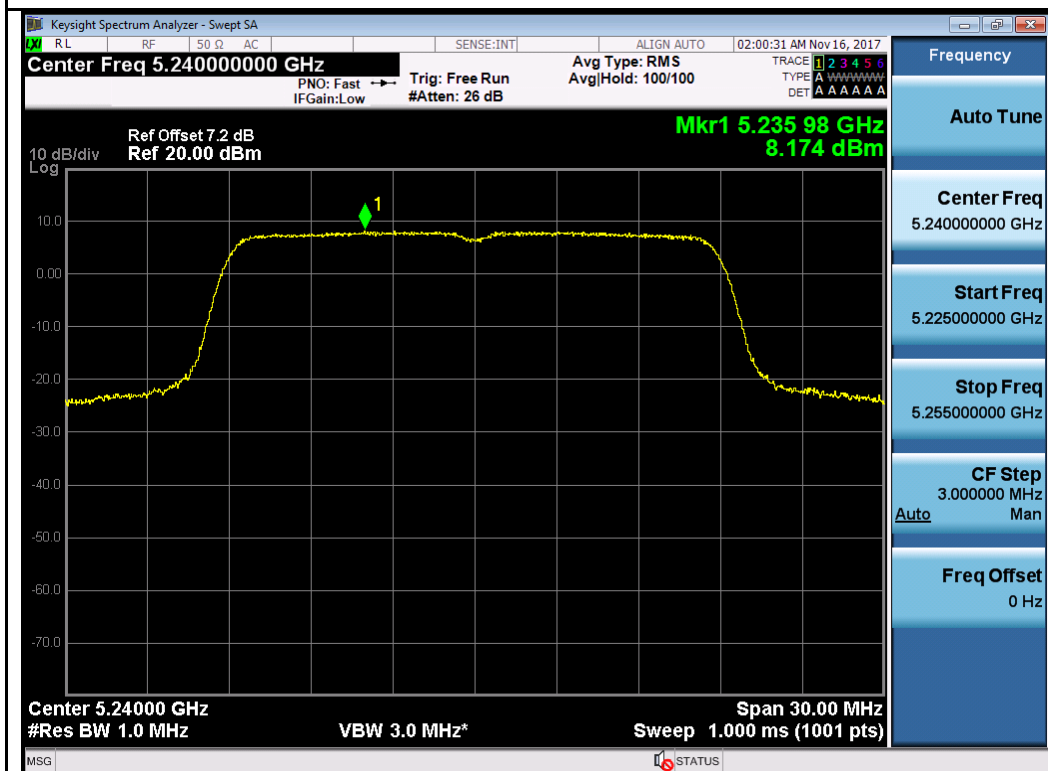

802.11n-HT20-5240MHz

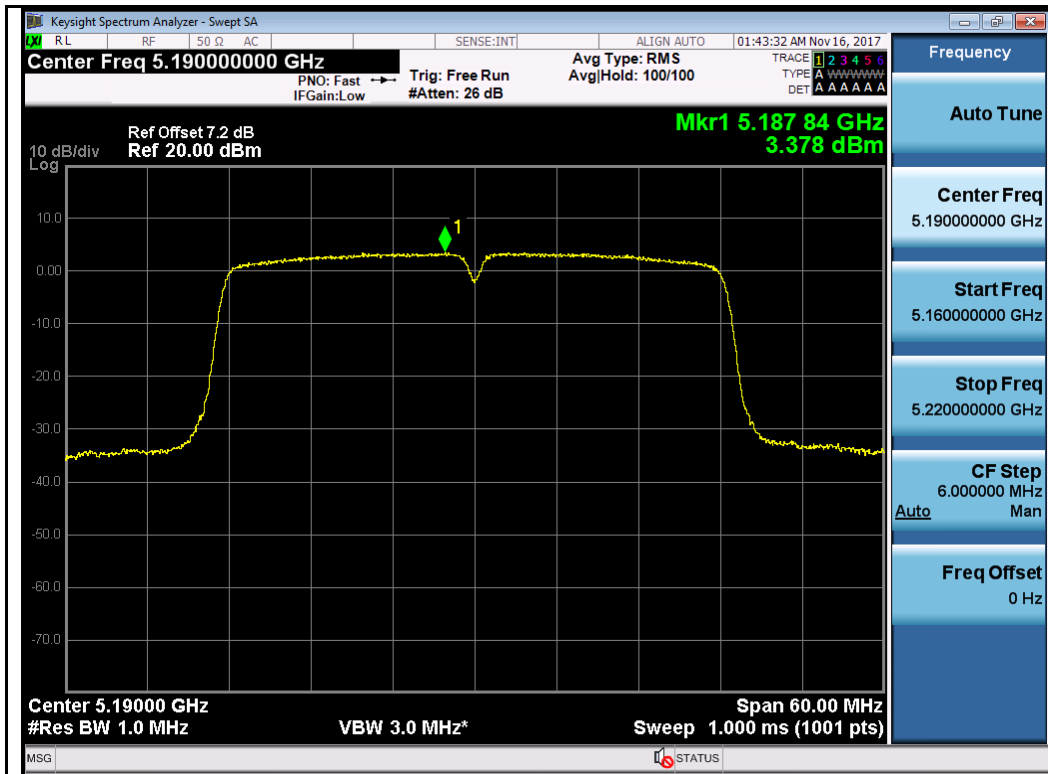

802.11n-HT40-5190MHz

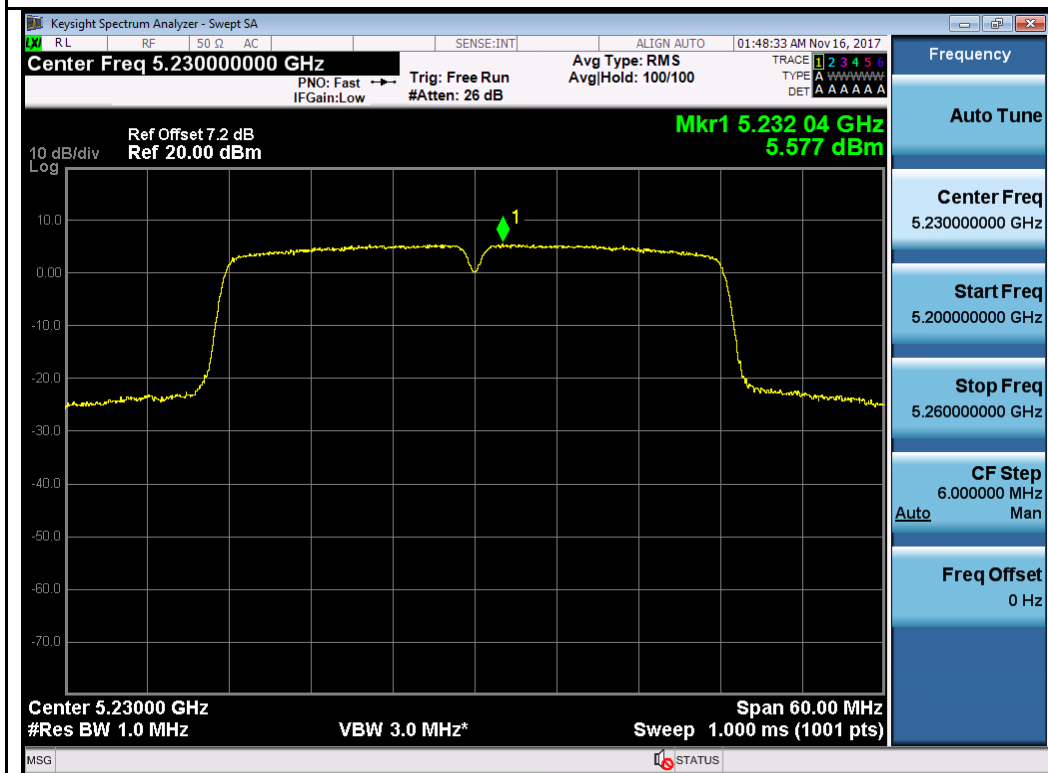

802.11n-HT40-5230MHz

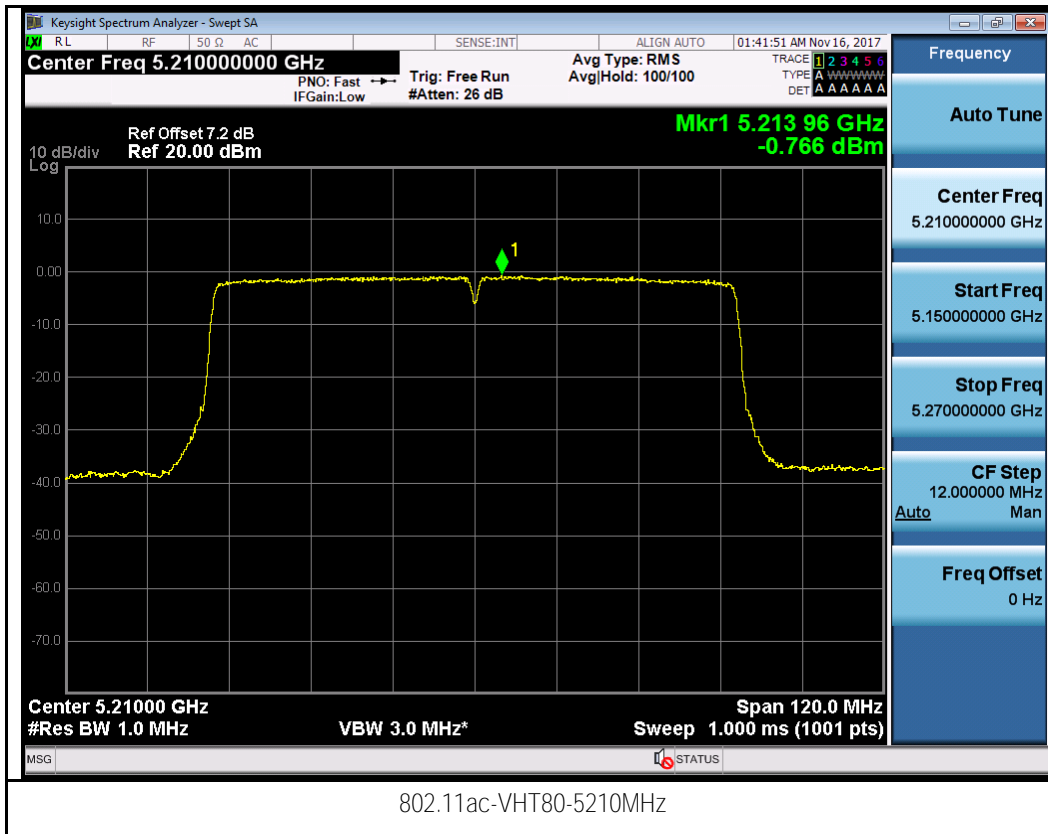

Test Plot for W58:

Chain 0:

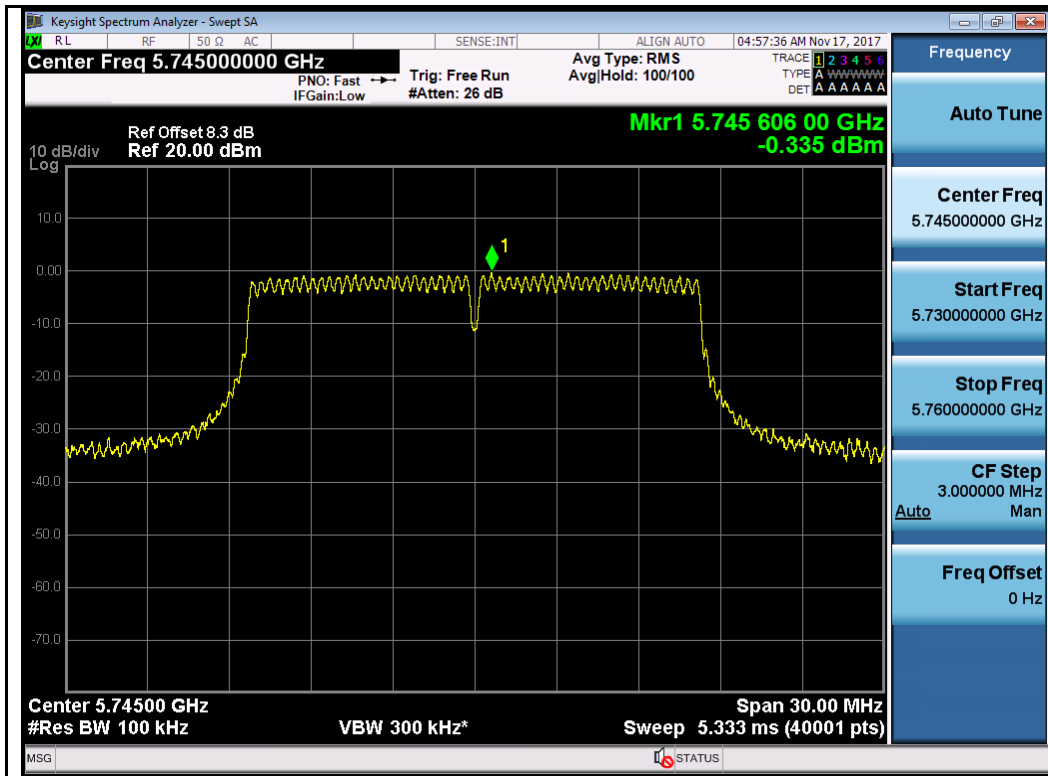

802.11a-5745MHz

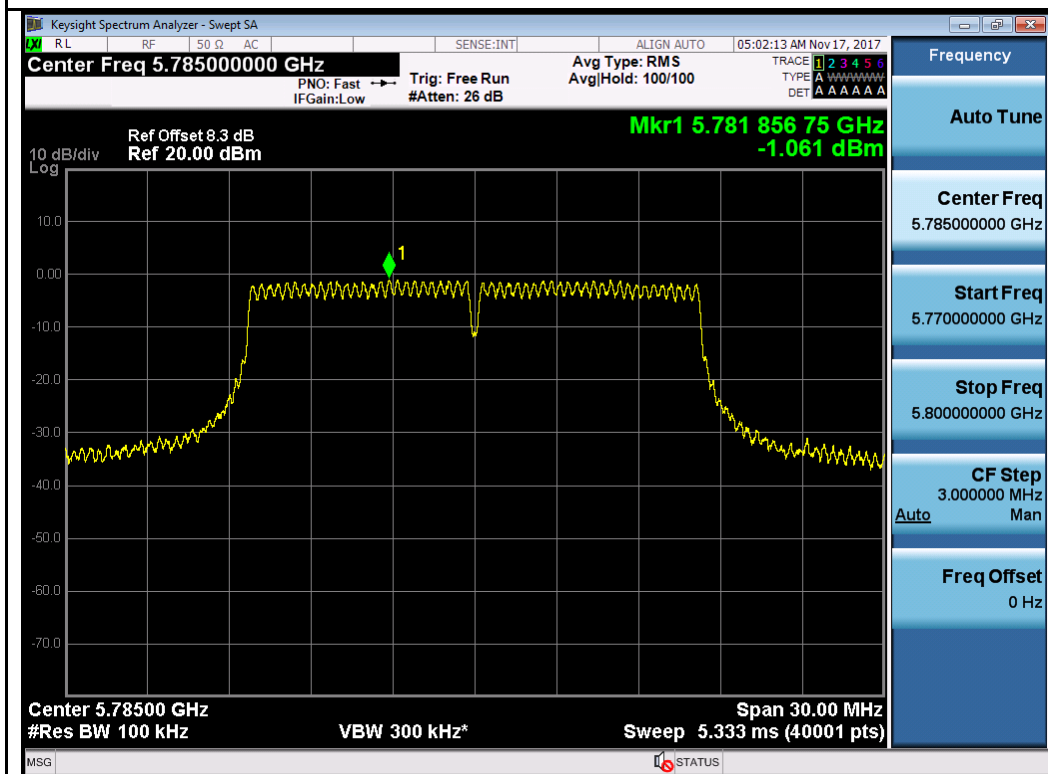

802.11a-5785MHz

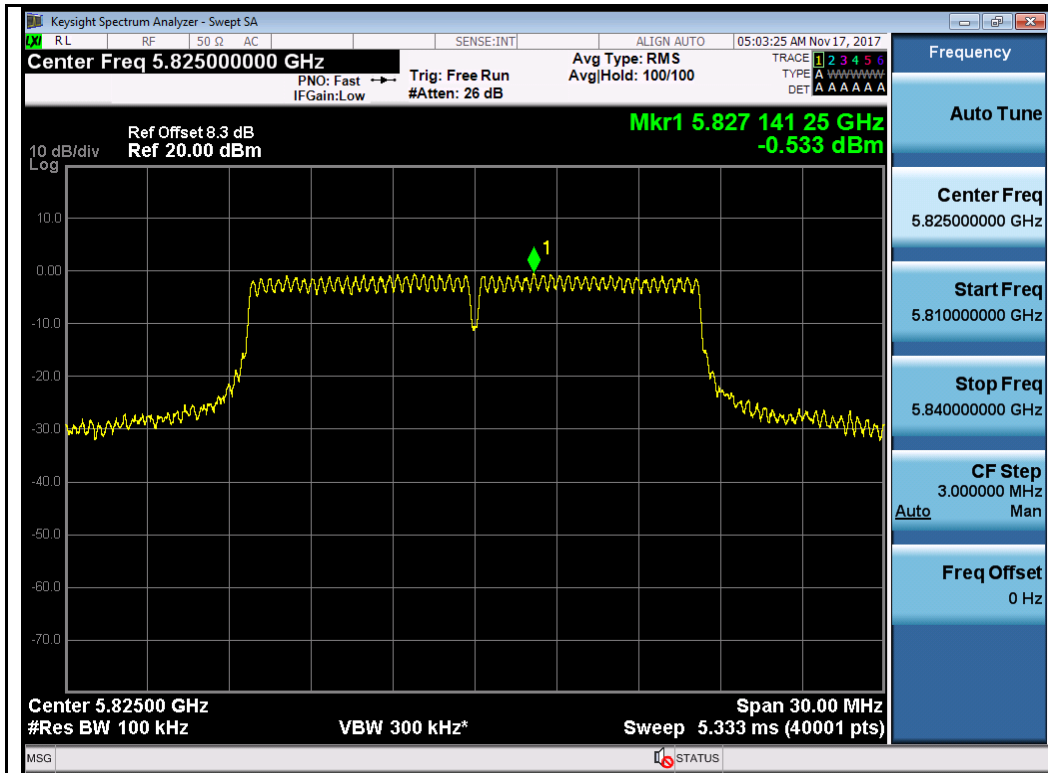

802.11a-5825MHz

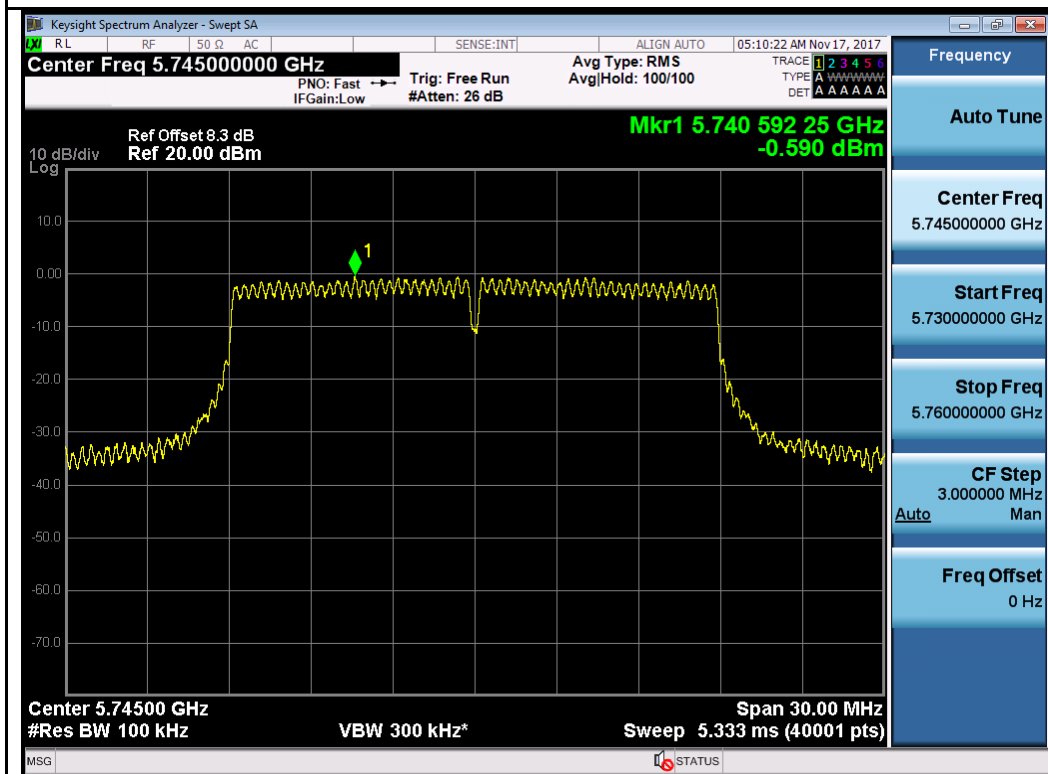

802.11n-HT20-5745MHz

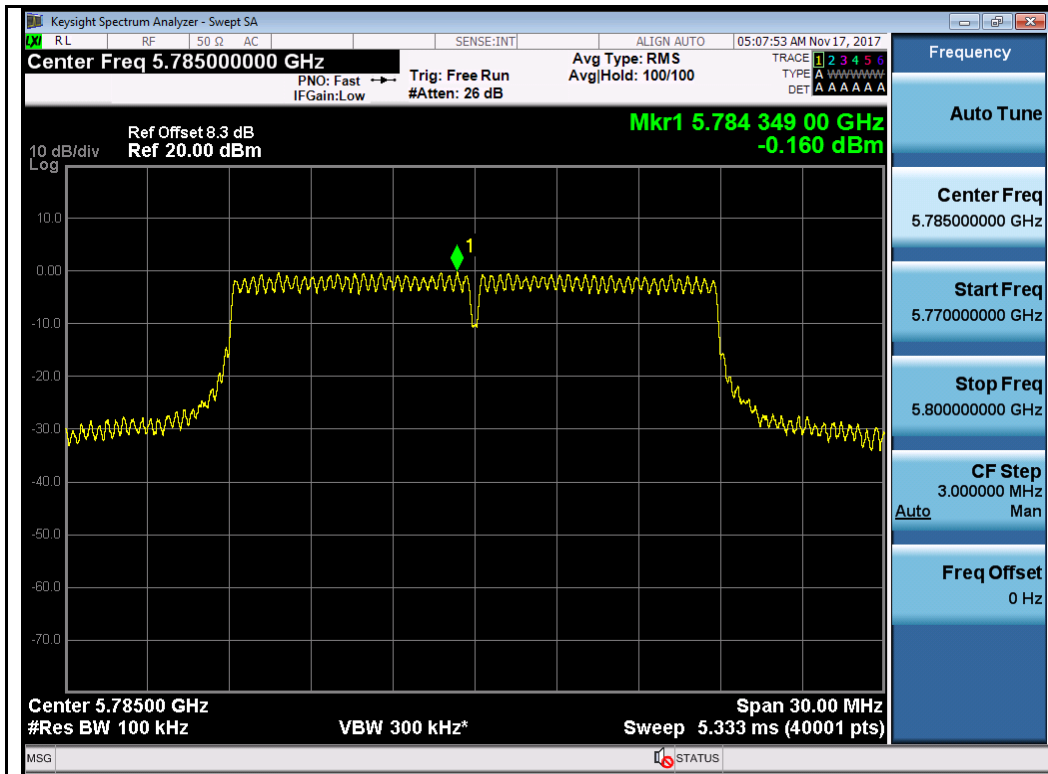

802.11n-HT20-5785MHz

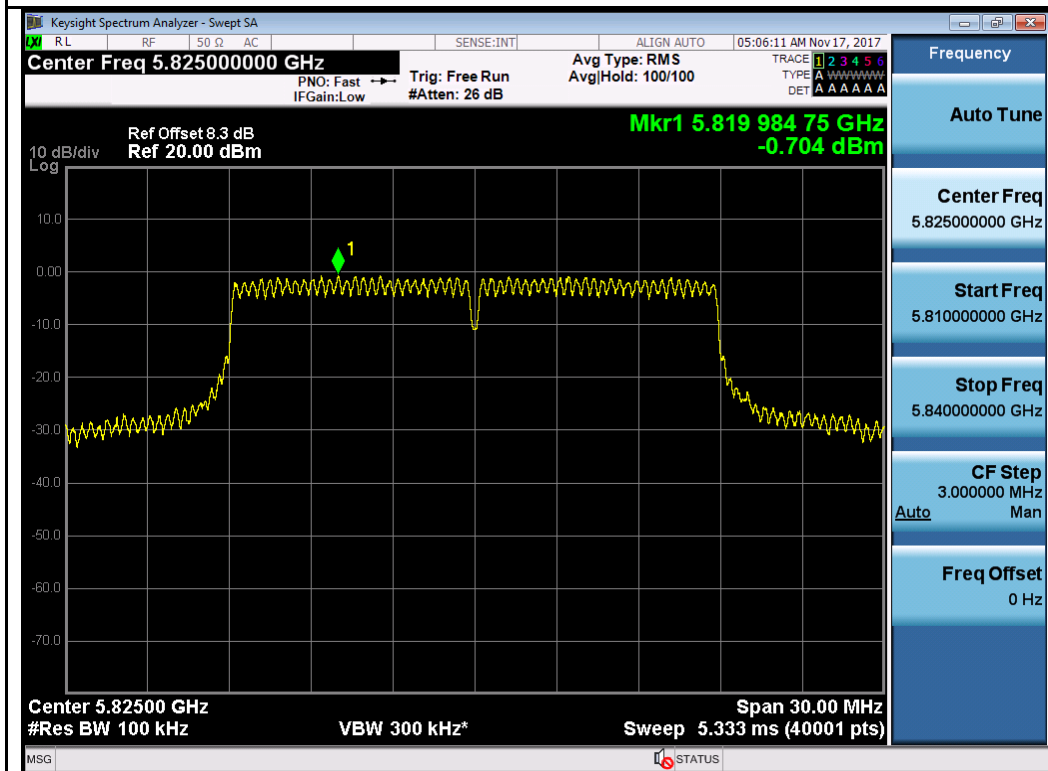

802.11n-HT20-5825MHz

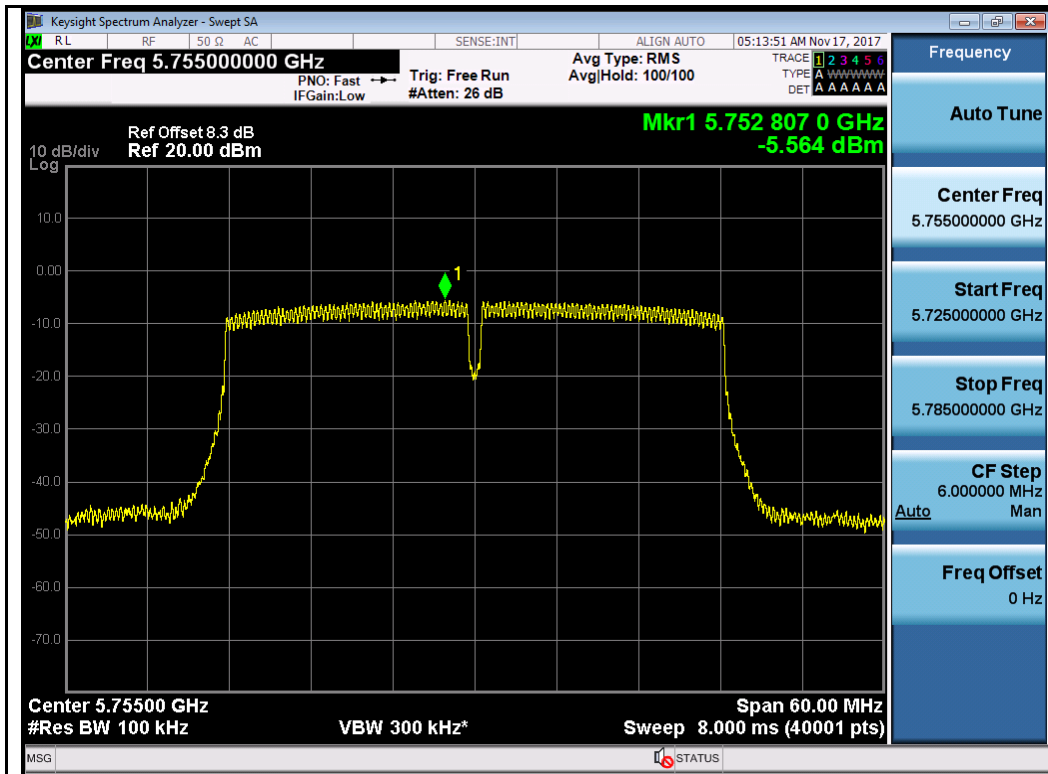

802.11n-HT40-5755MHz

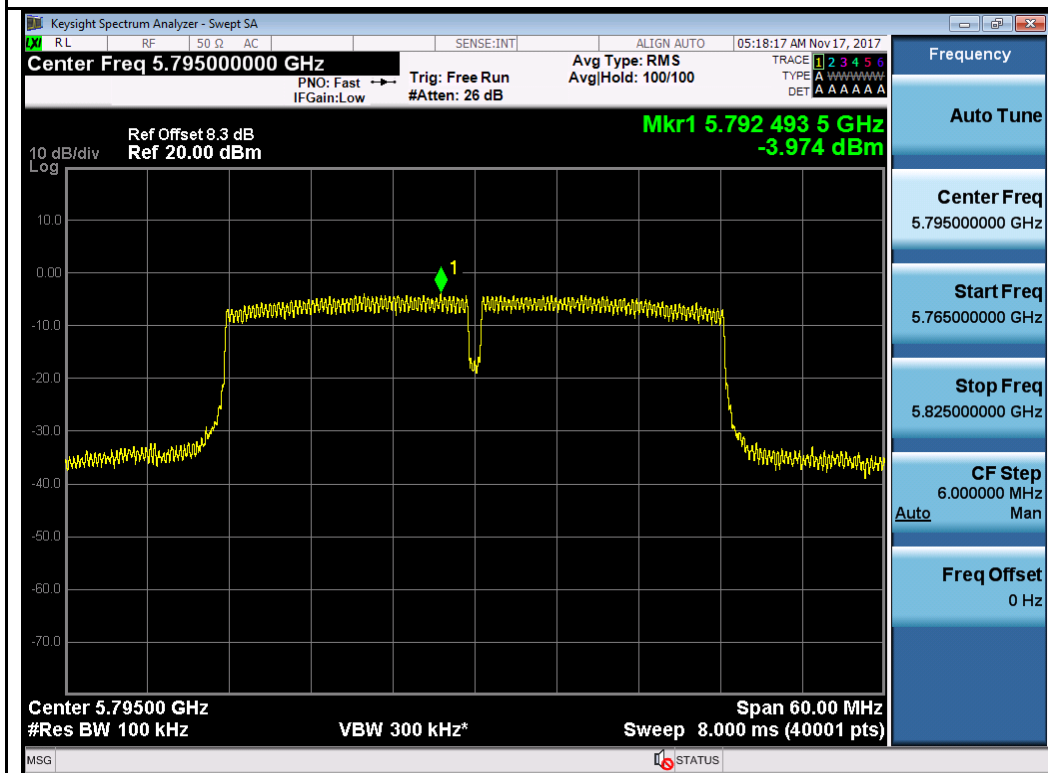

802.11n-HT40-5795MHz

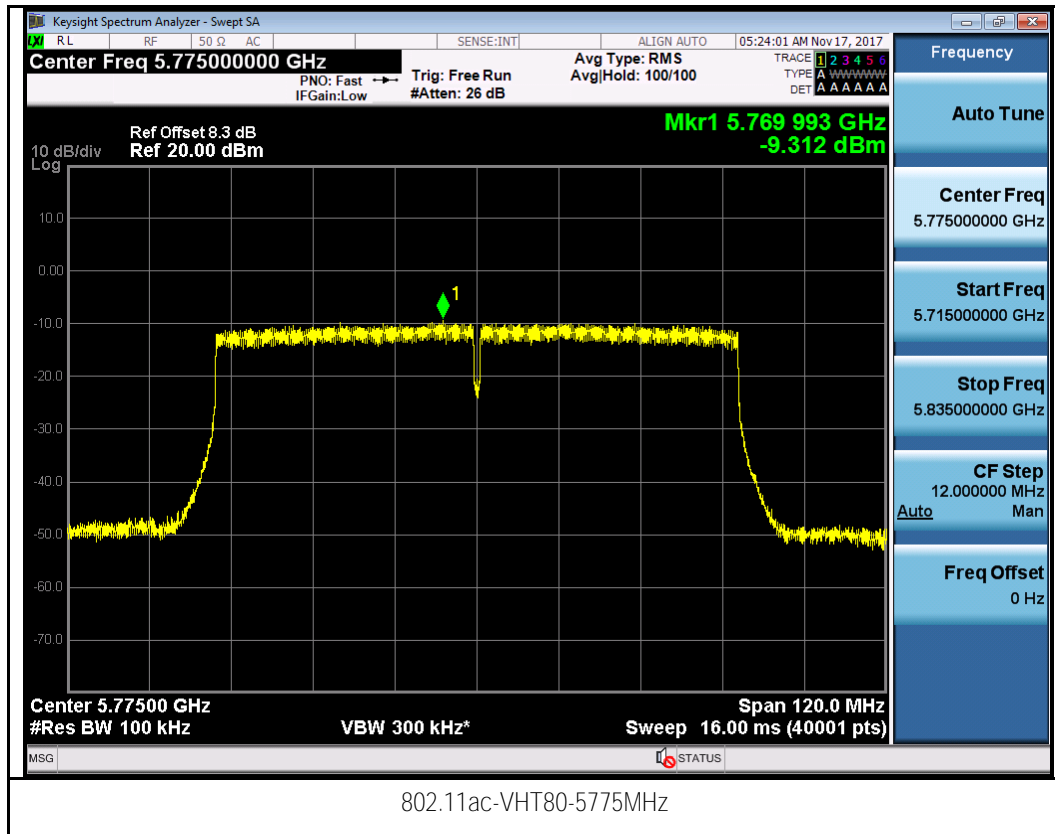

Chain 1:

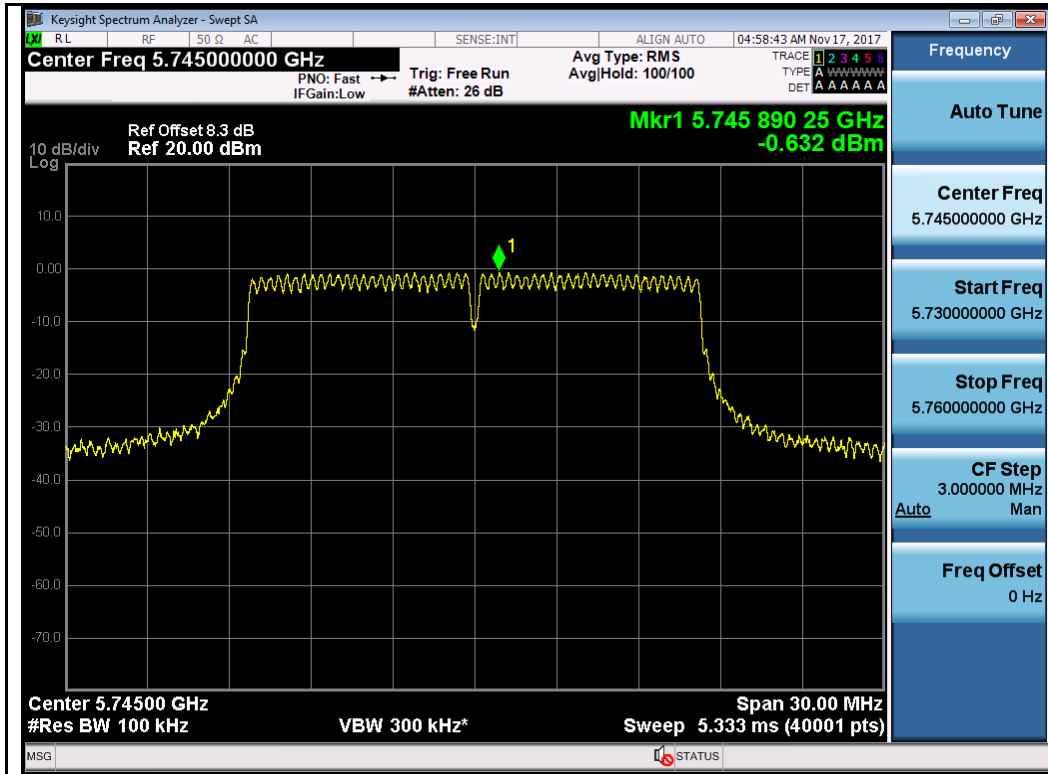

802.11a-5745MHz

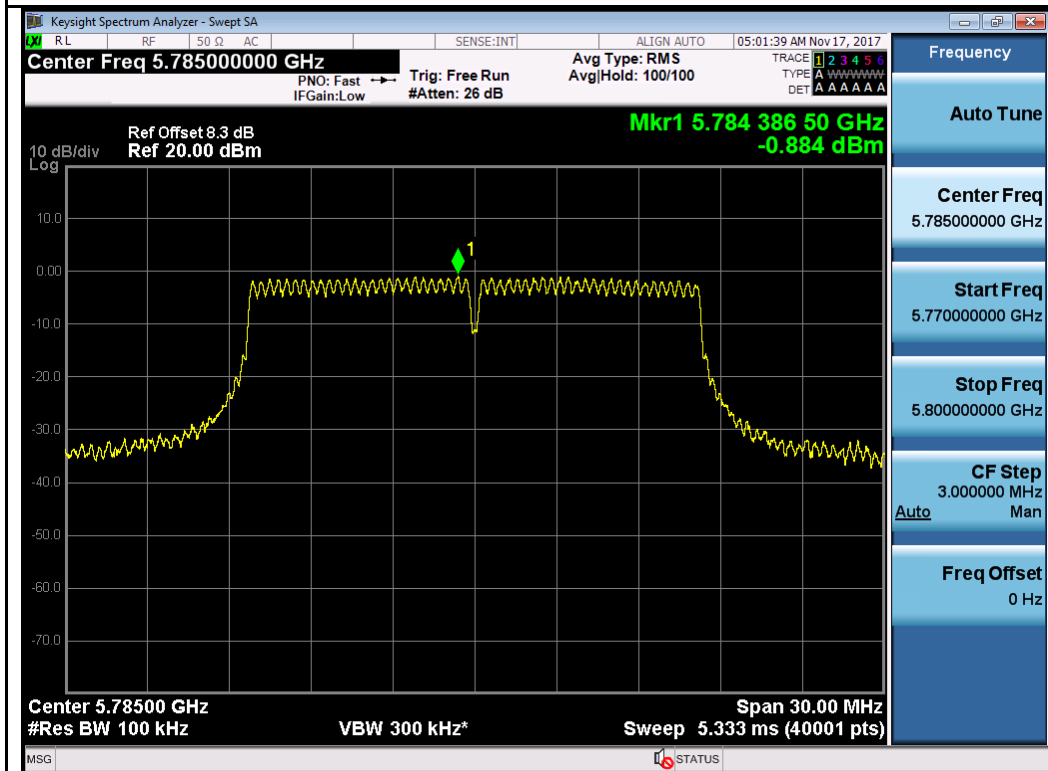

802.11a-5785MHz

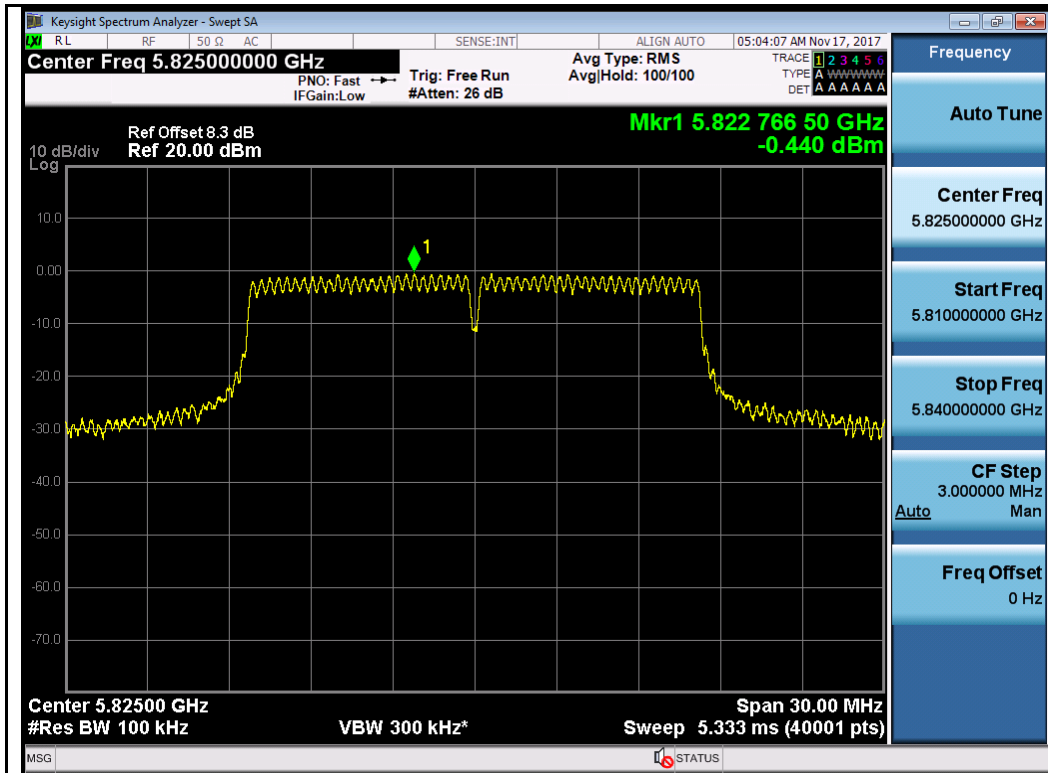

802.11a-5825MHz

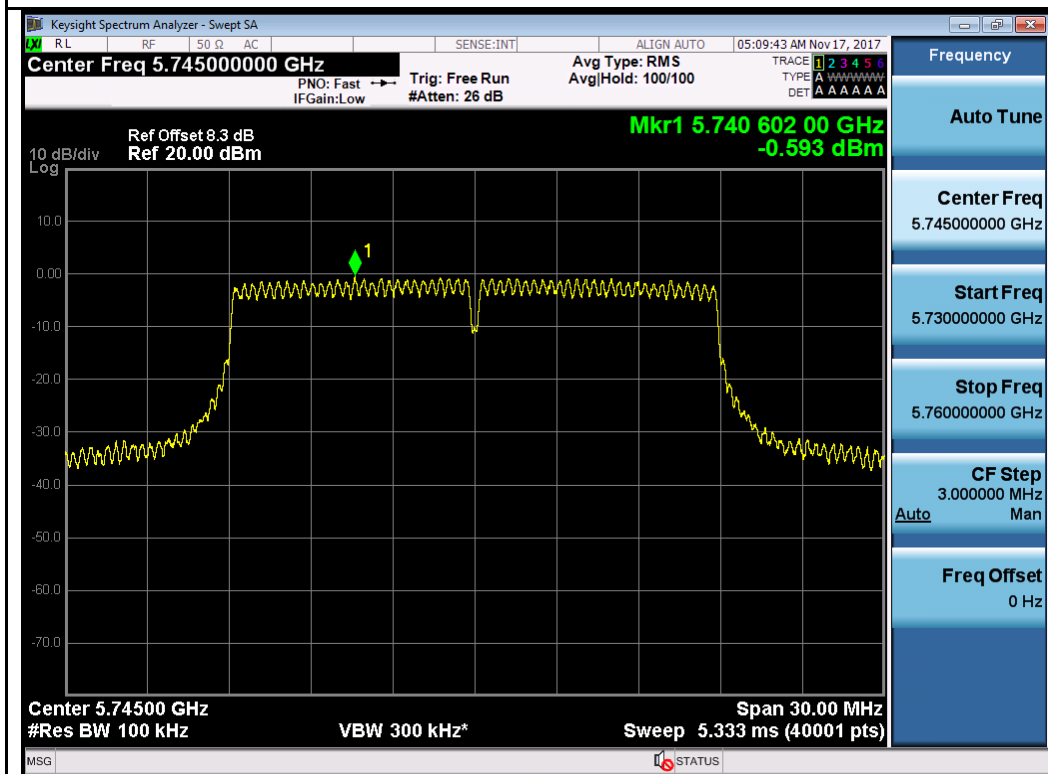

802.11n-HT20-5745MHz

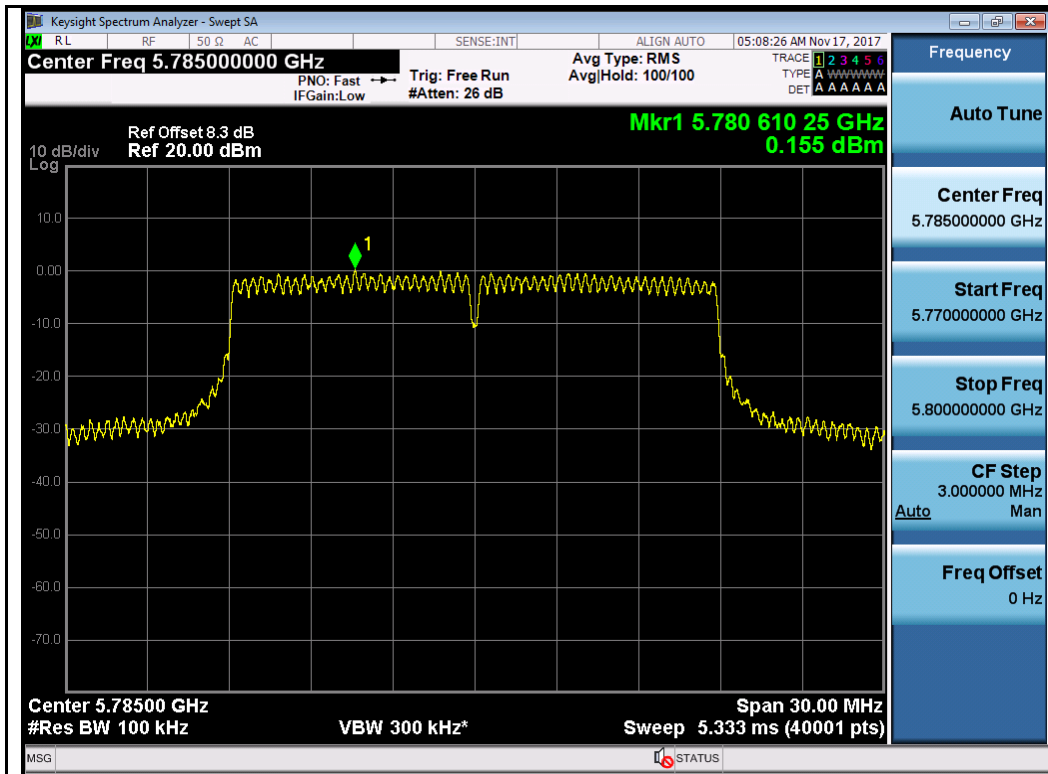

802.11n-HT20-5785MHz

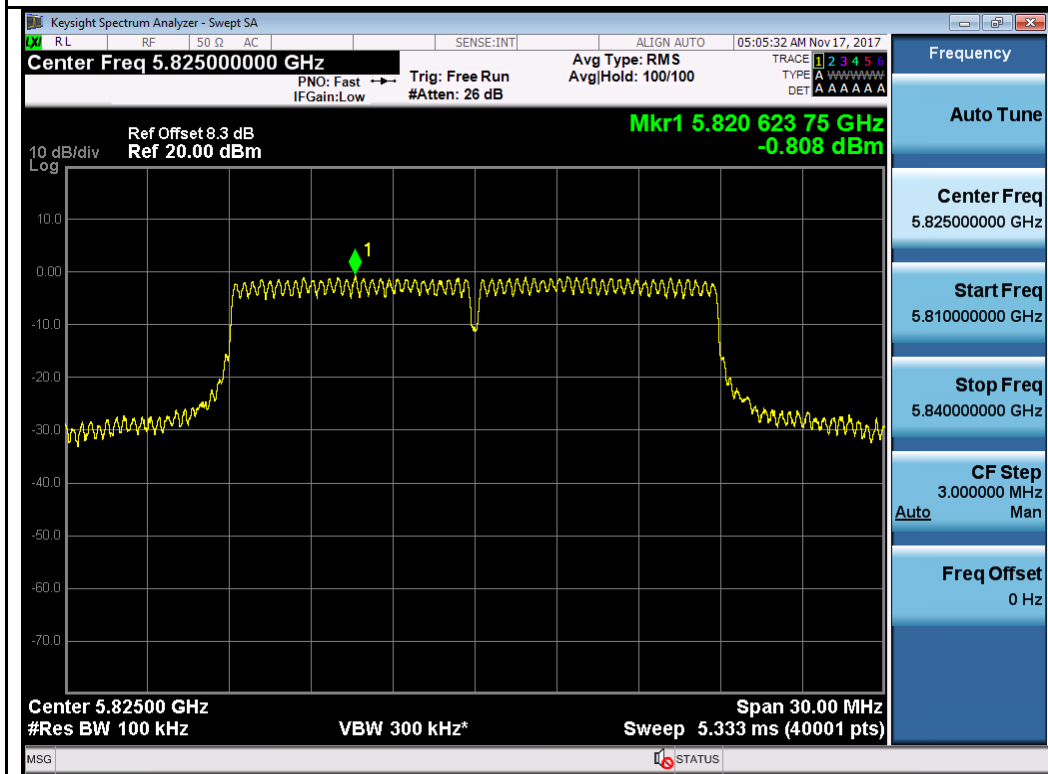

802.11n-HT20-5825MHz

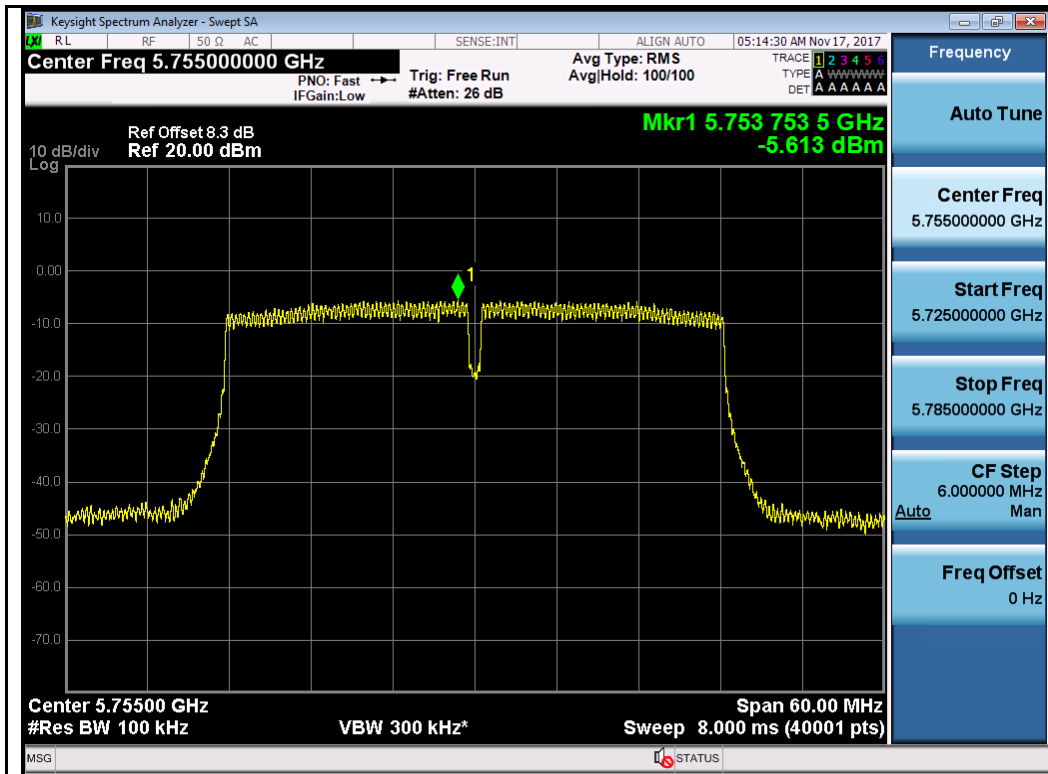

802.11n-HT40-5755MHz

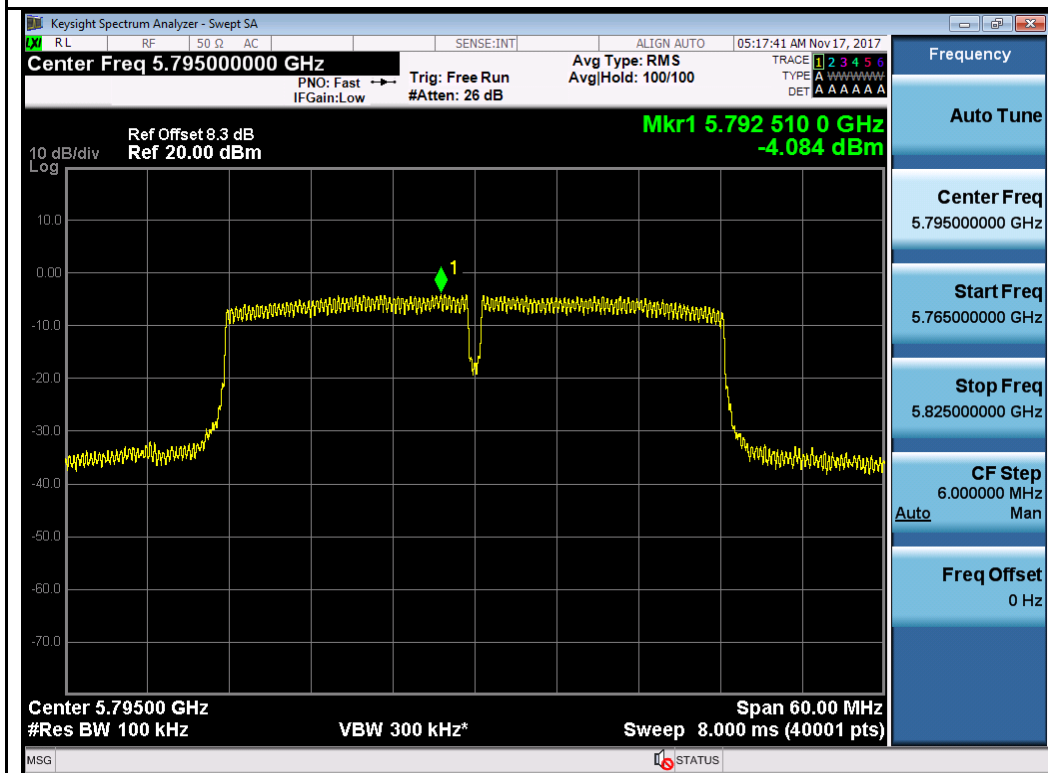

802.11n-HT40-5795MHz

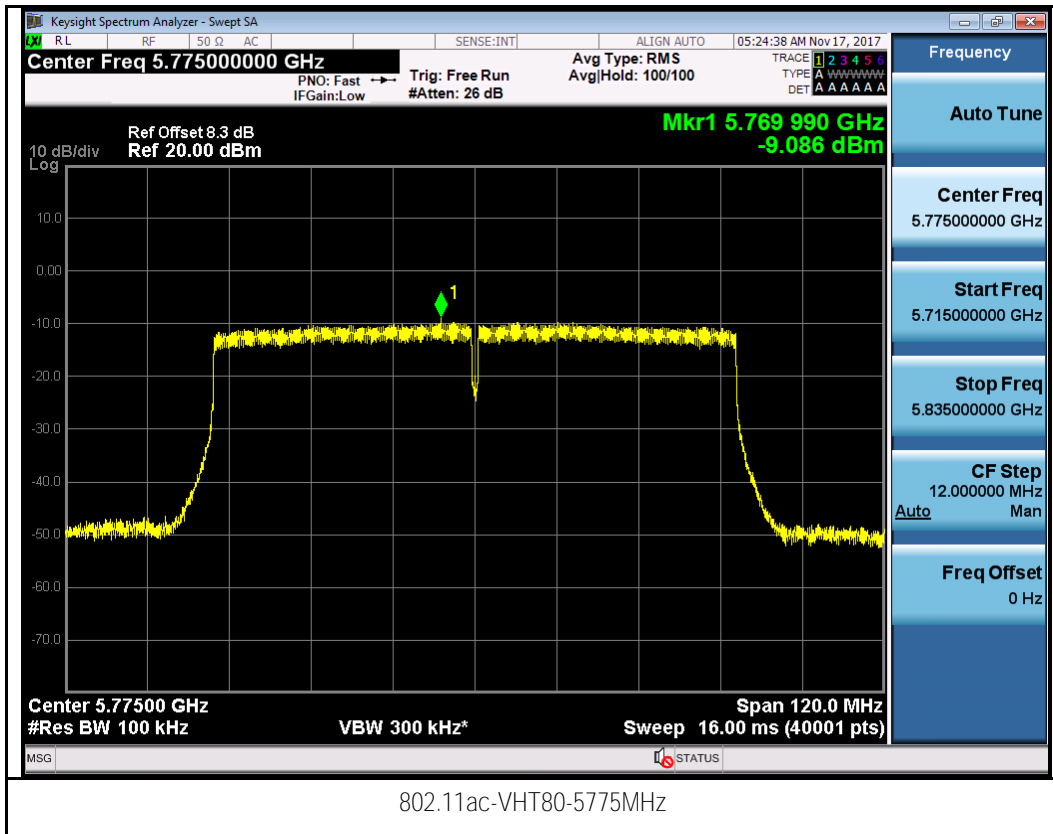

T310S Beamforming Mode
Test Plot for W52:
Chain 0:

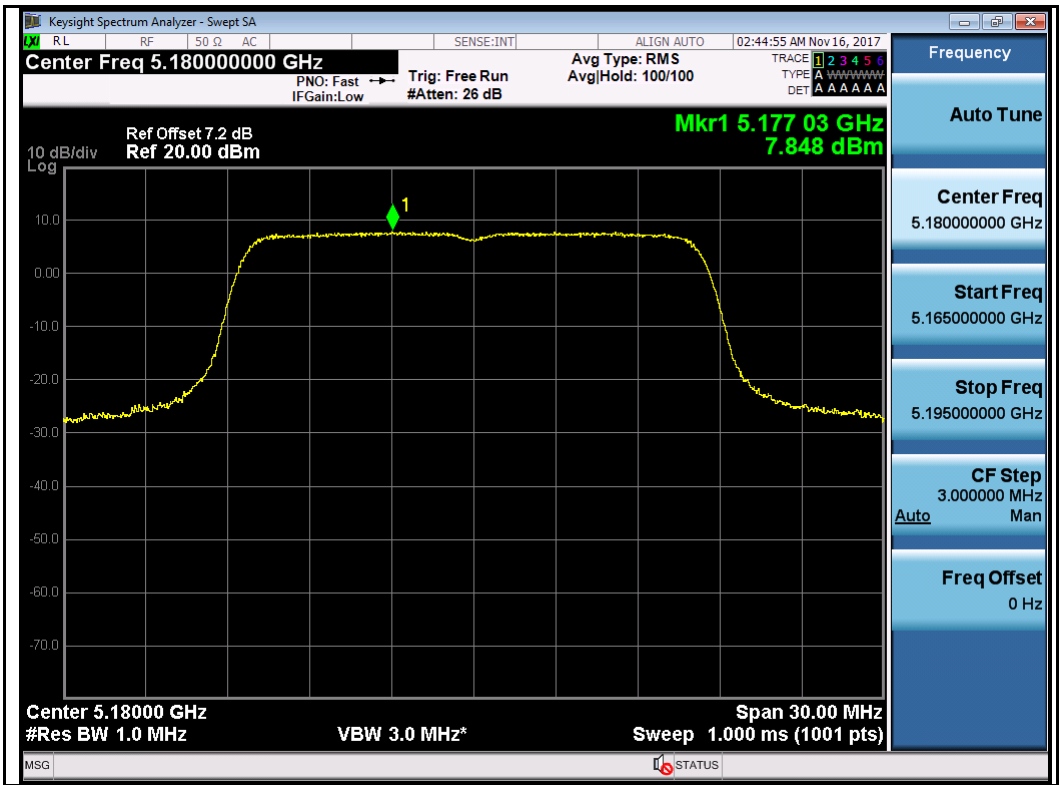

802.11a-5180MHz

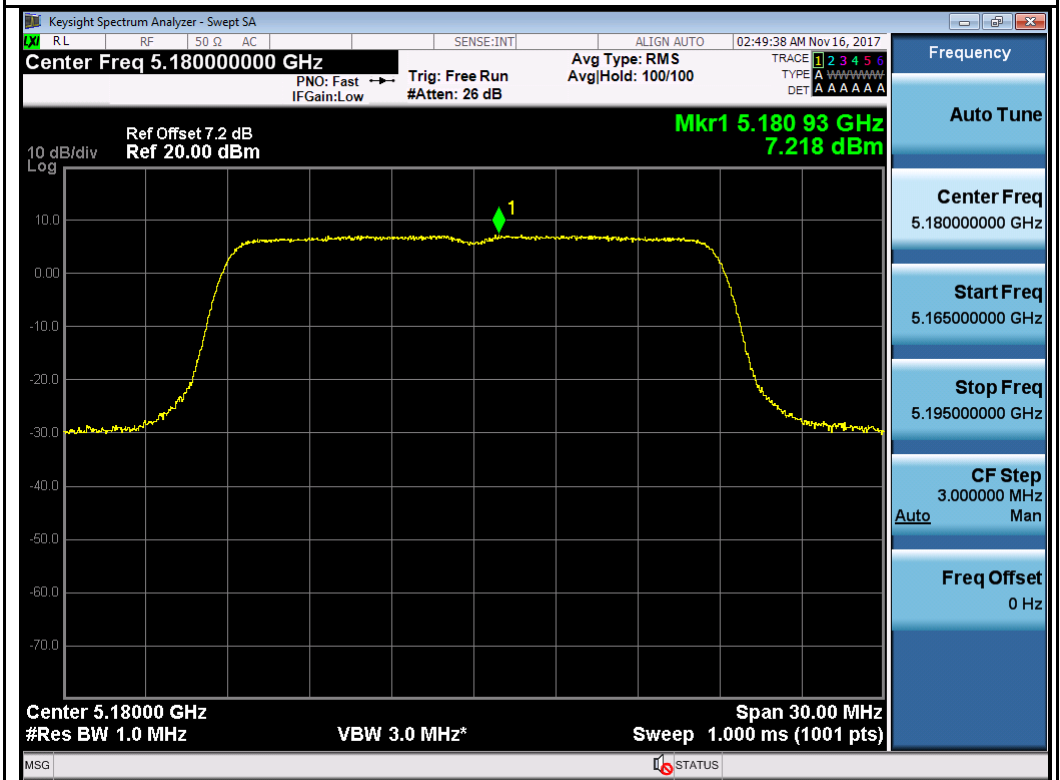

802.11n-HT20-5180MHz

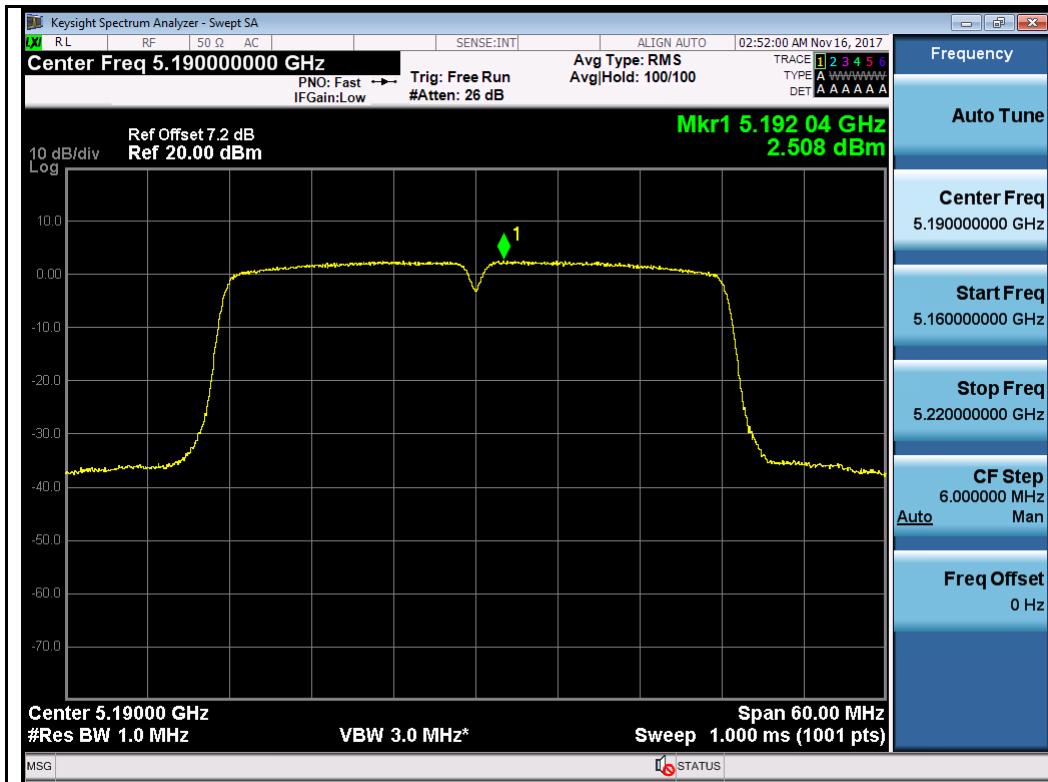

802.11n-HT40-5190MHz

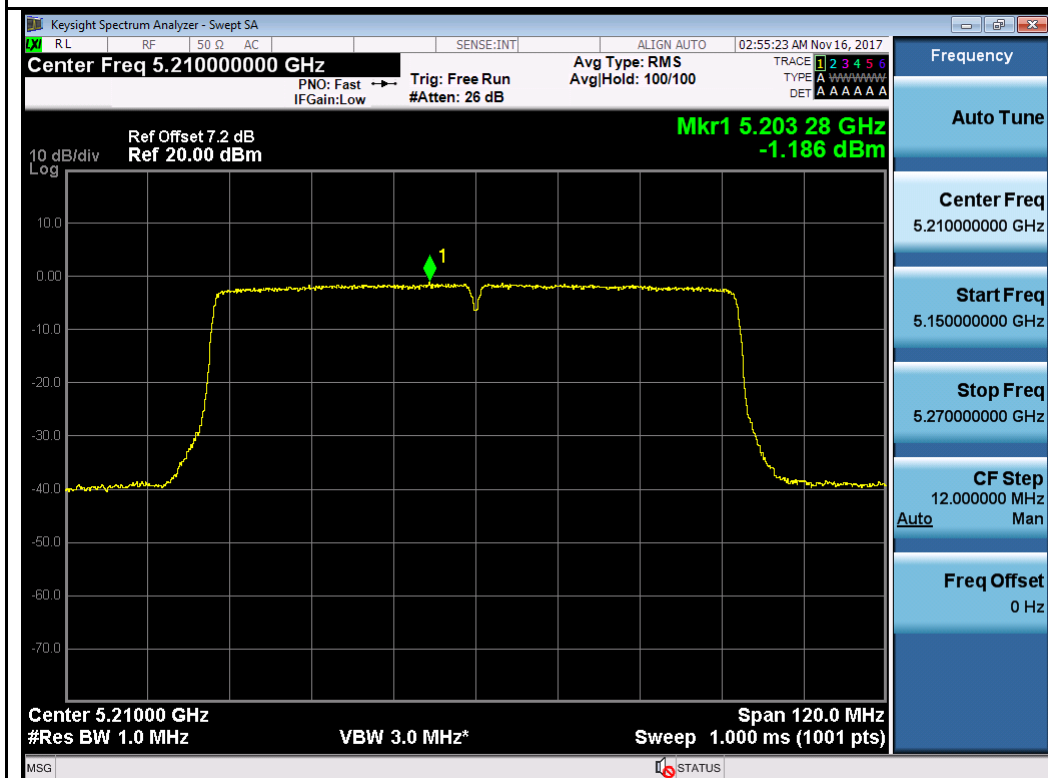

802.11ac-VHT80-5210MHz

Chain 1:

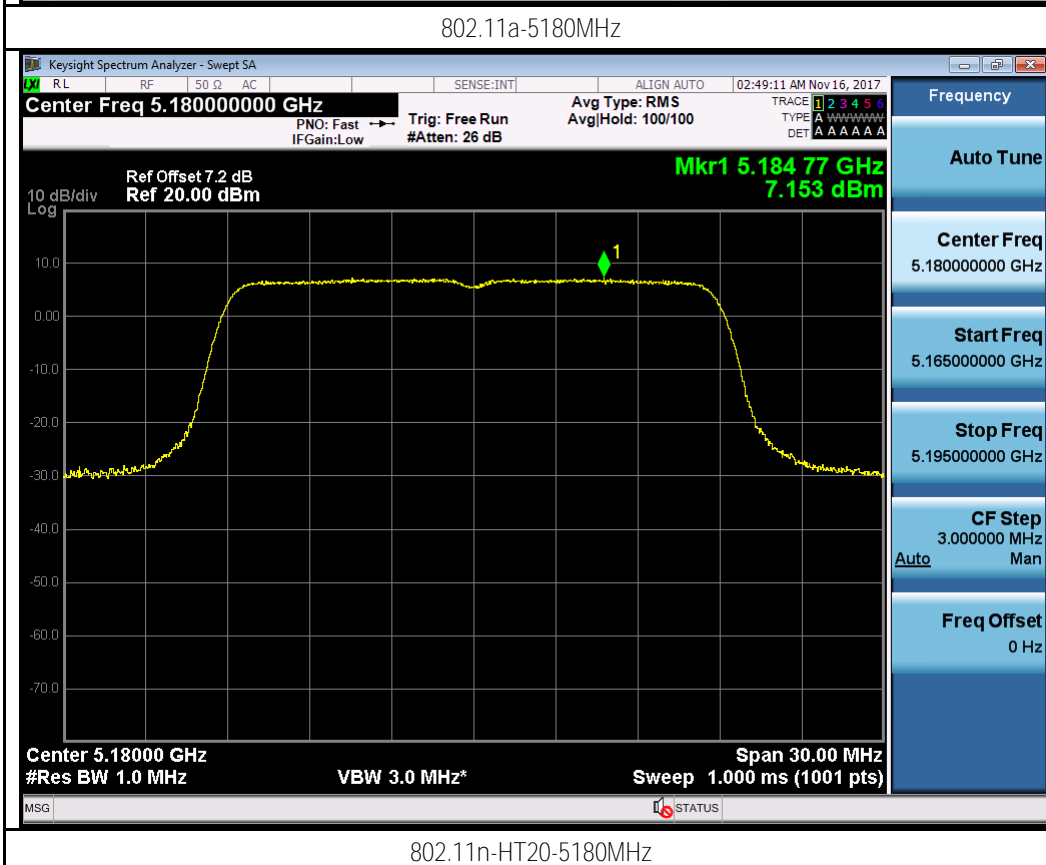
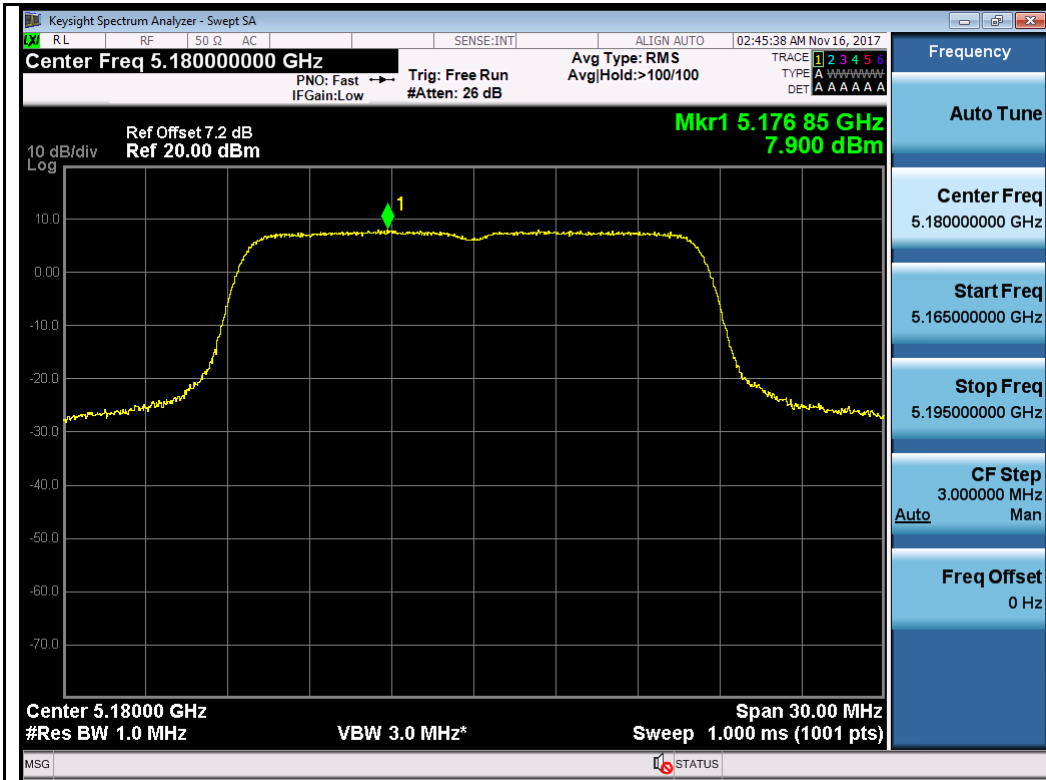

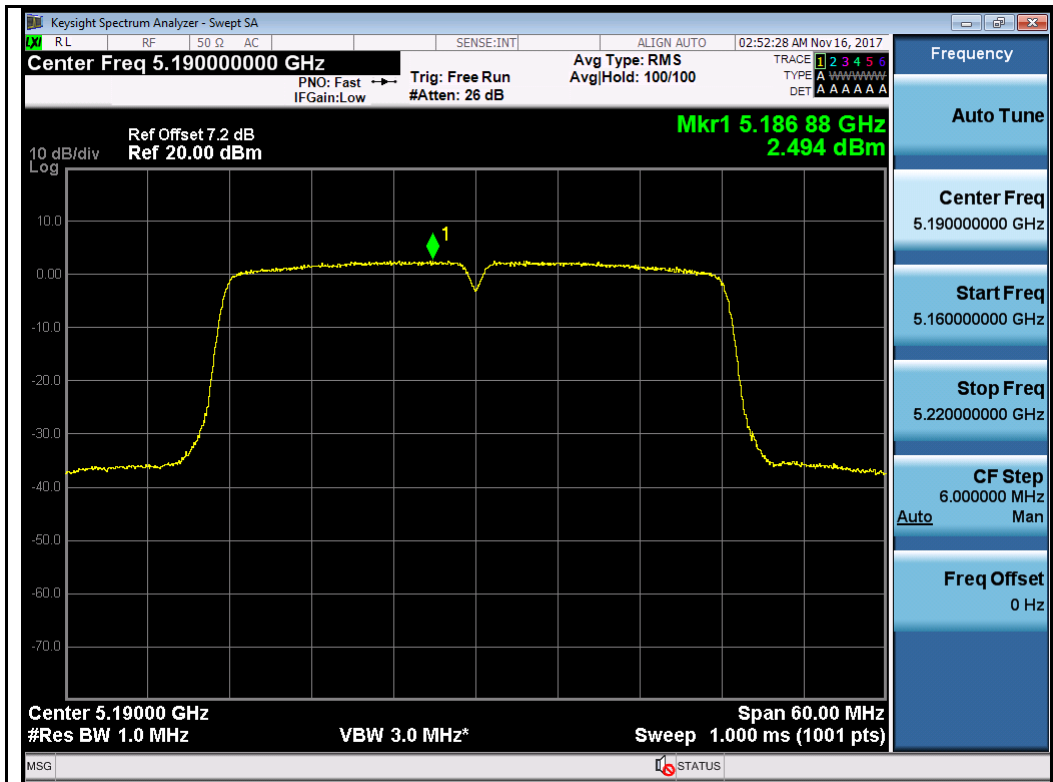

802.11n-HT40-5190MHz

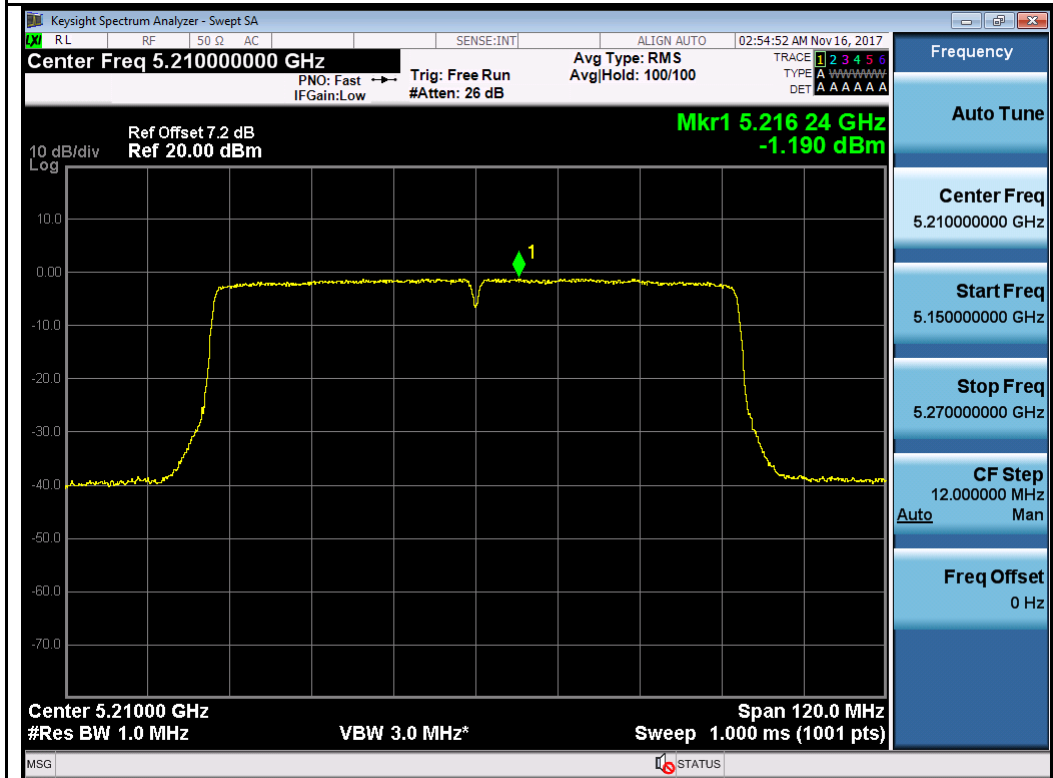

802.11ac-VHT80-5210MHz

Note: T310S power setting for Beamforming and Non-Beamforming modes just list 4 channels is different, other channels are same.

10.6 Band Edge and Emission Mask Measurement

Requirement(s):

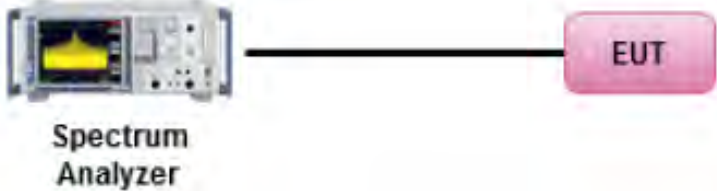
Spec	Item	Requirement	Applicable
47CFR§ 15.407(b)(2), 15.407(b)(6)	(1)	For transmitters operating in the 5.15-5.25 GHz band: all emissions outside of the 5.15-5.35 GHz band shall not exceed an EIRP of -27 dBm/MHz.	<input checked="" type="checkbox"/>
	(4)	For transmitters operating in the 5.725-5.825 GHz band: all emissions shall be limited to a level of -27 dBm/MHz at 75 MHz or more above or below the band edge increasing linearly to 10 dBm/MHz at 25 MHz above or below the band edge, and from 25 MHz above or below the band edge increasing linearly to a level of 15.6 dBm/MHz at 5 MHz above or below the band edge, and from 5 MHz above or below the band edge increasing linearly to a level of 27 dBm/MHz at the band edge.	<input checked="" type="checkbox"/>
Test Setup	 <p>The diagram shows a Spectrum Analyzer on the left connected by a black line to a pink box labeled 'EUT' on the right.</p>		
Procedure	<p>789033 D02 General UNII Test Procedures New Rules v01r02, II.F. Method SA-1</p> <p><u>Band Edge measurement:</u></p> <ul style="list-style-type: none"> - For average emissions measurements, follow the procedures described in section II.G.6., "Procedures for Average Unwanted Emissions Measurements above 1000 MHz", except for the following changes: - Set RBW=100kHz - Set VBW=300kHz - Perform a band-power integration across the 1 MHz bandwidth in which the band-edge emission level is to be measured. 		
Remark	Directional antenna gain was added to the offset.		
Result	<input checked="" type="checkbox"/> Pass <input type="checkbox"/> Fail		

Test Data Yes (See below) N/A

Test Plot Yes (See below) N/A

Test was done by Cipher at RF test site.

T310N
Test Plot for W52:
Chain 0:

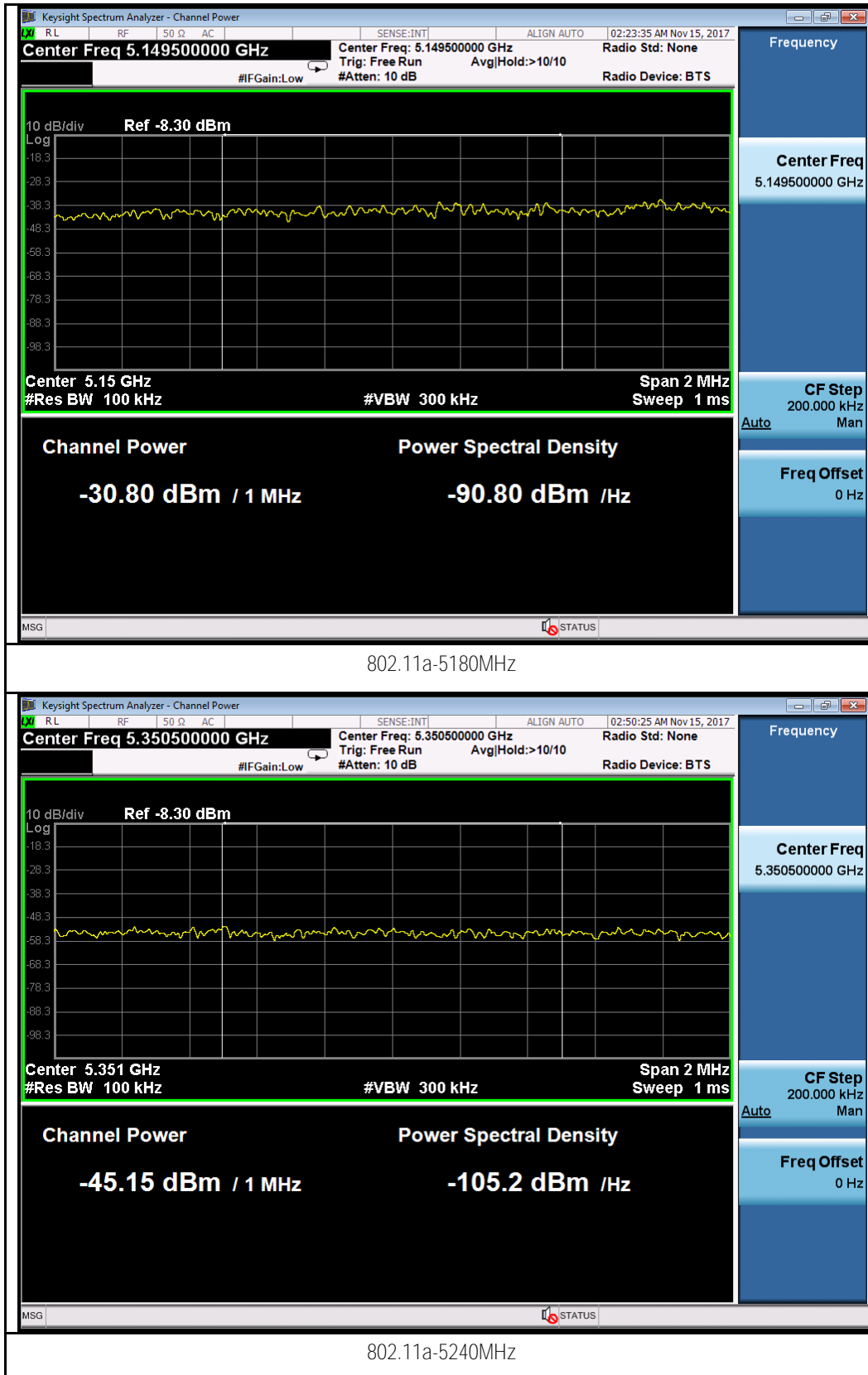

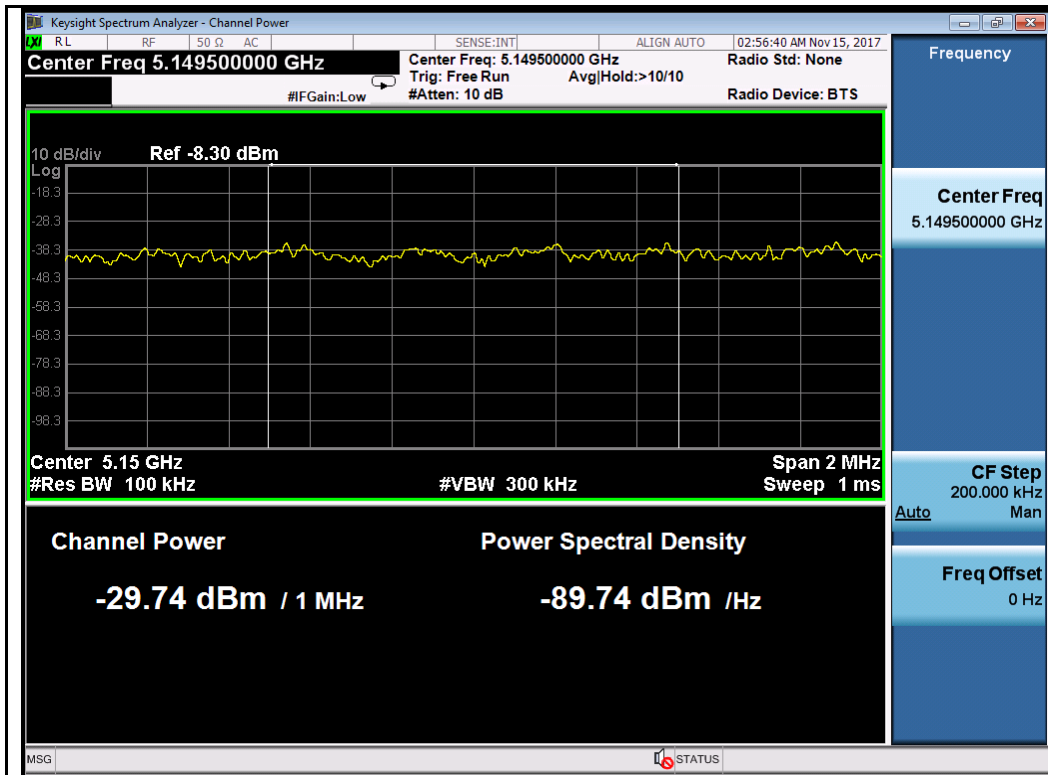

802.11n-HT20-5180MHz

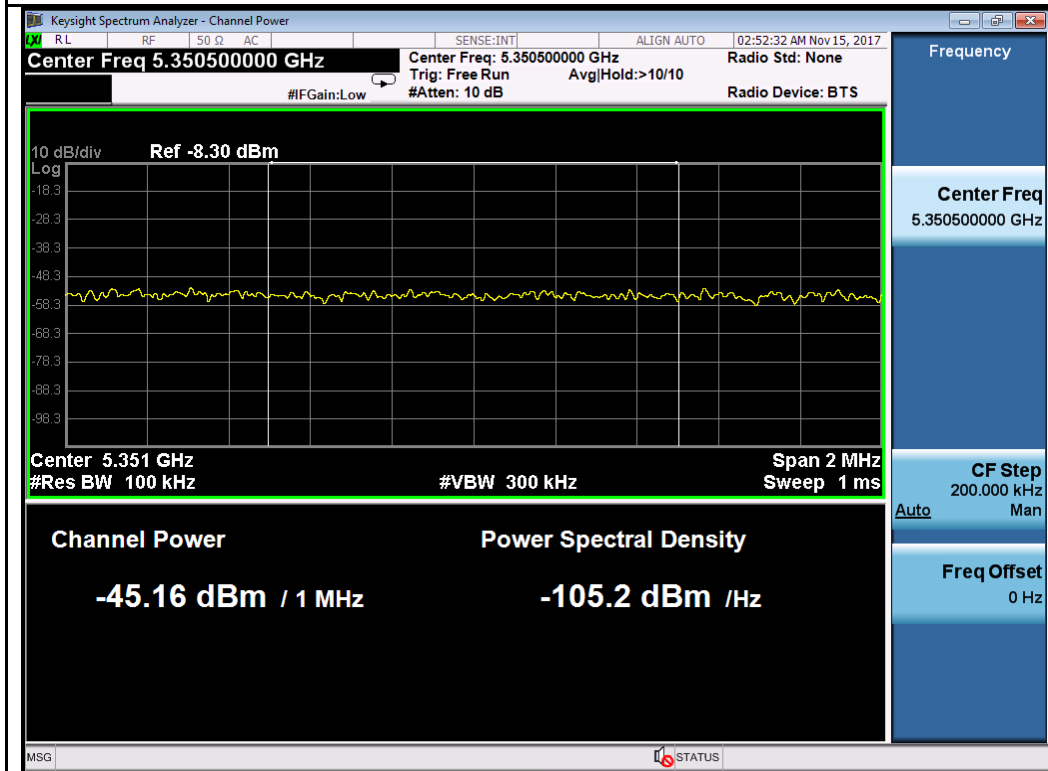

802.11n-HT20-5240MHz

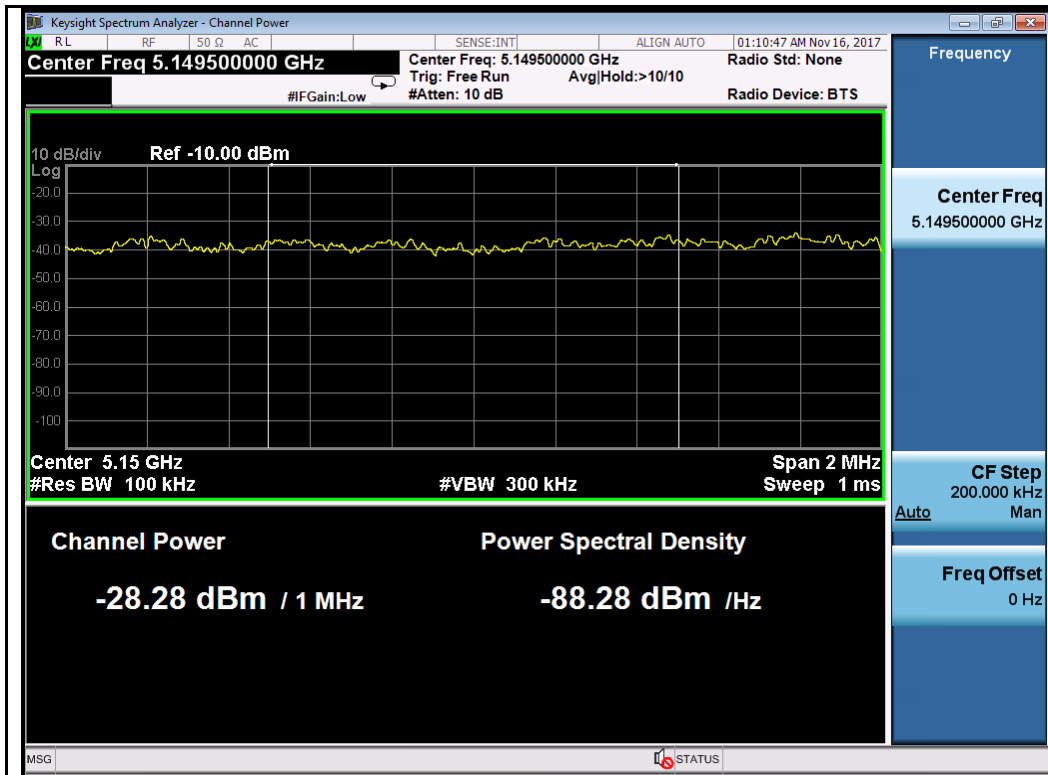

802.11n-HT40-5190MHz

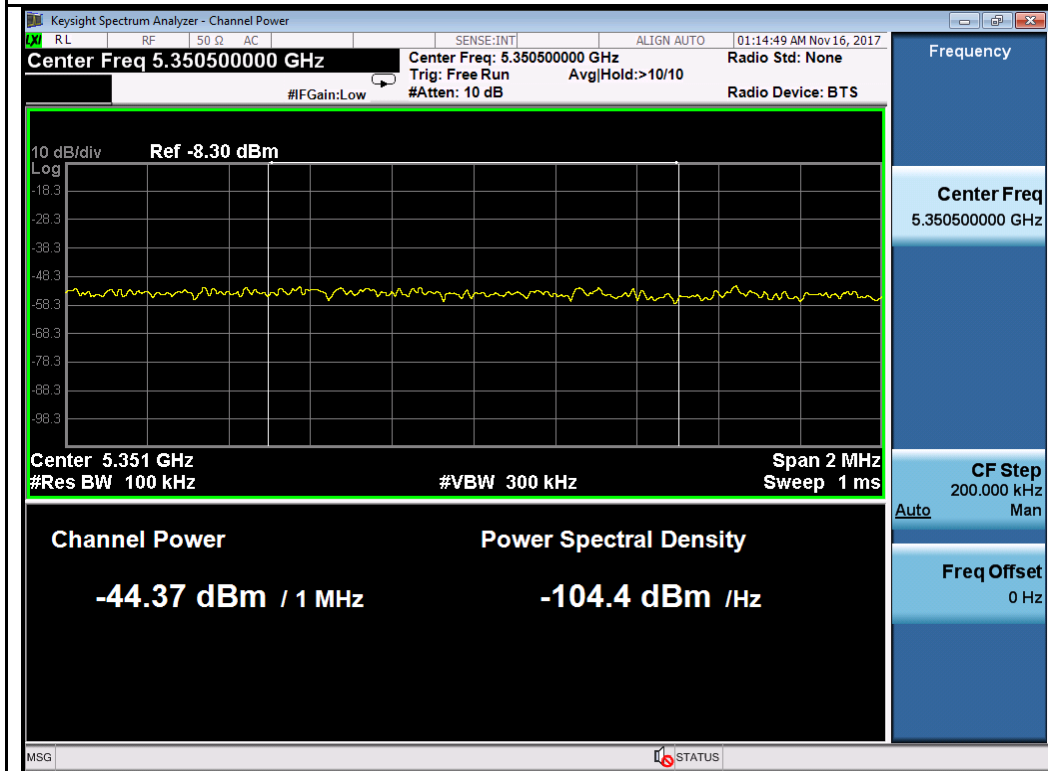

802.11n-HT40-5230MHz

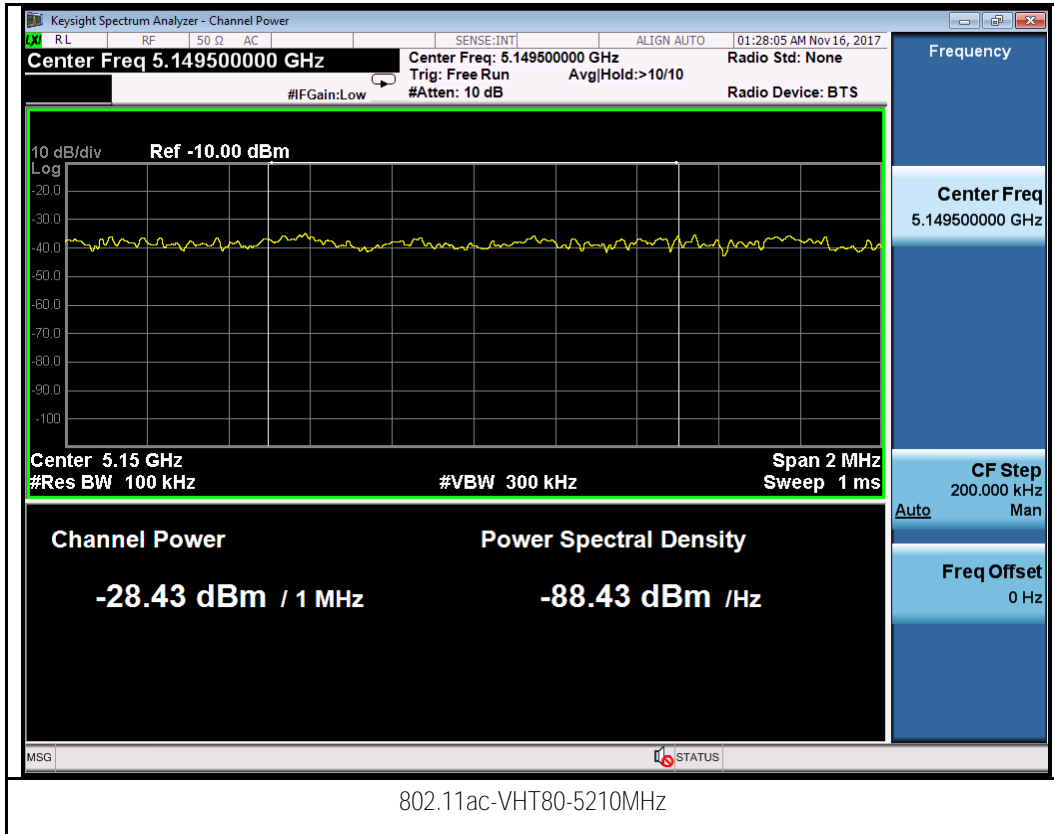

Chain 1:

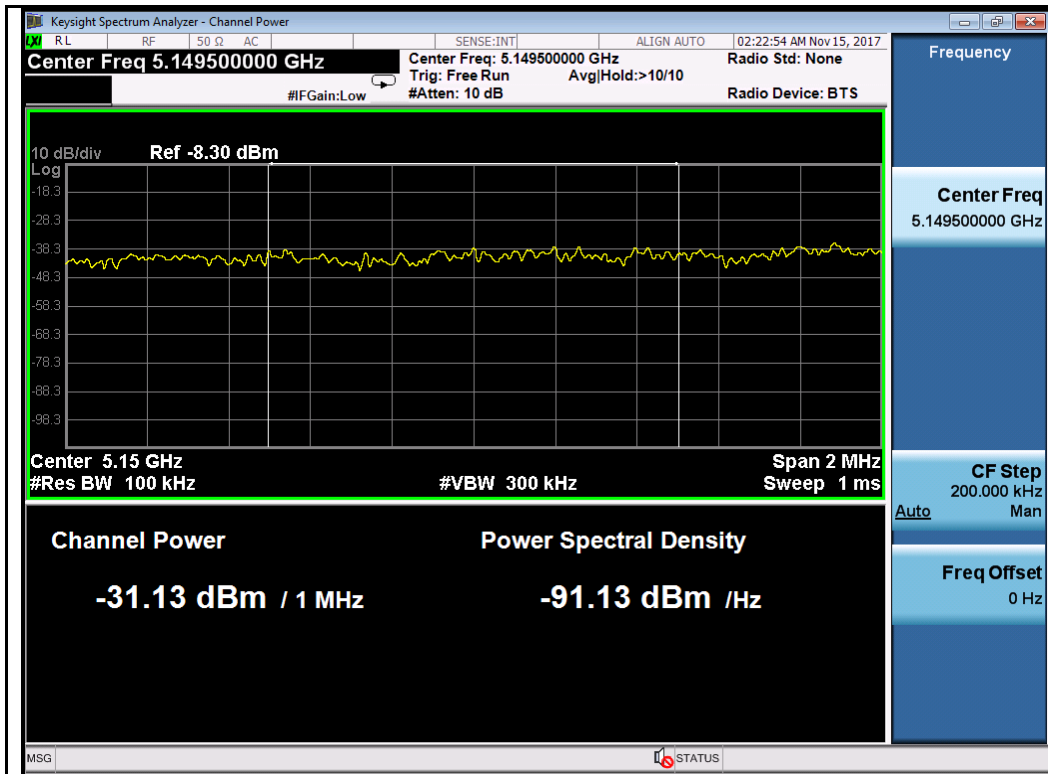

802.11a-5180MHz

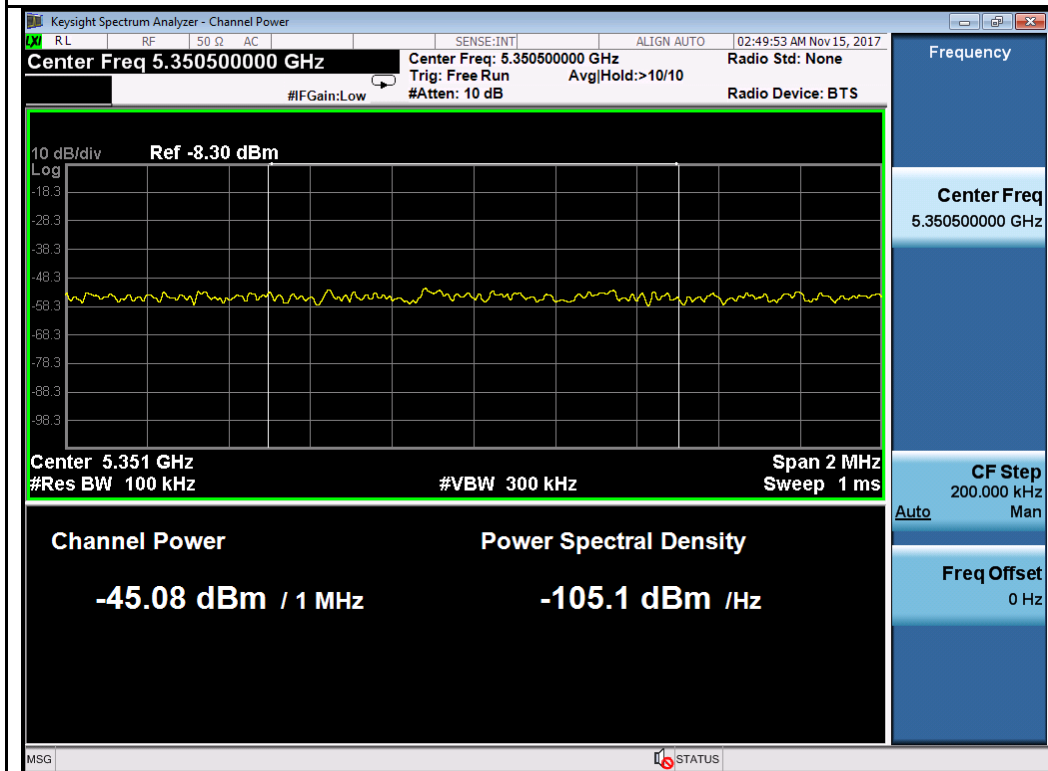

802.11a-5240MHz

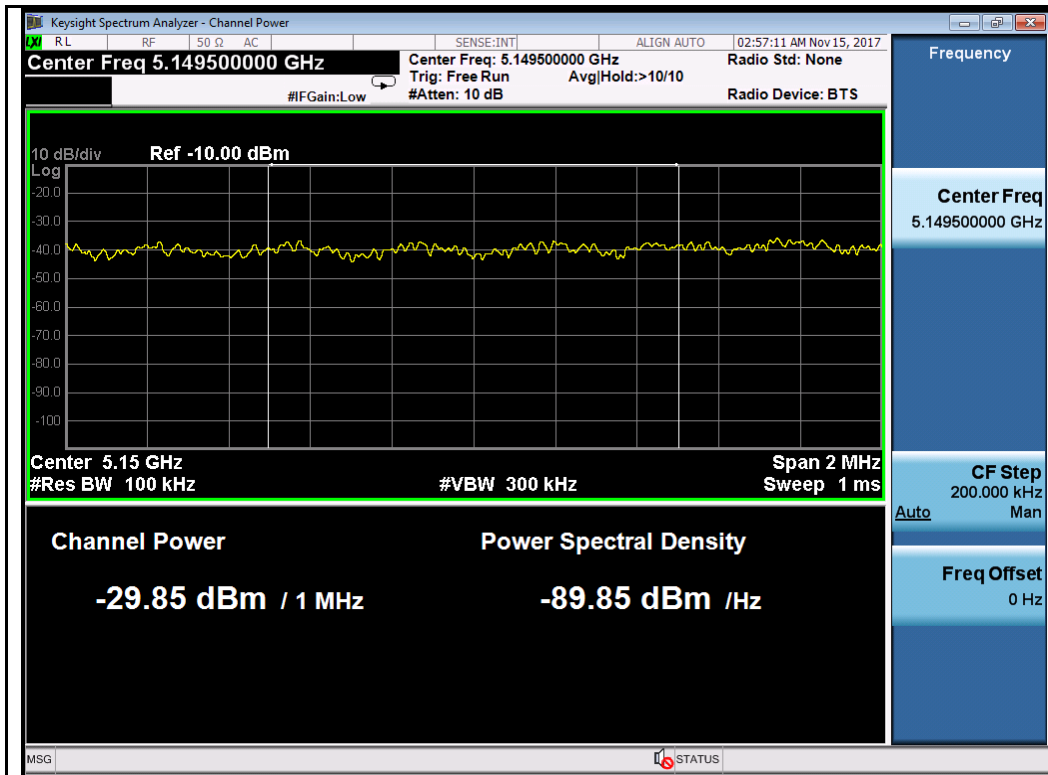

802.11n-HT20-5180MHz

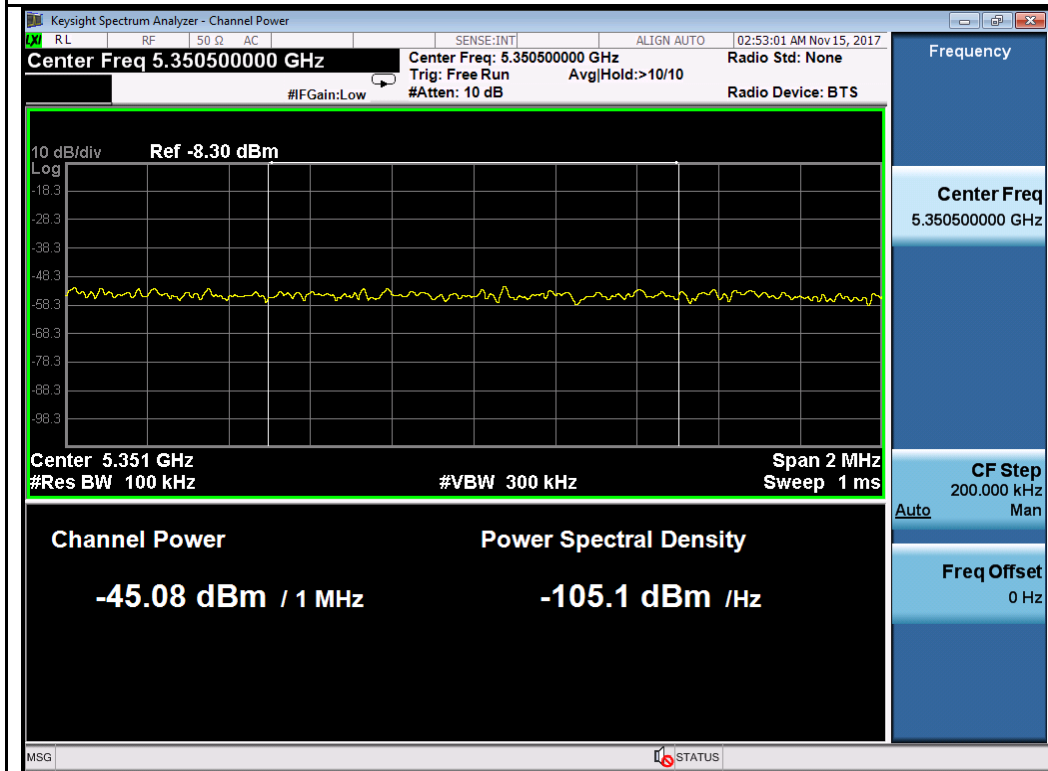

802.11n-HT20-5240MHz

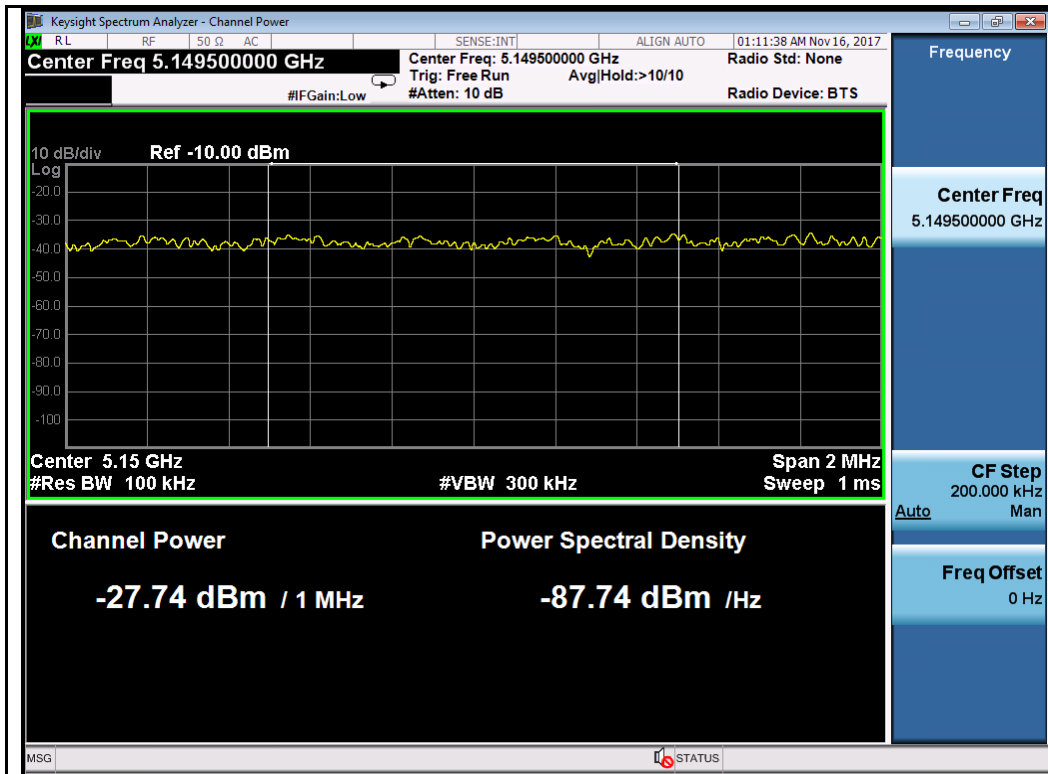

802.11n-HT40-5190MHz

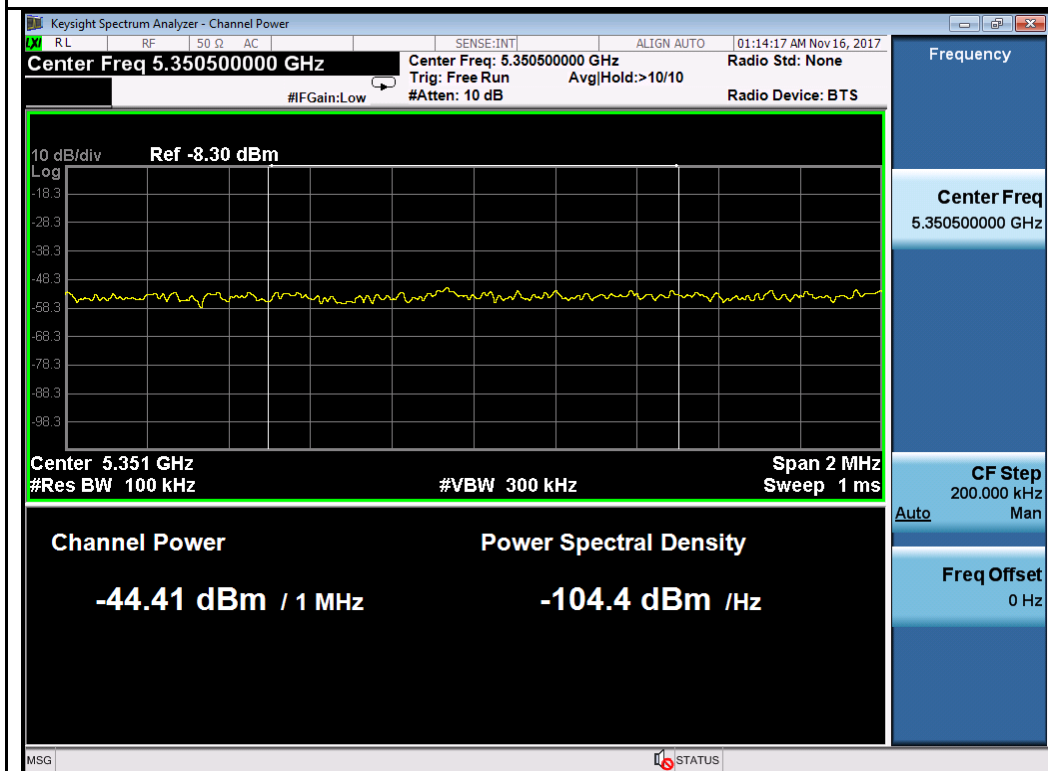

802.11n-HT40-5230MHz

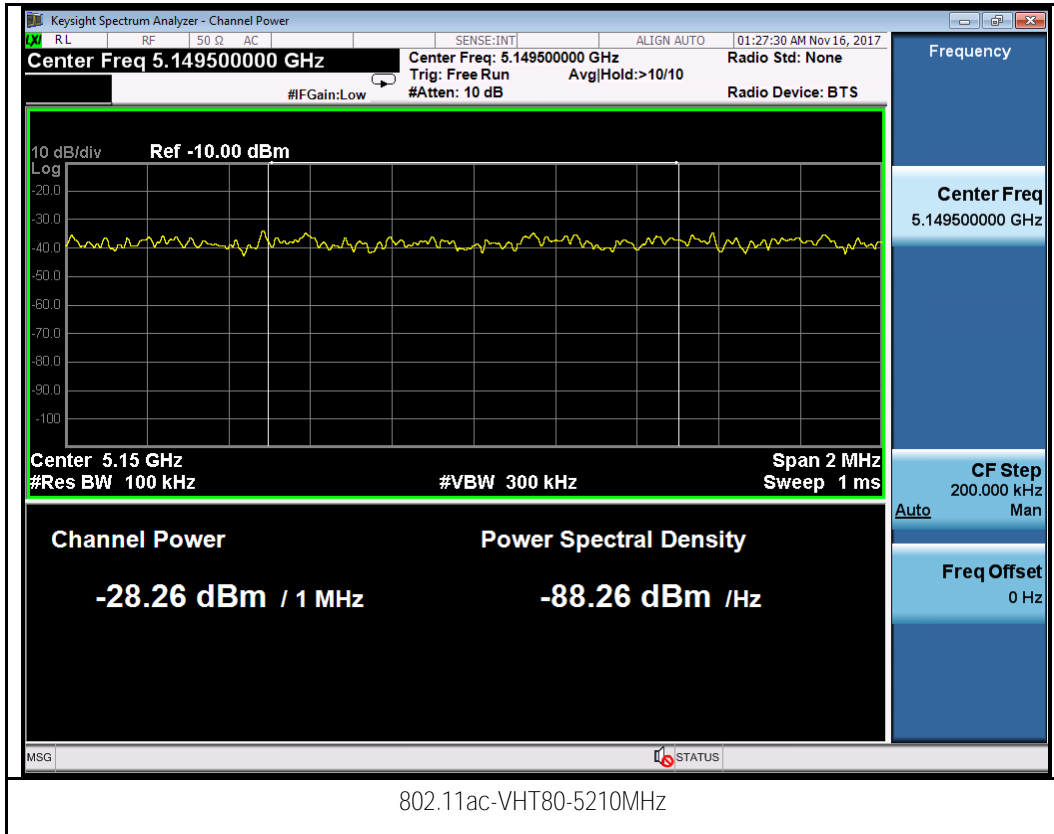

Test Plot for W58:
Chain 0:

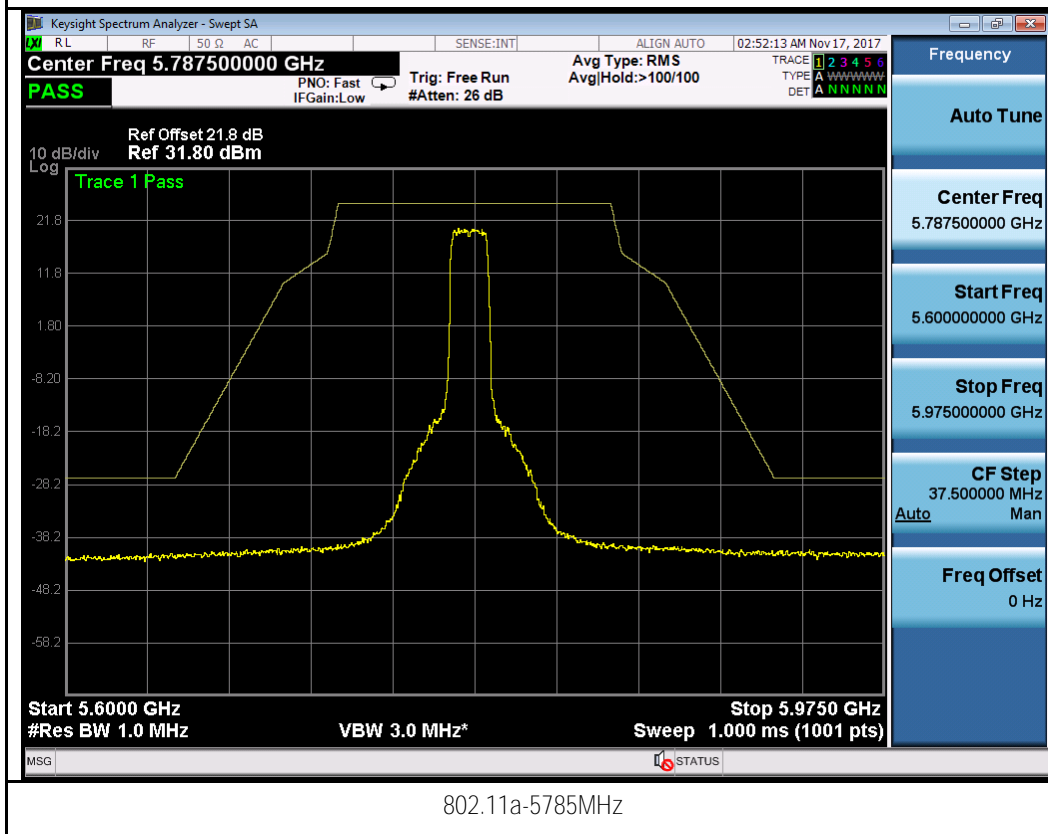
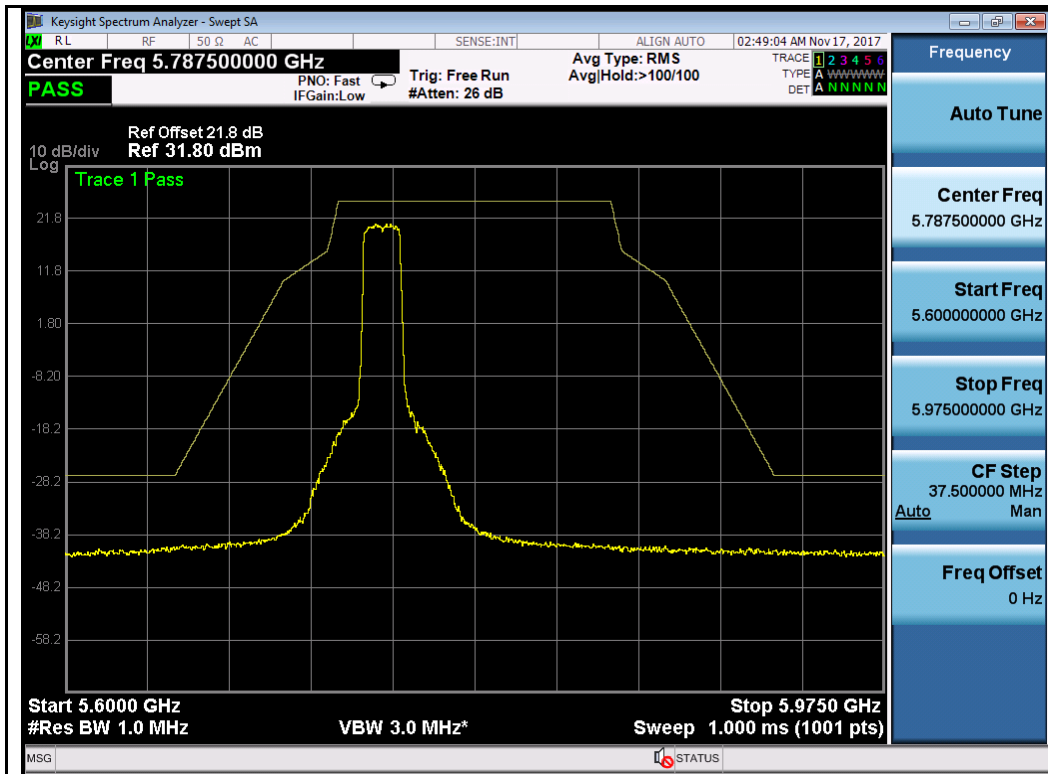

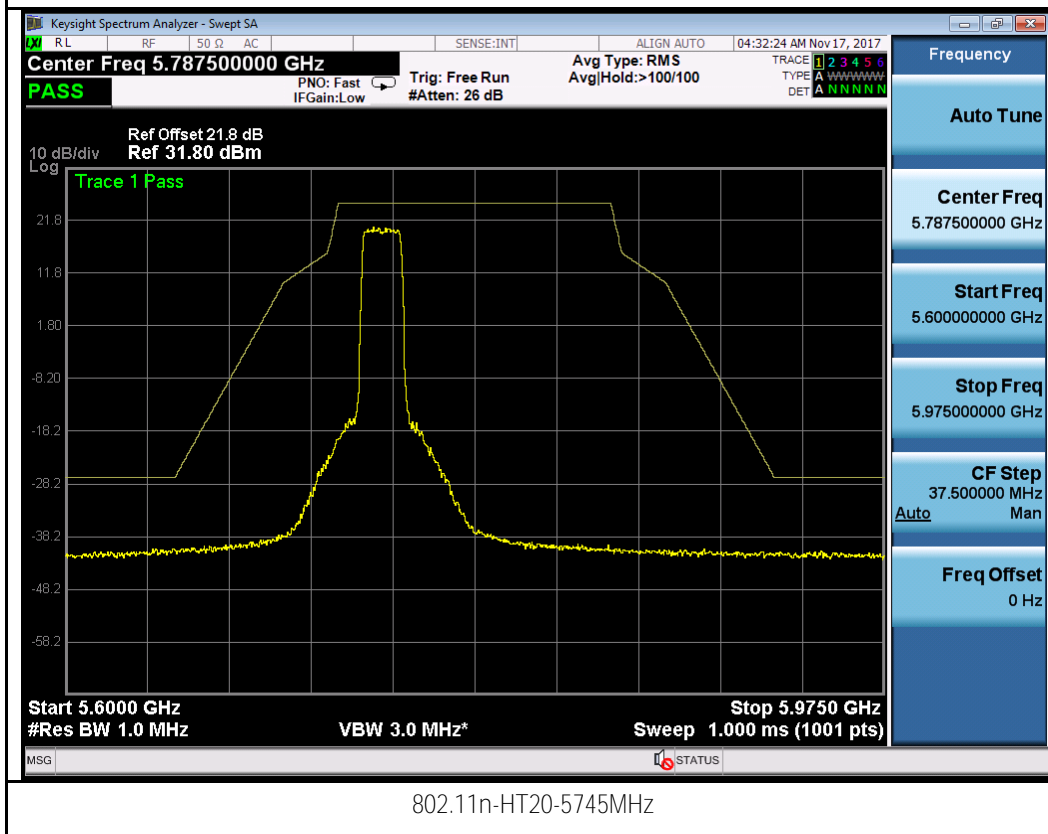
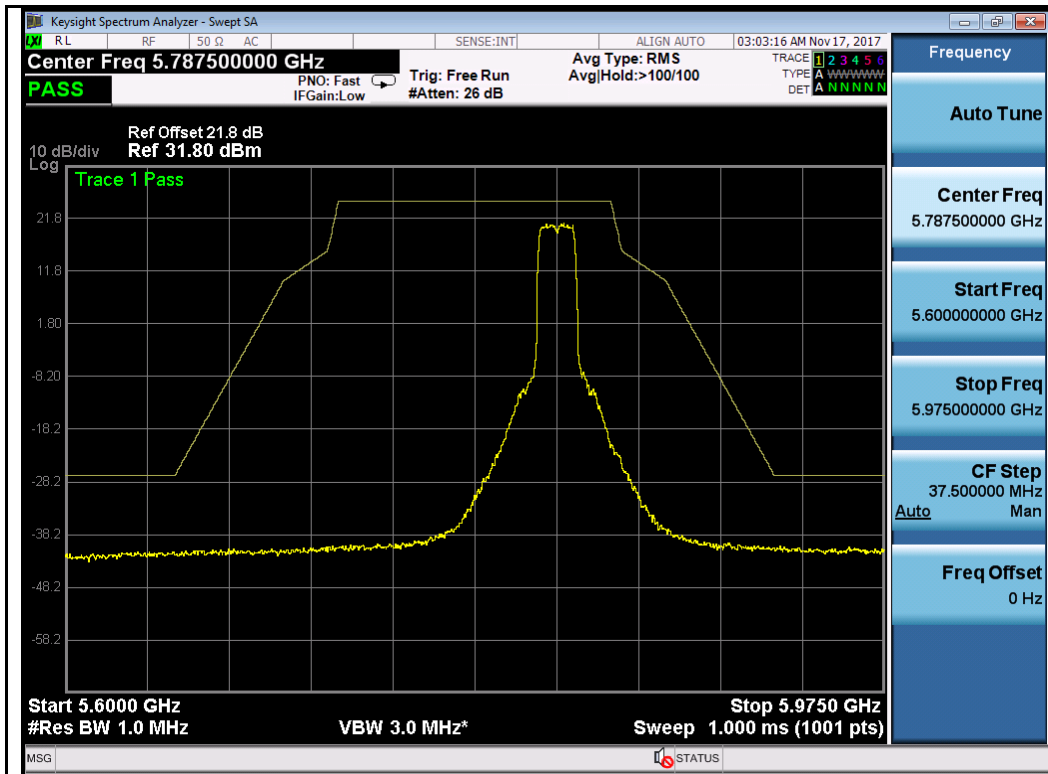

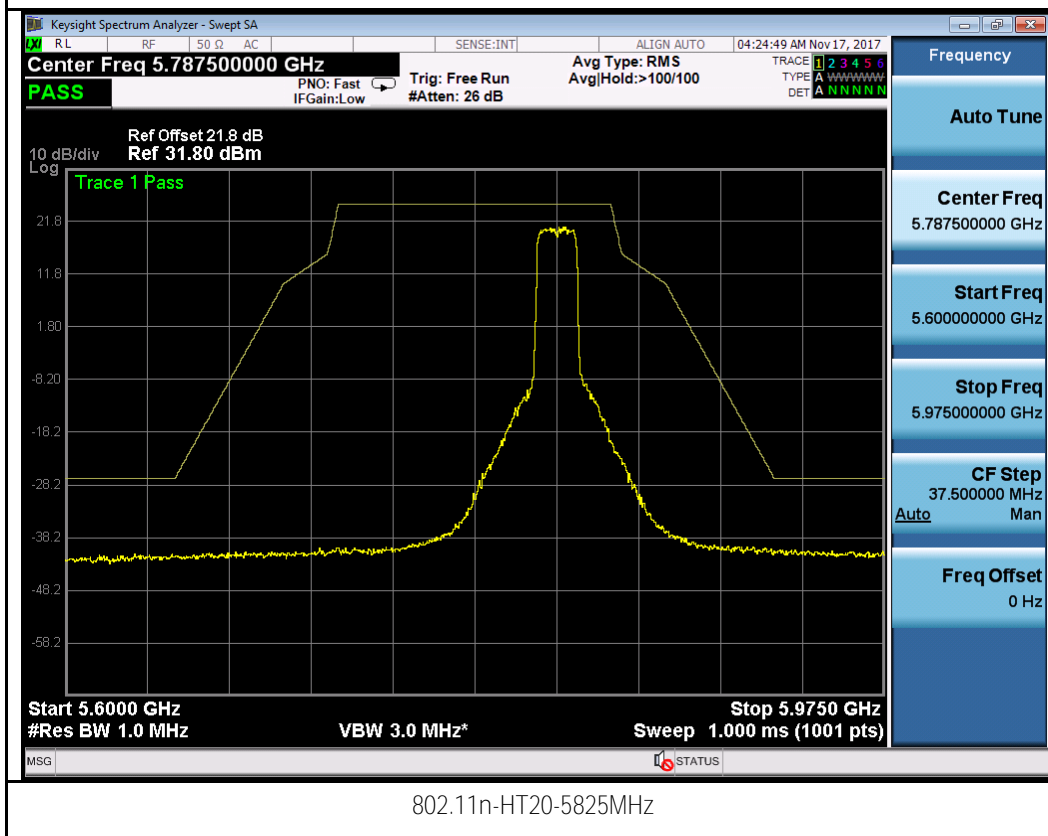
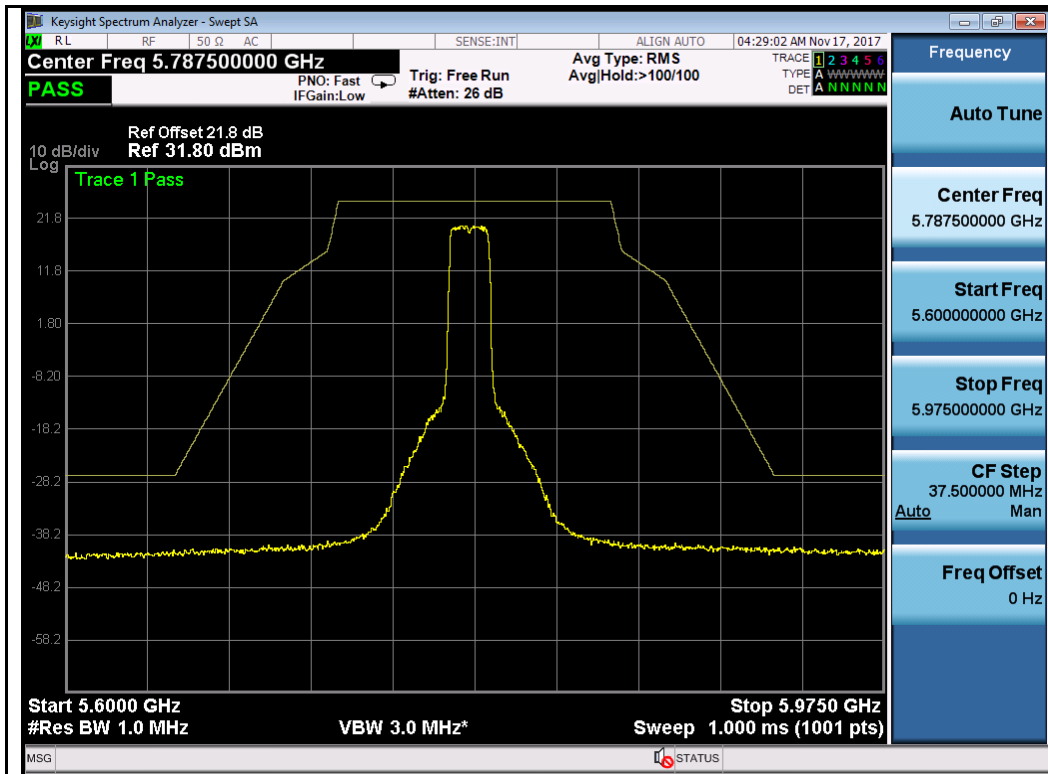

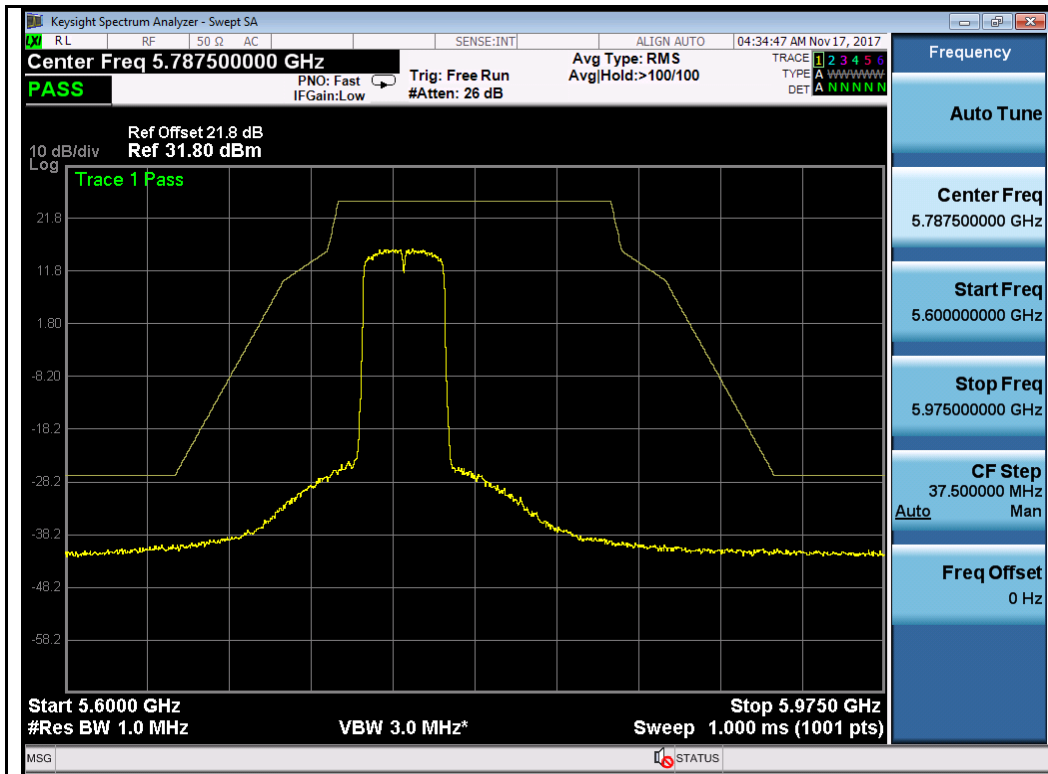

802.11n-HT40-5755MHz

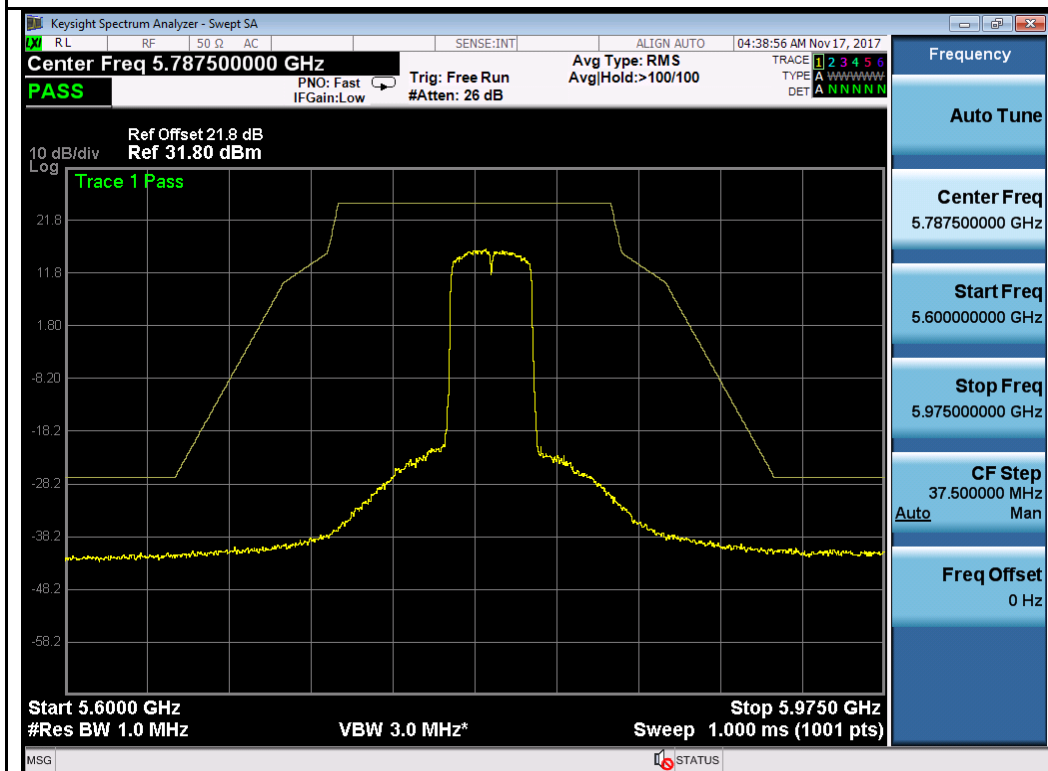

802.11n-HT40-5795MHz

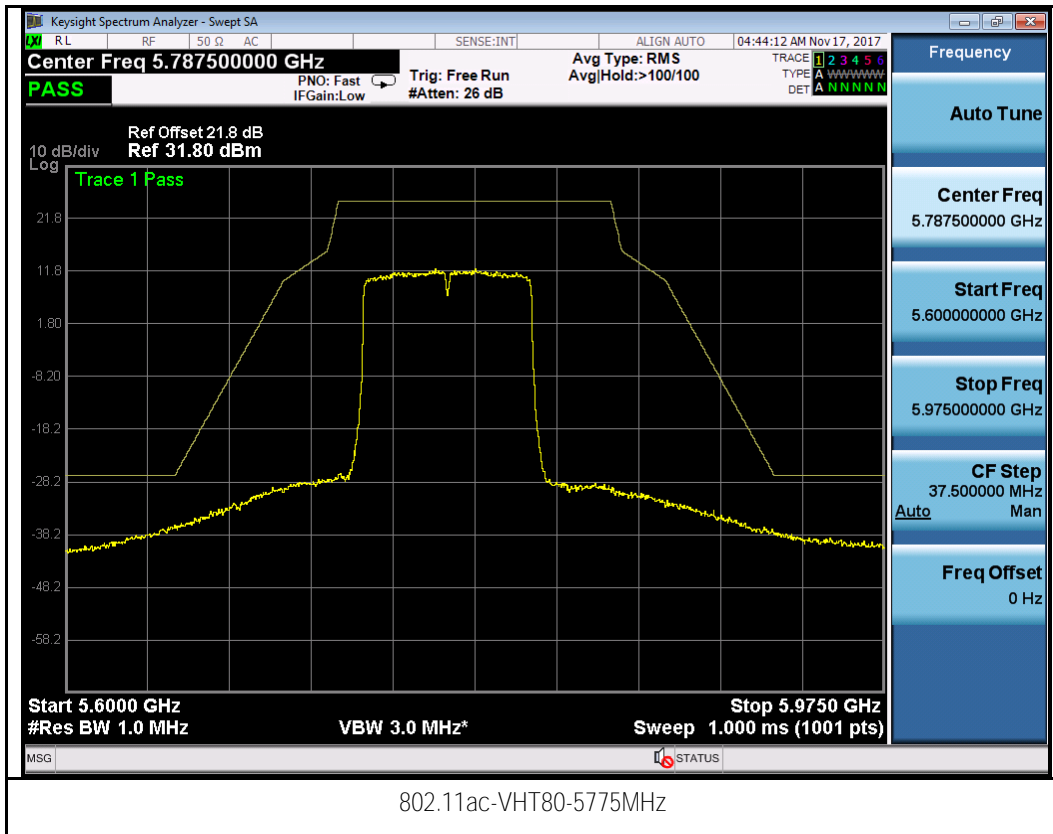

Chain 1:

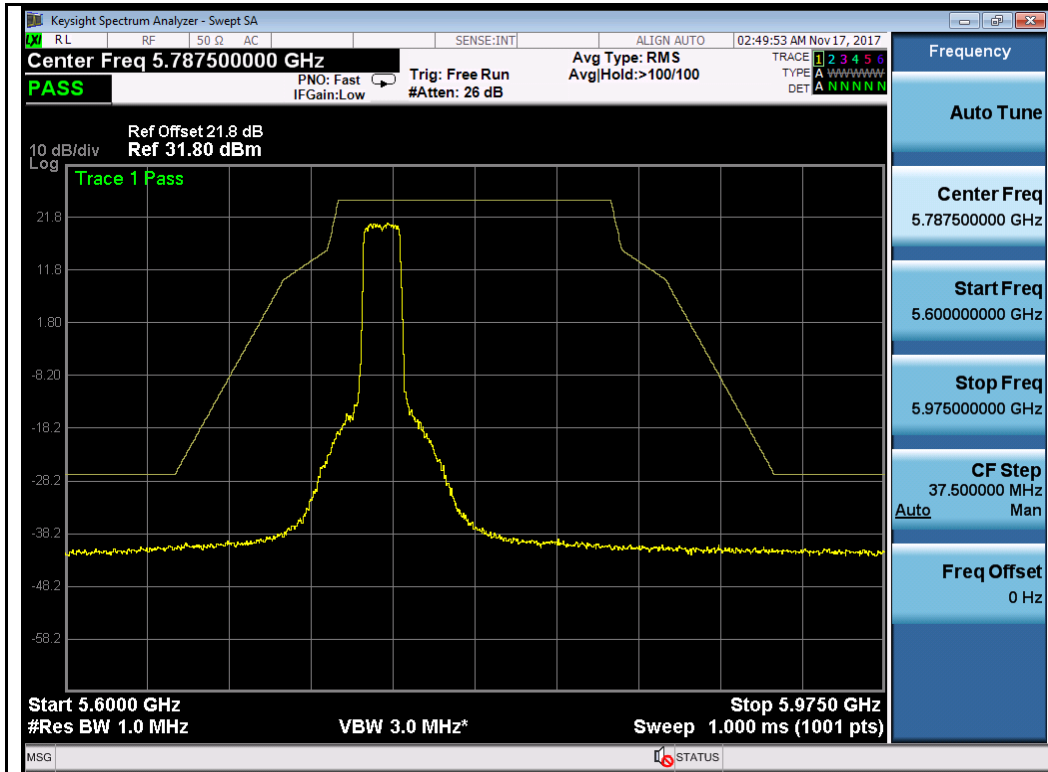

802.11a-5745MHz

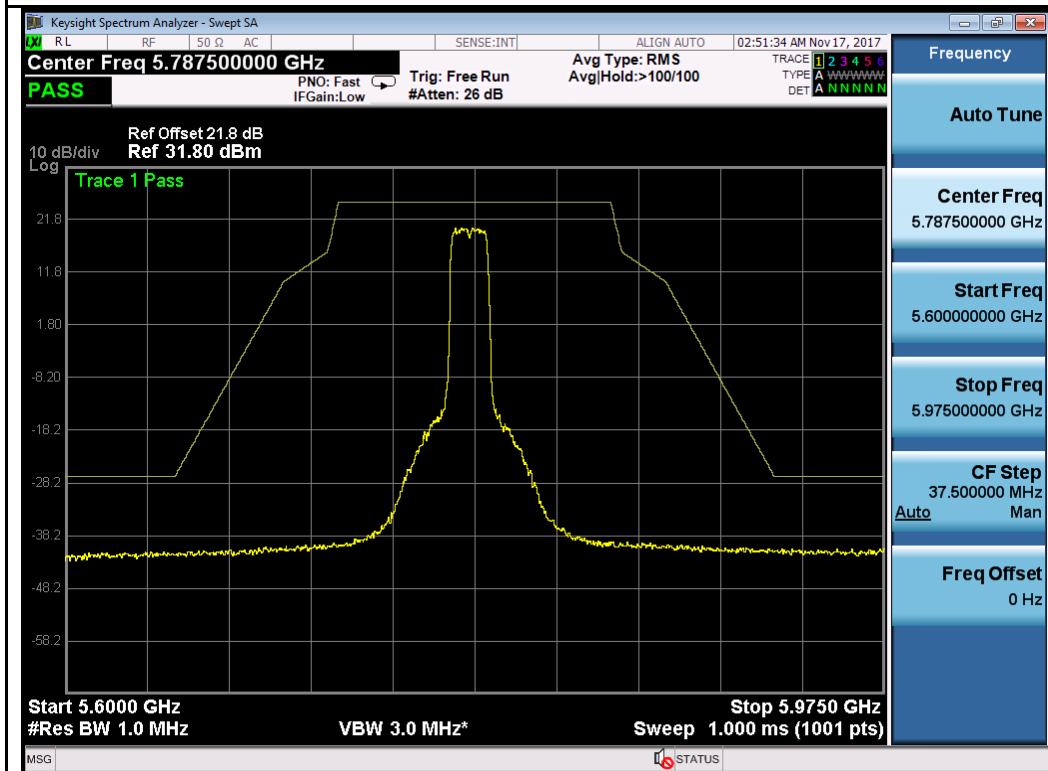

802.11a-5785MHz

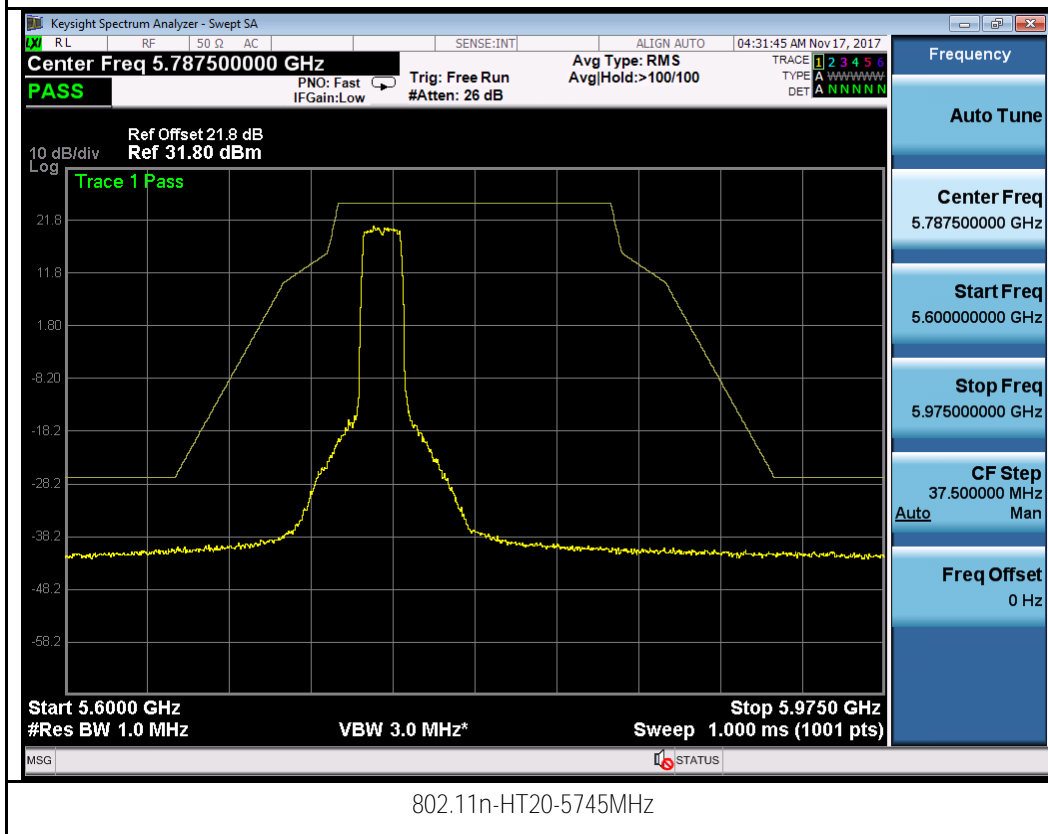
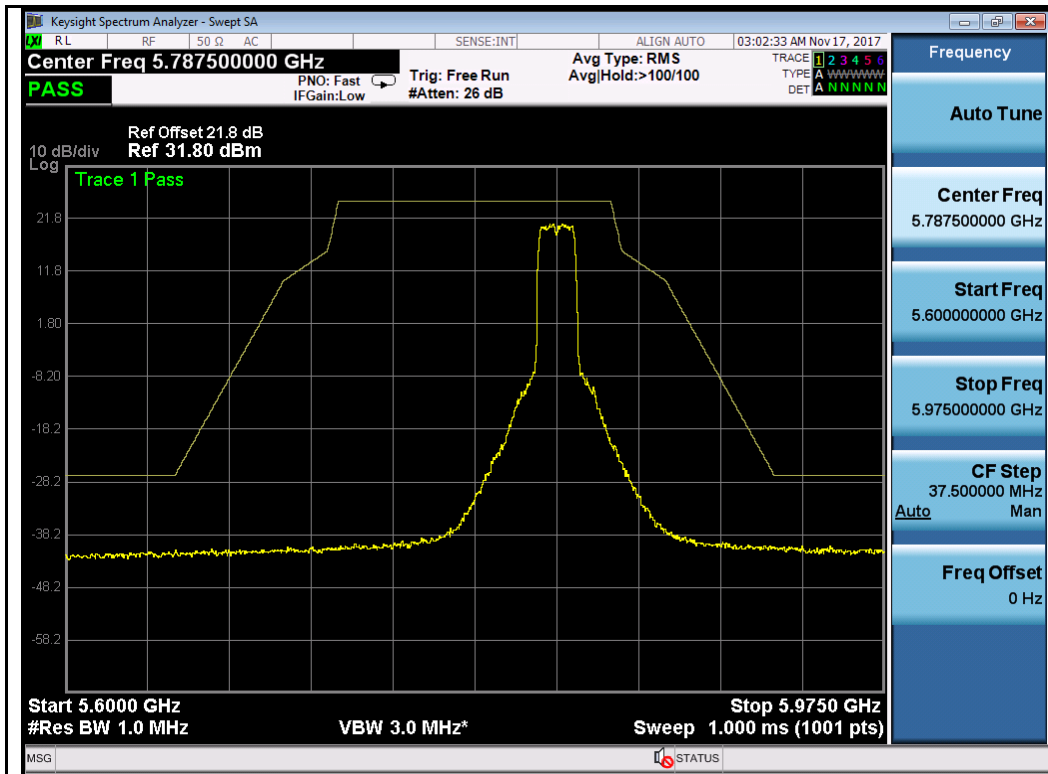

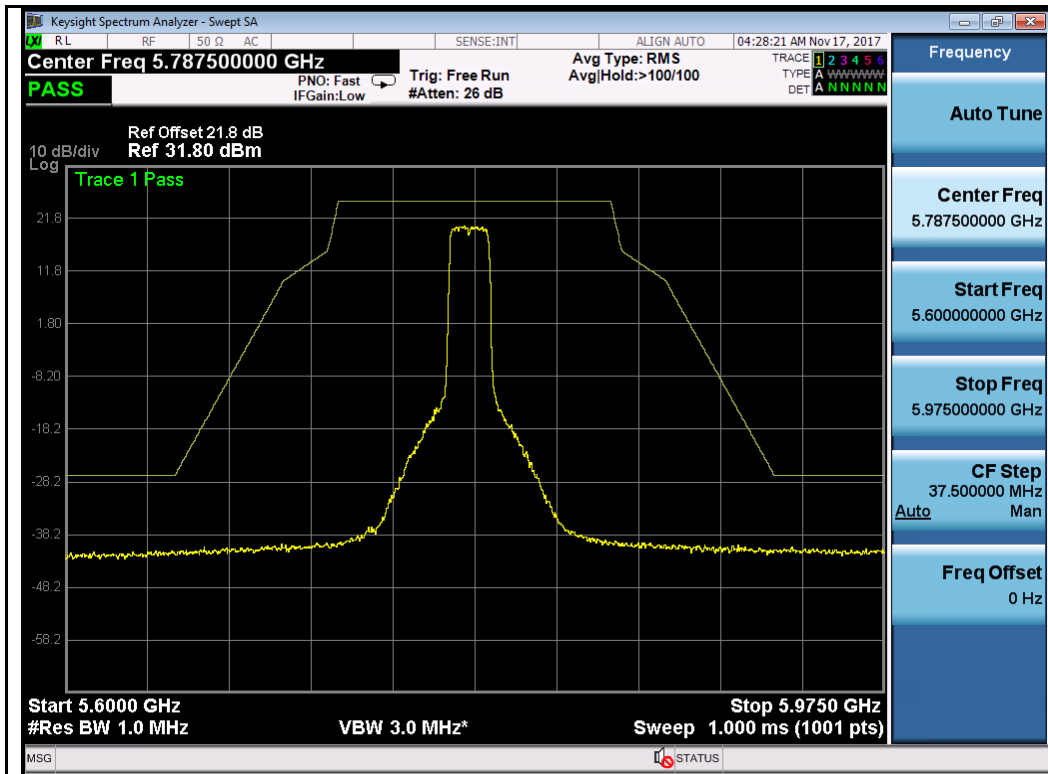

802.11n-HT20-5785MHz

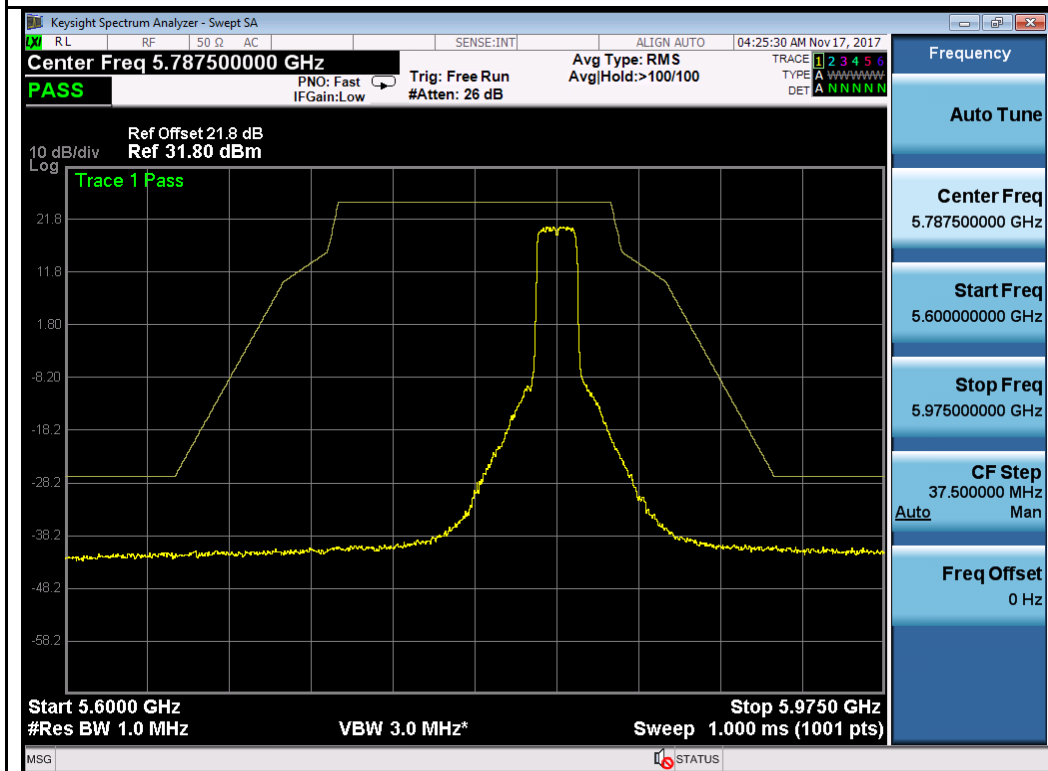

802.11n-HT20-5825MHz

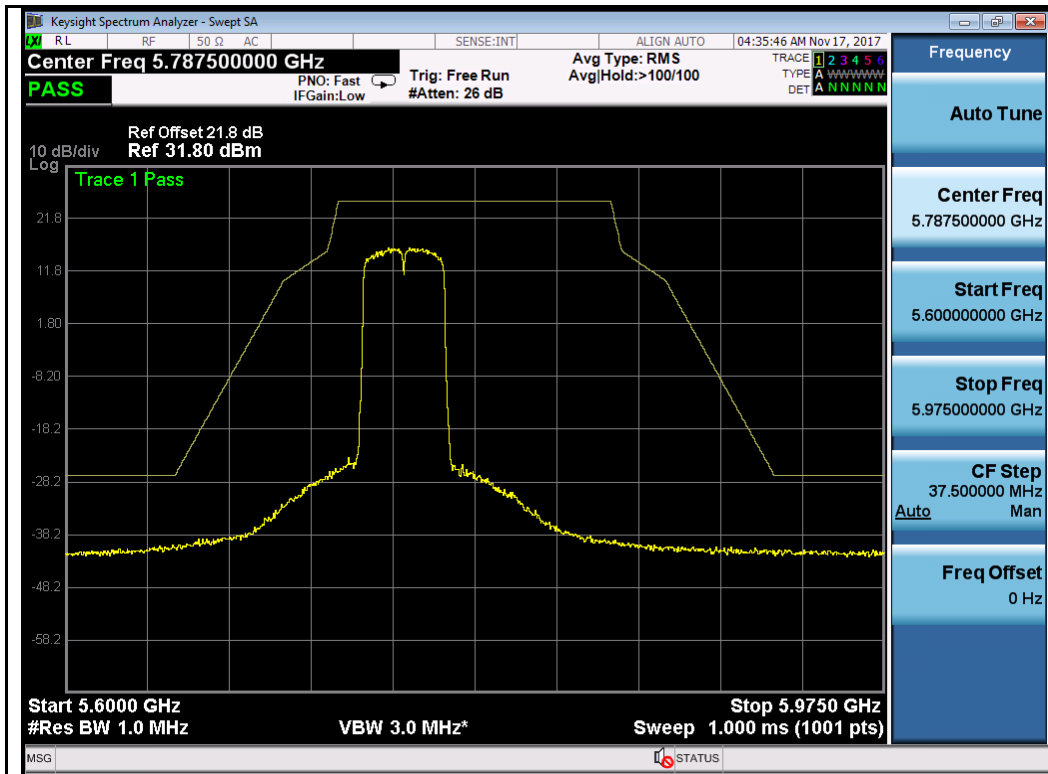

802.11n-HT40-5755MHz

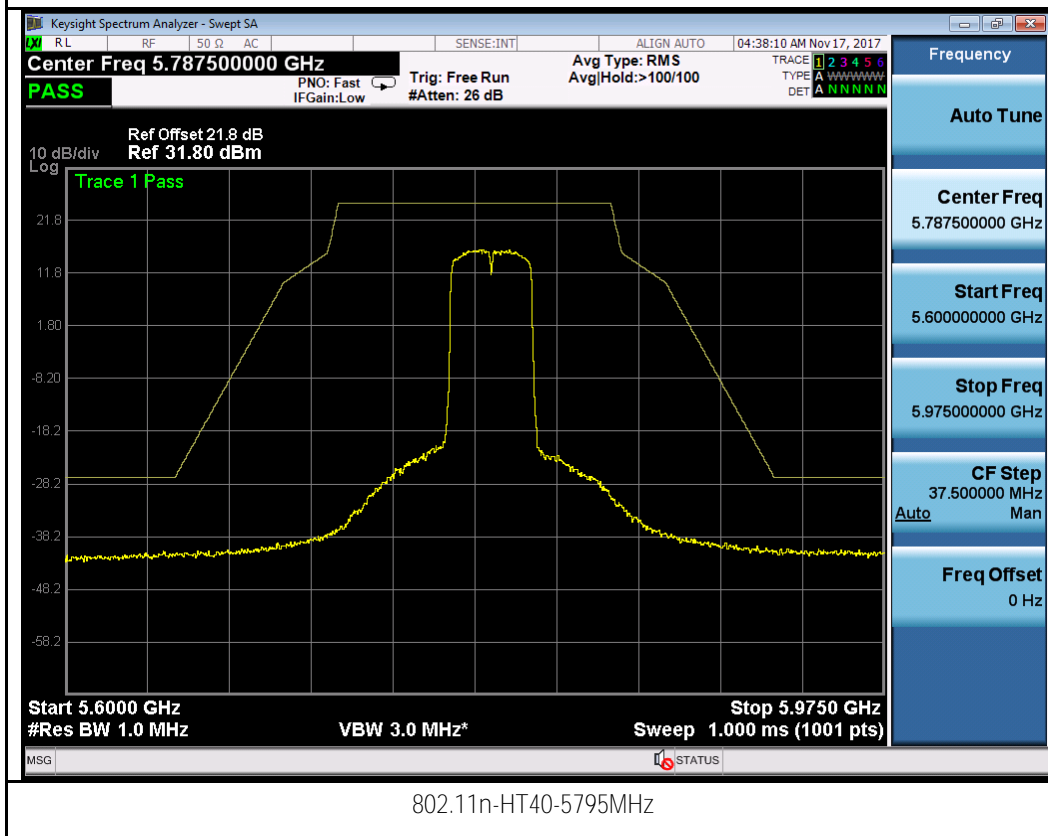

802.11n-HT40-5795MHz

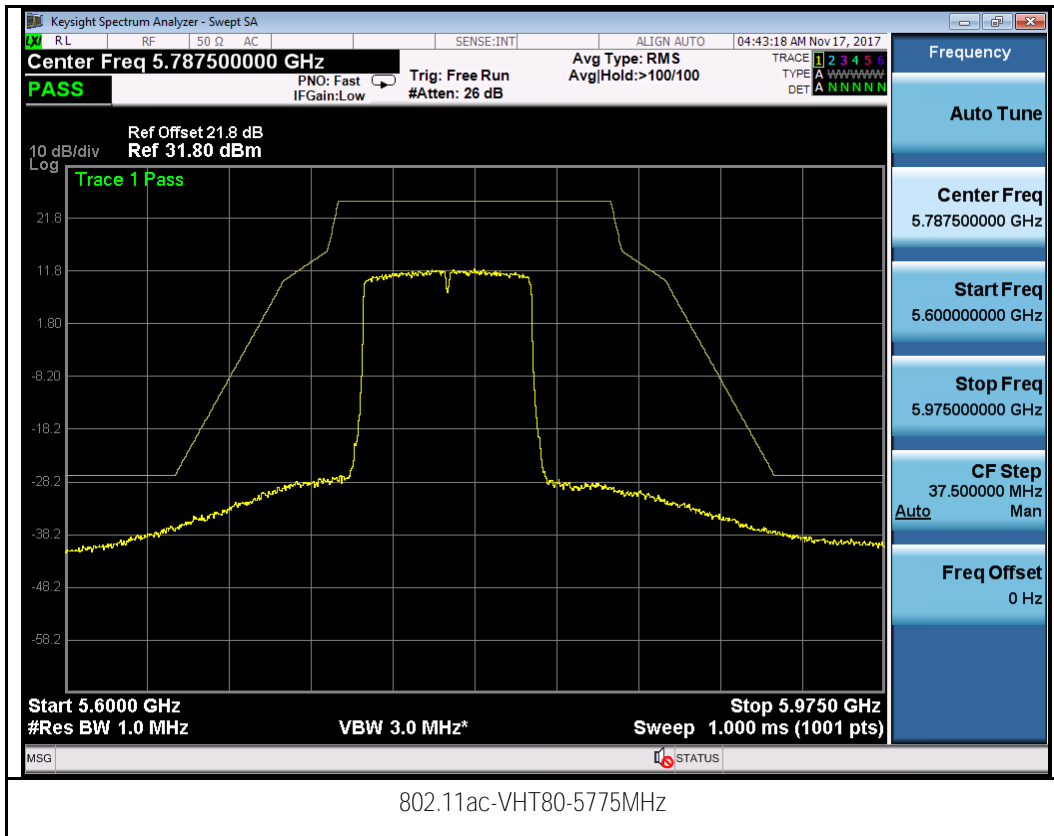

T310S
Test Plot for W52:
Chain 0:

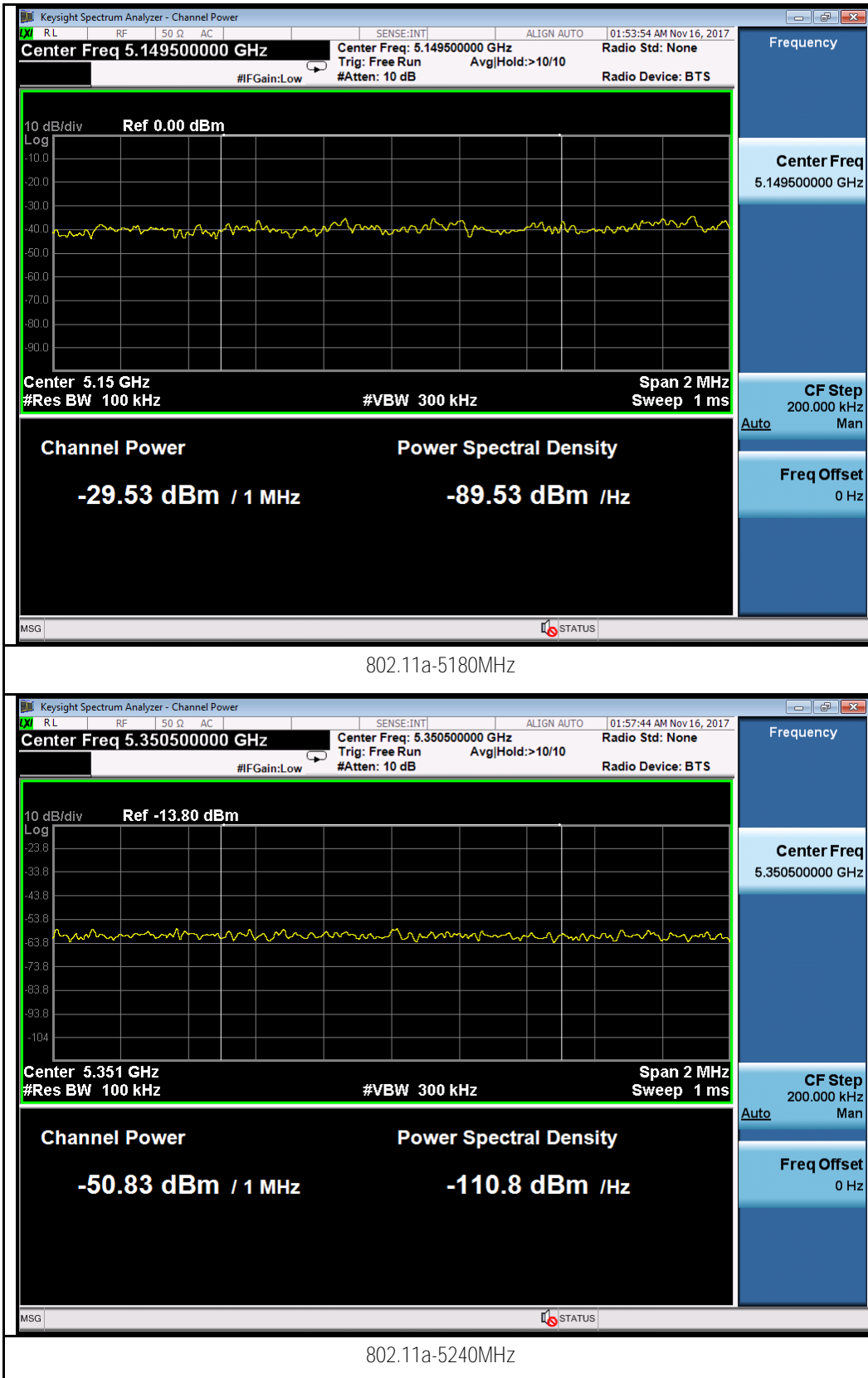

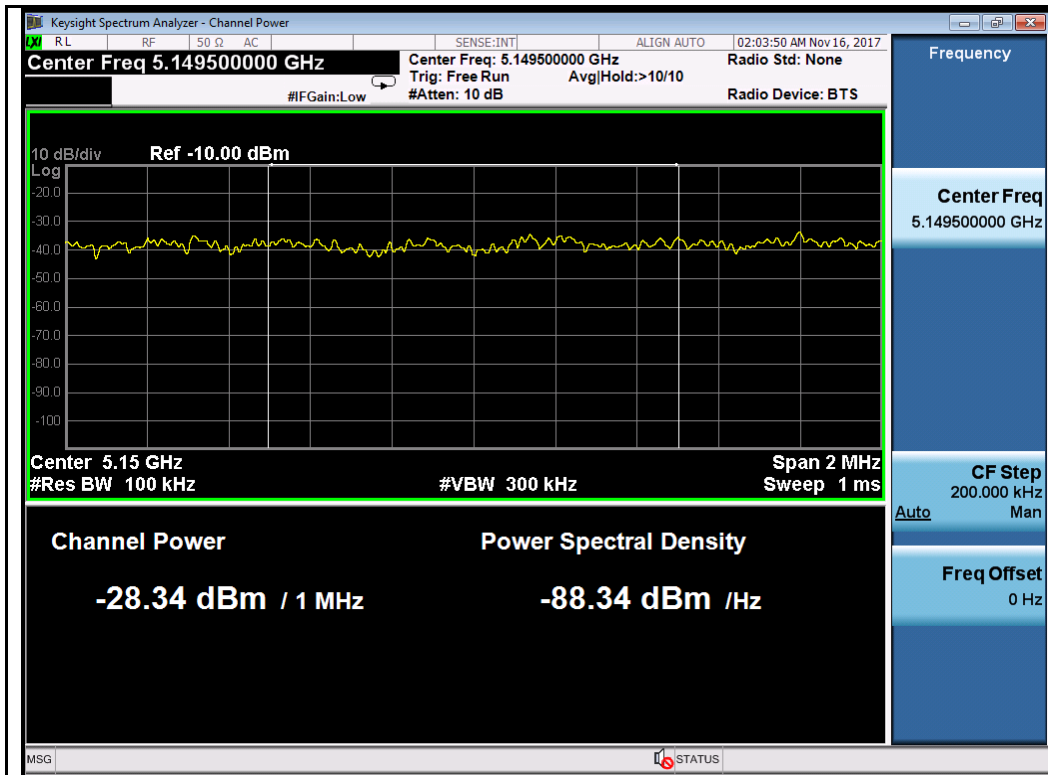

802.11n-HT20-5180MHz

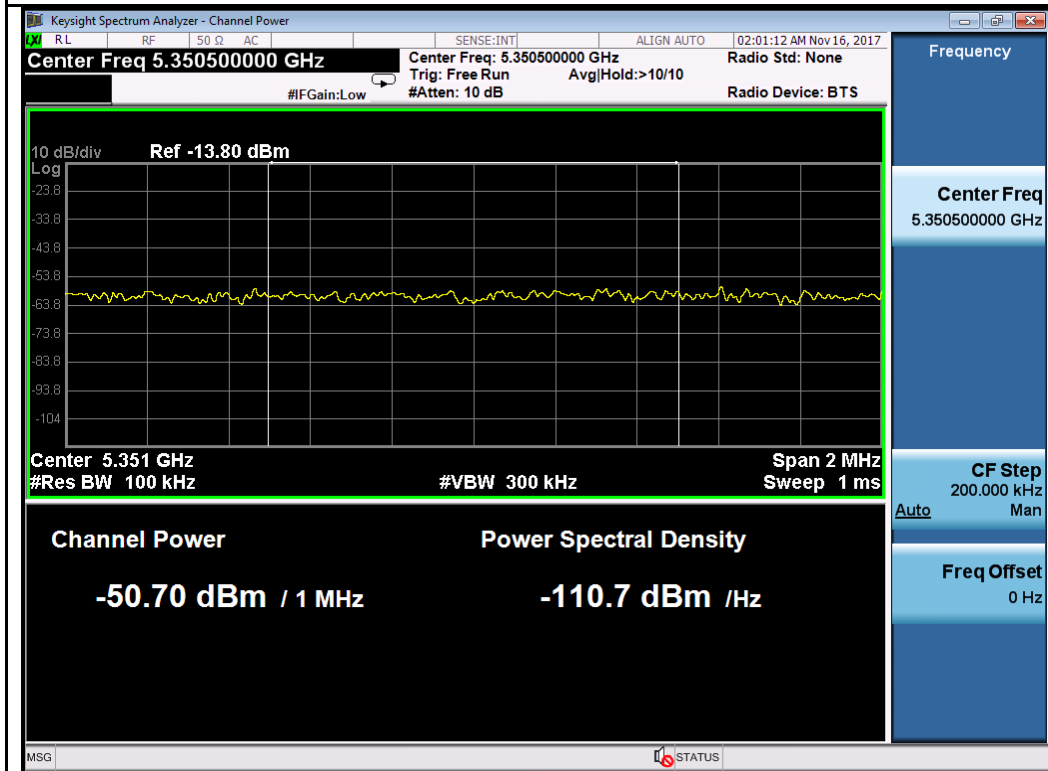

802.11n-HT20-5240MHz

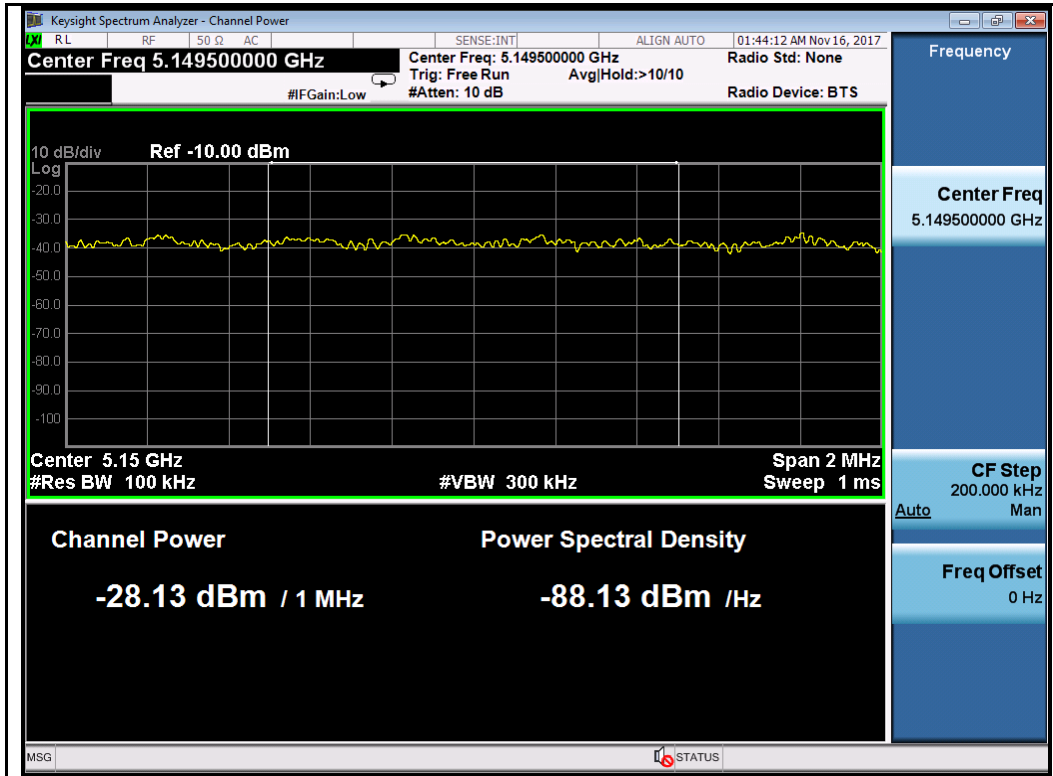

802.11n-HT40-5190MHz

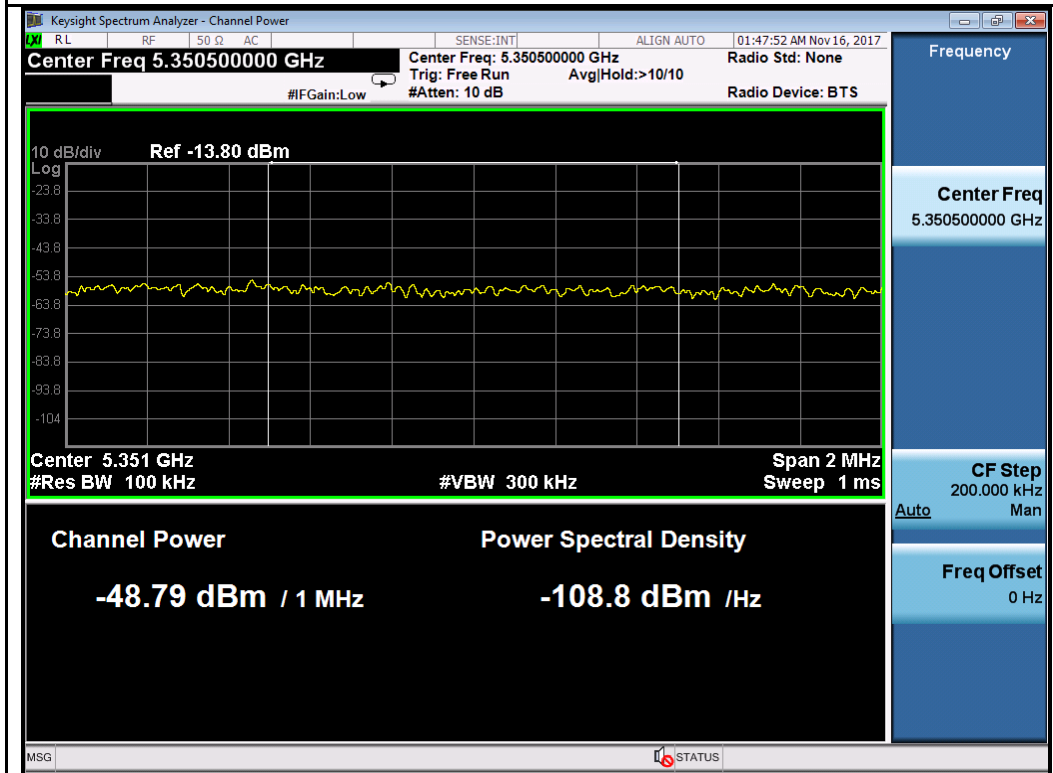

802.11n-HT40-5230MHz

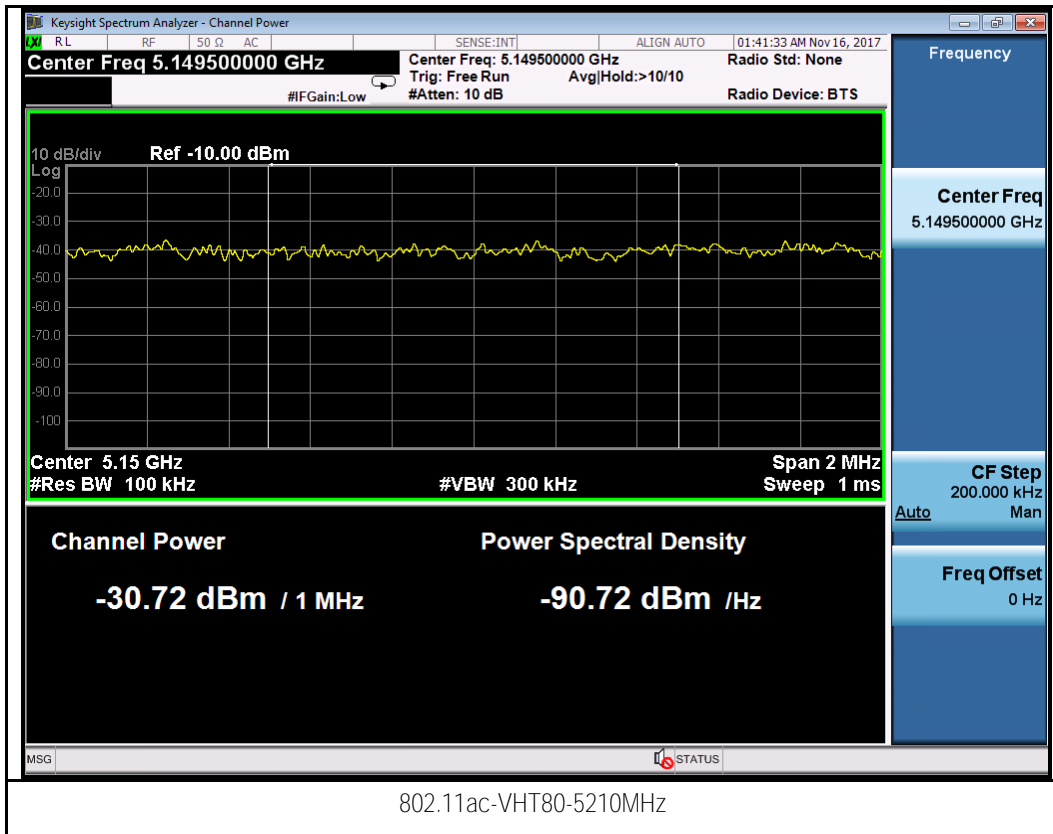

Chain 1:

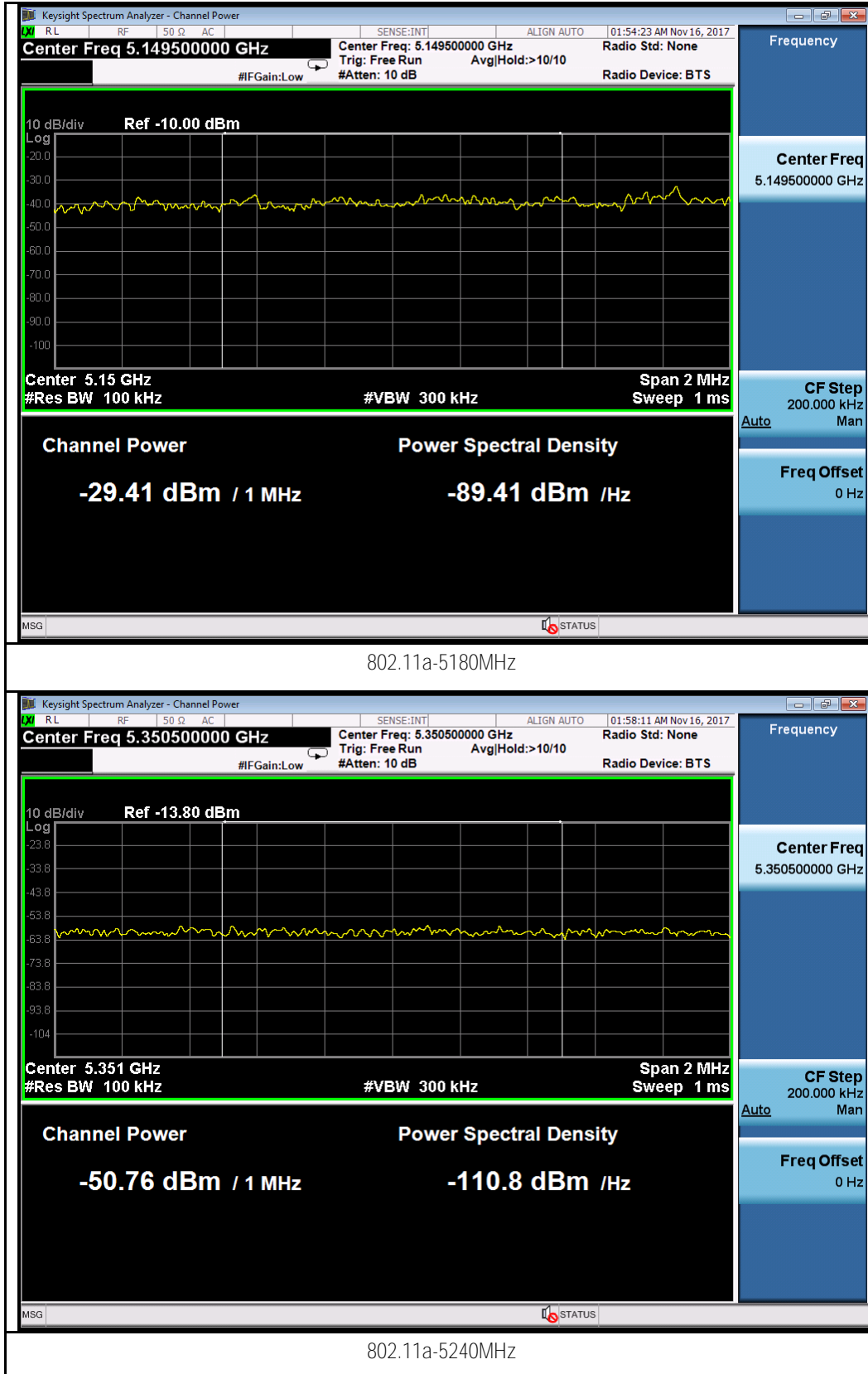

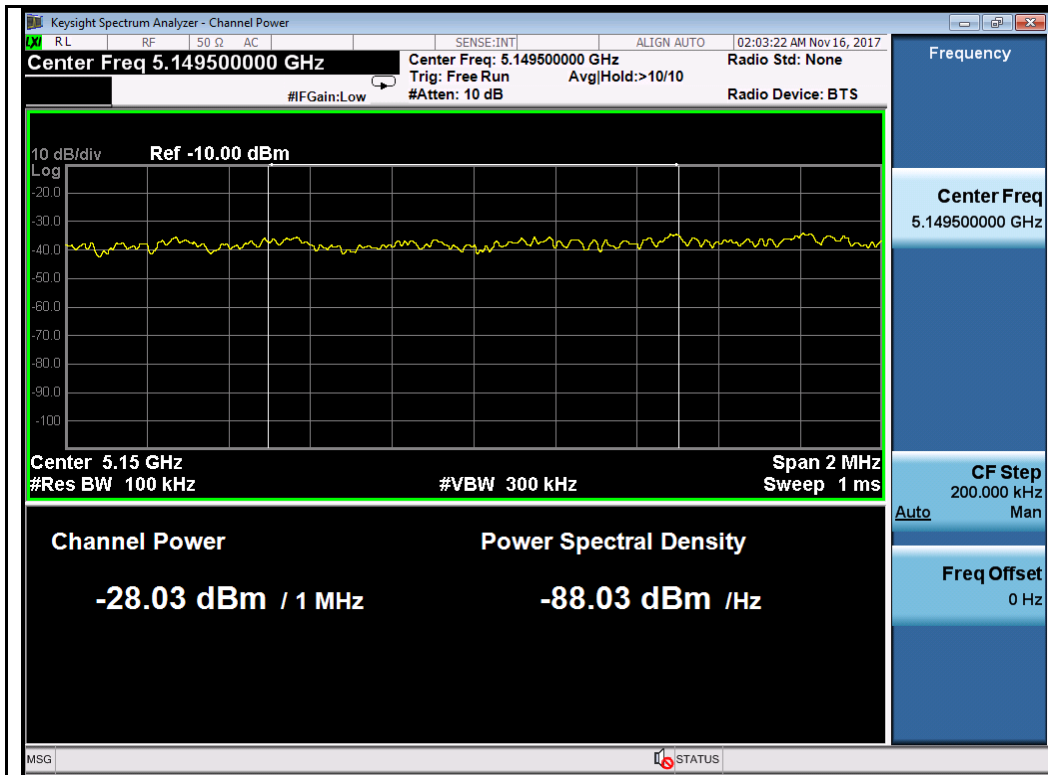

802.11n-HT20-5180MHz

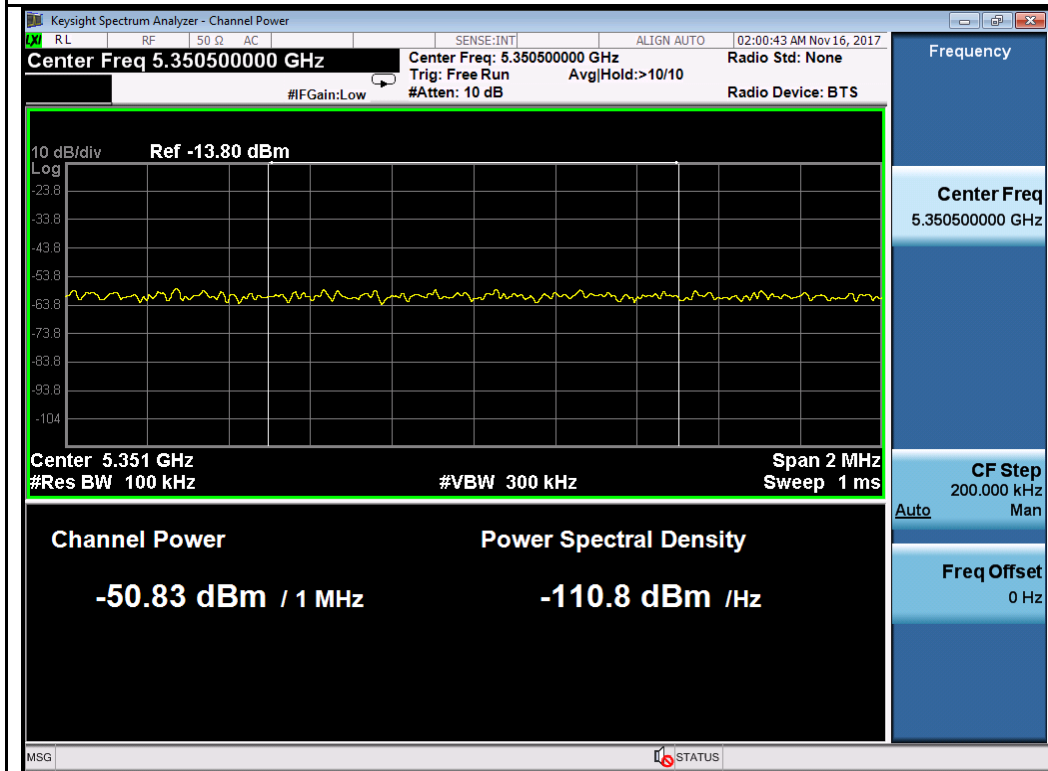

802.11n-HT20-5240MHz

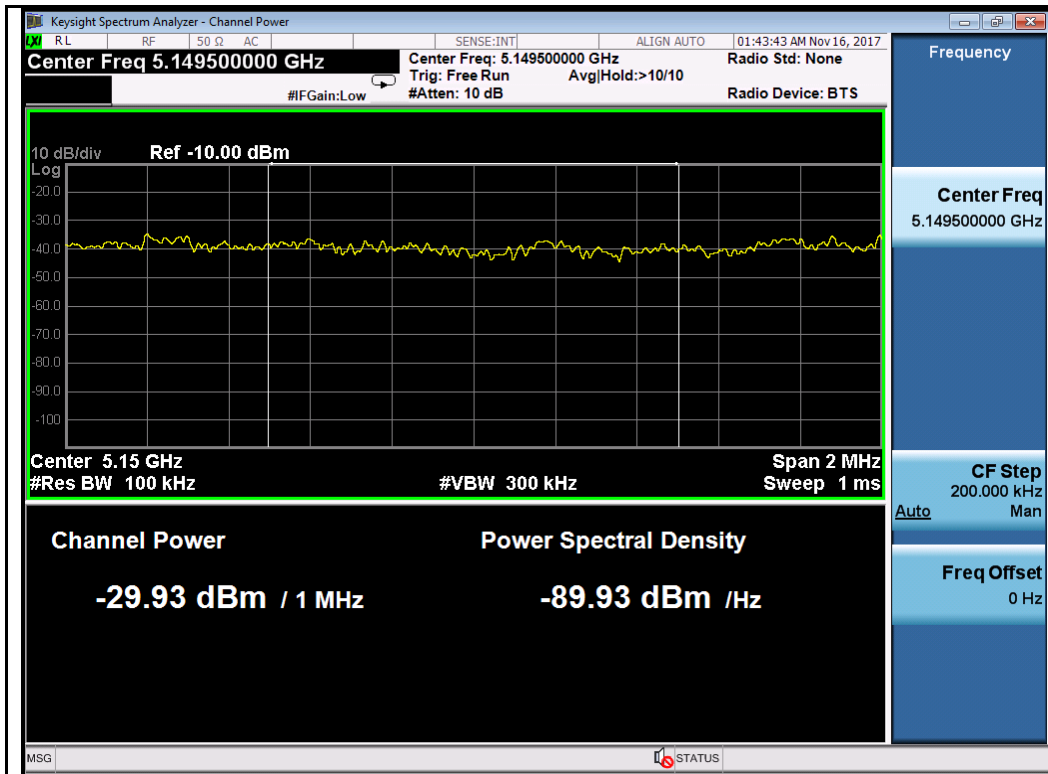

802.11n-HT40-5190MHz

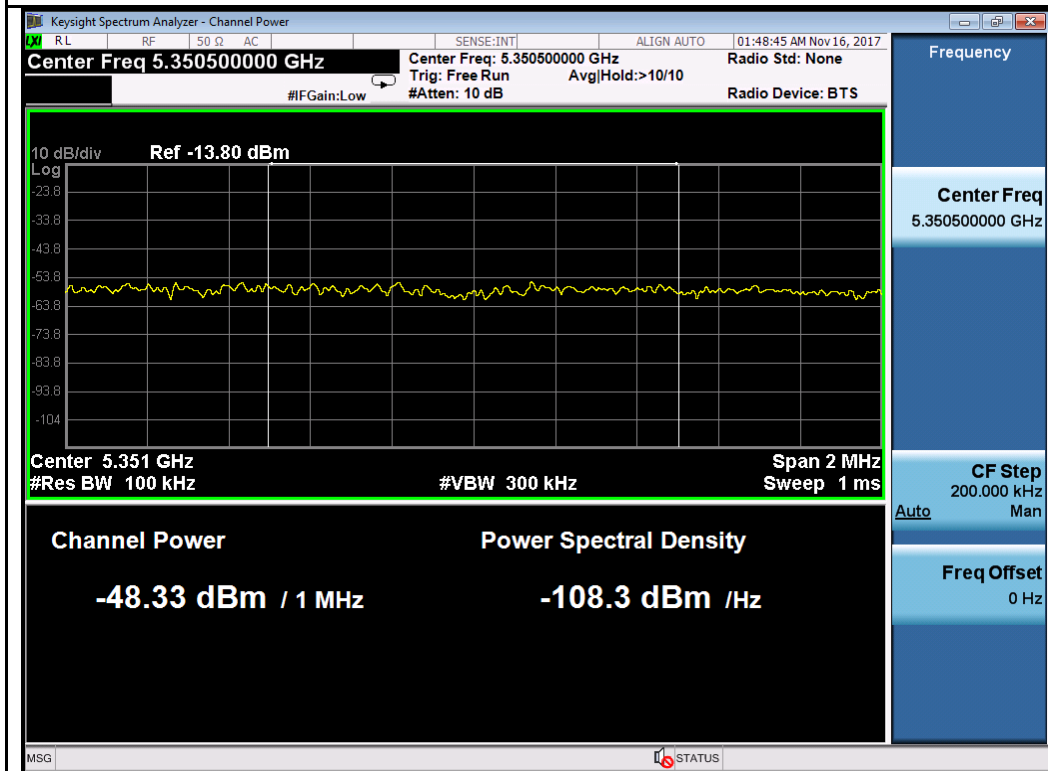

802.11n-HT40-5230MHz

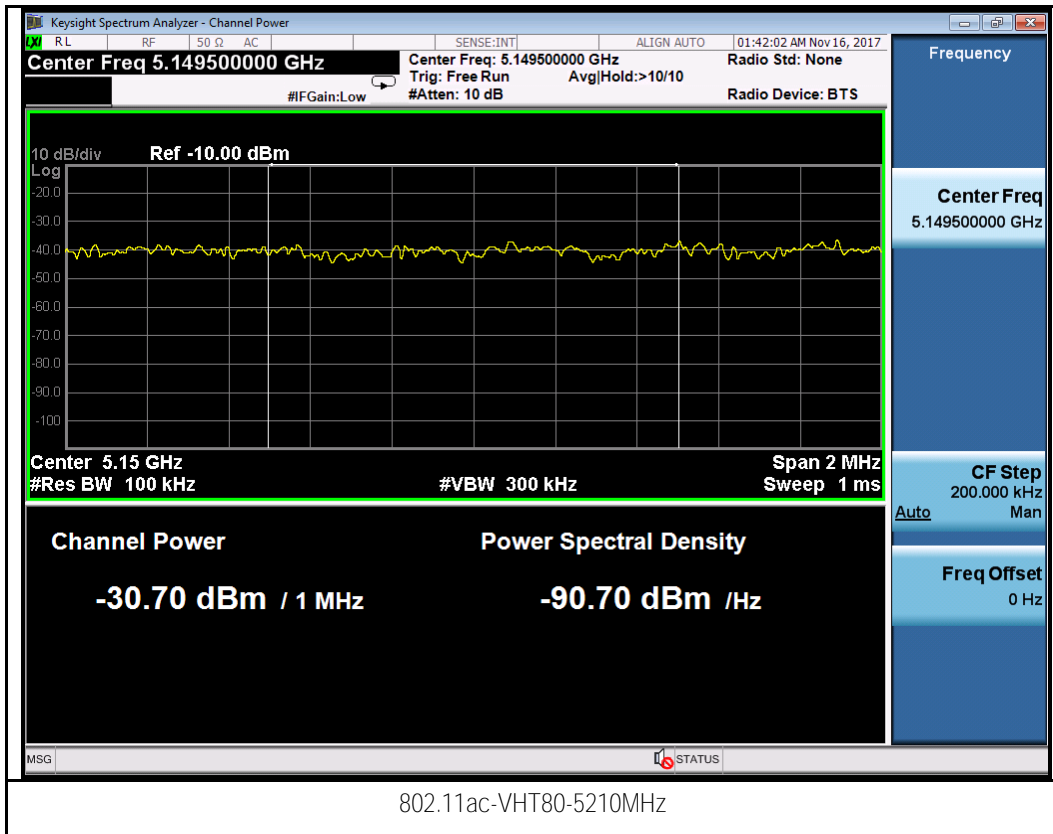

Test Plot for W58:

Chain 0:

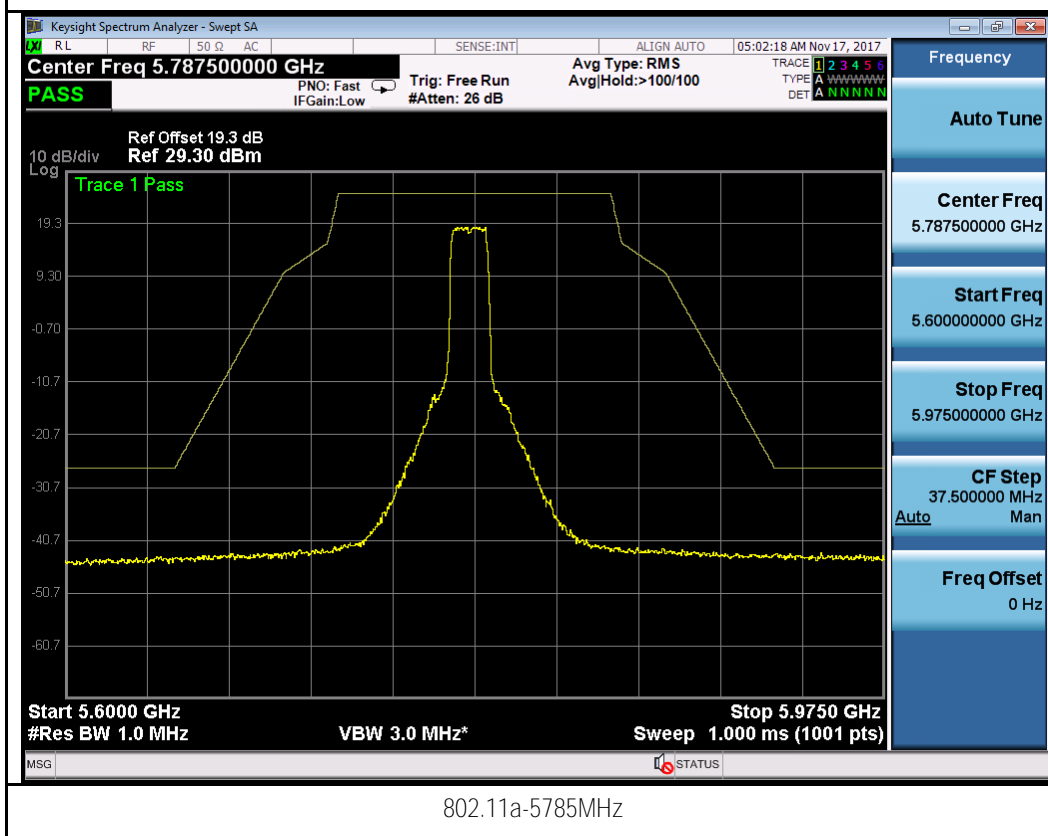
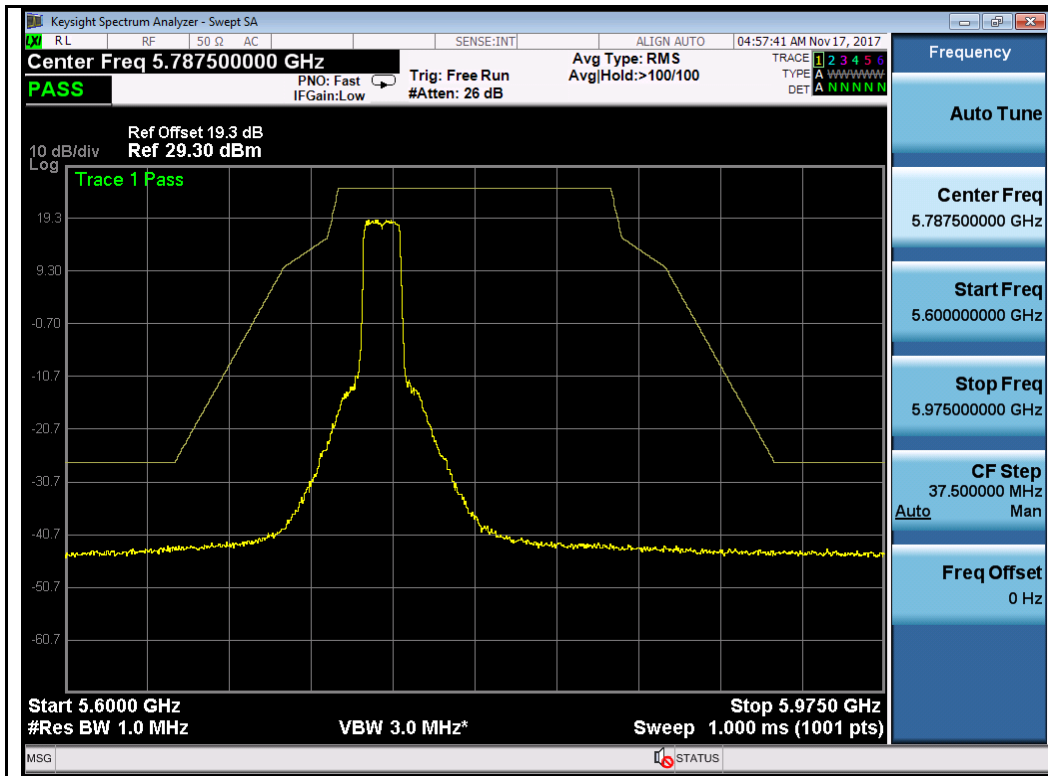

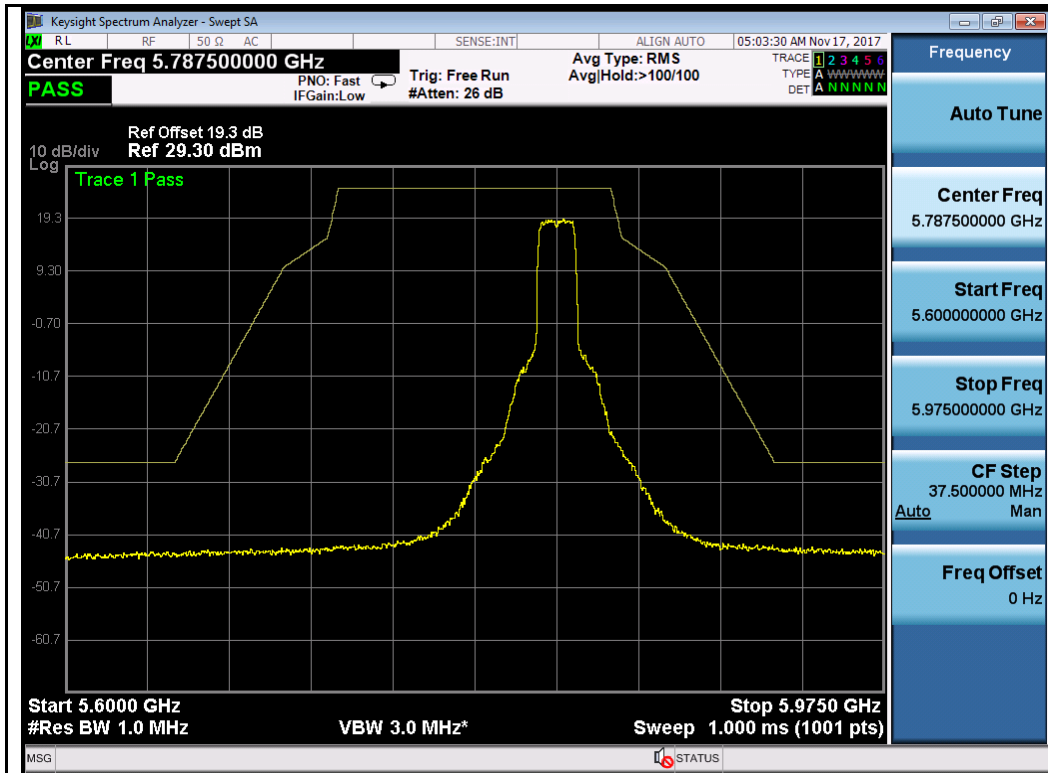

802.11a-5825MHz

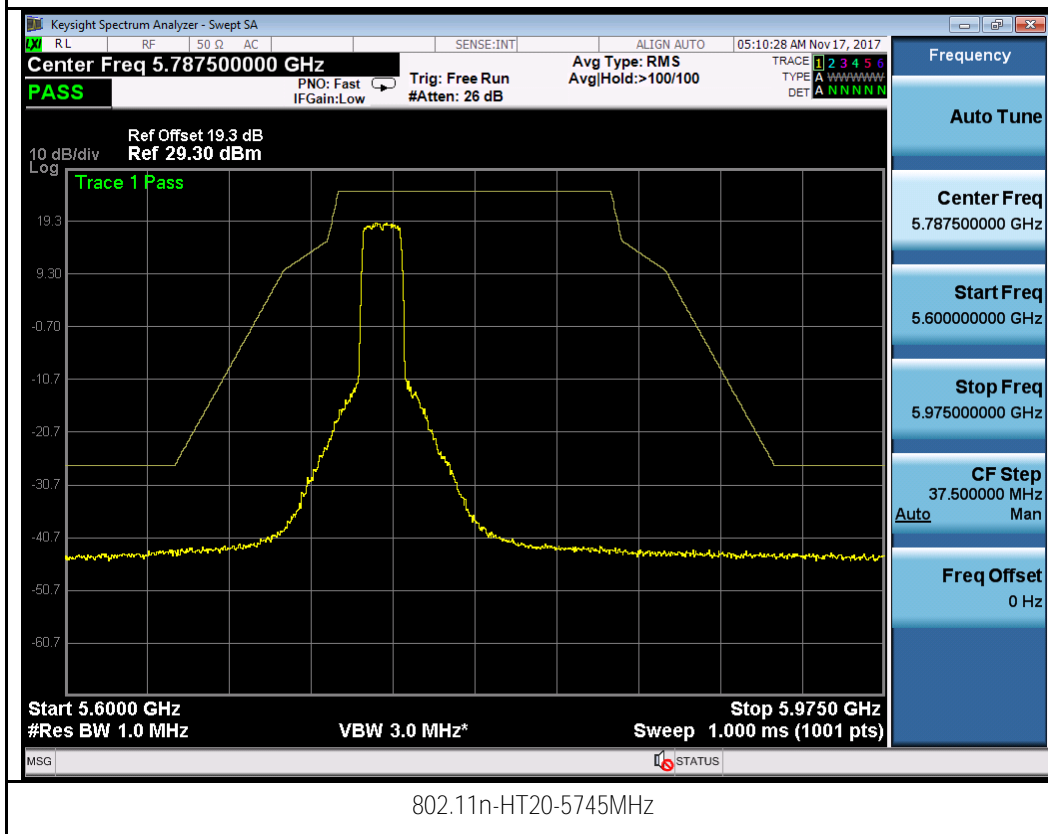

802.11n-HT20-5745MHz

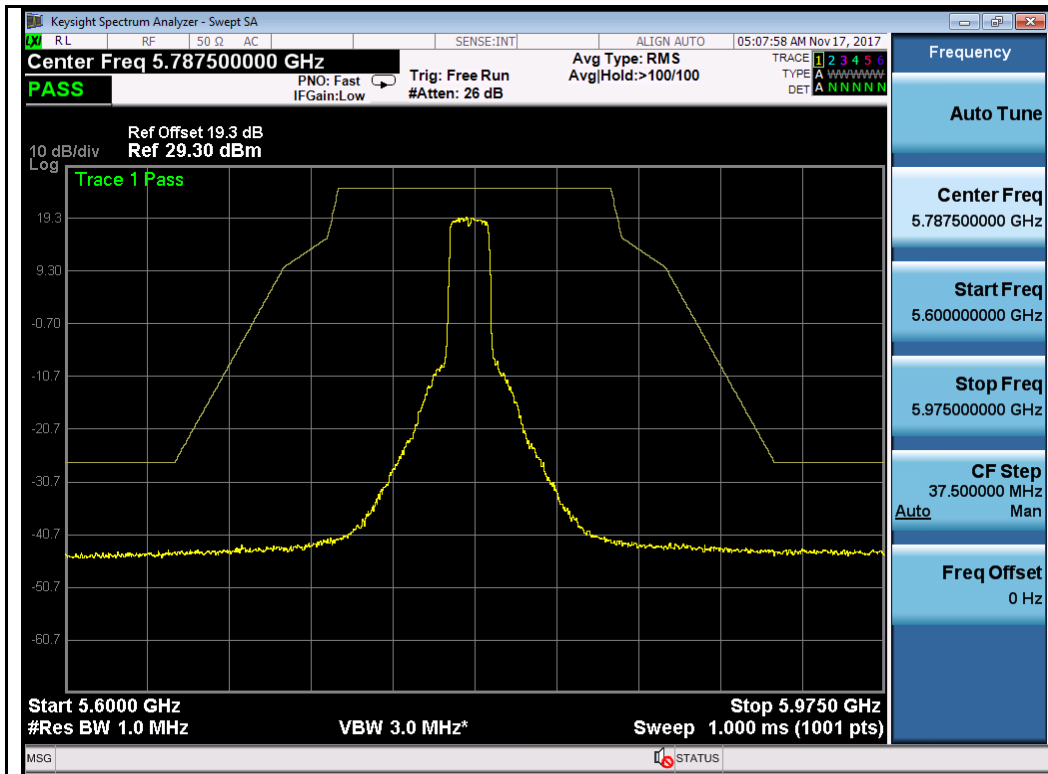

802.11n-HT20-5785MHz

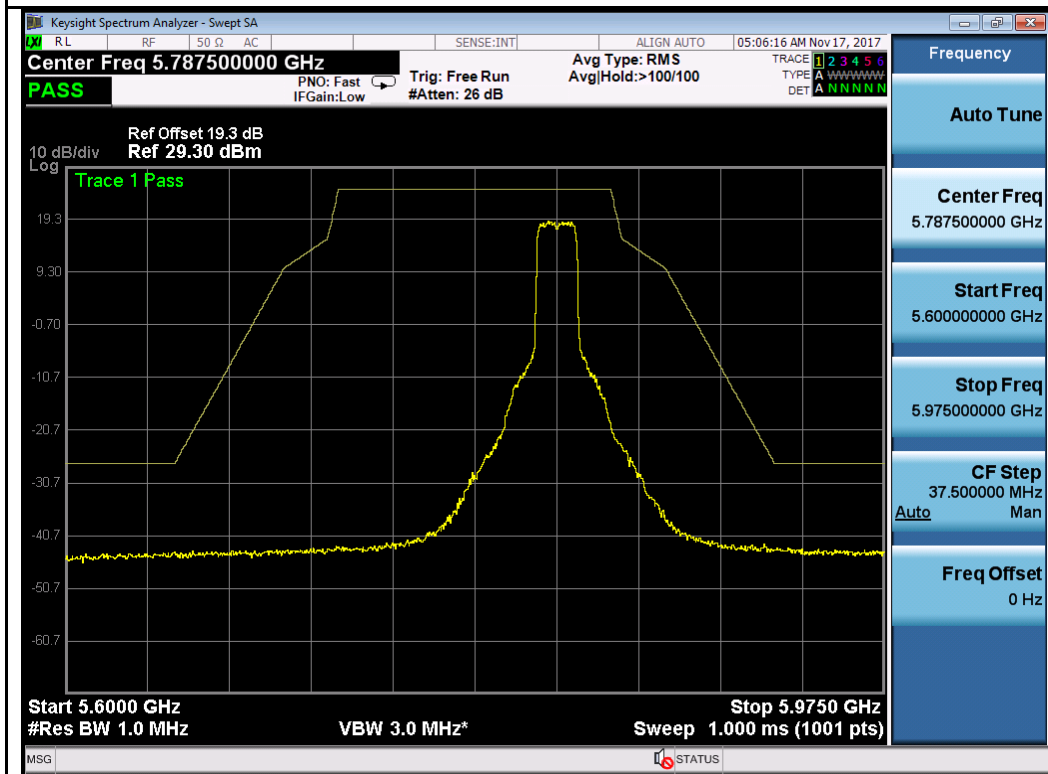

802.11n-HT20-5825MHz