



T310s Access Point Quick Setup Guide

NOTE: The minimum software revision for the T310s is ZoneDirector (ZD) 10.1 or later, or SmartZone (SZ) 3.6 or later, or standalone AP firmware 108.0 or later.

This Quick Setup Guide provides step-by-step instructions on how to field-install the Ruckus Wireless T310s access point (AP). For detailed information on planning the installation, performing a site survey, and operating the T310s, refer to the *Ruckus Wireless Outdoor Access Point User Guide*, available at <https://support.ruckuswireless.com>.

WARNING! Only trained and qualified personnel should be allowed to install, replace, or service this equipment.

WARNING! Installation of this equipment must comply with local and national electrical codes.

CAUTION! Make sure that you form a 80mm - 130mm (3"-5") drip loop in any cable that is attached to the AP or the building. This will prevent water from running along the cable and entering the AP or the building where the cable terminates.

CAUTION! Be sure that grounding is available and that it meets local and national electrical codes. For additional lightning protection, use lightning rods and lightning arrestors.

CAUTION! Make sure that proper lightning surge protection precautions are taken according to local electrical code.

WARNING! Ruckus Wireless strongly recommends that you wear eye protection before mounting the T310s.

This Guide in Other Languages

- 从以下网站得指南的体中文版 <https://support.ruckuswireless.com>.
- Vous trouverez la version française de ce guide à l'adresse suivante <https://support.ruckuswireless.com>.

- このガイドの日本語版は <https://support.ruckuswireless.com> でご覧ください。
- 이 가이드의 한국어 버전은 웹 사이트 (<https://support.ruckuswireless.com>) 에서 확인하시기 바랍니다.
- Veja a versão em português (Brasil) deste guia em <https://support.ruckuswireless.com>.
- Puede ver la versión en español (América Latina) de esta guía en <https://support.ruckuswireless.com>.

Before You Begin

Before deploying Ruckus Wireless products, please check for the latest software and the release documentation.

- Release Notes and other user documentation are available at <http://support.ruckuswireless.com/documents>.
- Software upgrades are available at <http://support.ruckuswireless.com/software>.
- Open source information is available at <http://opensource.ruckuswireless.com>.
- Software license and limited warranty information are available at <http://support.ruckuswireless.com/warranty>.

Before deploying your Ruckus Wireless Access Point, verify that all items listed in *Package Contents* are included in the package. If any item is damaged or missing, notify your authorized Ruckus Wireless sales representative. Also, make sure that you have the required hardware and tools.

Required Hardware and Tools

- No. 2 Phillips screwdriver
- Small flat-blade screwdriver
- Torque wrench or torque screwdriver with sockets
- Long-nose pliers
- Electrical wire stripping and terminal crimping pliers
- Pipe or pole --OR-- a sturdy flat surface
- Electric drill with drill bits and customer-supplied wall anchors, flat washers, and hex nuts for flat-surface mount

Package Contents

A complete T310s field installation package includes all of the items listed below (see Figure below for illustrations):

- T310s Access Point (A)
- M25 data cable gland (B)
- Ground wire with lug (C)
- Pole/Wall Mount Bracket Kit (D)
- Four steel pipe clamps
- Service Level Agreement/Limited Warranty Statement

- Declaration of Conformity
- Regulatory Statement
- Ruckus Wireless AP Getting Started Guide
- This Quick Setup Guide

FIGURE 1 T310s Package Contents

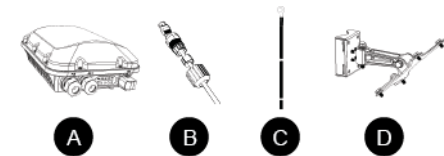

T310s Sector Antenna Coverage

The T310s 120-Degree Sector AP is best deployed where internal antenna directional beamwidths can provide extended reach and throughput to a 120-degree coverage area. See the illustrations below for the azimuth and elevation coverage patterns.

FIGURE 2 Typical AP sector azimuth plane coverage, top view

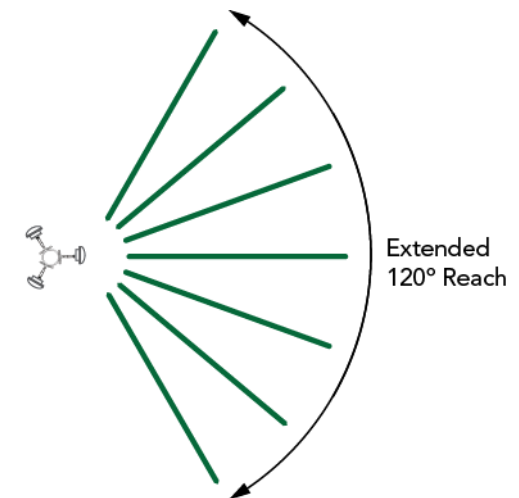
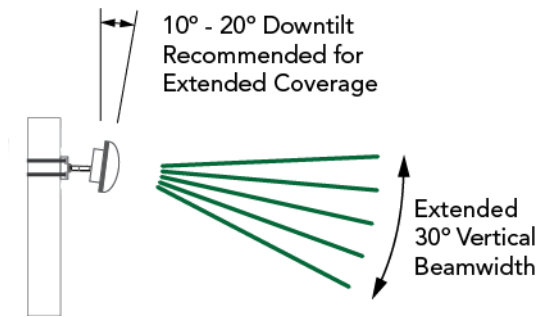

FIGURE 3 Typical AP sector elevation plane coverage, side view



Mounting Instructions

Connecting And Sealing the RJ-45 Cables

Connect and seal the RJ-45 cable(s) using the M25 data cable glands shown in the Figure below.

WARNING! Do not use any PoE injector not tested and approved by Ruckus Wireless to power the T310s Access Point.

FIGURE 4 T310s LEDs and Ports

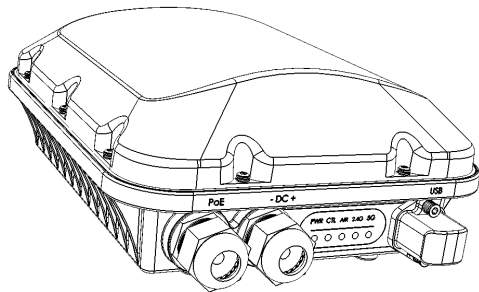

1. Feed the end of the cable through the sealing nut, rubber O-ring, clamping ring assembly and cable gland base as shown.

NOTE: Do not seat the clamping ring and rubber O-ring into the gland body until the gland body has been torqued to spec.

FIGURE 5 RJ-45 cable and cable gland assembly

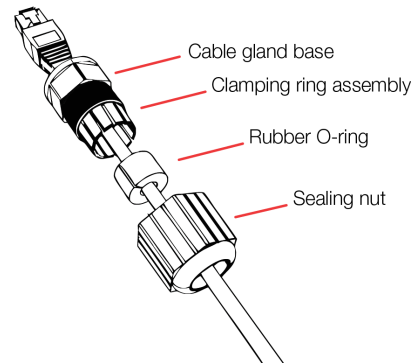

2. Use a wide flat-blade screwdriver to remove the required (PoE IN) blanking cap from the AP.
3. Connect the cable to the Ethernet port on the AP.
4. Tighten the cable gland base into the AP chassis to 7 N.m or 62 in-lbs.
5. Wrap the clamping ring assembly around the rubber O-ring. Make sure that the clamping ring assembly fully encloses the rubber O-ring.
6. Seat the clamping ring assembly and rubber O-ring in the cable gland base.
7. Hand-tighten the sealing nut.

Attaching the U-Joint Bracket to the Mounting Bracket

1. Position the U-joint bracket on the mounting bracket.

NOTE: Mount the U-joint bracket in any direction on the mounting bracket, preferably to allow AP azimuth adjustments. Then the AP bracket allows AP elevation adjustments.

FIGURE 6 U-joint bracket attached horizontally to the mounting bracket

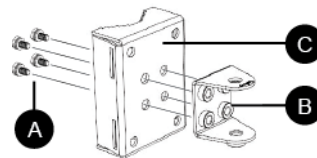

2. Use four 1/4-28 bolt and washer sets (A) to mount the U-joint bracket (B) to the mounting bracket (C). Tighten the bolts to 9.5 N.m (7 ft-lbs).

3. Continue with *Attaching the Mounting Bracket to a Flat Surface* or *Attaching the Mounting Bracket to a Pole*.

Attaching the Mounting Bracket to a Flat Surface

1. Place the mounting bracket at the location on the flat surface where you want to mount the AP. Use the holes on the mounting bracket as a template to mark the locations of the mounting holes.

FIGURE 7 Mounting bracket flat surface holes

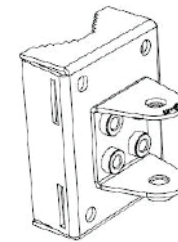

2. Remove the mounting bracket from the flat surface.
3. Drill holes required for the mounting hardware.

NOTE: The hardware required for mounting to a wall are not included in the mounting kit.

4. Attach the mounting bracket to the flat surface using the mounting hardware.
5. Using the mounting hardware instructions, tighten the hardware to secure the mounting bracket.
6. Continue with *Mounting the Linkage Bracket to the U-Joint Bracket*.

Attaching the Mounting Bracket to a Pole

1. Insert the open end of one steel clamp into the upper two slots on the mounting bracket.
2. Take the other steel clamp and insert it into the lower two slots on the mounting bracket.

NOTE: The clamps can be daisy-chained together to accommodate larger poles.

3. Use the clamps to attach the mounting bracket to the pole. Tighten the clamps to 3 N.m or 27 in-lbs, or per manufacturer's specifications.

FIGURE 8 Attaching the mounting bracket to a vertical pole

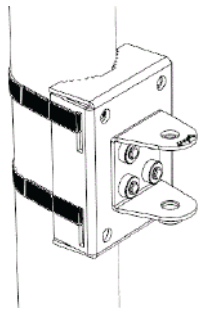

4. Continue with *Mounting the Linkage Bracket to the U-Joint Bracket*.

Mounting the Linkage Bracket to the U-Joint Bracket

1. The linkage bracket attaches to the U-joint bracket using an M8 bolt and washer set. The linkage bracket is symmetrical, and either end can be attached to the U-joint bracket.

NOTE: Make sure that linkage bracket is installed with its serrated external-tooth lock washer on the inside of the U-joint bracket flanges. This ensures that the azimuth adjustment does not change.

2. Loosely assemble the linkage bracket (A), the U-joint bracket (C), one serrated external-tooth lock washer (B), and one M8 bolt and washer set (D).

FIGURE 9 Attaching the linkage bracket to the U-joint bracket

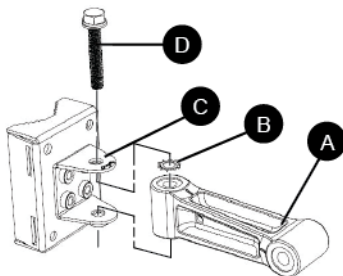

3. Set the azimuth required by the AP.
4. Tighten the M8 bolt to 13.6 N-m (10 ft-lbs).
5. Continue with *Attaching the AP Bracket to the Linkage Bracket*.

Attaching the AP Bracket to the Linkage Bracket

Attach the AP bracket to the linkage bracket using the included bolt, nut, lock washer, flat washer, serrated external-tooth washer shown in the illustration below.

The AP bracket attaches to the linkage bracket using an M8 bolt and washer set. The linkage bracket is symmetrical, and either end can be attached to the AP bracket.

NOTE: Make sure that linkage bracket is installed with its serrated external-tooth lock washer on the inside of the AP bracket flanges. This ensures that the elevation adjustment does not change.

As described in *Mounting the Linkage Bracket to the U-Joint Bracket*, loosely assemble the AP bracket to the linkage bracket using the second serrated external-tooth lock washer and the second M8 bolt and washer set.

FIGURE 10 Attach the linkage bracket to the AP bracket

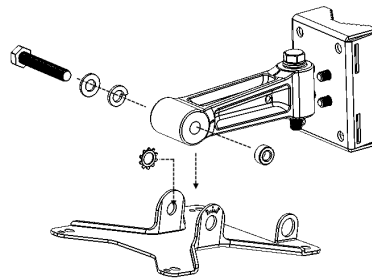

Attaching the AP Bracket to the Access Point

1. Place the AP bracket onto the back side of the AP so that the four larger screw holes on the bracket align with the four screw holes on the AP. Make sure that the end of the AP bracket with the hoisting loop is on the same side as the AP PoE IN port.

FIGURE 11 Attaching the AP bracket to the AP

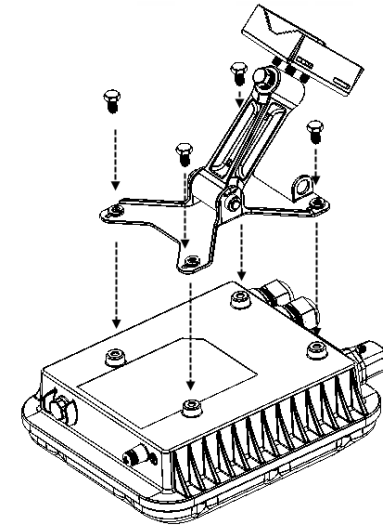

2. Use four 0.5-inch x 0.250-28 hex bolts with split lock and flat washer sets to mount the AP bracket to the AP. Tighten the bolts to 2.5-3.0 N.m or 22-27 in-lbs.

CAUTION! Make sure that the screws are no longer than 0.5 inch. If a screw is longer than 0.5 inch, it can damage the AP chassis.

3. If required, suspend the AP by attaching a carabiner to the hoisting loop on the AP bracket.

NOTE: This kit may include extra screws, nuts and washers. You may use the extras where required.

4. Continue with *Set the Elevation and Tighten Elevation Bolt*.

Set the Elevation and Tighten the Elevation Bolt

1. Set the elevation required by the AP.
2. Tighten the M8 bolt to 13.6 N-m (10 ft-lbs).
3. Continue with *Powering the AP with DC*.

Powering the AP with DC

The T310s can accommodate two sources of power – PoE (48V) power and 12V DC.

The T310s can draw power from the Ethernet input as a class 3 device, providing a maximum of 12.95W to the system. Alternately, power can be supplied through a customer-provided 12V DC power supply (7-20V DC acceptable) that will connect to a two pin terminal block. The terminal block is accessible through a water-tight gland on one end of the unit. The terminal block connection has surge and polarity protection to protect against inserting the wrong polarity leads into the terminal block.

NOTE: When both 12V DC and the 48V PoE power are active, the T310s will prioritize the 12VDC power.

NOTE: If DC cables are individual wires, then a special cable gland insert is required for IP67 seal.

1. Install the DC power supply as described in the DC power supply accessory installation guide.
2. Connect the power cord to a DC power source.
3. Verify that the PWR LED is a steady green.

Earth Grounding the AP

CAUTION! Make sure that earth grounding is available and that it meets local and national electrical codes. For additional lightning protection, use lightning rods and lightning arrestors.

NOTE: The color coding of ground wires varies by region. Before completing this step, check your local wiring standards for guidance.

Using the factory-supplied ground wire and ground screw/washer set, connect a good earth ground to the AP chassis ground point.

CAUTION! The T310s AP includes one 9mm stainless steel M6x1 earth ground screw with split lock and flat washers. Make sure that any replacement screw is no longer than 9mm. If a screw is longer than 9mm, it can damage the AP chassis.

FIGURE 12 Connect good earth ground to AP here

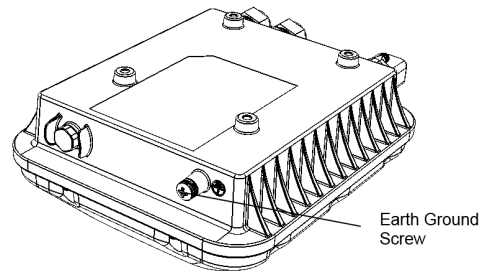

Congratulations! You have mounted your T310s access point.

Installing a USB Dongle

To install a USB dongle (such as an IoT radio device such as BLE, 802.15.4, Z-wave or similar), remove the two 3mm hex screws, remove the cap, and insert the dongle into the USB port.

Once installed, replace the cap and the hex screws, and torque the screws to 7 in-lbs (0.79 N.m).

NOTE: If required, a larger USB dongle cap can be purchased separately. The maximum dimensions of the USB dongle that can be inserted (with the large USB dongle cap, part # 902-0127-000) are 6 cm x 2 cm x 1.1 cm. Max Power: 450mW (SiLabs EM3578 max current draw at +20 dBm is 80mA over a 3.3V rail).

FIGURE 13 Installing a USB dongle

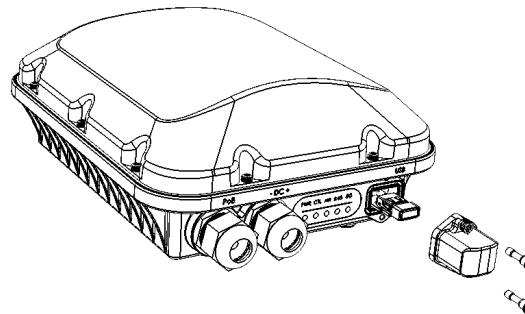

Troubleshooting

CAUTION! If required, you can reset the AP to its factory default settings by pressing the reset button located inside the PoE IN port. **DO NOT DO THIS UNLESS SO INSTRUCTED.** (Doing this resets the AP IP address to 192.168.0.1.)

NOTE: After a reset, you can access the internal AP web interface using <https://192.168.0.1>. Your device must use any other address from 192.168.0.2 through 192.168.0.254, with subnet mask 255.255.255.0. The username is super, and the password is sp-admin. Refer to the *Outdoor Access Point User Guide* for information on configuring and operating the AP. This document is available at <https://support.ruckuswireless.com>.

For More Information

For information on how to configure and manage the AP, refer to the *Ruckus Wireless Outdoor Access Point User Guide*, available from <https://support.ruckuswireless.com>.