





FCC PART 15.407  
**DYNAMIC FREQUENCY SELECTION  
 TEST AND MEASUREMENT REPORT**

For

**Ruckus Wireless, Inc.**

350 West Java Drive,  
 Sunnyvale, CA 94089, USA

**FCC ID: S9GT300**

<b>Report Type:</b> Class II Permissive Change	<b>Equipment Type:</b> 802.11a/b/g/n/ac Wireless Access Point
<b>Prepared By:</b> Rui Zhou	
<b>Report Number:</b> R1410275-DFS	
<b>Report Date:</b> 2015-06-26	
<b>Reviewed By:</b> Bo Li	
<b>RF Lead</b>	
Bay Area Compliance Laboratories Corporation (BACL) 1274 Anvilwood Avenue, Sunnyvale, CA 94089, USA Tel: (408) 732-9162 Fax: (408) 732-9164	

**Note:** This test report is prepared for the customer shown above and for the device described herein. It may not be duplicated or used in part without prior written consent from Bay Area Compliance Laboratories Corp. This report **must not** be used by the customer to claim product certification, approval, or endorsement by A2LA\* or any agency of the Federal Government.

\* This report may contain data that are not covered by the A2LA accreditation and are marked with an asterisk "\*" (b)(3)

## TABLE OF CONTENTS

<b>1</b>	<b>GENERAL DESCRIPTION.....</b>	<b>5</b>
1.1	PRODUCT DESCRIPTION FOR EQUIPMENT UNDER TEST (EUT).....	5
1.2	MECHANICAL DESCRIPTION OF EUT.....	5
1.3	OBJECTIVE.....	5
1.4	RELATED SUBMITTAL(S)/GRANT(S).....	5
1.5	TEST METHODOLOGY.....	5
1.6	TEST FACILITY.....	6
<b>2</b>	<b>EUT TEST CONFIGURATION.....</b>	<b>8</b>
2.1	JUSTIFICATION.....	8
2.2	EUT EXERCISE SOFTWARE.....	8
2.3	EQUIPMENT MODIFICATIONS.....	8
2.4	LOCAL SUPPORT EQUIPMENT.....	8
2.5	EUT INTERNAL CONFIGURATION DETAILS.....	8
2.6	INTERFACE PORTS AND CABLES.....	8
2.7	POWER SUPPLY LIST AND DETAILS.....	9
<b>3</b>	<b>SUMMARY OF TEST RESULTS.....</b>	<b>10</b>
<b>4</b>	<b>APPLICABLE STANDARDS.....</b>	<b>11</b>
4.1	DFS REQUIREMENT.....	11
4.2	DFS MEASUREMENT SYSTEM.....	14
4.3	SYSTEM BLOCK DIAGRAM.....	14
4.4	CONDUCTED METHOD.....	15
4.5	RADIATED METHOD.....	16
4.6	TEST PROCEDURE.....	16
<b>5</b>	<b>TEST RESULTS.....</b>	<b>17</b>
5.1	DESCRIPTION OF EUT.....	17
5.2	TEST EQUIPMENT LIST AND DETAILS.....	17
5.3	RADAR WAVEFORM CALIBRATION.....	18
5.4	TEST ENVIRONMENTAL CONDITIONS.....	18
<b>6</b>	<b>CHANNEL AVAILABILITY CHECK TIME (CAC).....</b>	<b>27</b>
6.1	TEST PROCEDURE.....	27
<b>7</b>	<b>CHANNEL MOVE TIME AND CHANNEL CLOSING TRANSMISSION TIME.....</b>	<b>34</b>
7.1	TEST PROCEDURE.....	34
7.2	TEST RESULTS.....	34
<b>8</b>	<b>NON-OCCUPANCY PERIOD.....</b>	<b>39</b>
8.1	TEST PROCEDURE.....	39
8.2	TEST RESULTS.....	39
<b>9</b>	<b>RADAR DETECTION BANDWIDTH &amp; RADAR DETECTION PERFORMANCE CHECK.....</b>	<b>41</b>
9.1	DETECTION BANDWIDTH.....	41
9.2	RADAR DETECTION PERFORMANCE CHECK.....	47
<b>10</b>	<b>APPENDIX A – TEST SETUP PHOTOGRAPHS.....</b>	<b>241</b>
10.1	DFS TEST SETUP VIEW.....	241
<b>11</b>	<b>APPENDIX B – EUT PHOTOGRAPHS.....</b>	<b>242</b>
11.1	EUT- TOP VIEW.....	242

---

<b>11.2</b>	EUT- BOTTOM VIEW .....	242
<b>11.3</b>	EUT - OPEN CASE VIEW.....	243
<b>11.4</b>	EUT - MAIN PCB BOARD.....	243
<b>11.5</b>	EUT - MAIN PCB BOARD REAR VIEW .....	244
<b>11.6</b>	EUT - RJ45 PORT FRONT VIEW.....	244
<b>11.7</b>	EUT - RJ45 PORT REAR VIEW.....	245
<b>11.8</b>	EUT - RUCKUS BOARD FRONT VIEW .....	245
<b>11.9</b>	EUT - IZAR BOARD FRONT VIEW.....	246
<b>11.10</b>	EUT - IZAR CROSS BOARD FRONT VIEW.....	246
<b>11.11</b>	AC ADAPTER .....	247

**DOCUMENT REVISION HISTORY**

<b>Revision Number</b>	<b>Report Number</b>	<b>Description of Revision</b>	<b>Date of Revision</b>
0	R1410275-DFS	Initial	2015-06-26

---

## 1 General Description

---

### 1.1 Product Description for Equipment under Test (EUT)

This test and measurement report was prepared on behalf of *Ruckus Wireless, Inc.*, and their product FCC ID: S9GT300, model: T300e or the “EUT” as referred to in this report. The EUT is an 802.11a/b/g/n/ac access point.

### 1.2 Mechanical Description of EUT

The EUT measures approximately 183 mm (L) x 154 mm (W) x 77 mm (H) and weighs approximately 900 g.

The test data gathered are from typical production sample, serial number: 25140600007

### 1.3 Objective

This report is prepared on behalf of *Ruckus Wireless, Inc.* in accordance with FCC CFR47 §15.407 (h), and KDB: 905462 D02 UNII DFS Compliance Procedures New Rules v01r01

This Class II Permissive Change for updating UNII DFS test data per KDB 905462 D02 DFS compliance procedure new rules. The objective is to determine compliance with FCC rules for DFS Detection Threshold, Channel Availability Check Time, Uniform Spreading U-NII Detection Bandwidth, Channel Closing Transmission Time, and Channel Move time in Master Mode.

### 1.4 Related Submittal(s)/Grant(s)

FCC ID: S9GT300

### 1.5 Test Methodology

FCC CFR 47 Part2, Part15.407 (h)

KDB: 905462 D02 UNII DFS Compliance Procedures New Rules v01r01

COMPLIANCE MEASUREMENT PROCEDURES FOR UNLICENSED-NATIONAL INFORMATION INFRASTRUCTURE DEVICES OPERATING IN THE 5250-5350 MHz AND 5470-5725 MHz BANDS INCORPORATING DYNAMIC FREQUENCY SELECTION

## 1.6 Test Facility

Bay Area Compliance Laboratories Corp. (BACL) is:

1- An independent Commercial Test Laboratory accredited to **ISO 17025: 2005** by **A2LA**, in the fields of: Electromagnetic Compatibility & Telecommunications covering Emissions, Immunity, Radio, RF Exposure, Safety and Telecom. This includes NEBS (Network Equipment Building System), Wireless RF, Telecommunications Terminal Equipment (TTE); Network Equipment; Information Technology Equipment (ITE); Medical Electrical Equipment; Industrial, Commercial, and Medical Test Equipment; Professional Audio and Video Equipment; Electronic (Digital) Products; Industrial and Scientific Instruments; Cabled Distribution Systems and Energy Efficiency Lighting.

2- An ENERGY STAR Recognized Laboratory, for the LM80 Testing, a wide variety of Luminaires and Computers.

3- A NIST Designated Phase-I and Phase-II CAB including: ACMA (Australian Communication and Media Authority), BSMI (Bureau of Standards, Metrology and Inspection of Taiwan), IDA (Infocomm Development Authority of Singapore), IC (Industry Canada), Korea (Ministry of Communications Radio Research Laboratory), NCC (Formerly DGT; Directorate General of Telecommunication of Chinese Taipei) OFTA (Office of the Telecommunications Authority of Hong Kong), Vietnam, VCCI - Voluntary Control Council for Interference of Japan and a designated EU CAB (Conformity Assessment Body) (Notified Body) for the EMC and R&TTE Directives.

4 - A Product Certification Body accredited to **ISO Guide 65: 1996** by **A2LA** to certify:

1- Unlicensed, Licensed radio frequency devices and Telephone Terminal Equipment for the FCC. Scope A1, A2, A3, A4, B1, B2, B3, B4 & C.

2. Radio Standards Specifications (RSS) in the Category I Equipment Standards List and All Broadcasting Technical Standards (BETS) in Category I Equipment Standards List for Industry Canada.

3. Radio Communication Equipment for Singapore.

4. Radio Equipment Specifications, GMDSS Marine Radio Equipment Specifications, and Fixed Network Equipment Specifications for Hong Kong.

5. Japan MIC Telecommunication Business Law (A1, A2) and Radio Law (B1, B2 and B3).

6. Audio/Video, Battery Charging Systems, Computers, Displays, Enterprise Servers, Imaging Equipment, Set-Top Boxes, Telephony, Televisions, Ceiling Fans, CFLs (including GU24s), Decorative Light Strings, Integral LED Lamps, Luminaires, Residential Ventilating Fans.

The test site used by BACL Corp. to collect radiated and conducted emissions measurement data is located at its facility in Sunnyvale, California, USA.

The test site at BACL Corp. has been fully described in reports submitted to the Federal Communication Commission (FCC) and Voluntary Control Council for Interference (VCCI). The details of these reports have been found to be in compliance with the requirements of Section 2.948 of the FCC Rules on February 11 and December 10, 1997, and Article 8 of the VCCI regulations on December 25, 1997. The test site also complies with the test methods and procedures set forth in CISPR 22:2008 §10.4 for measurements below 1 GHz and §10.6 for measurements above 1 GHz, as well as ANSI C63.4-2009, ANSI C63.4-2009, TIA/EIA-603 & CISPR 24: 2010.

The Federal Communications Commission and Voluntary Control Council for Interference have the reports on file and they are listed under FCC registration number: 90464 and VCCI Registration No.: A-0027. The test site has been approved by the FCC and VCCI for public use and is listed in the FCC Public Access Link (PAL) database.

Additionally, BACL Corp. is an American Association for Laboratory Accreditation (A2LA) accredited laboratory (Lab Code 3297-02). The current scope of accreditations can be found at

<http://www.a2la.org/scopepdf/3297-02.pdf?CFID=1132286&CFTOKEN=e42a3240dac3f6ba-6DE17DCB-1851-9E57-477422F667031258&jsessionid=8430d44f1f47cf2996124343c704b367816b>

## 2 EUT Test Configuration

### 2.1 Justification

The EUT was configured for testing according to FCC Part 15.407(H), and KDB: 905462 D02 UNII DFS Compliance Procedures New Rules v01r01

### 2.2 EUT Exercise Software

The test utility used version was 9.6.0 was provided by Ruckus Wireless Inc., and was verified by Bo Li to comply with the standard requirements being tested against.

### 2.3 Equipment Modifications

N/A

### 2.4 Local Support Equipment

Manufacturer	Description	Model	Serial Number
Dell	Laptop	Latitude E5420	CHZCMQ1

### 2.5 EUT Internal Configuration Details

Manufacturer	Description	Model	Serial Number
Ruckus	Main Board (SANTORINI)	ASM 120-11257 rev.4	411494908407
Ruckus	RJ45 Port Board	ASM 120-11264 rev. 2	1427
Ruckus	Ruckus Board	ASM 120-11229 rev. A	1439
Ruckus	IZAR Board	ASM 120-11261 rev. 3	1429
Ruckus	IZAR CROSS Board	ASM 120-11262 rev. 3	1433

### 2.6 Interface Ports and Cables

Cable Description	Length (m)	From	To
RJ45 Cable	1m	Laptop	POE
RJ45 Cable	1m	POE	EUT
RF Cable x2	<1m	EUT	PSA



**2.7 Power Supply List and Details**

<b>Manufacturer</b>	<b>Description</b>	<b>Model</b>	<b>Part Number</b>
Ruckus	POE AC Power Supply	740-64214-001	-

### 3 Summary of Test Results

The following result table represents the list of measurements required under the CFR47 §47 Part15.407 (h), and KDB: 905462 D02 UNII DFS Compliance Procedures New Rules v01r01. This report is to update from KDB: 905462 D02 UNII DFS Compliance Procedures Old rules v01 to KDB: 905462 D02 UNII DFS Compliance Procedures New Rules v01r01

Items	Description of Test	Results
Detection Bandwidth	UNII Detection Bandwidth	Compliant
Performance Requirements Check	Initial Channel Availability Check Time (CAC)	Compliant
	Radar Burst at the Beginning of the CAC	Compliant
	Radar Burst at the End of the CAC	Compliant
In-Service Monitoring	Channel Move Time	Compliant
	Channel Closing Transmission Time	Compliant
	Non-Occupancy Period	Compliant
Radar Detection	Statistical Performance Check	Compliant

## 4 Applicable Standards

### 4.1 DFS Requirement

FCC CFR47 §15.407 (h), and KDB: 905462 D02 UNII DFS Compliance Procedures New Rules v01r01

**Table 1: Applicability of DFS requirements prior to use of a channel**

Requirement	Operational Mode		
	Master	Client (Without radar detection)	Client (With radar detection)
Non-Occupancy Period	Yes	Not Required	Yes
DFS Detection Threshold	Yes	Not Required	Yes
Channel Availability Check Time	Yes	Not Required	Not Required
U-NII Detection Bandwidth	Yes	Not Required	Yes

**Table 2: Applicability of DFS requirements during normal operation**

Requirement	Operational Mode	
	Master Device or Client with Radar Detection	Client Without Radar Detection
DFS Detection Threshold	Yes	Not Required
Channel Closing Transmission Time	Yes	Yes
Channel Move Time	Yes	Yes
U-NII Detection Bandwidth	Yes	Not Required

Additional requirements for devices with multiple bandwidth modes	Master Device or Client with Radar Detection	Client Without Radar Detection
U-NII Detection Bandwidth and Statistical Performance Check	All BW modes must be tested	Not required
Channel Move Time and Channel Closing Transmission Time	Test using widest BW mode available	Test using the widest BW mode available for the link
All other tests	Any single BW mode	Not required
<b>Note:</b> Frequencies selected for statistical performance check (Section 7.8.4) should include several frequencies within the radar detection bandwidth and frequencies near the edge of the radar detection bandwidth. For 802.11 devices it is suggested to select frequencies in each of the bonded 20 MHz channels and the channel center frequency.		

**Table 3: Interference Threshold values, Master or Client incorporating In-Service Monitoring**

Maximum Transmit Power	Value (See Notes 1, 2 and 3)
EIRP $\geq$ 200 milliwatt	-64 dBm
EIRP $<$ 200 milliwatt and power spectral density $<$ 10dBm/MHz	-62 dBm
EIRP $<$ 200 milliwatt that do not meet the power spectral density requirement	-64 dBm

**Note 1:** This is the level at the input of the receiver assuming a 0 dBi receive antenna.  
**Note 2:** Throughout these test procedures an additional 1 dB has been added to the amplitude of the test transmission waveforms to account for variations in measurement equipment. This will ensure that the test signal is at or above the detection threshold level to trigger a DFS response.  
**Note 3:** EIRP is based on the highest antenna gain. For MIMO devices refer to KDB Publication 662911D01.

**Table 4: DFS Response Requirement Values**

Parameter	Value
Non-occupancy period	Minimum 30 minutes
Channel Availability Check Time	60 seconds
Channel Move Time	10 seconds See Note 1.
Channel Closing Transmission Time	200 milliseconds + an aggregate of 60 milliseconds over remaining 10 second period. See Notes 1 and 2.
U-NII Detection Bandwidth	Minimum 100% of the UNII 99% transmission power bandwidth. See Note 3.

**Note 1:** The instant that the *Channel Move Time* and the *Channel Closing Transmission Time* begins is as follows:

- For the Short Pulse Radar Test Signals this instant is the end of the *Burst*.
- For the Frequency Hopping radar Test Signal, this instant is the end of the last radar *Burst* generated.
- For the Long Pulse Radar Test Signal this instant is the end of the 12 second period defining the *Radar Waveform*.

**Note 2:** The *Channel Closing Transmission Time* is comprised of 200 milliseconds starting at the beginning of the *Channel Move Time* plus any additional intermittent control signals required to facilitate a *Channel* move (an aggregate of 60 milliseconds) during the remainder of the 10 second period. The aggregate duration of control signals will not count quiet periods in between transmissions.

**Note 3:** During the *U-NII Detection Bandwidth* detection test, radar type 0 is used and for each frequency step the minimum percentage of detection is 90 percent. Measurements are performed with no data traffic.

**Table 5: Short Pulse Radar Test Waveforms**

Radar Type	Pulse Width (Microseconds)	PRI (Microseconds)	Pulses	Minimum Percentage of Successful Detection	Minimum Number of Trials
0	1	1428	18	See Note 1	See Note 1
1	1	Test A: 15 unique PRI values randomly selected from the list of 23 PRI values in Table 5a	$\text{Roundup} \left( \frac{1}{360} \cdot \left( \frac{19 \cdot 10^6}{\text{PRI}_{\mu\text{sec}}} \right) \right)$	60%	30
		Test B: 15 unique PRI values randomly selected within the range of 518-3066 μsec, with a minimum increment of 1 μsec, excluding PRI values selected in Test A			
2	1-5	150-230	23-29	60%	30
3	6-10	200-500	16-18	60%	30
4	11-20	200-500	12-16	60%	30
Aggregate (Radar Types 1-4)				80%	120
<b>Note 1:</b> Short Pulse Radar Type 0 should be used for the detection bandwidth test, channel move time, and channel closing time tests.					

**Table 6: Long Pulse Radar Test Signal**

Radar Type	Bursts	Chirp Width (MHz)	PRI (usec)	Number of Pulses per Burst	Number of Bursts	Minimum Percentage of Successful Detection	Minimum Number of Trials
5	50-100	5-20	1000-2000	1-3	8-20	80%	30

**Table 7: Frequency Hopping Radar Test Signal**

Radar Type	Pulse Width (usec)	PRI (usec)	Pulses per Hop	Hopping Rate (kHz)	Hopping Sequence Length (msec)	Minimum Percentage of Successful Detection	Minimum Number of Trials
6	1	333	9	0.333	300	70%	30

## 4.2 DFS Measurement System

BACL DFS measurement system consists of two subsystems: (1) The radar signal generating subsystem and (2) the traffic monitoring subsystem.

## 4.3 System Block Diagram

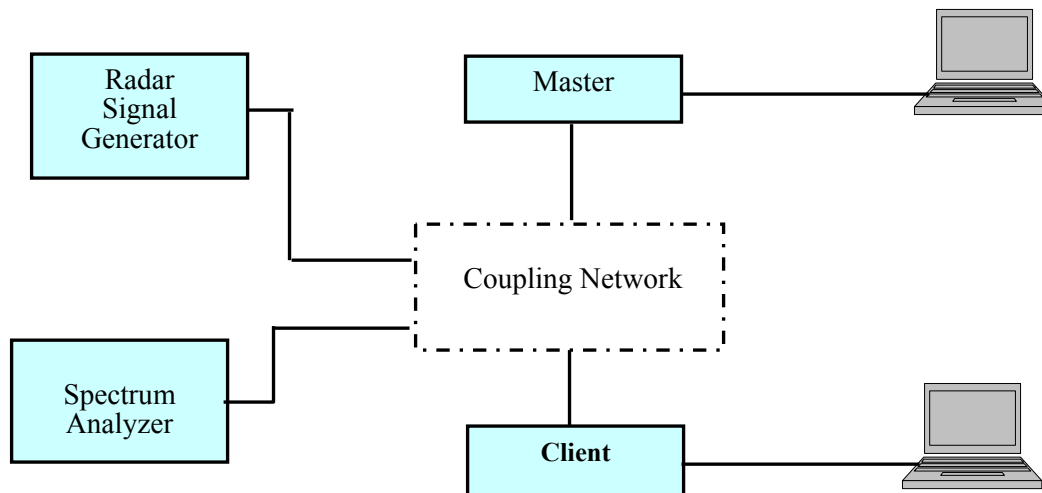

### 4.4 Conducted Method

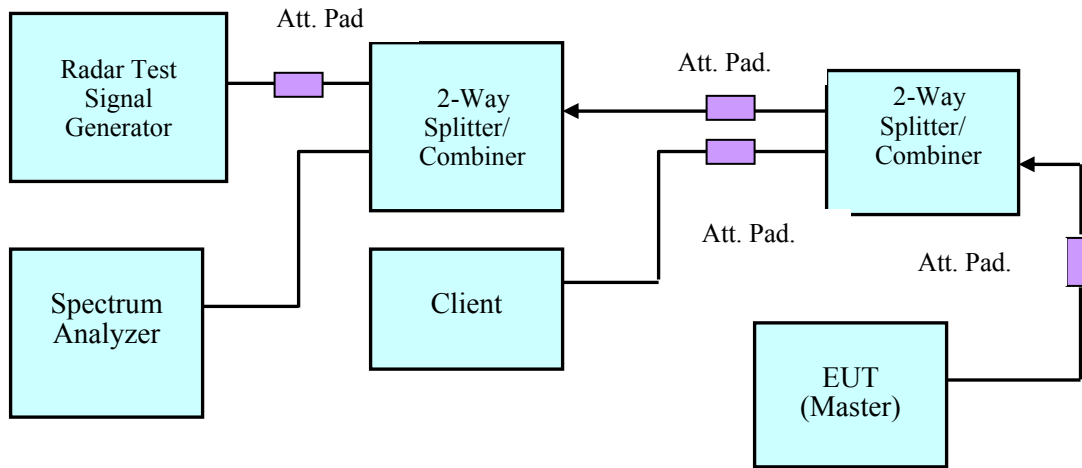

**Setup for Master with injection at the Master**

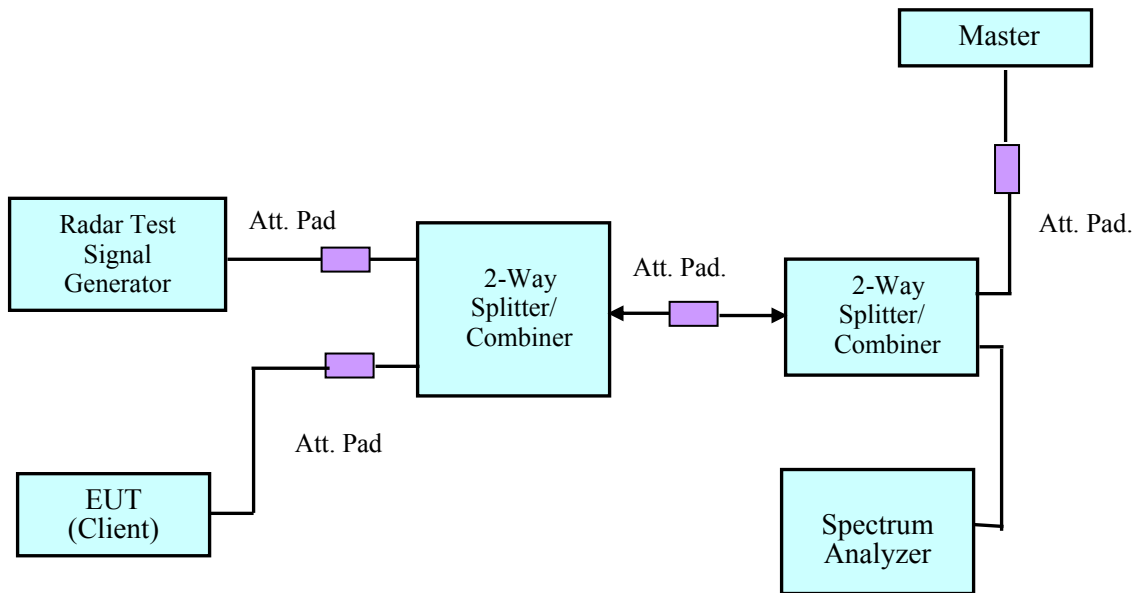

**Setup for Client with injection at the Master**

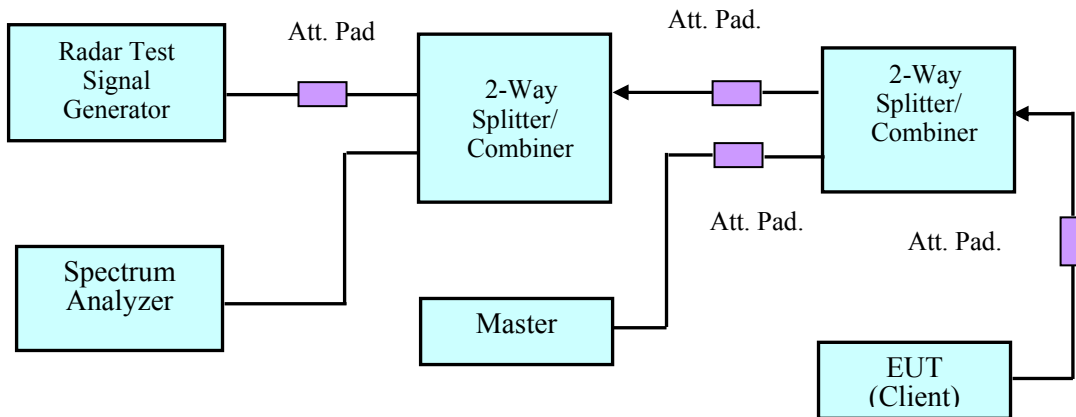

**Setup for Client with injection at the Client**

**4.5 Radiated Method**

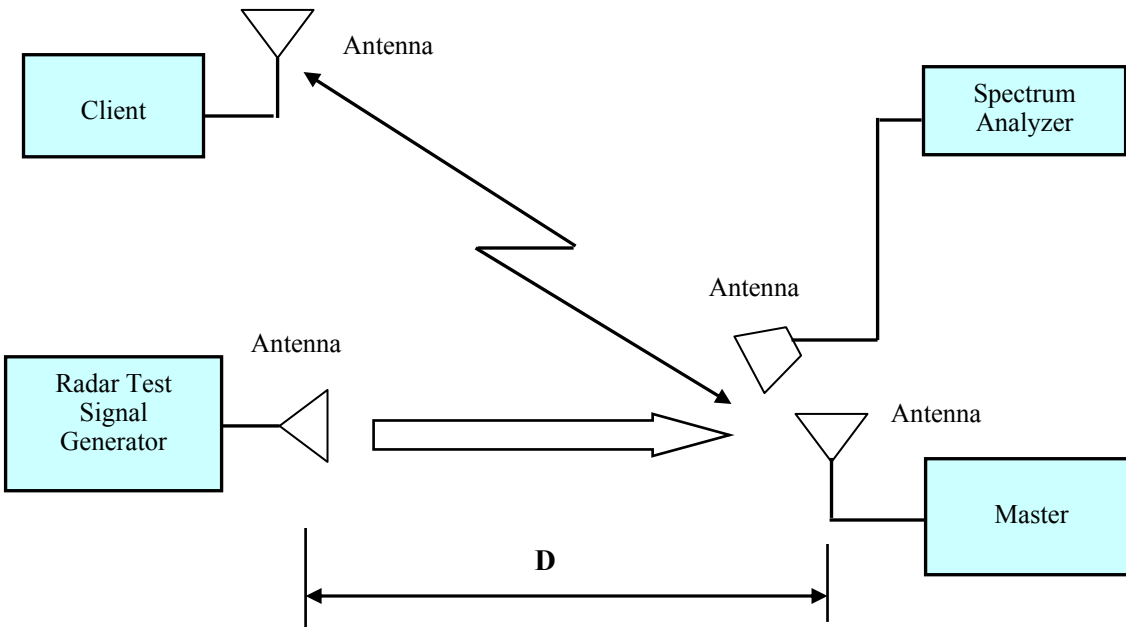

**4.6 Test Procedure**

A spectrum analyzer is used as a monitor that verifies the EUT’s status, which includes the Channel Closing Transmission Time and the Channel Move Time. The Spectrum analyzer is used to monitor the equipment under test (EUT) does not transmit on the same channel during the Non-Occupied Period after the radar detection. It is also used to monitor EUT transmissions during the Channel Availability Check Time.



## 5 Test Results

### 5.1 Description of EUT

The EUT operates in 5230-5350 MHz and 5470-5725 MHz range in Master Mode.

The rated output power of EUT is > 23 dBm (EIRP), Therefore the required interference threshold level is -64 dBm, the required radiated threshold at antenna port is -64 dBm.

The calibrated radiated DFS detection threshold level is set to -64 dBm.

WLAN traffic is generated by streaming the video file TestFile.mpg, this file is used by IP and Frame based systems for loading the test channel during the In-service compliance testing of the U-NII device. The file is streamed from the Access Point to the Client in full motion video mode using the media player with the V2.61 Codec package.

The EUT was tested with the 2 dBi gain antenna.

### 5.2 Test Equipment List and Details

Manufacturer	Equipment Description	Model	S/N	Calibration Date
National Instruments	NI PXI-1042 8-Slot chassis	PXI-1042	V08X01EE1	N/A
National Instruments	Arbitrary Waveform Generator	PXI-5421	N/A	N/A
National Instruments	RF Upconverter	PXI-5610	N/A	N/A
ASCOR	Upconverter	AS-7206	N/A	N/A
Agilent	Spectrum Analyzer	E4440A	MY44303352	2014-10-16
A.R.A.	Antenna Horn	DRG-118/A	1132	2015-01-29
EMCO	Antenna Horn	3115	9511-4627	2014-10-17
Mini-Circuits	Splitter/Combiner	2FSC-2-10G	0349	N/A
Narda	Splitter/Combiner	4326B-2	03514	N/A
Midwest	Attenuator	290-30	N/A	N/A
Mini-Circuits	Attenuator	BW-S30W2	N/A	N/A

**Statement of Traceability:** **BACL Corp.** attests that all calibrations have been performed per the A2LA requirements, traceable to the NIST.

### 5.3 Radar Waveform Calibration

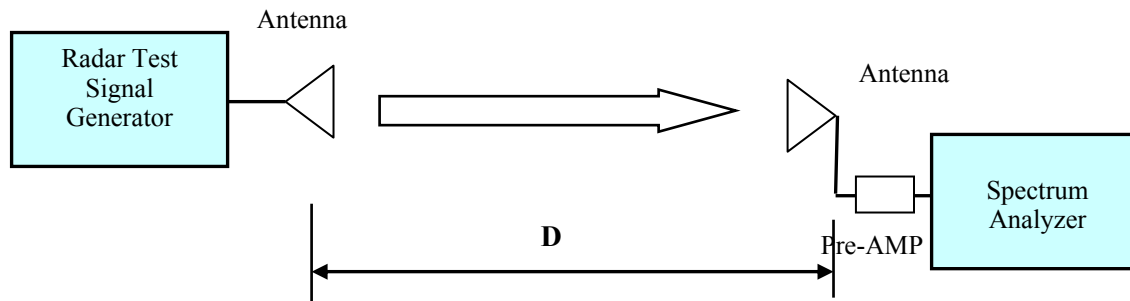

**Radiated Calibration Setup Block Diagram**

### 5.4 Test Environmental Conditions

<b>Temperature:</b>	23° C
<b>Relative Humidity:</b>	33 %
<b>ATM Pressure:</b>	101.65 kPa

*Testing performed by Ray Zhou on 2015-05-12 at DFS testing site.*

**Plots of Radar Waveforms**

5280 MHz

**Radar Type 0**

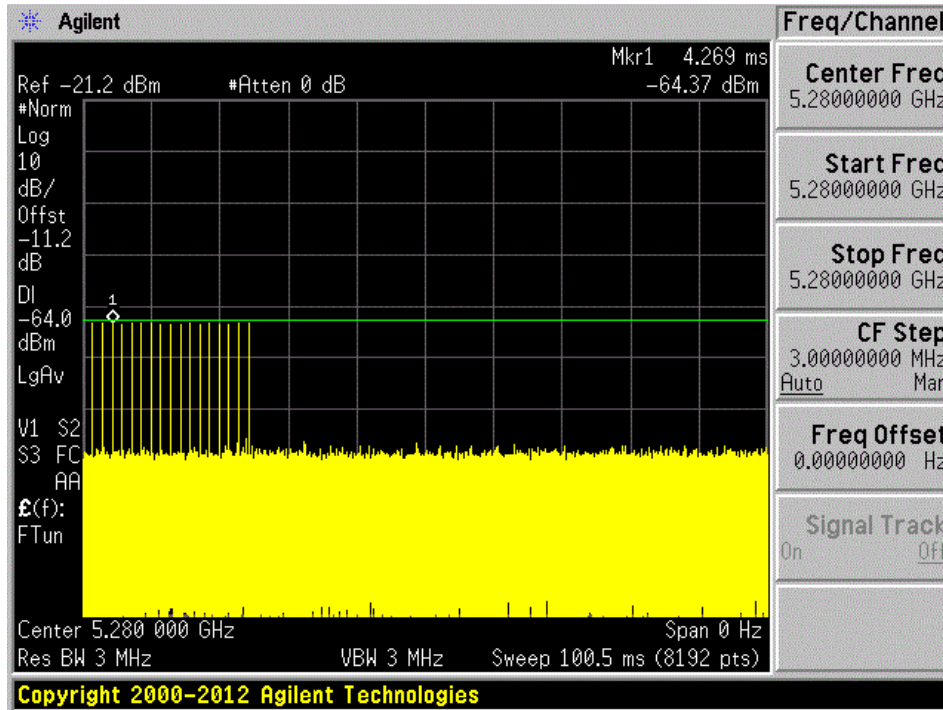

**Radar Type 1A**

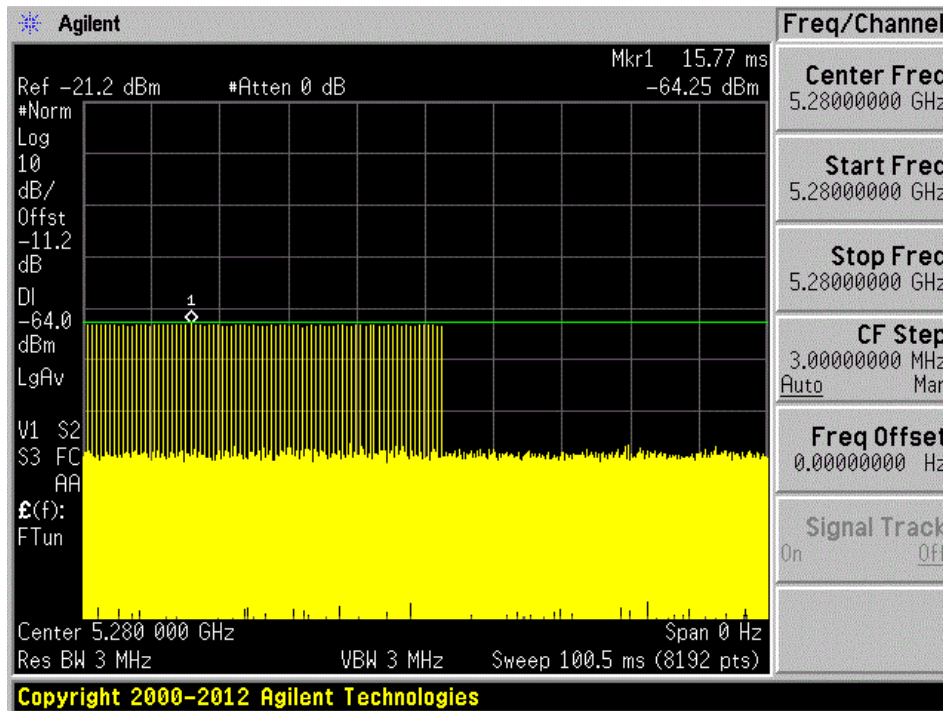

### Radar Type 1B

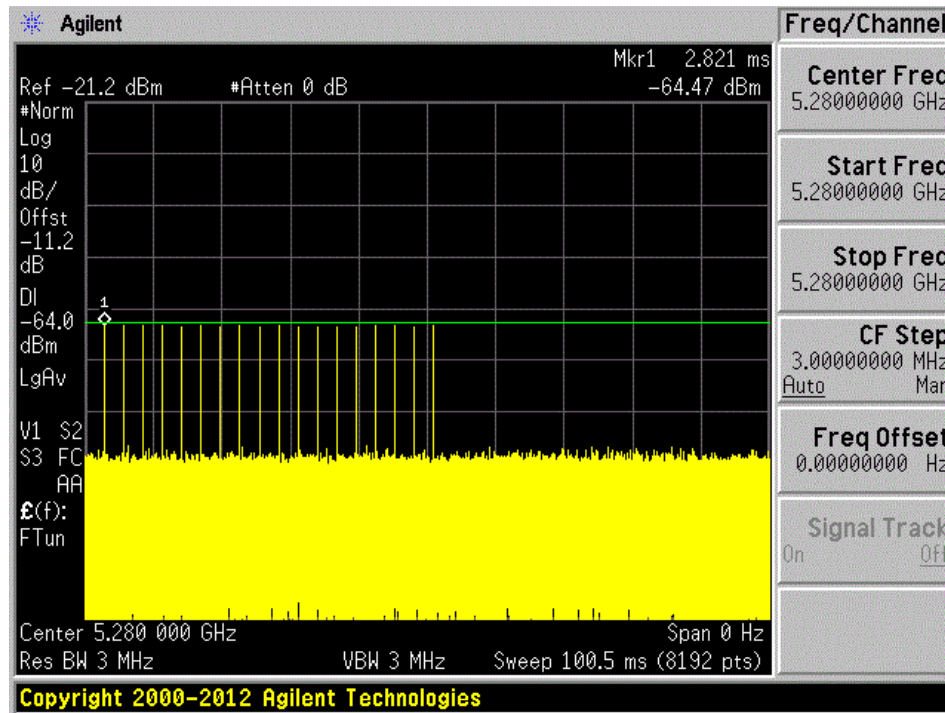

### Radar Type 2

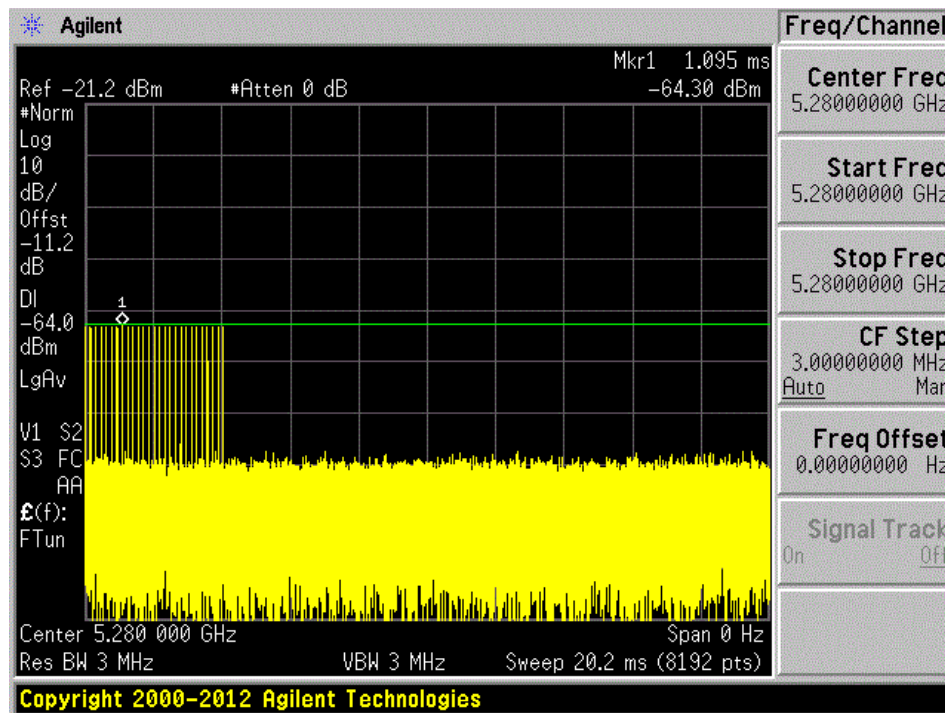

### Radar Type 3

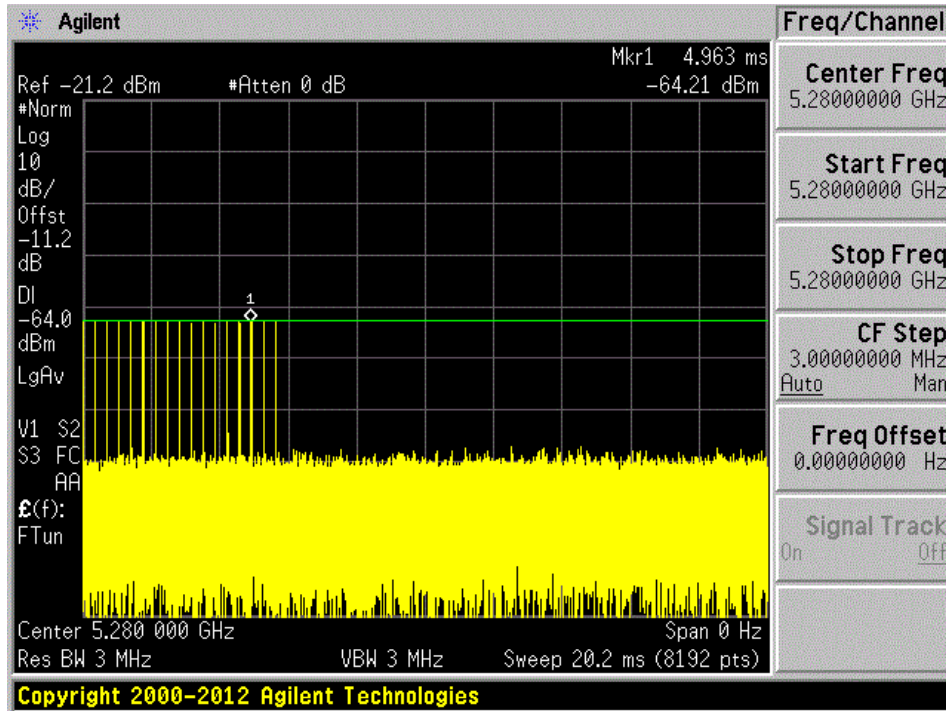

### Radar Type 4

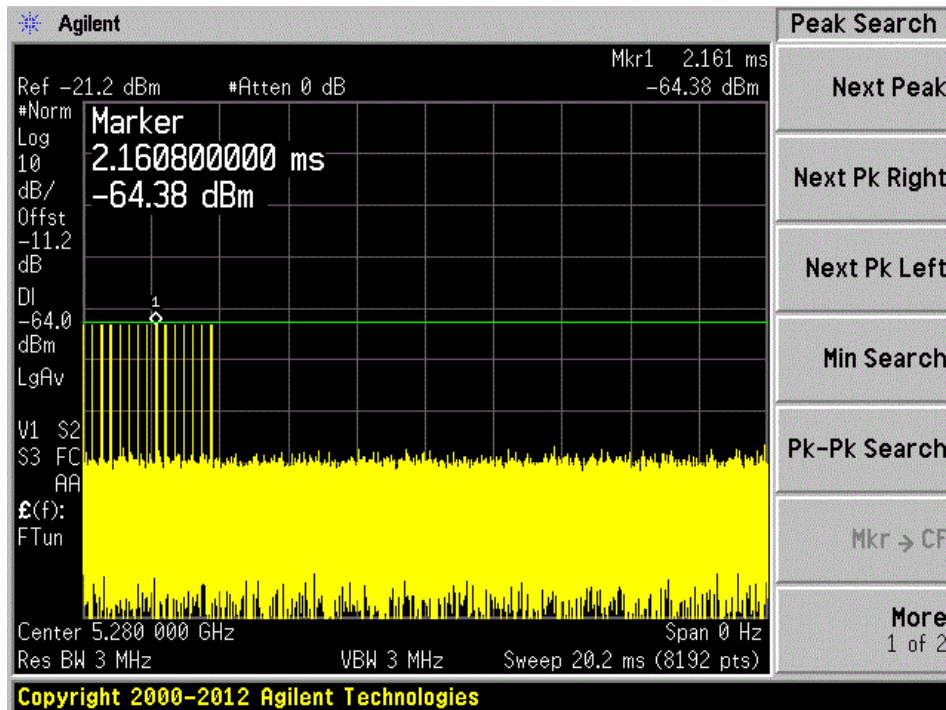

### Radar Type 5

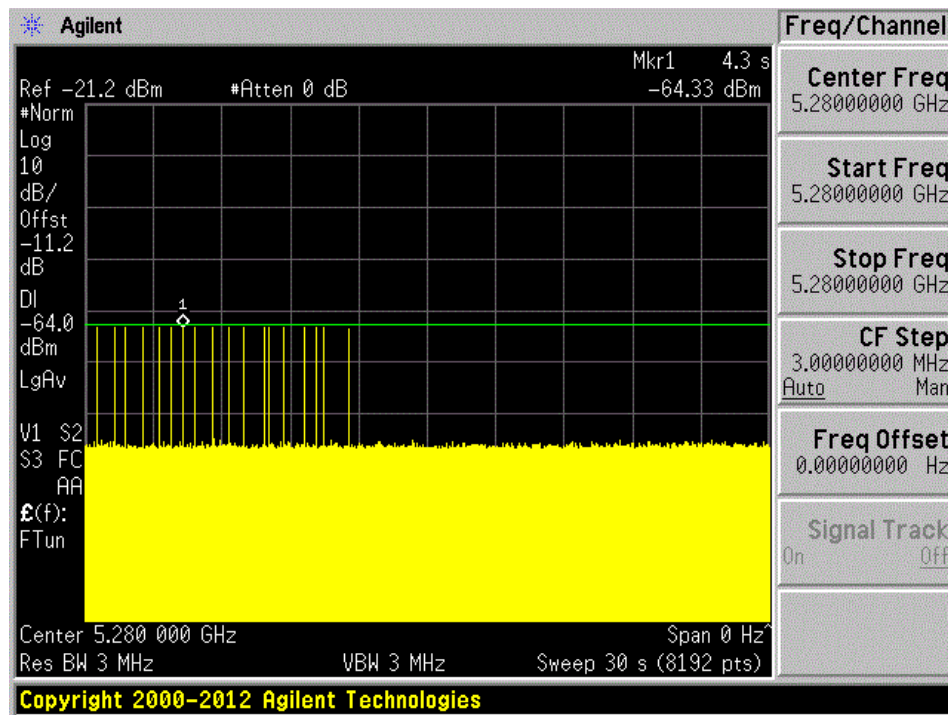

### Radar Type 6

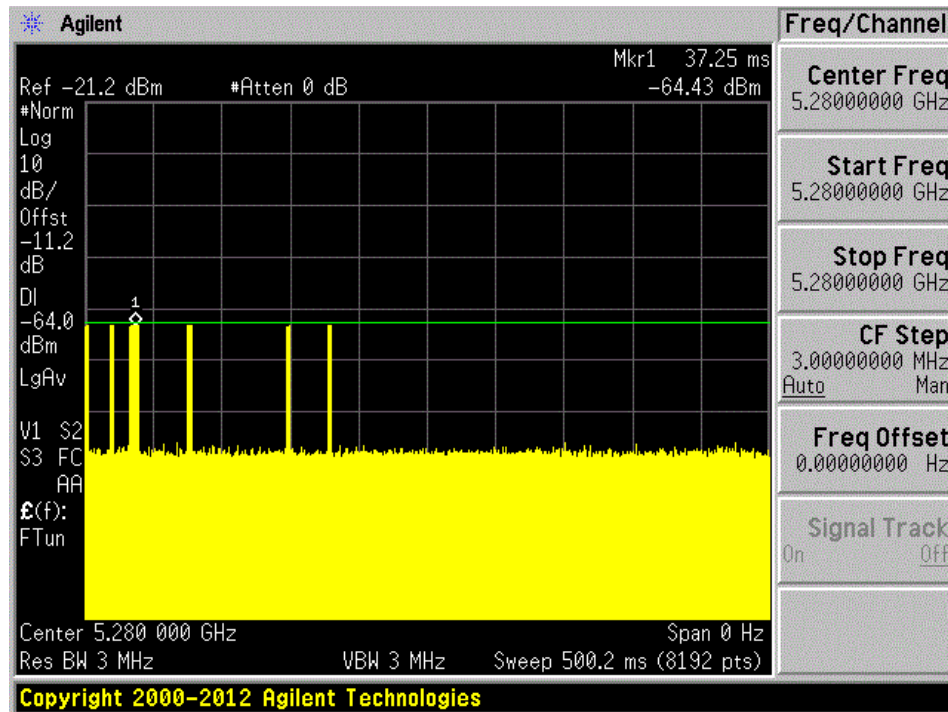

5580 MHz

Radar Type 0

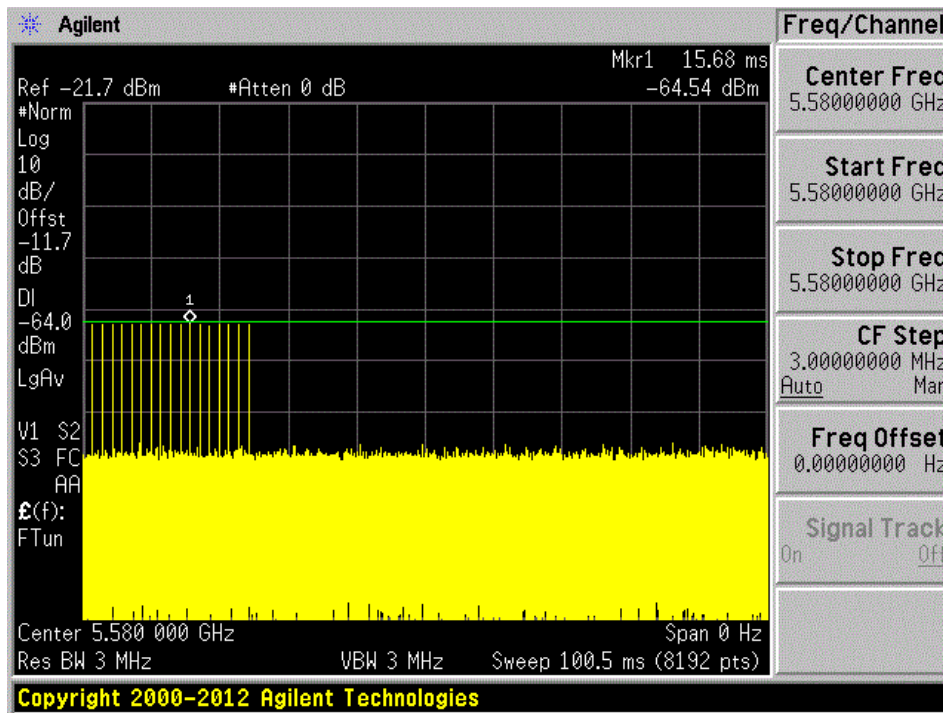

Radar Type 1A

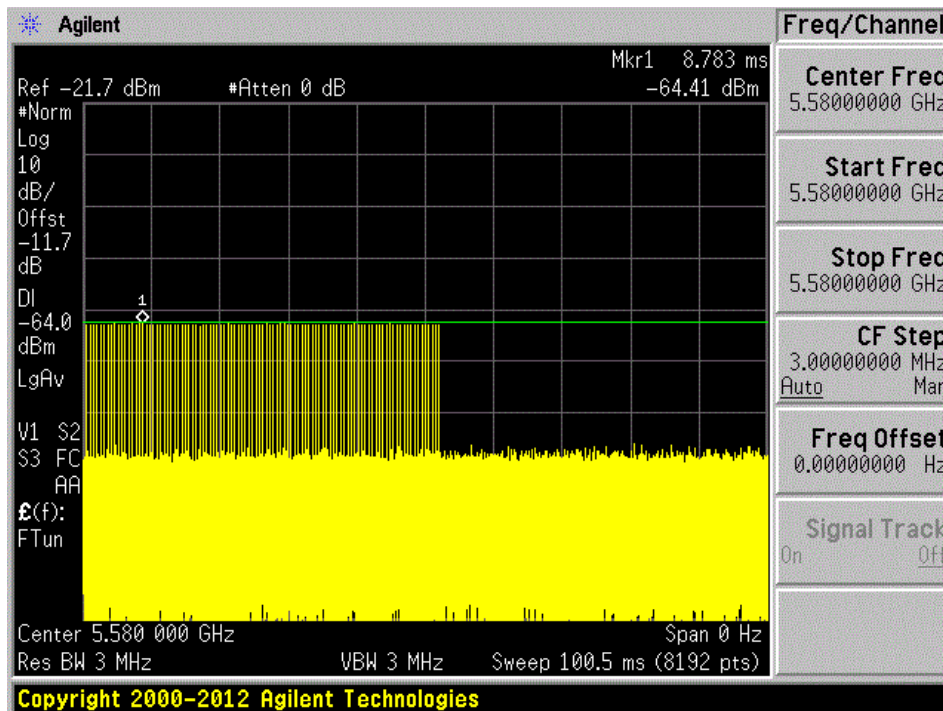

### Radar Type 1B

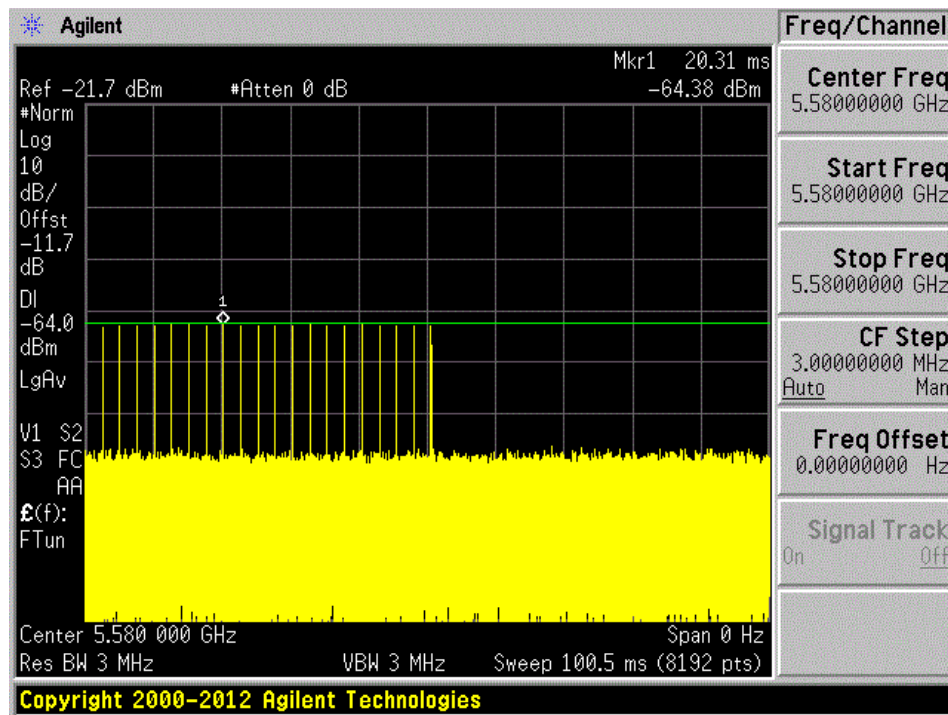

### Radar Type 2

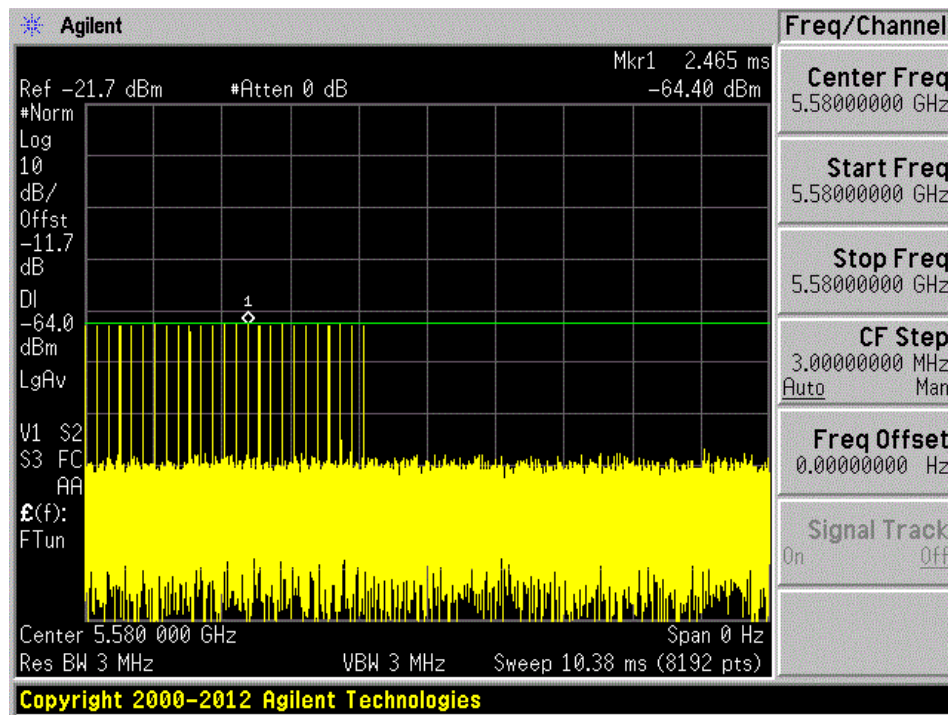



### Radar Type 3

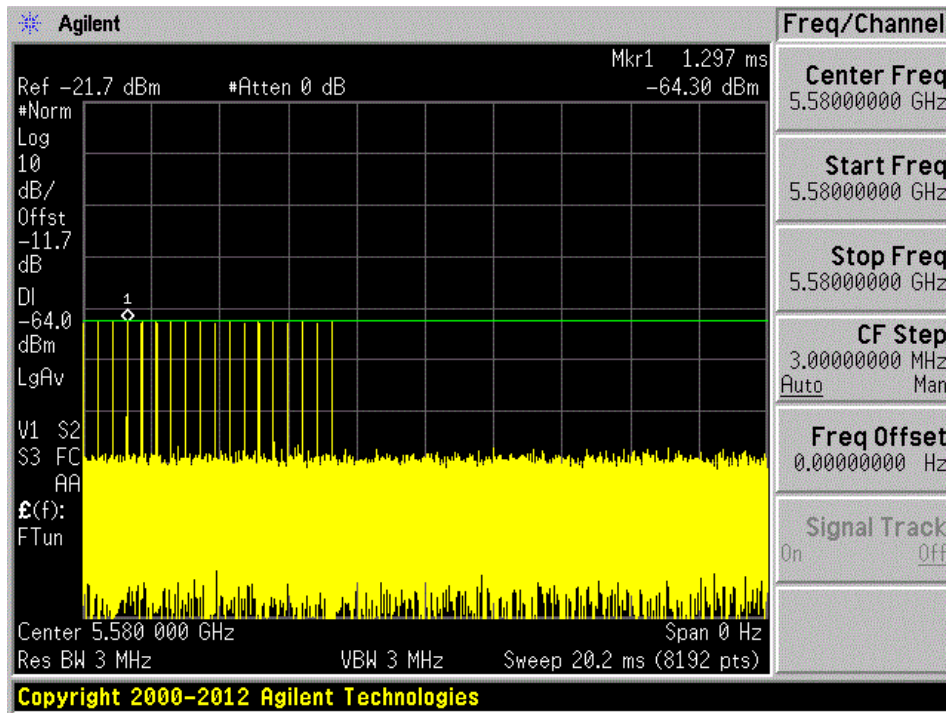

### Radar Type 4

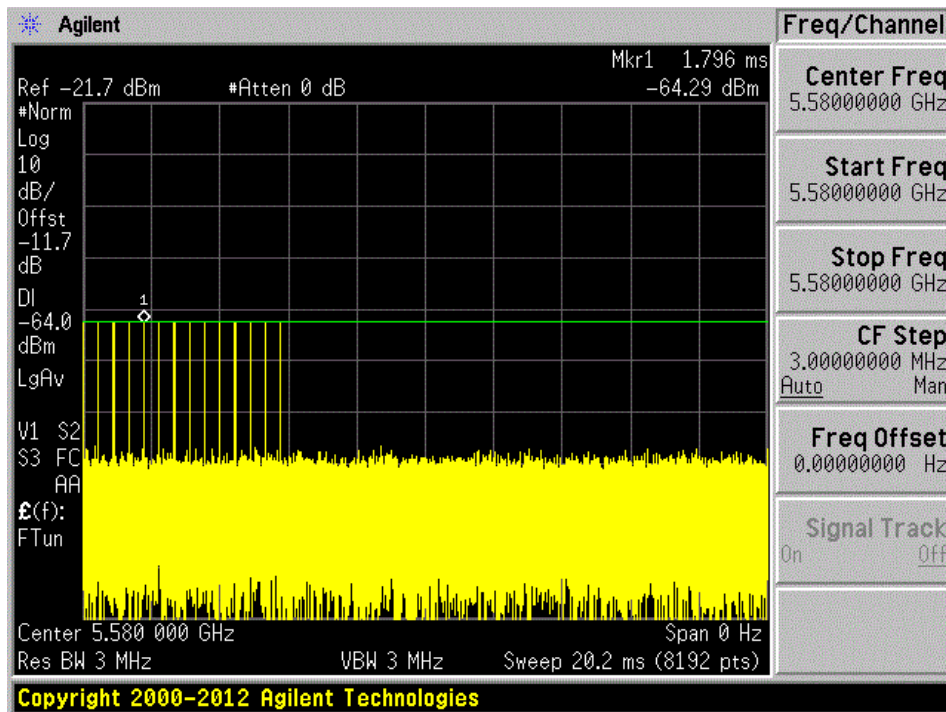

### Radar Type 5

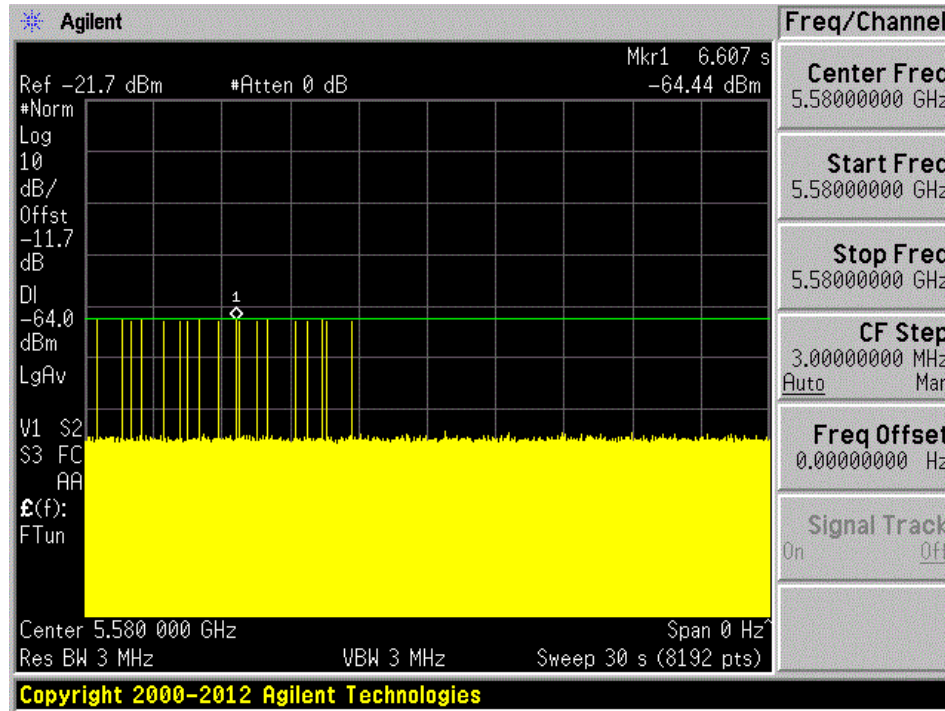

### Radar Type 6

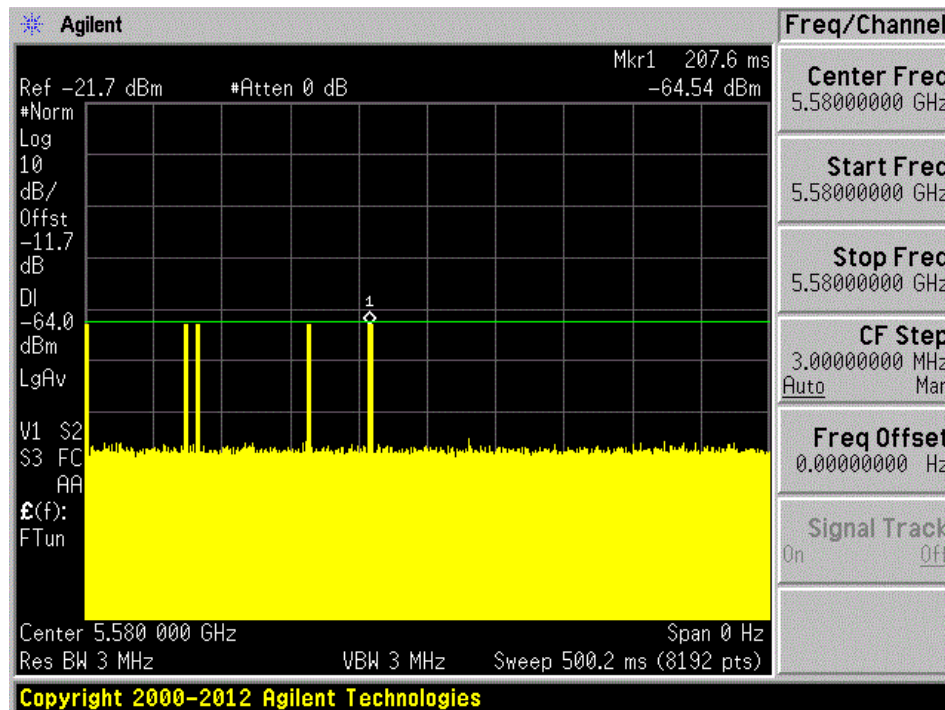

## 6 Channel Availability Check Time (CAC)

### 6.1 Test Procedure

- 1) Measure the initial power-up time of EUT.
- 2) With link established on channel, apply a radar signal within 0~6 seconds after the initial power-up period; monitor the transmissions on channel from the spectrum analyzer.
- 3) Reboot EUT, with a link established on channel, apply a radar signal within 54~60 seconds after the initial power-up period, and monitor the transmission on channel from the spectrum analyzer.

### EUT Initial power-up Cycle Time

5290 MHz and 5530 MHz Bandwidth 80 MHz

EUT initial Power-up cycle (Second)
35

### Results:

Timing of Radar Burst	Spectrum Analyzer Display
No Radar Triggered	Transmission begin after power-up cycle +60 seconds CAC
Within 2 seconds of the CAC starting	No transmission
Within the last 2 seconds of the CAC	No transmission

Please refer to the following plots.

**5290 MHz Bandwidth 80 MHz**

**Plot of without Radar signal applied**

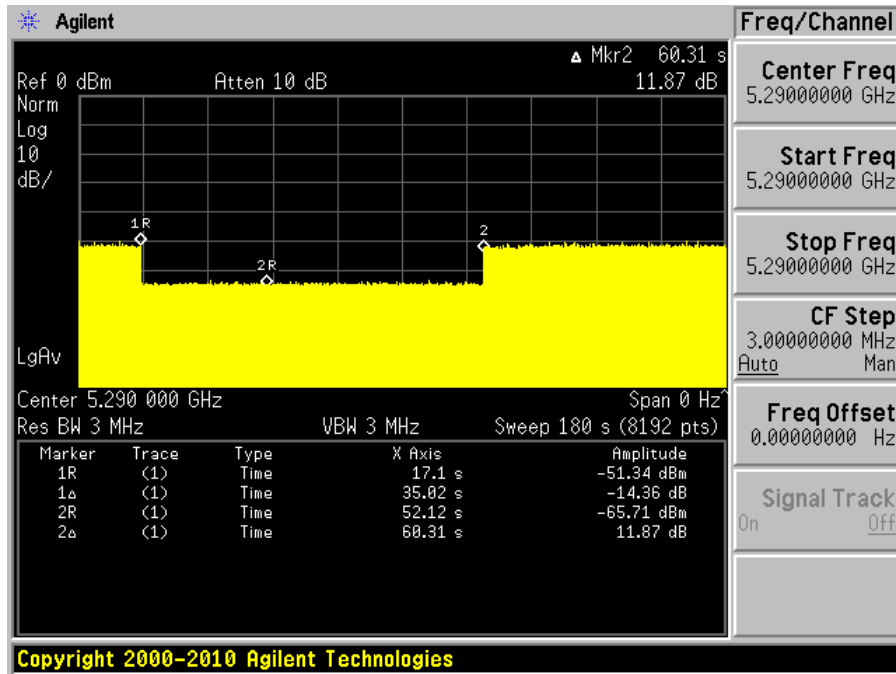

**Note:** The power-up cycle is 35 seconds.

### Plot of Radar signal applied within 2 seconds of start of CAC

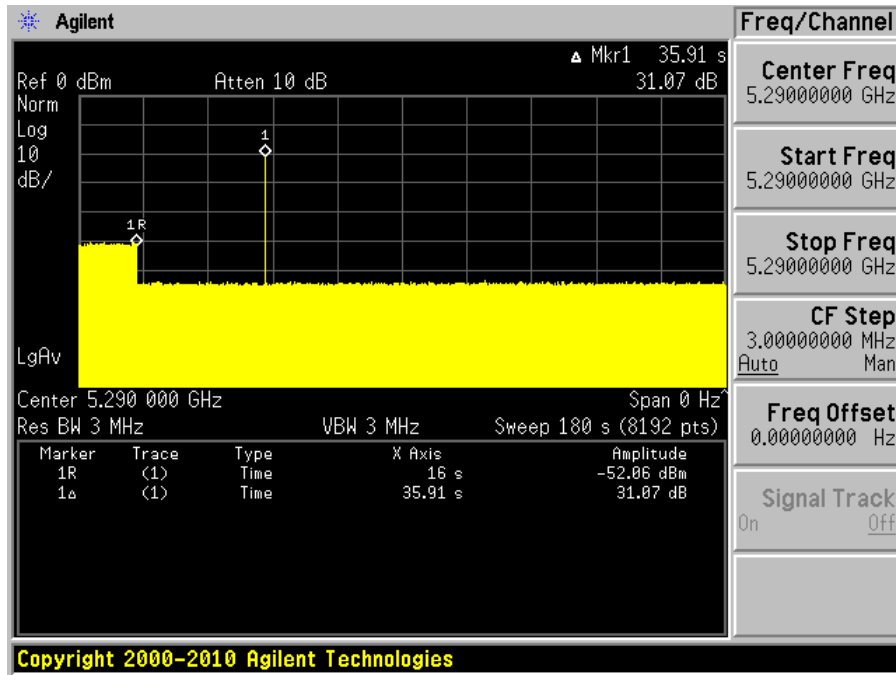

No transmissions found after radar signal applied.

**Plot of Radar signal applied at the end of 2 seconds of CAC**

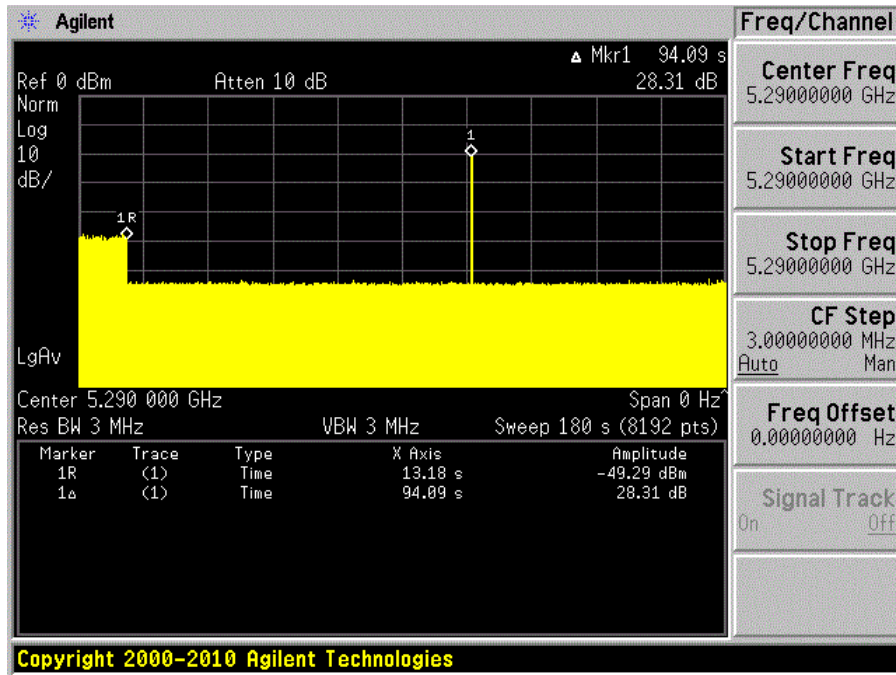

No transmissions found after radar signal applied.

**5530 MHz Bandwidth 80 MHz**

**Plot of without Radar signal applied**

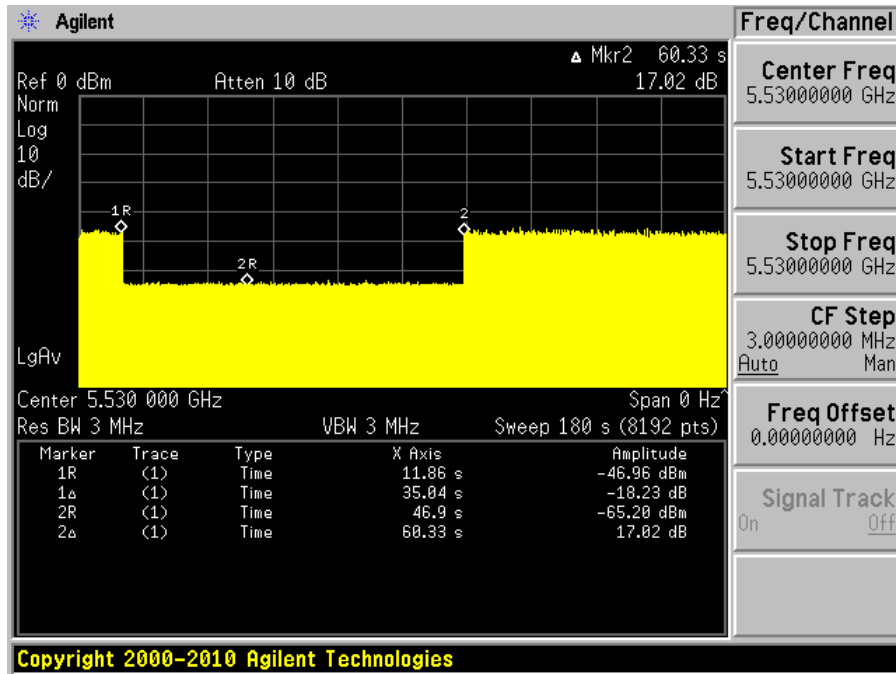

**Note:** The power-up cycle is 35 seconds.

### Plot of Radar signal applied within 2 seconds of start of CAC

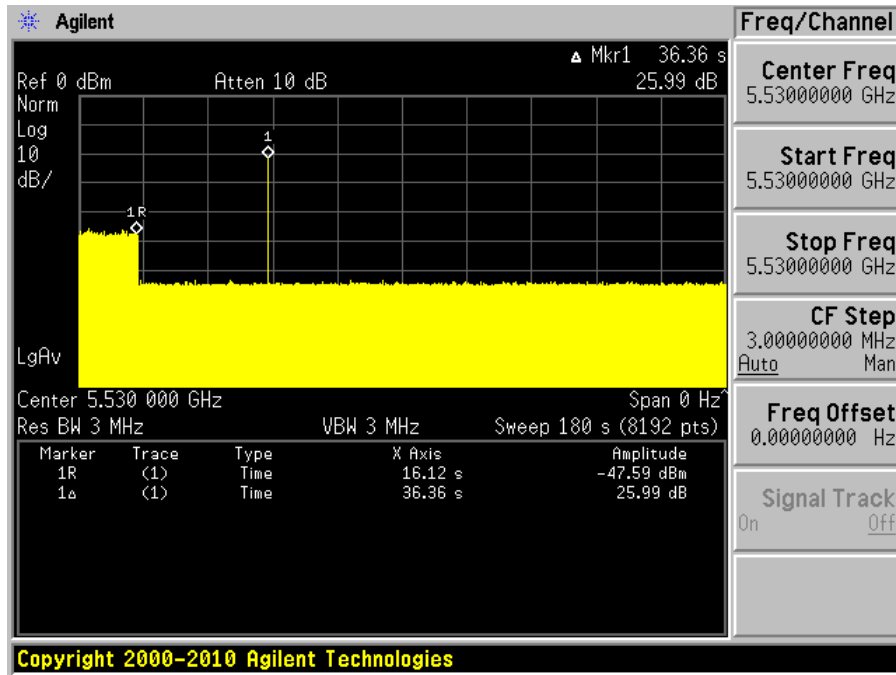

No transmissions found after radar signal applied.



**Plot of Radar signal applied at the end of 2 seconds of CAC**

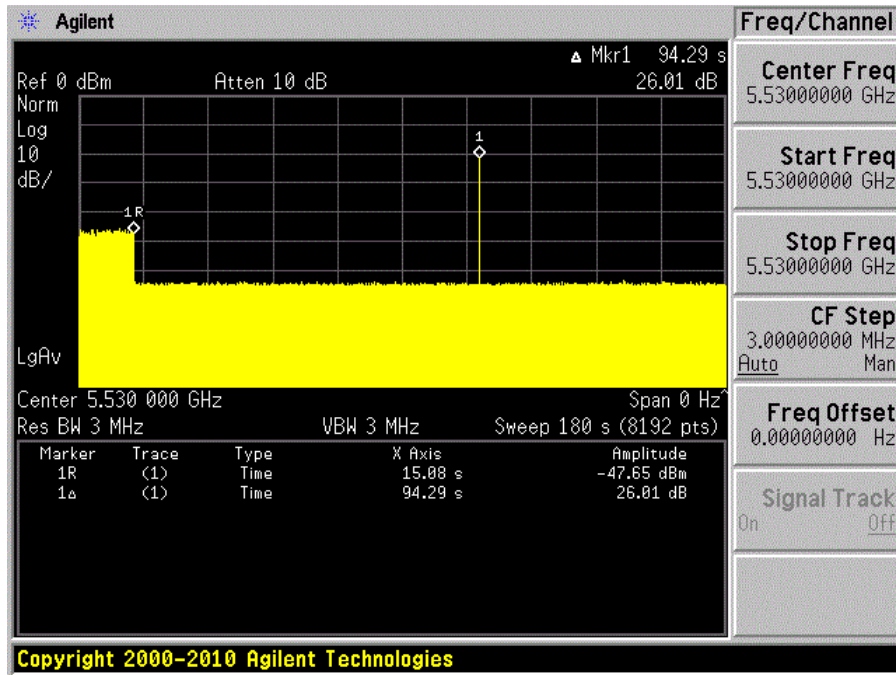

No transmissions found after radar signal applied.

## 7 Channel Move Time and Channel Closing Transmission Time

### 7.1 Test Procedure

Perform type 0 short pulse radar waveform, the aggregate channel closing transmission time is calculated as follows:

$$\text{Aggregate Transmission Time} = N * \text{Dwell Time}$$

N is the number of spectrum analyzer bins showing a device transmission

Dwell Time is the dwell time per bin (i.e. Dwell Time = S/B, S is the sweep time and B is the number of bin, i.e. 8192)

### 7.2 Test Results

Frequency (MHz)	Bandwidth (MHz)	Radar Type	Results
5290	80	Type 0	Compliant
5530	80	Type 0	Compliant

Please refer to the following tables and plots.

### 5290 MHz Bandwidth 80 MHz

Type 0 radar channel move time result:

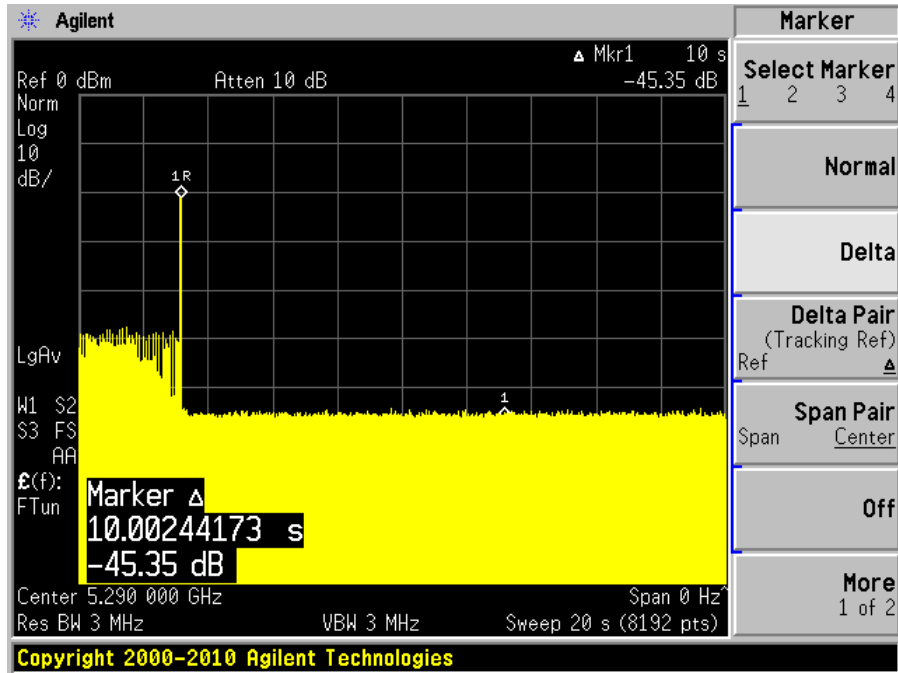

Type 0 radar channel closing transmission time result:

Aggregate Transmission Time (ms)	Limit (ms)	Margin (ms)
2.441	60	57.559

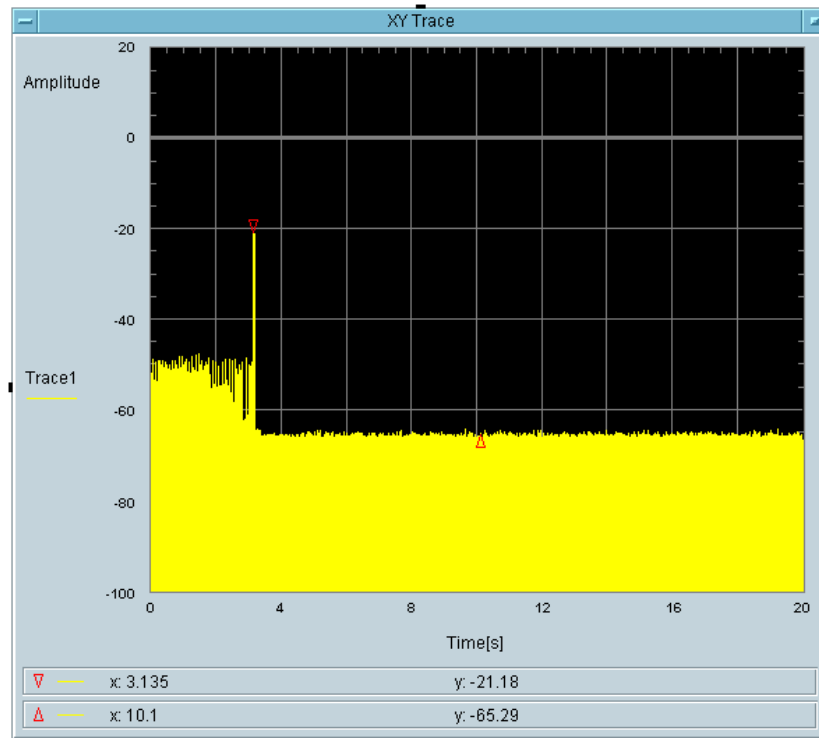

Total On Time [s]  
2.441m

### 5530 MHz Bandwidth 80 MHz

Type 0 radar channel move time result:

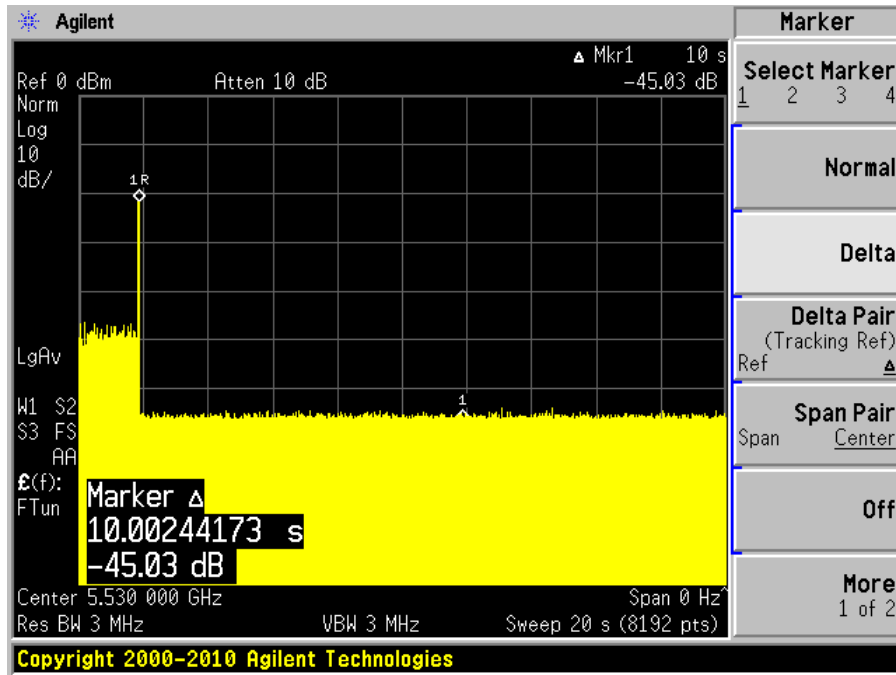

Type 0 radar channel closing transmission time result:

Aggregate Transmission Time (ms)	Limit (ms)	Margin (ms)
2.441	60	57.559

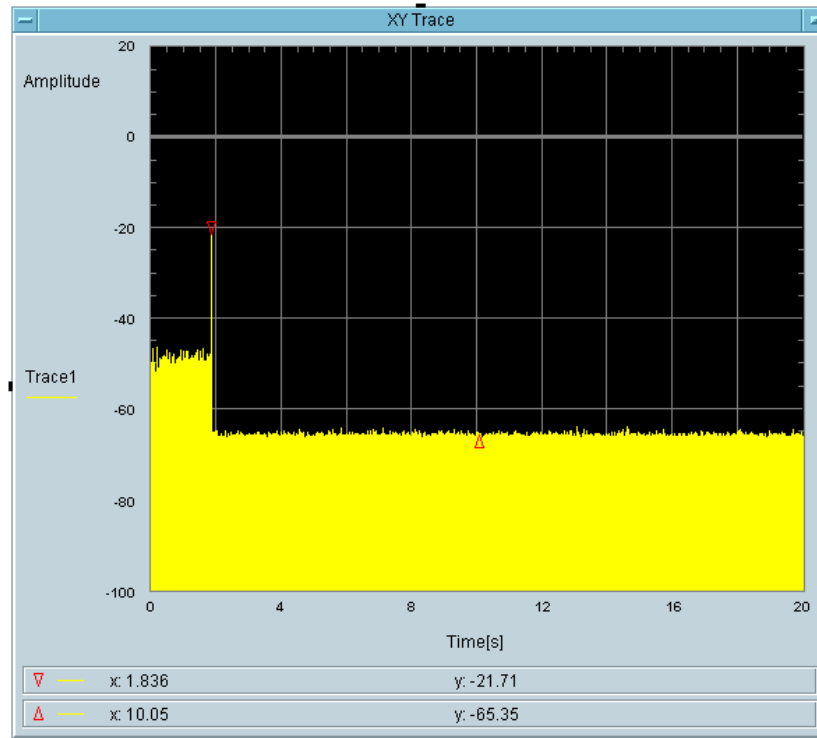

Total On Time [s]  
2.441m

## 8 Non-Occupancy Period

---

### 8.1 Test Procedure

Measure the EUT for more than 30 minutes following the channel close/move time to verify that the EUT does not resume any transmissions on this channel. Provide one plot to demonstrate no transmission on the channel for the non-occupancy period (30 minutes observation time)

### 8.2 Test Results

Frequency (MHz)	Bandwidth (MHz)	Spectrum Analyzer Display
5290	80	No transmission within 30 minutes
5530	80	No transmission within 30 minutes

Please refer to the following plots.

5290 MHz Bandwidth 80 MHz

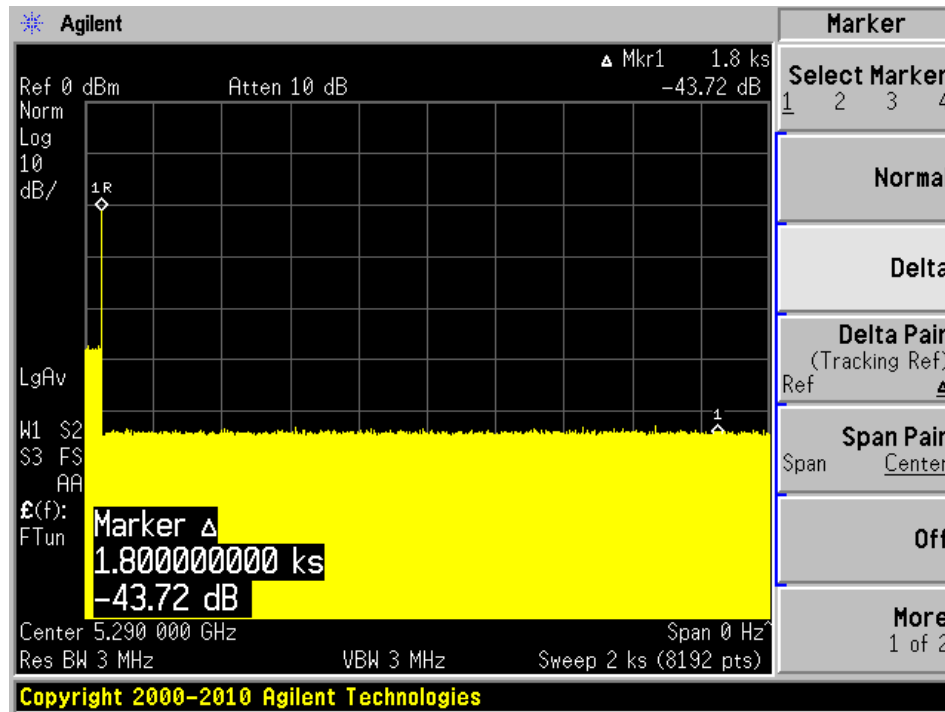

5530 MHz Bandwidth 80 MHz

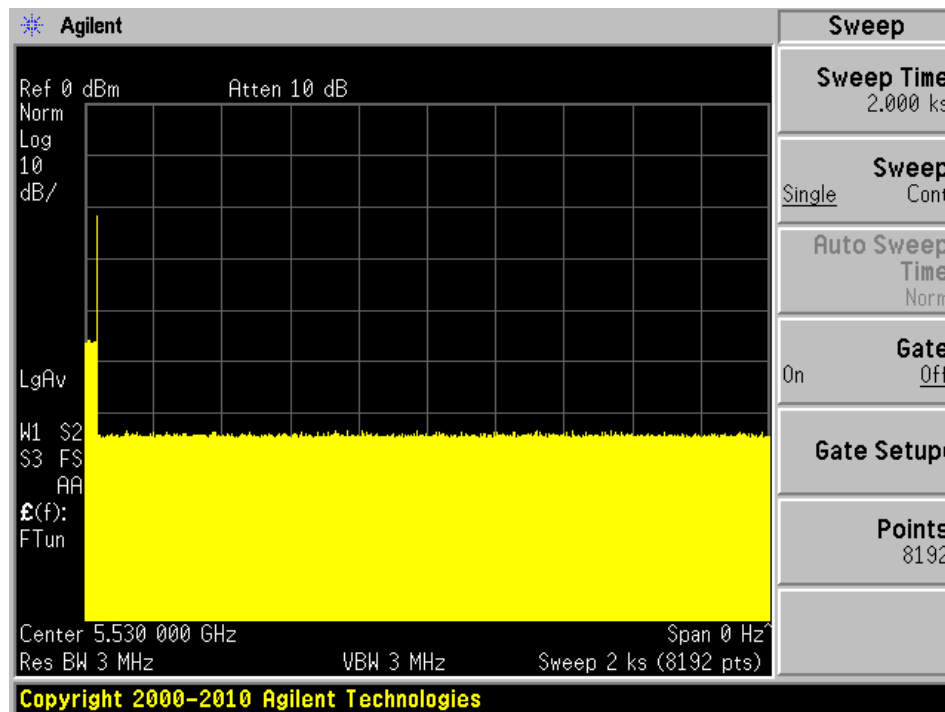



## 9 Radar Detection Bandwidth & Radar Detection Performance Check

### 9.1 Detection Bandwidth

#### Procedure:

Performed with the short pulse radar waveforms (type 0)

Start with radar generator frequency set to the center of the channel ( $F_c$ )

Perform at least 10 trials and confirm at least 90% detected

Increment radar generator frequency by 5 MHz and repeat

Perform at least 10 trials and confirm at least 90% detected

Continue incrementing the radar frequency until detection rate falls below 90%

Starting at  $F_c - 5$  MHz, Repeat this measurement in 1MHz steps at frequencies 5 MHz below where the detection rate begins to fall.

$F_L$  is the lowest frequency at which detection was 100% or better

$F_H$  is the highest frequency at which detection was 100% or better

UNII Detection Bandwidth =  $F_H - F_L$

#### Test Results

Frequency (MHz)	$F_L$ (MHz)	$F_H$ (MHz)	Detection Bandwidth (MHz)	Minimum Limit	Result
5280	5270	5290	20	100%	Compliance
5580	5570	5590	20	100%	Compliance
5270	5250	5290	40	80%	Compliance
5550	5530	5570	40	80%	Compliance
5290	5250	5330	80	80%	Compliance
5530	5490	5570	80	80%	Compliance

Please refer to the following tables and plots.

**Results of Detection Bandwidth:**

EUT Frequency = 5280 MHz											
DFS Detection Trials ( 1 = Detected, Blank = No Detected)											
Radar Frequency (MHz)	1	2	3	4	5	6	7	8	9	10	Detection Rate (%)
5269	0	0	0	0	0	0	0	0	0	0	0 %
<b>5270(F<sub>L</sub>)</b>	1	1	1	1	1	1	1	1	1	1	100 %
5275	1	1	1	1	1	1	1	1	1	1	100 %
5280(F <sub>c</sub> )	1	1	1	1	1	1	1	1	1	1	100 %
5285	1	1	1	1	1	1	1	1	1	1	100 %
<b>5290(F<sub>H</sub>)</b>	1	1	1	1	1	1	1	1	1	1	100 %
5291	0	0	0	0	0	0	0	0	0	0	0 %
<b>Detection Bandwidth = F<sub>H</sub> - F<sub>L</sub>=5290-5270=20 MHz</b>											
<b>EUT 99% OBW = 17.9704 MHz; 17.9704 x 100% = 17.9704 MHz</b>										<b>Result: Pass</b>	

EUT Frequency = 5580 MHz											
DFS Detection Trials ( 1 = Detected, Blank = No Detected)											
Radar Frequency (MHz)	1	2	3	4	5	6	7	8	9	10	Detection Rate (%)
5569	0	0	0	0	0	0	0	0	0	0	0 %
<b>5570(F<sub>L</sub>)</b>	1	1	1	1	1	1	1	1	1	1	100 %
5575	1	1	1	1	1	1	1	1	1	1	100 %
5580(F <sub>c</sub> )	1	1	1	1	1	1	1	1	1	1	100 %
5585	1	1	1	1	1	1	1	1	1	1	100 %
<b>5590(F<sub>H</sub>)</b>	1	1	1	1	1	1	1	1	1	1	100 %
5591	0	0	0	0	0	0	0	0	0	0	0 %
<b>Detection Bandwidth = F<sub>H</sub> - F<sub>L</sub>=5590-5570=20 MHz</b>											
<b>EUT 99% OBW = 17.9832 MHz; 17.9832 x 100% = 17.9832 MHz</b>										<b>Result: Pass</b>	

EUT Frequency = 5270 MHz											
DFS Detection Trials ( 1 = Detected, Blank = No Detected)											
Radar Frequency (MHz)	1	2	3	4	5	6	7	8	9	10	Detection Rate (%)
5269	1	0	0	0	0	0	0	0	0	0	10 %
<b>5250(F<sub>L</sub>)</b>	1	1	1	1	1	1	1	1	1	1	100 %
5252	1	1	1	1	1	1	1	1	1	1	100 %
5254	1	1	1	1	1	1	1	1	1	1	100 %
5256	1	1	1	1	1	1	1	1	1	1	100 %
5258	1	1	1	1	1	1	1	1	1	1	100 %
5260	1	1	1	1	1	1	1	1	1	1	100 %
5262	1	1	1	1	1	1	1	1	1	1	100 %
5264	1	1	1	1	1	1	1	1	1	1	100 %
5266	1	1	1	1	1	1	1	1	1	1	100 %
5268	1	1	1	1	1	1	1	1	1	1	100 %
5270(F <sub>c</sub> )	1	1	1	1	1	1	1	1	1	1	100 %
5272	1	1	1	1	1	1	1	1	1	1	100 %
5274	1	1	1	1	1	1	1	1	1	1	100 %
5276	1	1	1	1	1	1	1	1	1	1	100 %
5278	1	1	1	1	1	1	1	1	1	1	100 %
5280	1	1	1	1	1	1	1	1	1	1	100 %
5282	1	1	1	1	1	1	1	1	1	1	100 %
5284	1	1	1	1	1	1	1	1	1	1	100 %
5286	1	1	1	1	1	1	1	1	1	1	100 %
5288	1	1	1	1	1	1	1	1	1	1	100 %
<b>5290(F<sub>H</sub>)</b>	1	1	1	1	1	1	1	1	1	1	100 %
5291	0	0	0	0	0	0	0	0	0	0	0 %
<b>Detection Bandwidth = F<sub>H</sub> - F<sub>L</sub>=5290-5250=40 MHz</b>											
<b>EUT 99% OBW = 36.5899 MHz; 36.5899 x80%=29.27192 MHz      Result:      Pass</b>											

EUT Frequency = 5550 MHz											
DFS Detection Trials ( 1 = Detected, Blank = No Detected)											
Radar Frequency (MHz)	1	2	3	4	5	6	7	8	9	10	Detection Rate (%)
5529	0	0	0	0	0	0	0	0	0	0	0 %
<b>5530(F<sub>L</sub>)</b>	1	1	1	1	1	1	1	1	1	1	100 %
5532	1	1	1	1	1	1	1	1	1	1	100 %
5534	1	1	1	1	1	1	1	1	1	1	100 %
5536	1	1	1	1	1	1	1	1	1	1	100 %
5538	1	1	1	1	1	1	1	1	1	1	100 %
5540	1	1	1	1	1	1	1	1	1	1	100 %
5542	1	1	1	1	1	1	1	1	1	1	100 %
5544	1	1	1	1	1	1	1	1	1	1	100 %
5546	1	1	1	1	1	1	1	1	1	1	100 %
5548	1	1	1	1	1	1	1	1	1	1	100 %
5550 (F <sub>c</sub> )	1	1	1	1	1	1	1	1	1	1	100 %
5552	1	1	1	1	1	1	1	1	1	1	100 %
5554	1	1	1	1	1	1	1	1	1	1	100 %
5556	1	1	1	1	1	1	1	1	1	1	100 %
5558	1	1	1	1	1	1	1	1	1	1	100 %
5560	1	1	1	1	1	1	1	1	1	1	100 %
5562	1	1	1	1	1	1	1	1	1	1	100 %
5564	1	1	1	1	1	1	1	1	1	1	100 %
5566	1	1	1	1	1	1	1	1	1	1	100 %
5568	1	1	1	1	1	1	1	1	1	1	100 %
<b>5570(F<sub>H</sub>)</b>	1	1	1	1	1	1	1	1	1	1	100 %
5571	0	0	0	0	0	0	0	0	0	0	0 %
<b>Detection Bandwidth</b> = F <sub>H</sub> – F <sub>L</sub> =5570-5530=40 MHz											
<b>EUT 99% OBW</b> = 36.3159 MHz; 36.3159x80%= 29.05272MHz						<b>Result:</b> Pass					

EUT Frequency = 5290 MHz											
DFS Detection Trials ( 1 = Detected, Blank = No Detected)											
Radar Frequency (MHz)	1	2	3	4	5	6	7	8	9	10	Detection Rate (%)
5249	0	0	0	0	0	0	0	0	0	0	0 %
<b>5250(F<sub>L</sub>)</b>	1	1	1	1	1	1	1	1	1	1	100 %
5254	1	1	1	1	1	1	1	1	1	1	100 %
5258	1	1	1	1	1	1	1	1	1	1	100 %
5262	1	1	1	1	1	1	1	1	1	1	100 %
5266	1	1	1	1	1	1	1	1	1	1	100 %
5270	1	1	1	1	1	1	1	1	1	1	100 %
5274	1	1	1	1	1	1	1	1	1	1	100 %
5278	1	1	1	1	1	1	1	1	1	1	100 %
5282	1	1	1	1	1	1	1	1	1	1	100 %
5286	1	1	1	1	1	1	1	1	1	1	100 %
5290(F <sub>c</sub> )	1	1	1	1	1	1	1	1	1	1	100 %
5294	1	1	1	1	1	1	1	1	1	1	100 %
5298	1	1	1	1	1	1	1	1	1	1	100 %
5302	1	1	1	1	1	1	1	1	1	1	100 %
5306	1	1	1	1	1	1	1	1	1	1	100 %
5310	1	1	1	1	1	1	1	1	1	1	100 %
5314	1	1	1	1	1	1	1	1	1	1	100 %
5318	1	1	1	1	1	1	1	1	1	1	100 %
5322	1	1	1	1	1	1	1	1	1	1	100 %
5326	1	1	1	1	1	1	1	1	1	1	100 %
<b>5330(F<sub>H</sub>)</b>	1	1	1	1	1	1	1	1	1	1	100 %
5291	0	0	0	0	0	0	0	0	0	0	0 %
<b>Detection Bandwidth</b> = F <sub>H</sub> – F <sub>L</sub> = 5330-5250=80 MHz											
<b>EUT 99% OBW</b> = 75.5421 MHz; 75.5421x80%=60.63368 MHz								<b>Result:</b>		Pass	

EUT Frequency = 5530 MHz											
DFS Detection Trials ( 1 = Detected, Blank = No Detected)											
Radar Frequency (MHz)	1	2	3	4	5	6	7	8	9	10	Detection Rate (%)
5529	0	0	0	0	0	0	0	0	0	0	0 %
<b>5490(F<sub>L</sub>)</b>	1	1	1	1	1	1	1	1	1	1	100 %
5494	1	1	1	1	1	1	1	1	1	1	100 %
5498	1	1	1	1	1	1	1	1	1	1	100 %
5502	1	1	1	1	1	1	1	1	1	1	100 %
5506	1	1	1	1	1	1	1	1	1	1	100 %
5510	1	1	1	1	1	1	1	1	1	1	100 %
5514	1	1	1	1	1	1	1	1	1	1	100 %
5518	1	1	1	1	1	1	1	1	1	1	100 %
5522	1	1	1	1	1	1	1	1	1	1	100 %
5526	1	1	1	1	1	1	1	1	1	1	100 %
5530 (F <sub>c</sub> )	1	1	1	1	1	1	1	1	1	1	100 %
5534	1	1	1	1	1	1	1	1	1	1	100 %
5538	1	1	1	1	1	1	1	1	1	1	100 %
5542	1	1	1	1	1	1	1	1	1	1	100 %
5546	1	1	1	1	1	1	1	1	1	1	100 %
5550	1	1	1	1	1	1	1	1	1	1	100 %
5554	1	1	1	1	1	1	1	1	1	1	100 %
5558	1	1	1	1	1	1	1	1	1	1	100 %
5562	1	1	1	1	1	1	1	1	1	1	100 %
5566	1	1	1	1	1	1	1	1	1	1	100 %
<b>5570(F<sub>H</sub>)</b>	1	1	1	1	1	1	1	1	1	1	100 %
5571	0	0	0	0	0	0	0	0	0	0	0 %
<b>Detection Bandwidth = F<sub>H</sub> - F<sub>L</sub> = 5570 - 5490 = 80 MHz</b>											
<b>EUT 99% OBW = 75.6467 MHz; 75.6467x80%=60.51736 MHz                      Result:      Pass</b>											

## 9.2 Radar Detection Performance Check

### Procedure:

Stream MPEG file from master to slave

Generate radar waveform

Record whether or not the waveform was detected

At least 30 trials are applied for each radar type

For radar types with randomized parameters, each trial uses a unique waveform

Perform with each of the radar types 1-6

Confirm that the detection rate for each radar type meets the minimum requirement

Type 1A&1B, 2, 3, 4: 60% each

Type 5: 80%

Type 6: 70%

Confirm that the mean of the rates for radar types 1 through 4 meets the requirement of 80%

$$\text{Detection Ratio} = \frac{\text{Total Waveform Detections}}{\text{Total Waveform Trials}} \times 100$$

### Test Results:

#### 5280 MHz, 20 MHz Bandwidth

Radar Signal Type	Waveform/Trial Number	Detection (%)	Limit (%)	Pass/Fail
Type 1A/1B	30	100 %	60%	Pass
Type 2	30	100 %	60%	Pass
Type 3	30	100 %	60%	Pass
Type 4	30	100 %	60%	Pass
Aggregate (Type1 to 4)	120	100 %	80%	Pass
Type 5	30	100 %	80%	Pass
Type 6	30	100 %	70%	Pass

Please refer to the following statistical tables:

**Table-1 Radar Type 1A/1B Statistical Performance**

<b>Trial #</b>	<b>Fc (MHz)</b>	<b>Pulse/Burst</b>	<b>Pulse Width (μS)</b>	<b>PRI (μs)</b>	<b>Detection (1:yes; 0:no)</b>
1	5280	83	1	638	1
2	5280	58	1	918	1
3	5280	59	1	898	1
4	5280	76	1	698	1
5	5280	89	1	598	1
6	5280	95	1	558	1
7	5280	70	1	758	1
8	5280	92	1	578	1
9	5280	78	1	678	1
10	5280	63	1	838	1
11	5280	86	1	618	1
12	5280	102	1	518	1
13	5280	61	1	878	1
14	5280	67	1	798	1
15	5280	74	1	718	1
16	5280	36	1	1468	1
17	5280	21	1	2544	1
18	5280	21	1	2602	1
19	5280	22	1	2484	1
20	5280	56	1	957	1
21	5280	18	1	2937	1
22	5280	19	1	2901	1
23	5280	21	1	2636	1
24	5280	30	1	1773	1
25	5280	21	1	2578	1
26	5280	24	1	2213	1
27	5280	18	1	2965	1
28	5280	29	1	1868	1
29	5280	23	1	2312	1
30	5280	40	1	1336	1
<b>Detection Percentage: 100 % (&gt;60%)</b>					



**Table-2 Radar Type 2 Statistical Performance**

<b>Trial #</b>	<b>Fc (MHz)</b>	<b>Pulse/Burst</b>	<b>Pulse Width (μS)</b>	<b>PRI (μs)</b>	<b>Detection (1:yes; 0:no)</b>
1	5280	24	3.6	197	1
2	5280	25	2.9	166	1
3	5280	27	1.7	192	1
4	5280	26	4.5	216	1
5	5280	27	3.5	225	1
6	5280	24	1.7	218	1
7	5280	29	3.6	225	1
8	5280	26	4.4	227	1
9	5280	28	3.4	169	1
10	5280	23	1.8	189	1
11	5280	26	4.2	205	1
12	5280	26	4.1	230	1
13	5280	23	4.3	225	1
14	5280	27	4.9	226	1
15	5280	26	1	168	1
16	5280	23	2.7	220	1
17	5280	28	4.4	203	1
18	5280	26	2.5	229	1
19	5280	24	4.8	183	1
20	5280	23	1.8	227	1
21	5280	27	3.7	158	1
22	5280	29	2.9	175	1
23	5280	29	2.1	172	1
24	5280	24	3.9	193	1
25	5280	26	2.6	225	1
26	5280	29	3.2	178	1
27	5280	25	4.5	191	1
28	5280	29	2.7	203	1
29	5280	27	3.9	164	1
30	5280	27	5	153	1
<b>Detection Percentage: 100 % (&gt;60%)</b>					

**Table-3 Radar Type 3 Statistical Performance**

<b>Trial #</b>	<b>Fc (MHz)</b>	<b>Pulse/Burst</b>	<b>Pulse Width (μS)</b>	<b>PRI (μs)</b>	<b>Detection (1:yes; 0:no)</b>
1	5280	18	6.3	300	1
2	5280	18	6.5	366	1
3	5280	18	6.9	489	1
4	5280	16	8.5	263	1
5	5280	17	9.5	392	1
6	5280	16	7.5	320	1
7	5280	17	7.2	474	1
8	5280	16	6.5	219	1
9	5280	16	7.1	383	1
10	5280	16	9	364	1
11	5280	17	9.2	279	1
12	5280	18	9.3	351	1
13	5280	16	6.8	297	1
14	5280	16	8.3	459	1
15	5280	16	6.1	471	1
16	5280	17	8.4	266	1
17	5280	16	6.4	467	1
18	5280	18	6.3	403	1
19	5280	18	8.1	255	1
20	5280	18	6.2	379	1
21	5280	16	9.4	219	1
22	5280	18	9.2	217	1
23	5280	16	9.2	388	1
24	5280	18	6.1	423	1
25	5280	16	7.2	366	1
26	5280	17	8.1	333	1
27	5280	17	6.6	329	1
28	5280	18	6.5	453	1
29	5280	17	7.5	454	1
30	5280	16	6.3	341	1
<b>Detection Percentage: 100 % (&gt;60%)</b>					

**Table-4 Radar Type 4 Statistical Performance**

<b>Trial #</b>	<b>Fc (MHz)</b>	<b>Pulse/Burst</b>	<b>Pulse Width (μS)</b>	<b>PRI (μs)</b>	<b>Detection (1:yes; 0:no)</b>
1	5280	15	15.2	411	1
2	5280	15	18.7	475	1
3	5280	15	15.2	259	1
4	5280	15	12	500	1
5	5280	12	12	424	1
6	5280	16	15.2	221	1
7	5280	14	16.4	306	1
8	5280	14	11.7	490	1
9	5280	13	13.8	242	1
10	5280	15	15.1	325	1
11	5280	12	16.5	377	1
12	5280	15	14.4	441	1
13	5280	15	19.7	414	1
14	5280	15	17.2	295	1
15	5280	16	12.1	249	1
16	5280	14	13.8	297	1
17	5280	14	12.7	430	1
18	5280	12	18.3	368	1
19	5280	13	15.6	376	1
20	5280	16	16.8	438	1
21	5280	12	16.7	354	1
22	5280	12	11.9	336	1
23	5280	16	11.1	494	1
24	5280	14	13.7	362	1
25	5280	15	18.5	405	1
26	5280	12	19.1	433	1
27	5280	15	19.5	376	1
28	5280	16	16.7	449	1
29	5280	16	16.8	412	1
30	5280	12	13.6	460	1
<b>Detection Percentage: 100 % (&gt;60%)</b>					

**Table-5 Radar Type 5 Statistical Performance**

Bin5 Statistics 1

Trial #	Pulse	Chirp (MHz)	Pulse Width (µS)	Pulse 1-2 spacing (uS)	Pulse 2-3 spacing (uS)	Pulse Start(S)	Detection (1:yes; 0:no)
0	2	19	52.2	1042		0.824517	1
1	1	8	66.5			1.679848	
2	1	6	82			3.447666	
3	2	13	98.8	1816		4.137995	
4	2	19	82.6	1358		5.912295	
5	3	13	99.7	1994	1270	6.729176	
6	1	20	87.1			8.898633	
7	2	17	98.5	1468		9.433814	
8	2	11	98	1665		11.199082	

Bin5 Statistics 2

Trial #	Pulse	Chirp (MHz)	Pulse Width (µS)	Pulse 1-2 spacing (uS)	Pulse 2-3 spacing (uS)	Pulse Start(S)	Detection (1:yes; 0:no)
0	2	11	63.8	1962		0.476466	1
1	2	7	58.9	1812		0.727772	
2	2	12	79.6	1244		1.783482	
3	2	8	77.5	1663		2.226816	
4	1	20	78.5			2.903204	
5	1	13	77.9			3.626539	
6	2	10	97	1812		4.822246	
7	3	11	65.9	1835	1907	5.090139	
8	1	8	88.3			6.088747	
9	1	11	56.2			6.933686	
10	2	8	50.8	1509		7.224332	
11	3	12	72.1	1431	1925	8.301518	
12	2	12	99.6	1648		8.887639	
13	3	16	56.6	1633	1301	9.616613	
14	3	8	65.1	1851	1748	10.38499	
15	1	10	61.3			10.596142	
16	1	20	74.1			11.687014	

## Bin5 Statistics 3

Trial #	Pulse	Chirp (MHz)	Pulse Width (µS)	Pulse 1-2 spacing (µS)	Pulse 2-3 spacing (µS)	Pulse Start(S)	Detection (1:yes; 0:no)
0	2	6	84.3	1274		0.102464	1
1	2	15	88.4	1140		1.33061	
2	3	9	56.4	1593	1940	2.182985	
3	3	14	94.3	1102	1252	2.50193	
4	1	7	54.2			3.014702	
5	2	13	92.7	1305		4.135379	
6	1	10	54.6			4.62695	
7	3	11	51.6	1256	1405	5.896377	
8	3	14	72	1048	1420	6.415319	
9	2	16	54.5	1380		6.954464	
10	2	8	60	1409		7.812597	
11	1	20	61.8			8.708832	
12	3	5	97.8	1669	1999	9.419929	
13	1	11	92.5			9.790816	
14	1	12	50.9			10.583676	
15	1	18	79.6			11.666534	

## Bin5 Statistics 4

Trial #	Pulse	Chirp (MHz)	Pulse Width (µS)	Pulse 1-2 spacing (µS)	Pulse 2-3 spacing (µS)	Pulse Start(S)	Detection (1:yes; 0:no)
0	2	8	57.4	1465		0.092288	1
1	3	10	80.2	1524	1044	2.269354	
2	1	7	97.5			2.790425	
3	2	20	71.8	1685		3.950618	
4	2	14	84.1	1321		5.566133	
5	1	8	66.7			6.649952	
6	3	15	74.2	1558	1978	7.948997	
7	2	18	61.9	1904		8.813772	
8	2	7	75.8	1052		9.78957	
9	1	19	96.8			11.672359	

## Bin5 Statistics 5

Trial #	Pulse	Chirp (MHz)	Pulse Width (µS)	Pulse 1-2 spacing (uS)	Pulse 2-3 spacing (uS)	Pulse Start(S)	Detection (1:yes; 0:no)
0	2	5	64.7	1272		0.025298	1
1	3	8	81.9	1282	1846	1.06454	
2	2	8	77.3	1688		1.704639	
3	1	12	88.7			2.393151	
4	2	17	61.3	1520		2.785355	
5	2	16	99.3	1217		3.710044	
6	2	17	79.4	1761		3.866482	
7	2	17	82	1102		4.913459	
8	3	13	54.1	1406	1373	5.330279	
9	1	7	67.7			5.761237	
10	2	5	63.9	1948		6.871829	
11	2	8	53.9	1393		7.239006	
12	3	14	55	1008	1128	8.002813	
13	2	20	69	1033		8.780763	
14	2	16	51.8	1774		9.031942	
15	1	12	56.4			9.688958	
16	2	16	57.7	1648		10.560097	
17	2	16	62.6	1634		10.792214	
18	1	9	59.5			11.579926	

## Bin5 Statistics 6

Trial #	Pulse	Chirp (MHz)	Pulse Width (µS)	Pulse 1-2 spacing (uS)	Pulse 2-3 spacing (uS)	Pulse Start(S)	Detection (1:yes; 0:no)
0	3	13	83.2	1179	1234	0.107965	1
1	3	6	93.4	1933	1868	1.310266	
2	2	6	58.5	1289		1.698807	
3	3	6	58.7	1384	1844	2.366902	
4	2	7	62.9	1251		3.604877	
5	1	11	86.5			4.039136	
6	1	13	76.8			4.912149	
7	2	10	52.4	1094		5.676125	
8	3	17	50.7	1227	1873	6.066861	
9	3	13	79.1	1394	1404	7.191412	
10	2	5	89	1234		8.011697	
11	1	9	82.1			8.40304	
12	2	13	80.2	1610		9.216403	
13	3	13	80.9	1301	1738	10.261898	
14	3	19	70.8	1968	1051	11.078099	
15	3	20	83.9	1238	1532	11.576595	

## Bin5 Statistics 7

Trial #	Pulse	Chirp (MHz)	Pulse Width (µS)	Pulse 1-2 spacing (uS)	Pulse 2-3 spacing (uS)	Pulse Start(S)	Detection (1:yes; 0:no)
0	2	9	59.5	1279		0.73937	1
1	1	8	61.9			2.630907	
2	2	17	55.5	1096		3.983566	
3	2	14	85.3	1276		4.033158	
4	2	16	90.8	1725		6.097803	
5	2	14	59.5	1378		7.078494	
6	2	13	89.9	1955		8.642257	
7	1	9	65.3			10.415887	

## Bin5 Statistics 8

Trial #	Pulse	Chirp (MHz)	Pulse Width (µS)	Pulse 1-2 spacing (µS)	Pulse 2-3 spacing (µS)	Pulse Start(S)	Detection (1:yes; 0:no)
0	2	13	88.5	1750		0.617337	1
1	2	10	90.1	1786		1.43041	
2	2	14	81.9	1464		2.858804	
3	1	13	52.5			3.800303	
4	1	12	72.9			4.349996	
5	2	7	88	1042		5.04072	
6	2	12	84.3	1648		6.790323	
7	3	16	55.4	1228	1708	7.323794	
8	2	12	87.5	1222		8.970025	
9	2	14	66.4	1226		9.147781	
10	1	18	97.2			10.245397	
11	1	10	66.5			11.254863	

## Bin5 Statistics 9

Trial #	Pulse	Chirp (MHz)	Pulse Width (µS)	Pulse 1-2 spacing (µS)	Pulse 2-3 spacing (µS)	Pulse Start(S)	Detection (1:yes; 0:no)
0	3	19	98.2	1590	1836	0.362942	1
1	2	18	92.8	1469		1.084989	
2	2	5	77	1907		2.044224	
3	2	20	61.8	1512		2.401758	
4	3	11	73.8	1141	1027	2.907414	
5	2	11	59.4	1952		3.690721	
6	3	18	72.1	1338	1712	4.548379	
7	2	13	70.1	1143		5.417955	
8	1	16	71.8			5.722904	
9	3	19	69.9	1791	1152	6.773259	
10	2	16	62.4	1727		7.69001	
11	3	19	73.7	1896	1804	8.234751	
12	2	6	66.3	1161		8.516177	
13	2	20	69.9	1090		9.377659	
14	1	15	73.5			9.939783	
15	3	6	58.9	1435	1001	10.701689	
16	3	9	90.3	1205	1596	11.304148	



## Bin5 Statistics 10

Trial #	Pulse	Chirp (MHz)	Pulse Width (µS)	Pulse 1-2 spacing (uS)	Pulse 2-3 spacing (uS)	Pulse Start(S)	Detection (1:yes; 0:no)
0	2	13	78.5	1614		1.287747	1
1	3	15	55.9	1151	1222	2.842056	
2	1	11	50.5			3.232644	
3	1	8	81.9			4.740359	
4	2	15	53.7	1624		7.136252	
5	3	8	55.5	1798	1188	8.670178	
6	2	13	85.4	1349		9.509671	
7	2	20	74.7	1910		11.151547	

## Bin5 Statistics 11

Trial #	Pulse	Chirp (MHz)	Pulse Width (µS)	Pulse 1-2 spacing (uS)	Pulse 2-3 spacing (uS)	Pulse Start(S)	Detection (1:yes; 0:no)
0	1	19	96.5			0.013913	1
1	2	13	82.2	1323		1.88799	
2	1	12	58.4			2.639785	
3	1	7	74.2			3.777277	
4	3	8	58.7	1501	1692	4.042197	
5	2	17	57.2	1738		5.373782	
6	2	7	56.7	1359		6.57155	
7	2	14	65.1	1556		7.501752	
8	2	15	97.6	1779		8.954934	
9	1	13	75.6			9.528836	
10	1	13	71.3			10.359681	
11	3	16	85.8	1027	1107	11.598157	

## Bin5 Statistics 12

Trial #	Pulse	Chirp (MHz)	Pulse Width (µS)	Pulse 1-2 spacing (uS)	Pulse 2-3 spacing (uS)	Pulse Start(S)	Detection (1:yes; 0:no)
0	2	18	65.9	1517		0.089242	1
1	1	18	63.4			2.107236	
2	3	13	76.2	1948	1758	2.674523	
3	2	13	90.4	1782		3.884869	
4	1	16	97.6			4.954653	
5	1	16	69.4			6.447688	
6	1	5	67.8			7.868818	
7	2	15	94	1689		8.608912	
8	2	7	72.9	1528		9.741473	
9	2	11	64.5	1133		11.270631	
10	2	18	65.9	1517		0.089242	
11	1	18	63.4			2.107236	
12	3	13	76.2	1948	1758	2.674523	

## Bin5 Statistics 13

Trial #	Pulse	Chirp (MHz)	Pulse Width (µS)	Pulse 1-2 spacing (uS)	Pulse 2-3 spacing (uS)	Pulse Start(S)	Detection (1:yes; 0:no)
0	1	10	74.3			0.184997	1
1	2	5	99.3	1142		2.215573	
2	2	13	53.1	1904		3.388392	
3	2	5	61.9	1285		4.144348	
4	2	13	58.5	1444		5.716001	
5	3	16	65.7	1517	1343	6.690466	
6	2	10	53.2	1462		7.826855	
7	3	8	82.7	1296	1498	9.028305	
8	1	12	69.9			9.748856	
9	3	16	53.9	1019	1585	11.240107	

## Bin5 Statistics 14

Trial #	Pulse	Chirp (MHz)	Pulse Width (µS)	Pulse 1-2 spacing (µS)	Pulse 2-3 spacing (µS)	Pulse Start(S)	Detection (1:yes; 0:no)
0	2	18	78.5	1061		0.442864	1
1	1	5	51.8			0.90793	
2	2	17	91.3	1766		2.014569	
3	2	16	85.1	1936		2.802406	
4	2	16	79.5	1282		3.494646	
5	1	13	96.5			4.076432	
6	2	12	63.2	1292		5.144765	
7	1	15	68.2			5.540954	
8	2	13	96.9	1655		6.551524	
9	1	7	83.8			6.973103	
10	2	19	64.4	1505		7.996665	
11	2	18	96.8	1245		8.488582	
12	3	8	85.2	1555	1031	9.077463	
13	3	15	76.1	1473	1988	9.924317	
14	3	12	99.5	1412	1518	11.23324	
15	3	11	62.2	1360	1939	11.94173	

## Bin5 Statistics 15

Trial #	Pulse	Chirp (MHz)	Pulse Width (µS)	Pulse 1-2 spacing (µS)	Pulse 2-3 spacing (µS)	Pulse Start(S)	Detection (1:yes; 0:no)
0	3	14	51	1668	1270	0.083207	1
1	3	10	74.6	1636	1019	1.471652	
2	1	19	85.8			1.803888	
3	3	10	71.1	1614	1171	2.339805	
4	3	18	95.3	1938	1815	3.72106	
5	2	16	84	1940		3.806071	
6	1	7	88.9			5.028689	
7	2	16	55.8	1862		5.797809	
8	2	10	65.1	1192		6.659817	
9	2	11	97.2	1869		7.404995	
10	1	17	66.2			7.671903	
11	2	17	89.2	1896		8.813629	
12	2	11	89.5	1796		9.391609	
13	3	10	52.4	1099	1487	10.235477	
14	2	7	63.2	1867		11.155215	
15	2	19	99.9	1540		11.377177	

## Bin5 Statistics 16

Trial #	Pulse	Chirp (MHz)	Pulse Width (µS)	Pulse 1-2 spacing (uS)	Pulse 2-3 spacing (uS)	Pulse Start(S)	Detection (1:yes; 0:no)
0	3	8	95.9	1978	1407	0.597784	1
1	2	6	80.5	1880		1.306362	
2	2	19	57.6	1116		2.323959	
3	3	17	80.9	1235	1804	3.165438	
4	1	7	88.2			3.617644	
5	3	11	92	1716	1845	4.235337	
6	2	7	85	1613		4.922599	
7	1	12	98.4			5.737993	
8	1	8	66.4			6.411902	
9	2	5	89.2	1179		7.427564	
10	2	14	95.8	1904		8.140747	
11	2	12	92	1910		9.388938	
12	2	13	71.9	1403		9.610509	
13	2	13	62.4	1937		10.799062	
14	3	7	63.8	1242	1457	11.745111	

## Bin5 Statistics 17

Trial #	Pulse	Chirp (MHz)	Pulse Width (µS)	Pulse 1-2 spacing (uS)	Pulse 2-3 spacing (uS)	Pulse Start(S)	Detection (1:yes; 0:no)
0	3	14	70.4	1323	1708	0.636834	1
1	3	16	98.9	1659	1347	0.865889	
2	2	7	55.9	1307		1.516041	
3	2	19	83	1487		2.024868	
4	1	9	79.1			2.789183	
5	2	19	52.5	1194		3.862369	
6	2	13	59.8	1076		4.426353	
7	1	12	68.7			4.73938	
8	3	8	67.4	1549	1019	5.47453	
9	2	19	94.3	1266		6.138468	
10	1	20	73.4			6.907142	
11	1	10	84.3			7.368789	
12	1	17	80.4			8.510648	
13	2	7	71.3	1010		8.896467	
14	2	6	66.2	1282		9.403683	
15	1	17	98.5			10.496042	
16	1	16	85.3			11.233831	
17	2	17	84.8	1850		11.778426	

## Bin5 Statistics 18

Trial #	Pulse	Chirp (MHz)	Pulse Width (µS)	Pulse 1-2 spacing (uS)	Pulse 2-3 spacing (uS)	Pulse Start(S)	Detection (1:yes; 0:no)
0	2	8	88.5	1624		0.769844	1
1	1	10	68			1.57995	
2	2	20	77.5	1961		2.990397	
3	2	11	83	1186		5.039479	
4	3	7	99.9	1273	1825	6.60799	
5	3	18	59.5	1104	1295	7.416344	
6	3	8	61.7	1564	1523	9.161401	
7	1	7	76.7			10.267258	
8	2	9	92.2	1493		11.919004	

## Bin5 Statistics 19

Trial #	Pulse	Chirp (MHz)	Pulse Width (µS)	Pulse 1-2 spacing (uS)	Pulse 2-3 spacing (uS)	Pulse Start(S)	Detection (1:yes; 0:no)
0	3	6	64.3	1324	1528	0.734174	1
1	2	19	94.5	1270		2.348776	
2	2	12	89	1626		3.482059	
3	3	13	50.8	1357	1066	3.643312	
4	2	10	77.4	1201		4.886957	
5	3	20	95.3	1045	1732	7.042548	
6	2	6	79	1243		8.256502	
7	3	18	62.8	1155	1767	8.432394	
8	1	18	53.3			10.396107	
9	3	6	76.8	1622	1393	11.907237	

## Bin5 Statistics 20

Trial #	Pulse	Chirp (MHz)	Pulse Width (µS)	Pulse 1-2 spacing (uS)	Pulse 2-3 spacing (uS)	Pulse Start(S)	Detection (1:yes; 0:no)
0	3	11	83.8	1154	1806	0.397745	1
1	2	14	56.8	1059		1.212795	
2	2	17	79.5	1005		3.121943	
3	1	5	63.3			4.270054	
4	3	6	50.5	1164	1665	5.222007	
5	3	13	84.7	1372	1081	6.351303	
6	3	20	70.9	1579	1341	7.432944	
7	1	16	92.6			7.819203	
8	2	18	53.8	1530		9.64931	
9	2	14	75.7	1659		10.38812	
10	2	10	95.3	1179		11.636944	

## Bin5 Statistics 21

Trial #	Pulse	Chirp (MHz)	Pulse Width (µS)	Pulse 1-2 spacing (uS)	Pulse 2-3 spacing (uS)	Pulse Start(S)	Detection (1:yes; 0:no)
0	1	19	82.7			0.717466	1
1	2	18	83.6	1896		2.201916	
2	3	10	90.5	1634	1565	2.636265	
3	1	18	98			4.017272	
4	2	5	54.5	1983		5.958764	
5	3	5	90.5	1355	1233	6.082582	
6	2	6	80.1	1412		7.743599	
7	1	13	67.2			9.39119	
8	2	8	68.2	1279		9.718979	
9	2	9	64	1250		11.386902	

## Bin5 Statistics 22

Trial #	Pulse	Chirp (MHz)	Pulse Width (µS)	Pulse 1-2 spacing (uS)	Pulse 2-3 spacing (uS)	Pulse Start(S)	Detection (1:yes; 0:no)
0	3	19	54	1209	1340	1.151296	1
1	2	18	67	1165		2.295413	
2	2	5	59.2	1364		3.003025	
3	2	9	56.2	1490		3.858784	
4	1	13	56.9			5.444562	
5	3	7	52.3	1725	1742	6.174726	
6	2	16	58.6	1223		7.257968	
7	2	11	60.1	1169		9.585721	
8	2	16	80.4	1482		10.456212	
9	2	16	71.8	1000		10.808493	

## Bin5 Statistics 23

Trial #	Pulse	Chirp (MHz)	Pulse Width (µS)	Pulse 1-2 spacing (uS)	Pulse 2-3 spacing (uS)	Pulse Start(S)	Detection (1:yes; 0:no)
0	2	6	82.6	1505		0.731848	1
1	2	6	64.2	1729		1.191591	
2	3	16	97.5	1607	1450	1.950645	
3	1	19	99.1			2.737208	
4	2	10	61.4	1807		3.688123	
5	2	14	75.2	1740		4.375285	
6	3	18	86.5	1642	1213	5.405743	
7	2	11	57.2	1445		5.979253	
8	2	20	94.1	1751		6.711163	
9	3	8	62.4	1190	1041	7.553646	
10	2	15	74.3	1736		8.548322	
11	3	16	81.4	1802	1305	9.00187	
12	3	7	85.5	1918	1976	9.706796	
13	2	9	91.3	1444		10.719594	
14	1	19	72.9			11.923398	

## Bin5 Statistics 24

Trial #	Pulse	Chirp (MHz)	Pulse Width (µS)	Pulse 1-2 spacing (uS)	Pulse 2-3 spacing (uS)	Pulse Start(S)	Detection (1:yes; 0:no)
0	2	19	62.2	1837		0.621442	1
1	2	7	86.4	1769		0.933389	
2	2	5	79.4	1245		1.724559	
3	1	19	65.4			2.072459	
4	3	5	85.7	1930	1150	2.528089	
5	1	14	67.9			3.480068	
6	2	8	65.4	1446		3.981871	
7	3	20	89.5	1766	1558	4.675404	
8	2	8	66.1	1442		5.497292	
9	2	12	72.7	1108		6.129068	
10	3	19	98.1	1489	1989	6.787287	
11	2	14	88.2	1097		7.247691	
12	2	19	79.2	1404		7.850363	
13	3	17	98.5	1106	1886	8.609036	
14	3	19	83.7	1453	1453	8.933082	
15	2	16	78.2	1940		9.727828	
16	3	11	87.5	1439	1774	10.487877	
17	3	7	75.6	1799	1056	11.317766	
18	3	10	83	1333	1532	11.653169	

## Bin5 Statistics 25

Trial #	Pulse	Chirp (MHz)	Pulse Width (µS)	Pulse 1-2 spacing (uS)	Pulse 2-3 spacing (uS)	Pulse Start(S)	Detection (1:yes; 0:no)
0	3	11	87.4	1945	1138	1.091529	1
1	1	12	58.9			2.068421	
2	3	6	60.8	1204	1497	4.40481	
3	2	17	61.7	1218		5.9431	
4	1	18	95			7.146759	
5	1	5	71.4			7.697981	
6	2	13	65.9	1379		10.158401	
7	2	12	63.7	1890		11.803233	



## Bin5 Statistics 26

Trial #	Pulse	Chirp (MHz)	Pulse Width (µS)	Pulse 1-2 spacing (uS)	Pulse 2-3 spacing (uS)	Pulse Start(S)	Detection (1:yes; 0:no)
0	3	8	87.7	1559	1196	0.522321	1
1	2	10	85.8	1555		0.946794	
2	2	8	92.3	1362		1.47418	
3	3	8	97.8	1894	1420	2.121655	
4	1	20	57.3			3.295355	
5	3	14	67.9	1699	1625	3.959281	
6	1	18	70.3			4.521516	
7	1	9	93.4			5.3495	
8	1	7	62.9			6.079264	
9	3	10	88.3	1822	1460	6.506504	
10	3	9	61	1414	1111	7.684554	
11	3	16	88.4	1101	1303	7.836679	
12	2	12	78.6	1239		8.990348	
13	2	9	74.8	1706		9.662878	
14	3	14	84.9	1548	1635	10.493673	
15	3	17	51.9	1780	1120	11.011739	
16	3	7	62.3	1317	1323	11.942253	

## Bin5 Statistics 27

Trial #	Pulse	Chirp (MHz)	Pulse Width (µS)	Pulse 1-2 spacing (uS)	Pulse 2-3 spacing (uS)	Pulse Start(S)	Detection (1:yes; 0:no)
0	2	8	52.9	1275		0.285814	1
1	2	19	51.3	1737		0.968906	
2	2	13	73.5	1363		1.914069	
3	2	6	54.6	1643		3.136706	
4	2	10	92.9	1478		3.648796	
5	2	19	89.4	1138		4.405674	
6	1	18	58.2			5.648572	
7	2	16	77.1	1835		6.01034	
8	1	18	59.9			7.173842	
9	3	19	94.9	1626	1182	8.223925	
10	1	15	76.5			9.078323	
11	2	8	66.3	1886		9.874628	
12	2	19	71.5	1787		10.864909	
13	2	19	87.9	1374		11.320997	

## Bin5 Statistics 28

Trial #	Pulse	Chirp (MHz)	Pulse Width (µS)	Pulse 1-2 spacing (uS)	Pulse 2-3 spacing (uS)	Pulse Start(S)	Detection (1:yes; 0:no)
0	3	15	61.5	1880	1342	0.015738	1
1	3	15	92.6	1090	1371	1.290098	
2	1	6	93.7			2.574465	
3	2	17	81.2	1762		3.793491	
4	1	17	81.5			4.947765	
5	1	6	82.1			5.30192	
6	3	6	68.4	1038	1808	6.395078	
7	2	8	81.3	1363		7.098275	
8	1	20	90.6			8.201562	
9	3	15	93	1411	1133	9.401713	
10	2	14	83.2	1354		10.116772	
11	1	10	81			11.373352	

## Bin5 Statistics 29

Trial #	Pulse	Chirp (MHz)	Pulse Width (µS)	Pulse 1-2 spacing (uS)	Pulse 2-3 spacing (uS)	Pulse Start(S)	Detection (1:yes; 0:no)
0	1	15	50.7			0.312812	1
1	3	11	78	1021	1724	2.097392	
2	1	8	84.8			3.365383	
3	2	14	82.9	1932		4.859402	
4	3	15	94.4	1954	1074	6.37737	
5	2	7	58.9	1440		7.582385	
6	2	20	70.2	1103		8.438944	
7	3	9	74	1128	1240	10.064199	
8	2	11	69.6	1135		10.802338	

## Bin5 Statistics 30

<b>Trial #</b>	<b>Pulse</b>	<b>Chirp (MHz)</b>	<b>Pulse Width (µS)</b>	<b>Pulse 1-2 spacing (µS)</b>	<b>Pulse 2-3 spacing (µS)</b>	<b>Pulse Start(S)</b>	<b>Detection (1:yes; 0:no)</b>
0	2	7	81.5	1262		0.852325	1
1	3	16	74.3	1008	1836	2.539535	
2	3	11	93.6	1678	1160	3.565831	
3	3	15	94.8	1235	1631	5.193826	
4	1	17	55.3			5.619008	
5	1	9	68.5			7.756292	
6	2	14	60.2	1286		8.389185	
7	2	10	66.9	1360		10.015628	
8	2	9	99.8	1350		11.593073	

**Table-6 Radar Type 6 Statistical Performance**

Trial #	Fc (MHz)	Pulse /Burst	Pulse Width (µS)	PRI (µs)	Detection (1:yes; 0:no)	Hopping Sequence
1	5280	9	1	333	1	5685.0, 5409.0, 5352.0, 5503.0, 5707.0, 5575.0, 5533.0, 5378.0, 5542.0, 5504.0, 5673.0, 5468.0, 5317.0, 5594.0, 5632.0, 5587.0, 5273.0, 5525.0, 5416.0, 5410.0, 5563.0, 5686.0, 5654.0, 5669.0, 5332.0, 5699.0, 5407.0, 5566.0, 5584.0, 5543.0, 5476.0, 5647.0, 5555.0, 5652.0, 5372.0, 5572.0, 5319.0, 5299.0, 5680.0, 5671.0, 5519.0, 5351.0, 5388.0, 5428.0, 5641.0, 5538.0, 5380.0, 5469.0, 5327.0, 5381.0, 5619.0, 5498.0, 5591.0, 5253.0, 5445.0, 5646.0, 5463.0, 5655.0, 5455.0, 5674.0, 5535.0, 5431.0, 5633.0, 5601.0, 5644.0, 5704.0, 5590.0, 5539.0, 5615.0, 5305.0, 5291.0, 5386.0, 5350.0, 5347.0, 5611.0, 5258.0, 5310.0, 5377.0, 5313.0, 5457.0, 5612.0, 5683.0, 5713.0, 5340.0, 5689.0, 5675.0, 5323.0, 5304.0, 5334.0, 5275.0, 5717.0, 5709.0, 5529.0, 5392.0, 5568.0, 5368.0, 5667.0, 5436.0, 5506.0, 5329.0 (number of hits: 6)
2	5280	9	1	333	1	5390.0, 5387.0, 5281.0, 5475.0, 5322.0, 5363.0, 5562.0, 5675.0, 5702.0, 5284.0, 5633.0, 5447.0, 5603.0, 5398.0, 5354.0, 5528.0, 5683.0, 5697.0, 5451.0, 5564.0, 5536.0, 5421.0, 5651.0, 5255.0, 5523.0, 5319.0, 5355.0, 5381.0, 5290.0, 5335.0, 5316.0, 5645.0, 5389.0, 5487.0, 5331.0, 5688.0, 5508.0, 5658.0, 5287.0, 5713.0, 5476.0, 5292.0, 5446.0, 5541.0, 5615.0, 5372.0, 5563.0, 5560.0, 5617.0, 5505.0, 5258.0, 5515.0, 5314.0, 5262.0, 5646.0, 5654.0, 5538.0, 5394.0, 5340.0, 5513.0, 5504.0, 5643.0, 5348.0, 5676.0, 5460.0, 5368.0, 5437.0, 5698.0, 5582.0, 5601.0, 5610.0, 5556.0, 5310.0, 5455.0, 5584.0, 5678.0, 5674.0, 5553.0, 5606.0, 5304.0, 5642.0, 5661.0, 5407.0, 5288.0, 5619.0, 5492.0, 5657.0, 5445.0, 5456.0, 5404.0, 5473.0, 5411.0, 5344.0, 5500.0, 5648.0, 5628.0, 5632.0, 5496.0, 5370.0, 5482.0 (number of hits: 7)
3	5280	9	1	333	1	5600.0, 5383.0, 5354.0, 5662.0, 5687.0, 5286.0, 5616.0, 5582.0, 5475.0, 5253.0, 5262.0, 5471.0, 5298.0, 5456.0, 5506.0, 5531.0, 5373.0, 5596.0, 5517.0, 5481.0, 5299.0, 5716.0, 5516.0, 5421.0, 5581.0, 5297.0, 5445.0, 5703.0, 5263.0, 5443.0, 5441.0, 5278.0, 5267.0, 5284.0, 5579.0, 5574.0, 5629.0, 5490.0, 5281.0, 5406.0, 5617.0, 5614.0, 5415.0, 5388.0, 5271.0, 5544.0, 5469.0, 5528.0, 5258.0, 5627.0, 5664.0, 5437.0, 5358.0, 5380.0, 5448.0, 5459.0, 5419.0, 5414.0, 5640.0, 5655.0,

						5576.0, 5592.0, 5674.0, 5453.0, 5611.0, 5392.0, 5651.0, 5663.0, 5612.0, 5277.0, 5399.0, 5311.0, 5252.0, 5665.0, 5270.0, 5613.0, 5363.0, 5702.0, 5714.0, 5673.0, 5532.0, 5486.0, 5498.0, 5656.0, 5685.0, 5432.0, 5371.0, 5337.0, 5345.0, 5442.0, 5671.0, 5546.0, 5251.0, 5598.0, 5372.0, 5608.0, 5646.0, 5466.0, 5723.0, 5721.0 (number of hits: 5)
4	5280	9	1	333	1	5260.0, 5422.0, 5299.0, 5288.0, 5562.0, 5318.0, 5349.0, 5454.0, 5361.0, 5300.0, 5359.0, 5719.0, 5252.0, 5723.0, 5551.0, 5370.0, 5325.0, 5552.0, 5478.0, 5373.0, 5414.0, 5293.0, 5438.0, 5678.0, 5520.0, 5633.0, 5484.0, 5555.0, 5689.0, 5615.0, 5700.0, 5663.0, 5596.0, 5394.0, 5652.0, 5687.0, 5606.0, 5635.0, 5409.0, 5256.0, 5323.0, 5498.0, 5541.0, 5666.0, 5630.0, 5531.0, 5500.0, 5622.0, 5287.0, 5322.0, 5391.0, 5616.0, 5613.0, 5413.0, 5510.0, 5483.0, 5608.0, 5650.0, 5654.0, 5598.0, 5481.0, 5381.0, 5477.0, 5621.0, 5357.0, 5317.0, 5675.0, 5550.0, 5492.0, 5556.0, 5455.0, 5401.0, 5304.0, 5641.0, 5423.0, 5337.0, 5602.0, 5383.0, 5447.0, 5331.0, 5275.0, 5407.0, 5440.0, 5390.0, 5563.0, 5553.0, 5696.0, 5496.0, 5432.0, 5340.0, 5332.0, 5290.0, 5450.0, 5348.0, 5623.0, 5261.0, 5329.0, 5433.0, 5620.0, 5294.0 (number of hits: 8)
5	5280	9	1	333	1	5276.0, 5294.0, 5299.0, 5474.0, 5315.0, 5281.0, 5641.0, 5671.0, 5475.0, 5416.0, 5398.0, 5342.0, 5442.0, 5325.0, 5364.0, 5351.0, 5706.0, 5385.0, 5613.0, 5450.0, 5532.0, 5672.0, 5591.0, 5576.0, 5484.0, 5430.0, 5323.0, 5287.0, 5583.0, 5542.0, 5669.0, 5439.0, 5687.0, 5619.0, 5650.0, 5476.0, 5711.0, 5649.0, 5447.0, 5289.0, 5405.0, 5277.0, 5696.0, 5578.0, 5699.0, 5387.0, 5378.0, 5667.0, 5702.0, 5685.0, 5457.0, 5409.0, 5327.0, 5388.0, 5491.0, 5642.0, 5704.0, 5701.0, 5314.0, 5433.0, 5259.0, 5524.0, 5501.0, 5708.0, 5498.0, 5670.0, 5340.0, 5431.0, 5587.0, 5499.0, 5536.0, 5478.0, 5473.0, 5420.0, 5629.0, 5595.0, 5515.0, 5514.0, 5721.0, 5463.0, 5683.0, 5282.0, 5692.0, 5582.0, 5456.0, 5612.0, 5562.0, 5367.0, 5348.0, 5639.0, 5344.0, 5362.0, 5589.0, 5472.0, 5697.0, 5278.0, 5258.0, 5448.0, 5446.0, 5445.0 (number of hits: 5)
6	5280	9	1	333	1	5415.0, 5559.0, 5399.0, 5416.0, 5334.0, 5487.0, 5678.0, 5517.0, 5657.0, 5409.0, 5650.0, 5295.0, 5681.0, 5292.0, 5612.0, 5676.0, 5486.0, 5314.0, 5566.0, 5458.0, 5444.0, 5516.0, 5321.0, 5445.0, 5303.0, 5429.0, 5608.0, 5383.0, 5319.0, 5480.0, 5368.0, 5305.0, 5363.0, 5291.0, 5475.0, 5356.0, 5531.0, 5265.0, 5406.0, 5362.0,

						5476.0, 5279.0, 5376.0, 5570.0, 5443.0, 5705.0, 5442.0, 5605.0, 5318.0, 5620.0, 5532.0, 5708.0, 5420.0, 5289.0, 5255.0, 5488.0, 5352.0, 5512.0, 5403.0, 5343.0, 5639.0, 5526.0, 5636.0, 5306.0, 5654.0, 5428.0, 5582.0, 5386.0, 5342.0, 5313.0, 5361.0, 5358.0, 5723.0, 5577.0, 5721.0, 5349.0, 5366.0, 5479.0, 5704.0, 5324.0, 5597.0, 5589.0, 5472.0, 5644.0, 5315.0, 5492.0, 5251.0, 5453.0, 5457.0, 5538.0, 5519.0, 5354.0, 5518.0, 5638.0, 5640.0, 5270.0, 5328.0, 5699.0, 5364.0, 5667.0 (number of hits: 9)
7	5280	9	1	333	1	5407.0, 5478.0, 5343.0, 5494.0, 5640.0, 5453.0, 5496.0, 5506.0, 5452.0, 5685.0, 5417.0, 5597.0, 5486.0, 5559.0, 5500.0, 5539.0, 5490.0, 5557.0, 5576.0, 5612.0, 5633.0, 5538.0, 5634.0, 5441.0, 5427.0, 5290.0, 5672.0, 5529.0, 5593.0, 5632.0, 5511.0, 5391.0, 5308.0, 5587.0, 5445.0, 5426.0, 5567.0, 5365.0, 5674.0, 5262.0, 5722.0, 5670.0, 5479.0, 5428.0, 5271.0, 5410.0, 5610.0, 5266.0, 5641.0, 5719.0, 5335.0, 5517.0, 5405.0, 5388.0, 5358.0, 5282.0, 5465.0, 5353.0, 5540.0, 5429.0, 5381.0, 5717.0, 5571.0, 5366.0, 5691.0, 5644.0, 5254.0, 5487.0, 5464.0, 5547.0, 5657.0, 5449.0, 5723.0, 5303.0, 5278.0, 5648.0, 5484.0, 5309.0, 5337.0, 5596.0, 5469.0, 5570.0, 5375.0, 5376.0, 5277.0, 5561.0, 5613.0, 5291.0, 5414.0, 5577.0, 5512.0, 5311.0, 5503.0, 5615.0, 5595.0, 5537.0, 5329.0, 5666.0, 5361.0, 5642.0 (number of hits: 6)
8	5280	9	1	333	1	5498.0, 5652.0, 5314.0, 5363.0, 5354.0, 5676.0, 5418.0, 5339.0, 5277.0, 5455.0, 5447.0, 5343.0, 5680.0, 5486.0, 5711.0, 5707.0, 5519.0, 5440.0, 5602.0, 5612.0, 5324.0, 5690.0, 5267.0, 5675.0, 5666.0, 5382.0, 5592.0, 5667.0, 5643.0, 5524.0, 5391.0, 5550.0, 5289.0, 5684.0, 5607.0, 5479.0, 5634.0, 5364.0, 5573.0, 5463.0, 5369.0, 5282.0, 5411.0, 5674.0, 5576.0, 5476.0, 5422.0, 5546.0, 5258.0, 5627.0, 5668.0, 5693.0, 5514.0, 5451.0, 5551.0, 5561.0, 5596.0, 5511.0, 5448.0, 5670.0, 5500.0, 5610.0, 5679.0, 5352.0, 5262.0, 5621.0, 5306.0, 5635.0, 5542.0, 5659.0, 5639.0, 5687.0, 5611.0, 5499.0, 5397.0, 5678.0, 5569.0, 5702.0, 5605.0, 5295.0, 5661.0, 5577.0, 5273.0, 5719.0, 5433.0, 5515.0, 5395.0, 5331.0, 5484.0, 5268.0, 5647.0, 5723.0, 5654.0, 5265.0, 5658.0, 5522.0, 5319.0, 5320.0, 5489.0, 5461.0 (number of hits: 4)
9	5280	9	1	333	1	5460.0, 5336.0, 5268.0, 5464.0, 5525.0, 5485.0, 5641.0, 5556.0, 5407.0, 5539.0, 5506.0, 5388.0, 5628.0, 5450.0, 5391.0, 5405.0, 5319.0, 5297.0, 5598.0, 5666.0,

						5469.0, 5635.0, 5664.0, 5665.0, 5609.0, 5528.0, 5350.0, 5300.0, 5434.0, 5296.0, 5578.0, 5590.0, 5419.0, 5328.0, 5563.0, 5258.0, 5566.0, 5351.0, 5669.0, 5266.0, 5634.0, 5638.0, 5373.0, 5672.0, 5554.0, 5306.0, 5695.0, 5684.0, 5658.0, 5276.0, 5323.0, 5572.0, 5704.0, 5649.0, 5355.0, 5484.0, 5681.0, 5295.0, 5701.0, 5363.0, 5508.0, 5431.0, 5512.0, 5425.0, 5611.0, 5699.0, 5481.0, 5517.0, 5254.0, 5680.0, 5537.0, 5696.0, 5453.0, 5624.0, 5325.0, 5691.0, 5474.0, 5273.0, 5470.0, 5575.0, 5291.0, 5466.0, 5671.0, 5279.0, 5574.0, 5385.0, 5463.0, 5632.0, 5483.0, 5518.0, 5462.0, 5275.0, 5650.0, 5449.0, 5653.0, 5368.0, 5714.0, 5629.0, 5723.0, 5498.0 (number of hits: 6)
10	5280	9	1	333	1	5470.0, 5721.0, 5336.0, 5463.0, 5612.0, 5596.0, 5509.0, 5383.0, 5672.0, 5707.0, 5723.0, 5271.0, 5428.0, 5522.0, 5402.0, 5371.0, 5349.0, 5626.0, 5691.0, 5346.0, 5418.0, 5582.0, 5554.0, 5356.0, 5262.0, 5676.0, 5255.0, 5627.0, 5686.0, 5333.0, 5395.0, 5605.0, 5303.0, 5387.0, 5529.0, 5481.0, 5340.0, 5355.0, 5643.0, 5618.0, 5276.0, 5607.0, 5434.0, 5552.0, 5664.0, 5669.0, 5646.0, 5261.0, 5285.0, 5263.0, 5543.0, 5671.0, 5604.0, 5511.0, 5505.0, 5540.0, 5551.0, 5610.0, 5287.0, 5337.0, 5289.0, 5712.0, 5277.0, 5469.0, 5450.0, 5578.0, 5409.0, 5310.0, 5451.0, 5617.0, 5677.0, 5564.0, 5368.0, 5584.0, 5314.0, 5616.0, 5621.0, 5382.0, 5269.0, 5632.0, 5518.0, 5443.0, 5282.0, 5637.0, 5424.0, 5486.0, 5457.0, 5311.0, 5622.0, 5673.0, 5545.0, 5378.0, 5658.0, 5701.0, 5441.0, 5466.0, 5325.0, 5574.0, 5526.0, 5479.0 (number of hits: 7)
11	5280	9	1	333	1	5295.0, 5580.0, 5596.0, 5303.0, 5670.0, 5518.0, 5615.0, 5563.0, 5270.0, 5381.0, 5438.0, 5630.0, 5574.0, 5641.0, 5439.0, 5715.0, 5539.0, 5692.0, 5553.0, 5648.0, 5448.0, 5296.0, 5424.0, 5682.0, 5569.0, 5477.0, 5555.0, 5617.0, 5266.0, 5389.0, 5534.0, 5494.0, 5392.0, 5621.0, 5302.0, 5445.0, 5341.0, 5321.0, 5540.0, 5294.0, 5431.0, 5485.0, 5538.0, 5693.0, 5352.0, 5466.0, 5418.0, 5451.0, 5340.0, 5669.0, 5360.0, 5460.0, 5471.0, 5623.0, 5625.0, 5705.0, 5699.0, 5376.0, 5512.0, 5334.0, 5354.0, 5480.0, 5265.0, 5409.0, 5597.0, 5461.0, 5611.0, 5683.0, 5724.0, 5275.0, 5503.0, 5667.0, 5639.0, 5413.0, 5672.0, 5319.0, 5472.0, 5473.0, 5368.0, 5271.0, 5708.0, 5326.0, 5490.0, 5570.0, 5533.0, 5422.0, 5333.0, 5628.0, 5652.0, 5443.0, 5606.0, 5516.0, 5317.0, 5337.0, 5614.0, 5329.0, 5280.0, 5436.0, 5363.0, 5283.0 (number of hits: 5)

12	5280	9	1	333	1	<p>5602.0, 5715.0, 5501.0, 5312.0, 5420.0, 5529.0, 5320.0, 5632.0, 5462.0, 5354.0, 5424.0, 5335.0, 5392.0, 5707.0, 5315.0, 5553.0, 5581.0, 5342.0, 5421.0, 5550.0, 5381.0, 5443.0, 5655.0, 5640.0, 5450.0, 5373.0, 5283.0, 5321.0, 5264.0, 5521.0, 5622.0, 5441.0, 5349.0, 5341.0, 5648.0, 5713.0, 5606.0, 5528.0, 5305.0, 5436.0, 5496.0, 5352.0, 5571.0, 5645.0, 5444.0, 5380.0, 5452.0, 5417.0, 5288.0, 5512.0, 5614.0, 5676.0, 5325.0, 5670.0, 5367.0, 5665.0, 5376.0, 5591.0, 5410.0, 5654.0, 5723.0, 5683.0, 5616.0, 5293.0, 5531.0, 5716.0, 5280.0, 5687.0, 5503.0, 5469.0, 5644.0, 5537.0, 5337.0, 5677.0, 5458.0, 5412.0, 5317.0, 5332.0, 5694.0, 5351.0, 5378.0, 5703.0, 5569.0, 5461.0, 5592.0, 5498.0, 5638.0, 5509.0, 5520.0, 5511.0, 5423.0, 5383.0, 5377.0, 5252.0, 5593.0, 5674.0, 5708.0, 5477.0, 5304.0, 5339.0 (number of hits: 5)</p>
13	5280	9	1	333	1	<p>5417.0, 5564.0, 5392.0, 5523.0, 5485.0, 5405.0, 5705.0, 5340.0, 5710.0, 5386.0, 5371.0, 5554.0, 5374.0, 5383.0, 5664.0, 5572.0, 5589.0, 5618.0, 5252.0, 5503.0, 5566.0, 5440.0, 5495.0, 5358.0, 5535.0, 5325.0, 5369.0, 5413.0, 5558.0, 5674.0, 5491.0, 5270.0, 5407.0, 5540.0, 5723.0, 5416.0, 5565.0, 5456.0, 5586.0, 5543.0, 5418.0, 5455.0, 5353.0, 5501.0, 5260.0, 5269.0, 5403.0, 5487.0, 5477.0, 5701.0, 5414.0, 5266.0, 5590.0, 5351.0, 5287.0, 5512.0, 5629.0, 5254.0, 5313.0, 5651.0, 5357.0, 5310.0, 5509.0, 5669.0, 5296.0, 5571.0, 5317.0, 5341.0, 5419.0, 5318.0, 5689.0, 5257.0, 5476.0, 5620.0, 5468.0, 5453.0, 5290.0, 5422.0, 5363.0, 5526.0, 5721.0, 5663.0, 5679.0, 5483.0, 5513.0, 5537.0, 5593.0, 5551.0, 5702.0, 5652.0, 5262.0, 5681.0, 5718.0, 5384.0, 5530.0, 5251.0, 5444.0, 5385.0, 5644.0, 5289.0 (number of hits: 6)</p>
14	5280	9	1	333	1	<p>5392.0, 5600.0, 5553.0, 5624.0, 5474.0, 5252.0, 5502.0, 5376.0, 5511.0, 5334.0, 5273.0, 5528.0, 5443.0, 5489.0, 5351.0, 5294.0, 5556.0, 5581.0, 5302.0, 5326.0, 5674.0, 5574.0, 5333.0, 5570.0, 5366.0, 5361.0, 5700.0, 5677.0, 5281.0, 5303.0, 5692.0, 5259.0, 5476.0, 5461.0, 5257.0, 5480.0, 5379.0, 5338.0, 5669.0, 5496.0, 5486.0, 5315.0, 5435.0, 5347.0, 5319.0, 5589.0, 5420.0, 5292.0, 5672.0, 5596.0, 5287.0, 5305.0, 5659.0, 5278.0, 5290.0, 5359.0, 5694.0, 5304.0, 5384.0, 5651.0, 5437.0, 5444.0, 5517.0, 5429.0, 5593.0, 5394.0, 5291.0, 5477.0, 5698.0, 5718.0, 5374.0, 5386.0, 5459.0, 5491.0, 5468.0, 5627.0, 5307.0, 5621.0, 5614.0, 5328.0, 5413.0, 5268.0, 5418.0, 5369.0, 5271.0,</p>



						5377.0, 5702.0, 5605.0, 5352.0, 5342.0, 5513.0, 5610.0, 5410.0, 5668.0, 5566.0, 5495.0, 5488.0, 5508.0, 5531.0, 5398.0 (number of hits: 10)
15	5280	9	1	333	1	5539.0, 5478.0, 5507.0, 5447.0, 5406.0, 5343.0, 5334.0, 5312.0, 5542.0, 5389.0, 5394.0, 5685.0, 5681.0, 5601.0, 5602.0, 5264.0, 5514.0, 5336.0, 5414.0, 5569.0, 5705.0, 5309.0, 5362.0, 5328.0, 5400.0, 5684.0, 5338.0, 5595.0, 5300.0, 5575.0, 5291.0, 5251.0, 5644.0, 5481.0, 5276.0, 5533.0, 5269.0, 5510.0, 5523.0, 5456.0, 5485.0, 5598.0, 5409.0, 5638.0, 5526.0, 5361.0, 5385.0, 5391.0, 5658.0, 5649.0, 5467.0, 5487.0, 5642.0, 5293.0, 5340.0, 5552.0, 5704.0, 5410.0, 5442.0, 5364.0, 5419.0, 5633.0, 5668.0, 5677.0, 5388.0, 5420.0, 5455.0, 5430.0, 5344.0, 5597.0, 5697.0, 5457.0, 5522.0, 5356.0, 5555.0, 5558.0, 5679.0, 5265.0, 5669.0, 5477.0, 5329.0, 5509.0, 5622.0, 5655.0, 5274.0, 5348.0, 5459.0, 5720.0, 5480.0, 5659.0, 5628.0, 5347.0, 5403.0, 5407.0, 5449.0, 5326.0, 5272.0, 5435.0, 5656.0, 5374.0 (number of hits: 5)
16	5280	9	1	333	1	5341.0, 5620.0, 5584.0, 5508.0, 5413.0, 5640.0, 5471.0, 5562.0, 5357.0, 5655.0, 5635.0, 5510.0, 5310.0, 5367.0, 5529.0, 5321.0, 5702.0, 5389.0, 5653.0, 5264.0, 5287.0, 5306.0, 5484.0, 5304.0, 5593.0, 5275.0, 5474.0, 5452.0, 5550.0, 5358.0, 5649.0, 5675.0, 5309.0, 5654.0, 5305.0, 5355.0, 5564.0, 5380.0, 5257.0, 5618.0, 5694.0, 5438.0, 5420.0, 5385.0, 5630.0, 5316.0, 5463.0, 5303.0, 5643.0, 5436.0, 5453.0, 5402.0, 5624.0, 5386.0, 5482.0, 5546.0, 5479.0, 5641.0, 5404.0, 5327.0, 5714.0, 5606.0, 5476.0, 5291.0, 5262.0, 5682.0, 5573.0, 5379.0, 5307.0, 5535.0, 5469.0, 5407.0, 5283.0, 5437.0, 5313.0, 5455.0, 5259.0, 5666.0, 5481.0, 5368.0, 5715.0, 5354.0, 5561.0, 5486.0, 5370.0, 5587.0, 5284.0, 5553.0, 5663.0, 5425.0, 5693.0, 5363.0, 5418.0, 5656.0, 5467.0, 5473.0, 5558.0, 5652.0, 5335.0, 5480.0 (number of hits: 10)
17	5280	9	1	333	1	5480.0, 5608.0, 5706.0, 5345.0, 5278.0, 5264.0, 5297.0, 5305.0, 5595.0, 5620.0, 5300.0, 5635.0, 5665.0, 5541.0, 5667.0, 5368.0, 5419.0, 5475.0, 5592.0, 5276.0, 5546.0, 5715.0, 5377.0, 5396.0, 5272.0, 5569.0, 5488.0, 5481.0, 5288.0, 5375.0, 5591.0, 5348.0, 5662.0, 5362.0, 5366.0, 5389.0, 5251.0, 5281.0, 5450.0, 5710.0, 5682.0, 5474.0, 5282.0, 5356.0, 5299.0, 5581.0, 5432.0, 5651.0, 5417.0, 5386.0, 5549.0, 5584.0, 5294.0, 5336.0, 5444.0, 5514.0, 5324.0, 5707.0, 5684.0, 5312.0, 5446.0, 5552.0, 5313.0, 5491.0, 5705.0,

						5431.0, 5611.0, 5372.0, 5508.0, 5395.0, 5353.0, 5473.0, 5547.0, 5307.0, 5627.0, 5402.0, 5589.0, 5503.0, 5343.0, 5714.0, 5433.0, 5262.0, 5689.0, 5472.0, 5359.0, 5613.0, 5418.0, 5594.0, 5338.0, 5722.0, 5261.0, 5528.0, 5371.0, 5687.0, 5296.0, 5483.0, 5717.0, 5321.0, 5409.0, 5542.0 (number of hits: 10)
18	5280	9	1	333	1	5582.0, 5403.0, 5641.0, 5375.0, 5596.0, 5321.0, 5358.0, 5257.0, 5594.0, 5329.0, 5717.0, 5426.0, 5510.0, 5348.0, 5559.0, 5635.0, 5653.0, 5254.0, 5454.0, 5670.0, 5373.0, 5352.0, 5537.0, 5561.0, 5683.0, 5339.0, 5629.0, 5512.0, 5259.0, 5659.0, 5663.0, 5647.0, 5389.0, 5354.0, 5271.0, 5720.0, 5677.0, 5438.0, 5502.0, 5639.0, 5529.0, 5673.0, 5341.0, 5517.0, 5581.0, 5314.0, 5704.0, 5405.0, 5678.0, 5351.0, 5597.0, 5679.0, 5301.0, 5380.0, 5697.0, 5666.0, 5344.0, 5575.0, 5556.0, 5519.0, 5260.0, 5656.0, 5442.0, 5591.0, 5437.0, 5579.0, 5545.0, 5676.0, 5688.0, 5497.0, 5578.0, 5605.0, 5478.0, 5445.0, 5550.0, 5557.0, 5387.0, 5278.0, 5311.0, 5327.0, 5408.0, 5611.0, 5468.0, 5707.0, 5498.0, 5655.0, 5476.0, 5721.0, 5404.0, 5660.0, 5458.0, 5604.0, 5535.0, 5409.0, 5279.0, 5687.0, 5288.0, 5475.0, 5466.0, 5612.0 (number of hits: 4)
19	5280	9	1	333	1	5619.0, 5530.0, 5314.0, 5565.0, 5505.0, 5322.0, 5681.0, 5694.0, 5296.0, 5572.0, 5348.0, 5715.0, 5626.0, 5634.0, 5558.0, 5338.0, 5442.0, 5642.0, 5366.0, 5474.0, 5706.0, 5276.0, 5409.0, 5299.0, 5652.0, 5669.0, 5698.0, 5522.0, 5302.0, 5701.0, 5536.0, 5526.0, 5286.0, 5573.0, 5622.0, 5560.0, 5675.0, 5637.0, 5705.0, 5552.0, 5297.0, 5670.0, 5543.0, 5345.0, 5708.0, 5621.0, 5325.0, 5448.0, 5254.0, 5699.0, 5447.0, 5561.0, 5293.0, 5370.0, 5484.0, 5346.0, 5390.0, 5291.0, 5493.0, 5608.0, 5401.0, 5333.0, 5374.0, 5668.0, 5486.0, 5605.0, 5407.0, 5288.0, 5278.0, 5357.0, 5279.0, 5504.0, 5507.0, 5375.0, 5327.0, 5344.0, 5422.0, 5564.0, 5651.0, 5347.0, 5688.0, 5426.0, 5262.0, 5615.0, 5399.0, 5677.0, 5661.0, 5285.0, 5664.0, 5284.0, 5609.0, 5358.0, 5650.0, 5617.0, 5441.0, 5716.0, 5697.0, 5563.0, 5437.0, 5600.0 (number of hits: 10)
20	5280	9	1	333	1	5513.0, 5592.0, 5390.0, 5641.0, 5527.0, 5472.0, 5360.0, 5627.0, 5313.0, 5668.0, 5411.0, 5552.0, 5431.0, 5507.0, 5422.0, 5634.0, 5652.0, 5347.0, 5616.0, 5548.0, 5528.0, 5334.0, 5419.0, 5483.0, 5291.0, 5432.0, 5538.0, 5328.0, 5614.0, 5600.0, 5597.0, 5559.0, 5279.0, 5642.0, 5254.0, 5598.0, 5353.0, 5346.0, 5405.0, 5590.0, 5697.0, 5563.0, 5692.0, 5660.0, 5532.0,

						5370.0, 5693.0, 5648.0, 5350.0, 5332.0, 5689.0, 5636.0, 5688.0, 5669.0, 5686.0, 5628.0, 5354.0, 5480.0, 5375.0, 5601.0, 5265.0, 5635.0, 5458.0, 5650.0, 5379.0, 5583.0, 5266.0, 5424.0, 5418.0, 5368.0, 5591.0, 5412.0, 5514.0, 5400.0, 5352.0, 5569.0, 5564.0, 5484.0, 5301.0, 5492.0, 5556.0, 5460.0, 5351.0, 5303.0, 5259.0, 5250.0, 5436.0, 5673.0, 5361.0, 5298.0, 5671.0, 5399.0, 5325.0, 5551.0, 5684.0, 5587.0, 5537.0, 5462.0, 5427.0, 5387.0 (number of hits: 5)
21	5280	9	1	333	1	5418.0, 5441.0, 5290.0, 5300.0, 5284.0, 5389.0, 5336.0, 5501.0, 5353.0, 5641.0, 5510.0, 5470.0, 5258.0, 5356.0, 5287.0, 5697.0, 5446.0, 5561.0, 5492.0, 5483.0, 5511.0, 5383.0, 5675.0, 5663.0, 5369.0, 5274.0, 5705.0, 5622.0, 5467.0, 5525.0, 5465.0, 5604.0, 5403.0, 5484.0, 5365.0, 5689.0, 5721.0, 5440.0, 5567.0, 5263.0, 5486.0, 5579.0, 5524.0, 5602.0, 5334.0, 5636.0, 5397.0, 5378.0, 5425.0, 5546.0, 5505.0, 5400.0, 5685.0, 5518.0, 5338.0, 5539.0, 5281.0, 5427.0, 5538.0, 5433.0, 5256.0, 5429.0, 5278.0, 5419.0, 5588.0, 5375.0, 5449.0, 5471.0, 5614.0, 5527.0, 5268.0, 5292.0, 5366.0, 5307.0, 5315.0, 5310.0, 5437.0, 5436.0, 5423.0, 5343.0, 5592.0, 5349.0, 5519.0, 5711.0, 5520.0, 5473.0, 5320.0, 5385.0, 5583.0, 5633.0, 5587.0, 5330.0, 5601.0, 5565.0, 5522.0, 5560.0, 5700.0, 5569.0, 5691.0, 5468.0 (number of hits: 6)
22	5280	9	1	333	1	5479.0, 5586.0, 5614.0, 5370.0, 5581.0, 5502.0, 5510.0, 5553.0, 5359.0, 5514.0, 5597.0, 5598.0, 5278.0, 5517.0, 5350.0, 5593.0, 5340.0, 5708.0, 5700.0, 5525.0, 5558.0, 5269.0, 5723.0, 5610.0, 5449.0, 5710.0, 5529.0, 5450.0, 5616.0, 5329.0, 5548.0, 5561.0, 5621.0, 5522.0, 5428.0, 5445.0, 5662.0, 5715.0, 5645.0, 5690.0, 5676.0, 5596.0, 5547.0, 5695.0, 5258.0, 5427.0, 5499.0, 5453.0, 5718.0, 5540.0, 5323.0, 5322.0, 5673.0, 5568.0, 5283.0, 5484.0, 5251.0, 5356.0, 5373.0, 5678.0, 5419.0, 5301.0, 5288.0, 5271.0, 5631.0, 5694.0, 5304.0, 5633.0, 5639.0, 5496.0, 5407.0, 5434.0, 5414.0, 5337.0, 5569.0, 5533.0, 5384.0, 5298.0, 5458.0, 5523.0, 5507.0, 5430.0, 5435.0, 5608.0, 5312.0, 5310.0, 5366.0, 5669.0, 5583.0, 5588.0, 5408.0, 5386.0, 5713.0, 5262.0, 5717.0, 5651.0, 5539.0, 5418.0, 5591.0, 5566.0 (number of hits: 6)
23	5280	9	1	333	1	5684.0, 5390.0, 5563.0, 5579.0, 5522.0, 5706.0, 5507.0, 5690.0, 5489.0, 5375.0, 5720.0, 5254.0, 5296.0, 5449.0, 5703.0, 5721.0, 5377.0, 5586.0, 5500.0, 5628.0, 5615.0, 5640.0, 5294.0, 5716.0, 5398.0

						5279.0, 5327.0, 5459.0, 5660.0, 5583.0, 5634.0, 5659.0, 5443.0, 5280.0, 5643.0, 5350.0, 5569.0, 5434.0, 5286.0, 5444.0, 5478.0, 5595.0, 5589.0, 5587.0, 5683.0, 5650.0, 5561.0, 5334.0, 5260.0, 5399.0, 5665.0, 5374.0, 5265.0, 5574.0, 5584.0, 5462.0, 5708.0, 5675.0, 5357.0, 5329.0, 5669.0, 5624.0, 5654.0, 5681.0, 5420.0, 5482.0, 5559.0, 5723.0, 5340.0, 5306.0, 5310.0, 5457.0, 5552.0, 5605.0, 5717.0, 5368.0, 5441.0, 5538.0, 5316.0, 5597.0, 5676.0, 5313.0, 5622.0, 5714.0, 5456.0, 5494.0, 5396.0, 5359.0, 5517.0, 5627.0, 5528.0, 5685.0, 5278.0, 5631.0, 5273.0, 5319.0, 5593.0, 5448.0, 5506.0, 5701.0 (number of hits: 6)
24	5280	9	1	333	1	5586.0, 5647.0, 5516.0, 5492.0, 5357.0, 5679.0, 5513.0, 5564.0, 5277.0, 5367.0, 5413.0, 5490.0, 5407.0, 5279.0, 5415.0, 5285.0, 5570.0, 5370.0, 5462.0, 5331.0, 5710.0, 5260.0, 5265.0, 5371.0, 5309.0, 5643.0, 5361.0, 5699.0, 5678.0, 5419.0, 5610.0, 5716.0, 5412.0, 5549.0, 5453.0, 5283.0, 5372.0, 5332.0, 5682.0, 5503.0, 5267.0, 5456.0, 5271.0, 5721.0, 5459.0, 5587.0, 5506.0, 5328.0, 5252.0, 5402.0, 5457.0, 5446.0, 5547.0, 5389.0, 5427.0, 5505.0, 5637.0, 5636.0, 5348.0, 5617.0, 5574.0, 5411.0, 5584.0, 5634.0, 5334.0, 5319.0, 5589.0, 5297.0, 5718.0, 5375.0, 5512.0, 5278.0, 5498.0, 5680.0, 5652.0, 5524.0, 5254.0, 5438.0, 5340.0, 5431.0, 5325.0, 5373.0, 5256.0, 5276.0, 5289.0, 5488.0, 5359.0, 5658.0, 5632.0, 5593.0, 5724.0, 5434.0, 5460.0, 5481.0, 5561.0, 5672.0, 5551.0, 5667.0, 5668.0, 5571.0 (number of hits: 4)
25	5280	9	1	333	1	5485.0, 5539.0, 5458.0, 5417.0, 5423.0, 5270.0, 5488.0, 5559.0, 5284.0, 5443.0, 5688.0, 5689.0, 5671.0, 5339.0, 5440.0, 5360.0, 5503.0, 5368.0, 5661.0, 5479.0, 5501.0, 5643.0, 5457.0, 5308.0, 5337.0, 5332.0, 5307.0, 5425.0, 5602.0, 5380.0, 5646.0, 5611.0, 5272.0, 5587.0, 5336.0, 5529.0, 5326.0, 5274.0, 5498.0, 5647.0, 5369.0, 5297.0, 5700.0, 5675.0, 5453.0, 5504.0, 5327.0, 5590.0, 5304.0, 5456.0, 5638.0, 5474.0, 5372.0, 5597.0, 5495.0, 5581.0, 5315.0, 5277.0, 5262.0, 5449.0, 5570.0, 5580.0, 5489.0, 5579.0, 5593.0, 5558.0, 5577.0, 5625.0, 5388.0, 5462.0, 5534.0, 5642.0, 5414.0, 5263.0, 5690.0, 5596.0, 5328.0, 5687.0, 5370.0, 5566.0, 5644.0, 5518.0, 5512.0, 5362.0, 5678.0, 5623.0, 5709.0, 5343.0, 5348.0, 5651.0, 5576.0, 5355.0, 5486.0, 5509.0, 5445.0, 5521.0, 5450.0, 5466.0, 5698.0, 5662.0 (number of hits: 4)
26	5280	9	1	333	1	5473.0, 5466.0, 5311.0, 5657.0, 5448.0,

						5611.0, 5538.0, 5437.0, 5457.0, 5681.0, 5409.0, 5375.0, 5643.0, 5441.0, 5480.0, 5364.0, 5618.0, 5655.0, 5379.0, 5668.0, 5428.0, 5291.0, 5478.0, 5354.0, 5593.0, 5262.0, 5456.0, 5537.0, 5656.0, 5366.0, 5431.0, 5469.0, 5705.0, 5308.0, 5535.0, 5386.0, 5345.0, 5367.0, 5685.0, 5673.0, 5590.0, 5438.0, 5583.0, 5627.0, 5425.0, 5696.0, 5605.0, 5658.0, 5358.0, 5560.0, 5255.0, 5710.0, 5429.0, 5707.0, 5608.0, 5272.0, 5348.0, 5561.0, 5556.0, 5713.0, 5585.0, 5542.0, 5702.0, 5703.0, 5387.0, 5575.0, 5603.0, 5341.0, 5530.0, 5328.0, 5435.0, 5717.0, 5494.0, 5372.0, 5496.0, 5566.0, 5602.0, 5520.0, 5653.0, 5434.0, 5662.0, 5331.0, 5471.0, 5632.0, 5339.0, 5546.0, 5253.0, 5527.0, 5338.0, 5353.0, 5403.0, 5307.0, 5405.0, 5260.0, 5679.0, 5421.0, 5507.0, 5461.0, 5304.0, 5589.0 (number of hits: 5 )
27	5280	9	1	333	1	5430.0, 5533.0, 5261.0, 5702.0, 5307.0, 5664.0, 5409.0, 5346.0, 5647.0, 5656.0, 5387.0, 5550.0, 5578.0, 5619.0, 5618.0, 5534.0, 5354.0, 5415.0, 5590.0, 5706.0, 5383.0, 5539.0, 5524.0, 5339.0, 5299.0, 5614.0, 5707.0, 5293.0, 5374.0, 5378.0, 5620.0, 5501.0, 5366.0, 5345.0, 5632.0, 5428.0, 5457.0, 5659.0, 5653.0, 5316.0, 5598.0, 5648.0, 5371.0, 5460.0, 5509.0, 5363.0, 5523.0, 5291.0, 5623.0, 5610.0, 5271.0, 5687.0, 5290.0, 5440.0, 5426.0, 5535.0, 5704.0, 5689.0, 5453.0, 5279.0, 5443.0, 5281.0, 5484.0, 5344.0, 5449.0, 5340.0, 5487.0, 5325.0, 5377.0, 5713.0, 5336.0, 5444.0, 5341.0, 5446.0, 5331.0, 5684.0, 5577.0, 5516.0, 5543.0, 5272.0, 5372.0, 5301.0, 5330.0, 5611.0, 5529.0, 5476.0, 5380.0, 5514.0, 5625.0, 5676.0, 5617.0, 5470.0, 5414.0, 5607.0, 5379.0, 5700.0, 5608.0, 5322.0, 5388.0, 5604.0 (number of hits: 6 )
28	5280	9	1	333	1	5470.0, 5414.0, 5417.0, 5476.0, 5259.0, 5395.0, 5399.0, 5654.0, 5257.0, 5380.0, 5320.0, 5591.0, 5710.0, 5488.0, 5628.0, 5574.0, 5511.0, 5273.0, 5567.0, 5271.0, 5307.0, 5483.0, 5673.0, 5403.0, 5296.0, 5283.0, 5321.0, 5592.0, 5644.0, 5288.0, 5562.0, 5486.0, 5573.0, 5721.0, 5529.0, 5274.0, 5553.0, 5499.0, 5319.0, 5700.0, 5587.0, 5338.0, 5277.0, 5333.0, 5363.0, 5471.0, 5287.0, 5496.0, 5643.0, 5374.0, 5682.0, 5447.0, 5543.0, 5657.0, 5658.0, 5598.0, 5692.0, 5633.0, 5434.0, 5634.0, 5701.0, 5566.0, 5385.0, 5416.0, 5549.0, 5706.0, 5485.0, 5639.0, 5530.0, 5372.0, 5518.0, 5381.0, 5344.0, 5523.0, 5670.0, 5536.0, 5551.0, 5514.0, 5327.0, 5612.0, 5465.0, 5355.0, 5516.0, 5636.0, 5418.0, 5652.0, 5510.0, 5605.0, 5648.0, 5583.0

						5627.0, 5546.0, 5560.0, 5392.0, 5391.0, 5286.0, 5723.0, 5398.0, 5387.0, 5582.0 (number of hits: 5)
29	5280	9	1	333	1	5531.0, 5391.0, 5617.0, 5266.0, 5315.0, 5423.0, 5655.0, 5671.0, 5561.0, 5292.0, 5693.0, 5377.0, 5322.0, 5612.0, 5417.0, 5433.0, 5649.0, 5498.0, 5621.0, 5429.0, 5360.0, 5343.0, 5283.0, 5421.0, 5633.0, 5538.0, 5303.0, 5509.0, 5619.0, 5400.0, 5715.0, 5338.0, 5432.0, 5640.0, 5484.0, 5427.0, 5723.0, 5607.0, 5438.0, 5379.0, 5515.0, 5718.0, 5720.0, 5279.0, 5435.0, 5253.0, 5631.0, 5286.0, 5503.0, 5250.0, 5454.0, 5587.0, 5683.0, 5271.0, 5668.0, 5682.0, 5354.0, 5460.0, 5592.0, 5258.0, 5409.0, 5475.0, 5456.0, 5690.0, 5313.0, 5567.0, 5270.0, 5512.0, 5642.0, 5709.0, 5641.0, 5537.0, 5457.0, 5318.0, 5622.0, 5291.0, 5461.0, 5540.0, 5565.0, 5280.0, 5488.0, 5548.0, 5614.0, 5436.0, 5628.0, 5679.0, 5474.0, 5558.0, 5589.0, 5364.0, 5260.0, 5601.0, 5393.0, 5416.0, 5299.0, 5404.0, 5713.0, 5553.0, 5267.0, 5604.0 (number of hits: 6)
30	5280	9	1	333	1	5544.0, 5712.0, 5597.0, 5340.0, 5406.0, 5704.0, 5284.0, 5632.0, 5343.0, 5420.0, 5433.0, 5449.0, 5623.0, 5618.0, 5629.0, 5679.0, 5498.0, 5382.0, 5690.0, 5479.0, 5500.0, 5659.0, 5364.0, 5339.0, 5344.0, 5270.0, 5670.0, 5651.0, 5287.0, 5533.0, 5605.0, 5545.0, 5592.0, 5422.0, 5362.0, 5513.0, 5484.0, 5441.0, 5599.0, 5512.0, 5535.0, 5543.0, 5381.0, 5481.0, 5558.0, 5447.0, 5418.0, 5603.0, 5348.0, 5526.0, 5453.0, 5403.0, 5436.0, 5495.0, 5259.0, 5509.0, 5714.0, 5321.0, 5325.0, 5472.0, 5353.0, 5409.0, 5531.0, 5341.0, 5574.0, 5482.0, 5391.0, 5463.0, 5589.0, 5308.0, 5541.0, 5566.0, 5687.0, 5532.0, 5582.0, 5674.0, 5419.0, 5432.0, 5621.0, 5473.0, 5663.0, 5376.0, 5493.0, 5485.0, 5476.0, 5496.0, 5304.0, 5396.0, 5667.0, 5719.0, 5373.0, 5390.0, 5655.0, 5554.0, 5622.0, 5641.0, 5365.0, 5508.0, 5568.0, 5525.0 (number of hits: 3)

**5580 MHz, 20 MHz Bandwidth**

<b>Radar Signal Type</b>	<b>Waveform/Trial Number</b>	<b>Detection (%)</b>	<b>Limit (%)</b>	<b>Pass/Fail</b>
Type 1A/1B	30	100 %	60%	Pass
Type 2	30	100 %	60%	Pass
Type 3	30	100 %	60%	Pass
Type 4	30	100 %	60%	Pass
<b>Aggregate (Type1 to 4)</b>	120	100 %	80%	Pass
Type 5	30	100 %	80%	Pass
Type 6	30	100 %	70%	Pass

Please refer to the following statistical tables:

**Table-1 Radar Type 1A/1B Statistical Performance**

<b>Trial #</b>	<b>Fc (MHz)</b>	<b>Pulse/Burst</b>	<b>Pulse Width (μS)</b>	<b>PRI (μs)</b>	<b>Detection (1:yes; 0:no)</b>
1	5580	18	1	3066	1
2	5580	72	1	738	1
3	5580	68	1	778	1
4	5580	63	1	838	1
5	5580	83	1	638	1
6	5580	67	1	798	1
7	5580	92	1	578	1
8	5580	95	1	558	1
9	5580	99	1	538	1
10	5580	74	1	718	1
11	5580	86	1	618	1
12	5580	102	1	518	1
13	5580	62	1	858	1
14	5580	78	1	678	1
15	5580	81	1	658	1
16	5580	67	1	792	1
17	5580	38	1	1426	1
18	5580	26	1	2042	1
19	5580	23	1	2378	1
20	5580	37	1	1433	1
21	5580	25	1	2164	1
22	5580	63	1	840	1
23	5580	80	1	666	1
24	5580	19	1	2925	1
25	5580	25	1	2125	1
26	5580	18	1	2946	1
27	5580	41	1	1313	1
28	5580	20	1	2650	1
29	5580	39	1	1357	1
30	5580	24	1	2213	1
<b>Detection Percentage: 100 % (&gt;60%)</b>					



**Table-2 Radar Type 2 Statistical Performance**

<b>Trial #</b>	<b>Fc (MHz)</b>	<b>Pulse/Burst</b>	<b>Pulse Width (μS)</b>	<b>PRI (μs)</b>	<b>Detection (1:yes; 0:no)</b>
1	5580	27	1.6	156	1
2	5580	25	3.4	201	1
3	5580	24	1.6	201	1
4	5580	27	4.2	167	1
5	5580	29	1.3	211	1
6	5580	29	4.5	162	1
7	5580	28	2.2	192	1
8	5580	26	3.7	156	1
9	5580	29	3.8	150	1
10	5580	28	4.4	208	1
11	5580	24	2.5	151	1
12	5580	26	1.5	187	1
13	5580	29	4.3	162	1
14	5580	24	4.7	196	1
15	5580	29	4.4	150	1
16	5580	29	3.1	226	1
17	5580	29	1.9	151	1
18	5580	25	3.3	176	1
19	5580	27	1.3	183	1
20	5580	24	2.6	180	1
21	5580	25	4.6	228	1
22	5580	28	2	229	1
23	5580	26	4	186	1
24	5580	25	4.1	189	1
25	5580	29	4.5	168	1
26	5580	28	1.8	229	1
27	5580	27	1.7	172	1
28	5580	27	4.7	169	1
29	5580	26	4.9	179	1
30	5580	29	2.1	216	1
<b>Detection Percentage: 100 % (&gt;60%)</b>					

**Table-3 Radar Type 3 Statistical Performance**

<b>Trial #</b>	<b>Fc (MHz)</b>	<b>Pulse/Burst</b>	<b>Pulse Width (μS)</b>	<b>PRI (μs)</b>	<b>Detection (1:yes; 0:no)</b>
1	5580	18	7.9	235	1
2	5580	16	7.5	456	1
3	5580	18	9.9	435	1
4	5580	18	9.4	235	1
5	5580	18	9.5	353	1
6	5580	16	8.6	471	1
7	5580	17	8.7	418	1
8	5580	16	6.1	280	1
9	5580	16	7.4	445	1
10	5580	17	6.8	391	1
11	5580	18	9.3	240	1
12	5580	17	9.3	364	1
13	5580	17	6	440	1
14	5580	18	8.2	467	1
15	5580	17	6	285	1
16	5580	16	7.8	216	1
17	5580	16	7.5	475	1
18	5580	18	8.6	355	1
19	5580	18	6	342	1
20	5580	16	6.5	490	1
21	5580	18	7.3	393	1
22	5580	17	9.3	359	1
23	5580	17	8.9	400	1
24	5580	18	7.6	423	1
25	5580	18	6.7	442	1
26	5580	16	9.9	250	1
27	5580	17	8.3	409	1
28	5580	17	9.7	467	1
29	5580	18	6.2	385	1
30	5580	16	9.6	235	1
<b>Detection Percentage: 100 % (&gt;60%)</b>					

**Table-4 Radar Type 4 Statistical Performance**

<b>Trial #</b>	<b>Fc (MHz)</b>	<b>Pulse/Burst</b>	<b>Pulse Width (μS)</b>	<b>PRI (μs)</b>	<b>Detection (1:yes; 0:no)</b>
1	5580	16	15.9	484	1
2	5580	16	14.2	467	1
3	5580	14	15.9	346	1
4	5580	15	19.3	243	1
5	5580	15	19.8	348	1
6	5580	12	17.4	414	1
7	5580	16	11	416	1
8	5580	12	17.4	374	1
9	5580	12	19.6	355	1
10	5580	14	11.4	423	1
11	5580	13	20	473	1
12	5580	16	15.9	499	1
13	5580	14	16.8	384	1
14	5580	13	16.2	475	1
15	5580	13	13	400	1
16	5580	15	13.8	375	1
17	5580	14	15.5	449	1
18	5580	14	11.9	431	1
19	5580	12	16.8	320	1
20	5580	14	12.9	455	1
21	5580	13	12.4	418	1
22	5580	12	16.9	316	1
23	5580	15	19.4	220	1
24	5580	14	15.5	320	1
25	5580	15	13.6	226	1
26	5580	15	12.8	498	1
27	5580	16	14	364	1
28	5580	12	15.7	325	1
29	5580	13	16.3	446	1
30	5580	16	16.1	356	1
<b>Detection Percentage: 100 % (&gt;60%)</b>					

**Table-5 Radar Type 5 Statistical Performance**

Bin5 Statistics 1

Trial #	Pulse	Chirp (MHz)	Pulse Width (µS)	Pulse 1-2 spacing (µS)	Pulse 2-3 spacing (µS)	Pulse Start(S)	Detection (1:yes; 0:no)
0	3	18	71.6	1046	1546	0.082835	1
1	2	18	68.6	1065		0.633517	
2	2	19	56.3	1624		1.730519	
3	2	8	63.6	1037		2.457316	
4	3	18	89	1636	1197	2.668492	
5	3	17	77.5	1527	1314	3.308012	
6	2	16	91.7	1300		3.829489	
7	2	12	57.6	1548		4.72566	
8	3	9	97.4	1846	1381	5.443182	
9	1	17	99.6			6.063359	
10	2	10	65.9	1334		6.554405	
11	2	16	86.3	1219		7.441685	
12	2	15	97.3	1942		7.712953	
13	2	19	57.7	1008		8.521639	
14	2	7	76.2	1597		9.21785	
15	2	8	64.9	1360		10.047397	
16	2	6	56.5	1575		10.414459	
17	1	17	81.5			10.858459	
18	2	15	61.5	1046		11.521124	

Bin5 Statistics 2

Trial #	Pulse	Chirp (MHz)	Pulse Width (µS)	Pulse 1-2 spacing (µS)	Pulse 2-3 spacing (µS)	Pulse Start(S)	Detection (1:yes; 0:no)
0	2	10	97.2	1679		0.921458	1
1	2	17	81.5	1734		2.09309	
2	2	14	91.9	1565		3.291972	
3	2	18	97.9	1977		4.432563	
4	2	10	94.9	1385		5.658936	
5	2	19	59.5	1847		6.733296	
6	1	17	100			8.374535	
7	2	19	86.8	1462		9.468386	
8	2	17	80.9	1911		9.921502	
9	1	17	71.6			11.479824	

## Bin5 Statistics 3

Trial #	Pulse	Chirp (MHz)	Pulse Width (μS)	Pulse 1-2 spacing (uS)	Pulse 2-3 spacing (uS)	Pulse Start(S)	Detection (1:yes; 0:no)
0	2	2	16	64.3	1524		1
1	2	2	19	71	1410		
2	3	2	16	95.8	1189		
3	2	2	13	71.4	1468		
4	2	1	9	77.9			
5	2	3	17	74.4	1776	1118	
6	2	1	19	83.8			
7	2	3	9	67.2	1551	1075	
8	3	1	15	79.2			
9	3	1	9	70.5			
10	2	2	14	95.8	1488		
11	1	3	5	53.1	1928	1778	
12	2	3	15	69.8	1490	1820	
13	1	2	7	86.8	1027		
14	2	1	6	80.1			
15	2	2	5	50.5	1871		

## Bin5 Statistics 4

Trial #	Pulse	Chirp (MHz)	Pulse Width (µS)	Pulse 1-2 spacing (uS)	Pulse 2-3 spacing (uS)	Pulse Start(S)	Detection (1:yes; 0:no)
0	2	7	54.7	1367		0.41497	1
1	1	19	59.2			1.13245	
2	3	11	85.8	1004	1499	1.691902	
3	2	14	60.7	1145		2.125555	
4	2	12	82.7	1880		2.433681	
5	2	8	78.6	1224		3.018324	
6	1	7	63.1			3.654383	
7	2	9	83	1432		4.307225	
8	3	5	60.9	1504	1196	4.980883	
9	2	14	90.9	1047		5.879724	
10	1	20	90.4			6.537033	
11	2	19	66.3	1492		6.772474	
12	1	7	97.7			7.739171	
13	2	5	58.4	1921		8.008414	
14	2	13	90	1655		8.915491	
15	2	11	94.7	1776		9.113705	
16	1	6	68.6			10.079644	
17	3	13	99	1590	1329	10.73668	
18	2	6	93.3	1305		11.191634	
19	1	15	74.4			11.664757	

## Bin5 Statistics 5

Trial #	Pulse	Chirp (MHz)	Pulse Width (µS)	Pulse 1-2 spacing (uS)	Pulse 2-3 spacing (uS)	Pulse Start(S)	Detection (1:yes; 0:no)
0	1	6	53.7			0.727819	11
1	2	11	64.9	1883		1.565719	
2	1	13	93.8			2.342233	
3	1	13	94.2			3.078583	
4	2	6	74.2	1183		3.803088	
5	2	14	98.5	1310		4.859174	
6	2	10	78.1	1877		5.646093	
7	2	14	50.4	1904		6.3542	
8	1	17	90.1			6.958394	
9	3	13	85.4	1303	1327	7.71583	
10	3	12	75.1	1418	1319	8.910771	
11	3	11	79.9	1570	1049	10.062887	
12	1	20	66.3			10.798595	
13	2	16	96.1	1296		11.844399	

## Bin5 Statistics 6

Trial #	Pulse	Chirp (MHz)	Pulse Width (µS)	Pulse 1-2 spacing (uS)	Pulse 2-3 spacing (uS)	Pulse Start(S)	Detection (1:yes; 0:no)
0	2	13	62.6	1984		0.17209	1
1	3	16	51.3	1593	1882	1.790124	
2	2	15	91	1436		2.899663	
3	1	16	58.3			3.012517	
4	2	18	72.5	1329		4.315445	
5	2	9	61.2	1398		5.361061	
6	3	14	68	1687	1403	6.439926	
7	2	13	71.5	1864		7.414536	
8	3	7	86.9	1678	1671	8.20252	
9	3	12	74.3	1662	1111	9.015426	
10	2	7	96.9	1531		10.620442	
11	1	7	84.1			11.980191	

## Bin5 Statistics 7

Trial #	Pulse	Chirp (MHz)	Pulse Width (µS)	Pulse 1-2 spacing (uS)	Pulse 2-3 spacing (uS)	Pulse Start(S)	Detection (1:yes; 0:no)
0	2	16	75.6	1312		0.301815	1
1	3	9	96.4	1955	1288	1.690917	
2	1	13	52.8			4.184785	
3	3	6	85.5	1036	1852	5.489925	
4	1	6	92.1			6.861298	
5	1	13	74			7.704021	
6	2	13	62.7	1802		9.919841	
7	2	8	54.2	1837		10.552993	

## Bin5 Statistics 8

Trial #	Pulse	Chirp (MHz)	Pulse Width (µS)	Pulse 1-2 spacing (uS)	Pulse 2-3 spacing (uS)	Pulse Start(S)	Detection (1:yes; 0:no)
0	3	19	51.9	1566	1548	0.933537	1
1	3	14	63.5	1909	1825	1.552029	
2	2	9	55.6	1786		2.855362	
3	2	15	53.6	1921		3.660344	
4	3	17	62.3	1858	1477	5.72646	
5	3	18	58	1599	1142	6.994446	
6	3	6	76.9	1674	1774	8.271485	
7	3	7	53.4	1293	1319	8.892646	
8	2	18	75.8	1142		10.248701	
9	2	10	99.8	1696		11.333614	

## Bin5 Statistics 9

Trial #	Pulse	Chirp (MHz)	Pulse Width (µS)	Pulse 1-2 spacing (uS)	Pulse 2-3 spacing (uS)	Pulse Start(S)	Detection (1:yes; 0:no)
0	2	18	89.2	1238		0.493328	1
1	3	8	84.4	1160	1406	0.790182	
2	3	20	88.7	1902	1583	1.501868	
3	3	15	70.7	1709	1947	2.484277	
4	2	6	85.4	1131		3.097725	
5	2	9	96.6	1804		4.472464	
6	1	7	86.9			4.52673	
7	3	17	81.2	1257	1130	5.428508	
8	3	17	75.5	1451	1024	6.276037	
9	2	14	75.9	1241		7.112258	
10	1	11	55.5			8.016485	
11	2	12	71.5	1847		8.363039	
12	2	5	50.5	1031		9.045148	
13	2	11	54.8	1952		10.34221	
14	1	20	87.1			10.611912	
15	3	14	91.6	1398	1895	11.717583	



## Bin5 Statistics 10

Trial #	Pulse	Chirp (MHz)	Pulse Width (µS)	Pulse 1-2 spacing (uS)	Pulse 2-3 spacing (uS)	Pulse Start(S)	Detection (1:yes; 0:no)
0	3	17	68.6	1267	1029	0.294763	1
1	2	14	72.3	1965		1.623127	
2	2	6	60.1	1164		2.380436	
3	2	6	50.6	1726		3.388834	
4	2	13	88.4	1601		5.110517	
5	2	8	54.3	1030		5.788397	
6	2	7	94.1	1438		7.03259	
7	3	13	64.2	1147	1353	7.869933	
8	3	19	63	1412	1883	9.36479	
9	2	18	71	1214		10.581272	
10	3	6	69.2	1634	1880	11.541262	

## Bin5 Statistics 11

Trial #	Pulse	Chirp (MHz)	Pulse Width (µS)	Pulse 1-2 spacing (uS)	Pulse 2-3 spacing (uS)	Pulse Start(S)	Detection (1:yes; 0:no)
0	2	11	85.8	1787		0.906674	1
1	1	5	83.7			1.517159	
2	3	17	76.5	1583	1902	2.724548	
3	1	7	94.7			2.874427	
4	2	16	85	1627		3.695644	
5	3	9	85.5	1413	1597	5.248689	
6	3	13	76	1895	1624	5.701533	
7	2	16	73	1603		7.022356	
8	2	7	67.5	1200		7.567818	
9	3	11	98.1	1969	1541	9.028554	
10	2	16	93.2	1434		9.691261	
11	1	12	82.6			10.603106	
12	2	15	53.1	1537		11.18495	

## Bin5 Statistics 12

Trial #	Pulse	Chirp (MHz)	Pulse Width (µS)	Pulse 1-2 spacing (uS)	Pulse 2-3 spacing (uS)	Pulse Start(S)	Detection (1:yes; 0:no)
0	3	19	83.1	1140	1673	0.175949	1
1	1	13	55.6			1.04209	
2	3	11	75	1468	1181	1.812401	
3	3	5	52.8	1756	1670	2.700614	
4	1	18	83.1			3.88809	
5	2	5	60.9	1695		4.363321	
6	2	15	91.3	1618		5.21008	
7	2	8	54.9	1323		6.153747	
8	2	7	55.3	1759		7.451544	
9	1	7	60.8			8.249704	
10	2	10	84.5	1850		8.981505	
11	2	11	77.1	1676		10.206231	
12	3	9	68.1	1772	1213	10.778008	
13	2	5	54.4	1029		11.489808	

## Bin5 Statistics 13

Trial #	Pulse	Chirp (MHz)	Pulse Width (µS)	Pulse 1-2 spacing (uS)	Pulse 2-3 spacing (uS)	Pulse Start(S)	Detection (1:yes; 0:no)
0	3	6	93.6	1317	1459	0.296794	1
1	1	16	99.5			0.749215	
2	2	10	62.7	1519		1.237389	
3	3	14	81.4	1926	1483	2.121708	
4	1	15	65.5			2.898492	
5	2	14	79.5	1913		3.565896	
6	3	20	70.8	1377	1363	3.78595	
7	1	18	85.4			4.348332	
8	1	13	92.8			5.374959	
9	2	8	75.4	1235		5.59578	
10	1	6	99.2			6.552571	
11	2	18	98.4	1860		7.010014	
12	1	7	56.8			7.714069	
13	2	12	65.3	1448		8.382924	
14	3	16	65.3	1917	1811	8.75912	
15	1	11	82.9			9.57106	
16	1	16	78			10.036378	
17	2	16	99.2	1801		10.738712	
18	3	11	56	1032	1001	10.852713	
19	1	18	94.8			11.514556	

## Bin5 Statistics 14

Trial #	Pulse	Chirp (MHz)	Pulse Width (µS)	Pulse 1-2 spacing (uS)	Pulse 2-3 spacing (uS)	Pulse Start(S)	Detection (1:yes; 0:no)
0	2	10	96.1	1253		0.169361	0
1	1	20	82.8			1.9003	
2	2	12	99.3	1817		3.869075	
3	1	19	71.9			5.118027	
4	2	13	80.5	1210		6.30255	
5	1	18	79.8			7.59455	
6	1	15	86.9			9.180555	
7	2	8	89	1770		9.782378	
8	2	12	57.4	1128		11.936908	

## Bin5 Statistics 15

Trial #	Pulse	Chirp (MHz)	Pulse Width (µS)	Pulse 1-2 spacing (uS)	Pulse 2-3 spacing (uS)	Pulse Start(S)	Detection (1:yes; 0:no)
0	1	15	54.1			0.01742	1
1	1	18	81.6			1.644079	
2	2	6	93.9	1111		3.280214	
3	1	10	90.5			3.608732	
4	2	10	98.3	1987		5.674195	
5	2	18	81	1056		6.061121	
6	1	12	71.5			7.942414	
7	2	10	98.6	1636		8.45402	
8	2	11	50.2	1741		10.384271	
9	3	9	71.2	1908	1345	11.006778	

## Bin5 Statistics 16

Trial #	Pulse	Chirp (MHz)	Pulse Width (µS)	Pulse 1-2 spacing (uS)	Pulse 2-3 spacing (uS)	Pulse Start(S)	Detection (1:yes; 0:no)
0	2	15	58.3	1458		0.032479	1
1	1	6	80.5			1.187276	
2	2	12	60.9	1897		2.556068	
3	3	17	78.3	1669	1314	2.86508	
4	2	12	77.4	1344		4.062419	
5	2	8	87.7	1123		5.239256	
6	1	7	80.6			5.817504	
7	2	16	78.5	1192		7.012404	
8	2	15	90.9	1169		8.229061	
9	3	12	83.6	1926	1590	8.820045	
10	2	17	83.4	1998		10.001773	
11	1	5	56.3			10.673605	
12	1	9	76			11.612879	

## Bin5 Statistics 17

Trial #	Pulse	Chirp (MHz)	Pulse Width (µS)	Pulse 1-2 spacing (uS)	Pulse 2-3 spacing (uS)	Pulse Start(S)	Detection (1:yes; 0:no)
0	2	9	82	1821		0.796403	1
1	3	17	83.1	1907	1684	1.928378	
2	1	15	52.8			2.450597	
3	2	20	80.2	1509		3.593144	
4	2	13	78.1	1933		4.496824	
5	1	11	75			5.166096	
6	3	9	69.6	1970	1065	6.444186	
7	3	15	70.4	1656	1276	7.831849	
8	1	12	98.1			8.462963	
9	2	19	87	1818		9.438255	
10	2	7	62.2	1275		10.735216	
11	1	6	96.8			11.900625	

## Bin5 Statistics 18

Trial #	Pulse	Chirp (MHz)	Pulse Width (µS)	Pulse 1-2 spacing (uS)	Pulse 2-3 spacing (uS)	Pulse Start(S)	Detection (1:yes; 0:no)
0	1	13	62.3			0.439918	1
1	2	18	79.5	1282		0.878344	
2	2	14	92.8	1741		1.460131	
3	2	8	66.6	1100		2.769867	
4	2	12	57.6	1384		3.387713	
5	2	10	55.6	1757		4.183973	
6	3	17	66.5	1684	1478	4.727126	
7	2	6	61.6	1605		5.544334	
8	2	10	98.4	1988		5.717037	
9	2	9	98.8	1294		6.623528	
10	2	7	55.4	1063		7.375824	
11	2	18	82.4	1130		8.166165	
12	2	10	81.5	1499		8.478785	
13	3	19	66.2	1729	1927	9.80395	
14	3	18	78.7	1121	1465	10.574321	
15	2	16	96	1673		11.027099	
16	2	14	55.5	1654		11.70227	

## Bin5 Statistics 19

Trial #	Pulse	Chirp (MHz)	Pulse Width (µS)	Pulse 1-2 spacing (uS)	Pulse 2-3 spacing (uS)	Pulse Start(S)	Detection (1:yes; 0:no)
0	2	17	87.1	1939		0.758715	1
1	1	6	53.2			1.230297	
2	3	11	67.6	1398	1490	2.777662	
3	1	11	90.6			4.351431	
4	1	9	59.3			5.613067	
5	1	7	87.5			7.08845	
6	2	15	65	1645		7.500298	
7	1	19	69.7			9.204497	
8	3	9	85.4	1996	1992	9.601224	
9	2	11	77.1	1711		11.217393	

## Bin5 Statistics 20

Trial #	Pulse	Chirp (MHz)	Pulse Width (µS)	Pulse 1-2 spacing (uS)	Pulse 2-3 spacing (uS)	Pulse Start(S)	Detection (1:yes; 0:no)
0	2	8	87.4	1108		0.704367	1
1	3	6	87	1543	1944	1.485263	
2	2	11	86.1	1506		2.448633	
3	2	13	74.9	1918		3.263606	
4	1	11	67.4			3.799025	
5	2	19	56.3	1497		5.509863	
6	2	12	92.9	1247		5.783578	
7	2	13	51.8	1891		7.345782	
8	3	17	79.5	1299	1882	8.13712	
9	3	6	50.6	1565	1572	8.706154	
10	3	8	91.8	1641	1170	9.671245	
11	2	18	62.6	1915		10.779259	
12	2	15	81.9	1463		11.300367	

## Bin5 Statistics 21

Trial #	Pulse	Chirp (MHz)	Pulse Width (µS)	Pulse 1-2 spacing (uS)	Pulse 2-3 spacing (uS)	Pulse Start(S)	Detection (1:yes; 0:no)
0	1	6	83.3			0.192596	1
1	1	7	63.3			0.716135	
2	2	13	87.1	1500		1.974754	
3	3	17	85.4	1822	1796	2.635283	
4	2	9	59.3	1893		2.727034	
5	1	17	89.2			3.585559	
6	1	10	59.9			4.43649	
7	2	7	75.1	1029		4.949451	
8	3	12	76.5	1041	1137	5.852332	
9	1	6	82.1			6.356591	
10	2	8	73.8	1945		7.265639	
11	1	17	74.8			7.835382	
12	3	19	69.6	1177	1186	8.298887	
13	2	14	56.5	1077		8.870736	
14	1	15	58.4			9.510535	
15	3	19	56	1282	1534	10.598823	
16	1	11	78.7			10.901956	
17	2	15	71.9	1715		11.345806	

## Bin5 Statistics 22

Trial #	Pulse	Chirp (MHz)	Pulse Width (µS)	Pulse 1-2 spacing (uS)	Pulse 2-3 spacing (uS)	Pulse Start(S)	Detection (1:yes; 0:no)
0	3	20	67.9	1622	1358	0.191501	1
1	2	10	64.9	1520		0.97791	
2	1	10	70.4			2.559382	
3	2	13	65.8	1582		2.891393	
4	3	18	75.6	1906	1978	3.801132	
5	1	10	78.7			5.058978	
6	1	14	92.2			5.213554	
7	1	5	82.1			6.090344	
8	2	11	52.6	1280		7.290131	
9	2	14	55.6	1216		8.026129	
10	1	10	64.8			8.852168	
11	3	10	58.2	1346	1494	9.972465	
12	3	9	60.9	1713	1962	10.732095	
13	1	5	64.6			11.961628	

## Bin5 Statistics 23

Trial #	Pulse	Chirp (MHz)	Pulse Width (µS)	Pulse 1-2 spacing (uS)	Pulse 2-3 spacing (uS)	Pulse Start(S)	Detection (1:yes; 0:no)
0	3	12	54.1	1153	1837	0.033512	1
1	2	14	92.3	1832		1.092723	
2	3	17	72.1	1957	1772	2.091472	
3	2	10	83.8	1984		2.22439	
4	2	6	88.7	1546		2.904975	
5	3	19	82.3	1641	1961	4.118529	
6	2	10	81.1	1662		4.555531	
7	1	9	85.9			5.481168	
8	1	12	84.8			6.189344	
9	1	12	70.6			6.620195	
10	2	17	95.9	1603		7.255321	
11	3	7	97.2	1119	1373	8.186272	
12	1	16	98.3			9.107021	
13	3	10	77.6	1387	1797	9.547433	
14	3	13	55.4	1682	1444	10.043779	
15	2	12	77.2	1168		11.209405	
16	3	12	85.6	1043	1538	11.894252	

## Bin5 Statistics 24

Trial #	Pulse	Chirp (MHz)	Pulse Width (µS)	Pulse 1-2 spacing (uS)	Pulse 2-3 spacing (uS)	Pulse Start(S)	Detection (1:yes; 0:no)
0	3	6	96.9	1908	1654	0.309811	1
1	2	14	50.7	1970		1.056706	
2	2	18	50	1353		2.042117	
3	1	11	51.6			2.571496	
4	2	5	66.3	1465		3.176301	
5	2	12	89.3	1309		3.83667	
6	2	19	80.4	1668		4.623514	
7	2	16	64.5	1674		5.565688	
8	1	15	62.1			6.086511	
9	3	15	99.3	1642	1255	6.939854	
10	1	15	55.6			7.626165	
11	3	14	83.1	1176	1205	7.847845	
12	3	11	64.7	1399	1695	8.955377	
13	1	10	76.8			9.392514	
14	2	18	56.1	1572		10.039852	
15	3	11	75	1297	1677	10.634239	
16	3	17	86.4	1579	1814	11.463904	

## Bin5 Statistics 25

Trial #	Pulse	Chirp (MHz)	Pulse Width (µS)	Pulse 1-2 spacing (uS)	Pulse 2-3 spacing (uS)	Pulse Start(S)	Detection (1:yes; 0:no)
0	3	6	85	1479	1820	0.279711	1
1	2	7	62.8	1217		1.288454	
2	2	17	86.7	1972		2.659258	
3	2	5	76.3	1441		2.951984	
4	2	19	86.5	1248		3.839396	
5	3	19	94.5	1044	1224	5.126448	
6	2	5	89.5	1362		6.424367	
7	2	10	51.8	1122		7.357364	
8	2	10	67.5	1497		7.941685	
9	2	10	68.7	1571		9.205111	
10	2	11	95.7	1392		9.747868	
11	2	19	71.7	1383		10.799138	
12	2	18	50.9	1223		11.570094	



## Bin5 Statistics 26

Trial #	Pulse	Chirp (MHz)	Pulse Width (µS)	Pulse 1-2 spacing (uS)	Pulse 2-3 spacing (uS)	Pulse Start(S)	Detection (1:yes; 0:no)
0	2	8	88.1	1705		0.299729	1
1	1	16	73.2			1.051832	
2	2	18	63.9	1804		1.919846	
3	2	13	54.7	1939		2.019125	
4	2	6	62.3	1831		3.165581	
5	1	10	86.5			3.61485	
6	2	16	72.1	1655		4.117447	
7	3	6	75.7	1579	1525	4.747697	
8	2	12	62.5	1434		5.464671	
9	3	6	93.9	1267	1240	6.080331	
10	1	18	73.1			7.106282	
11	2	17	79.6	1253		7.502288	
12	3	12	69.1	1976	1029	8.337082	
13	2	15	55.7	1065		9.248365	
14	3	14	51.2	1228	1640	9.869216	
15	3	9	74.6	1821	1846	10.112707	
16	2	7	93.4	1458		10.875672	
17	2	10	89.1	1013		11.517589	

## Bin5 Statistics 27

Trial #	Pulse	Chirp (MHz)	Pulse Width (µS)	Pulse 1-2 spacing (uS)	Pulse 2-3 spacing (uS)	Pulse Start(S)	Detection (1:yes; 0:no)
0	2	8	54.9	1074		0.490795	1
1	2	11	61.2	1255		1.826671	
2	2	13	52.3	1891		2.372631	
3	3	14	61.6	1361	1325	3.410961	
4	2	6	84.5	1987		4.451558	
5	2	19	61.1	1183		4.908533	
6	1	16	55.7			6.163074	
7	1	18	72.6			6.938497	
8	3	13	73.5	1121	1986	8.207691	
9	2	9	51	1523		8.93598	
10	1	8	88.6			9.874344	
11	2	10	87.9	1577		10.428594	
12	2	11	54.8	1773		11.965229	

## Bin5 Statistics 28

Trial #	Pulse	Chirp (MHz)	Pulse Width (µS)	Pulse 1-2 spacing (uS)	Pulse 2-3 spacing (uS)	Pulse Start(S)	Detection (1:yes; 0:no)
0	1	13	57.4			0.421503	1
1	1	13	86.4			1.151242	
2	3	9	97.2	1156	1194	2.070951	
3	2	12	77.5	1645		2.764428	
4	2	15	94.4	1997		3.219614	
5	2	5	76.1	1355		4.339291	
6	2	14	85.7	1234		5.027857	
7	3	8	56	1768	1427	6.069455	
8	2	9	69.2	1564		6.762195	
9	2	14	67	1407		7.401898	
10	2	10	83.2	1662		8.438181	
11	2	6	56	1613		9.029927	
12	1	11	64			9.922479	
13	1	19	98.7			10.776733	
14	3	8	65.1	1449	1474	11.204763	

## Bin5 Statistics 29

Trial #	Pulse	Chirp (MHz)	Pulse Width (µS)	Pulse 1-2 spacing (uS)	Pulse 2-3 spacing (uS)	Pulse Start(S)	Detection (1:yes; 0:no)
0	1	11	71.1			0.010658	1
1	3	9	63.2	1509	1378	1.208387	
2	2	6	57.9	1015		1.864591	
3	2	14	62.3	1591		2.588198	
4	3	6	93	1865	1253	2.747386	
5	2	15	88.5	1504		3.58974	
6	3	9	97.5	1093	1569	4.648075	
7	1	11	99.1			5.240506	
8	2	14	70.7	1312		5.426769	
9	3	19	54.2	1556	1046	6.045823	
10	2	15	64.7	1799		6.864128	
11	2	14	65.4	1351		7.668874	
12	2	15	69.4	1778		8.637733	
13	1	17	92.9			9.302141	
14	2	19	51.7	1368		9.380126	
15	2	16	90.2	1682		10.441472	
16	3	9	90.6	1985	1185	10.951372	
17	1	7	86.2			11.634579	

## Bin5 Statistics 30

Trial #	Pulse	Chirp (MHz)	Pulse Width (µS)	Pulse 1-2 spacing (µS)	Pulse 2-3 spacing (µS)	Pulse Start(S)	Detection (1:yes; 0:no)
0	2	8	67.9	1338		0.043945	1
1	1	15	86.7			1.155003	
2	2	13	66.9	1020		2.1061	
3	2	17	88.3	1466		2.969751	
4	2	12	74.3	1117		3.274717	
5	1	19	96.8			4.374605	
6	1	19	52.4			5.034061	
7	1	13	72.3			5.505393	
8	1	11	56.8			6.494839	
9	2	18	70.8	1916		7.256841	
10	2	12	88.7	1547		8.038075	
11	3	19	95.6	1734	1741	8.591892	
12	3	9	67.7	1554	1231	9.352962	
13	2	14	57.1	1420		9.888142	
14	2	6	81.9	1050		11.160686	
15	1	10	95.7			11.330579	

**Table-6 Radar Type 6 Statistical Performance**

Trial #	Fc (MHz)	Pulse /Burst	Pulse Width (µS)	PRI (µs)	Detection (1:yes; 0:no)	Hopping Sequence
1	5580	9	1	333	1	5419.0, 5706.0, 5660.0, 5294.0, 5641.0, 5274.0, 5711.0, 5429.0, 5364.0, 5714.0, 5433.0, 5352.0, 5627.0, 5380.0, 5584.0, 5270.0, 5608.0, 5284.0, 5557.0, 5721.0, 5392.0, 5669.0, 5420.0, 5363.0, 5495.0, 5458.0, 5703.0, 5466.0, 5315.0, 5722.0, 5642.0, 5470.0, 5367.0, 5564.0, 5595.0, 5251.0, 5554.0, 5704.0, 5317.0, 5693.0, 5525.0, 5291.0, 5629.0, 5259.0, 5446.0, 5661.0, 5460.0, 5269.0, 5440.0, 5366.0, 5358.0, 5338.0, 5454.0, 5623.0, 5601.0, 5401.0, 5472.0, 5337.0, 5389.0, 5271.0, 5426.0, 5267.0, 5680.0, 5561.0, 5543.0, 5407.0, 5353.0, 5491.0, 5293.0, 5555.0, 5350.0, 5369.0, 5462.0, 5430.0, 5590.0, 5576.0, 5384.0, 5597.0, 5482.0, 5606.0, 5476.0, 5377.0, 5619.0, 5490.0, 5688.0, 5519.0, 5400.0, 5575.0, 5602.0, 5610.0, 5723.0, 5263.0, 5477.0, 5644.0, 5343.0, 5671.0, 5715.0, 5481.0, 5708.0, 5616.0 (number of hits: 9)
2	5580	9	1	333	1	5458.0, 5571.0, 5487.0, 5707.0, 5297.0, 5410.0, 5353.0, 5485.0, 5459.0, 5445.0, 5643.0, 5698.0, 5275.0, 5708.0, 5476.0, 5716.0, 5480.0, 5454.0, 5703.0, 5587.0, 5468.0, 5510.0, 5294.0, 5515.0, 5421.0, 5650.0, 5373.0, 5531.0, 5512.0, 5641.0, 5298.0, 5668.0, 5414.0, 5481.0, 5442.0, 5578.0, 5402.0, 5366.0, 5682.0, 5474.0, 5702.0, 5683.0, 5323.0, 5623.0, 5519.0, 5629.0, 5655.0, 5441.0, 5638.0, 5579.0, 5580.0, 5558.0, 5583.0, 5528.0, 5321.0, 5721.0, 5720.0, 5581.0, 5270.0, 5456.0, 5557.0, 5344.0, 5653.0, 5330.0, 5304.0, 5484.0, 5283.0, 5561.0, 5472.0, 5273.0, 5315.0, 5368.0, 5429.0, 5374.0, 5385.0, 5551.0, 5272.0, 5431.0, 5260.0, 5403.0, 5449.0, 5465.0, 5613.0, 5436.0, 5391.0, 5477.0, 5609.0, 5596.0, 5666.0, 5626.0, 5514.0, 5450.0, 5470.0, 5395.0, 5677.0, 5710.0, 5305.0, 5652.0, 5276.0, 5435.0 (number of hits: 7)
3	5580	9	1	333	1	5504.0, 5582.0, 5630.0, 5653.0, 5517.0, 5713.0, 5467.0, 5309.0, 5384.0, 5498.0, 5417.0, 5347.0, 5388.0, 5647.0, 5251.0, 5559.0, 5387.0, 5701.0, 5523.0, 5508.0, 5294.0, 5393.0, 5708.0, 5329.0, 5469.0, 5686.0, 5398.0, 5661.0, 5351.0, 5298.0, 5273.0, 5434.0, 5716.0, 5296.0, 5472.0, 5331.0, 5676.0, 5595.0, 5622.0, 5267.0, 5581.0, 5668.0, 5699.0, 5306.0, 5617.0, 5574.0, 5373.0, 5621.0, 5375.0, 5535.0, 5500.0, 5330.0, 5343.0, 5493.0, 5562.0, 5612.0, 5444.0, 5252.0, 5497.0, 5344.0,

						5420.0, 5421.0, 5439.0, 5360.0, 5688.0, 5556.0, 5520.0, 5293.0, 5277.0, 5705.0, 5270.0, 5722.0, 5310.0, 5524.0, 5568.0, 5502.0, 5652.0, 5301.0, 5689.0, 5263.0, 5495.0, 5465.0, 5436.0, 5404.0, 5454.0, 5594.0, 5723.0, 5700.0, 5326.0, 5481.0, 5487.0, 5478.0, 5352.0, 5491.0, 5718.0, 5626.0, 5709.0, 5717.0, 5337.0, 5475.0 (number of hits: 7)
4	5580	9	1	333	1	5273.0, 5674.0, 5413.0, 5323.0, 5420.0, 5476.0, 5509.0, 5287.0, 5389.0, 5555.0, 5593.0, 5512.0, 5500.0, 5345.0, 5651.0, 5720.0, 5513.0, 5639.0, 5678.0, 5647.0, 5641.0, 5295.0, 5255.0, 5281.0, 5623.0, 5291.0, 5497.0, 5575.0, 5455.0, 5675.0, 5702.0, 5251.0, 5627.0, 5570.0, 5407.0, 5596.0, 5448.0, 5468.0, 5432.0, 5367.0, 5370.0, 5315.0, 5403.0, 5723.0, 5377.0, 5612.0, 5465.0, 5292.0, 5469.0, 5672.0, 5380.0, 5416.0, 5622.0, 5707.0, 5511.0, 5516.0, 5392.0, 5560.0, 5348.0, 5598.0, 5538.0, 5388.0, 5462.0, 5637.0, 5617.0, 5313.0, 5566.0, 5606.0, 5452.0, 5439.0, 5429.0, 5588.0, 5398.0, 5664.0, 5409.0, 5517.0, 5362.0, 5505.0, 5374.0, 5496.0, 5268.0, 5265.0, 5434.0, 5711.0, 5296.0, 5329.0, 5692.0, 5621.0, 5673.0, 5587.0, 5539.0, 5585.0, 5342.0, 5618.0, 5522.0, 5514.0, 5338.0, 5533.0, 5317.0, 5427.0 (number of hits: 7)
5	5580	9	1	333	1	5721.0, 5723.0, 5456.0, 5467.0, 5547.0, 5688.0, 5418.0, 5627.0, 5587.0, 5279.0, 5616.0, 5500.0, 5357.0, 5395.0, 5371.0, 5526.0, 5410.0, 5419.0, 5634.0, 5549.0, 5508.0, 5420.0, 5268.0, 5416.0, 5302.0, 5426.0, 5435.0, 5446.0, 5424.0, 5355.0, 5282.0, 5574.0, 5566.0, 5343.0, 5506.0, 5365.0, 5596.0, 5626.0, 5304.0, 5637.0, 5572.0, 5393.0, 5265.0, 5258.0, 5336.0, 5436.0, 5485.0, 5345.0, 5496.0, 5313.0, 5577.0, 5512.0, 5423.0, 5551.0, 5429.0, 5253.0, 5294.0, 5478.0, 5372.0, 5291.0, 5630.0, 5495.0, 5444.0, 5408.0, 5504.0, 5636.0, 5397.0, 5319.0, 5287.0, 5584.0, 5488.0, 5702.0, 5687.0, 5522.0, 5337.0, 5315.0, 5404.0, 5703.0, 5267.0, 5580.0, 5622.0, 5528.0, 5523.0, 5617.0, 5544.0, 5649.0, 5708.0, 5555.0, 5452.0, 5475.0, 5581.0, 5378.0, 5272.0, 5396.0, 5349.0, 5259.0, 5437.0, 5689.0, 5516.0, 5657.0 (number of hits: 10)
6	5580	9	1	333	1	5604.0, 5544.0, 5338.0, 5559.0, 5423.0, 5353.0, 5354.0, 5342.0, 5551.0, 5509.0, 5476.0, 5537.0, 5309.0, 5634.0, 5391.0, 5622.0, 5361.0, 5583.0, 5512.0, 5580.0, 5334.0, 5278.0, 5495.0, 5626.0, 5708.0, 5504.0, 5415.0, 5625.0, 5450.0, 5398.0, 5526.0, 5365.0, 5260.0, 5517.0, 5407.0, 5541.0, 5641.0, 5691.0, 5408.0, 5427.0

						5265.0, 5652.0, 5704.0, 5287.0, 5520.0, 5273.0, 5337.0, 5623.0, 5405.0, 5301.0, 5333.0, 5388.0, 5304.0, 5305.0, 5722.0, 5485.0, 5553.0, 5665.0, 5639.0, 5414.0, 5269.0, 5394.0, 5322.0, 5655.0, 5587.0, 5690.0, 5682.0, 5592.0, 5448.0, 5663.0, 5336.0, 5630.0, 5717.0, 5376.0, 5502.0, 5314.0, 5457.0, 5670.0, 5456.0, 5298.0, 5702.0, 5480.0, 5326.0, 5390.0, 5446.0, 5451.0, 5518.0, 5577.0, 5371.0, 5259.0, 5493.0, 5440.0, 5515.0, 5268.0, 5274.0, 5345.0, 5566.0, 5615.0, 5706.0, 5560.0 (number of hits: 9)
7	5580	9	1	333	1	5265.0, 5516.0, 5608.0, 5466.0, 5686.0, 5577.0, 5292.0, 5405.0, 5545.0, 5550.0, 5537.0, 5335.0, 5486.0, 5379.0, 5639.0, 5426.0, 5269.0, 5346.0, 5635.0, 5274.0, 5331.0, 5582.0, 5533.0, 5457.0, 5647.0, 5627.0, 5605.0, 5334.0, 5476.0, 5465.0, 5706.0, 5401.0, 5271.0, 5272.0, 5277.0, 5585.0, 5337.0, 5275.0, 5573.0, 5359.0, 5603.0, 5513.0, 5394.0, 5360.0, 5591.0, 5697.0, 5719.0, 5553.0, 5460.0, 5343.0, 5390.0, 5564.0, 5395.0, 5643.0, 5640.0, 5376.0, 5409.0, 5389.0, 5497.0, 5407.0, 5295.0, 5446.0, 5362.0, 5278.0, 5569.0, 5253.0, 5358.0, 5698.0, 5722.0, 5344.0, 5534.0, 5371.0, 5420.0, 5442.0, 5561.0, 5423.0, 5546.0, 5388.0, 5264.0, 5663.0, 5408.0, 5259.0, 5258.0, 5438.0, 5266.0, 5566.0, 5443.0, 5517.0, 5370.0, 5515.0, 5291.0, 5597.0, 5709.0, 5308.0, 5683.0, 5617.0, 5263.0, 5700.0, 5583.0, 5372.0 (number of hits: 4)
8	5580	9	1	333	1	5369.0, 5432.0, 5251.0, 5374.0, 5301.0, 5344.0, 5702.0, 5373.0, 5720.0, 5587.0, 5337.0, 5417.0, 5637.0, 5558.0, 5572.0, 5575.0, 5250.0, 5511.0, 5307.0, 5435.0, 5714.0, 5299.0, 5399.0, 5426.0, 5379.0, 5516.0, 5415.0, 5433.0, 5604.0, 5685.0, 5643.0, 5551.0, 5578.0, 5411.0, 5512.0, 5391.0, 5408.0, 5703.0, 5574.0, 5280.0, 5451.0, 5659.0, 5580.0, 5641.0, 5498.0, 5297.0, 5706.0, 5634.0, 5409.0, 5582.0, 5544.0, 5424.0, 5490.0, 5629.0, 5422.0, 5474.0, 5722.0, 5536.0, 5453.0, 5276.0, 5259.0, 5362.0, 5437.0, 5472.0, 5421.0, 5397.0, 5617.0, 5625.0, 5485.0, 5639.0, 5502.0, 5678.0, 5372.0, 5461.0, 5447.0, 5561.0, 5571.0, 5547.0, 5304.0, 5281.0, 5673.0, 5352.0, 5530.0, 5471.0, 5287.0, 5657.0, 5670.0, 5681.0, 5262.0, 5268.0, 5389.0, 5598.0, 5442.0, 5266.0, 5477.0, 5294.0, 5649.0, 5505.0, 5622.0, 5423.0 (number of hits: 10)
9	5580	9	1	333	1	5466.0, 5313.0, 5278.0, 5449.0, 5285.0, 5387.0, 5721.0, 5603.0, 5439.0, 5482.0, 5299.0, 5392.0, 5645.0, 5509.0, 5254.0, 5442.0, 5700.0, 5569.0, 5357.0, 5444.0,

						5698.0, 5478.0, 5576.0, 5675.0, 5669.0, 5557.0, 5621.0, 5691.0, 5521.0, 5385.0, 5470.0, 5327.0, 5457.0, 5718.0, 5543.0, 5364.0, 5448.0, 5629.0, 5528.0, 5368.0, 5485.0, 5626.0, 5541.0, 5655.0, 5659.0, 5402.0, 5390.0, 5398.0, 5582.0, 5561.0, 5433.0, 5527.0, 5665.0, 5491.0, 5318.0, 5467.0, 5623.0, 5423.0, 5657.0, 5468.0, 5710.0, 5636.0, 5422.0, 5382.0, 5371.0, 5554.0, 5414.0, 5475.0, 5381.0, 5297.0, 5624.0, 5367.0, 5535.0, 5251.0, 5571.0, 5496.0, 5695.0, 5556.0, 5426.0, 5342.0, 5524.0, 5408.0, 5702.0, 5632.0, 5484.0, 5321.0, 5518.0, 5450.0, 5477.0, 5697.0, 5284.0, 5723.0, 5463.0, 5644.0, 5300.0, 5630.0, 5348.0, 5473.0, 5354.0, 5519.0 (number of hits: 5)
10	5580	9	1	333	1	5488.0, 5543.0, 5301.0, 5475.0, 5606.0, 5380.0, 5549.0, 5375.0, 5335.0, 5629.0, 5324.0, 5580.0, 5328.0, 5634.0, 5323.0, 5473.0, 5688.0, 5596.0, 5262.0, 5556.0, 5420.0, 5497.0, 5404.0, 5418.0, 5667.0, 5704.0, 5373.0, 5718.0, 5632.0, 5349.0, 5585.0, 5683.0, 5524.0, 5431.0, 5680.0, 5479.0, 5593.0, 5476.0, 5416.0, 5289.0, 5426.0, 5548.0, 5692.0, 5347.0, 5432.0, 5659.0, 5512.0, 5662.0, 5348.0, 5529.0, 5450.0, 5699.0, 5434.0, 5676.0, 5552.0, 5657.0, 5346.0, 5449.0, 5270.0, 5620.0, 5642.0, 5605.0, 5581.0, 5391.0, 5590.0, 5617.0, 5592.0, 5663.0, 5377.0, 5290.0, 5363.0, 5365.0, 5661.0, 5339.0, 5653.0, 5424.0, 5383.0, 5568.0, 5586.0, 5343.0, 5515.0, 5474.0, 5351.0, 5713.0, 5454.0, 5367.0, 5457.0, 5714.0, 5650.0, 5694.0, 5319.0, 5555.0, 5668.0, 5268.0, 5571.0, 5447.0, 5493.0, 5569.0, 5525.0, 5685.0 (number of hits: 4)
11	5580	9	1	333	1	5321.0, 5297.0, 5382.0, 5613.0, 5412.0, 5303.0, 5505.0, 5430.0, 5400.0, 5353.0, 5307.0, 5492.0, 5649.0, 5626.0, 5391.0, 5324.0, 5455.0, 5595.0, 5494.0, 5312.0, 5597.0, 5406.0, 5438.0, 5643.0, 5369.0, 5621.0, 5668.0, 5713.0, 5273.0, 5644.0, 5700.0, 5256.0, 5691.0, 5589.0, 5714.0, 5611.0, 5380.0, 5450.0, 5509.0, 5265.0, 5517.0, 5360.0, 5351.0, 5423.0, 5389.0, 5711.0, 5484.0, 5308.0, 5315.0, 5331.0, 5706.0, 5260.0, 5697.0, 5419.0, 5314.0, 5551.0, 5426.0, 5501.0, 5630.0, 5543.0, 5405.0, 5468.0, 5502.0, 5698.0, 5449.0, 5504.0, 5496.0, 5678.0, 5402.0, 5276.0, 5645.0, 5666.0, 5433.0, 5488.0, 5710.0, 5361.0, 5672.0, 5358.0, 5524.0, 5446.0, 5371.0, 5547.0, 5362.0, 5342.0, 5394.0, 5640.0, 5335.0, 5429.0, 5506.0, 5261.0, 5435.0, 5356.0, 5420.0, 5409.0, 5425.0, 5284.0, 5288.0, 5482.0, 5692.0, 5480.0 (number of hits: 8)

12	5580	9	1	333	1	5531.0, 5419.0, 5699.0, 5552.0, 5348.0, 5350.0, 5328.0, 5724.0, 5275.0, 5285.0, 5364.0, 5465.0, 5340.0, 5602.0, 5595.0, 5467.0, 5641.0, 5377.0, 5463.0, 5619.0, 5584.0, 5658.0, 5622.0, 5447.0, 5337.0, 5550.0, 5441.0, 5635.0, 5673.0, 5375.0, 5700.0, 5260.0, 5354.0, 5356.0, 5355.0, 5609.0, 5487.0, 5371.0, 5316.0, 5702.0, 5416.0, 5684.0, 5469.0, 5504.0, 5397.0, 5251.0, 5690.0, 5571.0, 5464.0, 5448.0, 5338.0, 5494.0, 5570.0, 5331.0, 5317.0, 5459.0, 5551.0, 5496.0, 5642.0, 5407.0, 5372.0, 5712.0, 5710.0, 5255.0, 5627.0, 5689.0, 5408.0, 5253.0, 5274.0, 5336.0, 5451.0, 5603.0, 5590.0, 5325.0, 5717.0, 5280.0, 5305.0, 5307.0, 5324.0, 5346.0, 5671.0, 5679.0, 5612.0, 5561.0, 5466.0, 5409.0, 5525.0, 5329.0, 5430.0, 5585.0, 5342.0, 5695.0, 5387.0, 5333.0, 5549.0, 5594.0, 5503.0, 5431.0, 5326.0, 5606.0 (number of hits: 8)
13	5580	9	1	333	1	5522.0, 5672.0, 5717.0, 5262.0, 5313.0, 5710.0, 5327.0, 5296.0, 5392.0, 5283.0, 5447.0, 5700.0, 5581.0, 5471.0, 5261.0, 5561.0, 5286.0, 5508.0, 5588.0, 5635.0, 5269.0, 5553.0, 5618.0, 5655.0, 5494.0, 5341.0, 5520.0, 5673.0, 5336.0, 5634.0, 5513.0, 5712.0, 5357.0, 5528.0, 5688.0, 5253.0, 5371.0, 5659.0, 5570.0, 5607.0, 5304.0, 5385.0, 5498.0, 5345.0, 5367.0, 5499.0, 5469.0, 5348.0, 5515.0, 5510.0, 5458.0, 5272.0, 5714.0, 5464.0, 5669.0, 5718.0, 5687.0, 5358.0, 5312.0, 5395.0, 5650.0, 5332.0, 5577.0, 5376.0, 5337.0, 5388.0, 5284.0, 5608.0, 5308.0, 5564.0, 5676.0, 5294.0, 5455.0, 5636.0, 5368.0, 5567.0, 5381.0, 5643.0, 5356.0, 5275.0, 5525.0, 5428.0, 5419.0, 5316.0, 5306.0, 5445.0, 5694.0, 5268.0, 5398.0, 5409.0, 5290.0, 5512.0, 5372.0, 5496.0, 5612.0, 5606.0, 5270.0, 5311.0, 5299.0, 5711.0 (number of hits: 11)
14	5580	9	1	333	1	5441.0, 5645.0, 5523.0, 5681.0, 5468.0, 5454.0, 5262.0, 5559.0, 5363.0, 5419.0, 5406.0, 5609.0, 5274.0, 5710.0, 5698.0, 5256.0, 5289.0, 5497.0, 5402.0, 5320.0, 5680.0, 5395.0, 5384.0, 5587.0, 5629.0, 5377.0, 5382.0, 5486.0, 5677.0, 5647.0, 5507.0, 5327.0, 5432.0, 5588.0, 5383.0, 5307.0, 5326.0, 5374.0, 5530.0, 5717.0, 5433.0, 5528.0, 5332.0, 5350.0, 5663.0, 5576.0, 5699.0, 5446.0, 5418.0, 5411.0, 5450.0, 5560.0, 5697.0, 5674.0, 5615.0, 5603.0, 5448.0, 5286.0, 5380.0, 5341.0, 5553.0, 5340.0, 5595.0, 5708.0, 5577.0, 5658.0, 5337.0, 5365.0, 5253.0, 5284.0, 5465.0, 5279.0, 5556.0, 5498.0, 5682.0, 5376.0, 5378.0, 5532.0, 5270.0, 5600.0, 5473.0, 5278.0, 5693.0, 5653.0, 5574.0,



						5462.0, 5608.0, 5610.0, 5482.0, 5705.0, 5637.0, 5459.0, 5273.0, 5678.0, 5654.0, 5503.0, 5440.0, 5308.0, 5706.0, 5290.0 (number of hits: 11)
15	5580	9	1	333	1	5461.0, 5481.0, 5327.0, 5656.0, 5612.0, 5585.0, 5600.0, 5404.0, 5518.0, 5611.0, 5403.0, 5280.0, 5564.0, 5510.0, 5635.0, 5631.0, 5507.0, 5253.0, 5252.0, 5307.0, 5431.0, 5596.0, 5443.0, 5295.0, 5718.0, 5536.0, 5696.0, 5419.0, 5349.0, 5470.0, 5544.0, 5341.0, 5418.0, 5654.0, 5257.0, 5560.0, 5389.0, 5267.0, 5647.0, 5671.0, 5499.0, 5546.0, 5692.0, 5607.0, 5330.0, 5312.0, 5521.0, 5637.0, 5313.0, 5617.0, 5613.0, 5380.0, 5262.0, 5603.0, 5508.0, 5423.0, 5362.0, 5422.0, 5610.0, 5300.0, 5604.0, 5558.0, 5394.0, 5680.0, 5540.0, 5482.0, 5369.0, 5709.0, 5365.0, 5292.0, 5715.0, 5406.0, 5333.0, 5658.0, 5370.0, 5599.0, 5452.0, 5616.0, 5477.0, 5321.0, 5428.0, 5660.0, 5393.0, 5417.0, 5689.0, 5639.0, 5584.0, 5511.0, 5636.0, 5555.0, 5685.0, 5460.0, 5412.0, 5432.0, 5308.0, 5668.0, 5673.0, 5352.0, 5265.0, 5466.0 (number of hits: 7)
16	5580	9	1	333	1	5290.0, 5360.0, 5585.0, 5412.0, 5534.0, 5693.0, 5615.0, 5527.0, 5281.0, 5656.0, 5267.0, 5722.0, 5405.0, 5367.0, 5478.0, 5632.0, 5563.0, 5265.0, 5623.0, 5336.0, 5523.0, 5495.0, 5347.0, 5299.0, 5305.0, 5329.0, 5353.0, 5450.0, 5444.0, 5316.0, 5327.0, 5330.0, 5706.0, 5559.0, 5699.0, 5637.0, 5376.0, 5511.0, 5516.0, 5335.0, 5488.0, 5584.0, 5533.0, 5679.0, 5459.0, 5425.0, 5277.0, 5350.0, 5321.0, 5354.0, 5593.0, 5607.0, 5499.0, 5592.0, 5457.0, 5446.0, 5300.0, 5674.0, 5311.0, 5651.0, 5537.0, 5332.0, 5700.0, 5470.0, 5566.0, 5490.0, 5510.0, 5635.0, 5525.0, 5633.0, 5346.0, 5520.0, 5378.0, 5697.0, 5289.0, 5308.0, 5452.0, 5568.0, 5624.0, 5612.0, 5605.0, 5540.0, 5390.0, 5292.0, 5422.0, 5583.0, 5427.0, 5492.0, 5654.0, 5719.0, 5394.0, 5673.0, 5391.0, 5438.0, 5418.0, 5505.0, 5526.0, 5521.0, 5701.0, 5643.0 (number of hits: 5)
17	5580	9	1	333	1	5540.0, 5418.0, 5390.0, 5436.0, 5321.0, 5558.0, 5410.0, 5529.0, 5687.0, 5368.0, 5605.0, 5574.0, 5567.0, 5420.0, 5610.0, 5415.0, 5398.0, 5469.0, 5565.0, 5667.0, 5531.0, 5349.0, 5721.0, 5419.0, 5279.0, 5251.0, 5537.0, 5437.0, 5673.0, 5350.0, 5550.0, 5432.0, 5435.0, 5486.0, 5706.0, 5597.0, 5666.0, 5520.0, 5547.0, 5615.0, 5318.0, 5573.0, 5393.0, 5549.0, 5280.0, 5270.0, 5298.0, 5482.0, 5305.0, 5391.0, 5263.0, 5361.0, 5462.0, 5618.0, 5677.0, 5680.0, 5404.0, 5695.0, 5277.0, 5640.0, 5413.0, 5555.0, 5487.0, 5252.0, 5443.0,

						5406.0, 5383.0, 5479.0, 5692.0, 5676.0, 5548.0, 5689.0, 5696.0, 5698.0, 5366.0, 5257.0, 5641.0, 5431.0, 5658.0, 5473.0, 5492.0, 5425.0, 5511.0, 5461.0, 5693.0, 5261.0, 5429.0, 5611.0, 5447.0, 5713.0, 5595.0, 5534.0, 5424.0, 5467.0, 5708.0, 5442.0, 5489.0, 5397.0, 5455.0, 5672.0 (number of hits: 9 )
18	5580	9	1	333	1	5680.0, 5688.0, 5323.0, 5678.0, 5331.0, 5271.0, 5353.0, 5379.0, 5612.0, 5319.0, 5439.0, 5693.0, 5297.0, 5467.0, 5417.0, 5560.0, 5659.0, 5534.0, 5420.0, 5288.0, 5712.0, 5660.0, 5621.0, 5676.0, 5317.0, 5510.0, 5336.0, 5526.0, 5651.0, 5392.0, 5456.0, 5278.0, 5581.0, 5355.0, 5546.0, 5306.0, 5280.0, 5257.0, 5450.0, 5466.0, 5709.0, 5515.0, 5485.0, 5627.0, 5311.0, 5318.0, 5575.0, 5569.0, 5454.0, 5364.0, 5540.0, 5294.0, 5723.0, 5698.0, 5528.0, 5636.0, 5435.0, 5707.0, 5491.0, 5679.0, 5600.0, 5624.0, 5291.0, 5270.0, 5287.0, 5378.0, 5371.0, 5559.0, 5305.0, 5713.0, 5391.0, 5604.0, 5484.0, 5488.0, 5256.0, 5533.0, 5514.0, 5419.0, 5683.0, 5594.0, 5619.0, 5662.0, 5677.0, 5264.0, 5448.0, 5471.0, 5409.0, 5388.0, 5345.0, 5516.0, 5300.0, 5494.0, 5320.0, 5655.0, 5507.0, 5452.0, 5472.0, 5704.0, 5293.0, 5718.0 (number of hits: 9 )
19	5580	9	1	333	1	5422.0, 5473.0, 5687.0, 5577.0, 5533.0, 5486.0, 5556.0, 5306.0, 5261.0, 5514.0, 5595.0, 5359.0, 5722.0, 5442.0, 5472.0, 5620.0, 5721.0, 5481.0, 5558.0, 5712.0, 5650.0, 5714.0, 5309.0, 5408.0, 5294.0, 5664.0, 5601.0, 5508.0, 5549.0, 5618.0, 5536.0, 5637.0, 5611.0, 5288.0, 5548.0, 5587.0, 5522.0, 5574.0, 5635.0, 5400.0, 5599.0, 5358.0, 5425.0, 5713.0, 5435.0, 5608.0, 5374.0, 5286.0, 5627.0, 5525.0, 5318.0, 5598.0, 5686.0, 5434.0, 5452.0, 5678.0, 5559.0, 5271.0, 5402.0, 5275.0, 5348.0, 5570.0, 5456.0, 5557.0, 5680.0, 5633.0, 5310.0, 5443.0, 5335.0, 5479.0, 5345.0, 5697.0, 5467.0, 5391.0, 5457.0, 5624.0, 5503.0, 5668.0, 5417.0, 5720.0, 5352.0, 5488.0, 5410.0, 5596.0, 5478.0, 5699.0, 5582.0, 5471.0, 5539.0, 5386.0, 5656.0, 5284.0, 5252.0, 5538.0, 5706.0, 5511.0, 5370.0, 5523.0, 5708.0, 5679.0 (number of hits: 7 )
20	5580	9	1	333	1	5262.0, 5486.0, 5440.0, 5375.0, 5316.0, 5426.0, 5710.0, 5712.0, 5529.0, 5309.0, 5406.0, 5621.0, 5504.0, 5674.0, 5295.0, 5671.0, 5472.0, 5463.0, 5277.0, 5315.0, 5268.0, 5599.0, 5590.0, 5338.0, 5564.0, 5606.0, 5684.0, 5402.0, 5327.0, 5629.0, 5378.0, 5549.0, 5650.0, 5499.0, 5600.0, 5313.0, 5356.0, 5511.0, 5428.0, 5514.0, 5500.0, 5391.0, 5515.0, 5478.0, 5596.0,

						5361.0, 5667.0, 5708.0, 5669.0, 5362.0, 5399.0, 5449.0, 5398.0, 5304.0, 5254.0, 5462.0, 5723.0, 5539.0, 5683.0, 5323.0, 5670.0, 5717.0, 5413.0, 5390.0, 5584.0, 5456.0, 5707.0, 5300.0, 5387.0, 5604.0, 5492.0, 5678.0, 5435.0, 5694.0, 5302.0, 5502.0, 5542.0, 5594.0, 5446.0, 5547.0, 5575.0, 5386.0, 5408.0, 5655.0, 5276.0, 5273.0, 5487.0, 5556.0, 5598.0, 5438.0, 5407.0, 5405.0, 5661.0, 5716.0, 5429.0, 5625.0, 5363.0, 5691.0, 5718.0, 5414.0 (number of hits: 6)
21	5580	9	1	333	1	5499.0, 5312.0, 5696.0, 5581.0, 5431.0, 5506.0, 5551.0, 5343.0, 5620.0, 5568.0, 5439.0, 5601.0, 5353.0, 5434.0, 5677.0, 5347.0, 5469.0, 5687.0, 5335.0, 5480.0, 5290.0, 5399.0, 5673.0, 5698.0, 5643.0, 5484.0, 5550.0, 5641.0, 5691.0, 5319.0, 5700.0, 5481.0, 5636.0, 5272.0, 5646.0, 5265.0, 5407.0, 5333.0, 5281.0, 5334.0, 5363.0, 5684.0, 5579.0, 5519.0, 5466.0, 5492.0, 5285.0, 5478.0, 5318.0, 5393.0, 5436.0, 5650.0, 5449.0, 5409.0, 5588.0, 5639.0, 5304.0, 5517.0, 5329.0, 5477.0, 5595.0, 5289.0, 5268.0, 5612.0, 5277.0, 5381.0, 5330.0, 5251.0, 5383.0, 5624.0, 5428.0, 5690.0, 5371.0, 5339.0, 5640.0, 5366.0, 5320.0, 5657.0, 5340.0, 5508.0, 5722.0, 5274.0, 5531.0, 5444.0, 5569.0, 5394.0, 5560.0, 5526.0, 5416.0, 5522.0, 5411.0, 5303.0, 5703.0, 5674.0, 5390.0, 5284.0, 5675.0, 5701.0, 5408.0, 5419.0 (number of hits: 10)
22	5580	9	1	333	1	5321.0, 5539.0, 5369.0, 5641.0, 5320.0, 5546.0, 5398.0, 5378.0, 5384.0, 5356.0, 5477.0, 5606.0, 5506.0, 5365.0, 5632.0, 5459.0, 5676.0, 5281.0, 5696.0, 5620.0, 5678.0, 5263.0, 5723.0, 5569.0, 5406.0, 5504.0, 5272.0, 5417.0, 5640.0, 5276.0, 5619.0, 5408.0, 5441.0, 5402.0, 5662.0, 5505.0, 5479.0, 5413.0, 5291.0, 5493.0, 5487.0, 5542.0, 5255.0, 5666.0, 5331.0, 5436.0, 5351.0, 5383.0, 5304.0, 5643.0, 5423.0, 5300.0, 5615.0, 5530.0, 5589.0, 5638.0, 5698.0, 5684.0, 5670.0, 5443.0, 5578.0, 5554.0, 5503.0, 5566.0, 5288.0, 5628.0, 5593.0, 5647.0, 5258.0, 5595.0, 5492.0, 5645.0, 5618.0, 5587.0, 5404.0, 5695.0, 5279.0, 5498.0, 5485.0, 5601.0, 5329.0, 5389.0, 5572.0, 5431.0, 5680.0, 5438.0, 5611.0, 5584.0, 5426.0, 5400.0, 5713.0, 5644.0, 5325.0, 5388.0, 5322.0, 5428.0, 5712.0, 5718.0, 5387.0, 5262.0 (number of hits: 9)
23	5580	9	1	333	1	5519.0, 5271.0, 5543.0, 5273.0, 5568.0, 5708.0, 5315.0, 5355.0, 5641.0, 5309.0, 5635.0, 5556.0, 5391.0, 5398.0, 5269.0, 5440.0, 5595.0, 5262.0, 5358.0, 5649.0, 5487.0, 5540.0, 5378.0, 5312.0, 5553.0,

						5287.0, 5628.0, 5467.0, 5678.0, 5491.0, 5561.0, 5419.0, 5286.0, 5585.0, 5396.0, 5599.0, 5597.0, 5551.0, 5620.0, 5672.0, 5498.0, 5370.0, 5426.0, 5331.0, 5290.0, 5610.0, 5662.0, 5686.0, 5699.0, 5476.0, 5494.0, 5412.0, 5408.0, 5344.0, 5496.0, 5639.0, 5677.0, 5322.0, 5601.0, 5602.0, 5654.0, 5591.0, 5430.0, 5522.0, 5401.0, 5293.0, 5661.0, 5338.0, 5509.0, 5342.0, 5345.0, 5579.0, 5633.0, 5457.0, 5604.0, 5705.0, 5381.0, 5459.0, 5721.0, 5690.0, 5453.0, 5723.0, 5481.0, 5356.0, 5455.0, 5589.0, 5679.0, 5695.0, 5425.0, 5548.0, 5372.0, 5263.0, 5362.0, 5570.0, 5386.0, 5572.0, 5469.0, 5545.0, 5280.0, 5351.0 (number of hits: 8)
24	5580	9	1	333	1	5685.0, 5682.0, 5353.0, 5723.0, 5674.0, 5570.0, 5420.0, 5379.0, 5355.0, 5252.0, 5377.0, 5672.0, 5447.0, 5714.0, 5394.0, 5453.0, 5352.0, 5383.0, 5425.0, 5655.0, 5724.0, 5430.0, 5626.0, 5507.0, 5336.0, 5591.0, 5461.0, 5501.0, 5605.0, 5599.0, 5547.0, 5451.0, 5496.0, 5498.0, 5303.0, 5454.0, 5390.0, 5592.0, 5471.0, 5539.0, 5279.0, 5347.0, 5343.0, 5292.0, 5493.0, 5490.0, 5572.0, 5643.0, 5548.0, 5590.0, 5619.0, 5416.0, 5283.0, 5681.0, 5700.0, 5419.0, 5308.0, 5290.0, 5359.0, 5380.0, 5520.0, 5296.0, 5646.0, 5302.0, 5711.0, 5440.0, 5528.0, 5473.0, 5483.0, 5531.0, 5661.0, 5405.0, 5332.0, 5532.0, 5462.0, 5326.0, 5545.0, 5569.0, 5320.0, 5375.0, 5266.0, 5300.0, 5488.0, 5376.0, 5546.0, 5603.0, 5719.0, 5555.0, 5524.0, 5294.0, 5634.0, 5456.0, 5413.0, 5325.0, 5316.0, 5584.0, 5374.0, 5475.0, 5406.0, 5717.0 (number of hits: 4)
25	5580	9	1	333	1	5520.0, 5612.0, 5549.0, 5722.0, 5435.0, 5644.0, 5363.0, 5436.0, 5324.0, 5441.0, 5430.0, 5448.0, 5597.0, 5451.0, 5364.0, 5305.0, 5715.0, 5490.0, 5555.0, 5386.0, 5342.0, 5704.0, 5446.0, 5563.0, 5512.0, 5635.0, 5629.0, 5369.0, 5546.0, 5570.0, 5530.0, 5712.0, 5705.0, 5276.0, 5406.0, 5272.0, 5718.0, 5388.0, 5484.0, 5711.0, 5667.0, 5322.0, 5586.0, 5344.0, 5550.0, 5514.0, 5508.0, 5265.0, 5256.0, 5658.0, 5630.0, 5318.0, 5599.0, 5347.0, 5701.0, 5299.0, 5517.0, 5457.0, 5594.0, 5654.0, 5676.0, 5664.0, 5252.0, 5329.0, 5413.0, 5590.0, 5529.0, 5379.0, 5350.0, 5604.0, 5282.0, 5283.0, 5601.0, 5374.0, 5317.0, 5440.0, 5390.0, 5498.0, 5719.0, 5326.0, 5449.0, 5407.0, 5343.0, 5464.0, 5302.0, 5393.0, 5311.0, 5524.0, 5650.0, 5453.0, 5301.0, 5640.0, 5431.0, 5592.0, 5316.0, 5683.0, 5401.0, 5609.0, 5627.0, 5267.0 (number of hits: 8)
26	5580	9	1	333	1	5380.0, 5559.0, 5593.0, 5417.0, 5579.0,

						5454.0, 5585.0, 5463.0, 5406.0, 5714.0, 5478.0, 5451.0, 5548.0, 5273.0, 5613.0, 5336.0, 5425.0, 5313.0, 5674.0, 5292.0, 5340.0, 5618.0, 5377.0, 5396.0, 5306.0, 5678.0, 5515.0, 5424.0, 5494.0, 5578.0, 5469.0, 5307.0, 5486.0, 5286.0, 5510.0, 5545.0, 5440.0, 5600.0, 5290.0, 5281.0, 5623.0, 5598.0, 5687.0, 5569.0, 5443.0, 5344.0, 5541.0, 5636.0, 5673.0, 5517.0, 5257.0, 5526.0, 5483.0, 5703.0, 5350.0, 5667.0, 5345.0, 5497.0, 5523.0, 5441.0, 5602.0, 5275.0, 5489.0, 5309.0, 5629.0, 5297.0, 5429.0, 5518.0, 5549.0, 5580.0, 5327.0, 5343.0, 5442.0, 5366.0, 5720.0, 5577.0, 5718.0, 5605.0, 5263.0, 5639.0, 5258.0, 5594.0, 5543.0, 5408.0, 5504.0, 5682.0, 5271.0, 5404.0, 5520.0, 5334.0, 5573.0, 5696.0, 5587.0, 5383.0, 5609.0, 5538.0, 5659.0, 5468.0, 5324.0, 5347.0 (number of hits: 8 )
27	5580	9	1	333	1	5648.0, 5256.0, 5303.0, 5511.0, 5310.0, 5443.0, 5496.0, 5344.0, 5459.0, 5446.0, 5687.0, 5721.0, 5297.0, 5719.0, 5680.0, 5311.0, 5700.0, 5681.0, 5377.0, 5338.0, 5593.0, 5498.0, 5433.0, 5722.0, 5349.0, 5666.0, 5385.0, 5591.0, 5543.0, 5616.0, 5309.0, 5596.0, 5369.0, 5263.0, 5447.0, 5637.0, 5460.0, 5471.0, 5565.0, 5373.0, 5499.0, 5685.0, 5688.0, 5418.0, 5584.0, 5564.0, 5411.0, 5656.0, 5654.0, 5518.0, 5617.0, 5618.0, 5651.0, 5332.0, 5347.0, 5277.0, 5328.0, 5624.0, 5639.0, 5319.0, 5594.0, 5405.0, 5261.0, 5257.0, 5706.0, 5602.0, 5329.0, 5649.0, 5647.0, 5340.0, 5606.0, 5575.0, 5400.0, 5653.0, 5341.0, 5641.0, 5574.0, 5293.0, 5410.0, 5569.0, 5417.0, 5273.0, 5673.0, 5707.0, 5567.0, 5315.0, 5424.0, 5660.0, 5716.0, 5389.0, 5595.0, 5670.0, 5701.0, 5587.0, 5280.0, 5479.0, 5363.0, 5662.0, 5600.0, 5437.0 (number of hits: 7 )
28	5580	9	1	333	1	5622.0, 5509.0, 5368.0, 5333.0, 5548.0, 5701.0, 5631.0, 5661.0, 5647.0, 5704.0, 5254.0, 5625.0, 5473.0, 5711.0, 5433.0, 5655.0, 5537.0, 5491.0, 5531.0, 5438.0, 5362.0, 5609.0, 5390.0, 5524.0, 5354.0, 5690.0, 5377.0, 5563.0, 5571.0, 5310.0, 5570.0, 5284.0, 5349.0, 5716.0, 5660.0, 5562.0, 5439.0, 5453.0, 5525.0, 5397.0, 5603.0, 5616.0, 5443.0, 5370.0, 5543.0, 5338.0, 5305.0, 5572.0, 5485.0, 5255.0, 5306.0, 5348.0, 5598.0, 5389.0, 5607.0, 5602.0, 5421.0, 5649.0, 5487.0, 5259.0, 5346.0, 5445.0, 5638.0, 5401.0, 5365.0, 5330.0, 5664.0, 5520.0, 5518.0, 5325.0, 5334.0, 5703.0, 5274.0, 5270.0, 5559.0, 5523.0, 5403.0, 5308.0, 5329.0, 5323.0, 5355.0, 5707.0, 5277.0, 5720.0, 5613.0, 5666.0, 5489.0, 5514.0, 5320.0, 5276.0

						5278.0, 5493.0, 5344.0, 5396.0, 5373.0, 5700.0, 5427.0, 5350.0, 5553.0, 5295.0 (number of hits: 9)
29	5580	9	1	333	1	5496.0, 5617.0, 5311.0, 5275.0, 5387.0, 5693.0, 5668.0, 5327.0, 5354.0, 5250.0, 5425.0, 5404.0, 5282.0, 5689.0, 5283.0, 5442.0, 5721.0, 5607.0, 5529.0, 5321.0, 5456.0, 5465.0, 5557.0, 5623.0, 5521.0, 5343.0, 5715.0, 5297.0, 5398.0, 5292.0, 5622.0, 5603.0, 5677.0, 5471.0, 5267.0, 5480.0, 5472.0, 5545.0, 5707.0, 5609.0, 5583.0, 5330.0, 5644.0, 5595.0, 5509.0, 5370.0, 5305.0, 5597.0, 5396.0, 5683.0, 5599.0, 5660.0, 5384.0, 5431.0, 5390.0, 5417.0, 5272.0, 5366.0, 5501.0, 5615.0, 5539.0, 5678.0, 5724.0, 5430.0, 5569.0, 5342.0, 5528.0, 5436.0, 5585.0, 5562.0, 5643.0, 5447.0, 5561.0, 5439.0, 5671.0, 5533.0, 5459.0, 5537.0, 5681.0, 5662.0, 5661.0, 5434.0, 5426.0, 5279.0, 5551.0, 5682.0, 5373.0, 5658.0, 5450.0, 5578.0, 5278.0, 5568.0, 5312.0, 5257.0, 5544.0, 5427.0, 5403.0, 5432.0, 5476.0, 5407.0 (number of hits: 9)
30	5580	9	1	333	1	5417.0, 5252.0, 5591.0, 5470.0, 5491.0, 5485.0, 5696.0, 5294.0, 5708.0, 5315.0, 5600.0, 5650.0, 5424.0, 5326.0, 5274.0, 5658.0, 5476.0, 5503.0, 5645.0, 5345.0, 5632.0, 5686.0, 5341.0, 5302.0, 5633.0, 5610.0, 5393.0, 5266.0, 5398.0, 5566.0, 5679.0, 5640.0, 5354.0, 5516.0, 5520.0, 5312.0, 5626.0, 5351.0, 5292.0, 5288.0, 5670.0, 5466.0, 5418.0, 5612.0, 5287.0, 5415.0, 5408.0, 5307.0, 5267.0, 5700.0, 5669.0, 5250.0, 5579.0, 5293.0, 5337.0, 5355.0, 5411.0, 5583.0, 5541.0, 5680.0, 5553.0, 5563.0, 5661.0, 5477.0, 5690.0, 5325.0, 5478.0, 5580.0, 5499.0, 5413.0, 5360.0, 5406.0, 5381.0, 5575.0, 5350.0, 5621.0, 5550.0, 5324.0, 5647.0, 5343.0, 5391.0, 5596.0, 5498.0, 5614.0, 5431.0, 5601.0, 5401.0, 5255.0, 5624.0, 5440.0, 5369.0, 5613.0, 5675.0, 5594.0, 5538.0, 5395.0, 5278.0, 5706.0, 5505.0, 5426.0 (number of hits: 9)

**5270 MHz, 40 MHz Bandwidth**

<b>Radar Signal Type</b>	<b>Waveform/Trial Number</b>	<b>Detection (%)</b>	<b>Limit (%)</b>	<b>Pass/Fail</b>
Type 1A/1B	30	100 %	60%	Pass
Type 2	30	100 %	60%	Pass
Type 3	30	100 %	60%	Pass
Type 4	30	100 %	60%	Pass
<b>Aggregate (Type1 to 4)</b>	120	100 %	80%	Pass
Type 5	30	100 %	80%	Pass
Type 6	30	100 %	70%	Pass

Please refer to the following statistical tables:

**Table-1 Radar Type 1A/1B Statistical Performance**

<b>Trial #</b>	<b>Fc (MHz)</b>	<b>Pulse/Burst</b>	<b>Pulse Width (μS)</b>	<b>PRI (μs)</b>	<b>Detection (1:yes; 0:no)</b>
1	5270	18	1	3066	1
2	5270	72	1	738	1
3	5270	68	1	778	1
4	5270	63	1	838	1
5	5270	83	1	638	1
6	5270	67	1	798	1
7	5270	92	1	578	1
8	5270	95	1	558	1
9	5270	99	1	538	1
10	5270	74	1	718	1
11	5270	86	1	618	1
12	5270	102	1	518	1
13	5270	62	1	858	1
14	5270	78	1	678	1
15	5270	81	1	658	1
16	5270	67	1	792	1
17	5270	38	1	1426	1
18	5270	26	1	2042	1
19	5270	23	1	2378	1
20	5270	37	1	1433	1
21	5270	25	1	2164	1
22	5270	63	1	840	1
23	5270	80	1	666	1
24	5270	19	1	2925	1
25	5270	25	1	2125	1
26	5270	18	1	2946	1
27	5270	41	1	1313	1
28	5270	20	1	2650	1
29	5270	39	1	1357	1
30	5270	24	1	2213	1
<b>Detection Percentage: 100 % (&gt;60%)</b>					



**Table-2 Radar Type 2 Statistical Performance**

<b>Trial #</b>	<b>Fc (MHz)</b>	<b>Pulse/Burst</b>	<b>Pulse Width (μS)</b>	<b>PRI (μs)</b>	<b>Detection (1:yes; 0:no)</b>
1	5270	23	4.7	220	1
2	5270	25	4.9	194	1
3	5270	25	4.7	204	1
4	5270	25	1.9	178	1
5	5270	29	2.9	225	1
6	5270	29	3.7	160	1
7	5270	29	4.5	190	1
8	5270	27	3.4	169	1
9	5270	29	5	188	1
10	5270	27	1.7	204	1
11	5270	27	5	182	1
12	5270	25	4.2	176	1
13	5270	27	4.8	167	1
14	5270	28	3.7	150	1
15	5270	24	4.7	181	1
16	5270	27	1.7	187	1
17	5270	29	3	179	1
18	5270	25	1.4	182	1
19	5270	26	4.7	230	1
20	5270	27	2.8	228	1
21	5270	24	1.9	226	1
22	5270	25	1.1	154	1
23	5270	27	2.1	206	1
24	5270	25	3.8	203	1
25	5270	25	1.1	223	1
26	5270	29	3.7	150	1
27	5270	24	4.9	175	1
28	5270	28	1.5	215	1
29	5270	27	3.4	222	1
30	5270	28	3	165	1
<b>Detection Percentage: 100 % (&gt;60%)</b>					

**Table-3 Radar Type 3 Statistical Performance**

<b>Trial #</b>	<b>Fc (MHz)</b>	<b>Pulse/Burst</b>	<b>Pulse Width (μS)</b>	<b>PRI (μs)</b>	<b>Detection (1:yes; 0:no)</b>
1	5270	18	8.8	419	1
2	5270	18	8.2	454	1
3	5270	16	7.1	404	1
4	5270	18	7.8	476	1
5	5270	16	9.4	415	1
6	5270	16	7.3	452	1
7	5270	18	8.4	240	1
8	5270	16	8.6	444	1
9	5270	16	9.9	271	1
10	5270	18	8.9	336	1
11	5270	17	8.5	256	1
12	5270	17	8.6	436	1
13	5270	18	7.3	236	1
14	5270	18	6.7	299	1
15	5270	17	9.5	397	1
16	5270	17	6.4	237	1
17	5270	16	7.2	284	1
18	5270	16	9.8	424	1
19	5270	16	6.3	494	1
20	5270	17	6.8	499	1
21	5270	16	7.3	383	1
22	5270	18	9.7	289	1
23	5270	17	8.6	237	1
24	5270	17	8.1	443	1
25	5270	17	6.6	293	1
26	5270	17	6.8	490	1
27	5270	17	9.1	389	1
28	5270	17	9.9	458	1
29	5270	18	8.6	420	1
30	5270	18	7.8	259	1
<b>Detection Percentage: 100 % (&gt;60%)</b>					

**Table-4 Radar Type 4 Statistical Performance**

<b>Trial #</b>	<b>Fc (MHz)</b>	<b>Pulse/Burst</b>	<b>Pulse Width (μS)</b>	<b>PRI (μs)</b>	<b>Detection (1:yes; 0:no)</b>
1	5270	14	14.7	217	1
2	5270	14	14	468	1
3	5270	12	11.7	335	1
4	5270	16	11.7	433	1
5	5270	12	14.9	422	1
6	5270	13	13.1	430	1
7	5270	13	11.1	408	1
8	5270	16	19.8	421	1
9	5270	15	15.3	301	1
10	5270	13	13	272	1
11	5270	15	16.1	360	1
12	5270	12	14.1	466	1
13	5270	16	15	239	1
14	5270	12	15.4	392	1
15	5270	16	15.3	387	1
16	5270	15	19.5	359	1
17	5270	13	11.2	430	1
18	5270	12	19.8	423	1
19	5270	12	19.4	235	1
20	5270	14	18.6	279	1
21	5270	13	17.9	359	1
22	5270	16	15.5	430	1
23	5270	12	11.3	472	1
24	5270	14	14.1	341	1
25	5270	13	19.2	220	1
26	5270	12	15.9	405	1
27	5270	15	14.8	275	1
28	5270	15	19.7	459	1
29	5270	12	14.8	207	1
30	5270	16	15.5	222	1
<b>Detection Percentage: 100 % (&gt;60%)</b>					

**Table-5 Radar Type 5 Statistical Performance**

Bin5 Statistics 1

Trial #	Pulse	Chirp (MHz)	Pulse Width (μS)	Pulse 1-2 spacing (uS)	Pulse 2-3 spacing (uS)	Pulse Start(S)	Detection (1:yes; 0:no)
0	1	15	70.1			0.045591	1
1	2	10	72.1	1732		1.990391	
2	3	12	68	1316	1447	2.566158	
3	2	7	81.8	1239		3.54135	
4	2	9	85.7	1928		4.394199	
5	1	5	71.9			5.812003	
6	1	13	61.8			7.416072	
7	1	6	55.1			7.915664	
8	3	9	62.7	1144	1026	9.23954	
9	2	8	97	1703		10.10797	
10	2	18	66.7	1538		10.95697	

## Bin5 Statistics 2

Trial #	Pulse	Chirp (MHz)	Pulse Width (µS)	Pulse 1-2 spacing (uS)	Pulse 2-3 spacing (uS)	Pulse Start(S)	Detection (1:yes; 0:no)
0	2	10	77.8	1322		0.08727	1
1	1	13	80.3			0.990448	
2	1	6	96.3			2.159286	
3	2	15	77.3	1589		2.728657	
4	2	17	88.6	1694		3.519288	
5	2	6	72.7	1978		4.94224	
6	2	10	59	1580		5.904933	
7	3	6	79.6	1910	1061	6.582889	
8	1	19	94.6			6.904231	
9	2	11	87.9	1825		7.833711	
10	3	17	89.6	1486	1608	8.963691	
11	2	14	52.2	1672		10.02211	
12	2	17	64.3	1568		10.48593	
13	1	14	83			11.62676	

## Bin5 Statistics 3

Trial #	Pulse	Chirp (MHz)	Pulse Width (µS)	Pulse 1-2 spacing (uS)	Pulse 2-3 spacing (uS)	Pulse Start(S)	Detection (1:yes; 0:no)
0	3	9	90.9	1877	1387	0.789216	1
1	1	17	53.8			1.408242	
2	1	8	82.5			1.844436	
3	2	17	56.8	1929		2.994433	
4	1	5	72.8			3.668738	
5	3	11	70.6	1320	1688	4.813327	
6	2	12	71.9	1094		5.851509	
7	2	10	52.7	1287		6.205489	
8	2	20	89.6	1235		7.354498	
9	1	20	83.6			7.973206	
10	3	16	93.1	1006	1623	9.158278	
11	1	13	73.9			9.877266	
12	2	8	91.2	1569		11.01373	
13	3	7	69.7	1227	1464	11.63907	

## Bin5 Statistics 4

Trial #	Pulse	Chirp (MHz)	Pulse Width (μS)	Pulse 1-2 spacing (uS)	Pulse 2-3 spacing (uS)	Pulse Start(S)	Detection (1:yes; 0:no)
0	2	9	96.4	1451		0.364953	1
1	3	16	52.6	1545	1840	1.025589	
2	2	11	69	1353		1.728325	
3	2	20	60.3	1123		2.388249	
4	3	19	93.9	1128	1975	2.94042	
5	2	15	67.2	1055		3.515948	
6	1	10	77.1			3.902315	
7	3	11	84.9	1399	1261	4.668698	
8	2	11	70.5	1249		4.926878	
9	3	9	70	1059	1167	5.871458	
10	2	9	93	1907		6.423863	
11	2	12	60	1377		6.963996	
12	2	16	66.2	1750		7.488793	
13	2	7	82.5	1920		8.158687	
14	2	6	81.8	1552		8.565853	
15	1	14	88.2			9.516418	
16	1	16	78.9			10.00584	
17	1	18	65.9			10.32386	
18	2	5	95.4	1945		10.97786	
19	3	8	52.9	1901	1861	11.61946	

## Bin5 Statistics 5

Trial #	Pulse	Chirp (MHz)	Pulse Width (µS)	Pulse 1-2 spacing (uS)	Pulse 2-3 spacing (uS)	Pulse Start(S)	Detection (1:yes; 0:no)
0	2	14	81.2	1777		0.233766	1
1	2	11	98.6	1834		0.915963	
2	1	9	89.9			1.380344	
3	1	8	98.2			2.200486	
4	3	19	69	1381	1937	2.621695	
5	2	15	92.6	1012		3.48564	
6	3	11	87.3	1626	1154	4.154222	
7	3	14	54.5	1230	1559	4.98532	
8	3	15	65.9	1098	1314	5.610417	
9	1	9	83.6			6.119882	
10	2	19	87.9	1578		6.449118	
11	3	8	78.7	1439	1558	7.129372	
12	1	6	95.2			8.099635	
13	1	13	52.3			8.421073	
14	2	20	97	1706		9.405464	
15	1	14	60.5			10.00156	
16	1	14	55.4			10.35669	
17	3	8	56.3	1012	1352	10.90691	
18	2	7	77.2	1690		11.37701	

## Bin5 Statistics 6

Trial #	Pulse	Chirp (MHz)	Pulse Width (µS)	Pulse 1-2 spacing (uS)	Pulse 2-3 spacing (uS)	Pulse Start(S)	Detection (1:yes; 0:no)
0	3	8	53.9	1909	1281	0.738276	1
1	2	12	85.9	1080		1.996426	
2	1	15	74.7			3.100501	
3	1	20	80.4			4.294401	
4	3	6	50.5	1068	1809	4.762148	
5	3	8	92.1	1290	1080	6.152022	
6	1	6	52.1			7.549441	
7	2	14	76.9	1097		8.38056	
8	1	5	85.2			9.173088	
9	2	14	87	1276		10.08982	
10	2	15	58.4	1554		11.09841	

## Bin5 Statistics 7

Trial #	Pulse	Chirp (MHz)	Pulse Width (µS)	Pulse 1-2 spacing (µS)	Pulse 2-3 spacing (µS)	Pulse Start(S)	Detection (1:yes; 0:no)
0	2	13	90.9	1626		0.705746	1
1	2	7	71.8	1748		0.779128	
2	3	14	50	1664	1434	1.836794	
3	2	19	62.1	1016		2.407656	
4	1	11	72.7			3.115247	
5	2	9	87.1	1157		4.443928	
6	2	13	98.8	1505		5.228139	
7	2	8	68.1	1345		5.898033	
8	3	12	52.7	1619	1509	6.730688	
9	2	18	60	1446		7.01925	
10	2	11	51.5	1500		7.635585	
11	2	15	60.6	1015		8.787724	
12	1	19	68.5			9.165673	
13	3	8	56.9	1861	1171	9.837449	
14	3	8	96.9	1609	1803	10.82643	
15	2	9	91.2	1921		11.54385	

## Bin5 Statistics 8

Trial #	Pulse	Chirp (MHz)	Pulse Width (µS)	Pulse 1-2 spacing (µS)	Pulse 2-3 spacing (µS)	Pulse Start(S)	Detection (1:yes; 0:no)
0	2	15	64.6	1150		0.95814	1
1	1	14	52.7			1.730506	
2	2	12	71.1	1508		2.862579	
3	3	11	57.2	1854	1256	5.148728	
4	2	8	94	1416		5.92923	
5	1	8	93.5			6.693038	
6	2	11	54.9	1080		9.180562	
7	2	15	91.3	1068		10.62376	
8	2	10	90.4	1349		10.955	



## Bin5 Statistics 9

Trial #	Pulse	Chirp (MHz)	Pulse Width (µS)	Pulse 1-2 spacing (µS)	Pulse 2-3 spacing (µS)	Pulse Start(S)	Detection (1:yes; 0:no)
0	3	10	51.6	1290	1449	0.368488	1
1	3	12	88.3	1304	1302	1.116709	
2	3	18	84.6	1484	1428	1.315748	
3	3	18	97.8	1113	1793	2.476134	
4	3	19	95.5	1310	1042	3.142385	
5	2	18	72.1	1291		3.669327	
6	1	19	52.5			4.280015	
7	1	12	94.6			4.846175	
8	1	18	93.6			5.170695	
9	3	15	90.5	1734	1747	5.883275	
10	1	13	94.4			6.668401	
11	2	11	54.2	1653		7.432034	
12	1	11	89			7.845739	
13	2	12	85.4	1279		8.820533	
14	2	8	77.3	1646		9.129696	
15	2	6	72.2	1167		9.925616	
16	2	10	76.3	1537		10.31868	
17	3	7	90.7	1367	1880	10.77985	
18	2	16	66.2	1586		11.80133	

## Bin5 Statistics 10

Trial #	Pulse	Chirp (MHz)	Pulse Width (µS)	Pulse 1-2 spacing (uS)	Pulse 2-3 spacing (uS)	Pulse Start(S)	Detection (1:yes; 0:no)
0	1	7	79.6			0.025202	1
1	1	7	88.9			0.911448	
2	2	9	60.3	1233		1.6158	
3	3	19	94.3	1012	1683	2.646215	
4	3	17	99.9	1185	1800	3.447888	
5	3	7	75.3	1797	1842	3.72928	
6	2	13	66.6	1334		4.734487	
7	1	13	50.1			5.528944	
8	2	12	61.6	1970		5.731945	
9	2	15	86.1	1550		6.775081	
10	2	14	82.1	1010		7.462325	
11	2	18	83.2	1435		7.798441	
12	2	7	96.5	1638		9.0243	
13	3	18	71.2	1765	1076	9.532801	
14	2	13	60.5	1250		9.901829	
15	2	7	97.2	1794		11.00174	
16	1	6	51.1			11.88783	

## Bin5 Statistics 11

Trial #	Pulse	Chirp (MHz)	Pulse Width (µS)	Pulse 1-2 spacing (µS)	Pulse 2-3 spacing (µS)	Pulse Start(S)	Detection (1:yes; 0:no)
0	3	19	89.7	1275	1522	0.067894	1
1	3	14	65.5	1245	1874	1.092123	
2	2	19	51.3	1377		1.256623	
3	2	8	51.5	1552		1.998978	
4	3	16	72.9	1825	1684	2.521717	
5	1	11	73.2			3.336126	
6	2	18	76	1471		3.610826	
7	2	13	97.8	1613		4.330937	
8	3	18	66	1119	1743	4.857945	
9	2	8	88.7	1649		5.698963	
10	2	15	87.4	1874		6.198802	
11	1	10	55.7			6.66073	
12	2	10	95.3	1754		7.574701	
13	1	18	51.4			8.041401	
14	3	12	88.9	1055	1230	8.456387	
15	1	6	81.6			9.225893	
16	1	15	98.2			9.752764	
17	2	10	92.8	1264		10.22534	
18	2	7	74.9	1962		11.31222	
19	1	18	78.3			11.96439	

## Bin5 Statistics 12

Trial #	Pulse	Chirp (MHz)	Pulse Width (µS)	Pulse 1-2 spacing (µS)	Pulse 2-3 spacing (µS)	Pulse Start(S)	Detection (1:yes; 0:no)
0	3	14	87.6	1646	1718	0.036329	1
1	2	11	83.4	2000		1.033625	
2	2	16	96.1	1706		1.675595	
3	1	12	69.7			2.162622	
4	2	10	83.6	1327		2.948534	
5	2	11	69	1679		3.710292	
6	3	7	97.7	1572	1039	4.852929	
7	2	20	86.3	1418		5.490379	
8	3	6	53.4	1504	1951	5.772876	
9	2	16	85.6	1731		6.539263	
10	1	13	72.5			7.187284	
11	1	7	72.8			7.861148	
12	2	16	86.4	1343		8.50278	
13	2	15	68.3	1118		9.805902	
14	2	10	93.8	1976		10.50068	
15	2	18	64.9	1722		11.10109	
16	1	10	66.7			11.68294	

## Bin5 Statistics 13

Trial #	Pulse	Chirp (MHz)	Pulse Width (µS)	Pulse 1-2 spacing (uS)	Pulse 2-3 spacing (uS)	Pulse Start(S)	Detection (1:yes; 0:no)
0	2	15	69.9	1420		0.157027	1
1	3	20	79.5	1032	1870	0.729603	
2	2	5	60.3	1346		1.950433	
3	2	13	56.5	1594		2.473786	
4	2	7	85.8	1480		2.667157	
5	2	19	50.2	1163		3.62629	
6	1	14	72.3			4.149604	
7	2	13	80.2	1423		5.278294	
8	3	19	78.5	1355	1329	5.986168	
9	1	14	55.7			6.36349	
10	3	19	62	1931	1595	6.809597	
11	2	17	66.7	1823		7.510338	
12	2	19	55.6	1097		8.534221	
13	3	11	83.1	1471	1900	8.939152	
14	3	13	87.4	1865	1129	9.940549	
15	1	16	86.1			10.4818	
16	2	13	58.6	1732		11.03498	
17	1	12	95.3			11.77819	

## Bin5 Statistics 14

Trial #	Pulse	Chirp (MHz)	Pulse Width (µS)	Pulse 1-2 spacing (µS)	Pulse 2-3 spacing (µS)	Pulse Start(S)	Detection (1:yes; 0:no)
0	3	10	53.2	1461	1022	0.568382	1
1	1	17	69.7			1.029049	
2	1	17	63.1			1.830124	
3	3	18	72.8	1517	1373	2.713384	
4	3	7	68.2	1560	1881	3.084757	
5	1	19	59.6			3.926469	
6	3	6	99.3	1424	1156	4.372742	
7	3	10	50.9	1310	1780	5.454946	
8	1	10	79.6			6.20101	
9	1	11	62			6.686267	
10	2	5	61.9	1470		7.110441	
11	2	16	96.5	1688		8.029127	
12	2	16	79.5	1795		9.133852	
13	2	19	76.8	1726		9.661321	
14	3	12	87.9	1582	1750	10.06768	
15	2	13	85.3	1787		11.1021	
16	1	16	54.7			11.4245	

## Bin5 Statistics 15

Trial #	Pulse	Chirp (MHz)	Pulse Width (µS)	Pulse 1-2 spacing (µS)	Pulse 2-3 spacing (µS)	Pulse Start(S)	Detection (1:yes; 0:no)
0	1	6	61.3			0.534768	1
1	3	12	53.1	1047	1052	1.039545	
2	2	9	91.8	1249		2.661993	
3	1	8	90.6			3.770001	
4	2	16	91.1	1885		4.303693	
5	2	11	79.7	1410		5.519975	
6	2	16	66.4	1943		6.761859	
7	2	7	83.5	1998		7.837206	
8	1	7	84.9			8.85322	
9	2	18	99.4	1302		9.245699	
10	2	17	99.1	1609		10.36392	
11	2	13	56	1433		11.26309	

## Bin5 Statistics 16

Trial #	Pulse	Chirp (MHz)	Pulse Width (µS)	Pulse 1-2 spacing (uS)	Pulse 2-3 spacing (uS)	Pulse Start(S)	Detection (1:yes; 0:no)
0	3	16	90	1293	1340	0.365798	1
1	2	9	64.4	1883		0.849507	
2	1	9	60			1.451578	
3	1	15	67.7			2.364212	
4	3	13	97.1	1075	1785	3.277225	
5	2	20	51.1	1177		3.949898	
6	1	9	59.9			4.247445	
7	1	12	69.9			4.76853	
8	2	14	55.7	1358		5.793391	
9	2	9	74.9	1139		6.059387	
10	1	9	57.4			7.260586	
11	2	14	61.5	1310		7.453691	
12	1	15	75.9			8.309246	
13	1	11	99.7			8.857469	
14	1	6	62.8			9.405904	
15	1	19	53.4			10.09859	
16	2	10	66.6	1083		11.04266	
17	2	8	73.5	1862		11.50681	

## Bin5 Statistics 17

Trial #	Pulse	Chirp (MHz)	Pulse Width (µS)	Pulse 1-2 spacing (uS)	Pulse 2-3 spacing (uS)	Pulse Start(S)	Detection (1:yes; 0:no)
0	1	20	50.3			1.307499	1
1	2	6	71.1	1547		2.482109	
2	2	11	96.4	1064		3.745915	
3	3	18	74.6	1045	1652	4.424683	
4	2	14	74.8	1325		5.451946	
5	2	8	51.2	1196		6.836395	
6	2	16	75	1392		8.617207	
7	2	10	77.1	1844		10.11466	
8	2	10	54.7	1019		11.98461	

## Bin5 Statistics 18

Trial #	Pulse	Chirp (MHz)	Pulse Width (µS)	Pulse 1-2 spacing (µS)	Pulse 2-3 spacing (µS)	Pulse Start(S)	Detection (1:yes; 0:no)
0	2	19	81.9	1676		0.906835	1
1	1	16	52.8			1.301423	
2	1	14	81			3.533518	
3	3	12	52.5	1541	1311	4.02953	
4	1	14	55.2			5.911581	
5	3	14	53.4	1200	1926	6.780233	
6	1	17	96.7			7.703416	
7	3	13	51.7	1998	1343	9.390809	
8	1	14	57.1			10.03109	
9	2	7	50.9	1295		11.45545	

## Bin5 Statistics 19

Trial #	Pulse	Chirp (MHz)	Pulse Width (µS)	Pulse 1-2 spacing (µS)	Pulse 2-3 spacing (µS)	Pulse Start(S)	Detection (1:yes; 0:no)
0	2	5	83.1	1135		0.196421	1
1	2	11	71	1727		1.2435	
2	2	6	59.9	1802		1.998617	
3	2	19	86.8	1202		2.702067	
4	3	10	95.6	1929	1926	3.598326	
5	1	17	65.5			4.129577	
6	1	11	77.3			5.183913	
7	1	9	52.3			5.713154	
8	3	8	81.1	1160	1531	6.949169	
9	2	8	98.2	1374		7.321429	
10	1	10	88			8.620996	
11	2	13	57.3	1040		9.205364	
12	2	8	72.3	1453		9.802664	
13	2	13	87	1764		11.1396	
14	2	7	82.3	1645		11.23715	



## Bin5 Statistics 20

Trial #	Pulse	Chirp (MHz)	Pulse Width (µS)	Pulse 1-2 spacing (uS)	Pulse 2-3 spacing (uS)	Pulse Start(S)	Detection (1:yes; 0:no)
0	1	16	89.4			0.405745	1
1	3	6	91.6	1041	1357	1.144938	
2	3	14	97.7	1192	1909	1.878834	
3	3	7	50.6	1719	1151	3.029102	
4	2	18	65	1537		3.833026	
5	2	20	52.7	1035		5.133634	
6	3	14	64.3	1206	1387	5.344495	
7	2	6	99.5	1227		6.591082	
8	3	6	95.5	1419	1034	7.043041	
9	3	13	68.3	1522	1802	7.934144	
10	3	10	85.8	1288	1815	9.076462	
11	1	15	99.8			9.611522	
12	3	16	80.9	1464	1744	11.03231	
13	2	9	68.9	1381		11.368	

## Bin5 Statistics 21

Trial #	Pulse	Chirp (MHz)	Pulse Width (µS)	Pulse 1-2 spacing (uS)	Pulse 2-3 spacing (uS)	Pulse Start(S)	Detection (1:yes; 0:no)
0	1	15	52.3			0.628359	1
1	1	11	57.1			1.670943	
2	1	14	76.7			2.326782	
3	2	8	77.4	1508		3.311374	
4	2	20	70.6	1869		4.146781	
5	1	20	73.1			5.007846	
6	2	18	84.1	1950		5.794298	
7	2	9	81	1833		6.723895	
8	2	17	66.2	1606		7.644403	
9	1	18	91.4			9.05771	
10	3	17	98.8	1394	1380	9.832748	
11	2	16	69.8	1969		11.04896	
12	1	16	84.5			11.19311	

## Bin5 Statistics 22

Trial #	Pulse	Chirp (MHz)	Pulse Width (µS)	Pulse 1-2 spacing (µS)	Pulse 2-3 spacing (µS)	Pulse Start(S)	Detection (1:yes; 0:no)
0	3	19	63.2	1241	1979	0.024614	1
1	1	15	76.1			1.007786	
2	1	18	68.3			1.685115	
3	1	20	70.9			2.110151	
4	2	6	76.4	1760		3.163122	
5	2	16	97	1234		3.61234	
6	2	6	64.5	1881		4.321106	
7	1	5	75.5			5.201218	
8	2	19	93.2	1405		5.333722	
9	1	11	67.7			6.160263	
10	3	17	88.6	1031	1664	6.687666	
11	1	11	62.8			7.648874	
12	1	18	56.5			8.535981	
13	2	8	52.5	1353		8.714102	
14	1	6	64.7			9.814755	
15	2	13	68.3	1053		10.60216	
16	1	16	67.4			10.71943	
17	2	15	79.5	1569		11.9471	

## Bin5 Statistics 23

Trial #	Pulse	Chirp (MHz)	Pulse Width (µS)	Pulse 1-2 spacing (µS)	Pulse 2-3 spacing (µS)	Pulse Start(S)	Detection (1:yes; 0:no)
0	2	17	60.2	1239		0.691316	1
1	3	14	50.6	1285	1401	1.918412	
2	1	14	68.7			3.09239	
3	2	18	66.1	1778		3.776425	
4	2	9	77.4	1915		4.96119	
5	2	19	94.6	1001		6.749445	
6	2	16	58	1434		7.205251	
7	2	18	91.5	1025		9.379147	
8	2	11	89.8	1854		9.678402	
9	2	15	94.6	1284		11.75709	

## Bin5 Statistics 24

Trial #	Pulse	Chirp (MHz)	Pulse Width (µS)	Pulse 1-2 spacing (uS)	Pulse 2-3 spacing (uS)	Pulse Start(S)	Detection (1:yes; 0:no)
0	3	9	92.6	1181	1591	0.290817	1
1	2	11	62.2	1908		0.905119	
2	2	9	52.1	1369		1.779548	
3	2	13	54.6	1287		2.668637	
4	1	7	97			3.089807	
5	1	17	76.2			4.068757	
6	2	5	73.2	1995		5.047356	
7	3	16	86.8	1624	1104	5.915802	
8	2	16	74.3	1276		6.127367	
9	2	11	80	1123		7.36504	
10	2	9	52.5	1353		8.031611	
11	2	13	92.6	1053		8.715708	
12	2	16	75.8	1348		9.043187	
13	2	11	82.3	1306		10.28631	
14	2	8	97.6	1562		10.95763	
15	2	13	96.2	1189		11.7168	

## Bin5 Statistics 25

Trial #	Pulse	Chirp (MHz)	Pulse Width (µS)	Pulse 1-2 spacing (uS)	Pulse 2-3 spacing (uS)	Pulse Start(S)	Detection (1:yes; 0:no)
0	2	6	68.3	1629		0.345392	1
1	3	12	87.1	1050	1877	1.263643	
2	1	15	87.6			2.57023	
3	2	8	67	1961		3.143532	
4	3	15	80.3	1668	1245	4.191675	
5	3	10	89.5	1346	1048	5.383487	
6	1	10	77.9			6.158224	
7	1	10	71.2			6.470663	
8	3	9	90.6	1001	1189	7.699805	
9	2	9	93.7	1116		8.649066	
10	2	12	58.1	1260		9.800431	
11	1	13	64.7			10.78315	
12	2	8	64.8	1218		11.9791	

## Bin5 Statistics 26

Trial #	Pulse	Chirp (MHz)	Pulse Width (µS)	Pulse 1-2 spacing (uS)	Pulse 2-3 spacing (uS)	Pulse Start(S)	Detection (1:yes; 0:no)
0	2	18	79.6	1351		0.594664	1
1	1	20	56			0.803466	
2	3	8	64.9	1072	1656	1.468738	
3	2	14	78.1	1336		2.763591	
4	1	18	52.5			3.287795	
5	2	7	66.7	1482		3.882282	
6	2	7	69.1	1132		4.354753	
7	2	7	56.4	1021		5.218612	
8	2	16	56	1604		5.744424	
9	2	9	64.9	1059		6.644989	
10	2	19	84.6	1188		7.731033	
11	3	13	55	1314	1701	8.171329	
12	2	10	92.2	1652		8.819275	
13	3	9	54.7	1389	1547	9.424995	
14	3	12	57.7	1141	1391	9.975317	
15	3	14	88.9	1575	1472	11.21858	
16	1	10	65.1			11.31664	

## Bin5 Statistics 27

Trial #	Pulse	Chirp (MHz)	Pulse Width (µS)	Pulse 1-2 spacing (uS)	Pulse 2-3 spacing (uS)	Pulse Start(S)	Detection (1:yes; 0:no)
0	2	10	71.3	1525		0.712141	1
1	2	13	78.1	1605		1.813376	
2	2	17	82.3	1012		3.493235	
3	3	13	51.7	1610	1932	4.464565	
4	3	6	73.5	1277	1500	5.493879	
5	2	16	61.2	1452		7.351178	
6	2	9	76	1532		8.855152	
7	2	15	50.3	1229		9.5692	
8	3	7	86.6	1545	1712	11.31207	

## Bin5 Statistics 28

Trial #	Pulse	Chirp (MHz)	Pulse Width (µS)	Pulse 1-2 spacing (µS)	Pulse 2-3 spacing (µS)	Pulse Start(S)	Detection (1:yes; 0:no)
0	2	6	57.1	1640		0.045894	1
1	3	6	65	1306	1230	1.948847	
2	1	15	84.6			2.930772	
3	3	15	96.8	1602	1523	3.488318	
4	2	6	56.3	1983		4.741826	
5	1	20	76.7			6.135553	
6	3	5	69	1125	1289	6.76271	
7	2	10	53.6	1502		8.575691	
8	3	13	93.4	1593	1676	8.834857	
9	1	17	54			10.87113	
10	3	11	64.6	1489	1812	10.98707	

## Bin5 Statistics 29

Trial #	Pulse	Chirp (MHz)	Pulse Width (µS)	Pulse 1-2 spacing (µS)	Pulse 2-3 spacing (µS)	Pulse Start(S)	Detection (1:yes; 0:no)
0	2	9	94.5	1492		0.101873	1
1	2	5	91.7	1524		1.003544	
2	2	11	65.1	1475		1.630464	
3	3	9	98.5	1293	1381	1.909511	
4	3	9	89.6	1076	1369	2.753944	
5	2	16	99.6	1809		3.503476	
6	2	9	89.2	1764		3.98883	
7	3	18	52.5	1475	1074	4.664943	
8	2	14	59.4	1724		5.129324	
9	3	16	69.3	1875	1434	5.991451	
10	3	12	86.6	1145	1327	6.632259	
11	2	19	69.8	1817		7.350033	
12	2	17	70	1239		7.9171	
13	3	20	86.9	1473	1380	8.644239	
14	1	16	68.9			9.364277	
15	3	13	84.6	1842	1520	9.897428	
16	3	7	74.1	1245	1922	10.43002	
17	2	14	66.7	1568		11.23733	
18	3	5	75.2	1323	1671	11.74051	

## Bin5 Statistics 30

Trial #	Pulse	Chirp (MHz)	Pulse Width (µS)	Pulse 1-2 spacing (µS)	Pulse 2-3 spacing (µS)	Pulse Start(S)	Detection (1:yes; 0:no)
0	2	16	89.6	1536		0.744891	1
1	3	6	91.1	1255	1130	1.242632	
2	1	6	91.7			2.343806	
3	1	9	80.2			2.720216	
4	2	9	74.8	1114		3.769712	
5	2	6	87.4	1248		4.658853	
6	2	13	55.5	1335		5.63496	
7	3	15	88.6	1200	1217	6.031833	
8	1	10	50.8			6.93369	
9	2	20	90.1	1268		8.045439	
10	3	16	57.5	1604	1851	8.61266	
11	1	13	52.2			10.02782	
12	2	12	95.1	1044		11.08198	
13	3	12	80.9	1886	1681	11.5611	

**Table-6 Radar Type 6 Statistical Performance**

Trial #	Fc (MHz)	Pulse /Burst	Pulse Width (µS)	PRI (µs)	Detection (1:yes; 0:no)	Hopping Sequence
1	5270	9	1	333	1	5620.0, 5643.0, 5296.0, 5295.0, 5625.0, 5489.0, 5653.0, 5359.0, 5613.0, 5407.0, 5382.0, 5252.0, 5676.0, 5626.0, 5543.0, 5378.0, 5420.0, 5715.0, 5345.0, 5492.0, 5357.0, 5567.0, 5349.0, 5609.0, 5618.0, 5385.0, 5269.0, 5284.0, 5666.0, 5516.0, 5631.0, 5404.0, 5360.0, 5431.0, 5513.0, 5485.0, 5574.0, 5555.0, 5328.0, 5563.0, 5591.0, 5695.0, 5424.0, 5703.0, 5456.0, 5619.0, 5259.0, 5467.0, 5491.0, 5348.0, 5678.0, 5281.0, 5696.0, 5339.0, 5673.0, 5384.0, 5531.0, 5312.0, 5694.0, 5302.0, 5396.0, 5580.0, 5566.0, 5436.0, 5449.0, 5374.0, 5642.0, 5587.0, 5565.0, 5399.0, 5640.0, 5473.0, 5304.0, 5717.0, 5612.0, 5706.0, 5503.0, 5411.0, 5355.0, 5526.0, 5597.0, 5512.0, 5509.0, 5632.0, 5508.0, 5578.0, 5641.0, 5344.0, 5365.0, 5460.0, 5709.0, 5291.0, 5528.0, 5624.0, 5533.0, 5654.0, 5575.0, 5261.0, 5593.0, 5542.0 (number of hits: 6)
2	5270	9	1	333	1	5425.0, 5460.0, 5451.0, 5576.0, 5532.0, 5393.0, 5506.0, 5475.0, 5381.0, 5634.0, 5525.0, 5618.0, 5424.0, 5401.0, 5445.0, 5328.0, 5354.0, 5252.0, 5695.0, 5517.0, 5710.0, 5664.0, 5514.0, 5332.0, 5538.0, 5627.0, 5455.0, 5584.0, 5300.0, 5298.0, 5493.0, 5612.0, 5648.0, 5653.0, 5461.0, 5536.0, 5411.0, 5673.0, 5639.0, 5293.0, 5499.0, 5459.0, 5409.0, 5347.0, 5659.0, 5382.0, 5415.0, 5638.0, 5467.0, 5671.0, 5701.0, 5294.0, 5580.0, 5555.0, 5334.0, 5400.0, 5629.0, 5321.0, 5255.0, 5721.0, 5550.0, 5377.0, 5343.0, 5264.0, 5280.0, 5443.0, 5360.0, 5665.0, 5430.0, 5268.0, 5351.0, 5658.0, 5279.0, 5635.0, 5544.0, 5463.0, 5579.0, 5327.0, 5386.0, 5592.0, 5470.0, 5269.0, 5500.0, 5613.0, 5689.0, 5518.0, 5602.0, 5437.0, 5272.0, 5476.0, 5404.0, 5274.0, 5572.0, 5392.0, 5420.0, 5422.0, 5533.0, 5450.0, 5266.0, 5479.0 (number of hits: 4)
3	5270	9	1	333	1	5338.0, 5518.0, 5260.0, 5627.0, 5328.0, 5398.0, 5358.0, 5462.0, 5558.0, 5670.0, 5287.0, 5451.0, 5385.0, 5616.0, 5613.0, 5470.0, 5312.0, 5706.0, 5324.0, 5341.0, 5329.0, 5632.0, 5654.0, 5259.0, 5650.0, 5364.0, 5322.0, 5531.0, 5274.0, 5603.0, 5335.0, 5664.0, 5378.0, 5450.0, 5597.0, 5332.0, 5628.0, 5533.0, 5262.0, 5656.0, 5379.0, 5715.0, 5473.0, 5393.0, 5592.0, 5488.0, 5456.0, 5611.0, 5557.0, 5640.0, 5320.0, 5679.0, 5436.0, 5586.0, 5425.0

						5447.0, 5566.0, 5400.0, 5375.0, 5637.0, 5344.0, 5620.0, 5345.0, 5538.0, 5429.0, 5426.0, 5311.0, 5306.0, 5497.0, 5683.0, 5495.0, 5605.0, 5392.0, 5507.0, 5484.0, 5574.0, 5655.0, 5465.0, 5330.0, 5331.0, 5583.0, 5251.0, 5509.0, 5619.0, 5390.0, 5310.0, 5389.0, 5691.0, 5252.0, 5716.0, 5702.0, 5326.0, 5452.0, 5540.0, 5467.0, 5673.0, 5490.0, 5263.0, 5371.0, 5717.0 (number of hits: 5)
4	5270	9	1	333	1	5509.0, 5367.0, 5420.0, 5394.0, 5267.0, 5417.0, 5467.0, 5665.0, 5650.0, 5481.0, 5254.0, 5696.0, 5631.0, 5465.0, 5527.0, 5426.0, 5545.0, 5363.0, 5718.0, 5400.0, 5565.0, 5410.0, 5577.0, 5539.0, 5453.0, 5680.0, 5677.0, 5572.0, 5511.0, 5265.0, 5683.0, 5610.0, 5548.0, 5697.0, 5306.0, 5575.0, 5522.0, 5287.0, 5414.0, 5519.0, 5278.0, 5384.0, 5364.0, 5529.0, 5634.0, 5639.0, 5332.0, 5449.0, 5621.0, 5644.0, 5269.0, 5331.0, 5358.0, 5563.0, 5421.0, 5661.0, 5543.0, 5352.0, 5533.0, 5553.0, 5489.0, 5385.0, 5441.0, 5347.0, 5408.0, 5623.0, 5549.0, 5378.0, 5418.0, 5311.0, 5348.0, 5580.0, 5318.0, 5713.0, 5506.0, 5560.0, 5576.0, 5622.0, 5368.0, 5434.0, 5597.0, 5307.0, 5382.0, 5456.0, 5288.0, 5537.0, 5723.0, 5643.0, 5430.0, 5478.0, 5404.0, 5409.0, 5647.0, 5571.0, 5473.0, 5462.0, 5722.0, 5447.0, 5554.0, 5423.0 (number of hits: 5)
5	5270	9	1	333	1	5552.0, 5403.0, 5594.0, 5680.0, 5576.0, 5583.0, 5470.0, 5634.0, 5380.0, 5275.0, 5455.0, 5679.0, 5724.0, 5539.0, 5615.0, 5372.0, 5344.0, 5523.0, 5618.0, 5410.0, 5430.0, 5504.0, 5676.0, 5299.0, 5510.0, 5265.0, 5260.0, 5353.0, 5655.0, 5332.0, 5443.0, 5708.0, 5513.0, 5308.0, 5303.0, 5548.0, 5400.0, 5341.0, 5428.0, 5525.0, 5290.0, 5486.0, 5315.0, 5294.0, 5574.0, 5669.0, 5319.0, 5564.0, 5621.0, 5377.0, 5550.0, 5670.0, 5639.0, 5632.0, 5709.0, 5613.0, 5274.0, 5585.0, 5692.0, 5475.0, 5473.0, 5719.0, 5702.0, 5648.0, 5653.0, 5616.0, 5376.0, 5381.0, 5526.0, 5354.0, 5460.0, 5311.0, 5607.0, 5279.0, 5374.0, 5657.0, 5263.0, 5358.0, 5394.0, 5334.0, 5438.0, 5440.0, 5656.0, 5281.0, 5489.0, 5689.0, 5582.0, 5595.0, 5313.0, 5458.0, 5599.0, 5675.0, 5347.0, 5436.0, 5611.0, 5405.0, 5431.0, 5287.0, 5538.0, 5579.0 (number of hits: 8)
6	5270	9	1	333	1	5419.0, 5476.0, 5382.0, 5293.0, 5488.0, 5469.0, 5297.0, 5490.0, 5386.0, 5528.0, 5684.0, 5420.0, 5483.0, 5716.0, 5546.0, 5470.0, 5275.0, 5636.0, 5372.0, 5699.0, 5689.0, 5563.0, 5277.0, 5463.0, 5457.0, 5288.0, 5360.0, 5567.0, 5722.0, 5434.0, 5254.0, 5608.0, 5359.0, 5425.0, 5556.0



						5299.0, 5480.0, 5498.0, 5580.0, 5358.0, 5670.0, 5598.0, 5390.0, 5423.0, 5466.0, 5427.0, 5555.0, 5458.0, 5548.0, 5705.0, 5633.0, 5412.0, 5370.0, 5350.0, 5620.0, 5281.0, 5574.0, 5331.0, 5451.0, 5508.0, 5351.0, 5392.0, 5352.0, 5330.0, 5435.0, 5609.0, 5306.0, 5345.0, 5325.0, 5539.0, 5367.0, 5378.0, 5532.0, 5270.0, 5614.0, 5559.0, 5557.0, 5589.0, 5544.0, 5521.0, 5394.0, 5562.0, 5309.0, 5533.0, 5381.0, 5304.0, 5375.0, 5399.0, 5255.0, 5713.0, 5718.0, 5329.0, 5444.0, 5720.0, 5430.0, 5565.0, 5278.0, 5656.0, 5428.0, 5355.0 (number of hits: 7)
7	5270	9	1	333	1	5703.0, 5312.0, 5398.0, 5401.0, 5595.0, 5533.0, 5581.0, 5499.0, 5356.0, 5360.0, 5396.0, 5631.0, 5648.0, 5710.0, 5494.0, 5322.0, 5678.0, 5506.0, 5656.0, 5498.0, 5649.0, 5517.0, 5402.0, 5513.0, 5670.0, 5558.0, 5537.0, 5685.0, 5694.0, 5268.0, 5326.0, 5630.0, 5616.0, 5495.0, 5589.0, 5334.0, 5646.0, 5586.0, 5251.0, 5335.0, 5653.0, 5667.0, 5318.0, 5429.0, 5651.0, 5572.0, 5704.0, 5313.0, 5723.0, 5323.0, 5695.0, 5342.0, 5428.0, 5452.0, 5333.0, 5569.0, 5574.0, 5276.0, 5403.0, 5545.0, 5547.0, 5471.0, 5477.0, 5434.0, 5270.0, 5274.0, 5507.0, 5463.0, 5280.0, 5610.0, 5412.0, 5632.0, 5339.0, 5382.0, 5516.0, 5407.0, 5582.0, 5713.0, 5570.0, 5362.0, 5627.0, 5615.0, 5271.0, 5370.0, 5511.0, 5686.0, 5584.0, 5504.0, 5311.0, 5277.0, 5436.0, 5440.0, 5395.0, 5492.0, 5565.0, 5562.0, 5571.0, 5550.0, 5491.0, 5663.0 (number of hits: 3)
8	5270	9	1	333	1	5520.0, 5721.0, 5352.0, 5416.0, 5682.0, 5265.0, 5320.0, 5630.0, 5526.0, 5279.0, 5403.0, 5422.0, 5332.0, 5307.0, 5535.0, 5463.0, 5545.0, 5317.0, 5491.0, 5451.0, 5631.0, 5345.0, 5442.0, 5337.0, 5398.0, 5722.0, 5397.0, 5445.0, 5647.0, 5530.0, 5510.0, 5488.0, 5420.0, 5311.0, 5555.0, 5449.0, 5376.0, 5308.0, 5261.0, 5532.0, 5611.0, 5657.0, 5298.0, 5252.0, 5380.0, 5454.0, 5636.0, 5392.0, 5674.0, 5572.0, 5282.0, 5411.0, 5610.0, 5543.0, 5593.0, 5271.0, 5601.0, 5439.0, 5395.0, 5381.0, 5529.0, 5443.0, 5627.0, 5523.0, 5467.0, 5334.0, 5544.0, 5359.0, 5304.0, 5459.0, 5492.0, 5412.0, 5472.0, 5643.0, 5417.0, 5623.0, 5285.0, 5709.0, 5648.0, 5710.0, 5560.0, 5620.0, 5570.0, 5685.0, 5344.0, 5597.0, 5415.0, 5625.0, 5289.0, 5617.0, 5351.0, 5277.0, 5465.0, 5552.0, 5542.0, 5697.0, 5370.0, 5718.0, 5714.0, 5431.0 (number of hits: 7)
9	5270	9	1	333	1	5565.0, 5268.0, 5628.0, 5557.0, 5687.0, 5271.0, 5288.0, 5255.0, 5324.0, 5405.0, 5527.0, 5569.0, 5264.0, 5474.0, 5668.0,

						5380.0, 5476.0, 5251.0, 5445.0, 5370.0, 5560.0, 5496.0, 5671.0, 5645.0, 5326.0, 5644.0, 5660.0, 5608.0, 5462.0, 5610.0, 5254.0, 5675.0, 5390.0, 5443.0, 5256.0, 5620.0, 5705.0, 5385.0, 5513.0, 5294.0, 5306.0, 5672.0, 5448.0, 5540.0, 5609.0, 5413.0, 5718.0, 5715.0, 5677.0, 5630.0, 5430.0, 5338.0, 5467.0, 5606.0, 5446.0, 5652.0, 5463.0, 5418.0, 5262.0, 5684.0, 5422.0, 5378.0, 5689.0, 5287.0, 5410.0, 5633.0, 5642.0, 5277.0, 5669.0, 5278.0, 5367.0, 5614.0, 5541.0, 5575.0, 5505.0, 5301.0, 5568.0, 5375.0, 5289.0, 5587.0, 5482.0, 5507.0, 5589.0, 5438.0, 5697.0, 5643.0, 5721.0, 5520.0, 5379.0, 5670.0, 5711.0, 5638.0, 5679.0, 5636.0, 5717.0, 5659.0, 5676.0, 5417.0, 5707.0, 5456.0 (number of hits: 6)
10	5270	9	1	333	1	5281.0, 5567.0, 5373.0, 5570.0, 5443.0, 5256.0, 5710.0, 5324.0, 5608.0, 5340.0, 5296.0, 5310.0, 5360.0, 5412.0, 5616.0, 5556.0, 5406.0, 5303.0, 5542.0, 5600.0, 5485.0, 5645.0, 5505.0, 5386.0, 5346.0, 5312.0, 5503.0, 5593.0, 5615.0, 5599.0, 5586.0, 5411.0, 5284.0, 5622.0, 5381.0, 5458.0, 5274.0, 5480.0, 5493.0, 5578.0, 5471.0, 5487.0, 5333.0, 5391.0, 5634.0, 5486.0, 5654.0, 5436.0, 5251.0, 5342.0, 5697.0, 5407.0, 5526.0, 5263.0, 5395.0, 5533.0, 5287.0, 5253.0, 5716.0, 5669.0, 5671.0, 5553.0, 5703.0, 5519.0, 5637.0, 5538.0, 5677.0, 5598.0, 5560.0, 5317.0, 5457.0, 5576.0, 5517.0, 5278.0, 5375.0, 5670.0, 5384.0, 5428.0, 5277.0, 5301.0, 5265.0, 5566.0, 5286.0, 5640.0, 5685.0, 5722.0, 5267.0, 5266.0, 5529.0, 5724.0, 5648.0, 5562.0, 5376.0, 5723.0, 5308.0, 5350.0, 5522.0, 5488.0, 5388.0, 5549.0 (number of hits: 8)
11	5270	9	1	333	1	5544.0, 5657.0, 5386.0, 5417.0, 5407.0, 5601.0, 5714.0, 5325.0, 5379.0, 5422.0, 5497.0, 5696.0, 5403.0, 5644.0, 5372.0, 5258.0, 5253.0, 5420.0, 5285.0, 5638.0, 5307.0, 5625.0, 5336.0, 5267.0, 5548.0, 5603.0, 5682.0, 5573.0, 5531.0, 5482.0, 5618.0, 5377.0, 5299.0, 5489.0, 5652.0, 5461.0, 5541.0, 5506.0, 5295.0, 5330.0, 5279.0, 5348.0, 5263.0, 5477.0, 5664.0, 5498.0, 5283.0, 5522.0, 5381.0, 5492.0, 5404.0, 5613.0, 5699.0, 5654.0, 5629.0, 5577.0, 5687.0, 5472.0, 5514.0, 5701.0, 5287.0, 5627.0, 5661.0, 5639.0, 5462.0, 5539.0, 5525.0, 5633.0, 5319.0, 5312.0, 5542.0, 5276.0, 5402.0, 5636.0, 5505.0, 5255.0, 5524.0, 5449.0, 5672.0, 5504.0, 5375.0, 5529.0, 5694.0, 5556.0, 5252.0, 5314.0, 5490.0, 5598.0, 5315.0, 5471.0, 5645.0, 5596.0, 5313.0, 5673.0, 5401.0, 5675.0, 5394.0, 5454.0, 5316.0, 5511.0

						(number of hits: 8 )
12	5270	9	1	333	1	5689.0, 5275.0, 5430.0, 5325.0, 5515.0, 5444.0, 5359.0, 5560.0, 5432.0, 5652.0, 5587.0, 5478.0, 5437.0, 5565.0, 5591.0, 5680.0, 5258.0, 5429.0, 5718.0, 5467.0, 5653.0, 5348.0, 5314.0, 5288.0, 5466.0, 5492.0, 5266.0, 5267.0, 5547.0, 5338.0, 5489.0, 5420.0, 5263.0, 5698.0, 5630.0, 5315.0, 5419.0, 5475.0, 5427.0, 5423.0, 5252.0, 5504.0, 5283.0, 5386.0, 5495.0, 5379.0, 5670.0, 5474.0, 5627.0, 5415.0, 5382.0, 5657.0, 5299.0, 5350.0, 5500.0, 5481.0, 5426.0, 5574.0, 5609.0, 5433.0, 5602.0, 5637.0, 5362.0, 5259.0, 5389.0, 5658.0, 5683.0, 5676.0, 5714.0, 5688.0, 5462.0, 5568.0, 5421.0, 5376.0, 5639.0, 5289.0, 5251.0, 5458.0, 5293.0, 5351.0, 5508.0, 5418.0, 5375.0, 5345.0, 5321.0, 5499.0, 5719.0, 5342.0, 5646.0, 5606.0, 5618.0, 5674.0, 5480.0, 5360.0, 5383.0, 5527.0, 5692.0, 5672.0, 5331.0, 5353.0
						(number of hits: 5 )
13	5270	9	1	333	1	5563.0, 5442.0, 5559.0, 5538.0, 5690.0, 5460.0, 5424.0, 5685.0, 5385.0, 5428.0, 5337.0, 5643.0, 5268.0, 5327.0, 5550.0, 5426.0, 5362.0, 5680.0, 5309.0, 5480.0, 5308.0, 5390.0, 5316.0, 5501.0, 5629.0, 5297.0, 5329.0, 5317.0, 5284.0, 5626.0, 5513.0, 5631.0, 5618.0, 5333.0, 5363.0, 5315.0, 5439.0, 5370.0, 5655.0, 5393.0, 5307.0, 5476.0, 5602.0, 5379.0, 5409.0, 5449.0, 5351.0, 5318.0, 5709.0, 5555.0, 5479.0, 5289.0, 5536.0, 5596.0, 5573.0, 5320.0, 5688.0, 5386.0, 5275.0, 5630.0, 5660.0, 5526.0, 5416.0, 5266.0, 5290.0, 5438.0, 5276.0, 5710.0, 5663.0, 5387.0, 5420.0, 5708.0, 5475.0, 5305.0, 5360.0, 5652.0, 5675.0, 5280.0, 5406.0, 5671.0, 5577.0, 5530.0, 5312.0, 5303.0, 5715.0, 5258.0, 5648.0, 5451.0, 5707.0, 5599.0, 5654.0, 5491.0, 5398.0, 5634.0, 5391.0, 5669.0, 5437.0, 5448.0, 5531.0, 5552.0
						(number of hits: 9 )
14	5270	9	1	333	1	5491.0, 5260.0, 5482.0, 5438.0, 5307.0, 5470.0, 5673.0, 5421.0, 5647.0, 5289.0, 5394.0, 5318.0, 5706.0, 5464.0, 5360.0, 5616.0, 5629.0, 5710.0, 5605.0, 5494.0, 5386.0, 5348.0, 5373.0, 5569.0, 5295.0, 5399.0, 5473.0, 5321.0, 5568.0, 5691.0, 5450.0, 5298.0, 5546.0, 5344.0, 5685.0, 5254.0, 5570.0, 5387.0, 5506.0, 5398.0, 5275.0, 5661.0, 5449.0, 5499.0, 5489.0, 5403.0, 5619.0, 5460.0, 5564.0, 5397.0, 5338.0, 5446.0, 5525.0, 5712.0, 5362.0, 5382.0, 5481.0, 5426.0, 5440.0, 5314.0, 5633.0, 5624.0, 5505.0, 5316.0, 5406.0, 5492.0, 5255.0, 5463.0, 5313.0, 5315.0, 5521.0, 5636.0, 5543.0, 5575.0, 5342.0, 5306.0, 5290.0, 5443.0, 5594.0, 5272.0,

						5412.0, 5301.0, 5536.0, 5415.0, 5312.0, 5544.0, 5654.0, 5705.0, 5467.0, 5662.0, 5565.0, 5420.0, 5555.0, 5610.0, 5496.0, 5670.0, 5622.0, 5308.0, 5328.0, 5303.0 (number of hits: 12 )
15	5270	9	1	333	1	5636.0, 5654.0, 5291.0, 5514.0, 5716.0, 5693.0, 5430.0, 5304.0, 5539.0, 5323.0, 5286.0, 5427.0, 5550.0, 5386.0, 5353.0, 5428.0, 5451.0, 5484.0, 5487.0, 5709.0, 5569.0, 5498.0, 5434.0, 5650.0, 5467.0, 5488.0, 5442.0, 5625.0, 5649.0, 5365.0, 5328.0, 5380.0, 5476.0, 5583.0, 5490.0, 5332.0, 5520.0, 5340.0, 5632.0, 5522.0, 5699.0, 5515.0, 5264.0, 5345.0, 5346.0, 5669.0, 5270.0, 5349.0, 5440.0, 5460.0, 5436.0, 5284.0, 5485.0, 5461.0, 5454.0, 5330.0, 5542.0, 5458.0, 5501.0, 5512.0, 5524.0, 5651.0, 5422.0, 5483.0, 5418.0, 5336.0, 5464.0, 5710.0, 5288.0, 5389.0, 5659.0, 5566.0, 5535.0, 5478.0, 5295.0, 5362.0, 5374.0, 5333.0, 5307.0, 5573.0, 5606.0, 5310.0, 5567.0, 5282.0, 5559.0, 5321.0, 5444.0, 5692.0, 5254.0, 5510.0, 5549.0, 5466.0, 5494.0, 5274.0, 5408.0, 5633.0, 5343.0, 5613.0, 5404.0, 5655.0 (number of hits: 7 )
16	5270	9	1	333	1	5570.0, 5540.0, 5288.0, 5665.0, 5523.0, 5347.0, 5371.0, 5411.0, 5412.0, 5479.0, 5319.0, 5504.0, 5296.0, 5711.0, 5589.0, 5548.0, 5260.0, 5439.0, 5642.0, 5388.0, 5709.0, 5661.0, 5362.0, 5696.0, 5569.0, 5470.0, 5262.0, 5667.0, 5706.0, 5714.0, 5537.0, 5298.0, 5327.0, 5264.0, 5415.0, 5333.0, 5670.0, 5253.0, 5292.0, 5626.0, 5437.0, 5477.0, 5623.0, 5695.0, 5432.0, 5519.0, 5322.0, 5631.0, 5556.0, 5397.0, 5484.0, 5611.0, 5386.0, 5511.0, 5335.0, 5606.0, 5458.0, 5400.0, 5660.0, 5497.0, 5628.0, 5472.0, 5710.0, 5492.0, 5348.0, 5455.0, 5385.0, 5591.0, 5469.0, 5558.0, 5516.0, 5489.0, 5405.0, 5664.0, 5655.0, 5572.0, 5358.0, 5396.0, 5306.0, 5325.0, 5326.0, 5356.0, 5576.0, 5512.0, 5433.0, 5555.0, 5498.0, 5311.0, 5712.0, 5383.0, 5290.0, 5476.0, 5284.0, 5295.0, 5510.0, 5453.0, 5514.0, 5688.0, 5357.0, 5280.0 (number of hits: 8 )
17	5270	9	1	333	1	5690.0, 5322.0, 5290.0, 5364.0, 5674.0, 5265.0, 5536.0, 5543.0, 5535.0, 5641.0, 5441.0, 5281.0, 5282.0, 5304.0, 5529.0, 5559.0, 5686.0, 5347.0, 5714.0, 5610.0, 5614.0, 5669.0, 5504.0, 5317.0, 5276.0, 5461.0, 5313.0, 5589.0, 5253.0, 5608.0, 5665.0, 5439.0, 5336.0, 5634.0, 5435.0, 5563.0, 5644.0, 5596.0, 5342.0, 5417.0, 5706.0, 5645.0, 5260.0, 5250.0, 5576.0, 5459.0, 5564.0, 5466.0, 5442.0, 5719.0, 5385.0, 5316.0, 5718.0, 5653.0, 5314.0, 5702.0, 5548.0, 5601.0, 5659.0, 5307.0,

						5593.0, 5334.0, 5403.0, 5264.0, 5409.0, 5703.0, 5636.0, 5654.0, 5520.0, 5705.0, 5261.0, 5280.0, 5562.0, 5670.0, 5668.0, 5272.0, 5326.0, 5547.0, 5335.0, 5527.0, 5324.0, 5587.0, 5345.0, 5359.0, 5308.0, 5355.0, 5289.0, 5278.0, 5331.0, 5286.0, 5502.0, 5534.0, 5492.0, 5383.0, 5412.0, 5382.0, 5448.0, 5539.0, 5370.0, 5401.0 (number of hits: 8)
18	5270	9	1	333	1	5665.0, 5296.0, 5457.0, 5370.0, 5639.0, 5335.0, 5643.0, 5599.0, 5469.0, 5565.0, 5527.0, 5431.0, 5338.0, 5253.0, 5587.0, 5692.0, 5702.0, 5323.0, 5361.0, 5660.0, 5571.0, 5481.0, 5634.0, 5674.0, 5503.0, 5616.0, 5716.0, 5390.0, 5627.0, 5512.0, 5534.0, 5354.0, 5285.0, 5451.0, 5373.0, 5332.0, 5396.0, 5312.0, 5621.0, 5475.0, 5614.0, 5685.0, 5569.0, 5372.0, 5349.0, 5700.0, 5586.0, 5722.0, 5550.0, 5610.0, 5556.0, 5484.0, 5720.0, 5644.0, 5574.0, 5547.0, 5605.0, 5448.0, 5694.0, 5293.0, 5478.0, 5679.0, 5460.0, 5517.0, 5433.0, 5690.0, 5393.0, 5317.0, 5308.0, 5303.0, 5626.0, 5316.0, 5426.0, 5640.0, 5440.0, 5567.0, 5470.0, 5647.0, 5276.0, 5352.0, 5509.0, 5553.0, 5320.0, 5608.0, 5283.0, 5261.0, 5695.0, 5282.0, 5516.0, 5507.0, 5297.0, 5623.0, 5666.0, 5491.0, 5548.0, 5709.0, 5617.0, 5598.0, 5387.0, 5398.0 (number of hits: 7)
19	5270	9	1	333	1	5724.0, 5252.0, 5316.0, 5262.0, 5721.0, 5433.0, 5297.0, 5705.0, 5656.0, 5555.0, 5325.0, 5406.0, 5415.0, 5515.0, 5654.0, 5270.0, 5424.0, 5553.0, 5657.0, 5549.0, 5324.0, 5309.0, 5362.0, 5320.0, 5473.0, 5540.0, 5441.0, 5661.0, 5418.0, 5284.0, 5685.0, 5535.0, 5543.0, 5348.0, 5347.0, 5354.0, 5422.0, 5416.0, 5380.0, 5539.0, 5474.0, 5600.0, 5396.0, 5291.0, 5403.0, 5447.0, 5498.0, 5387.0, 5476.0, 5637.0, 5619.0, 5558.0, 5339.0, 5699.0, 5626.0, 5692.0, 5250.0, 5713.0, 5333.0, 5506.0, 5443.0, 5280.0, 5579.0, 5358.0, 5467.0, 5279.0, 5565.0, 5264.0, 5516.0, 5350.0, 5278.0, 5481.0, 5266.0, 5466.0, 5706.0, 5720.0, 5414.0, 5672.0, 5323.0, 5610.0, 5377.0, 5289.0, 5708.0, 5274.0, 5717.0, 5417.0, 5645.0, 5665.0, 5283.0, 5580.0, 5575.0, 5492.0, 5296.0, 5551.0, 5254.0, 5452.0, 5605.0, 5349.0, 5370.0, 5344.0 (number of hits: 5)
20	5270	9	1	333	1	5412.0, 5345.0, 5686.0, 5286.0, 5417.0, 5581.0, 5375.0, 5317.0, 5613.0, 5693.0, 5689.0, 5623.0, 5506.0, 5318.0, 5297.0, 5687.0, 5503.0, 5590.0, 5449.0, 5691.0, 5411.0, 5380.0, 5552.0, 5308.0, 5435.0, 5676.0, 5593.0, 5542.0, 5535.0, 5592.0, 5455.0, 5537.0, 5272.0, 5678.0, 5265.0, 5640.0, 5710.0, 5723.0, 5341.0, 5355.0,

						5587.0, 5681.0, 5343.0, 5283.0, 5703.0, 5583.0, 5516.0, 5379.0, 5303.0, 5589.0, 5527.0, 5255.0, 5600.0, 5704.0, 5624.0, 5250.0, 5446.0, 5416.0, 5467.0, 5569.0, 5508.0, 5654.0, 5539.0, 5263.0, 5442.0, 5692.0, 5495.0, 5394.0, 5577.0, 5502.0, 5415.0, 5488.0, 5414.0, 5450.0, 5622.0, 5491.0, 5314.0, 5635.0, 5445.0, 5562.0, 5576.0, 5530.0, 5620.0, 5465.0, 5644.0, 5511.0, 5315.0, 5492.0, 5494.0, 5696.0, 5291.0, 5507.0, 5656.0, 5364.0, 5708.0, 5385.0, 5370.0, 5365.0, 5395.0, 5513.0 (number of hits: 6)
21	5270	9	1	333	1	5359.0, 5604.0, 5721.0, 5352.0, 5688.0, 5694.0, 5288.0, 5640.0, 5376.0, 5410.0, 5430.0, 5515.0, 5581.0, 5423.0, 5284.0, 5252.0, 5680.0, 5254.0, 5631.0, 5691.0, 5490.0, 5656.0, 5344.0, 5385.0, 5716.0, 5462.0, 5307.0, 5397.0, 5540.0, 5570.0, 5467.0, 5466.0, 5605.0, 5480.0, 5406.0, 5597.0, 5424.0, 5519.0, 5559.0, 5536.0, 5434.0, 5492.0, 5554.0, 5298.0, 5353.0, 5395.0, 5257.0, 5404.0, 5315.0, 5297.0, 5301.0, 5529.0, 5402.0, 5504.0, 5403.0, 5588.0, 5439.0, 5259.0, 5451.0, 5275.0, 5413.0, 5608.0, 5697.0, 5389.0, 5558.0, 5655.0, 5642.0, 5692.0, 5678.0, 5607.0, 5639.0, 5514.0, 5569.0, 5575.0, 5567.0, 5346.0, 5471.0, 5496.0, 5508.0, 5698.0, 5313.0, 5318.0, 5521.0, 5321.0, 5409.0, 5648.0, 5455.0, 5705.0, 5320.0, 5627.0, 5651.0, 5615.0, 5380.0, 5547.0, 5270.0, 5645.0, 5560.0, 5400.0, 5375.0, 5649.0 (number of hits: 6)
22	5270	9	1	333	1	5458.0, 5722.0, 5545.0, 5402.0, 5677.0, 5528.0, 5482.0, 5716.0, 5270.0, 5361.0, 5371.0, 5460.0, 5665.0, 5404.0, 5299.0, 5611.0, 5478.0, 5286.0, 5593.0, 5660.0, 5467.0, 5465.0, 5694.0, 5613.0, 5296.0, 5422.0, 5317.0, 5718.0, 5406.0, 5261.0, 5285.0, 5687.0, 5414.0, 5476.0, 5354.0, 5446.0, 5443.0, 5355.0, 5258.0, 5454.0, 5615.0, 5503.0, 5676.0, 5417.0, 5294.0, 5395.0, 5547.0, 5622.0, 5255.0, 5430.0, 5723.0, 5558.0, 5474.0, 5272.0, 5330.0, 5686.0, 5401.0, 5695.0, 5698.0, 5632.0, 5581.0, 5365.0, 5590.0, 5691.0, 5669.0, 5265.0, 5517.0, 5463.0, 5343.0, 5569.0, 5587.0, 5702.0, 5300.0, 5349.0, 5271.0, 5289.0, 5575.0, 5573.0, 5586.0, 5591.0, 5287.0, 5352.0, 5366.0, 5707.0, 5441.0, 5612.0, 5514.0, 5442.0, 5604.0, 5576.0, 5420.0, 5551.0, 5304.0, 5635.0, 5266.0, 5353.0, 5335.0, 5658.0, 5486.0, 5461.0 (number of hits: 9)
23	5270	9	1	333	1	5570.0, 5685.0, 5593.0, 5402.0, 5603.0, 5483.0, 5641.0, 5657.0, 5555.0, 5449.0, 5633.0, 5639.0, 5654.0, 5713.0, 5337.0, 5548.0, 5620.0, 5716.0, 5420.0, 5389.0

						5643.0, 5519.0, 5283.0, 5395.0, 5517.0, 5311.0, 5345.0, 5683.0, 5514.0, 5672.0, 5526.0, 5388.0, 5589.0, 5416.0, 5352.0, 5627.0, 5611.0, 5357.0, 5292.0, 5439.0, 5488.0, 5360.0, 5607.0, 5671.0, 5623.0, 5640.0, 5634.0, 5608.0, 5497.0, 5695.0, 5319.0, 5553.0, 5678.0, 5709.0, 5510.0, 5377.0, 5554.0, 5655.0, 5387.0, 5314.0, 5571.0, 5253.0, 5609.0, 5619.0, 5397.0, 5458.0, 5550.0, 5310.0, 5317.0, 5590.0, 5719.0, 5610.0, 5475.0, 5529.0, 5592.0, 5532.0, 5456.0, 5560.0, 5442.0, 5250.0, 5545.0, 5413.0, 5499.0, 5613.0, 5549.0, 5556.0, 5325.0, 5429.0, 5393.0, 5368.0, 5615.0, 5454.0, 5410.0, 5660.0, 5486.0, 5407.0, 5691.0, 5546.0, 5281.0, 5381.0 (number of hits: 4)
24	5270	9	1	333	1	5310.0, 5484.0, 5684.0, 5333.0, 5445.0, 5536.0, 5474.0, 5685.0, 5487.0, 5369.0, 5255.0, 5266.0, 5717.0, 5293.0, 5303.0, 5503.0, 5632.0, 5299.0, 5514.0, 5535.0, 5508.0, 5648.0, 5313.0, 5556.0, 5425.0, 5260.0, 5419.0, 5630.0, 5291.0, 5704.0, 5449.0, 5387.0, 5563.0, 5567.0, 5455.0, 5309.0, 5531.0, 5330.0, 5454.0, 5433.0, 5450.0, 5489.0, 5466.0, 5564.0, 5284.0, 5523.0, 5597.0, 5250.0, 5593.0, 5365.0, 5688.0, 5495.0, 5464.0, 5448.0, 5691.0, 5600.0, 5545.0, 5294.0, 5584.0, 5569.0, 5502.0, 5368.0, 5661.0, 5388.0, 5674.0, 5599.0, 5651.0, 5350.0, 5558.0, 5629.0, 5391.0, 5505.0, 5257.0, 5524.0, 5304.0, 5459.0, 5301.0, 5441.0, 5431.0, 5548.0, 5475.0, 5364.0, 5426.0, 5544.0, 5682.0, 5476.0, 5521.0, 5705.0, 5452.0, 5488.0, 5379.0, 5344.0, 5668.0, 5638.0, 5406.0, 5478.0, 5432.0, 5623.0, 5575.0, 5615.0 (number of hits: 10)
25	5270	9	1	333	1	5370.0, 5492.0, 5393.0, 5392.0, 5339.0, 5430.0, 5343.0, 5266.0, 5574.0, 5303.0, 5329.0, 5614.0, 5539.0, 5586.0, 5517.0, 5655.0, 5643.0, 5354.0, 5549.0, 5265.0, 5691.0, 5506.0, 5260.0, 5676.0, 5566.0, 5666.0, 5302.0, 5421.0, 5466.0, 5644.0, 5487.0, 5661.0, 5659.0, 5348.0, 5467.0, 5500.0, 5457.0, 5439.0, 5483.0, 5663.0, 5579.0, 5705.0, 5628.0, 5426.0, 5619.0, 5543.0, 5282.0, 5569.0, 5378.0, 5364.0, 5528.0, 5419.0, 5313.0, 5344.0, 5452.0, 5536.0, 5444.0, 5712.0, 5662.0, 5657.0, 5493.0, 5602.0, 5717.0, 5537.0, 5473.0, 5710.0, 5669.0, 5647.0, 5288.0, 5509.0, 5458.0, 5598.0, 5281.0, 5650.0, 5475.0, 5649.0, 5587.0, 5627.0, 5351.0, 5295.0, 5453.0, 5293.0, 5384.0, 5395.0, 5357.0, 5668.0, 5448.0, 5478.0, 5270.0, 5507.0, 5615.0, 5369.0, 5689.0, 5693.0, 5498.0, 5603.0, 5562.0, 5362.0, 5685.0, 5601.0 (number of hits: 6)

26	5270	9	1	333	1	5571.0, 5720.0, 5440.0, 5311.0, 5491.0, 5543.0, 5641.0, 5518.0, 5546.0, 5492.0, 5332.0, 5443.0, 5689.0, 5482.0, 5469.0, 5676.0, 5624.0, 5648.0, 5361.0, 5452.0, 5711.0, 5263.0, 5269.0, 5410.0, 5616.0, 5430.0, 5453.0, 5333.0, 5717.0, 5661.0, 5710.0, 5264.0, 5644.0, 5324.0, 5653.0, 5646.0, 5434.0, 5290.0, 5532.0, 5708.0, 5376.0, 5328.0, 5535.0, 5519.0, 5588.0, 5302.0, 5647.0, 5340.0, 5338.0, 5524.0, 5414.0, 5606.0, 5523.0, 5512.0, 5450.0, 5607.0, 5356.0, 5278.0, 5678.0, 5459.0, 5339.0, 5540.0, 5499.0, 5545.0, 5530.0, 5287.0, 5373.0, 5399.0, 5538.0, 5585.0, 5582.0, 5378.0, 5298.0, 5387.0, 5456.0, 5306.0, 5464.0, 5406.0, 5596.0, 5462.0, 5369.0, 5623.0, 5295.0, 5628.0, 5569.0, 5698.0, 5699.0, 5473.0, 5475.0, 5309.0, 5687.0, 5322.0, 5425.0, 5517.0, 5671.0, 5327.0, 5331.0, 5486.0, 5602.0, 5613.0 (number of hits: 8 )
27	5270	9	1	333	1	5530.0, 5486.0, 5506.0, 5494.0, 5455.0, 5679.0, 5338.0, 5474.0, 5463.0, 5642.0, 5352.0, 5477.0, 5631.0, 5319.0, 5645.0, 5602.0, 5576.0, 5424.0, 5665.0, 5289.0, 5545.0, 5481.0, 5668.0, 5478.0, 5377.0, 5458.0, 5310.0, 5518.0, 5444.0, 5552.0, 5468.0, 5517.0, 5626.0, 5376.0, 5430.0, 5252.0, 5306.0, 5395.0, 5314.0, 5656.0, 5593.0, 5353.0, 5692.0, 5397.0, 5260.0, 5685.0, 5360.0, 5479.0, 5529.0, 5265.0, 5554.0, 5283.0, 5447.0, 5320.0, 5438.0, 5591.0, 5421.0, 5538.0, 5317.0, 5675.0, 5495.0, 5662.0, 5690.0, 5673.0, 5435.0, 5404.0, 5661.0, 5414.0, 5405.0, 5624.0, 5694.0, 5499.0, 5501.0, 5335.0, 5693.0, 5632.0, 5550.0, 5285.0, 5329.0, 5452.0, 5682.0, 5442.0, 5281.0, 5489.0, 5543.0, 5476.0, 5608.0, 5345.0, 5257.0, 5490.0, 5583.0, 5469.0, 5585.0, 5427.0, 5594.0, 5584.0, 5722.0, 5383.0, 5296.0, 5537.0 (number of hits: 6 )
28	5270	9	1	333	1	5310.0, 5353.0, 5622.0, 5557.0, 5502.0, 5578.0, 5513.0, 5344.0, 5368.0, 5372.0, 5591.0, 5260.0, 5531.0, 5582.0, 5357.0, 5529.0, 5643.0, 5329.0, 5538.0, 5282.0, 5646.0, 5700.0, 5343.0, 5548.0, 5520.0, 5477.0, 5614.0, 5362.0, 5278.0, 5598.0, 5261.0, 5496.0, 5706.0, 5691.0, 5328.0, 5298.0, 5360.0, 5504.0, 5358.0, 5422.0, 5364.0, 5464.0, 5431.0, 5708.0, 5560.0, 5539.0, 5302.0, 5552.0, 5433.0, 5712.0, 5495.0, 5692.0, 5389.0, 5334.0, 5637.0, 5683.0, 5367.0, 5388.0, 5634.0, 5551.0, 5338.0, 5340.0, 5687.0, 5610.0, 5506.0, 5403.0, 5621.0, 5488.0, 5595.0, 5342.0, 5324.0, 5521.0, 5420.0, 5472.0, 5556.0, 5297.0, 5449.0, 5703.0, 5655.0, 5606.0, 5474.0, 5579.0, 5273.0, 5585.0, 5309.0,



						5500.0, 5702.0, 5386.0, 5532.0, 5592.0, 5377.0, 5526.0, 5288.0, 5624.0, 5490.0, 5296.0, 5530.0, 5626.0, 5414.0, 5473.0 (number of hits: 7)
29	5270	9	1	333	1	5547.0, 5499.0, 5323.0, 5339.0, 5476.0, 5618.0, 5337.0, 5358.0, 5628.0, 5563.0, 5674.0, 5506.0, 5281.0, 5680.0, 5257.0, 5366.0, 5461.0, 5531.0, 5601.0, 5299.0, 5711.0, 5525.0, 5456.0, 5450.0, 5634.0, 5587.0, 5480.0, 5675.0, 5321.0, 5288.0, 5684.0, 5293.0, 5665.0, 5631.0, 5599.0, 5569.0, 5513.0, 5352.0, 5365.0, 5433.0, 5353.0, 5295.0, 5564.0, 5468.0, 5542.0, 5535.0, 5505.0, 5600.0, 5290.0, 5514.0, 5381.0, 5478.0, 5501.0, 5419.0, 5469.0, 5572.0, 5496.0, 5647.0, 5568.0, 5370.0, 5612.0, 5671.0, 5656.0, 5294.0, 5578.0, 5660.0, 5604.0, 5282.0, 5409.0, 5712.0, 5342.0, 5645.0, 5632.0, 5494.0, 5664.0, 5510.0, 5373.0, 5431.0, 5687.0, 5637.0, 5320.0, 5277.0, 5576.0, 5424.0, 5700.0, 5387.0, 5640.0, 5400.0, 5384.0, 5439.0, 5403.0, 5678.0, 5537.0, 5515.0, 5673.0, 5301.0, 5465.0, 5326.0, 5704.0, 5683.0 (number of hits: 7)
30	5270	9	1	333	1	5714.0, 5631.0, 5671.0, 5575.0, 5255.0, 5459.0, 5448.0, 5333.0, 5712.0, 5580.0, 5652.0, 5687.0, 5454.0, 5502.0, 5610.0, 5308.0, 5267.0, 5492.0, 5642.0, 5587.0, 5399.0, 5422.0, 5405.0, 5667.0, 5531.0, 5623.0, 5329.0, 5376.0, 5274.0, 5313.0, 5285.0, 5398.0, 5550.0, 5463.0, 5558.0, 5401.0, 5451.0, 5349.0, 5599.0, 5677.0, 5304.0, 5592.0, 5629.0, 5591.0, 5607.0, 5439.0, 5443.0, 5318.0, 5593.0, 5654.0, 5609.0, 5638.0, 5542.0, 5337.0, 5518.0, 5563.0, 5569.0, 5633.0, 5560.0, 5377.0, 5621.0, 5601.0, 5649.0, 5353.0, 5632.0, 5641.0, 5335.0, 5416.0, 5268.0, 5532.0, 5613.0, 5444.0, 5254.0, 5360.0, 5611.0, 5374.0, 5685.0, 5715.0, 5537.0, 5284.0, 5433.0, 5485.0, 5352.0, 5327.0, 5344.0, 5529.0, 5585.0, 5534.0, 5527.0, 5723.0, 5501.0, 5651.0, 5363.0, 5586.0, 5617.0, 5457.0, 5706.0, 5478.0, 5381.0, 5496.0 (number of hits: 4)

**5550 MHz, 40 MHz Bandwidth**

<b>Radar Signal Type</b>	<b>Waveform/Trial Number</b>	<b>Detection (%)</b>	<b>Limit (%)</b>	<b>Pass/Fail</b>
<b>Type 1A/1B</b>	30	100 %	60%	Pass
<b>Type 2</b>	30	100 %	60%	Pass
<b>Type 3</b>	30	100 %	60%	Pass
<b>Type 4</b>	30	100 %	60%	Pass
<b>Aggregate (Type1 to 4)</b>	120	100 %	80%	Pass
<b>Type 5</b>	30	100 %	80%	Pass
<b>Type 6</b>	30	100 %	70%	Pass

Please refer to the following statistical tables:

**Table-1 Radar Type 1A/1B Statistical Performance**

<b>Trial #</b>	<b>Fc (MHz)</b>	<b>Pulse/Burst</b>	<b>Pulse Width (μS)</b>	<b>PRI (μs)</b>	<b>Detection (1:yes; 0:no)</b>
1	5550	62	1	858	1
2	5550	99	1	538	1
3	5550	86	1	618	1
4	5550	61	1	878	1
5	5550	63	1	838	1
6	5550	74	1	718	1
7	5550	68	1	778	1
8	5550	67	1	798	1
9	5550	95	1	558	1
10	5550	72	1	738	1
11	5550	58	1	918	1
12	5550	65	1	818	1
13	5550	18	1	3066	1
14	5550	102	1	518	1
15	5550	76	1	698	1
16	5550	39	1	1354	1
17	5550	37	1	1433	1
18	5550	43	1	1229	1
19	5550	45	1	1186	1
20	5550	28	1	1898	1
21	5550	28	1	1915	1
22	5550	23	1	2358	1
23	5550	18	1	2933	1
24	5550	74	1	722	1
25	5550	33	1	1630	1
26	5550	28	1	1935	1
27	5550	47	1	1146	1
28	5550	53	1	1010	1
29	5550	21	1	2638	1
30	5550	70	1	763	1
<b>Detection Percentage: 100 % (&gt;60%)</b>					

**Table-2 Radar Type 2 Statistical Performance**

<b>Trial #</b>	<b>Fc (MHz)</b>	<b>Pulse/Burst</b>	<b>Pulse Width (μS)</b>	<b>PRI (μs)</b>	<b>Detection (1:yes; 0:no)</b>
1	5550	27	2.5	197	1
2	5550	28	4.5	176	1
3	5550	27	2.4	219	1
4	5550	29	1.3	181	1
5	5550	26	4.5	153	1
6	5550	28	4.9	210	1
7	5550	23	4.5	155	1
8	5550	25	1.9	153	1
9	5550	26	2.7	159	1
10	5550	26	3.4	175	1
11	5550	25	2.4	217	1
12	5550	26	4.9	194	1
13	5550	24	2.6	156	1
14	5550	28	2.8	229	1
15	5550	29	1.4	164	1
16	5550	23	3.1	150	1
17	5550	25	3.6	213	1
18	5550	29	1.2	174	1
19	5550	25	3.6	151	1
20	5550	26	3.5	154	1
21	5550	25	3.4	167	1
22	5550	23	1.4	151	1
23	5550	25	1.7	150	1
24	5550	28	3.2	177	1
25	5550	27	2.5	220	1
26	5550	23	4.9	154	1
27	5550	29	2.2	225	1
28	5550	24	1.8	203	1
29	5550	28	4.3	213	1
30	5550	27	1.8	182	1
<b>Detection Percentage: 100 % (&gt;60%)</b>					

**Table-3 Radar Type 3 Statistical Performance**

<b>Trial #</b>	<b>Fc (MHz)</b>	<b>Pulse/Burst</b>	<b>Pulse Width (μS)</b>	<b>PRI (μs)</b>	<b>Detection (1:yes; 0:no)</b>
1	5550	18	6.8	447	1
2	5550	18	8.1	422	1
3	5550	16	6	277	1
4	5550	17	9.5	205	1
5	5550	16	9.5	466	1
6	5550	18	9.6	308	1
7	5550	17	9.1	377	1
8	5550	17	9	379	1
9	5550	17	7.1	299	1
10	5550	17	7	257	1
11	5550	16	8.3	437	1
12	5550	18	9.4	448	1
13	5550	18	7	310	1
14	5550	16	8.5	476	1
15	5550	16	7.4	224	1
16	5550	17	9.4	447	1
17	5550	16	7.7	267	1
18	5550	16	7.1	287	1
19	5550	16	7.2	351	1
20	5550	16	7.9	208	1
21	5550	18	7.8	360	1
22	5550	18	7.9	354	1
23	5550	17	8.4	215	1
24	5550	17	8	233	1
25	5550	17	7.4	220	1
26	5550	18	8.2	269	1
27	5550	18	9.4	468	1
28	5550	17	6.2	212	1
29	5550	18	8.5	406	1
30	5550	17	6.5	367	1
<b>Detection Percentage: 100 % (&gt;60%)</b>					

**Table-4 Radar Type 4 Statistical Performance**

<b>Trial #</b>	<b>Fc (MHz)</b>	<b>Pulse/Burst</b>	<b>Pulse Width (μS)</b>	<b>PRI (μs)</b>	<b>Detection (1:yes; 0:no)</b>
1	5550	12	14.3	358	1
2	5550	15	12	416	1
3	5550	14	19	363	1
4	5550	14	15.4	236	1
5	5550	12	17.2	440	1
6	5550	16	19.7	398	1
7	5550	12	17	482	1
8	5550	12	17.5	346	1
9	5550	12	11.3	280	1
10	5550	12	13.2	375	1
11	5550	16	18.2	312	1
12	5550	15	11.5	354	1
13	5550	12	16.7	435	1
14	5550	15	13.5	357	1
15	5550	14	19.6	248	1
16	5550	12	19	257	1
17	5550	16	18.5	310	1
18	5550	13	13	261	1
19	5550	16	11.8	337	1
20	5550	13	16	258	1
21	5550	13	15.6	230	1
22	5550	12	13	453	1
23	5550	14	17.7	311	1
24	5550	12	12.2	456	1
25	5550	14	13.8	281	1
26	5550	13	11	347	1
27	5550	13	11.7	210	1
28	5550	16	13.4	307	1
29	5550	12	15.8	476	1
30	5550	15	18.6	493	1
<b>Detection Percentage: 100 % (&gt;60%)</b>					

**Table-5 Radar Type 5 Statistical Performance**

Bin5 Statistics 1

Trial #	Pulse	Chirp (MHz)	Pulse Width (µS)	Pulse 1-2 spacing (uS)	Pulse 2-3 spacing (uS)	Pulse Start(S)	Detection (1:yes; 0:no)
0	2	18	57.4	1479		0.569578	1
1	2	10	89.2	1153		1.475261	
2	2	18	98	1727		2.316005	
3	1	17	71.4			2.429844	
4	2	18	63.3	1905		3.52511	
5	1	20	65.8			4.053872	
6	1	15	89.7			5.470225	
7	2	8	52.3	1305		6.213914	
8	2	7	92.9	1578		6.513719	
9	3	5	99.4	1380	1464	7.86896	
10	2	9	99.6	1666		8.179316	
11	2	14	61.1	1066		9.123754	
12	2	17	78.8	1320		9.775365	
13	2	18	97.7	1999		10.562338	
14	3	9	75	1903	1464	11.417531	

Bin5 Statistics 2

Trial #	Pulse	Chirp (MHz)	Pulse Width (µS)	Pulse 1-2 spacing (uS)	Pulse 2-3 spacing (uS)	Pulse Start(S)	Detection (1:yes; 0:no)
0	1	18	70.1			0.221082	1
1	3	16	75.4	1114	1851	1.366065	
2	2	13	82.7	1064		2.41751	
3	1	20	99.9			4.281588	
4	2	7	68.4	1798		5.244385	
5	2	11	61.1	1964		5.853356	
6	2	8	69.7	1983		7.292346	
7	3	7	80.5	1047	1501	7.739241	
8	3	11	90.8	1284	1690	9.047334	
9	1	9	61.5			10.192186	
10	2	7	72	1469		11.547415	

## Bin5 Statistics 3

Trial #	Pulse	Chirp (MHz)	Pulse Width (µS)	Pulse 1-2 spacing (uS)	Pulse 2-3 spacing (uS)	Pulse Start(S)	Detection (1:yes; 0:no)
0	3	14	52.1	1924	1971	0.79991	1
1	1	10	66.3			1.945275	
2	1	7	85.8			2.930344	
3	2	17	86.4	1051		3.001869	
4	3	5	68.2	1823	1520	4.1138	
5	2	15	85.9	1485		5.684052	
6	3	10	54	1208	1851	6.611834	
7	3	18	81.4	1705	1036	7.702889	
8	1	6	97.9			8.035763	
9	2	5	93.1	1436		9.512806	
10	2	18	98.6	1927		10.945435	
11	2	9	88.8	1083		11.463025	

## Bin5 Statistics 4

Trial #	Pulse	Chirp (MHz)	Pulse Width (µS)	Pulse 1-2 spacing (uS)	Pulse 2-3 spacing (uS)	Pulse Start(S)	Detection (1:yes; 0:no)
0	2	6	77.4	1863		0.019177	1
1	1	19	58.8			1.501381	
2	1	12	55.1			1.88448	
3	3	9	83.5	1123	1616	2.647478	
4	2	13	84.4	1048		3.642796	
5	1	15	92.7			4.329578	
6	3	9	58.6	1515	1874	5.139243	
7	1	20	64.9			6.242641	
8	1	12	82.5			6.570682	
9	1	13	87.8			7.592332	
10	2	18	73.2	1697		8.15394	
11	2	18	56.4	1214		9.066602	
12	1	11	66.8			9.687428	
13	2	11	59.2	1893		11.072452	
14	2	13	75	1546		11.301877	



## Bin5 Statistics 5

Trial #	Pulse	Chirp (MHz)	Pulse Width (µS)	Pulse 1-2 spacing (uS)	Pulse 2-3 spacing (uS)	Pulse Start(S)	Detection (1:yes; 0:no)
0	2	10	64.6	1669		0.194774	1
1	2	7	53.2	1527		2.034046	
2	1	13	52			3.970208	
3	2	11	81.8	1140		4.251069	
4	2	18	50.9	1759		5.698528	
5	3	13	85.3	1637	1211	7.29095	
6	2	18	80.8	1587		9.285288	
7	3	6	69.7	1205	1036	10.237077	
8	2	13	61.9	1451		11.043265	

## Bin5 Statistics 6

Trial #	Pulse	Chirp (MHz)	Pulse Width (µS)	Pulse 1-2 spacing (uS)	Pulse 2-3 spacing (uS)	Pulse Start(S)	Detection (1:yes; 0:no)
0	1	9	94.1			0.337181	1
1	2	8	80.2	1580		1.79294	
2	3	8	81.1	1133	1528	2.537108	
3	3	5	70.9	1908	1904	3.237056	
4	2	5	94.2	1746		4.416746	
5	2	17	56.1	1158		5.688822	
6	2	15	81.5	1155		6.002695	
7	2	10	97.9	1698		7.357661	
8	2	11	87.8	1542		8.488229	
9	3	5	58.4	1023	1921	9.732068	
10	2	7	67.9	1609		10.708328	
11	1	10	60.1			11.125816	

## Bin5 Statistics 7

Trial #	Pulse	Chirp (MHz)	Pulse Width (µS)	Pulse 1-2 spacing (uS)	Pulse 2-3 spacing (uS)	Pulse Start(S)	Detection (1:yes; 0:no)
0	2	10	69.4	1585		0.210599	1
1	1	11	80.8			1.830911	
2	3	7	69.8	1039	1420	2.274488	
3	1	11	91.1			3.251889	
4	2	13	82.4	1166		3.944131	
5	2	5	66.4	1282		4.698114	
6	1	14	60.8			6.40506	
7	1	10	72.5			6.675409	
8	3	12	89.5	1803	1926	7.765605	
9	2	13	67.8	1773		8.965401	
10	3	17	86.6	1524	1028	9.391687	
11	2	5	64.7	1156		10.54944	
12	2	7	84.1	1190		11.537165	

## Bin5 Statistics 8

Trial #	Pulse	Chirp (MHz)	Pulse Width (µS)	Pulse 1-2 spacing (uS)	Pulse 2-3 spacing (uS)	Pulse Start(S)	Detection (1:yes; 0:no)
0	1	10	53.4			0.777797	1
1	2	10	84.7	1428		1.604955	
2	2	10	89.9	1428		2.315656	
3	2	20	51.1	1527		3.611241	
4	1	5	65.2			4.821192	
5	3	13	93.6	1766	1070	5.833417	
6	3	9	66.2	1851	1513	6.947288	
7	3	15	84.9	1208	1689	7.718479	
8	2	20	67.6	1733		8.390775	
9	2	18	96.1	1633		9.132173	
10	3	12	56.8	1873	1024	10.348006	
11	3	13	74.3	1174	1377	11.744291	

## Bin5 Statistics 9

Trial #	Pulse	Chirp (MHz)	Pulse Width (µS)	Pulse 1-2 spacing (uS)	Pulse 2-3 spacing (uS)	Pulse Start(S)	Detection (1:yes; 0:no)
0	2	9	77.5	1092		0.218585	1
1	2	5	80.7	1271		1.406927	
2	3	6	88.2	1611	1053	2.279841	
3	1	14	72.2			2.688772	
4	2	11	62.1	1027		3.733413	
5	2	16	76.8	1681		4.145052	
6	2	8	91.2	1495		5.413053	
7	2	7	84.1	1049		6.114844	
8	2	9	72.7	1621		6.875804	
9	2	18	82.5	1368		7.812613	
10	2	10	67.9	1300		8.446695	
11	1	18	99.6			9.13553	
12	2	8	71.2	1450		10.327315	
13	2	14	62	1400		10.630534	
14	3	17	57.2	1330	1906	11.267201	

## Bin5 Statistics 10

Trial #	Pulse	Chirp (MHz)	Pulse Width (µS)	Pulse 1-2 spacing (uS)	Pulse 2-3 spacing (uS)	Pulse Start(S)	Detection (1:yes; 0:no)
0	2	16	77.5	1525		0.153758	1
1	2	18	86.5	1782		1.276794	
2	1	14	51.9			1.864183	
3	2	6	76	1838		2.280764	
4	2	13	63	1419		3.238059	
5	2	20	74.7	1597		3.917505	
6	2	12	60.4	1059		4.434453	
7	1	6	97.2			4.93292	
8	2	6	99.8	1723		5.369736	
9	3	6	68.7	1363	1537	6.590769	
10	2	17	67	1736		7.211451	
11	2	17	86.8	1211		7.630139	
12	1	8	80			8.325559	
13	2	19	57.8	1411		8.991878	
14	3	15	91.1	1578	1480	9.701781	
15	2	19	97.3	1260		10.038913	
16	1	16	54.7			11.014039	
17	2	5	54.5	1432		11.993502	

## Bin5 Statistics 11

Trial #	Pulse	Chirp (MHz)	Pulse Width (µS)	Pulse 1-2 spacing (uS)	Pulse 2-3 spacing (uS)	Pulse Start(S)	Detection (1:yes; 0:no)
0	3	11	98.1	1651	1483	1.092599	1
1	2	9	51.3	1212		1.555371	
2	2	14	56.3	1002		3.744252	
3	2	11	72.7	1505		4.838616	
4	2	10	70.9	1006		6.902566	
5	3	19	93.4	1548	1694	8.344698	
6	2	14	87.8	1067		9.274167	
7	2	5	79.7	1867		10.80586	

## Bin5 Statistics 12

Trial #	Pulse	Chirp (MHz)	Pulse Width (µS)	Pulse 1-2 spacing (uS)	Pulse 2-3 spacing (uS)	Pulse Start(S)	Detection (1:yes; 0:no)
0	2	11	81.9	1216		0.688536	1
1	1	11	87.1			1.770964	
2	1	6	97.8			2.882639	
3	1	6	64			3.979242	
4	3	15	74.9	1907	1862	4.769285	
5	2	8	78.2	1563		5.014129	
6	3	6	89.1	1783	1780	6.251554	
7	2	7	86.3	1427		7.12609	
8	2	14	72.5	1695		8.83013	
9	2	9	79.2	1677		9.716541	
10	3	14	81.5	1558	1325	10.023435	
11	3	13	88	1323	1210	11.795753	

## Bin5 Statistics 13

Trial #	Pulse	Chirp (MHz)	Pulse Width (µS)	Pulse 1-2 spacing (µS)	Pulse 2-3 spacing (µS)	Pulse Start(S)	Detection (1:yes; 0:no)
0	2	7	51.2	1098		0.050235	1
1	2	7	80.3	1585		1.670581	
2	3	15	93.8	1426	1290	3.691816	
3	3	18	98	1217	1780	4.241696	
4	3	6	82.8	1870	1928	6.566634	
5	1	18	52			7.380573	
6	2	13	87.4	1593		8.801828	
7	2	11	98.8	1182		9.667107	
8	2	6	66.3	1253		11.59678	

## Bin5 Statistics 14

Trial #	Pulse	Chirp (MHz)	Pulse Width (µS)	Pulse 1-2 spacing (µS)	Pulse 2-3 spacing (µS)	Pulse Start(S)	Detection (1:yes; 0:no)
0	3	20	99.7	1393	1061	0.371267	1
1	2	14	61.7	1720		0.823684	
2	2	7	55.3	1753		1.721682	
3	1	15	61			2.313425	
4	1	8	65.7			3.106936	
5	2	19	94	1282		3.83883	
6	3	13	82	1887	1294	4.030911	
7	2	9	74.6	1246		5.286852	
8	2	19	84	1393		5.637459	
9	2	11	55.1	1076		6.128028	
10	2	15	65.7	1712		6.697445	
11	3	11	69.9	1944	1962	7.905409	
12	2	7	97.7	1990		8.474816	
13	2	18	60	1754		8.970917	
14	2	9	75.7	1203		9.523058	
15	3	7	53	1227	1774	10.407277	
16	1	10	63			11.035688	
17	2	17	96.4	1778		11.367658	

## Bin5 Statistics 15

Trial #	Pulse	Chirp (MHz)	Pulse Width (µS)	Pulse 1-2 spacing (uS)	Pulse 2-3 spacing (uS)	Pulse Start(S)	Detection (1:yes; 0:no)
0	3	14	87.7	1786	1580	0.663316	1
1	2	7	90.3	1665		1.184365	
2	3	7	77.7	1693	1765	2.218226	
3	3	14	89.6	1902	1243	3.596711	
4	1	9	93.5			3.812291	
5	3	10	63.5	1740	1232	4.677711	
6	2	17	61.2	1135		5.891973	
7	1	15	98.6			6.57623	
8	1	7	70.4			7.498825	
9	2	15	81.2	1441		8.480673	
10	1	6	86.5			9.432348	
11	3	20	73.9	1042	1177	10.691955	
12	2	14	91.8	1613		11.249077	

## Bin5 Statistics 16

Trial #	Pulse	Chirp (MHz)	Pulse Width (µS)	Pulse 1-2 spacing (uS)	Pulse 2-3 spacing (uS)	Pulse Start(S)	Detection (1:yes; 0:no)
0	1	12	72.3			0.747008	1
1	2	15	97.9	1786		1.397013	
2	3	16	52.6	1554	1139	1.964385	
3	3	16	76.7	1369	1216	3.412368	
4	3	16	95.8	1337	1175	3.794808	
5	2	13	62.2	1081		5.380643	
6	1	11	69.5			6.331518	
7	2	16	80.7	1793		7.079502	
8	2	13	91.1	1981		8.147811	
9	1	19	87.8			8.951554	
10	1	15	52.2			9.422832	
11	2	7	77.8	1535		10.185727	
12	1	13	66.1			11.377606	

## Bin5 Statistics 17

Trial #	Pulse	Chirp (MHz)	Pulse Width (µS)	Pulse 1-2 spacing (µS)	Pulse 2-3 spacing (µS)	Pulse Start(S)	Detection (1:yes; 0:no)
0	1	9	89.5			1.0098	1
1	2	7	64.6	1440		1.181372	
2	2	14	59.7	1173		2.382297	
3	3	7	67.7	1203	1135	4.203947	
4	1	18	50.7			4.796254	
5	2	20	72.9	1696		6.407806	
6	1	6	67.7			6.666527	
7	2	9	70.9	1534		7.974888	
8	1	8	99.9			9.674954	
9	2	15	92.8	1928		10.746284	
10	2	9	96.7	1821		11.203263	

## Bin5 Statistics 18

Trial #	Pulse	Chirp (MHz)	Pulse Width (µS)	Pulse 1-2 spacing (µS)	Pulse 2-3 spacing (µS)	Pulse Start(S)	Detection (1:yes; 0:no)
0	2	15	52.7	1000		0.312462	1
1	2	10	61	1739		0.888608	
2	1	19	70.5			1.459428	
3	1	8	75			2.04266	
4	1	17	50.4			3.048202	
5	3	18	97.5	1504	1155	3.358351	
6	1	15	56.6			4.098611	
7	2	12	57	1209		5.308789	
8	3	11	94	1624	1004	5.411047	
9	2	7	82	1653		6.611456	
10	1	20	53			6.85824	
11	2	16	98.4	1036		7.907261	
12	2	12	65.6	1894		8.481214	
13	2	9	55.2	1062		9.011272	
14	2	6	65.2	1095		9.937857	
15	1	13	72.6			10.319782	
16	1	17	73.7			10.945764	
17	2	14	72.9	1222		11.708689	

## Bin5 Statistics 19

Trial #	Pulse	Chirp (MHz)	Pulse Width (µS)	Pulse 1-2 spacing (uS)	Pulse 2-3 spacing (uS)	Pulse Start(S)	Detection (1:yes; 0:no)
0	3	17	52.2	1188	1043	0.662548	1
1	2	17	67.2	1780		1.741197	
2	1	18	72.1			2.370104	
3	2	16	55.9	1465		3.556358	
4	2	17	82.8	1355		4.390686	
5	2	15	91.5	1349		5.554903	
6	2	10	95.7	1292		7.628344	
7	1	8	67.4			7.983446	
8	3	19	72.4	1493	1794	9.111545	
9	1	8	56.7			10.565471	
10	1	5	92.5			11.331714	

## Bin5 Statistics 20

Trial #	Pulse	Chirp (MHz)	Pulse Width (µS)	Pulse 1-2 spacing (uS)	Pulse 2-3 spacing (uS)	Pulse Start(S)	Detection (1:yes; 0:no)
0	2	19	68.1	1196		0.498388	1
1	3	11	57.5	1325	1180	1.737238	
2	2	16	57.4	1896		3.089808	
3	2	13	54.6	1533		3.949764	
4	2	20	97.6	1147		5.065633	
5	2	6	84.4	1427		5.807437	
6	2	18	51.6	1474		7.551306	
7	1	9	74			8.163647	
8	3	11	84.7	1112	1035	9.452528	
9	2	7	83	1173		10.59844	
10	2	20	89.8	1565		11.184737	



## Bin5 Statistics 21

Trial #	Pulse	Chirp (MHz)	Pulse Width (µS)	Pulse 1-2 spacing (uS)	Pulse 2-3 spacing (uS)	Pulse Start(S)	Detection (1:yes; 0:no)
0	2	8	72.2	1530		0.752466	1
1	3	13	70.8	1040	1737	1.676823	
2	3	5	82.5	1495	1372	3.350476	
3	3	19	81.5	1596	1391	5.110262	
4	3	17	97.3	1611	1788	5.572713	
5	2	18	64.3	1885		7.604712	
6	2	14	75.7	1458		8.619642	
7	2	17	65.7	1375		10.518525	
8	2	10	75.8	1833		10.744122	

## Bin5 Statistics 22

Trial #	Pulse	Chirp (MHz)	Pulse Width (µS)	Pulse 1-2 spacing (uS)	Pulse 2-3 spacing (uS)	Pulse Start(S)	Detection (1:yes; 0:no)
0	1	8	74.4			0.296275	1
1	2	16	89	1471		1.044808	
2	3	17	84.9	1675	1987	1.924561	
3	2	20	88.7	1306		3.118277	
4	1	6	93.3			4.061331	
5	3	7	93.9	1338	1637	4.690043	
6	2	13	59.2	1439		6.13549	
7	2	19	99.6	1757		6.575318	
8	2	17	93.6	1032		7.431319	
9	2	17	66.3	1281		8.78741	
10	3	8	98.2	1149	1485	9.632995	
11	2	6	63.2	1381		10.437013	
12	3	15	75.8	1867	1811	11.819537	

## Bin5 Statistics 23

Trial #	Pulse	Chirp (MHz)	Pulse Width (µS)	Pulse 1-2 spacing (uS)	Pulse 2-3 spacing (uS)	Pulse Start(S)	Detection (1:yes; 0:no)
0	2	12	63.2	1275		0.308812	1
1	2	9	73.8	1272		1.191559	
2	3	14	90.4	1131	1558	1.846862	
3	1	19	79.6			2.478661	
4	2	11	54	1669		2.997057	
5	1	19	65.5			3.976336	
6	1	7	62.3			4.498803	
7	2	11	81.9	1534		5.481493	
8	2	10	67	1879		6.264592	
9	2	18	67.2	1562		6.698948	
10	1	19	95.1			7.490095	
11	2	7	75.7	1646		8.225697	
12	1	5	86.7			9.01624	
13	1	11	84.8			9.760396	
14	2	14	96.3	1010		10.192047	
15	2	9	78.8	1147		11.084134	
16	2	16	86.5	1152		11.306581	

## Bin5 Statistics 24

Trial #	Pulse	Chirp (MHz)	Pulse Width (µS)	Pulse 1-2 spacing (uS)	Pulse 2-3 spacing (uS)	Pulse Start(S)	Detection (1:yes; 0:no)
0	3	13	62.7	1718	1739	0.232229	1
1	3	13	66.8	1772	1526	2.061225	
2	3	13	98.3	1085	1185	2.771426	
3	3	12	98.1	1173	1152	4.578366	
4	3	20	79.5	1322	1887	5.094235	
5	1	5	71.7			6.59279	
6	2	12	95.2	1037		7.507613	
7	2	15	84.1	1193		9.055772	
8	2	10	55.2	1946		10.141473	
9	2	15	63.6	1154		11.799966	

## Bin5 Statistics 25

Trial #	Pulse	Chirp (MHz)	Pulse Width (µS)	Pulse 1-2 spacing (µS)	Pulse 2-3 spacing (µS)	Pulse Start(S)	Detection (1:yes; 0:no)
0	3	6	51	1230	1199	0.399902	1
1	1	10	93.3			0.888859	
2	3	15	54.8	1067	1518	1.445179	
3	1	8	86			1.885816	
4	2	10	83.3	1054		2.528193	
5	2	11	53.4	1388		3.093826	
6	1	16	53.2			3.783708	
7	2	9	77.6	1451		4.235966	
8	2	18	71.9	1017		5.316313	
9	2	12	71.8	1300		5.422307	
10	2	20	87	1787		6.217912	
11	3	17	97.7	1514	1349	7.174923	
12	2	19	93.5	1091		7.305011	
13	1	14	50.4			8.024749	
14	2	11	54.9	1250		8.622589	
15	1	18	78.2			9.279098	
16	3	10	62.1	1152	1033	9.62829	
17	1	18	90.9			10.549796	
18	2	12	80.9	1048		11.052801	
19	2	11	71.6	1154		11.900498	

## Bin5 Statistics 26

Trial #	Pulse	Chirp (MHz)	Pulse Width (µS)	Pulse 1-2 spacing (µS)	Pulse 2-3 spacing (µS)	Pulse Start(S)	Detection (1:yes; 0:no)
0	2	7	70.3	1963		0.133516	1
1	1	7	77.7			2.331622	
2	2	15	51.5	1192		2.958868	
3	1	7	64.7			4.736602	
4	3	12	69.5	1736	1461	5.622273	
5	2	8	72.6	1084		7.495201	
6	2	19	60.9	1952		8.555184	
7	3	13	82.6	1850	1139	10.113038	
8	2	8	52.7	1070		10.904722	

## Bin5 Statistics 27

Trial #	Pulse	Chirp (MHz)	Pulse Width (µS)	Pulse 1-2 spacing (uS)	Pulse 2-3 spacing (uS)	Pulse Start(S)	Detection (1:yes; 0:no)
0	3	15	59.4	1381	1466	0.580674	1
1	1	12	75.5			0.997233	
2	2	12	83.5	1245		1.494392	
3	2	10	62.6	1552		2.445108	
4	2	7	88.9	1620		2.701983	
5	2	17	84.7	1053		3.471981	
6	2	19	51.5	1059		4.023721	
7	2	11	79.3	1566		4.79549	
8	3	11	58.6	1275	1732	5.733197	
9	2	10	85.5	1044		6.253783	
10	2	10	56.3	1044		7.185556	
11	1	18	67.4			7.79116	
12	3	17	98	1346	1172	8.499985	
13	1	10	66			9.184779	
14	2	11	60.3	1844		9.578786	
15	1	12	85			10.229376	
16	2	17	58.8	1449		11.052846	
17	2	17	63.3	1966		11.78031	

## Bin5 Statistics 28

Trial #	Pulse	Chirp (MHz)	Pulse Width (µS)	Pulse 1-2 spacing (uS)	Pulse 2-3 spacing (uS)	Pulse Start(S)	Detection (1:yes; 0:no)
0	3	11	65.5	1656	1121	0.045784	1
1	1	11	72.9			1.58527	
2	3	14	78.1	1748	1853	3.028083	
3	1	8	57.1			3.49747	
4	2	18	94	1825		4.539186	
5	2	8	74.7	1911		5.857265	
6	1	10	88			7.29745	
7	2	15	95.8	1258		8.631111	
8	2	10	85.8	1448		9.671991	
9	2	13	93.8	1056		10.555552	
10	1	14	51			11.548531	

## Bin5 Statistics 29

Trial #	Pulse	Chirp (MHz)	Pulse Width (µS)	Pulse 1-2 spacing (uS)	Pulse 2-3 spacing (uS)	Pulse Start(S)	Detection (1:yes; 0:no)
0	3	14	54.3	1680	1475	0.637204	1
1	1	9	64.2			1.410195	
2	1	7	83.6			2.934775	
3	2	19	77.3	1341		4.200452	
4	3	7	77.1	1054	1595	5.789711	
5	2	7	92.8	1361		7.117308	
6	2	10	70.8	1235		7.226461	
7	3	16	89	1001	1361	9.123431	
8	2	10	70.9	1917		9.77708	
9	2	7	73.5	1247		11.221718	

## Bin5 Statistics 30

Trial #	Pulse	Chirp (MHz)	Pulse Width (µS)	Pulse 1-2 spacing (uS)	Pulse 2-3 spacing (uS)	Pulse Start(S)	Detection (1:yes; 0:no)
0	2	14	66.3	1692		0.69578	1
1	1	6	60.7			1.280063	
2	1	13	97.8			1.768636	
3	3	14	87.3	1129	1584	2.614161	
4	1	19	87.2			2.941439	
5	2	8	95.3	1568		3.79828	
6	2	11	94.2	1765		4.271239	
7	3	14	86.4	1663	1554	5.634817	
8	3	19	91.2	1355	1153	5.897121	
9	2	17	76.2	1105		7.037017	
10	3	16	98.3	1701	1558	7.594503	
11	3	7	88	1410	1951	8.23716	
12	3	16	58.6	1313	1159	8.540367	
13	3	12	72.9	1609	1555	9.379878	
14	2	7	64	1629		10.534227	
15	2	7	80.9	1456		10.971948	
16	2	15	57.9	1934		11.524466	

**Table-6 Radar Type 6 Statistical Performance**

Trial #	Fc (MHz)	Pulse /Burst	Pulse Width (µS)	PRI (µs)	Detection (1:yes; 0:no)	Hopping Sequence
1	5550	9	1	333	1	5382.0, 5347.0, 5602.0, 5593.0, 5372.0, 5363.0, 5710.0, 5555.0, 5478.0, 5309.0, 5288.0, 5635.0, 5341.0, 5289.0, 5633.0, 5370.0, 5690.0, 5355.0, 5598.0, 5340.0, 5719.0, 5577.0, 5699.0, 5540.0, 5395.0, 5400.0, 5483.0, 5548.0, 5396.0, 5653.0, 5681.0, 5695.0, 5259.0, 5458.0, 5449.0, 5614.0, 5573.0, 5350.0, 5603.0, 5308.0, 5398.0, 5443.0, 5604.0, 5283.0, 5701.0, 5324.0, 5508.0, 5311.0, 5669.0, 5605.0, 5663.0, 5362.0, 5595.0, 5597.0, 5636.0, 5437.0, 5664.0, 5545.0, 5574.0, 5524.0, 5668.0, 5658.0, 5475.0, 5505.0, 5528.0, 5471.0, 5625.0, 5291.0, 5525.0, 5572.0, 5591.0, 5284.0, 5718.0, 5275.0, 5319.0, 5720.0, 5487.0, 5450.0, 5717.0, 5439.0, 5585.0, 5354.0, 5391.0, 5631.0, 5451.0, 5509.0, 5426.0, 5342.0, 5637.0, 5684.0, 5270.0, 5436.0, 5644.0, 5513.0, 5546.0, 5618.0, 5559.0, 5415.0, 5412.0, 5429.0 (number of hits: 6)
2	5550	9	1	333	1	5681.0, 5668.0, 5602.0, 5527.0, 5585.0, 5473.0, 5656.0, 5558.0, 5504.0, 5395.0, 5359.0, 5610.0, 5648.0, 5671.0, 5580.0, 5672.0, 5390.0, 5654.0, 5333.0, 5287.0, 5620.0, 5466.0, 5562.0, 5339.0, 5340.0, 5707.0, 5480.0, 5460.0, 5606.0, 5389.0, 5312.0, 5693.0, 5469.0, 5629.0, 5632.0, 5309.0, 5619.0, 5552.0, 5365.0, 5665.0, 5697.0, 5518.0, 5657.0, 5512.0, 5704.0, 5325.0, 5292.0, 5572.0, 5680.0, 5684.0, 5667.0, 5718.0, 5633.0, 5676.0, 5687.0, 5405.0, 5516.0, 5467.0, 5705.0, 5346.0, 5683.0, 5685.0, 5622.0, 5255.0, 5570.0, 5263.0, 5640.0, 5471.0, 5462.0, 5653.0, 5712.0, 5332.0, 5393.0, 5641.0, 5358.0, 5508.0, 5347.0, 5410.0, 5686.0, 5442.0, 5402.0, 5498.0, 5267.0, 5409.0, 5510.0, 5281.0, 5526.0, 5425.0, 5675.0, 5343.0, 5688.0, 5487.0, 5567.0, 5591.0, 5375.0, 5320.0, 5601.0, 5669.0, 5428.0, 5496.0 (number of hits: 4)
3	5550	9	1	333	1	5490.0, 5608.0, 5640.0, 5571.0, 5545.0, 5544.0, 5295.0, 5426.0, 5502.0, 5342.0, 5611.0, 5706.0, 5498.0, 5622.0, 5637.0, 5266.0, 5397.0, 5254.0, 5659.0, 5688.0, 5529.0, 5620.0, 5512.0, 5716.0, 5722.0, 5657.0, 5589.0, 5419.0, 5459.0, 5276.0, 5676.0, 5515.0, 5492.0, 5255.0, 5575.0, 5366.0, 5596.0, 5292.0, 5651.0, 5412.0, 5527.0, 5592.0, 5449.0, 5616.0, 5321.0, 5374.0, 5472.0, 5462.0, 5299.0, 5541.0, 5278.0, 5478.0, 5535.0, 5542.0, 5289.0, 5281.0, 5317.0, 5671.0, 5395.0, 5586.0

						5309.0, 5538.0, 5451.0, 5414.0, 5607.0, 5453.0, 5655.0, 5253.0, 5423.0, 5682.0, 5678.0, 5452.0, 5411.0, 5464.0, 5307.0, 5708.0, 5332.0, 5467.0, 5314.0, 5700.0, 5402.0, 5351.0, 5257.0, 5662.0, 5280.0, 5715.0, 5407.0, 5371.0, 5270.0, 5435.0, 5718.0, 5619.0, 5505.0, 5555.0, 5614.0, 5712.0, 5648.0, 5631.0, 5316.0, 5469.0 (number of hits: 7)
4	5550	9	1	333	1	5349.0, 5518.0, 5275.0, 5626.0, 5595.0, 5608.0, 5336.0, 5619.0, 5594.0, 5711.0, 5341.0, 5555.0, 5530.0, 5295.0, 5407.0, 5539.0, 5712.0, 5330.0, 5279.0, 5420.0, 5688.0, 5636.0, 5261.0, 5705.0, 5366.0, 5259.0, 5281.0, 5433.0, 5687.0, 5411.0, 5644.0, 5273.0, 5551.0, 5680.0, 5367.0, 5574.0, 5328.0, 5461.0, 5604.0, 5607.0, 5402.0, 5686.0, 5338.0, 5704.0, 5689.0, 5257.0, 5256.0, 5654.0, 5578.0, 5294.0, 5444.0, 5591.0, 5436.0, 5418.0, 5648.0, 5719.0, 5479.0, 5567.0, 5409.0, 5441.0, 5488.0, 5606.0, 5428.0, 5656.0, 5504.0, 5434.0, 5325.0, 5429.0, 5526.0, 5540.0, 5584.0, 5404.0, 5495.0, 5612.0, 5500.0, 5412.0, 5582.0, 5634.0, 5559.0, 5521.0, 5576.0, 5424.0, 5503.0, 5276.0, 5633.0, 5298.0, 5718.0, 5610.0, 5623.0, 5316.0, 5629.0, 5674.0, 5653.0, 5715.0, 5387.0, 5477.0, 5541.0, 5378.0, 5721.0, 5667.0 (number of hits: 3)
5	5550	9	1	333	1	5459.0, 5318.0, 5400.0, 5413.0, 5612.0, 5460.0, 5373.0, 5697.0, 5349.0, 5569.0, 5295.0, 5687.0, 5679.0, 5333.0, 5410.0, 5648.0, 5603.0, 5590.0, 5634.0, 5257.0, 5562.0, 5461.0, 5597.0, 5424.0, 5457.0, 5584.0, 5383.0, 5661.0, 5273.0, 5698.0, 5624.0, 5494.0, 5571.0, 5724.0, 5595.0, 5668.0, 5568.0, 5313.0, 5606.0, 5655.0, 5609.0, 5659.0, 5558.0, 5504.0, 5699.0, 5308.0, 5575.0, 5706.0, 5289.0, 5515.0, 5631.0, 5425.0, 5321.0, 5469.0, 5447.0, 5427.0, 5657.0, 5288.0, 5401.0, 5287.0, 5467.0, 5317.0, 5671.0, 5525.0, 5252.0, 5388.0, 5489.0, 5507.0, 5290.0, 5604.0, 5303.0, 5617.0, 5456.0, 5491.0, 5274.0, 5521.0, 5345.0, 5304.0, 5614.0, 5513.0, 5523.0, 5405.0, 5637.0, 5485.0, 5454.0, 5527.0, 5526.0, 5514.0, 5662.0, 5719.0, 5535.0, 5465.0, 5582.0, 5342.0, 5621.0, 5464.0, 5592.0, 5395.0, 5439.0, 5419.0 (number of hits: 9)
6	5550	9	1	333	1	5288.0, 5566.0, 5705.0, 5538.0, 5345.0, 5456.0, 5339.0, 5262.0, 5420.0, 5637.0, 5601.0, 5502.0, 5481.0, 5476.0, 5343.0, 5595.0, 5615.0, 5565.0, 5279.0, 5489.0, 5579.0, 5451.0, 5587.0, 5292.0, 5517.0, 5515.0, 5617.0, 5403.0, 5650.0, 5619.0, 5678.0, 5259.0, 5430.0, 5296.0, 5256.0, 5516.0, 5540.0, 5651.0, 5434.0, 5393.0,

						5548.0, 5402.0, 5594.0, 5472.0, 5559.0, 5453.0, 5324.0, 5263.0, 5488.0, 5700.0, 5448.0, 5529.0, 5499.0, 5251.0, 5689.0, 5333.0, 5634.0, 5528.0, 5544.0, 5313.0, 5663.0, 5673.0, 5518.0, 5539.0, 5714.0, 5460.0, 5411.0, 5322.0, 5520.0, 5408.0, 5352.0, 5409.0, 5414.0, 5462.0, 5641.0, 5367.0, 5501.0, 5567.0, 5433.0, 5320.0, 5317.0, 5364.0, 5463.0, 5703.0, 5471.0, 5530.0, 5546.0, 5305.0, 5443.0, 5573.0, 5534.0, 5407.0, 5265.0, 5346.0, 5389.0, 5394.0, 5470.0, 5583.0, 5397.0, 5557.0 (number of hits: 5)
7	5550	9	1	333	1	5688.0, 5381.0, 5718.0, 5690.0, 5555.0, 5315.0, 5655.0, 5627.0, 5532.0, 5303.0, 5632.0, 5506.0, 5266.0, 5526.0, 5609.0, 5415.0, 5643.0, 5393.0, 5370.0, 5430.0, 5338.0, 5276.0, 5498.0, 5268.0, 5398.0, 5425.0, 5345.0, 5604.0, 5620.0, 5262.0, 5290.0, 5270.0, 5383.0, 5626.0, 5353.0, 5641.0, 5661.0, 5554.0, 5259.0, 5402.0, 5476.0, 5517.0, 5685.0, 5426.0, 5534.0, 5548.0, 5373.0, 5584.0, 5258.0, 5317.0, 5706.0, 5313.0, 5671.0, 5516.0, 5689.0, 5648.0, 5375.0, 5495.0, 5545.0, 5565.0, 5533.0, 5723.0, 5253.0, 5694.0, 5372.0, 5428.0, 5380.0, 5464.0, 5280.0, 5440.0, 5486.0, 5631.0, 5524.0, 5659.0, 5478.0, 5585.0, 5538.0, 5421.0, 5272.0, 5406.0, 5360.0, 5544.0, 5392.0, 5376.0, 5722.0, 5435.0, 5556.0, 5269.0, 5311.0, 5422.0, 5320.0, 5613.0, 5576.0, 5668.0, 5612.0, 5255.0, 5327.0, 5467.0, 5610.0, 5301.0 (number of hits: 5)
8	5550	9	1	333	1	5286.0, 5681.0, 5615.0, 5488.0, 5310.0, 5554.0, 5271.0, 5531.0, 5493.0, 5450.0, 5585.0, 5483.0, 5655.0, 5496.0, 5634.0, 5377.0, 5560.0, 5392.0, 5611.0, 5307.0, 5538.0, 5456.0, 5469.0, 5517.0, 5316.0, 5311.0, 5298.0, 5575.0, 5672.0, 5424.0, 5448.0, 5309.0, 5532.0, 5374.0, 5367.0, 5452.0, 5673.0, 5475.0, 5653.0, 5656.0, 5559.0, 5412.0, 5657.0, 5346.0, 5679.0, 5344.0, 5518.0, 5403.0, 5652.0, 5711.0, 5573.0, 5435.0, 5699.0, 5486.0, 5394.0, 5376.0, 5567.0, 5300.0, 5441.0, 5363.0, 5401.0, 5479.0, 5370.0, 5610.0, 5419.0, 5505.0, 5494.0, 5444.0, 5462.0, 5402.0, 5443.0, 5393.0, 5471.0, 5387.0, 5391.0, 5395.0, 5312.0, 5324.0, 5388.0, 5259.0, 5716.0, 5535.0, 5398.0, 5613.0, 5287.0, 5449.0, 5601.0, 5428.0, 5591.0, 5595.0, 5459.0, 5326.0, 5501.0, 5366.0, 5379.0, 5330.0, 5266.0, 5530.0, 5436.0, 5654.0 (number of hits: 9)
9	5550	9	1	333	1	5411.0, 5459.0, 5301.0, 5273.0, 5300.0, 5543.0, 5370.0, 5343.0, 5338.0, 5599.0, 5582.0, 5270.0, 5489.0, 5486.0, 5438.0, 5535.0, 5291.0, 5592.0, 5715.0, 5496.0



						5441.0, 5497.0, 5560.0, 5586.0, 5400.0, 5371.0, 5600.0, 5420.0, 5694.0, 5682.0, 5254.0, 5528.0, 5577.0, 5499.0, 5288.0, 5602.0, 5547.0, 5285.0, 5295.0, 5381.0, 5325.0, 5520.0, 5714.0, 5636.0, 5583.0, 5688.0, 5465.0, 5576.0, 5392.0, 5278.0, 5297.0, 5310.0, 5607.0, 5482.0, 5481.0, 5701.0, 5357.0, 5470.0, 5409.0, 5680.0, 5530.0, 5395.0, 5443.0, 5361.0, 5677.0, 5631.0, 5290.0, 5382.0, 5628.0, 5644.0, 5427.0, 5256.0, 5541.0, 5695.0, 5444.0, 5503.0, 5314.0, 5488.0, 5405.0, 5263.0, 5690.0, 5312.0, 5498.0, 5267.0, 5284.0, 5564.0, 5556.0, 5711.0, 5323.0, 5410.0, 5513.0, 5397.0, 5587.0, 5674.0, 5548.0, 5512.0, 5494.0, 5523.0, 5350.0, 5581.0 (number of hits: 11)
10	5550	9	1	333	1	5363.0, 5442.0, 5591.0, 5379.0, 5267.0, 5266.0, 5343.0, 5553.0, 5425.0, 5457.0, 5705.0, 5671.0, 5527.0, 5529.0, 5720.0, 5290.0, 5607.0, 5484.0, 5605.0, 5508.0, 5340.0, 5356.0, 5270.0, 5628.0, 5492.0, 5668.0, 5293.0, 5498.0, 5588.0, 5544.0, 5370.0, 5282.0, 5518.0, 5590.0, 5676.0, 5307.0, 5470.0, 5268.0, 5586.0, 5463.0, 5581.0, 5413.0, 5252.0, 5371.0, 5445.0, 5618.0, 5517.0, 5273.0, 5521.0, 5715.0, 5572.0, 5347.0, 5331.0, 5515.0, 5504.0, 5251.0, 5642.0, 5631.0, 5490.0, 5689.0, 5373.0, 5597.0, 5575.0, 5559.0, 5530.0, 5375.0, 5666.0, 5296.0, 5546.0, 5416.0, 5332.0, 5260.0, 5353.0, 5417.0, 5608.0, 5451.0, 5503.0, 5696.0, 5657.0, 5305.0, 5604.0, 5327.0, 5491.0, 5436.0, 5276.0, 5380.0, 5522.0, 5717.0, 5408.0, 5321.0, 5703.0, 5535.0, 5579.0, 5351.0, 5693.0, 5550.0, 5583.0, 5646.0, 5701.0, 5398.0 (number of hits: 5)
11	5550	9	1	333	1	5622.0, 5313.0, 5343.0, 5599.0, 5635.0, 5646.0, 5307.0, 5403.0, 5530.0, 5361.0, 5459.0, 5431.0, 5382.0, 5321.0, 5580.0, 5257.0, 5440.0, 5482.0, 5596.0, 5286.0, 5292.0, 5362.0, 5698.0, 5438.0, 5616.0, 5386.0, 5411.0, 5340.0, 5644.0, 5669.0, 5645.0, 5450.0, 5272.0, 5682.0, 5705.0, 5380.0, 5464.0, 5656.0, 5376.0, 5413.0, 5471.0, 5615.0, 5508.0, 5597.0, 5641.0, 5519.0, 5709.0, 5255.0, 5351.0, 5608.0, 5626.0, 5535.0, 5665.0, 5260.0, 5420.0, 5433.0, 5536.0, 5353.0, 5648.0, 5456.0, 5423.0, 5556.0, 5485.0, 5542.0, 5584.0, 5680.0, 5638.0, 5500.0, 5688.0, 5514.0, 5579.0, 5672.0, 5258.0, 5296.0, 5510.0, 5722.0, 5452.0, 5553.0, 5274.0, 5624.0, 5623.0, 5700.0, 5269.0, 5526.0, 5504.0, 5497.0, 5643.0, 5525.0, 5418.0, 5344.0, 5346.0, 5491.0, 5541.0, 5610.0, 5546.0, 5540.0, 5466.0, 5251.0, 5424.0, 5473.0 (number of hits: 5)

12	5550	9	1	333	1	5547.0, 5531.0, 5679.0, 5536.0, 5482.0, 5452.0, 5568.0, 5684.0, 5341.0, 5375.0, 5619.0, 5631.0, 5584.0, 5410.0, 5402.0, 5628.0, 5357.0, 5277.0, 5610.0, 5449.0, 5439.0, 5699.0, 5589.0, 5616.0, 5666.0, 5484.0, 5471.0, 5558.0, 5494.0, 5312.0, 5654.0, 5553.0, 5454.0, 5546.0, 5676.0, 5398.0, 5385.0, 5417.0, 5268.0, 5485.0, 5287.0, 5529.0, 5416.0, 5301.0, 5379.0, 5262.0, 5698.0, 5265.0, 5406.0, 5339.0, 5593.0, 5340.0, 5404.0, 5334.0, 5389.0, 5311.0, 5279.0, 5681.0, 5419.0, 5285.0, 5380.0, 5673.0, 5618.0, 5579.0, 5565.0, 5430.0, 5691.0, 5633.0, 5352.0, 5543.0, 5658.0, 5623.0, 5305.0, 5527.0, 5288.0, 5492.0, 5414.0, 5721.0, 5707.0, 5516.0, 5716.0, 5470.0, 5717.0, 5322.0, 5293.0, 5501.0, 5337.0, 5434.0, 5266.0, 5358.0, 5714.0, 5317.0, 5453.0, 5561.0, 5656.0, 5276.0, 5467.0, 5281.0, 5549.0, 5611.0 (number of hits: 8 )
13	5550	9	1	333	1	5674.0, 5275.0, 5591.0, 5589.0, 5399.0, 5356.0, 5641.0, 5343.0, 5299.0, 5644.0, 5600.0, 5720.0, 5529.0, 5280.0, 5458.0, 5277.0, 5685.0, 5684.0, 5721.0, 5338.0, 5585.0, 5701.0, 5587.0, 5395.0, 5689.0, 5664.0, 5553.0, 5657.0, 5516.0, 5582.0, 5595.0, 5346.0, 5407.0, 5388.0, 5404.0, 5273.0, 5691.0, 5575.0, 5364.0, 5480.0, 5634.0, 5468.0, 5442.0, 5508.0, 5569.0, 5565.0, 5310.0, 5500.0, 5262.0, 5476.0, 5328.0, 5300.0, 5449.0, 5482.0, 5268.0, 5658.0, 5326.0, 5457.0, 5373.0, 5571.0, 5380.0, 5654.0, 5702.0, 5348.0, 5660.0, 5626.0, 5659.0, 5375.0, 5717.0, 5618.0, 5631.0, 5506.0, 5454.0, 5381.0, 5719.0, 5655.0, 5629.0, 5475.0, 5352.0, 5511.0, 5564.0, 5282.0, 5576.0, 5462.0, 5723.0, 5645.0, 5426.0, 5679.0, 5687.0, 5505.0, 5413.0, 5370.0, 5298.0, 5607.0, 5542.0, 5667.0, 5428.0, 5707.0, 5406.0, 5671.0 (number of hits: 4 )
14	5550	9	1	333	1	5551.0, 5635.0, 5325.0, 5445.0, 5631.0, 5478.0, 5516.0, 5504.0, 5500.0, 5392.0, 5585.0, 5709.0, 5542.0, 5609.0, 5530.0, 5556.0, 5250.0, 5280.0, 5601.0, 5310.0, 5447.0, 5633.0, 5663.0, 5263.0, 5716.0, 5330.0, 5646.0, 5603.0, 5499.0, 5571.0, 5575.0, 5449.0, 5396.0, 5714.0, 5440.0, 5651.0, 5269.0, 5335.0, 5424.0, 5505.0, 5347.0, 5558.0, 5410.0, 5471.0, 5268.0, 5592.0, 5525.0, 5722.0, 5638.0, 5497.0, 5261.0, 5664.0, 5688.0, 5492.0, 5527.0, 5495.0, 5597.0, 5332.0, 5271.0, 5548.0, 5422.0, 5512.0, 5614.0, 5312.0, 5345.0, 5353.0, 5258.0, 5461.0, 5270.0, 5616.0, 5672.0, 5324.0, 5255.0, 5554.0, 5634.0, 5684.0, 5308.0, 5487.0, 5708.0, 5719.0, 5479.0, 5696.0, 5540.0, 5385.0, 5435.0,

						5547.0, 5596.0, 5511.0, 5337.0, 5317.0, 5675.0, 5442.0, 5641.0, 5438.0, 5498.0, 5395.0, 5619.0, 5654.0, 5678.0, 5291.0 (number of hits: 4)
15	5550	9	1	333	1	5467.0, 5542.0, 5717.0, 5608.0, 5264.0, 5656.0, 5529.0, 5612.0, 5707.0, 5265.0, 5650.0, 5312.0, 5353.0, 5594.0, 5516.0, 5464.0, 5475.0, 5438.0, 5251.0, 5257.0, 5355.0, 5316.0, 5639.0, 5665.0, 5709.0, 5654.0, 5336.0, 5406.0, 5404.0, 5482.0, 5629.0, 5421.0, 5426.0, 5258.0, 5697.0, 5487.0, 5450.0, 5699.0, 5556.0, 5663.0, 5695.0, 5307.0, 5452.0, 5480.0, 5341.0, 5573.0, 5296.0, 5269.0, 5495.0, 5547.0, 5669.0, 5338.0, 5481.0, 5706.0, 5531.0, 5365.0, 5492.0, 5641.0, 5308.0, 5318.0, 5527.0, 5356.0, 5391.0, 5683.0, 5664.0, 5506.0, 5339.0, 5723.0, 5374.0, 5320.0, 5439.0, 5383.0, 5390.0, 5515.0, 5453.0, 5583.0, 5273.0, 5470.0, 5672.0, 5499.0, 5382.0, 5592.0, 5711.0, 5342.0, 5721.0, 5558.0, 5634.0, 5331.0, 5544.0, 5671.0, 5261.0, 5301.0, 5477.0, 5546.0, 5616.0, 5513.0, 5432.0, 5618.0, 5512.0, 5651.0 (number of hits: 5)
16	5550	9	1	333	1	5398.0, 5466.0, 5477.0, 5251.0, 5685.0, 5638.0, 5490.0, 5664.0, 5495.0, 5653.0, 5377.0, 5715.0, 5336.0, 5624.0, 5422.0, 5442.0, 5613.0, 5357.0, 5487.0, 5629.0, 5671.0, 5269.0, 5607.0, 5555.0, 5314.0, 5459.0, 5374.0, 5270.0, 5481.0, 5719.0, 5690.0, 5615.0, 5324.0, 5596.0, 5564.0, 5301.0, 5578.0, 5592.0, 5334.0, 5367.0, 5429.0, 5355.0, 5453.0, 5423.0, 5519.0, 5502.0, 5438.0, 5510.0, 5348.0, 5388.0, 5524.0, 5522.0, 5337.0, 5445.0, 5278.0, 5518.0, 5347.0, 5553.0, 5267.0, 5588.0, 5489.0, 5394.0, 5250.0, 5484.0, 5478.0, 5274.0, 5573.0, 5628.0, 5475.0, 5712.0, 5433.0, 5684.0, 5643.0, 5698.0, 5569.0, 5646.0, 5292.0, 5345.0, 5562.0, 5460.0, 5667.0, 5706.0, 5599.0, 5330.0, 5391.0, 5420.0, 5365.0, 5282.0, 5535.0, 5380.0, 5559.0, 5645.0, 5661.0, 5349.0, 5262.0, 5265.0, 5621.0, 5686.0, 5378.0, 5392.0 (number of hits: 3)
17	5550	9	1	333	1	5379.0, 5421.0, 5584.0, 5645.0, 5419.0, 5719.0, 5486.0, 5617.0, 5385.0, 5423.0, 5411.0, 5304.0, 5381.0, 5387.0, 5614.0, 5450.0, 5589.0, 5484.0, 5352.0, 5265.0, 5375.0, 5456.0, 5716.0, 5466.0, 5695.0, 5430.0, 5509.0, 5490.0, 5404.0, 5253.0, 5367.0, 5338.0, 5349.0, 5364.0, 5310.0, 5441.0, 5582.0, 5501.0, 5322.0, 5659.0, 5572.0, 5395.0, 5335.0, 5555.0, 5321.0, 5389.0, 5324.0, 5526.0, 5506.0, 5583.0, 5479.0, 5286.0, 5426.0, 5585.0, 5278.0, 5372.0, 5251.0, 5564.0, 5428.0, 5592.0, 5483.0, 5258.0, 5519.0, 5418.0, 5677.0,

						5476.0, 5462.0, 5492.0, 5298.0, 5570.0, 5639.0, 5644.0, 5276.0, 5626.0, 5480.0, 5559.0, 5699.0, 5646.0, 5515.0, 5255.0, 5487.0, 5548.0, 5390.0, 5474.0, 5608.0, 5302.0, 5259.0, 5610.0, 5332.0, 5478.0, 5551.0, 5649.0, 5531.0, 5360.0, 5493.0, 5354.0, 5444.0, 5448.0, 5525.0, 5358.0 (number of hits: 5)
18	5550	9	1	333	1	5386.0, 5440.0, 5696.0, 5484.0, 5510.0, 5678.0, 5297.0, 5446.0, 5656.0, 5561.0, 5444.0, 5601.0, 5635.0, 5495.0, 5652.0, 5687.0, 5615.0, 5594.0, 5631.0, 5468.0, 5409.0, 5382.0, 5497.0, 5262.0, 5707.0, 5334.0, 5556.0, 5692.0, 5628.0, 5682.0, 5307.0, 5548.0, 5640.0, 5449.0, 5636.0, 5465.0, 5489.0, 5681.0, 5703.0, 5706.0, 5312.0, 5704.0, 5251.0, 5417.0, 5645.0, 5637.0, 5272.0, 5677.0, 5301.0, 5451.0, 5509.0, 5309.0, 5689.0, 5533.0, 5448.0, 5639.0, 5404.0, 5571.0, 5534.0, 5471.0, 5259.0, 5349.0, 5441.0, 5435.0, 5550.0, 5436.0, 5266.0, 5367.0, 5359.0, 5651.0, 5565.0, 5613.0, 5486.0, 5305.0, 5684.0, 5666.0, 5398.0, 5568.0, 5679.0, 5411.0, 5392.0, 5721.0, 5709.0, 5304.0, 5705.0, 5473.0, 5418.0, 5547.0, 5516.0, 5399.0, 5402.0, 5585.0, 5496.0, 5562.0, 5274.0, 5456.0, 5423.0, 5502.0, 5344.0, 5407.0 (number of hits: 7)
19	5550	9	1	333	1	5466.0, 5723.0, 5263.0, 5709.0, 5383.0, 5343.0, 5309.0, 5552.0, 5315.0, 5617.0, 5325.0, 5305.0, 5442.0, 5629.0, 5324.0, 5581.0, 5646.0, 5327.0, 5657.0, 5455.0, 5610.0, 5669.0, 5399.0, 5532.0, 5675.0, 5386.0, 5328.0, 5406.0, 5691.0, 5349.0, 5372.0, 5302.0, 5259.0, 5484.0, 5497.0, 5444.0, 5370.0, 5547.0, 5528.0, 5653.0, 5473.0, 5554.0, 5318.0, 5638.0, 5397.0, 5440.0, 5420.0, 5643.0, 5534.0, 5381.0, 5672.0, 5674.0, 5518.0, 5655.0, 5364.0, 5320.0, 5288.0, 5416.0, 5270.0, 5432.0, 5663.0, 5253.0, 5515.0, 5449.0, 5618.0, 5301.0, 5300.0, 5615.0, 5623.0, 5375.0, 5436.0, 5266.0, 5282.0, 5274.0, 5278.0, 5656.0, 5628.0, 5621.0, 5662.0, 5271.0, 5314.0, 5355.0, 5326.0, 5264.0, 5493.0, 5589.0, 5541.0, 5572.0, 5396.0, 5291.0, 5721.0, 5415.0, 5567.0, 5261.0, 5506.0, 5346.0, 5389.0, 5492.0, 5620.0, 5564.0 (number of hits: 8)
20	5550	9	1	333	1	5585.0, 5268.0, 5272.0, 5398.0, 5435.0, 5631.0, 5530.0, 5480.0, 5257.0, 5434.0, 5639.0, 5538.0, 5327.0, 5492.0, 5561.0, 5536.0, 5463.0, 5452.0, 5479.0, 5269.0, 5697.0, 5695.0, 5411.0, 5489.0, 5444.0, 5298.0, 5253.0, 5527.0, 5454.0, 5577.0, 5344.0, 5387.0, 5461.0, 5292.0, 5438.0, 5427.0, 5702.0, 5573.0, 5390.0, 5311.0, 5407.0, 5405.0, 5691.0, 5447.0, 5343.0,

						5655.0, 5677.0, 5709.0, 5485.0, 5251.0, 5687.0, 5358.0, 5314.0, 5670.0, 5267.0, 5494.0, 5674.0, 5574.0, 5308.0, 5372.0, 5278.0, 5317.0, 5693.0, 5428.0, 5379.0, 5457.0, 5302.0, 5393.0, 5682.0, 5376.0, 5406.0, 5495.0, 5453.0, 5446.0, 5425.0, 5518.0, 5570.0, 5404.0, 5539.0, 5476.0, 5338.0, 5385.0, 5507.0, 5661.0, 5319.0, 5651.0, 5588.0, 5329.0, 5594.0, 5305.0, 5389.0, 5708.0, 5448.0, 5417.0, 5620.0, 5690.0, 5601.0, 5627.0, 5685.0, 5289.0 (number of hits: 8)
21	5550	9	1	333	1	5687.0, 5457.0, 5615.0, 5368.0, 5647.0, 5682.0, 5599.0, 5257.0, 5657.0, 5672.0, 5400.0, 5395.0, 5459.0, 5499.0, 5706.0, 5533.0, 5555.0, 5666.0, 5309.0, 5347.0, 5436.0, 5481.0, 5531.0, 5510.0, 5270.0, 5408.0, 5482.0, 5611.0, 5460.0, 5679.0, 5331.0, 5399.0, 5634.0, 5410.0, 5293.0, 5556.0, 5632.0, 5478.0, 5605.0, 5624.0, 5574.0, 5614.0, 5538.0, 5569.0, 5486.0, 5639.0, 5263.0, 5382.0, 5297.0, 5357.0, 5301.0, 5696.0, 5363.0, 5351.0, 5627.0, 5269.0, 5471.0, 5462.0, 5338.0, 5567.0, 5518.0, 5635.0, 5304.0, 5477.0, 5342.0, 5630.0, 5455.0, 5454.0, 5580.0, 5598.0, 5379.0, 5545.0, 5384.0, 5352.0, 5340.0, 5326.0, 5719.0, 5668.0, 5498.0, 5584.0, 5341.0, 5571.0, 5450.0, 5618.0, 5693.0, 5671.0, 5709.0, 5412.0, 5305.0, 5366.0, 5650.0, 5287.0, 5411.0, 5653.0, 5619.0, 5524.0, 5415.0, 5563.0, 5424.0, 5369.0 (number of hits: 7)
22	5550	9	1	333	1	5264.0, 5616.0, 5611.0, 5676.0, 5662.0, 5380.0, 5448.0, 5362.0, 5377.0, 5653.0, 5415.0, 5443.0, 5466.0, 5315.0, 5294.0, 5681.0, 5713.0, 5594.0, 5585.0, 5631.0, 5287.0, 5403.0, 5416.0, 5289.0, 5372.0, 5554.0, 5583.0, 5426.0, 5685.0, 5582.0, 5322.0, 5433.0, 5526.0, 5678.0, 5524.0, 5619.0, 5613.0, 5435.0, 5429.0, 5666.0, 5700.0, 5564.0, 5337.0, 5406.0, 5430.0, 5412.0, 5269.0, 5303.0, 5450.0, 5690.0, 5584.0, 5431.0, 5703.0, 5699.0, 5312.0, 5468.0, 5579.0, 5350.0, 5521.0, 5625.0, 5344.0, 5299.0, 5482.0, 5695.0, 5341.0, 5510.0, 5256.0, 5701.0, 5478.0, 5608.0, 5513.0, 5309.0, 5371.0, 5419.0, 5670.0, 5361.0, 5339.0, 5500.0, 5427.0, 5432.0, 5663.0, 5351.0, 5638.0, 5384.0, 5332.0, 5497.0, 5364.0, 5355.0, 5723.0, 5276.0, 5545.0, 5370.0, 5417.0, 5697.0, 5476.0, 5686.0, 5557.0, 5321.0, 5467.0, 5404.0 (number of hits: 7)
23	5550	9	1	333	1	5470.0, 5255.0, 5343.0, 5439.0, 5306.0, 5348.0, 5629.0, 5635.0, 5702.0, 5643.0, 5718.0, 5413.0, 5442.0, 5542.0, 5496.0, 5431.0, 5526.0, 5426.0, 5275.0, 5475.0, 5253.0, 5438.0, 5315.0, 5423.0, 5587.0

						5410.0, 5655.0, 5271.0, 5357.0, 5506.0, 5326.0, 5625.0, 5562.0, 5373.0, 5681.0, 5316.0, 5358.0, 5610.0, 5290.0, 5578.0, 5288.0, 5471.0, 5700.0, 5324.0, 5369.0, 5651.0, 5486.0, 5679.0, 5600.0, 5374.0, 5606.0, 5468.0, 5251.0, 5683.0, 5711.0, 5504.0, 5389.0, 5477.0, 5717.0, 5493.0, 5652.0, 5379.0, 5322.0, 5252.0, 5450.0, 5571.0, 5642.0, 5312.0, 5556.0, 5514.0, 5264.0, 5286.0, 5588.0, 5699.0, 5549.0, 5649.0, 5665.0, 5356.0, 5479.0, 5354.0, 5576.0, 5564.0, 5614.0, 5303.0, 5696.0, 5432.0, 5378.0, 5280.0, 5713.0, 5451.0, 5522.0, 5259.0, 5336.0, 5262.0, 5403.0, 5570.0, 5325.0, 5254.0, 5455.0, 5341.0 (number of hits: 6)
24	5550	9	1	333	1	5658.0, 5510.0, 5285.0, 5645.0, 5625.0, 5350.0, 5465.0, 5439.0, 5555.0, 5373.0, 5665.0, 5609.0, 5426.0, 5340.0, 5622.0, 5552.0, 5417.0, 5413.0, 5270.0, 5405.0, 5361.0, 5490.0, 5498.0, 5724.0, 5277.0, 5715.0, 5454.0, 5336.0, 5402.0, 5517.0, 5639.0, 5706.0, 5648.0, 5387.0, 5632.0, 5450.0, 5664.0, 5404.0, 5461.0, 5320.0, 5499.0, 5449.0, 5392.0, 5382.0, 5337.0, 5429.0, 5516.0, 5564.0, 5710.0, 5452.0, 5473.0, 5443.0, 5317.0, 5501.0, 5391.0, 5691.0, 5502.0, 5641.0, 5366.0, 5282.0, 5689.0, 5420.0, 5643.0, 5343.0, 5394.0, 5291.0, 5703.0, 5597.0, 5581.0, 5543.0, 5300.0, 5425.0, 5339.0, 5616.0, 5651.0, 5466.0, 5513.0, 5642.0, 5445.0, 5680.0, 5436.0, 5289.0, 5453.0, 5408.0, 5474.0, 5364.0, 5547.0, 5666.0, 5262.0, 5459.0, 5560.0, 5633.0, 5571.0, 5546.0, 5614.0, 5637.0, 5626.0, 5275.0, 5353.0, 5558.0 (number of hits: 4)
25	5550	9	1	333	1	5302.0, 5469.0, 5377.0, 5590.0, 5502.0, 5655.0, 5646.0, 5565.0, 5632.0, 5435.0, 5574.0, 5664.0, 5481.0, 5278.0, 5255.0, 5545.0, 5486.0, 5342.0, 5519.0, 5335.0, 5273.0, 5674.0, 5567.0, 5397.0, 5568.0, 5423.0, 5518.0, 5611.0, 5355.0, 5300.0, 5426.0, 5394.0, 5367.0, 5398.0, 5477.0, 5576.0, 5290.0, 5688.0, 5609.0, 5461.0, 5378.0, 5707.0, 5693.0, 5450.0, 5608.0, 5472.0, 5399.0, 5669.0, 5365.0, 5649.0, 5500.0, 5651.0, 5564.0, 5467.0, 5663.0, 5599.0, 5724.0, 5604.0, 5497.0, 5434.0, 5331.0, 5709.0, 5538.0, 5522.0, 5533.0, 5468.0, 5320.0, 5409.0, 5252.0, 5557.0, 5474.0, 5362.0, 5464.0, 5407.0, 5381.0, 5695.0, 5593.0, 5371.0, 5470.0, 5392.0, 5420.0, 5506.0, 5691.0, 5368.0, 5444.0, 5386.0, 5292.0, 5456.0, 5418.0, 5714.0, 5588.0, 5287.0, 5665.0, 5346.0, 5629.0, 5327.0, 5396.0, 5628.0, 5421.0, 5276.0 (number of hits: 5)
26	5550	9	1	333	1	5389.0, 5546.0, 5456.0, 5440.0, 5698.0,

						5569.0, 5566.0, 5697.0, 5638.0, 5522.0, 5591.0, 5354.0, 5318.0, 5350.0, 5483.0, 5395.0, 5719.0, 5580.0, 5579.0, 5337.0, 5364.0, 5458.0, 5420.0, 5348.0, 5334.0, 5606.0, 5323.0, 5633.0, 5710.0, 5515.0, 5383.0, 5666.0, 5570.0, 5343.0, 5643.0, 5700.0, 5394.0, 5398.0, 5695.0, 5599.0, 5513.0, 5542.0, 5424.0, 5529.0, 5355.0, 5336.0, 5461.0, 5356.0, 5556.0, 5497.0, 5311.0, 5306.0, 5593.0, 5272.0, 5524.0, 5624.0, 5669.0, 5369.0, 5537.0, 5657.0, 5258.0, 5277.0, 5718.0, 5620.0, 5557.0, 5517.0, 5454.0, 5421.0, 5330.0, 5478.0, 5357.0, 5665.0, 5586.0, 5385.0, 5378.0, 5672.0, 5430.0, 5263.0, 5560.0, 5608.0, 5692.0, 5340.0, 5345.0, 5464.0, 5509.0, 5289.0, 5533.0, 5431.0, 5295.0, 5683.0, 5548.0, 5642.0, 5660.0, 5713.0, 5659.0, 5563.0, 5494.0, 5699.0, 5588.0, 5629.0 (number of hits: 4)
27	5550	9	1	333	1	5440.0, 5496.0, 5480.0, 5273.0, 5544.0, 5395.0, 5598.0, 5704.0, 5664.0, 5310.0, 5404.0, 5313.0, 5492.0, 5677.0, 5606.0, 5250.0, 5528.0, 5360.0, 5290.0, 5354.0, 5364.0, 5501.0, 5600.0, 5312.0, 5662.0, 5537.0, 5486.0, 5321.0, 5329.0, 5562.0, 5507.0, 5686.0, 5489.0, 5701.0, 5376.0, 5390.0, 5464.0, 5505.0, 5646.0, 5278.0, 5411.0, 5428.0, 5453.0, 5635.0, 5694.0, 5693.0, 5647.0, 5301.0, 5713.0, 5638.0, 5723.0, 5565.0, 5331.0, 5365.0, 5300.0, 5715.0, 5711.0, 5517.0, 5652.0, 5702.0, 5504.0, 5590.0, 5681.0, 5384.0, 5396.0, 5594.0, 5296.0, 5567.0, 5493.0, 5294.0, 5419.0, 5337.0, 5372.0, 5373.0, 5630.0, 5535.0, 5456.0, 5601.0, 5475.0, 5592.0, 5277.0, 5539.0, 5359.0, 5362.0, 5709.0, 5595.0, 5378.0, 5457.0, 5648.0, 5325.0, 5665.0, 5705.0, 5324.0, 5525.0, 5596.0, 5433.0, 5355.0, 5363.0, 5386.0, 5264.0 (number of hits: 8)
28	5550	9	1	333	1	5697.0, 5628.0, 5448.0, 5569.0, 5616.0, 5387.0, 5685.0, 5386.0, 5380.0, 5609.0, 5338.0, 5432.0, 5443.0, 5564.0, 5406.0, 5605.0, 5579.0, 5688.0, 5684.0, 5373.0, 5544.0, 5524.0, 5408.0, 5570.0, 5321.0, 5360.0, 5646.0, 5304.0, 5455.0, 5639.0, 5500.0, 5479.0, 5642.0, 5709.0, 5636.0, 5414.0, 5492.0, 5657.0, 5291.0, 5537.0, 5554.0, 5293.0, 5430.0, 5277.0, 5294.0, 5669.0, 5706.0, 5340.0, 5341.0, 5260.0, 5571.0, 5469.0, 5597.0, 5573.0, 5503.0, 5398.0, 5346.0, 5433.0, 5282.0, 5255.0, 5329.0, 5431.0, 5361.0, 5648.0, 5674.0, 5602.0, 5560.0, 5295.0, 5700.0, 5638.0, 5583.0, 5614.0, 5258.0, 5441.0, 5468.0, 5519.0, 5535.0, 5495.0, 5658.0, 5320.0, 5421.0, 5405.0, 5525.0, 5253.0, 5446.0, 5548.0, 5374.0, 5393.0, 5426.0, 5664.0

						5665.0, 5392.0, 5551.0, 5300.0, 5403.0, 5470.0, 5420.0, 5309.0, 5416.0, 5543.0 (number of hits: 7 )
29	5550	9	1	333	1	5533.0, 5329.0, 5382.0, 5274.0, 5309.0, 5505.0, 5314.0, 5550.0, 5400.0, 5460.0, 5665.0, 5718.0, 5616.0, 5437.0, 5585.0, 5286.0, 5446.0, 5708.0, 5381.0, 5664.0, 5535.0, 5517.0, 5617.0, 5529.0, 5252.0, 5721.0, 5512.0, 5674.0, 5370.0, 5424.0, 5689.0, 5277.0, 5518.0, 5313.0, 5395.0, 5369.0, 5287.0, 5507.0, 5307.0, 5504.0, 5261.0, 5657.0, 5459.0, 5376.0, 5497.0, 5646.0, 5681.0, 5409.0, 5344.0, 5330.0, 5587.0, 5461.0, 5439.0, 5457.0, 5700.0, 5396.0, 5520.0, 5661.0, 5598.0, 5593.0, 5388.0, 5641.0, 5394.0, 5449.0, 5666.0, 5324.0, 5295.0, 5672.0, 5407.0, 5493.0, 5351.0, 5509.0, 5621.0, 5667.0, 5557.0, 5371.0, 5296.0, 5268.0, 5401.0, 5404.0, 5602.0, 5614.0, 5425.0, 5608.0, 5566.0, 5638.0, 5468.0, 5413.0, 5692.0, 5709.0, 5543.0, 5627.0, 5278.0, 5488.0, 5590.0, 5555.0, 5353.0, 5541.0, 5669.0, 5474.0 (number of hits: 8 )
30	5550	9	1	333	1	5570.0, 5611.0, 5271.0, 5405.0, 5632.0, 5575.0, 5545.0, 5556.0, 5511.0, 5387.0, 5539.0, 5664.0, 5660.0, 5648.0, 5447.0, 5554.0, 5495.0, 5331.0, 5626.0, 5595.0, 5607.0, 5322.0, 5510.0, 5379.0, 5560.0, 5680.0, 5568.0, 5509.0, 5669.0, 5638.0, 5721.0, 5402.0, 5384.0, 5365.0, 5666.0, 5415.0, 5628.0, 5645.0, 5465.0, 5662.0, 5348.0, 5699.0, 5341.0, 5351.0, 5356.0, 5469.0, 5714.0, 5386.0, 5706.0, 5603.0, 5719.0, 5339.0, 5442.0, 5513.0, 5473.0, 5268.0, 5486.0, 5569.0, 5657.0, 5709.0, 5701.0, 5400.0, 5566.0, 5542.0, 5508.0, 5639.0, 5619.0, 5395.0, 5264.0, 5376.0, 5334.0, 5505.0, 5722.0, 5526.0, 5414.0, 5410.0, 5494.0, 5258.0, 5316.0, 5372.0, 5323.0, 5294.0, 5502.0, 5429.0, 5552.0, 5693.0, 5435.0, 5433.0, 5605.0, 5708.0, 5562.0, 5369.0, 5658.0, 5295.0, 5555.0, 5406.0, 5584.0, 5398.0, 5284.0, 5342.0 (number of hits: 2 )



**5290 MHz, 80 MHz Bandwidth**

<b>Radar Signal Type</b>	<b>Waveform/Trial Number</b>	<b>Detection (%)</b>	<b>Limit (%)</b>	<b>Pass/Fail</b>
<b>Type 1A/1B</b>	30	100 %	60%	Pass
<b>Type 2</b>	30	100 %	60%	Pass
<b>Type 3</b>	30	100 %	60%	Pass
<b>Type 4</b>	30	100 %	60%	Pass
<b>Aggregate (Type1 to 4)</b>	120	100 %	80%	Pass
<b>Type 5</b>	30	100 %	80%	Pass
<b>Type 6</b>	30	100 %	70%	Pass

Please refer to the following statistical tables:

**Table-1 Radar Type 1A/1B Statistical Performance**

<b>Trial #</b>	<b>Fc (MHz)</b>	<b>Pulse/Burst</b>	<b>Pulse Width (μS)</b>	<b>PRI (μs)</b>	<b>Detection (1:yes; 0:no)</b>
1	5290	78	1	678	1
2	5290	70	1	758	1
3	5290	63	1	838	1
4	5290	57	1	938	1
5	5290	92	1	578	1
6	5290	76	1	698	1
7	5290	95	1	558	1
8	5290	83	1	638	1
9	5290	62	1	858	1
10	5290	99	1	538	1
11	5290	59	1	898	1
12	5290	61	1	878	1
13	5290	89	1	598	1
14	5290	67	1	798	1
15	5290	18	1	3066	1
16	5290	19	1	2895	1
17	5290	34	1	1597	1
18	5290	27	1	1973	1
19	5290	58	1	923	1
20	5290	55	1	974	1
21	5290	23	1	2382	1
22	5290	39	1	1381	1
23	5290	23	1	2312	1
24	5290	77	1	689	1
25	5290	70	1	754	1
26	5290	23	1	2349	1
27	5290	31	1	1724	1
28	5290	22	1	2469	1
29	5290	29	1	1824	1
30	5290	22	1	2402	1
<b>Detection Percentage: 100 % (&gt;60%)</b>					

**Table-2 Radar Type 2 Statistical Performance**

<b>Trial #</b>	<b>Fc (MHz)</b>	<b>Pulse/Burst</b>	<b>Pulse Width (μS)</b>	<b>PRI (μs)</b>	<b>Detection (1:yes; 0:no)</b>
1	5290	23	3.4	179	1
2	5290	27	2.4	216	1
3	5290	26	1.9	183	1
4	5290	27	2.4	208	1
5	5290	28	1.3	198	1
6	5290	24	3.8	158	1
7	5290	26	2	177	1
8	5290	27	1.7	230	1
9	5290	29	2.7	181	1
10	5290	29	1.8	170	1
11	5290	25	2.2	163	1
12	5290	28	4.7	222	1
13	5290	23	4	228	1
14	5290	25	2.5	196	1
15	5290	28	4.5	207	1
16	5290	27	5	159	1
17	5290	26	1	153	1
18	5290	29	3.1	191	1
19	5290	28	3.1	228	1
20	5290	27	2.6	155	1
21	5290	23	2.4	181	1
22	5290	23	1.6	216	1
23	5290	23	4.1	230	1
24	5290	29	1.3	176	1
25	5290	24	1.7	191	1
26	5290	26	3.6	155	1
27	5290	27	1.5	178	1
28	5290	27	3	179	1
29	5290	25	4.1	224	1
30	5290	28	4.2	226	1
<b>Detection Percentage: 100 % (&gt;60%)</b>					

**Table-3 Radar Type 3 Statistical Performance**

<b>Trial #</b>	<b>Fc (MHz)</b>	<b>Pulse/Burst</b>	<b>Pulse Width (μS)</b>	<b>PRI (μs)</b>	<b>Detection (1:yes; 0:no)</b>
1	5290	16	7.4	418	1
2	5290	18	8.6	345	1
3	5290	17	6	486	1
4	5290	18	6	233	1
5	5290	17	8.1	466	1
6	5290	18	8.7	412	1
7	5290	16	6.5	419	1
8	5290	17	6.1	473	1
9	5290	18	7.3	278	1
10	5290	17	10	445	1
11	5290	16	6.2	336	1
12	5290	16	7.2	226	1
13	5290	16	7.9	367	1
14	5290	17	6.4	384	1
15	5290	18	6	257	1
16	5290	16	7.6	462	1
17	5290	16	9.8	243	1
18	5290	18	7.7	264	1
19	5290	18	7.8	404	1
20	5290	18	8.8	494	1
21	5290	16	9.8	219	1
22	5290	16	7.5	370	1
23	5290	16	7.7	312	1
24	5290	17	6.3	248	1
25	5290	16	6.4	221	1
26	5290	16	9.5	426	1
27	5290	18	8.4	387	1
28	5290	16	6	456	1
29	5290	18	7.9	297	1
30	5290	18	6.5	413	1
<b>Detection Percentage: 100 % (&gt;60%)</b>					

**Table-4 Radar Type 4 Statistical Performance**

<b>Trial #</b>	<b>Fc (MHz)</b>	<b>Pulse/Burst</b>	<b>Pulse Width (µS)</b>	<b>PRI (µs)</b>	<b>Detection (1:yes; 0:no)</b>
1	5290	16	14	258	1
2	5290	15	12.8	482	1
3	5290	14	11.5	275	1
4	5290	14	13.9	234	1
5	5290	15	14.2	334	1
6	5290	12	13.3	334	1
7	5290	16	16.2	206	1
8	5290	16	14.1	442	1
9	5290	15	13.9	214	1
10	5290	12	14.2	414	1
11	5290	15	15.8	311	1
12	5290	14	19.7	435	1
13	5290	16	13.6	328	1
14	5290	15	14.7	360	1
15	5290	13	14.1	344	1
16	5290	15	19.6	474	1
17	5290	12	17.3	287	1
18	5290	15	11.3	259	1
19	5290	12	17.2	379	1
20	5290	12	12	260	1
21	5290	16	19.6	253	1
22	5290	12	14.4	290	1
23	5290	16	17.8	295	1
24	5290	14	14.1	466	1
25	5290	16	12.5	488	1
26	5290	16	12.7	247	1
27	5290	12	13.7	467	1
28	5290	14	16	228	1
29	5290	14	16.1	269	1
30	5290	14	14.2	434	1
<b>Detection Percentage: 100 % (&gt;60%)</b>					

**Table-5 Radar Type 5 Statistical Performance**

Bin5 Statistics 1

Trial #	Pulse	Chirp (MHz)	Pulse Width (µS)	Pulse 1-2 spacing (uS)	Pulse 2-3 spacing (uS)	Pulse Start(S)	Detection (1:yes; 0:no)
0	2	20	72	1307		0.683732	1
1	2	8	88.9	1727		1.659033	
2	2	16	61	1851		3.223262	
3	1	13	80.7			3.826519	
4	1	10	72.7			4.864602	
5	3	18	95.2	1247	1740	6.084724	
6	3	9	90.3	1158	1179	7.426935	
7	1	10	85.6			7.735932	
8	3	7	72.6	1401	1445	8.760265	
9	2	7	89.2	1091		10.465568	
10	2	20	61.5	1996		10.984125	

Bin5 Statistics 2

Trial #	Pulse	Chirp (MHz)	Pulse Width (µS)	Pulse 1-2 spacing (uS)	Pulse 2-3 spacing (uS)	Pulse Start(S)	Detection (1:yes; 0:no)
0	3	8	84.9	1356	1727	0.249547	1
1	3	13	73.6	1075	1725	0.79292	
2	1	12	66.1			1.886941	
3	1	14	65.1			2.227991	
4	2	10	96.9	1732		3.026802	
5	3	20	92	1023	1859	3.703725	
6	3	9	96.7	1579	1942	4.294519	
7	2	18	83.8	1115		5.635097	
8	2	13	80.7	1816		5.870059	
9	2	6	65.7	1798		6.657634	
10	1	11	70.1			7.223867	
11	2	13	80.5	1095		8.367382	
12	1	9	93.6			9.023306	
13	2	11	99.7	1182		9.802787	
14	2	10	68.7	1652		10.490117	
15	2	9	50.3	1039		11.218264	
16	2	7	87.9	1490		11.430854	

## Bin5 Statistics 3

Trial #	Pulse	Chirp (MHz)	Pulse Width (µS)	Pulse 1-2 spacing (uS)	Pulse 2-3 spacing (uS)	Pulse Start(S)	Detection (1:yes; 0:no)
0	1	13	90.7			0.283457	1
1	1	8	80.3			0.925172	
2	1	13	82.5			1.789324	
3	2	14	99.4	1378		2.364538	
4	1	19	52.1			2.878882	
5	3	6	99.4	1207	1871	3.558933	
6	2	17	74.8	1629		4.068928	
7	1	7	79.2			4.620913	
8	1	17	78.7			5.387563	
9	2	12	98.3	1087		6.256616	
10	3	19	90.3	1503	1101	6.669182	
11	1	13	99.6			7.16937	
12	2	5	58.5	1185		8.108394	
13	2	7	71.8	1349		8.388886	
14	2	12	75.7	1410		9.204267	
15	3	11	96.8	1249	1748	9.637739	
16	1	7	72.6			10.161391	
17	2	6	60.8	1669		10.911568	
18	2	18	83.8	1335		11.413052	

## Bin5 Statistics 4

Trial #	Pulse	Chirp (MHz)	Pulse Width (µS)	Pulse 1-2 spacing (uS)	Pulse 2-3 spacing (uS)	Pulse Start(S)	Detection (1:yes; 0:no)
0	3	16	53.1	1527	1799	0.190125	1
1	3	14	73.3	1980	1610	1.162143	
2	2	17	60.5	1440		1.701291	
3	3	20	54.6	1742	1469	2.788702	
4	2	10	57	1506		3.21329	
5	3	8	53	1352	1483	4.157889	
6	1	14	92.2			4.555037	
7	3	16	74.4	1862	1235	5.739782	
8	2	12	86.3	1000		6.673	
9	2	14	75.1	1809		6.991884	
10	2	7	71.5	1852		7.874474	
11	1	19	96.1			8.575662	
12	1	7	98.8			9.477777	
13	2	8	82.5	1847		10.070964	
14	1	19	58.9			10.893454	
15	2	11	93.3	1769		11.991981	

## Bin5 Statistics 5

Trial #	Pulse	Chirp (MHz)	Pulse Width (µS)	Pulse 1-2 spacing (uS)	Pulse 2-3 spacing (uS)	Pulse Start(S)	Detection (1:yes; 0:no)
0	2	8	62.4	1751		0.04303	1
1	2	6	56.8	1669		1.251367	
2	1	6	57.3			1.984563	
3	2	18	57.3	1067		2.606455	
4	2	6	91.8	1912		3.738491	
5	2	17	93.1	1624		4.555731	
6	2	8	69.8	1473		5.992069	
7	1	5	55.3			6.318532	
8	2	9	88.1	1190		7.69379	
9	2	6	98.4	1873		8.251444	
10	2	9	52.8	1570		9.236034	
11	2	7	55.1	1775		10.277811	
12	2	5	100	1612		10.577003	
13	2	19	58.7	1291		11.5163	



## Bin5 Statistics 6

Trial #	Pulse	Chirp (MHz)	Pulse Width (µS)	Pulse 1-2 spacing (uS)	Pulse 2-3 spacing (uS)	Pulse Start(S)	Detection (1:yes; 0:no)
0	1	18	75.5			0.331997	1
1	2	8	61.7	1978		0.911458	
2	1	16	93.8			1.581708	
3	2	10	97.7	1390		2.093215	
4	1	10	54.1			3.078999	
5	3	8	66.6	1728	1257	3.310924	
6	2	9	64.6	1464		4.037805	
7	3	6	79.9	1229	1874	4.809441	
8	3	12	77.3	1645	1447	5.111199	
9	3	6	55.3	1285	1773	6.17154	
10	1	7	55.2			6.335885	
11	3	11	71.6	1435	1723	7.030653	
12	2	8	67.3	1566		7.845198	
13	2	19	91.1	1620		8.524794	
14	3	17	92.8	1512	1992	9.28839	
15	2	19	53.2	1380		9.963126	
16	1	16	93.8			10.241627	
17	1	6	74.6			11.164475	
18	3	16	52.2	1862	1718	11.557711	

## Bin5 Statistics 7

Trial #	Pulse	Chirp (MHz)	Pulse Width (µS)	Pulse 1-2 spacing (uS)	Pulse 2-3 spacing (uS)	Pulse Start(S)	Detection (1:yes; 0:no)
0	2	15	70.6	1448		0.256394	1
1	2	11	92.9	1746		1.326994	
2	2	6	83.8	1241		3.061191	
3	3	6	64.6	1166	1784	3.632383	
4	2	12	87.7	1761		5.272738	
5	2	15	89.1	1298		6.479492	
6	2	18	71.7	1219		8.031775	
7	3	18	75.6	1633	1243	8.519368	
8	3	18	95.3	1954	1530	9.719124	
9	2	15	82.3	1739		11.827053	

## Bin5 Statistics 8

Trial #	Pulse	Chirp (MHz)	Pulse Width (µS)	Pulse 1-2 spacing (µS)	Pulse 2-3 spacing (µS)	Pulse Start(S)	Detection (1:yes; 0:no)
0	2	17	82	1532		1.020039	1
1	3	10	86	1412	1487	1.529867	
2	1	12	54.8			3.741026	
3	2	10	71.9	1303		5.6976	
4	2	18	92.3	1462		6.576039	
5	2	16	80.3	1825		8.602354	
6	1	9	80.3			9.806969	
7	3	11	50.6	1047	1344	11.328798	

## Bin5 Statistics 9

Trial #	Pulse	Chirp (MHz)	Pulse Width (µS)	Pulse 1-2 spacing (µS)	Pulse 2-3 spacing (µS)	Pulse Start(S)	Detection (1:yes; 0:no)
0	1	18	82.7			0.658817	1
1	1	17	97.7			0.950377	
2	3	15	52.2	1536	1638	1.468433	
3	3	20	73.6	1216	1257	2.388662	
4	2	14	75.5	1196		3.055859	
5	2	8	69.2	1472		4.037011	
6	3	16	55.5	1591	1879	4.53174	
7	2	10	96.6	1260		5.32655	
8	2	10	87.9	1133		5.955626	
9	1	12	60.8			6.674494	
10	1	6	58.1			7.474904	
11	2	13	60.9	1957		8.221803	
12	2	8	86.4	1341		8.714731	
13	3	7	69.1	1907	1343	9.240599	
14	2	16	74.5	1498		9.9338	
15	2	10	84.5	1900		11.151782	
16	2	8	89.7	1421		11.348553	

## Bin5 Statistics 10

Trial #	Pulse	Chirp (MHz)	Pulse Width (µS)	Pulse 1-2 spacing (µS)	Pulse 2-3 spacing (µS)	Pulse Start(S)	Detection (1:yes; 0:no)
0	2	16	63.7	1153		0.350057	1
1	2	16	90.9	1819		0.634684	
2	1	10	66.7			1.451073	
3	1	13	91			2.425168	
4	1	18	74.5			2.676989	
5	3	15	86.8	1818	1129	3.701947	
6	3	16	76.6	1320	1194	3.803715	
7	2	11	95.1	1900		4.564021	
8	1	9	94.1			5.116925	
9	1	17	55.5			5.914236	
10	2	16	53.8	1188		6.599636	
11	3	13	66.3	1502	1236	7.364064	
12	2	15	71.1	1735		7.985342	
13	2	20	82.8	1079		8.495801	
14	3	19	69	1162	1887	9.246993	
15	2	16	75	1983		9.701524	
16	2	19	72	1348		10.603332	
17	1	14	68.9			11.000521	
18	1	18	65.8			11.542018	

## Bin5 Statistics 11

Trial #	Pulse	Chirp (MHz)	Pulse Width (µS)	Pulse 1-2 spacing (µS)	Pulse 2-3 spacing (µS)	Pulse Start(S)	Detection (1:yes; 0:no)
0	3	12	68.4	1862	1861	0.232967	1
1	3	11	71.7	1508	1372	1.570927	
2	3	18	90.9	1689	1804	2.208772	
3	1	8	95.1			2.410255	
4	3	15	52.1	1667	1349	3.969403	
5	2	19	99.1	1096		4.508566	
6	1	14	88.3			4.84913	
7	3	7	93.2	1437	1635	6.160947	
8	3	17	94.9	1063	1170	7.065344	
9	1	14	54.8			7.340763	
10	2	10	73.9	1235		8.608187	
11	3	8	94.7	1519	1895	9.423464	
12	3	18	83.7	1636	1358	10.185728	
13	2	10	73.2	1489		10.560482	
14	2	17	80.3	1477		11.40858	

## Bin5 Statistics 12

Trial #	Pulse	Chirp (MHz)	Pulse Width (µS)	Pulse 1-2 spacing (µS)	Pulse 2-3 spacing (µS)	Pulse Start(S)	Detection (1:yes; 0:no)
0	2	14	85.3	1732		0.237678	1
1	2	9	60.7	1757		1.937546	
2	2	19	94.4	1065		2.386101	
3	1	6	71.8			3.874428	
4	2	8	58.9	1948		5.381169	
5	2	15	87.3	1890		6.481637	
6	2	9	50.4	1173		6.798712	
7	1	6	97			7.841373	
8	1	6	87.4			8.747068	
9	1	8	77.4			9.999875	
10	3	6	50.6	1264	1589	11.217726	

## Bin5 Statistics 13

Trial #	Pulse	Chirp (MHz)	Pulse Width (µS)	Pulse 1-2 spacing (µS)	Pulse 2-3 spacing (µS)	Pulse Start(S)	Detection (1:yes; 0:no)
0	3	15	55.8	1047	1364	0.271027	1
1	3	19	87.3	1276	1756	0.856606	
2	2	13	57.1	1100		1.502919	
3	2	12	69.7	1774		2.917284	
4	2	10	75.7	1525		3.33455	
5	3	19	79.3	1805	1603	4.22525	
6	3	6	50.1	1789	1782	4.982548	
7	2	19	50.4	1920		5.375145	
8	2	17	50.3	1539		6.484952	
9	2	14	86.3	1479		7.069134	
10	2	10	63.4	1758		7.911617	
11	2	5	81.3	1423		8.787541	
12	2	11	71.9	1876		9.013469	
13	1	15	84.8			10.249507	
14	3	6	58.8	1138	1249	11.040365	
15	2	18	78.4	1269		11.55387	

## Bin5 Statistics 14

Trial #	Pulse	Chirp (MHz)	Pulse Width (µS)	Pulse 1-2 spacing (µS)	Pulse 2-3 spacing (µS)	Pulse Start(S)	Detection (1:yes; 0:no)
0	1	19	70.1			0.765817	1
1	2	16	92.9	1099		0.931924	
2	2	6	52.9	1431		1.975369	
3	1	15	79.1			3.226865	
4	3	10	66.3	1793	1153	3.897865	
5	3	14	85.8	1893	1180	4.782792	
6	2	17	63.1	1465		5.85924	
7	2	5	72.7	1941		7.322331	
8	3	11	53.4	1247	1528	8.150576	
9	2	13	58.5	1193		9.184178	
10	1	15	54.3			9.275342	
11	3	7	67.7	1585	1407	10.172116	
12	2	16	54.7	1401		11.460716	

## Bin5 Statistics 15

Trial #	Pulse	Chirp (MHz)	Pulse Width (µS)	Pulse 1-2 spacing (µS)	Pulse 2-3 spacing (µS)	Pulse Start(S)	Detection (1:yes; 0:no)
0	3	20	76.8	1209	1382	0.591038	1
1	2	17	92.6	1751		1.02405	
2	2	18	75.4	1752		1.901714	
3	2	8	65.7	1587		2.130116	
4	1	6	85.9			3.084174	
5	1	18	57.3			3.805156	
6	3	10	80.5	1758	1989	4.860914	
7	1	17	98.7			5.286119	
8	1	14	91.9			5.913075	
9	3	14	86.4	1136	1488	7.032505	
10	3	16	51	1478	1217	7.454366	
11	2	15	51.4	1375		8.26537	
12	3	13	63.9	1169	1378	8.639046	
13	3	9	92.7	1113	1988	9.224951	
14	2	7	78.8	1364		10.541022	
15	3	15	85.2	1739	1630	11.251536	
16	2	18	69.7	1350		11.816999	

## Bin5 Statistics 16

Trial #	Pulse	Chirp (MHz)	Pulse Width (µS)	Pulse 1-2 spacing (uS)	Pulse 2-3 spacing (uS)	Pulse Start(S)	Detection (1:yes; 0:no)
0	3	12	75.5	1402	1942	0.252224	1
1	3	8	69.9	1383	1199	1.196469	
2	1	10	66.1			1.419873	
3	3	11	92.4	1724	1191	2.334348	
4	3	6	87.5	1799	1650	2.654274	
5	2	13	98.9	1486		3.582687	
6	1	13	86.8			4.259109	
7	2	11	54.1	1159		4.722858	
8	2	6	60.9	1507		5.621098	
9	3	17	77.6	1370	1216	6.19617	
10	3	12	89.7	1902	1216	6.811974	
11	2	9	91.5	1104		6.952994	
12	1	6	66			7.740441	
13	2	19	96.5	1133		8.457907	
14	2	19	67.8	1880		9.022191	
15	1	11	66.7			9.960975	
16	3	19	68.7	1210	1173	10.398974	
17	3	17	76.5	1817	1375	11.04977	
18	3	6	63.6	1670	1560	11.908783	

## Bin5 Statistics 17

Trial #	Pulse	Chirp (MHz)	Pulse Width (µS)	Pulse 1-2 spacing (µS)	Pulse 2-3 spacing (µS)	Pulse Start(S)	Detection (1:yes; 0:no)
0	2	20	68.1	1994		0.093179	1
1	3	19	61.7	1395	1424	0.901953	
2	2	6	77.5	1227		1.898209	
3	2	17	69.6	1950		2.760764	
4	1	6	67.2			3.440706	
5	2	19	55.6	1310		4.413327	
6	1	17	74.3			4.591308	
7	2	6	90.1	1178		5.718594	
8	2	5	54.6	1662		6.469625	
9	3	8	94.8	1951	1421	6.901664	
10	3	6	99.3	1427	1147	7.612275	
11	3	15	53.7	1288	1552	8.313259	
12	3	5	99.1	1095	1061	9.445667	
13	3	15	70.1	1699	1178	10.13435	
14	3	13	77.5	1056	1057	10.546126	
15	3	8	85.9	1640	1156	11.462262	

## Bin5 Statistics 18

Trial #	Pulse	Chirp (MHz)	Pulse Width (µS)	Pulse 1-2 spacing (µS)	Pulse 2-3 spacing (µS)	Pulse Start(S)	Detection (1:yes; 0:no)
0	2	10	62.8	1130		1.002233	1
1	2	5	51.9	1241		1.44561	
2	2	6	65.2	1961		2.392195	
3	1	16	90			4.121375	
4	1	16	90.8			5.121719	
5	2	13	81.5	1393		5.862262	
6	3	17	53.5	1046	1536	6.597385	
7	2	18	50.8	1543		7.76767	
8	3	9	63.2	1363	1153	9.52064	
9	2	13	91.5	1370		10.81989	
10	2	14	72.3	1241		11.642597	

## Bin5 Statistics 19

Trial #	Pulse	Chirp (MHz)	Pulse Width (µS)	Pulse 1-2 spacing (µS)	Pulse 2-3 spacing (µS)	Pulse Start(S)	Detection (1:yes; 0:no)
0	2	19	69.2	1081		0.791769	1
1	3	15	84.6	1680	1528	1.436954	
2	1	8	87.6			2.689701	
3	3	11	62	1397	1809	3.205861	
4	2	11	86.4	1866		4.820455	
5	2	17	86.6	1860		5.835511	
6	3	16	94.8	1320	1289	6.110299	
7	3	7	94.5	1597	1233	7.524921	
8	1	9	97			8.880888	
9	2	11	58.9	1399		9.037295	
10	2	14	73	1526		10.75746	
11	2	17	95.6	1481		11.305318	

## Bin5 Statistics 20

Trial #	Pulse	Chirp (MHz)	Pulse Width (µS)	Pulse 1-2 spacing (µS)	Pulse 2-3 spacing (µS)	Pulse Start(S)	Detection (1:yes; 0:no)
0	3	10	62	1757	1796	0.567794	1
1	2	9	53.1	1948		0.982773	
2	2	11	96.5	1419		1.71905	
3	2	10	79.4	1404		2.222162	
4	1	8	63.1			2.873423	
5	2	16	54.3	1478		3.507406	
6	1	8	64.7			4.198128	
7	3	7	96.8	1222	1288	4.95655	
8	1	17	50.4			5.942577	
9	2	20	76	1760		6.313461	
10	3	13	78.4	1686	1372	6.735363	
11	3	15	84.8	1397	1441	7.98749	
12	2	6	63.6	1489		8.050117	
13	2	13	54.4	1998		8.812779	
14	1	11	76.2			9.758874	
15	2	15	60.9	1987		10.559491	
16	2	17	71.2	1258		10.708942	
17	1	15	62.9			11.682724	



## Bin5 Statistics 21

Trial #	Pulse	Chirp (MHz)	Pulse Width (µS)	Pulse 1-2 spacing (uS)	Pulse 2-3 spacing (uS)	Pulse Start(S)	Detection (1:yes; 0:no)
0	2	19	97.7	1357		0.38957	1
1	2	19	77.9	1867		1.28494	
2	2	8	78.6	1960		1.631928	
3	2	18	50.5	1344		2.402458	
4	1	14	66.8			3.159131	
5	3	7	59.1	1489	1294	3.968184	
6	2	15	81.3	1782		4.008109	
7	2	9	70	1731		5.252398	
8	1	14	53.4			5.385181	
9	3	9	69.1	1087	1931	6.422905	
10	3	5	63	1467	1120	7.220281	
11	2	10	76.4	1366		7.428977	
12	2	6	71.6	1428		8.067649	
13	2	9	56.1	1023		8.802282	
14	3	19	97.9	1889	1351	9.793473	
15	1	8	97.7			10.040801	
16	3	20	93.2	1883	1112	10.869022	
17	1	17	76.5			11.59981	

## Bin5 Statistics 22

Trial #	Pulse	Chirp (MHz)	Pulse Width (µS)	Pulse 1-2 spacing (uS)	Pulse 2-3 spacing (uS)	Pulse Start(S)	Detection (1:yes; 0:no)
0	3	7	88.5	1280	1655	0.436858	1
1	2	19	54.1	1327		1.031312	
2	2	12	52.8	1787		2.096382	
3	2	9	93.7	1860		3.131399	
4	3	8	51.8	1426	1773	4.923424	
5	1	19	56.5			5.473957	
6	3	8	93.9	1322	1962	6.18382	
7	3	14	79.4	1099	1052	7.052234	
8	2	8	50.7	1565		8.456787	
9	1	18	75.9			9.672181	
10	2	7	70.3	1873		10.923631	
11	2	15	86.7	1107		11.293071	

## Bin5 Statistics 23

Trial #	Pulse	Chirp (MHz)	Pulse Width (µS)	Pulse 1-2 spacing (uS)	Pulse 2-3 spacing (uS)	Pulse Start(S)	Detection (1:yes; 0:no)
0	2	18	71.9	1035		0.157303	1
1	2	14	67.7	1144		1.821993	
2	1	5	94.9			2.622077	
3	3	14	86.7	1103	1280	3.393656	
4	2	19	80.3	1856		3.749672	
5	2	19	82.3	1323		4.782021	
6	3	6	73.9	1151	1277	5.91416	
7	2	5	83.7	1841		6.561673	
8	3	17	75.7	1925	1180	7.704794	
9	1	13	77.4			8.670416	
10	1	5	88.9			9.655072	
11	2	5	85	1795		10.45616	
12	1	11	73			11.932705	

## Bin5 Statistics 24

Trial #	Pulse	Chirp (MHz)	Pulse Width (µS)	Pulse 1-2 spacing (uS)	Pulse 2-3 spacing (uS)	Pulse Start(S)	Detection (1:yes; 0:no)
0	1	7	55.9			1.020056	1
1	1	15	65.9			1.501094	
2	1	14	66.4			3.958203	
3	3	10	82.2	1577	1421	4.54032	
4	2	19	67.5	1432		6.466876	
5	3	13	77	1060	1156	7.700033	
6	1	17	76.9			10.309965	
7	2	15	90.5	1618		10.721857	

## Bin5 Statistics 25

Trial #	Pulse	Chirp (MHz)	Pulse Width (µS)	Pulse 1-2 spacing (uS)	Pulse 2-3 spacing (uS)	Pulse Start(S)	Detection (1:yes; 0:no)
0	2	5	52.7	1330		0.155412	1
1	2	19	72.8	1167		2.300666	
2	3	12	57.8	1660	1768	2.79431	
3	2	10	78	1655		3.974361	
4	1	17	72.8			5.611001	
5	2	15	95.8	1314		6.241794	
6	2	18	81.4	1789		7.783122	
7	1	16	51.5			9.204526	
8	3	14	96	1527	1558	10.263136	
9	2	14	76.1	1401		11.306091	

## Bin5 Statistics 26

Trial #	Pulse	Chirp (MHz)	Pulse Width (µS)	Pulse 1-2 spacing (uS)	Pulse 2-3 spacing (uS)	Pulse Start(S)	Detection (1:yes; 0:no)
0	2	17	84.3	1195		0.271053	1
1	1	19	60.8			1.193601	
2	2	7	97.1	1599		1.869024	
3	2	14	95.2	1976		2.468834	
4	1	20	68.1			3.154675	
5	2	8	87.7	1189		3.719274	
6	1	17	79.2			4.334481	
7	3	12	74.9	1331	1085	4.954992	
8	2	12	98	1939		5.48584	
9	3	12	95	1298	1102	6.117385	
10	1	7	93.1			7.061166	
11	1	15	98.8			7.674436	
12	1	7	73.3			8.301107	
13	2	13	55.6	1830		9.221574	
14	3	8	72.6	1003	1062	9.761646	
15	1	10	79.9			10.169854	
16	2	10	88.4	1637		10.913103	
17	3	12	63.4	1844	1920	11.91597	

## Bin5 Statistics 27

Trial #	Pulse	Chirp (MHz)	Pulse Width (µS)	Pulse 1-2 spacing (µS)	Pulse 2-3 spacing (µS)	Pulse Start(S)	Detection (1:yes; 0:no)
0	2	6	55	1196		0.467247	1
1	2	8	86.2	1916		1.325195	
2	2	18	57.3	1341		1.992438	
3	2	12	76.1	1076		2.589748	
4	1	7	96.7			3.645278	
5	1	5	56.3			4.450914	
6	3	14	95.9	1979	1968	4.853794	
7	2	18	64.6	1892		5.844645	
8	3	8	75.6	1435	1640	6.2942	
9	2	7	81.4	1941		6.830078	
10	3	9	72	1003	1863	7.52417	
11	1	10	56.7			8.652717	
12	3	12	74.3	1870	1177	9.42248	
13	1	17	75			9.850722	
14	3	12	61	1959	1313	10.859738	
15	2	8	56.1	1350		11.388576	

## Bin5 Statistics 28

Trial #	Pulse	Chirp (MHz)	Pulse Width (µS)	Pulse 1-2 spacing (µS)	Pulse 2-3 spacing (µS)	Pulse Start(S)	Detection (1:yes; 0:no)
0	1	20	64.7			0.613079	1
1	2	17	95.9	1544		1.261543	
2	1	5	85.4			2.38202	
3	2	19	57.3	1430		2.971087	
4	2	18	99.6	1242		3.585414	
5	3	20	78	1495	1576	4.396132	
6	3	18	63.6	1220	1413	5.513959	
7	2	15	79.2	1769		6.008441	
8	2	20	93.3	1702		6.90766	
9	3	11	87.1	1371	1845	7.440337	
10	3	19	55.7	1702	1954	8.702189	
11	3	7	90.8	1805	1920	9.064632	
12	2	7	63.2	1909		9.731474	
13	2	20	89.8	1668		10.790371	
14	3	20	59	1769	1361	11.424183	

## Bin5 Statistics 29

Trial #	Pulse	Chirp (MHz)	Pulse Width (µS)	Pulse 1-2 spacing (µS)	Pulse 2-3 spacing (µS)	Pulse Start(S)	Detection (1:yes; 0:no)
0	2	11	95.3	1331		0.321648	1
1	3	12	69.7	1499	1335	1.345459	
2	2	16	64	1631		2.119136	
3	2	7	85.9	1774		3.00343	
4	2	14	56	1875		4.661247	
5	2	12	91.3	1344		5.696039	
6	3	16	72.8	1320	1029	6.945506	
7	3	6	73.2	1293	1226	7.484716	
8	2	11	82.2	1115		8.807089	
9	2	6	94.5	1044		9.282486	
10	2	10	69.5	1659		10.800925	
11	2	9	77.4	1882		11.594473	

## Bin5 Statistics 30

Trial #	Pulse	Chirp (MHz)	Pulse Width (µS)	Pulse 1-2 spacing (µS)	Pulse 2-3 spacing (µS)	Pulse Start(S)	Detection (1:yes; 0:no)
0	1	20	63.5			0.071925	1
1	1	9	92			1.051527	
2	3	15	68.8	1834	1644	1.531599	
3	1	10	50.7			2.617362	
4	1	5	97			3.512253	
5	2	12	73	1016		4.15012	
6	2	20	85.3	1100		4.697798	
7	1	9	60.1			5.050617	
8	1	13	84.7			5.748966	
9	3	18	53.1	1667	1850	6.990669	
10	1	15	80.9			7.080001	
11	1	8	66.3			8.137838	
12	3	6	51.4	1497	1895	8.873654	
13	1	7	51.1			9.76172	
14	1	6	53.8			10.251376	
15	3	13	61.1	1208	1736	10.838513	
16	3	6	80	1950	1332	11.669252	

**Table-6 Radar Type 6 Statistical Performance**

Trial #	Fc (MHz)	Pulse /Burst	Pulse Width (µS)	PRI (µs)	Detection (1:yes; 0:no)	Hopping Sequence
1	5290	9	1	333	1	5305.0, 5672.0, 5566.0, 5602.0, 5266.0, 5379.0, 5282.0, 5427.0, 5501.0, 5630.0, 5559.0, 5696.0, 5428.0, 5707.0, 5703.0, 5574.0, 5348.0, 5680.0, 5561.0, 5513.0, 5429.0, 5639.0, 5611.0, 5476.0, 5720.0, 5391.0, 5261.0, 5370.0, 5355.0, 5596.0, 5358.0, 5377.0, 5507.0, 5600.0, 5362.0, 5658.0, 5534.0, 5661.0, 5435.0, 5709.0, 5451.0, 5692.0, 5459.0, 5645.0, 5485.0, 5323.0, 5504.0, 5667.0, 5318.0, 5589.0, 5576.0, 5252.0, 5339.0, 5472.0, 5584.0, 5390.0, 5344.0, 5456.0, 5695.0, 5640.0, 5597.0, 5437.0, 5343.0, 5652.0, 5670.0, 5255.0, 5511.0, 5465.0, 5412.0, 5705.0, 5628.0, 5325.0, 5388.0, 5310.0, 5678.0, 5641.0, 5365.0, 5347.0, 5439.0, 5269.0, 5643.0, 5480.0, 5383.0, 5708.0, 5294.0, 5336.0, 5587.0, 5481.0, 5306.0, 5516.0, 5491.0, 5567.0, 5353.0, 5552.0, 5691.0, 5398.0, 5418.0, 5535.0, 5533.0, 5271.0 (number of hits: 4)
2	5290	9	1	333	1	5268.0, 5343.0, 5694.0, 5453.0, 5311.0, 5600.0, 5335.0, 5609.0, 5526.0, 5632.0, 5446.0, 5551.0, 5715.0, 5442.0, 5710.0, 5628.0, 5313.0, 5424.0, 5515.0, 5352.0, 5412.0, 5476.0, 5418.0, 5586.0, 5556.0, 5569.0, 5623.0, 5454.0, 5622.0, 5644.0, 5503.0, 5709.0, 5428.0, 5393.0, 5422.0, 5541.0, 5482.0, 5627.0, 5398.0, 5331.0, 5383.0, 5403.0, 5285.0, 5719.0, 5370.0, 5439.0, 5281.0, 5557.0, 5395.0, 5539.0, 5385.0, 5672.0, 5639.0, 5386.0, 5369.0, 5613.0, 5662.0, 5533.0, 5373.0, 5633.0, 5334.0, 5397.0, 5376.0, 5419.0, 5267.0, 5324.0, 5264.0, 5604.0, 5304.0, 5712.0, 5686.0, 5433.0, 5461.0, 5312.0, 5494.0, 5553.0, 5657.0, 5408.0, 5388.0, 5269.0, 5491.0, 5318.0, 5351.0, 5265.0, 5495.0, 5693.0, 5448.0, 5251.0, 5682.0, 5306.0, 5699.0, 5262.0, 5474.0, 5574.0, 5580.0, 5391.0, 5483.0, 5355.0, 5655.0, 5302.0 (number of hits: 7)
3	5290	9	1	333	1	5292.0, 5668.0, 5700.0, 5371.0, 5473.0, 5366.0, 5343.0, 5458.0, 5463.0, 5377.0, 5409.0, 5637.0, 5253.0, 5559.0, 5281.0, 5612.0, 5601.0, 5349.0, 5531.0, 5618.0, 5535.0, 5517.0, 5598.0, 5551.0, 5317.0, 5394.0, 5376.0, 5629.0, 5720.0, 5511.0, 5386.0, 5288.0, 5493.0, 5469.0, 5650.0, 5344.0, 5489.0, 5427.0, 5274.0, 5536.0, 5694.0, 5666.0, 5355.0, 5399.0, 5448.0, 5402.0, 5522.0, 5456.0, 5452.0, 5277.0, 5553.0, 5677.0, 5323.0, 5379.0, 5577.0, 5690.0, 5657.0, 5439.0, 5263.0, 5632.0,

						5483.0, 5646.0, 5555.0, 5610.0, 5684.0, 5380.0, 5342.0, 5549.0, 5282.0, 5689.0, 5481.0, 5529.0, 5259.0, 5368.0, 5387.0, 5548.0, 5600.0, 5625.0, 5703.0, 5418.0, 5516.0, 5542.0, 5616.0, 5571.0, 5546.0, 5415.0, 5579.0, 5698.0, 5284.0, 5357.0, 5327.0, 5609.0, 5494.0, 5692.0, 5644.0, 5351.0, 5487.0, 5653.0, 5401.0, 5680.0 (number of hits: 2 )
4	5290	9	1	333	1	5336.0, 5717.0, 5451.0, 5609.0, 5417.0, 5295.0, 5276.0, 5499.0, 5330.0, 5291.0, 5494.0, 5456.0, 5331.0, 5438.0, 5617.0, 5603.0, 5344.0, 5616.0, 5613.0, 5622.0, 5363.0, 5352.0, 5638.0, 5584.0, 5551.0, 5375.0, 5445.0, 5261.0, 5354.0, 5408.0, 5538.0, 5293.0, 5256.0, 5549.0, 5439.0, 5457.0, 5720.0, 5300.0, 5577.0, 5264.0, 5391.0, 5629.0, 5431.0, 5462.0, 5508.0, 5550.0, 5350.0, 5266.0, 5448.0, 5351.0, 5578.0, 5493.0, 5504.0, 5633.0, 5586.0, 5593.0, 5415.0, 5434.0, 5501.0, 5357.0, 5284.0, 5631.0, 5671.0, 5481.0, 5267.0, 5712.0, 5489.0, 5313.0, 5340.0, 5358.0, 5453.0, 5333.0, 5565.0, 5523.0, 5537.0, 5598.0, 5399.0, 5651.0, 5670.0, 5325.0, 5507.0, 5428.0, 5332.0, 5495.0, 5576.0, 5272.0, 5612.0, 5465.0, 5461.0, 5422.0, 5547.0, 5252.0, 5389.0, 5610.0, 5587.0, 5518.0, 5327.0, 5607.0, 5503.0, 5539.0 (number of hits: 5 )
5	5290	9	1	333	1	5572.0, 5547.0, 5295.0, 5286.0, 5419.0, 5719.0, 5625.0, 5433.0, 5702.0, 5260.0, 5543.0, 5462.0, 5700.0, 5653.0, 5481.0, 5587.0, 5300.0, 5430.0, 5509.0, 5288.0, 5276.0, 5302.0, 5446.0, 5258.0, 5291.0, 5353.0, 5720.0, 5570.0, 5372.0, 5338.0, 5393.0, 5418.0, 5402.0, 5675.0, 5721.0, 5316.0, 5469.0, 5657.0, 5417.0, 5563.0, 5261.0, 5320.0, 5521.0, 5306.0, 5384.0, 5499.0, 5544.0, 5311.0, 5696.0, 5438.0, 5583.0, 5307.0, 5676.0, 5605.0, 5390.0, 5334.0, 5282.0, 5723.0, 5649.0, 5512.0, 5468.0, 5350.0, 5445.0, 5386.0, 5298.0, 5515.0, 5478.0, 5613.0, 5294.0, 5705.0, 5385.0, 5554.0, 5455.0, 5339.0, 5375.0, 5449.0, 5299.0, 5274.0, 5343.0, 5576.0, 5628.0, 5410.0, 5270.0, 5349.0, 5699.0, 5250.0, 5673.0, 5368.0, 5551.0, 5362.0, 5574.0, 5436.0, 5557.0, 5347.0, 5669.0, 5333.0, 5630.0, 5401.0, 5566.0, 5465.0 (number of hits: 12 )
6	5290	9	1	333	1	5692.0, 5614.0, 5489.0, 5629.0, 5291.0, 5473.0, 5656.0, 5315.0, 5556.0, 5702.0, 5514.0, 5635.0, 5560.0, 5538.0, 5628.0, 5348.0, 5474.0, 5515.0, 5280.0, 5616.0, 5302.0, 5606.0, 5574.0, 5416.0, 5277.0, 5425.0, 5285.0, 5414.0, 5260.0, 5334.0, 5284.0, 5503.0, 5389.0, 5512.0, 5607.0, 5483.0, 5383.0, 5257.0, 5504.0, 5613.0,

						5410.0, 5676.0, 5409.0, 5657.0, 5407.0, 5678.0, 5612.0, 5561.0, 5477.0, 5367.0, 5345.0, 5482.0, 5697.0, 5262.0, 5436.0, 5310.0, 5347.0, 5518.0, 5264.0, 5261.0, 5509.0, 5272.0, 5371.0, 5453.0, 5585.0, 5354.0, 5570.0, 5653.0, 5693.0, 5539.0, 5571.0, 5625.0, 5266.0, 5486.0, 5535.0, 5458.0, 5488.0, 5591.0, 5442.0, 5479.0, 5573.0, 5420.0, 5271.0, 5263.0, 5362.0, 5351.0, 5460.0, 5517.0, 5304.0, 5417.0, 5364.0, 5620.0, 5578.0, 5670.0, 5413.0, 5550.0, 5665.0, 5314.0, 5626.0, 5519.0 (number of hits: 6)
7	5290	9	1	333	1	5358.0, 5325.0, 5251.0, 5631.0, 5707.0, 5532.0, 5441.0, 5552.0, 5564.0, 5455.0, 5588.0, 5658.0, 5336.0, 5487.0, 5369.0, 5596.0, 5407.0, 5446.0, 5619.0, 5283.0, 5624.0, 5399.0, 5499.0, 5543.0, 5356.0, 5524.0, 5721.0, 5307.0, 5419.0, 5379.0, 5722.0, 5615.0, 5350.0, 5561.0, 5423.0, 5525.0, 5601.0, 5521.0, 5621.0, 5397.0, 5435.0, 5457.0, 5637.0, 5405.0, 5549.0, 5373.0, 5424.0, 5479.0, 5452.0, 5359.0, 5695.0, 5556.0, 5559.0, 5265.0, 5712.0, 5632.0, 5654.0, 5574.0, 5371.0, 5506.0, 5513.0, 5475.0, 5541.0, 5335.0, 5492.0, 5418.0, 5719.0, 5431.0, 5302.0, 5659.0, 5576.0, 5607.0, 5655.0, 5587.0, 5333.0, 5640.0, 5275.0, 5451.0, 5427.0, 5690.0, 5523.0, 5417.0, 5270.0, 5338.0, 5636.0, 5566.0, 5648.0, 5374.0, 5381.0, 5528.0, 5391.0, 5346.0, 5394.0, 5485.0, 5323.0, 5422.0, 5489.0, 5575.0, 5573.0, 5653.0 (number of hits: 2)
8	5290	9	1	333	1	5402.0, 5676.0, 5593.0, 5308.0, 5312.0, 5490.0, 5492.0, 5586.0, 5385.0, 5380.0, 5452.0, 5709.0, 5533.0, 5403.0, 5316.0, 5511.0, 5619.0, 5269.0, 5306.0, 5671.0, 5632.0, 5598.0, 5624.0, 5663.0, 5712.0, 5706.0, 5337.0, 5612.0, 5265.0, 5672.0, 5428.0, 5580.0, 5659.0, 5693.0, 5578.0, 5617.0, 5541.0, 5601.0, 5645.0, 5422.0, 5500.0, 5469.0, 5486.0, 5325.0, 5282.0, 5413.0, 5356.0, 5700.0, 5568.0, 5570.0, 5605.0, 5689.0, 5610.0, 5716.0, 5391.0, 5680.0, 5687.0, 5615.0, 5440.0, 5343.0, 5620.0, 5278.0, 5597.0, 5608.0, 5445.0, 5647.0, 5357.0, 5583.0, 5251.0, 5253.0, 5489.0, 5363.0, 5529.0, 5407.0, 5479.0, 5688.0, 5355.0, 5555.0, 5366.0, 5525.0, 5635.0, 5252.0, 5416.0, 5501.0, 5644.0, 5359.0, 5639.0, 5502.0, 5585.0, 5333.0, 5655.0, 5522.0, 5477.0, 5259.0, 5277.0, 5330.0, 5467.0, 5512.0, 5464.0, 5424.0 (number of hits: 3)
9	5290	9	1	333	1	5472.0, 5591.0, 5401.0, 5282.0, 5366.0, 5433.0, 5504.0, 5276.0, 5278.0, 5342.0, 5402.0, 5261.0, 5596.0, 5458.0, 5334.0, 5577.0, 5597.0, 5667.0, 5466.0, 5369.0,



						5645.0, 5513.0, 5425.0, 5519.0, 5509.0, 5271.0, 5560.0, 5674.0, 5659.0, 5321.0, 5338.0, 5694.0, 5365.0, 5653.0, 5587.0, 5399.0, 5665.0, 5705.0, 5523.0, 5343.0, 5558.0, 5677.0, 5269.0, 5640.0, 5566.0, 5489.0, 5719.0, 5573.0, 5275.0, 5589.0, 5518.0, 5547.0, 5387.0, 5391.0, 5613.0, 5373.0, 5641.0, 5711.0, 5692.0, 5615.0, 5559.0, 5608.0, 5337.0, 5514.0, 5701.0, 5485.0, 5525.0, 5467.0, 5530.0, 5298.0, 5413.0, 5406.0, 5422.0, 5570.0, 5359.0, 5620.0, 5364.0, 5380.0, 5594.0, 5673.0, 5441.0, 5353.0, 5431.0, 5317.0, 5495.0, 5259.0, 5257.0, 5657.0, 5663.0, 5574.0, 5426.0, 5707.0, 5252.0, 5627.0, 5306.0, 5447.0, 5609.0, 5469.0, 5639.0, 5492.0 (number of hits: 2 )
10	5290	9	1	333	1	5673.0, 5412.0, 5680.0, 5641.0, 5584.0, 5344.0, 5699.0, 5633.0, 5278.0, 5287.0, 5430.0, 5357.0, 5399.0, 5386.0, 5400.0, 5387.0, 5499.0, 5351.0, 5477.0, 5438.0, 5383.0, 5598.0, 5364.0, 5662.0, 5514.0, 5504.0, 5603.0, 5326.0, 5467.0, 5528.0, 5654.0, 5466.0, 5288.0, 5343.0, 5381.0, 5722.0, 5469.0, 5338.0, 5631.0, 5318.0, 5692.0, 5308.0, 5296.0, 5260.0, 5573.0, 5291.0, 5548.0, 5674.0, 5567.0, 5621.0, 5453.0, 5537.0, 5636.0, 5710.0, 5375.0, 5316.0, 5409.0, 5510.0, 5607.0, 5369.0, 5439.0, 5398.0, 5314.0, 5702.0, 5283.0, 5666.0, 5358.0, 5437.0, 5646.0, 5543.0, 5413.0, 5591.0, 5592.0, 5658.0, 5581.0, 5304.0, 5500.0, 5372.0, 5513.0, 5302.0, 5706.0, 5667.0, 5562.0, 5565.0, 5339.0, 5345.0, 5563.0, 5540.0, 5448.0, 5334.0, 5527.0, 5677.0, 5271.0, 5539.0, 5323.0, 5618.0, 5550.0, 5451.0, 5723.0, 5505.0 (number of hits: 8 )
11	5290	9	1	333	1	5359.0, 5664.0, 5671.0, 5435.0, 5417.0, 5311.0, 5286.0, 5475.0, 5269.0, 5372.0, 5481.0, 5313.0, 5499.0, 5659.0, 5260.0, 5393.0, 5472.0, 5430.0, 5721.0, 5328.0, 5446.0, 5527.0, 5626.0, 5315.0, 5595.0, 5464.0, 5571.0, 5674.0, 5655.0, 5648.0, 5551.0, 5392.0, 5420.0, 5251.0, 5405.0, 5431.0, 5486.0, 5572.0, 5398.0, 5381.0, 5704.0, 5691.0, 5647.0, 5470.0, 5373.0, 5693.0, 5669.0, 5483.0, 5681.0, 5444.0, 5294.0, 5640.0, 5254.0, 5554.0, 5321.0, 5617.0, 5613.0, 5482.0, 5607.0, 5599.0, 5371.0, 5451.0, 5600.0, 5705.0, 5627.0, 5458.0, 5288.0, 5537.0, 5478.0, 5460.0, 5345.0, 5534.0, 5278.0, 5342.0, 5602.0, 5447.0, 5369.0, 5257.0, 5580.0, 5707.0, 5346.0, 5588.0, 5523.0, 5415.0, 5532.0, 5480.0, 5487.0, 5565.0, 5710.0, 5261.0, 5550.0, 5340.0, 5469.0, 5409.0, 5496.0, 5543.0, 5525.0, 5400.0, 5423.0, 5274.0 (number of hits: 5 )

12	5290	9	1	333	1	5615.0, 5713.0, 5627.0, 5601.0, 5623.0, 5264.0, 5606.0, 5419.0, 5309.0, 5637.0, 5503.0, 5679.0, 5594.0, 5494.0, 5440.0, 5413.0, 5347.0, 5529.0, 5663.0, 5368.0, 5376.0, 5475.0, 5717.0, 5499.0, 5282.0, 5343.0, 5643.0, 5609.0, 5391.0, 5613.0, 5366.0, 5319.0, 5273.0, 5619.0, 5488.0, 5700.0, 5472.0, 5304.0, 5384.0, 5473.0, 5686.0, 5620.0, 5299.0, 5595.0, 5354.0, 5402.0, 5522.0, 5592.0, 5467.0, 5308.0, 5704.0, 5306.0, 5423.0, 5271.0, 5562.0, 5608.0, 5377.0, 5292.0, 5685.0, 5545.0, 5425.0, 5677.0, 5365.0, 5655.0, 5568.0, 5471.0, 5312.0, 5486.0, 5404.0, 5511.0, 5371.0, 5651.0, 5286.0, 5611.0, 5501.0, 5433.0, 5310.0, 5416.0, 5579.0, 5504.0, 5324.0, 5567.0, 5287.0, 5458.0, 5399.0, 5706.0, 5383.0, 5253.0, 5558.0, 5361.0, 5502.0, 5378.0, 5548.0, 5411.0, 5554.0, 5418.0, 5412.0, 5298.0, 5582.0, 5695.0 (number of hits: 11)
13	5290	9	1	333	1	5629.0, 5710.0, 5584.0, 5285.0, 5672.0, 5601.0, 5662.0, 5498.0, 5545.0, 5439.0, 5294.0, 5342.0, 5689.0, 5421.0, 5574.0, 5707.0, 5489.0, 5527.0, 5658.0, 5266.0, 5490.0, 5447.0, 5396.0, 5693.0, 5334.0, 5586.0, 5358.0, 5578.0, 5585.0, 5618.0, 5519.0, 5326.0, 5677.0, 5349.0, 5646.0, 5307.0, 5429.0, 5308.0, 5531.0, 5603.0, 5607.0, 5458.0, 5280.0, 5563.0, 5593.0, 5614.0, 5673.0, 5514.0, 5352.0, 5377.0, 5571.0, 5633.0, 5621.0, 5525.0, 5443.0, 5697.0, 5509.0, 5375.0, 5357.0, 5480.0, 5581.0, 5518.0, 5305.0, 5313.0, 5257.0, 5379.0, 5694.0, 5269.0, 5720.0, 5577.0, 5701.0, 5455.0, 5457.0, 5386.0, 5636.0, 5337.0, 5255.0, 5465.0, 5572.0, 5476.0, 5329.0, 5279.0, 5599.0, 5289.0, 5721.0, 5576.0, 5705.0, 5311.0, 5398.0, 5268.0, 5524.0, 5434.0, 5382.0, 5263.0, 5479.0, 5325.0, 5422.0, 5464.0, 5300.0, 5610.0 (number of hits: 9)
14	5290	9	1	333	1	5645.0, 5393.0, 5531.0, 5270.0, 5519.0, 5656.0, 5367.0, 5422.0, 5460.0, 5487.0, 5703.0, 5682.0, 5442.0, 5566.0, 5438.0, 5558.0, 5510.0, 5685.0, 5332.0, 5313.0, 5707.0, 5681.0, 5514.0, 5568.0, 5526.0, 5317.0, 5406.0, 5469.0, 5418.0, 5587.0, 5377.0, 5330.0, 5348.0, 5556.0, 5342.0, 5691.0, 5314.0, 5590.0, 5504.0, 5601.0, 5489.0, 5496.0, 5670.0, 5316.0, 5345.0, 5631.0, 5325.0, 5620.0, 5530.0, 5516.0, 5362.0, 5318.0, 5293.0, 5705.0, 5366.0, 5431.0, 5661.0, 5271.0, 5324.0, 5397.0, 5266.0, 5647.0, 5562.0, 5699.0, 5286.0, 5604.0, 5415.0, 5465.0, 5347.0, 5253.0, 5550.0, 5365.0, 5575.0, 5520.0, 5413.0, 5326.0, 5435.0, 5376.0, 5412.0, 5447.0, 5513.0, 5494.0, 5450.0, 5605.0, 5679.0

						5420.0, 5275.0, 5462.0, 5322.0, 5339.0, 5352.0, 5598.0, 5290.0, 5649.0, 5525.0, 5364.0, 5333.0, 5606.0, 5486.0, 5344.0 (number of hits: 5)
15	5290	9	1	333	1	5630.0, 5264.0, 5484.0, 5397.0, 5507.0, 5565.0, 5654.0, 5313.0, 5452.0, 5480.0, 5591.0, 5635.0, 5490.0, 5293.0, 5470.0, 5582.0, 5641.0, 5431.0, 5287.0, 5282.0, 5518.0, 5420.0, 5437.0, 5656.0, 5382.0, 5468.0, 5639.0, 5674.0, 5601.0, 5491.0, 5252.0, 5296.0, 5389.0, 5542.0, 5253.0, 5412.0, 5472.0, 5564.0, 5710.0, 5651.0, 5508.0, 5617.0, 5584.0, 5265.0, 5648.0, 5705.0, 5598.0, 5679.0, 5578.0, 5613.0, 5695.0, 5647.0, 5500.0, 5467.0, 5321.0, 5523.0, 5377.0, 5290.0, 5356.0, 5612.0, 5280.0, 5477.0, 5369.0, 5260.0, 5514.0, 5456.0, 5646.0, 5716.0, 5272.0, 5351.0, 5703.0, 5492.0, 5699.0, 5696.0, 5341.0, 5634.0, 5509.0, 5528.0, 5271.0, 5504.0, 5574.0, 5352.0, 5548.0, 5474.0, 5347.0, 5250.0, 5515.0, 5512.0, 5275.0, 5505.0, 5682.0, 5510.0, 5424.0, 5692.0, 5569.0, 5314.0, 5261.0, 5429.0, 5534.0, 5592.0 (number of hits: 6)
16	5290	9	1	333	1	5583.0, 5316.0, 5574.0, 5425.0, 5465.0, 5415.0, 5671.0, 5538.0, 5331.0, 5491.0, 5322.0, 5522.0, 5365.0, 5369.0, 5317.0, 5644.0, 5295.0, 5479.0, 5287.0, 5343.0, 5422.0, 5580.0, 5391.0, 5279.0, 5327.0, 5482.0, 5656.0, 5535.0, 5267.0, 5445.0, 5354.0, 5655.0, 5557.0, 5265.0, 5505.0, 5613.0, 5651.0, 5292.0, 5389.0, 5660.0, 5281.0, 5571.0, 5537.0, 5495.0, 5717.0, 5667.0, 5443.0, 5578.0, 5350.0, 5549.0, 5413.0, 5524.0, 5520.0, 5629.0, 5640.0, 5620.0, 5553.0, 5590.0, 5552.0, 5448.0, 5450.0, 5490.0, 5441.0, 5257.0, 5468.0, 5635.0, 5497.0, 5692.0, 5471.0, 5344.0, 5577.0, 5596.0, 5277.0, 5286.0, 5424.0, 5418.0, 5466.0, 5707.0, 5690.0, 5702.0, 5531.0, 5342.0, 5603.0, 5306.0, 5435.0, 5370.0, 5258.0, 5270.0, 5683.0, 5506.0, 5492.0, 5610.0, 5632.0, 5516.0, 5378.0, 5619.0, 5622.0, 5681.0, 5261.0, 5298.0 (number of hits: 6)
17	5290	9	1	333	1	5592.0, 5510.0, 5307.0, 5639.0, 5547.0, 5432.0, 5361.0, 5568.0, 5478.0, 5646.0, 5362.0, 5345.0, 5598.0, 5259.0, 5652.0, 5491.0, 5398.0, 5471.0, 5299.0, 5282.0, 5277.0, 5473.0, 5680.0, 5420.0, 5644.0, 5375.0, 5703.0, 5395.0, 5402.0, 5512.0, 5334.0, 5392.0, 5435.0, 5689.0, 5697.0, 5593.0, 5716.0, 5342.0, 5637.0, 5663.0, 5396.0, 5315.0, 5542.0, 5258.0, 5447.0, 5448.0, 5578.0, 5659.0, 5425.0, 5522.0, 5404.0, 5714.0, 5496.0, 5440.0, 5386.0, 5408.0, 5604.0, 5704.0, 5309.0, 5615.0, 5469.0, 5573.0, 5651.0, 5257.0, 5600.0,

						5379.0, 5617.0, 5351.0, 5649.0, 5564.0, 5261.0, 5461.0, 5267.0, 5587.0, 5613.0, 5429.0, 5706.0, 5674.0, 5518.0, 5541.0, 5647.0, 5638.0, 5503.0, 5406.0, 5524.0, 5672.0, 5422.0, 5451.0, 5544.0, 5467.0, 5631.0, 5621.0, 5715.0, 5673.0, 5504.0, 5489.0, 5454.0, 5582.0, 5483.0, 5389.0 (number of hits: 3 )
18	5290	9	1	333	1	5319.0, 5446.0, 5359.0, 5434.0, 5482.0, 5695.0, 5352.0, 5387.0, 5277.0, 5649.0, 5316.0, 5490.0, 5254.0, 5364.0, 5633.0, 5414.0, 5305.0, 5264.0, 5388.0, 5272.0, 5628.0, 5644.0, 5453.0, 5655.0, 5698.0, 5365.0, 5301.0, 5348.0, 5252.0, 5583.0, 5439.0, 5615.0, 5250.0, 5432.0, 5486.0, 5419.0, 5530.0, 5561.0, 5257.0, 5563.0, 5396.0, 5668.0, 5447.0, 5525.0, 5351.0, 5511.0, 5412.0, 5717.0, 5626.0, 5270.0, 5299.0, 5493.0, 5292.0, 5376.0, 5337.0, 5603.0, 5287.0, 5705.0, 5686.0, 5343.0, 5595.0, 5303.0, 5394.0, 5402.0, 5415.0, 5600.0, 5288.0, 5690.0, 5515.0, 5390.0, 5268.0, 5580.0, 5502.0, 5398.0, 5284.0, 5672.0, 5495.0, 5315.0, 5310.0, 5586.0, 5311.0, 5370.0, 5380.0, 5674.0, 5451.0, 5702.0, 5638.0, 5499.0, 5409.0, 5651.0, 5477.0, 5517.0, 5289.0, 5459.0, 5291.0, 5681.0, 5556.0, 5578.0, 5684.0, 5689.0 (number of hits: 11 )
19	5290	9	1	333	1	5723.0, 5339.0, 5377.0, 5256.0, 5632.0, 5580.0, 5396.0, 5327.0, 5422.0, 5628.0, 5291.0, 5669.0, 5613.0, 5481.0, 5366.0, 5535.0, 5688.0, 5304.0, 5616.0, 5513.0, 5351.0, 5251.0, 5254.0, 5318.0, 5323.0, 5496.0, 5300.0, 5272.0, 5629.0, 5622.0, 5391.0, 5340.0, 5342.0, 5343.0, 5588.0, 5701.0, 5316.0, 5681.0, 5266.0, 5435.0, 5288.0, 5719.0, 5559.0, 5660.0, 5283.0, 5495.0, 5695.0, 5301.0, 5344.0, 5268.0, 5515.0, 5345.0, 5592.0, 5303.0, 5456.0, 5467.0, 5540.0, 5659.0, 5507.0, 5418.0, 5364.0, 5346.0, 5641.0, 5690.0, 5450.0, 5341.0, 5692.0, 5458.0, 5433.0, 5393.0, 5274.0, 5612.0, 5596.0, 5276.0, 5593.0, 5575.0, 5597.0, 5499.0, 5317.0, 5394.0, 5700.0, 5532.0, 5371.0, 5531.0, 5606.0, 5670.0, 5648.0, 5460.0, 5703.0, 5454.0, 5411.0, 5442.0, 5407.0, 5678.0, 5652.0, 5526.0, 5566.0, 5564.0, 5380.0, 5684.0 (number of hits: 6 )
20	5290	9	1	333	1	5441.0, 5640.0, 5688.0, 5435.0, 5442.0, 5500.0, 5554.0, 5677.0, 5252.0, 5364.0, 5623.0, 5478.0, 5635.0, 5480.0, 5359.0, 5605.0, 5326.0, 5667.0, 5305.0, 5379.0, 5336.0, 5451.0, 5395.0, 5575.0, 5355.0, 5573.0, 5456.0, 5686.0, 5279.0, 5549.0, 5724.0, 5661.0, 5494.0, 5641.0, 5696.0, 5308.0, 5691.0, 5614.0, 5422.0, 5550.0, 5619.0, 5639.0, 5445.0, 5528.0, 5563.0,

						5283.0, 5571.0, 5334.0, 5626.0, 5438.0, 5591.0, 5570.0, 5631.0, 5617.0, 5280.0, 5381.0, 5572.0, 5372.0, 5432.0, 5288.0, 5302.0, 5561.0, 5272.0, 5277.0, 5419.0, 5479.0, 5489.0, 5597.0, 5261.0, 5327.0, 5318.0, 5430.0, 5522.0, 5707.0, 5433.0, 5310.0, 5559.0, 5459.0, 5599.0, 5625.0, 5557.0, 5600.0, 5654.0, 5580.0, 5608.0, 5495.0, 5497.0, 5373.0, 5385.0, 5499.0, 5306.0, 5377.0, 5332.0, 5674.0, 5388.0, 5462.0, 5397.0, 5361.0, 5496.0, 5577.0 (number of hits: 6)
21	5290	9	1	333	1	5365.0, 5438.0, 5689.0, 5722.0, 5523.0, 5310.0, 5650.0, 5303.0, 5545.0, 5253.0, 5697.0, 5528.0, 5387.0, 5529.0, 5343.0, 5263.0, 5327.0, 5466.0, 5333.0, 5533.0, 5561.0, 5526.0, 5301.0, 5640.0, 5694.0, 5392.0, 5357.0, 5716.0, 5574.0, 5406.0, 5656.0, 5626.0, 5550.0, 5652.0, 5290.0, 5543.0, 5298.0, 5713.0, 5307.0, 5344.0, 5419.0, 5287.0, 5622.0, 5673.0, 5317.0, 5481.0, 5476.0, 5326.0, 5318.0, 5474.0, 5270.0, 5551.0, 5277.0, 5289.0, 5703.0, 5462.0, 5295.0, 5281.0, 5685.0, 5366.0, 5369.0, 5471.0, 5637.0, 5402.0, 5445.0, 5364.0, 5675.0, 5643.0, 5597.0, 5619.0, 5401.0, 5267.0, 5329.0, 5589.0, 5491.0, 5421.0, 5606.0, 5569.0, 5396.0, 5378.0, 5568.0, 5400.0, 5711.0, 5500.0, 5524.0, 5591.0, 5498.0, 5570.0, 5671.0, 5261.0, 5410.0, 5617.0, 5556.0, 5564.0, 5399.0, 5712.0, 5615.0, 5255.0, 5324.0, 5251.0 (number of hits: 9)
22	5290	9	1	333	1	5698.0, 5388.0, 5264.0, 5310.0, 5690.0, 5713.0, 5594.0, 5676.0, 5630.0, 5702.0, 5384.0, 5340.0, 5358.0, 5334.0, 5585.0, 5361.0, 5618.0, 5685.0, 5518.0, 5300.0, 5694.0, 5295.0, 5398.0, 5473.0, 5628.0, 5294.0, 5545.0, 5442.0, 5392.0, 5415.0, 5339.0, 5450.0, 5374.0, 5506.0, 5596.0, 5584.0, 5259.0, 5252.0, 5268.0, 5461.0, 5297.0, 5664.0, 5576.0, 5368.0, 5486.0, 5611.0, 5571.0, 5527.0, 5614.0, 5281.0, 5433.0, 5463.0, 5332.0, 5298.0, 5412.0, 5500.0, 5504.0, 5563.0, 5280.0, 5416.0, 5338.0, 5507.0, 5378.0, 5429.0, 5539.0, 5589.0, 5538.0, 5354.0, 5719.0, 5422.0, 5326.0, 5365.0, 5393.0, 5279.0, 5330.0, 5260.0, 5704.0, 5436.0, 5598.0, 5605.0, 5455.0, 5290.0, 5438.0, 5683.0, 5408.0, 5444.0, 5612.0, 5306.0, 5645.0, 5528.0, 5669.0, 5360.0, 5679.0, 5377.0, 5382.0, 5517.0, 5559.0, 5314.0, 5503.0, 5660.0 (number of hits: 9)
23	5290	9	1	333	1	5273.0, 5582.0, 5593.0, 5333.0, 5581.0, 5527.0, 5462.0, 5436.0, 5485.0, 5564.0, 5475.0, 5328.0, 5612.0, 5301.0, 5578.0, 5547.0, 5502.0, 5517.0, 5553.0, 5486.0, 5355.0, 5575.0, 5510.0, 5611.0, 5636.0,

						5424.0, 5334.0, 5303.0, 5422.0, 5552.0, 5385.0, 5341.0, 5604.0, 5526.0, 5407.0, 5289.0, 5433.0, 5371.0, 5721.0, 5621.0, 5561.0, 5685.0, 5340.0, 5491.0, 5659.0, 5550.0, 5504.0, 5254.0, 5285.0, 5590.0, 5689.0, 5656.0, 5441.0, 5675.0, 5459.0, 5255.0, 5658.0, 5378.0, 5426.0, 5615.0, 5716.0, 5536.0, 5674.0, 5509.0, 5447.0, 5622.0, 5696.0, 5306.0, 5641.0, 5419.0, 5420.0, 5719.0, 5351.0, 5344.0, 5457.0, 5471.0, 5390.0, 5313.0, 5294.0, 5472.0, 5425.0, 5532.0, 5589.0, 5661.0, 5703.0, 5701.0, 5410.0, 5279.0, 5448.0, 5640.0, 5668.0, 5653.0, 5495.0, 5706.0, 5359.0, 5275.0, 5482.0, 5468.0, 5657.0, 5620.0 (number of hits: 7)
24	5290	9	1	333	1	5662.0, 5282.0, 5702.0, 5704.0, 5654.0, 5633.0, 5563.0, 5669.0, 5493.0, 5639.0, 5409.0, 5626.0, 5528.0, 5623.0, 5494.0, 5722.0, 5319.0, 5700.0, 5377.0, 5604.0, 5684.0, 5679.0, 5698.0, 5646.0, 5543.0, 5470.0, 5628.0, 5602.0, 5660.0, 5474.0, 5256.0, 5421.0, 5435.0, 5585.0, 5481.0, 5269.0, 5609.0, 5365.0, 5331.0, 5490.0, 5347.0, 5262.0, 5632.0, 5530.0, 5529.0, 5612.0, 5314.0, 5580.0, 5420.0, 5372.0, 5303.0, 5645.0, 5667.0, 5368.0, 5410.0, 5393.0, 5671.0, 5476.0, 5514.0, 5550.0, 5482.0, 5673.0, 5631.0, 5562.0, 5442.0, 5253.0, 5525.0, 5356.0, 5350.0, 5449.0, 5354.0, 5706.0, 5395.0, 5642.0, 5294.0, 5325.0, 5320.0, 5333.0, 5708.0, 5450.0, 5487.0, 5677.0, 5321.0, 5635.0, 5374.0, 5471.0, 5367.0, 5515.0, 5339.0, 5505.0, 5297.0, 5611.0, 5600.0, 5522.0, 5334.0, 5295.0, 5586.0, 5468.0, 5516.0, 5370.0 (number of hits: 5)
25	5290	9	1	333	1	5588.0, 5499.0, 5717.0, 5405.0, 5367.0, 5412.0, 5365.0, 5688.0, 5578.0, 5488.0, 5315.0, 5454.0, 5647.0, 5550.0, 5592.0, 5264.0, 5685.0, 5359.0, 5472.0, 5579.0, 5394.0, 5484.0, 5645.0, 5481.0, 5286.0, 5353.0, 5428.0, 5524.0, 5345.0, 5464.0, 5561.0, 5372.0, 5410.0, 5533.0, 5357.0, 5508.0, 5594.0, 5595.0, 5366.0, 5638.0, 5442.0, 5319.0, 5438.0, 5663.0, 5291.0, 5409.0, 5351.0, 5600.0, 5558.0, 5342.0, 5611.0, 5280.0, 5343.0, 5401.0, 5462.0, 5599.0, 5703.0, 5516.0, 5698.0, 5363.0, 5466.0, 5416.0, 5334.0, 5525.0, 5637.0, 5377.0, 5692.0, 5473.0, 5368.0, 5287.0, 5572.0, 5434.0, 5564.0, 5567.0, 5584.0, 5324.0, 5702.0, 5476.0, 5650.0, 5544.0, 5530.0, 5339.0, 5392.0, 5552.0, 5446.0, 5527.0, 5374.0, 5338.0, 5283.0, 5445.0, 5347.0, 5573.0, 5500.0, 5355.0, 5316.0, 5596.0, 5569.0, 5301.0, 5581.0, 5479.0 (number of hits: 4)
26	5290	9	1	333	1	5630.0, 5569.0, 5486.0, 5397.0, 5438.0,

						5635.0, 5322.0, 5504.0, 5551.0, 5618.0, 5601.0, 5345.0, 5639.0, 5616.0, 5511.0, 5690.0, 5423.0, 5374.0, 5466.0, 5678.0, 5390.0, 5292.0, 5596.0, 5256.0, 5682.0, 5642.0, 5651.0, 5420.0, 5432.0, 5342.0, 5509.0, 5377.0, 5627.0, 5488.0, 5417.0, 5557.0, 5489.0, 5291.0, 5268.0, 5281.0, 5614.0, 5722.0, 5300.0, 5360.0, 5567.0, 5594.0, 5487.0, 5503.0, 5310.0, 5376.0, 5312.0, 5330.0, 5274.0, 5654.0, 5271.0, 5523.0, 5400.0, 5664.0, 5582.0, 5526.0, 5552.0, 5294.0, 5721.0, 5653.0, 5369.0, 5695.0, 5471.0, 5680.0, 5550.0, 5407.0, 5251.0, 5388.0, 5636.0, 5597.0, 5715.0, 5359.0, 5328.0, 5525.0, 5698.0, 5570.0, 5484.0, 5387.0, 5375.0, 5650.0, 5332.0, 5361.0, 5689.0, 5480.0, 5333.0, 5350.0, 5449.0, 5628.0, 5657.0, 5264.0, 5609.0, 5566.0, 5674.0, 5280.0, 5472.0, 5605.0 (number of hits: 6)
27	5290	9	1	333	1	5509.0, 5651.0, 5594.0, 5618.0, 5347.0, 5275.0, 5658.0, 5336.0, 5722.0, 5702.0, 5631.0, 5519.0, 5306.0, 5713.0, 5510.0, 5663.0, 5386.0, 5610.0, 5559.0, 5632.0, 5567.0, 5528.0, 5298.0, 5500.0, 5396.0, 5547.0, 5449.0, 5394.0, 5530.0, 5666.0, 5538.0, 5717.0, 5427.0, 5430.0, 5711.0, 5290.0, 5283.0, 5360.0, 5640.0, 5474.0, 5609.0, 5377.0, 5635.0, 5481.0, 5302.0, 5688.0, 5668.0, 5611.0, 5495.0, 5313.0, 5310.0, 5345.0, 5457.0, 5573.0, 5710.0, 5721.0, 5434.0, 5645.0, 5374.0, 5252.0, 5484.0, 5716.0, 5387.0, 5267.0, 5384.0, 5503.0, 5566.0, 5613.0, 5339.0, 5714.0, 5600.0, 5514.0, 5462.0, 5416.0, 5697.0, 5670.0, 5397.0, 5410.0, 5271.0, 5455.0, 5527.0, 5286.0, 5281.0, 5314.0, 5665.0, 5371.0, 5490.0, 5648.0, 5389.0, 5356.0, 5625.0, 5672.0, 5372.0, 5473.0, 5657.0, 5460.0, 5466.0, 5537.0, 5563.0, 5400.0 (number of hits: 8)
28	5290	9	1	333	1	5431.0, 5499.0, 5557.0, 5380.0, 5647.0, 5460.0, 5312.0, 5506.0, 5578.0, 5545.0, 5569.0, 5593.0, 5369.0, 5510.0, 5514.0, 5440.0, 5332.0, 5329.0, 5465.0, 5640.0, 5467.0, 5601.0, 5533.0, 5423.0, 5650.0, 5718.0, 5366.0, 5488.0, 5699.0, 5483.0, 5512.0, 5660.0, 5355.0, 5448.0, 5710.0, 5677.0, 5414.0, 5634.0, 5252.0, 5300.0, 5461.0, 5395.0, 5624.0, 5276.0, 5430.0, 5435.0, 5441.0, 5508.0, 5474.0, 5275.0, 5711.0, 5678.0, 5452.0, 5347.0, 5401.0, 5523.0, 5284.0, 5470.0, 5633.0, 5443.0, 5408.0, 5645.0, 5254.0, 5602.0, 5717.0, 5643.0, 5426.0, 5321.0, 5549.0, 5723.0, 5658.0, 5671.0, 5354.0, 5673.0, 5439.0, 5642.0, 5495.0, 5269.0, 5445.0, 5261.0, 5377.0, 5446.0, 5616.0, 5687.0, 5688.0, 5400.0, 5553.0, 5389.0, 5343.0, 5532.0

						5555.0, 5392.0, 5585.0, 5475.0, 5378.0, 5303.0, 5648.0, 5487.0, 5586.0, 5397.0 (number of hits: 3 )
29	5290	9	1	333	1	5390.0, 5344.0, 5592.0, 5250.0, 5447.0, 5602.0, 5330.0, 5667.0, 5711.0, 5503.0, 5294.0, 5627.0, 5308.0, 5587.0, 5445.0, 5337.0, 5640.0, 5272.0, 5303.0, 5350.0, 5524.0, 5489.0, 5487.0, 5521.0, 5582.0, 5254.0, 5454.0, 5317.0, 5515.0, 5543.0, 5719.0, 5572.0, 5706.0, 5616.0, 5259.0, 5635.0, 5275.0, 5564.0, 5655.0, 5385.0, 5411.0, 5614.0, 5709.0, 5522.0, 5463.0, 5578.0, 5424.0, 5336.0, 5683.0, 5441.0, 5318.0, 5461.0, 5312.0, 5343.0, 5647.0, 5510.0, 5653.0, 5702.0, 5319.0, 5284.0, 5405.0, 5562.0, 5444.0, 5530.0, 5699.0, 5349.0, 5609.0, 5675.0, 5622.0, 5668.0, 5492.0, 5263.0, 5692.0, 5295.0, 5517.0, 5417.0, 5456.0, 5301.0, 5597.0, 5446.0, 5663.0, 5657.0, 5626.0, 5607.0, 5409.0, 5509.0, 5712.0, 5377.0, 5669.0, 5471.0, 5320.0, 5324.0, 5528.0, 5519.0, 5670.0, 5413.0, 5700.0, 5407.0, 5401.0, 5372.0 (number of hits: 6 )
30	5290	9	1	333	1	5447.0, 5425.0, 5700.0, 5429.0, 5276.0, 5296.0, 5527.0, 5612.0, 5345.0, 5668.0, 5684.0, 5377.0, 5628.0, 5676.0, 5287.0, 5314.0, 5354.0, 5497.0, 5587.0, 5250.0, 5619.0, 5434.0, 5698.0, 5724.0, 5442.0, 5454.0, 5669.0, 5277.0, 5681.0, 5516.0, 5675.0, 5557.0, 5342.0, 5639.0, 5479.0, 5626.0, 5714.0, 5709.0, 5706.0, 5403.0, 5474.0, 5505.0, 5411.0, 5288.0, 5317.0, 5492.0, 5367.0, 5423.0, 5378.0, 5428.0, 5457.0, 5511.0, 5540.0, 5353.0, 5542.0, 5279.0, 5537.0, 5264.0, 5683.0, 5691.0, 5584.0, 5255.0, 5667.0, 5393.0, 5623.0, 5292.0, 5274.0, 5419.0, 5722.0, 5705.0, 5560.0, 5586.0, 5685.0, 5690.0, 5596.0, 5364.0, 5260.0, 5633.0, 5397.0, 5382.0, 5450.0, 5307.0, 5651.0, 5359.0, 5559.0, 5333.0, 5531.0, 5366.0, 5688.0, 5439.0, 5617.0, 5618.0, 5335.0, 5427.0, 5480.0, 5717.0, 5602.0, 5613.0, 5620.0, 5576.0 (number of hits: 6 )



**5530 MHz, 80 MHz Bandwidth**

<b>Radar Signal Type</b>	<b>Waveform/Trial Number</b>	<b>Detection (%)</b>	<b>Limit (%)</b>	<b>Pass/Fail</b>
<b>Type 1A/1B</b>	30	100 %	60%	Pass
<b>Type 2</b>	30	100 %	60%	Pass
<b>Type 3</b>	30	100 %	60%	Pass
<b>Type 4</b>	30	100 %	60%	Pass
<b>Aggregate (Type1 to 4)</b>	120	100 %	80%	Pass
<b>Type 5</b>	30	100 %	80%	Pass
<b>Type 6</b>	30	100 %	70%	Pass

Please refer to the following statistical tables:

**Table-1 Radar Type 1A/1B Statistical Performance**

<b>Trial #</b>	<b>Fc (MHz)</b>	<b>Pulse/Burst</b>	<b>Pulse Width (μS)</b>	<b>PRI (μs)</b>	<b>Detection (1:yes; 0:no)</b>
1	5530	74	1	718	1
2	5530	76	1	698	1
3	5530	62	1	858	1
4	5530	92	1	578	1
5	5530	61	1	878	1
6	5530	59	1	898	1
7	5530	68	1	778	1
8	5530	78	1	678	1
9	5530	58	1	918	1
10	5530	89	1	598	1
11	5530	99	1	538	1
12	5530	65	1	818	1
13	5530	83	1	638	1
14	5530	63	1	838	1
15	5530	95	1	558	1
16	5530	21	1	2537	1
17	5530	29	1	1845	1
18	5530	33	1	1603	1
19	5530	22	1	2430	1
20	5530	28	1	1920	1
21	5530	47	1	1145	1
22	5530	81	1	657	1
23	5530	45	1	1193	1
24	5530	70	1	761	1
25	5530	61	1	874	1
26	5530	20	1	2740	1
27	5530	29	1	1843	1
28	5530	19	1	2918	1
29	5530	29	1	1880	1
30	5530	21	1	2585	1
<b>Detection Percentage: 100 % (&gt;60%)</b>					

**Table-2 Radar Type 2 Statistical Performance**

<b>Trial #</b>	<b>Fc (MHz)</b>	<b>Pulse/Burst</b>	<b>Pulse Width (μS)</b>	<b>PRI (μs)</b>	<b>Detection (1:yes; 0:no)</b>
1	5530	25	4.2	169	1
2	5530	24	4.3	230	1
3	5530	27	2.6	173	1
4	5530	29	1	224	1
5	5530	27	2.8	216	1
6	5530	29	4	170	1
7	5530	24	1.3	199	1
8	5530	26	3.9	207	1
9	5530	29	5	208	1
10	5530	24	4.7	225	1
11	5530	26	4.4	195	1
12	5530	24	3.6	188	1
13	5530	23	4.2	230	1
14	5530	25	2	160	1
15	5530	29	3.1	161	1
16	5530	29	3.6	196	1
17	5530	25	5	170	1
18	5530	27	3.9	182	1
19	5530	26	1	152	1
20	5530	24	2.8	229	1
21	5530	26	2	177	1
22	5530	26	2.2	195	1
23	5530	29	4.2	224	1
24	5530	27	3	204	1
25	5530	28	4.3	211	1
26	5530	26	3.3	196	1
27	5530	23	2.3	221	1
28	5530	27	1.9	197	1
29	5530	26	2.4	214	1
30	5530	27	1.9	150	1
<b>Detection Percentage: 100 % (&gt;60%)</b>					

**Table-3 Radar Type 3 Statistical Performance**

<b>Trial #</b>	<b>Fc (MHz)</b>	<b>Pulse/Burst</b>	<b>Pulse Width (μS)</b>	<b>PRI (μs)</b>	<b>Detection (1:yes; 0:no)</b>
1	5530	18	7.3	351	1
2	5530	16	8.7	240	1
3	5530	18	6.5	480	1
4	5530	17	6.6	448	1
5	5530	16	9.1	253	1
6	5530	17	9.1	442	1
7	5530	18	8.9	242	1
8	5530	16	7.2	440	1
9	5530	17	9.3	470	1
10	5530	18	7.7	464	1
11	5530	18	6.1	215	1
12	5530	17	6.8	236	1
13	5530	16	6.1	208	1
14	5530	18	7.5	388	1
15	5530	18	9.5	404	1
16	5530	18	10	301	1
17	5530	16	9.9	477	1
18	5530	16	9.3	405	1
19	5530	16	7.4	449	1
20	5530	16	8.4	373	1
21	5530	17	7.7	262	1
22	5530	16	8.1	423	1
23	5530	17	6.8	284	1
24	5530	17	7.4	430	1
25	5530	18	8.7	255	1
26	5530	16	7.6	363	1
27	5530	16	6.2	250	1
28	5530	18	7.2	343	1
29	5530	16	6.8	492	1
30	5530	16	6.7	419	1
<b>Detection Percentage: 100 % (&gt;60%)</b>					

**Table-4 Radar Type 4 Statistical Performance**

<b>Trial #</b>	<b>Fc (MHz)</b>	<b>Pulse/Burst</b>	<b>Pulse Width (µS)</b>	<b>PRI (µs)</b>	<b>Detection (1:yes; 0:no)</b>
1	5530	15	19.2	429	1
2	5530	13	12	462	1
3	5530	14	15.5	286	1
4	5530	15	20	275	1
5	5530	13	11.5	376	1
6	5530	12	15.1	394	1
7	5530	12	15.5	426	1
8	5530	16	17.1	456	1
9	5530	16	14.6	453	1
10	5530	14	14.3	295	1
11	5530	14	14.8	477	1
12	5530	12	11	239	1
13	5530	12	13.5	416	1
14	5530	16	11.9	415	1
15	5530	16	19.1	221	1
16	5530	13	12.3	472	1
17	5530	16	15.6	491	1
18	5530	12	13.4	451	1
19	5530	14	12.8	425	1
20	5530	12	12.6	204	1
21	5530	16	17.5	409	1
22	5530	15	18.8	460	1
23	5530	16	16.8	275	1
24	5530	14	14.2	433	1
25	5530	14	14.3	346	1
26	5530	16	17.2	425	1
27	5530	16	13.8	482	1
28	5530	16	16.6	495	1
29	5530	16	19	203	1
30	5530	15	17.3	479	1
<b>Detection Percentage: 100 % (&gt;60%)</b>					

**Table-5 Radar Type 5 Statistical Performance**

## Bin5 Statistics 1

Trial #	Pulse	Chirp (MHz)	Pulse Width (µS)	Pulse 1-2 spacing (uS)	Pulse 2-3 spacing (uS)	Pulse Start(S)	Detection (1:yes; 0:no)
0	2	6	62.9	1696		0.00338	1
1	2	10	87.1	1437		0.876424	
2	2	20	62.1	1041		2.078321	
3	3	18	51.3	1891	1522	2.496991	
4	1	9	91.5			3.603647	
5	2	15	67	1309		4.452675	
6	1	7	55.6			5.263337	
7	2	12	93.4	1969		6.370496	
8	3	15	64.1	1011	1701	7.179686	
9	3	18	87.2	1972	1005	7.354618	
10	2	18	68.2	1493		8.48942	
11	3	16	56.9	1334	1676	8.989179	
12	1	10	52			10.044121	
13	2	11	83.9	1248		11.18976	
14	2	17	93.1	1621		11.661808	

## Bin5 Statistics 2

Trial #	Pulse	Chirp (MHz)	Pulse Width (µS)	Pulse 1-2 spacing (uS)	Pulse 2-3 spacing (uS)	Pulse Start(S)	Detection (1:yes; 0:no)
0	2	8	85.3	1613		0.899425	1
1	3	8	74.5	1627	1113	1.581624	
2	2	16	87.6	1520		2.261731	
3	2	16	63.8	1962		3.065497	
4	2	5	60.8	1254		3.864478	
5	3	7	68	1087	1165	5.499155	
6	1	9	83.5			6.30546	
7	1	15	93.8			6.917944	
8	3	13	91.1	1102	1489	8.215682	
9	2	8	67.7	1378		8.49851	
10	2	14	63.7	1802		9.879804	
11	1	12	80.6			10.473502	
12	2	13	77	1298		11.503213	

## Bin5 Statistics 3

Trial #	Pulse	Chirp (MHz)	Pulse Width (µS)	Pulse 1-2 spacing (µS)	Pulse 2-3 spacing (µS)	Pulse Start(S)	Detection (1:yes; 0:no)
0	2	17	75.4	1617		0.19314	1
1	3	5	51.9	1676	1992	1.218853	
2	2	7	54.8	1687		1.730849	
3	2	6	73.1	1742		2.28374	
4	3	11	74.8	1238	1140	3.262092	
5	1	9	72.7			3.455307	
6	2	14	64.2	1528		4.641535	
7	3	17	62.7	1952	1248	5.137111	
8	3	10	86.3	1061	1529	5.768769	
9	3	10	78.6	1280	1520	6.579041	
10	2	18	67.6	1016		6.872513	
11	1	7	68			7.596488	
12	1	20	94.1			8.138649	
13	2	18	96.1	1457		9.311256	
14	2	11	99.8	1346		9.940773	
15	2	12	74.1	1272		10.112768	
16	2	14	73	1824		10.889318	
17	3	9	83.6	1735	1844	11.892925	

## Bin5 Statistics 4

Trial #	Pulse	Chirp (MHz)	Pulse Width (µS)	Pulse 1-2 spacing (µS)	Pulse 2-3 spacing (µS)	Pulse Start(S)	Detection (1:yes; 0:no)
0	1	7	75.2			0.013394	1
1	2	19	90.3	1957		1.272163	
2	2	5	52.4	1053		2.08473	
3	2	14	55.9	1235		3.481798	
4	2	9	80.4	1496		4.218535	
5	2	12	75	1256		5.049378	
6	3	19	66.9	1391	1133	5.574312	
7	2	13	72.6	1751		7.352791	
8	2	17	60.5	1916		7.713061	
9	1	20	73.3			8.44987	
10	2	14	61	1393		9.55545	
11	2	8	56.6	1655		10.269462	
12	2	18	95.2	1500		11.445811	

## Bin5 Statistics 5

Trial #	Pulse	Chirp (MHz)	Pulse Width (µS)	Pulse 1-2 spacing (uS)	Pulse 2-3 spacing (uS)	Pulse Start(S)	Detection (1:yes; 0:no)
0	3	16	75.4	1590	1514	0.62626	1
1	3	6	74.1	1830	1077	1.820383	
2	1	15	67.8			2.108793	
3	2	7	98.4	1178		3.447424	
4	3	10	99.8	1599	1792	4.082561	
5	2	11	91.6	1317		5.28654	
6	2	19	95.3	1544		6.133262	
7	2	9	84.3	1845		7.065715	
8	2	5	95.4	1851		7.388768	
9	2	18	69	1214		8.784748	
10	3	18	74.6	1967	1419	9.7468	
11	2	7	63.6	1759		10.545802	
12	2	17	66.9	1348		11.970474	

## Bin5 Statistics 6

Trial #	Pulse	Chirp (MHz)	Pulse Width (µS)	Pulse 1-2 spacing (uS)	Pulse 2-3 spacing (uS)	Pulse Start(S)	Detection (1:yes; 0:no)
0	2	8	69	1126		0.515903	1
1	2	9	72.4	1420		1.044404	
2	3	12	55.8	1713	1062	2.926029	
3	2	10	81.9	1113		3.213275	
4	2	10	63.9	1214		4.358963	
5	3	8	61.3	1243	1086	5.717827	
6	1	8	53.1			6.887823	
7	3	12	98	1343	1797	7.977319	
8	2	11	62.4	1248		8.453776	
9	3	5	79.1	1234	1707	9.772413	
10	2	17	71.5	1065		10.78546	
11	2	17	94	1331		11.160899	



## Bin5 Statistics 7

Trial #	Pulse	Chirp (MHz)	Pulse Width (µS)	Pulse 1-2 spacing (µS)	Pulse 2-3 spacing (µS)	Pulse Start(S)	Detection (1:yes; 0:no)
0	1	7	80.4			0.381931	1
1	3	7	84.9	1384	1251	0.957727	
2	3	13	76.5	1643	1205	1.858028	
3	3	7	74.4	1270	1683	2.450726	
4	1	11	52.1			2.99221	
5	2	14	55.6	1999		3.485128	
6	1	8	59.2			4.61282	
7	3	14	78.7	1137	1409	5.005639	
8	2	15	86.2	1980		5.855477	
9	3	7	74.3	1472	1801	6.3825	
10	2	13	76.5	1429		7.044882	
11	1	17	97.7			7.444801	
12	3	13	54.6	1989	1931	8.086101	
13	3	13	84.4	1609	1672	9.265688	
14	1	8	73.7			9.496481	
15	3	11	95.3	1964	1865	10.269657	
16	1	14	59.9			10.888377	
17	2	9	67.8	1861		11.367331	

## Bin5 Statistics 8

Trial #	Pulse	Chirp (MHz)	Pulse Width (µS)	Pulse 1-2 spacing (µS)	Pulse 2-3 spacing (µS)	Pulse Start(S)	Detection (1:yes; 0:no)
0	2	13	66.4	1126		0.530199	1
1	2	6	91.6	1970		0.967197	
2	3	9	89.8	1715	1304	1.623943	
3	2	11	92.1	1491		2.30173	
4	2	6	58.3	1162		2.889687	
5	2	7	74.4	1994		3.81566	
6	2	20	81.5	1878		4.463645	
7	3	5	83.8	1955	1207	5.215845	
8	3	17	69.5	1680	1349	5.51059	
9	1	8	88.8			6.619333	
10	1	18	75.9			7.186407	
11	2	9	86.5	1355		7.702549	
12	1	15	54.7			8.525558	
13	2	7	98.3	1913		9.078242	
14	2	14	98.4	1318		9.613771	
15	1	14	74.4			10.306714	
16	1	11	70.7			10.901145	
17	2	10	98	1003		11.721432	

## Bin5 Statistics 9

Trial #	Pulse	Chirp (MHz)	Pulse Width (µS)	Pulse 1-2 spacing (µS)	Pulse 2-3 spacing (µS)	Pulse Start(S)	Detection (1:yes; 0:no)
0	2	19	93.4	1630		0.309112	1
1	2	16	61	1212		1.472512	
2	1	8	75.8			2.292211	
3	2	19	51.6	1938		2.525684	
4	3	14	76.9	1349	1223	3.583068	
5	3	14	52.8	1216	1000	4.672453	
6	2	8	50.2	1501		5.280789	
7	2	13	50.7	1007		5.709784	
8	2	6	82.5	1179		7.002045	
9	2	8	80.4	1852		7.416021	
10	1	18	65			8.417914	
11	2	13	64.9	1945		9.313932	
12	2	20	70.4	1900		9.725477	
13	2	15	86.6	1750		10.734483	
14	2	5	61.2	1738		11.645261	

## Bin5 Statistics 10

Trial #	Pulse	Chirp (MHz)	Pulse Width (µS)	Pulse 1-2 spacing (µS)	Pulse 2-3 spacing (µS)	Pulse Start(S)	Detection (1:yes; 0:no)
0	2	15	67.2	1835		0.284492	1
1	2	19	74.2	1544		1.168505	
2	3	6	95.9	1412	1813	2.008424	
3	2	18	60.1	1481		2.752587	
4	3	16	90.7	1059	1928	3.228425	
5	3	16	74.4	1224	1302	3.871117	
6	2	12	63	1714		5.22036	
7	3	8	73.5	1393	1850	5.857315	
8	2	5	73.9	1348		6.642052	
9	1	18	76.5			7.222616	
10	1	17	61			8.129875	
11	1	10	94.8			8.418555	
12	2	15	78.3	1355		9.332518	
13	2	11	50.1	1669		9.973139	
14	3	6	94	1046	1630	10.528792	
15	2	20	94.8	1796		11.501337	

## Bin5 Statistics 11

Trial #	Pulse	Chirp (MHz)	Pulse Width (µS)	Pulse 1-2 spacing (µS)	Pulse 2-3 spacing (µS)	Pulse Start(S)	Detection (1:yes; 0:no)
0	2	17	84.5	1638		0.451668	1
1	2	13	84.7	1832		0.965184	
2	2	10	52.5	1168		1.797592	
3	2	7	63	1868		2.681408	
4	1	7	86.5			3.257263	
5	1	12	64.1			4.438379	
6	1	9	63.7			4.677964	
7	2	7	94.4	1799		5.548038	
8	3	18	63.8	1566	1290	6.673354	
9	2	18	53.2	1226		6.82765	
10	2	5	71.2	1340		8.03841	
11	2	16	58	1260		8.426914	
12	2	7	85.3	1319		9.149033	
13	1	10	86.8			10.101894	
14	2	10	69.5	1411		10.646617	
15	3	11	80.7	1427	1976	11.695029	

## Bin5 Statistics 12

Trial #	Pulse	Chirp (MHz)	Pulse Width (µS)	Pulse 1-2 spacing (uS)	Pulse 2-3 spacing (uS)	Pulse Start(S)	Detection (1:yes; 0:no)
0	3	7	98.6	1006	1411	0.498891	1
1	2	10	71.5	1737		1.247729	
2	1	6	51.1			1.346609	
3	3	7	60.5	1359	1851	2.155249	
4	2	8	66.6	1019		2.774518	
5	1	6	78.4			3.511626	
6	1	7	79.2			4.150884	
7	1	6	62.1			5.028556	
8	2	11	61.7	1828		5.618701	
9	3	9	86.4	1945	1285	5.920603	
10	3	17	72	1559	1298	6.513718	
11	3	16	65.4	1658	1344	7.316582	
12	2	20	68	1284		7.889472	
13	2	16	58.5	1926		8.828358	
14	1	7	79.9			9.162261	
15	3	11	85.8	1142	1696	9.559549	
16	2	13	83.6	1000		10.250066	
17	1	20	57.4			11.087298	
18	1	19	61.5			11.480315	

## Bin5 Statistics 13

Trial #	Pulse	Chirp (MHz)	Pulse Width (µS)	Pulse 1-2 spacing (uS)	Pulse 2-3 spacing (uS)	Pulse Start(S)	Detection (1:yes; 0:no)
0	1	13	51.2			1.48628	1
1	3	7	81	1861	1116	2.684644	
2	2	5	96.5	1156		3.09387	
3	2	8	64.5	1142		4.863805	
4	1	14	97.1			7.335068	
5	1	5	59.8			8.214302	
6	1	16	86.2			9.436572	
7	3	12	86.3	1973	1568	11.989257	

## Bin5 Statistics 14

Trial #	Pulse	Chirp (MHz)	Pulse Width (µS)	Pulse 1-2 spacing (uS)	Pulse 2-3 spacing (uS)	Pulse Start(S)	Detection (1:yes; 0:no)
0	3	11	89.6	1061	1848	1.061078	1
1	2	12	79.1	1030		1.34916	
2	1	10	51.1			3.315358	
3	2	6	55.8	1932		4.613559	
4	2	10	79	1908		5.828506	
5	1	5	73.9			6.761897	
6	1	15	77.4			7.366633	
7	2	17	65.8	1708		9.587951	
8	3	6	96.9	1516	1700	10.341221	
9	2	18	94.8	1259		11.424433	

## Bin5 Statistics 15

Trial #	Pulse	Chirp (MHz)	Pulse Width (µS)	Pulse 1-2 spacing (uS)	Pulse 2-3 spacing (uS)	Pulse Start(S)	Detection (1:yes; 0:no)
0	2	8	78.2	1795		0.71732	1
1	2	8	79.8	1065		1.127907	
2	3	15	56.8	1798	1697	2.523135	
3	2	12	58.5	1841		3.322528	
4	3	16	84.2	1135	1629	4.709507	
5	2	6	63.4	1427		5.036481	
6	1	15	98.9			6.652452	
7	1	6	62.9			7.576258	
8	2	9	77.6	1436		8.382466	
9	2	14	70	1977		9.827633	
10	1	15	100			10.416765	
11	3	13	86.2	1948	1284	11.171341	

## Bin5 Statistics 16

Trial #	Pulse	Chirp (MHz)	Pulse Width (µS)	Pulse 1-2 spacing (uS)	Pulse 2-3 spacing (uS)	Pulse Start(S)	Detection (1:yes; 0:no)
0	2	11	63.9	1821		0.626953	1
1	1	14	79.4			1.359394	
2	2	8	99.6	1309		2.325206	
3	3	8	86.2	1385	1346	3.192927	
4	1	15	58.5			4.077462	
5	3	11	98.1	1433	1096	4.659845	
6	2	6	52.5	1391		6.161546	
7	1	14	58.8			7.256672	
8	3	10	90.7	1672	1679	8.144549	
9	3	16	86.3	1999	1099	8.359701	
10	2	7	72.9	1880		9.665954	
11	1	17	76.1			10.708176	
12	3	19	74.8	1079	1470	11.377385	

## Bin5 Statistics 17

Trial #	Pulse	Chirp (MHz)	Pulse Width (µS)	Pulse 1-2 spacing (uS)	Pulse 2-3 spacing (uS)	Pulse Start(S)	Detection (1:yes; 0:no)
0	2	9	82.7	1469		1.28562	1
1	2	17	96.5	1320		2.237121	
2	3	13	99.8	1311	1522	3.246429	
3	2	20	73.9	1236		4.244095	
4	1	7	68.9			6.476893	
5	3	19	95.4	1969	1543	7.979303	
6	2	14	81.1	1772		8.812307	
7	1	7	77.9			10.643852	
8	1	5	53.1			10.975827	

## Bin5 Statistics 18

Trial #	Pulse	Chirp (MHz)	Pulse Width (µS)	Pulse 1-2 spacing (µS)	Pulse 2-3 spacing (µS)	Pulse Start(S)	Detection (1:yes; 0:no)
0	2	11	86.2	1089		0.354733	1
1	2	5	67.8	1182		1.573785	
2	2	19	89.5	1167		1.991931	
3	2	16	53.9	1608		2.51839	
4	3	9	55.5	1961	1917	3.913041	
5	2	11	76	1707		4.69223	
6	3	7	80.6	1845	1329	5.318321	
7	1	13	55.8			5.744476	
8	3	10	74.3	1882	1949	6.686419	
9	2	8	69.8	1730		7.377396	
10	1	16	95.1			8.04981	
11	3	8	73	1632	1535	8.84639	
12	3	11	94	1429	1711	9.889033	
13	2	15	92.6	1325		10.568515	
14	2	14	88.2	1195		11.908966	

## Bin5 Statistics 19

Trial #	Pulse	Chirp (MHz)	Pulse Width (µS)	Pulse 1-2 spacing (µS)	Pulse 2-3 spacing (µS)	Pulse Start(S)	Detection (1:yes; 0:no)
0	2	13	70.4	1057		0.401072	1
1	1	5	60.4			1.309209	
2	3	9	79.5	1037	1948	2.873246	
3	1	20	65.8			3.32054	
4	2	15	94.8	1333		4.308957	
5	1	14	88.7			5.077228	
6	2	14	84.1	1287		6.110444	
7	2	12	88.5	1883		7.768398	
8	3	17	55.3	1322	1132	8.468057	
9	3	16	97.3	1216	1317	9.895261	
10	2	5	50.4	1829		10.659096	
11	1	15	63.8			11.636758	

## Bin5 Statistics 20

Trial #	Pulse	Chirp (MHz)	Pulse Width (µS)	Pulse 1-2 spacing (uS)	Pulse 2-3 spacing (uS)	Pulse Start(S)	Detection (1:yes; 0:no)
0	3	19	62.8	1943	1642	0.181924	1
1	2	14	51	1808		1.09854	
2	2	6	59.9	1080		1.712825	
3	2	6	95.8	1922		2.810373	
4	2	5	69.6	1500		3.343506	
5	2	15	81.4	1923		3.979766	
6	2	17	52.7	1019		4.608937	
7	2	8	88.7	1886		5.782087	
8	2	13	86.3	1713		6.219507	
9	2	14	87.5	1185		6.760171	
10	2	7	95.8	1869		7.938283	
11	1	10	79.1			8.590723	
12	3	10	84	1557	1110	9.575679	
13	2	6	69.1	1374		9.959404	
14	1	7	87.2			10.689384	
15	3	14	89.5	1677	1623	11.919809	

## Bin5 Statistics 21

Trial #	Pulse	Chirp (MHz)	Pulse Width (µS)	Pulse 1-2 spacing (uS)	Pulse 2-3 spacing (uS)	Pulse Start(S)	Detection (1:yes; 0:no)
0	1	16	92			0.354126	1
1	2	15	51.7	1850		1.253141	
2	2	5	95	1967		2.794989	
3	3	16	57.2	1289	1150	3.267454	
4	2	16	90.4	1878		4.504713	
5	1	13	89.4			5.910427	
6	2	19	56.2	1098		6.801973	
7	2	8	85	1266		7.280183	
8	2	13	70	1470		8.223678	
9	1	11	82.5			9.909127	
10	3	16	70.9	1208	1028	10.456867	
11	2	11	93.2	1533		11.941107	



## Bin5 Statistics 22

Trial #	Pulse	Chirp (MHz)	Pulse Width (µS)	Pulse 1-2 spacing (uS)	Pulse 2-3 spacing (uS)	Pulse Start(S)	Detection (1:yes; 0:no)
0	1	15	57.9			0.03321	1
1	3	13	55.9	1743	1230	0.828383	
2	2	20	91.3	1049		1.523442	
3	2	14	60.1	1209		2.659773	
4	2	17	98.4	1987		3.323744	
5	2	6	77.3	1563		4.125137	
6	2	17	61.7	1044		4.743208	
7	1	19	72.5			5.342958	
8	1	5	97.5			6.349671	
9	2	15	86.8	1935		6.413346	
10	3	17	74.7	1398	1586	7.137912	
11	2	18	69	1654		8.037972	
12	2	13	66.8	1865		8.887269	
13	2	5	54.4	1732		9.877874	
14	2	17	62.1	1268		10.377376	
15	2	12	60.1	1567		11.003385	
16	3	14	73.1	1376	1523	11.845512	

## Bin5 Statistics 23

Trial #	Pulse	Chirp (MHz)	Pulse Width (µS)	Pulse 1-2 spacing (uS)	Pulse 2-3 spacing (uS)	Pulse Start(S)	Detection (1:yes; 0:no)
0	2	13	65	1107		0.969881	1
1	1	8	77.4			2.464323	
2	3	17	97.1	1484	1824	4.172934	
3	2	10	58.9	1874		5.19658	
4	2	16	53.3	1528		6.160516	
5	2	12	67.5	1907		8.871633	
6	3	7	57.5	1714	1969	9.101388	
7	2	11	72.7	1537		11.005282	

## Bin5 Statistics 24

Trial #	Pulse	Chirp (MHz)	Pulse Width (µS)	Pulse 1-2 spacing (uS)	Pulse 2-3 spacing (uS)	Pulse Start(S)	Detection (1:yes; 0:no)
0	1	20	67.9			0.324812	1
1	3	17	87.1	1589	1969	0.698228	
2	1	10	95.3			1.531917	
3	2	19	69.5	1796		2.429909	
4	2	19	73.3	1365		2.560105	
5	2	12	87.4	1587		3.720319	
6	2	7	61.3	1670		4.06682	
7	1	14	89.4			4.62727	
8	2	10	93.1	1081		5.119571	
9	3	19	53.6	1419	1315	5.895048	
10	2	13	63.4	1287		6.777857	
11	3	8	74.6	1701	1693	6.992242	
12	1	11	58.6			8.115362	
13	3	9	71.5	1860	1834	8.283644	
14	1	12	90.3			9.430617	
15	3	8	64.5	1670	1262	10.007774	
16	2	18	51.3	1421		10.113218	
17	2	17	96	1993		11.067545	
18	2	8	81.6	1580		11.732765	

## Bin5 Statistics 25

Trial #	Pulse	Chirp (MHz)	Pulse Width (µS)	Pulse 1-2 spacing (uS)	Pulse 2-3 spacing (uS)	Pulse Start(S)	Detection (1:yes; 0:no)
0	1	18	87.1			0.810347	1
1	2	14	80.3	1779		1.402177	
2	2	13	77.5	1697		2.267734	
3	2	19	50.1	1917		2.819159	
4	2	9	78.9	1736		3.704836	
5	3	17	50	1163	1934	5.010346	
6	2	14	91.1	1574		6.4019	
7	2	6	63.6	1404		6.942495	
8	3	5	59.6	1949	1695	7.830052	
9	1	15	96.2			8.74796	
10	2	9	88.1	1260		9.833909	
11	2	17	82.2	1832		10.481071	
12	2	14	92.4	1185		11.51646	

## Bin5 Statistics 26

Trial #	Pulse	Chirp (MHz)	Pulse Width (µS)	Pulse 1-2 spacing (uS)	Pulse 2-3 spacing (uS)	Pulse Start(S)	Detection (1:yes; 0:no)
0	2	5	65.3	1293		0.552259	1
1	2	15	78.1	1041		2.359058	
2	1	10	98.9			3.099811	
3	2	6	72.4	1939		4.785624	
4	2	11	58.7	1415		5.338197	
5	2	11	61.2	1367		6.909208	
6	2	18	88.4	1209		8.262916	
7	1	17	91.2			9.41248	
8	2	17	68.7	1260		10.273752	
9	3	8	94.5	1575	1852	11.192784	

## Bin5 Statistics 27

Trial #	Pulse	Chirp (MHz)	Pulse Width (µS)	Pulse 1-2 spacing (uS)	Pulse 2-3 spacing (uS)	Pulse Start(S)	Detection (1:yes; 0:no)
0	1	7	52.8			0.548676	1
1	1	17	73.3			1.46715	
2	1	16	94.9			2.848997	
3	1	9	69.1			3.573843	
4	2	14	51.6	1861		4.125015	
5	3	12	83.8	1692	1728	5.964751	
6	2	8	86.8	1019		6.598731	
7	2	17	77.7	1134		7.483534	
8	2	13	76.7	1425		8.45124	
9	1	18	70.7			9.207538	
10	3	12	57.6	1189	1666	10.053221	
11	1	16	99.2			11.907508	

## Bin5 Statistics 28

Trial #	Pulse	Chirp (MHz)	Pulse Width (µS)	Pulse 1-2 spacing (uS)	Pulse 2-3 spacing (uS)	Pulse Start(S)	Detection (1:yes; 0:no)
0	2	9	54.5	1268		0.619816	1
1	1	7	71.3			1.067491	
2	2	19	77.3	1190		1.769338	
3	1	13	64.9			2.814455	
4	3	20	93.6	1430	1852	3.2967	
5	3	9	87.1	1699	1877	3.770059	
6	1	17	61.4			4.761737	
7	2	8	51.9	1604		5.440846	
8	2	19	70.7	1141		6.082859	
9	2	17	89.7	1517		7.463157	
10	1	12	88.1			7.851701	
11	2	19	63.3	1324		8.529709	
12	1	9	94.8			9.219926	
13	2	18	84.1	1789		10.014395	
14	1	19	91.5			10.899708	
15	3	11	77.2	1627	1438	11.327079	

## Bin5 Statistics 29

Trial #	Pulse	Chirp (MHz)	Pulse Width (µS)	Pulse 1-2 spacing (uS)	Pulse 2-3 spacing (uS)	Pulse Start(S)	Detection (1:yes; 0:no)
0	1	11	68.5			0.49781	1
1	1	10	56.3			1.225069	
2	1	14	60.1			1.442314	
3	3	15	80	1077	1579	2.031956	
4	1	12	87.5			2.903464	
5	2	7	65.9	1184		3.590493	
6	1	18	74.6			4.332175	
7	1	6	59.8			4.469852	
8	3	16	83.9	1944	1661	5.352426	
9	2	14	69.4	1826		5.852805	
10	2	15	94.6	1155		6.727804	
11	2	15	67.1	1925		7.071424	
12	2	10	72.8	1479		8.148616	
13	2	9	95.9	1740		8.222673	
14	3	17	96.8	1057	1398	8.934832	
15	2	9	62.5	1284		10.023124	
16	2	10	85	1397		10.108962	
17	2	17	99.4	1089		10.740345	
18	1	17	93.6			11.723944	

## Bin5 Statistics 30

Trial #	Pulse	Chirp (MHz)	Pulse Width (µS)	Pulse 1-2 spacing (uS)	Pulse 2-3 spacing (uS)	Pulse Start(S)	Detection (1:yes; 0:no)
0	3	12	59.9	1968	1095	1.189593	1
1	2	13	60.5	1577		2.543645	
2	3	13	51.3	1120	1213	2.882216	
3	2	12	84.6	1303		4.216993	
4	2	15	68.8	1662		6.544222	
5	3	12	52	1320	1010	7.73393	
6	3	13	51	1676	1627	8.272372	
7	3	5	56.1	1057	1663	9.522348	
8	3	19	79.3	1239	1932	11.741736	

**Table-6 Radar Type 6 Statistical Performance**

Trial #	Fc (MHz)	Pulse /Burst	Pulse Width (µS)	PRI (µs)	Detection (1:yes; 0:no)	Hopping Sequence
1	5530	9	1	333	1	5448.0, 5531.0, 5251.0, 5393.0, 5685.0, 5577.0, 5658.0, 5348.0, 5398.0, 5449.0, 5596.0, 5567.0, 5346.0, 5390.0, 5635.0, 5314.0, 5454.0, 5680.0, 5573.0, 5333.0, 5485.0, 5461.0, 5456.0, 5279.0, 5418.0, 5642.0, 5627.0, 5717.0, 5400.0, 5285.0, 5690.0, 5268.0, 5652.0, 5720.0, 5636.0, 5688.0, 5616.0, 5599.0, 5260.0, 5483.0, 5499.0, 5665.0, 5701.0, 5396.0, 5588.0, 5702.0, 5266.0, 5374.0, 5281.0, 5320.0, 5300.0, 5549.0, 5601.0, 5645.0, 5476.0, 5352.0, 5661.0, 5439.0, 5673.0, 5666.0, 5472.0, 5674.0, 5397.0, 5623.0, 5267.0, 5565.0, 5541.0, 5408.0, 5705.0, 5634.0, 5431.0, 5586.0, 5611.0, 5332.0, 5619.0, 5310.0, 5378.0, 5264.0, 5392.0, 5657.0, 5271.0, 5497.0, 5668.0, 5643.0, 5686.0, 5451.0, 5654.0, 5715.0, 5687.0, 5298.0, 5455.0, 5625.0, 5675.0, 5648.0, 5399.0, 5421.0, 5653.0, 5707.0, 5275.0, 5345.0 (number of hits: 5)
2	5530	9	1	333	1	5691.0, 5459.0, 5418.0, 5595.0, 5558.0, 5375.0, 5438.0, 5315.0, 5553.0, 5275.0, 5264.0, 5466.0, 5412.0, 5493.0, 5332.0, 5427.0, 5649.0, 5571.0, 5568.0, 5326.0, 5529.0, 5385.0, 5393.0, 5267.0, 5423.0, 5261.0, 5285.0, 5606.0, 5387.0, 5331.0, 5668.0, 5279.0, 5383.0, 5678.0, 5695.0, 5365.0, 5413.0, 5344.0, 5282.0, 5470.0, 5680.0, 5522.0, 5658.0, 5302.0, 5297.0, 5615.0, 5675.0, 5256.0, 5448.0, 5431.0, 5603.0, 5409.0, 5392.0, 5640.0, 5311.0, 5316.0, 5597.0, 5653.0, 5632.0, 5662.0, 5320.0, 5366.0, 5380.0, 5480.0, 5525.0, 5508.0, 5600.0, 5280.0, 5665.0, 5684.0, 5561.0, 5634.0, 5699.0, 5334.0, 5616.0, 5722.0, 5372.0, 5333.0, 5638.0, 5432.0, 5455.0, 5681.0, 5314.0, 5532.0, 5693.0, 5462.0, 5417.0, 5425.0, 5667.0, 5262.0, 5317.0, 5388.0, 5442.0, 5580.0, 5703.0, 5456.0, 5618.0, 5574.0, 5420.0, 5400.0 (number of hits: 5)
3	5530	9	1	333	1	5525.0, 5316.0, 5459.0, 5564.0, 5389.0, 5683.0, 5473.0, 5261.0, 5501.0, 5629.0, 5331.0, 5492.0, 5295.0, 5486.0, 5665.0, 5555.0, 5572.0, 5343.0, 5350.0, 5265.0, 5308.0, 5301.0, 5370.0, 5655.0, 5368.0, 5627.0, 5511.0, 5429.0, 5498.0, 5580.0, 5515.0, 5334.0, 5679.0, 5366.0, 5313.0, 5512.0, 5280.0, 5530.0, 5293.0, 5556.0, 5393.0, 5310.0, 5392.0, 5514.0, 5278.0, 5502.0, 5542.0, 5451.0, 5430.0, 5547.0, 5253.0, 5505.0, 5609.0, 5419.0, 5710.0, 5325.0, 5329.0, 5497.0, 5255.0, 5560.0

						5381.0, 5658.0, 5681.0, 5704.0, 5702.0, 5466.0, 5425.0, 5355.0, 5605.0, 5475.0, 5371.0, 5568.0, 5678.0, 5327.0, 5534.0, 5646.0, 5286.0, 5406.0, 5270.0, 5360.0, 5326.0, 5287.0, 5487.0, 5573.0, 5590.0, 5411.0, 5516.0, 5391.0, 5395.0, 5645.0, 5537.0, 5641.0, 5662.0, 5553.0, 5420.0, 5621.0, 5256.0, 5321.0, 5444.0, 5644.0 (number of hits: 8)
4	5530	9	1	333	1	5359.0, 5519.0, 5293.0, 5651.0, 5443.0, 5430.0, 5464.0, 5679.0, 5573.0, 5628.0, 5497.0, 5481.0, 5594.0, 5462.0, 5354.0, 5529.0, 5648.0, 5718.0, 5565.0, 5711.0, 5665.0, 5683.0, 5582.0, 5667.0, 5592.0, 5549.0, 5294.0, 5453.0, 5275.0, 5322.0, 5269.0, 5501.0, 5303.0, 5459.0, 5585.0, 5520.0, 5632.0, 5372.0, 5458.0, 5352.0, 5403.0, 5607.0, 5384.0, 5455.0, 5273.0, 5586.0, 5532.0, 5674.0, 5553.0, 5498.0, 5391.0, 5694.0, 5640.0, 5435.0, 5548.0, 5345.0, 5472.0, 5601.0, 5581.0, 5588.0, 5433.0, 5415.0, 5291.0, 5709.0, 5680.0, 5545.0, 5334.0, 5697.0, 5302.0, 5524.0, 5450.0, 5253.0, 5423.0, 5707.0, 5427.0, 5661.0, 5722.0, 5456.0, 5380.0, 5717.0, 5376.0, 5616.0, 5491.0, 5556.0, 5353.0, 5503.0, 5344.0, 5626.0, 5647.0, 5476.0, 5550.0, 5705.0, 5432.0, 5591.0, 5577.0, 5659.0, 5538.0, 5612.0, 5593.0, 5599.0 (number of hits: 5)
5	5530	9	1	333	1	5407.0, 5285.0, 5339.0, 5616.0, 5436.0, 5348.0, 5576.0, 5701.0, 5697.0, 5315.0, 5404.0, 5533.0, 5654.0, 5462.0, 5496.0, 5477.0, 5714.0, 5438.0, 5482.0, 5547.0, 5640.0, 5464.0, 5382.0, 5589.0, 5519.0, 5349.0, 5609.0, 5550.0, 5558.0, 5504.0, 5452.0, 5569.0, 5269.0, 5679.0, 5495.0, 5594.0, 5302.0, 5666.0, 5321.0, 5564.0, 5678.0, 5328.0, 5422.0, 5612.0, 5500.0, 5331.0, 5412.0, 5286.0, 5347.0, 5677.0, 5370.0, 5512.0, 5355.0, 5583.0, 5474.0, 5516.0, 5606.0, 5265.0, 5431.0, 5629.0, 5546.0, 5645.0, 5298.0, 5468.0, 5260.0, 5447.0, 5562.0, 5336.0, 5457.0, 5549.0, 5360.0, 5574.0, 5289.0, 5294.0, 5423.0, 5660.0, 5268.0, 5387.0, 5637.0, 5700.0, 5535.0, 5683.0, 5401.0, 5710.0, 5253.0, 5273.0, 5258.0, 5720.0, 5610.0, 5548.0, 5325.0, 5659.0, 5393.0, 5513.0, 5358.0, 5684.0, 5591.0, 5446.0, 5276.0, 5685.0 (number of hits: 6)
6	5530	9	1	333	1	5711.0, 5372.0, 5436.0, 5487.0, 5563.0, 5636.0, 5423.0, 5650.0, 5616.0, 5627.0, 5696.0, 5623.0, 5685.0, 5576.0, 5382.0, 5502.0, 5551.0, 5539.0, 5594.0, 5530.0, 5334.0, 5586.0, 5532.0, 5651.0, 5422.0, 5694.0, 5346.0, 5374.0, 5598.0, 5575.0, 5509.0, 5250.0, 5499.0, 5345.0, 5648.0, 5452.0, 5479.0, 5570.0, 5621.0, 5548.0,

						5702.0, 5451.0, 5463.0, 5438.0, 5583.0, 5407.0, 5471.0, 5626.0, 5272.0, 5468.0, 5429.0, 5557.0, 5533.0, 5402.0, 5252.0, 5309.0, 5254.0, 5641.0, 5337.0, 5628.0, 5348.0, 5492.0, 5562.0, 5359.0, 5585.0, 5370.0, 5649.0, 5295.0, 5448.0, 5363.0, 5443.0, 5351.0, 5644.0, 5475.0, 5512.0, 5264.0, 5693.0, 5298.0, 5661.0, 5698.0, 5305.0, 5459.0, 5484.0, 5308.0, 5703.0, 5592.0, 5489.0, 5324.0, 5349.0, 5569.0, 5516.0, 5333.0, 5329.0, 5381.0, 5715.0, 5646.0, 5257.0, 5520.0, 5535.0, 5300.0 (number of hits: 6)
7	5530	9	1	333	1	5596.0, 5625.0, 5341.0, 5478.0, 5502.0, 5342.0, 5493.0, 5348.0, 5293.0, 5586.0, 5665.0, 5544.0, 5352.0, 5708.0, 5572.0, 5278.0, 5433.0, 5343.0, 5371.0, 5410.0, 5345.0, 5347.0, 5456.0, 5398.0, 5524.0, 5337.0, 5279.0, 5686.0, 5365.0, 5678.0, 5669.0, 5445.0, 5364.0, 5295.0, 5658.0, 5284.0, 5590.0, 5600.0, 5672.0, 5712.0, 5459.0, 5593.0, 5311.0, 5575.0, 5559.0, 5369.0, 5253.0, 5716.0, 5670.0, 5385.0, 5422.0, 5332.0, 5679.0, 5707.0, 5487.0, 5346.0, 5325.0, 5718.0, 5635.0, 5618.0, 5723.0, 5601.0, 5396.0, 5378.0, 5693.0, 5565.0, 5643.0, 5488.0, 5498.0, 5539.0, 5547.0, 5614.0, 5660.0, 5701.0, 5258.0, 5616.0, 5355.0, 5402.0, 5379.0, 5585.0, 5450.0, 5497.0, 5441.0, 5505.0, 5291.0, 5334.0, 5282.0, 5628.0, 5714.0, 5504.0, 5467.0, 5602.0, 5542.0, 5517.0, 5477.0, 5359.0, 5395.0, 5675.0, 5319.0, 5349.0 (number of hits: 4)
8	5530	9	1	333	1	5578.0, 5328.0, 5610.0, 5719.0, 5416.0, 5438.0, 5640.0, 5723.0, 5393.0, 5339.0, 5351.0, 5685.0, 5556.0, 5367.0, 5410.0, 5636.0, 5513.0, 5309.0, 5604.0, 5531.0, 5630.0, 5650.0, 5552.0, 5284.0, 5267.0, 5631.0, 5435.0, 5269.0, 5579.0, 5422.0, 5532.0, 5392.0, 5526.0, 5461.0, 5666.0, 5436.0, 5709.0, 5430.0, 5585.0, 5293.0, 5616.0, 5601.0, 5642.0, 5447.0, 5527.0, 5696.0, 5487.0, 5550.0, 5279.0, 5483.0, 5457.0, 5482.0, 5700.0, 5611.0, 5542.0, 5632.0, 5549.0, 5477.0, 5386.0, 5287.0, 5266.0, 5595.0, 5597.0, 5544.0, 5454.0, 5280.0, 5374.0, 5303.0, 5485.0, 5390.0, 5546.0, 5663.0, 5676.0, 5625.0, 5591.0, 5677.0, 5270.0, 5633.0, 5686.0, 5437.0, 5389.0, 5353.0, 5695.0, 5715.0, 5708.0, 5523.0, 5711.0, 5606.0, 5619.0, 5268.0, 5668.0, 5693.0, 5404.0, 5469.0, 5674.0, 5627.0, 5417.0, 5273.0, 5662.0, 5285.0 (number of hits: 5)
9	5530	9	1	333	1	5261.0, 5552.0, 5344.0, 5648.0, 5500.0, 5488.0, 5654.0, 5556.0, 5507.0, 5440.0, 5290.0, 5336.0, 5270.0, 5527.0, 5446.0, 5665.0, 5698.0, 5697.0, 5642.0, 5582.0,



						5653.0, 5324.0, 5520.0, 5508.0, 5362.0, 5511.0, 5467.0, 5638.0, 5401.0, 5663.0, 5305.0, 5275.0, 5451.0, 5623.0, 5307.0, 5606.0, 5469.0, 5345.0, 5350.0, 5272.0, 5619.0, 5303.0, 5262.0, 5464.0, 5565.0, 5482.0, 5636.0, 5503.0, 5268.0, 5537.0, 5544.0, 5693.0, 5551.0, 5436.0, 5380.0, 5545.0, 5635.0, 5589.0, 5611.0, 5419.0, 5372.0, 5251.0, 5368.0, 5577.0, 5538.0, 5705.0, 5553.0, 5557.0, 5431.0, 5437.0, 5316.0, 5573.0, 5327.0, 5616.0, 5296.0, 5555.0, 5629.0, 5294.0, 5514.0, 5394.0, 5323.0, 5363.0, 5684.0, 5273.0, 5687.0, 5672.0, 5643.0, 5259.0, 5534.0, 5353.0, 5450.0, 5378.0, 5281.0, 5699.0, 5418.0, 5260.0, 5340.0, 5254.0, 5325.0, 5366.0 (number of hits: 6)
10	5530	9	1	333	1	5368.0, 5435.0, 5639.0, 5451.0, 5439.0, 5493.0, 5442.0, 5464.0, 5654.0, 5398.0, 5599.0, 5547.0, 5584.0, 5275.0, 5391.0, 5509.0, 5699.0, 5308.0, 5337.0, 5379.0, 5575.0, 5298.0, 5264.0, 5690.0, 5544.0, 5644.0, 5627.0, 5570.0, 5333.0, 5569.0, 5395.0, 5315.0, 5648.0, 5408.0, 5296.0, 5325.0, 5542.0, 5251.0, 5430.0, 5579.0, 5341.0, 5304.0, 5587.0, 5405.0, 5362.0, 5718.0, 5610.0, 5440.0, 5563.0, 5402.0, 5367.0, 5697.0, 5363.0, 5586.0, 5638.0, 5449.0, 5458.0, 5572.0, 5688.0, 5531.0, 5353.0, 5549.0, 5664.0, 5687.0, 5433.0, 5250.0, 5528.0, 5453.0, 5323.0, 5497.0, 5519.0, 5416.0, 5366.0, 5344.0, 5499.0, 5324.0, 5384.0, 5496.0, 5399.0, 5512.0, 5711.0, 5254.0, 5322.0, 5475.0, 5503.0, 5331.0, 5390.0, 5348.0, 5516.0, 5557.0, 5345.0, 5513.0, 5617.0, 5712.0, 5299.0, 5457.0, 5555.0, 5258.0, 5375.0, 5444.0 (number of hits: 5)
11	5530	9	1	333	1	5269.0, 5466.0, 5393.0, 5634.0, 5284.0, 5480.0, 5370.0, 5424.0, 5664.0, 5646.0, 5531.0, 5388.0, 5572.0, 5351.0, 5439.0, 5706.0, 5263.0, 5702.0, 5445.0, 5402.0, 5384.0, 5279.0, 5549.0, 5457.0, 5300.0, 5709.0, 5592.0, 5320.0, 5409.0, 5680.0, 5668.0, 5420.0, 5310.0, 5389.0, 5521.0, 5277.0, 5503.0, 5292.0, 5346.0, 5276.0, 5367.0, 5537.0, 5613.0, 5337.0, 5575.0, 5306.0, 5341.0, 5260.0, 5714.0, 5469.0, 5334.0, 5542.0, 5317.0, 5565.0, 5673.0, 5324.0, 5363.0, 5425.0, 5596.0, 5434.0, 5610.0, 5495.0, 5605.0, 5288.0, 5456.0, 5681.0, 5399.0, 5282.0, 5707.0, 5621.0, 5640.0, 5261.0, 5612.0, 5677.0, 5623.0, 5649.0, 5719.0, 5547.0, 5578.0, 5626.0, 5481.0, 5345.0, 5603.0, 5496.0, 5315.0, 5568.0, 5523.0, 5606.0, 5353.0, 5422.0, 5504.0, 5467.0, 5387.0, 5656.0, 5694.0, 5498.0, 5430.0, 5287.0, 5516.0, 5450.0 (number of hits: 6)

12	5530	9	1	333	1	<p>5712.0, 5274.0, 5543.0, 5575.0, 5655.0, 5577.0, 5614.0, 5278.0, 5426.0, 5323.0, 5304.0, 5722.0, 5448.0, 5689.0, 5652.0, 5435.0, 5717.0, 5645.0, 5723.0, 5432.0, 5477.0, 5505.0, 5288.0, 5556.0, 5446.0, 5475.0, 5567.0, 5703.0, 5669.0, 5372.0, 5682.0, 5609.0, 5421.0, 5499.0, 5377.0, 5656.0, 5314.0, 5250.0, 5295.0, 5440.0, 5535.0, 5558.0, 5686.0, 5569.0, 5620.0, 5268.0, 5564.0, 5375.0, 5306.0, 5497.0, 5376.0, 5612.0, 5257.0, 5632.0, 5413.0, 5439.0, 5514.0, 5702.0, 5479.0, 5568.0, 5561.0, 5275.0, 5654.0, 5300.0, 5693.0, 5457.0, 5534.0, 5269.0, 5487.0, 5688.0, 5523.0, 5378.0, 5496.0, 5590.0, 5601.0, 5373.0, 5681.0, 5366.0, 5576.0, 5606.0, 5486.0, 5332.0, 5589.0, 5538.0, 5462.0, 5276.0, 5615.0, 5355.0, 5532.0, 5671.0, 5417.0, 5367.0, 5573.0, 5481.0, 5407.0, 5525.0, 5647.0, 5396.0, 5489.0, 5333.0 (number of hits: 6)</p>
13	5530	9	1	333	1	<p>5629.0, 5428.0, 5456.0, 5426.0, 5678.0, 5263.0, 5264.0, 5468.0, 5471.0, 5273.0, 5359.0, 5438.0, 5673.0, 5391.0, 5588.0, 5699.0, 5459.0, 5328.0, 5525.0, 5520.0, 5587.0, 5410.0, 5401.0, 5572.0, 5561.0, 5711.0, 5714.0, 5514.0, 5348.0, 5503.0, 5624.0, 5311.0, 5535.0, 5266.0, 5442.0, 5376.0, 5642.0, 5251.0, 5384.0, 5308.0, 5626.0, 5648.0, 5566.0, 5606.0, 5433.0, 5656.0, 5294.0, 5545.0, 5458.0, 5332.0, 5614.0, 5300.0, 5620.0, 5432.0, 5423.0, 5397.0, 5427.0, 5374.0, 5253.0, 5615.0, 5687.0, 5679.0, 5261.0, 5646.0, 5569.0, 5649.0, 5354.0, 5722.0, 5619.0, 5653.0, 5516.0, 5403.0, 5488.0, 5670.0, 5596.0, 5381.0, 5601.0, 5640.0, 5686.0, 5383.0, 5585.0, 5630.0, 5595.0, 5301.0, 5632.0, 5635.0, 5605.0, 5361.0, 5579.0, 5368.0, 5475.0, 5655.0, 5269.0, 5281.0, 5676.0, 5481.0, 5443.0, 5571.0, 5519.0, 5622.0 (number of hits: 5)</p>
14	5530	9	1	333	1	<p>5558.0, 5354.0, 5661.0, 5411.0, 5430.0, 5455.0, 5671.0, 5318.0, 5680.0, 5632.0, 5713.0, 5458.0, 5382.0, 5286.0, 5581.0, 5326.0, 5591.0, 5703.0, 5712.0, 5282.0, 5340.0, 5544.0, 5552.0, 5701.0, 5356.0, 5644.0, 5368.0, 5401.0, 5659.0, 5454.0, 5492.0, 5450.0, 5442.0, 5507.0, 5267.0, 5513.0, 5460.0, 5357.0, 5263.0, 5572.0, 5699.0, 5708.0, 5652.0, 5664.0, 5268.0, 5331.0, 5434.0, 5505.0, 5294.0, 5653.0, 5257.0, 5362.0, 5538.0, 5299.0, 5439.0, 5641.0, 5688.0, 5542.0, 5484.0, 5274.0, 5497.0, 5269.0, 5590.0, 5316.0, 5327.0, 5367.0, 5502.0, 5609.0, 5570.0, 5635.0, 5474.0, 5494.0, 5694.0, 5706.0, 5381.0, 5503.0, 5612.0, 5283.0, 5426.0, 5514.0, 5413.0, 5539.0, 5379.0, 5628.0, 5536.0</p>

						5677.0, 5402.0, 5422.0, 5371.0, 5270.0, 5547.0, 5569.0, 5308.0, 5705.0, 5622.0, 5687.0, 5526.0, 5684.0, 5465.0, 5672.0 (number of hits: 4)
15	5530	9	1	333	1	5329.0, 5674.0, 5376.0, 5556.0, 5307.0, 5308.0, 5530.0, 5686.0, 5409.0, 5699.0, 5622.0, 5658.0, 5486.0, 5585.0, 5541.0, 5696.0, 5690.0, 5449.0, 5259.0, 5507.0, 5280.0, 5399.0, 5336.0, 5586.0, 5526.0, 5457.0, 5331.0, 5514.0, 5636.0, 5672.0, 5580.0, 5476.0, 5509.0, 5588.0, 5431.0, 5270.0, 5682.0, 5720.0, 5499.0, 5614.0, 5391.0, 5317.0, 5361.0, 5421.0, 5441.0, 5640.0, 5528.0, 5340.0, 5712.0, 5610.0, 5666.0, 5704.0, 5612.0, 5338.0, 5319.0, 5305.0, 5292.0, 5406.0, 5582.0, 5291.0, 5368.0, 5550.0, 5487.0, 5267.0, 5353.0, 5552.0, 5628.0, 5563.0, 5420.0, 5495.0, 5445.0, 5379.0, 5611.0, 5490.0, 5467.0, 5312.0, 5330.0, 5381.0, 5532.0, 5548.0, 5474.0, 5565.0, 5538.0, 5360.0, 5412.0, 5688.0, 5364.0, 5657.0, 5546.0, 5700.0, 5523.0, 5544.0, 5633.0, 5442.0, 5418.0, 5722.0, 5263.0, 5493.0, 5320.0, 5709.0 (number of hits: 6)
16	5530	9	1	333	1	5351.0, 5326.0, 5502.0, 5252.0, 5422.0, 5298.0, 5355.0, 5323.0, 5672.0, 5390.0, 5352.0, 5448.0, 5679.0, 5652.0, 5273.0, 5332.0, 5471.0, 5518.0, 5521.0, 5640.0, 5470.0, 5267.0, 5573.0, 5720.0, 5702.0, 5426.0, 5708.0, 5437.0, 5529.0, 5658.0, 5576.0, 5321.0, 5458.0, 5365.0, 5328.0, 5596.0, 5259.0, 5542.0, 5325.0, 5563.0, 5441.0, 5701.0, 5485.0, 5713.0, 5705.0, 5555.0, 5369.0, 5607.0, 5373.0, 5344.0, 5314.0, 5512.0, 5372.0, 5654.0, 5433.0, 5483.0, 5572.0, 5719.0, 5651.0, 5587.0, 5621.0, 5415.0, 5285.0, 5472.0, 5294.0, 5582.0, 5400.0, 5339.0, 5559.0, 5509.0, 5378.0, 5272.0, 5583.0, 5473.0, 5284.0, 5408.0, 5682.0, 5487.0, 5282.0, 5394.0, 5692.0, 5516.0, 5392.0, 5633.0, 5315.0, 5391.0, 5508.0, 5452.0, 5552.0, 5406.0, 5469.0, 5382.0, 5674.0, 5681.0, 5707.0, 5567.0, 5357.0, 5439.0, 5665.0, 5541.0 (number of hits: 4)
17	5530	9	1	333	1	5708.0, 5522.0, 5605.0, 5681.0, 5383.0, 5543.0, 5426.0, 5620.0, 5596.0, 5622.0, 5600.0, 5608.0, 5500.0, 5553.0, 5428.0, 5398.0, 5650.0, 5331.0, 5589.0, 5569.0, 5384.0, 5645.0, 5468.0, 5688.0, 5303.0, 5389.0, 5675.0, 5544.0, 5518.0, 5344.0, 5660.0, 5251.0, 5439.0, 5457.0, 5529.0, 5554.0, 5719.0, 5429.0, 5339.0, 5349.0, 5411.0, 5257.0, 5407.0, 5279.0, 5412.0, 5614.0, 5351.0, 5603.0, 5511.0, 5254.0, 5477.0, 5654.0, 5365.0, 5625.0, 5577.0, 5538.0, 5505.0, 5480.0, 5323.0, 5624.0, 5691.0, 5353.0, 5578.0, 5452.0, 5435.0

						5487.0, 5694.0, 5319.0, 5634.0, 5557.0, 5255.0, 5378.0, 5484.0, 5661.0, 5713.0, 5324.0, 5593.0, 5612.0, 5462.0, 5515.0, 5431.0, 5320.0, 5427.0, 5350.0, 5402.0, 5655.0, 5549.0, 5636.0, 5641.0, 5637.0, 5445.0, 5693.0, 5302.0, 5458.0, 5568.0, 5555.0, 5459.0, 5310.0, 5470.0, 5701.0 (number of hits: 3 )
18	5530	9	1	333	1	5638.0, 5546.0, 5507.0, 5490.0, 5423.0, 5636.0, 5685.0, 5466.0, 5430.0, 5599.0, 5625.0, 5523.0, 5374.0, 5690.0, 5565.0, 5634.0, 5429.0, 5445.0, 5649.0, 5604.0, 5480.0, 5411.0, 5528.0, 5702.0, 5459.0, 5298.0, 5494.0, 5410.0, 5296.0, 5595.0, 5284.0, 5646.0, 5336.0, 5476.0, 5375.0, 5619.0, 5687.0, 5400.0, 5647.0, 5710.0, 5442.0, 5340.0, 5542.0, 5327.0, 5697.0, 5331.0, 5311.0, 5659.0, 5271.0, 5250.0, 5489.0, 5582.0, 5711.0, 5452.0, 5387.0, 5291.0, 5591.0, 5385.0, 5346.0, 5628.0, 5665.0, 5434.0, 5700.0, 5344.0, 5335.0, 5319.0, 5524.0, 5497.0, 5302.0, 5485.0, 5288.0, 5424.0, 5676.0, 5337.0, 5396.0, 5723.0, 5683.0, 5597.0, 5556.0, 5471.0, 5703.0, 5538.0, 5437.0, 5467.0, 5295.0, 5478.0, 5630.0, 5262.0, 5552.0, 5403.0, 5562.0, 5415.0, 5719.0, 5496.0, 5577.0, 5460.0, 5275.0, 5571.0, 5280.0, 5506.0 (number of hits: 7 )
19	5530	9	1	333	1	5511.0, 5703.0, 5397.0, 5679.0, 5583.0, 5610.0, 5627.0, 5622.0, 5353.0, 5492.0, 5642.0, 5410.0, 5432.0, 5563.0, 5635.0, 5665.0, 5289.0, 5413.0, 5611.0, 5570.0, 5387.0, 5348.0, 5332.0, 5317.0, 5555.0, 5261.0, 5539.0, 5264.0, 5430.0, 5373.0, 5647.0, 5581.0, 5644.0, 5470.0, 5620.0, 5459.0, 5661.0, 5312.0, 5524.0, 5309.0, 5285.0, 5716.0, 5513.0, 5369.0, 5532.0, 5681.0, 5304.0, 5637.0, 5613.0, 5425.0, 5402.0, 5568.0, 5713.0, 5455.0, 5263.0, 5552.0, 5253.0, 5496.0, 5519.0, 5590.0, 5381.0, 5293.0, 5435.0, 5427.0, 5322.0, 5573.0, 5721.0, 5439.0, 5386.0, 5670.0, 5650.0, 5370.0, 5504.0, 5385.0, 5281.0, 5445.0, 5468.0, 5482.0, 5699.0, 5724.0, 5277.0, 5421.0, 5688.0, 5389.0, 5720.0, 5265.0, 5259.0, 5330.0, 5422.0, 5475.0, 5301.0, 5379.0, 5618.0, 5494.0, 5390.0, 5399.0, 5257.0, 5327.0, 5501.0, 5367.0 (number of hits: 7 )
20	5530	9	1	333	1	5366.0, 5349.0, 5703.0, 5641.0, 5299.0, 5531.0, 5602.0, 5529.0, 5569.0, 5325.0, 5546.0, 5697.0, 5437.0, 5311.0, 5681.0, 5537.0, 5286.0, 5485.0, 5673.0, 5395.0, 5289.0, 5563.0, 5499.0, 5319.0, 5432.0, 5592.0, 5479.0, 5684.0, 5512.0, 5701.0, 5369.0, 5487.0, 5455.0, 5553.0, 5654.0, 5534.0, 5640.0, 5310.0, 5708.0, 5448.0, 5296.0, 5620.0, 5278.0, 5591.0, 5642.0,

						5273.0, 5587.0, 5542.0, 5495.0, 5330.0, 5470.0, 5373.0, 5689.0, 5686.0, 5431.0, 5318.0, 5387.0, 5500.0, 5605.0, 5651.0, 5515.0, 5538.0, 5484.0, 5365.0, 5612.0, 5386.0, 5705.0, 5549.0, 5715.0, 5316.0, 5457.0, 5494.0, 5417.0, 5340.0, 5545.0, 5604.0, 5382.0, 5699.0, 5516.0, 5337.0, 5581.0, 5619.0, 5672.0, 5565.0, 5454.0, 5685.0, 5308.0, 5547.0, 5562.0, 5288.0, 5302.0, 5509.0, 5506.0, 5560.0, 5389.0, 5698.0, 5721.0, 5561.0, 5348.0, 5328.0 (number of hits: 9)
21	5530	9	1	333	1	5686.0, 5401.0, 5699.0, 5296.0, 5386.0, 5575.0, 5705.0, 5305.0, 5458.0, 5297.0, 5573.0, 5449.0, 5568.0, 5327.0, 5256.0, 5514.0, 5342.0, 5332.0, 5470.0, 5681.0, 5532.0, 5495.0, 5610.0, 5309.0, 5258.0, 5703.0, 5625.0, 5537.0, 5668.0, 5443.0, 5382.0, 5722.0, 5518.0, 5430.0, 5497.0, 5717.0, 5476.0, 5291.0, 5643.0, 5277.0, 5488.0, 5419.0, 5483.0, 5721.0, 5338.0, 5698.0, 5596.0, 5570.0, 5468.0, 5406.0, 5261.0, 5527.0, 5471.0, 5398.0, 5611.0, 5517.0, 5285.0, 5255.0, 5655.0, 5678.0, 5701.0, 5674.0, 5320.0, 5252.0, 5613.0, 5352.0, 5455.0, 5496.0, 5581.0, 5374.0, 5259.0, 5491.0, 5710.0, 5472.0, 5475.0, 5300.0, 5307.0, 5312.0, 5545.0, 5459.0, 5494.0, 5314.0, 5687.0, 5466.0, 5329.0, 5650.0, 5385.0, 5547.0, 5469.0, 5682.0, 5586.0, 5541.0, 5719.0, 5646.0, 5672.0, 5571.0, 5281.0, 5323.0, 5394.0, 5409.0 (number of hits: 10)
22	5530	9	1	333	1	5593.0, 5399.0, 5594.0, 5291.0, 5684.0, 5705.0, 5685.0, 5524.0, 5671.0, 5446.0, 5616.0, 5437.0, 5462.0, 5689.0, 5465.0, 5339.0, 5712.0, 5699.0, 5319.0, 5693.0, 5463.0, 5274.0, 5458.0, 5661.0, 5286.0, 5368.0, 5639.0, 5688.0, 5324.0, 5571.0, 5503.0, 5261.0, 5642.0, 5327.0, 5657.0, 5255.0, 5526.0, 5342.0, 5370.0, 5656.0, 5691.0, 5486.0, 5710.0, 5328.0, 5680.0, 5455.0, 5470.0, 5515.0, 5422.0, 5427.0, 5386.0, 5478.0, 5288.0, 5406.0, 5349.0, 5711.0, 5556.0, 5435.0, 5643.0, 5335.0, 5394.0, 5722.0, 5634.0, 5473.0, 5605.0, 5631.0, 5424.0, 5611.0, 5608.0, 5269.0, 5591.0, 5417.0, 5551.0, 5574.0, 5297.0, 5265.0, 5402.0, 5431.0, 5615.0, 5651.0, 5652.0, 5461.0, 5409.0, 5333.0, 5296.0, 5352.0, 5362.0, 5531.0, 5702.0, 5579.0, 5377.0, 5581.0, 5273.0, 5412.0, 5281.0, 5445.0, 5414.0, 5418.0, 5629.0, 5701.0 (number of hits: 5)
23	5530	9	1	333	1	5623.0, 5279.0, 5371.0, 5267.0, 5393.0, 5459.0, 5255.0, 5721.0, 5583.0, 5320.0, 5663.0, 5582.0, 5648.0, 5567.0, 5318.0, 5461.0, 5422.0, 5295.0, 5359.0, 5599.0, 5457.0, 5637.0, 5356.0, 5592.0, 5672.0,

						5347.0, 5545.0, 5681.0, 5515.0, 5404.0, 5396.0, 5495.0, 5319.0, 5625.0, 5398.0, 5714.0, 5263.0, 5261.0, 5699.0, 5317.0, 5647.0, 5266.0, 5645.0, 5490.0, 5405.0, 5308.0, 5367.0, 5348.0, 5530.0, 5270.0, 5716.0, 5384.0, 5668.0, 5691.0, 5296.0, 5315.0, 5402.0, 5483.0, 5539.0, 5389.0, 5454.0, 5692.0, 5311.0, 5466.0, 5708.0, 5269.0, 5300.0, 5531.0, 5652.0, 5676.0, 5321.0, 5285.0, 5553.0, 5492.0, 5554.0, 5502.0, 5594.0, 5331.0, 5474.0, 5512.0, 5611.0, 5302.0, 5522.0, 5479.0, 5666.0, 5516.0, 5653.0, 5513.0, 5403.0, 5410.0, 5306.0, 5312.0, 5609.0, 5537.0, 5646.0, 5523.0, 5493.0, 5644.0, 5604.0, 5361.0 (number of hits: 9)
24	5530	9	1	333	1	5253.0, 5446.0, 5581.0, 5456.0, 5598.0, 5419.0, 5503.0, 5341.0, 5494.0, 5409.0, 5654.0, 5401.0, 5451.0, 5590.0, 5563.0, 5605.0, 5626.0, 5455.0, 5480.0, 5259.0, 5315.0, 5710.0, 5613.0, 5528.0, 5565.0, 5531.0, 5492.0, 5621.0, 5683.0, 5407.0, 5557.0, 5693.0, 5469.0, 5712.0, 5344.0, 5348.0, 5697.0, 5721.0, 5709.0, 5670.0, 5402.0, 5612.0, 5500.0, 5515.0, 5467.0, 5720.0, 5594.0, 5576.0, 5577.0, 5711.0, 5620.0, 5422.0, 5370.0, 5667.0, 5568.0, 5277.0, 5509.0, 5266.0, 5382.0, 5355.0, 5484.0, 5272.0, 5493.0, 5352.0, 5578.0, 5704.0, 5260.0, 5399.0, 5365.0, 5269.0, 5723.0, 5297.0, 5271.0, 5342.0, 5638.0, 5533.0, 5359.0, 5288.0, 5586.0, 5625.0, 5349.0, 5615.0, 5608.0, 5542.0, 5562.0, 5488.0, 5622.0, 5694.0, 5611.0, 5335.0, 5334.0, 5674.0, 5440.0, 5541.0, 5678.0, 5279.0, 5282.0, 5599.0, 5601.0, 5715.0 (number of hits: 2)
25	5530	9	1	333	1	5551.0, 5360.0, 5514.0, 5507.0, 5707.0, 5617.0, 5576.0, 5683.0, 5300.0, 5376.0, 5722.0, 5657.0, 5271.0, 5505.0, 5654.0, 5262.0, 5438.0, 5586.0, 5254.0, 5564.0, 5417.0, 5687.0, 5310.0, 5441.0, 5433.0, 5675.0, 5668.0, 5694.0, 5491.0, 5608.0, 5653.0, 5721.0, 5393.0, 5520.0, 5550.0, 5601.0, 5609.0, 5421.0, 5680.0, 5291.0, 5399.0, 5340.0, 5490.0, 5506.0, 5648.0, 5284.0, 5629.0, 5701.0, 5427.0, 5343.0, 5619.0, 5407.0, 5263.0, 5479.0, 5258.0, 5686.0, 5493.0, 5708.0, 5621.0, 5623.0, 5282.0, 5599.0, 5472.0, 5552.0, 5655.0, 5697.0, 5287.0, 5385.0, 5712.0, 5296.0, 5640.0, 5690.0, 5658.0, 5431.0, 5391.0, 5459.0, 5495.0, 5508.0, 5367.0, 5536.0, 5556.0, 5293.0, 5437.0, 5432.0, 5425.0, 5338.0, 5369.0, 5561.0, 5620.0, 5302.0, 5542.0, 5642.0, 5311.0, 5436.0, 5641.0, 5294.0, 5681.0, 5267.0, 5404.0, 5354.0 (number of hits: 9)
26	5530	9	1	333	1	5665.0, 5269.0, 5330.0, 5424.0, 5304.0,

						5594.0, 5309.0, 5360.0, 5333.0, 5489.0, 5327.0, 5618.0, 5490.0, 5703.0, 5494.0, 5679.0, 5720.0, 5647.0, 5450.0, 5464.0, 5455.0, 5586.0, 5668.0, 5454.0, 5372.0, 5559.0, 5340.0, 5483.0, 5470.0, 5306.0, 5283.0, 5313.0, 5651.0, 5673.0, 5654.0, 5411.0, 5575.0, 5567.0, 5361.0, 5709.0, 5391.0, 5565.0, 5451.0, 5605.0, 5364.0, 5642.0, 5723.0, 5406.0, 5262.0, 5430.0, 5271.0, 5322.0, 5579.0, 5480.0, 5496.0, 5417.0, 5288.0, 5631.0, 5711.0, 5447.0, 5521.0, 5550.0, 5615.0, 5603.0, 5541.0, 5478.0, 5525.0, 5588.0, 5264.0, 5716.0, 5387.0, 5643.0, 5267.0, 5321.0, 5538.0, 5472.0, 5292.0, 5607.0, 5492.0, 5415.0, 5632.0, 5611.0, 5659.0, 5453.0, 5598.0, 5452.0, 5385.0, 5449.0, 5544.0, 5572.0, 5561.0, 5587.0, 5695.0, 5425.0, 5574.0, 5600.0, 5347.0, 5589.0, 5326.0, 5721.0 (number of hits: 6)
27	5530	9	1	333	1	5538.0, 5428.0, 5602.0, 5590.0, 5396.0, 5380.0, 5575.0, 5364.0, 5393.0, 5661.0, 5510.0, 5282.0, 5392.0, 5543.0, 5432.0, 5336.0, 5685.0, 5721.0, 5714.0, 5331.0, 5506.0, 5589.0, 5513.0, 5595.0, 5338.0, 5366.0, 5660.0, 5377.0, 5697.0, 5502.0, 5571.0, 5276.0, 5305.0, 5529.0, 5535.0, 5354.0, 5578.0, 5352.0, 5294.0, 5414.0, 5416.0, 5254.0, 5278.0, 5286.0, 5487.0, 5609.0, 5287.0, 5488.0, 5623.0, 5273.0, 5464.0, 5266.0, 5265.0, 5389.0, 5279.0, 5634.0, 5412.0, 5498.0, 5312.0, 5559.0, 5585.0, 5612.0, 5441.0, 5526.0, 5600.0, 5643.0, 5425.0, 5486.0, 5553.0, 5635.0, 5496.0, 5413.0, 5666.0, 5627.0, 5290.0, 5689.0, 5410.0, 5532.0, 5325.0, 5650.0, 5610.0, 5631.0, 5327.0, 5508.0, 5622.0, 5398.0, 5478.0, 5552.0, 5656.0, 5447.0, 5558.0, 5301.0, 5403.0, 5645.0, 5490.0, 5636.0, 5335.0, 5262.0, 5374.0, 5676.0 (number of hits: 7)
28	5530	9	1	333	1	5327.0, 5255.0, 5388.0, 5463.0, 5448.0, 5698.0, 5412.0, 5408.0, 5373.0, 5535.0, 5435.0, 5687.0, 5355.0, 5641.0, 5436.0, 5628.0, 5617.0, 5488.0, 5485.0, 5499.0, 5414.0, 5377.0, 5723.0, 5577.0, 5433.0, 5671.0, 5302.0, 5294.0, 5330.0, 5721.0, 5646.0, 5362.0, 5262.0, 5649.0, 5424.0, 5661.0, 5283.0, 5276.0, 5347.0, 5304.0, 5715.0, 5459.0, 5701.0, 5357.0, 5407.0, 5543.0, 5611.0, 5514.0, 5494.0, 5364.0, 5380.0, 5513.0, 5366.0, 5601.0, 5318.0, 5599.0, 5654.0, 5612.0, 5370.0, 5524.0, 5648.0, 5676.0, 5476.0, 5593.0, 5409.0, 5281.0, 5251.0, 5668.0, 5403.0, 5663.0, 5704.0, 5395.0, 5351.0, 5385.0, 5383.0, 5679.0, 5420.0, 5531.0, 5480.0, 5311.0, 5719.0, 5483.0, 5422.0, 5427.0, 5450.0, 5445.0, 5594.0, 5404.0, 5695.0, 5279.0

						5688.0, 5289.0, 5268.0, 5300.0, 5343.0, 5658.0, 5271.0, 5259.0, 5308.0, 5596.0 (number of hits: 7)
29	5530	9	1	333	1	5320.0, 5657.0, 5451.0, 5399.0, 5666.0, 5632.0, 5461.0, 5712.0, 5251.0, 5275.0, 5495.0, 5342.0, 5691.0, 5482.0, 5260.0, 5466.0, 5281.0, 5683.0, 5687.0, 5479.0, 5716.0, 5677.0, 5590.0, 5347.0, 5355.0, 5313.0, 5487.0, 5291.0, 5585.0, 5628.0, 5371.0, 5592.0, 5448.0, 5656.0, 5453.0, 5416.0, 5361.0, 5317.0, 5658.0, 5586.0, 5301.0, 5690.0, 5527.0, 5374.0, 5345.0, 5538.0, 5322.0, 5303.0, 5389.0, 5685.0, 5524.0, 5253.0, 5570.0, 5617.0, 5410.0, 5372.0, 5438.0, 5694.0, 5622.0, 5689.0, 5722.0, 5436.0, 5430.0, 5507.0, 5325.0, 5595.0, 5601.0, 5675.0, 5256.0, 5397.0, 5367.0, 5670.0, 5580.0, 5551.0, 5643.0, 5563.0, 5612.0, 5500.0, 5333.0, 5718.0, 5398.0, 5546.0, 5378.0, 5671.0, 5366.0, 5648.0, 5414.0, 5539.0, 5351.0, 5613.0, 5255.0, 5493.0, 5556.0, 5508.0, 5636.0, 5340.0, 5468.0, 5681.0, 5609.0, 5562.0 (number of hits: 4)
30	5530	9	1	333	1	5474.0, 5349.0, 5702.0, 5358.0, 5353.0, 5309.0, 5376.0, 5453.0, 5368.0, 5356.0, 5722.0, 5293.0, 5638.0, 5663.0, 5718.0, 5400.0, 5461.0, 5340.0, 5532.0, 5386.0, 5351.0, 5647.0, 5473.0, 5374.0, 5467.0, 5662.0, 5393.0, 5695.0, 5444.0, 5614.0, 5588.0, 5274.0, 5419.0, 5531.0, 5319.0, 5513.0, 5422.0, 5425.0, 5354.0, 5466.0, 5696.0, 5723.0, 5292.0, 5481.0, 5658.0, 5714.0, 5268.0, 5291.0, 5348.0, 5593.0, 5406.0, 5576.0, 5618.0, 5388.0, 5261.0, 5454.0, 5457.0, 5693.0, 5541.0, 5436.0, 5517.0, 5507.0, 5434.0, 5459.0, 5495.0, 5571.0, 5665.0, 5521.0, 5424.0, 5512.0, 5314.0, 5265.0, 5527.0, 5634.0, 5339.0, 5529.0, 5715.0, 5673.0, 5553.0, 5574.0, 5369.0, 5508.0, 5719.0, 5655.0, 5503.0, 5323.0, 5589.0, 5344.0, 5494.0, 5399.0, 5627.0, 5383.0, 5669.0, 5709.0, 5491.0, 5639.0, 5625.0, 5451.0, 5551.0, 5659.0 (number of hits: 5)



## 10 Appendix A – Test Setup Photographs

### 10.1 DFS Test Setup View

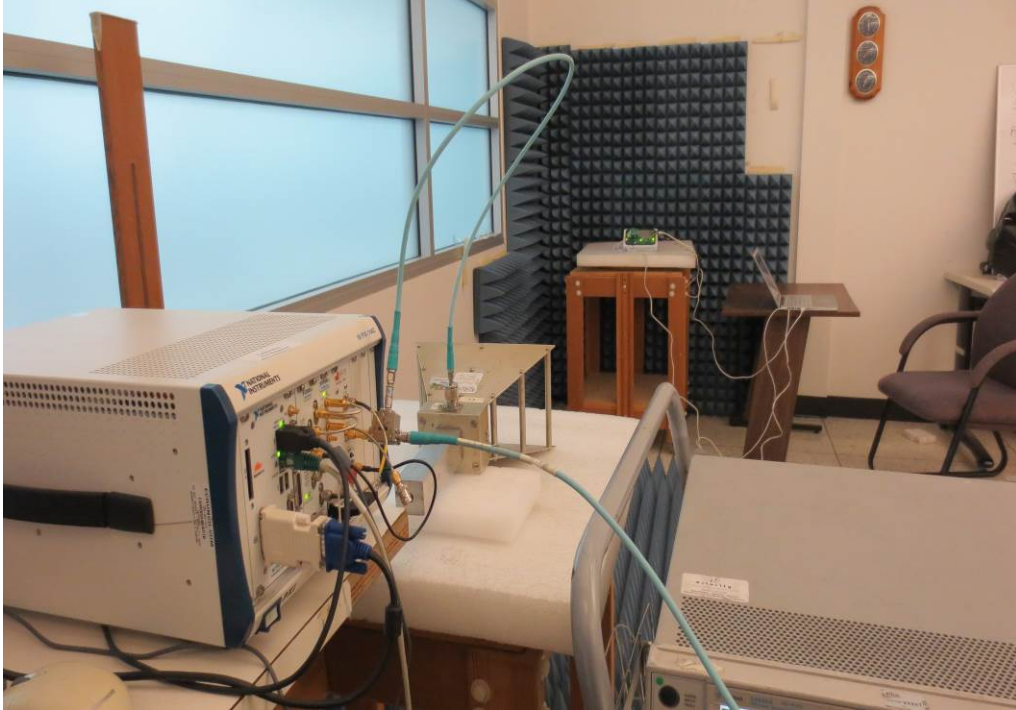

## 11 Appendix B – EUT Photographs

### 11.1 EUT- Top View



### 11.2 EUT- Bottom View



### 11.3 EUT - Open Case View



### 11.4 EUT - Main PCB Board

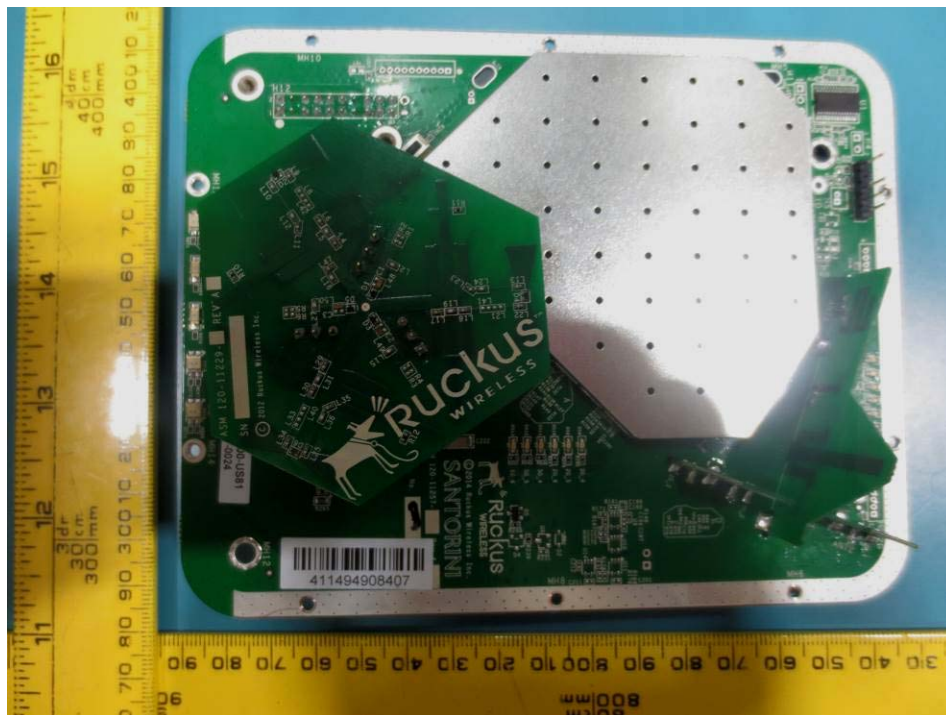

### 11.5 EUT - Main PCB Board Rear View

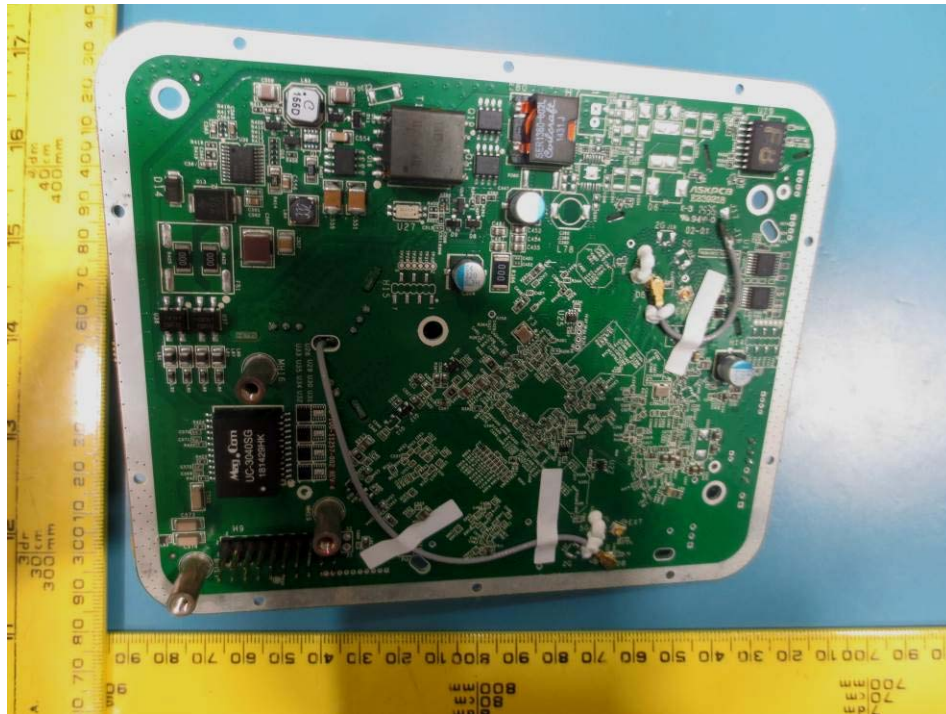

### 11.6 EUT - RJ45 Port Front View

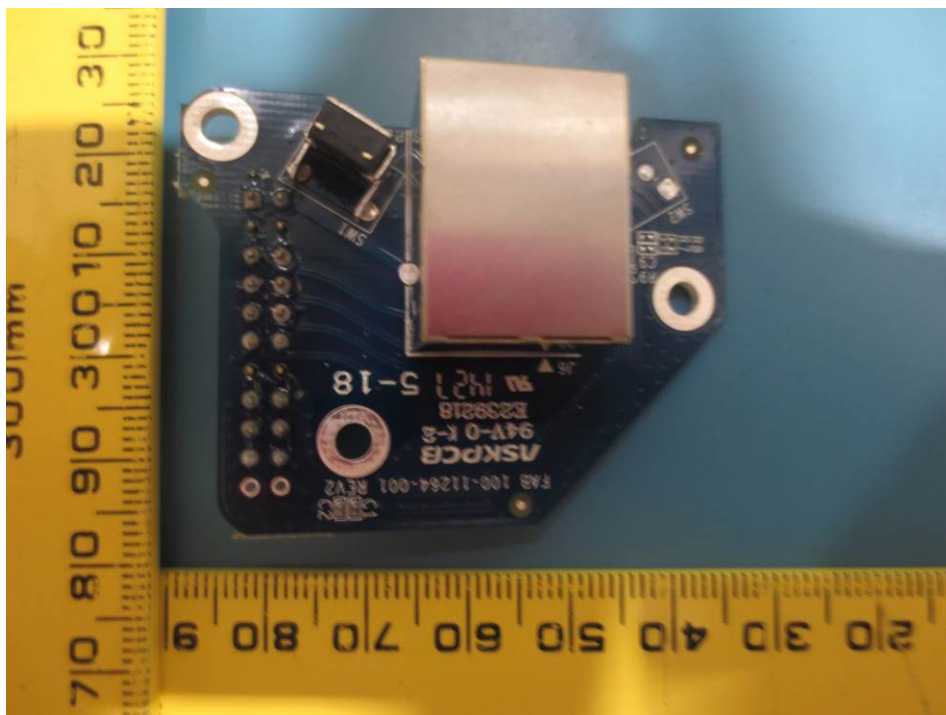

### 11.7 EUT - RJ45 Port Rear View

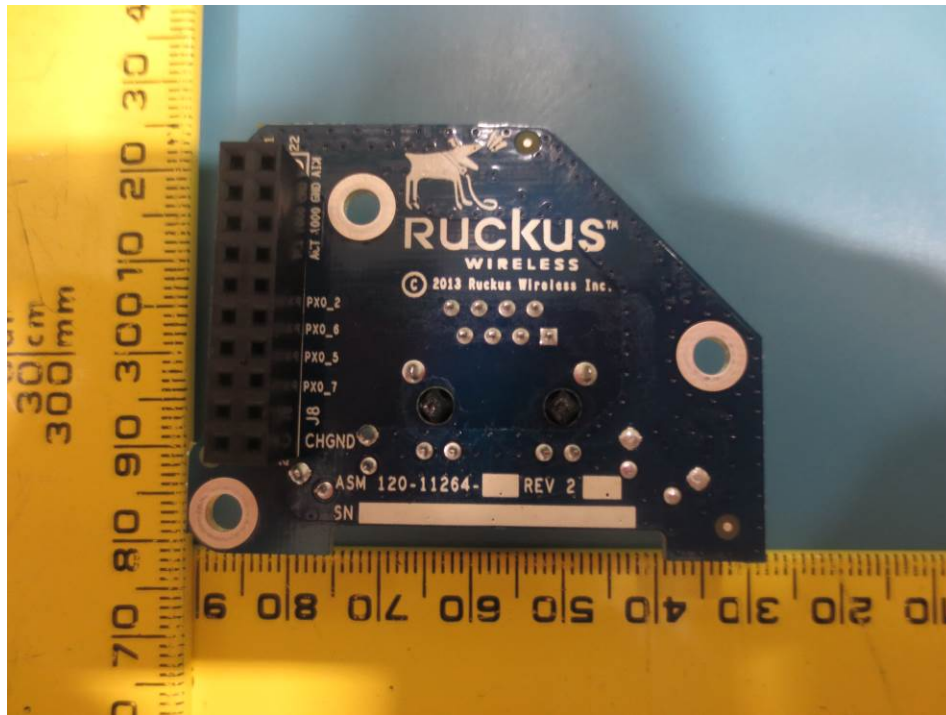

### 11.8 EUT - Ruckus Board Front View

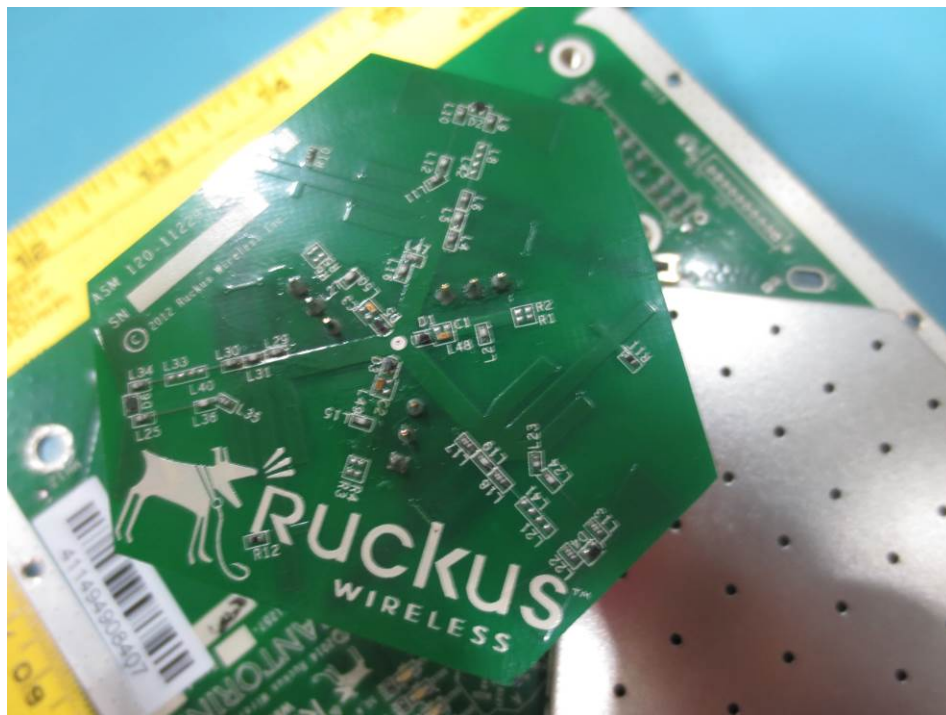

### 11.9 EUT - IZAR Board Front View

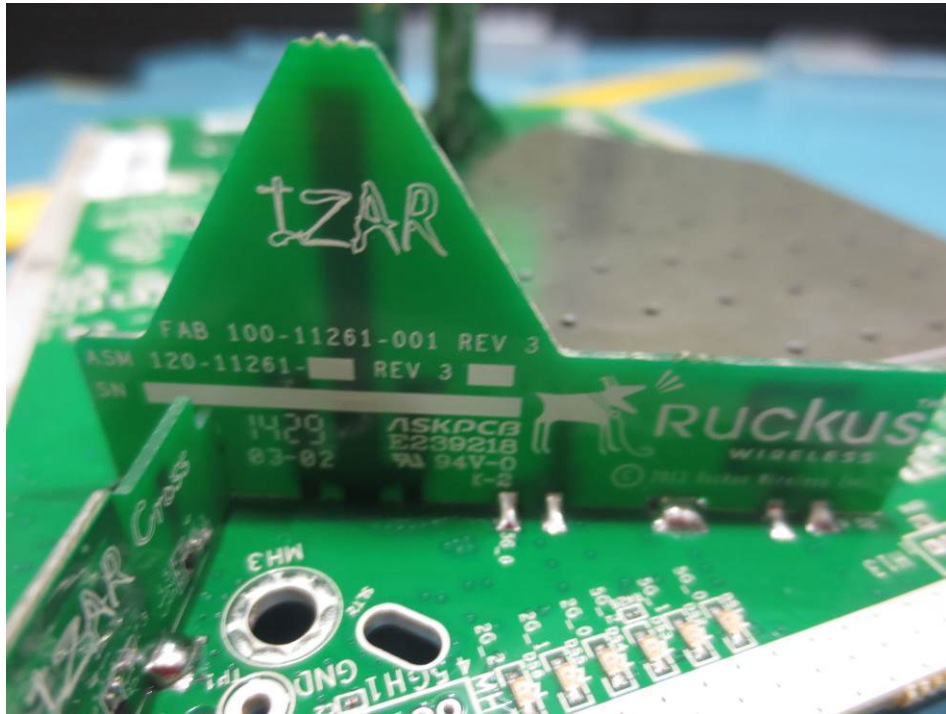

### 11.10 EUT - IZAR CROSS Board Front View

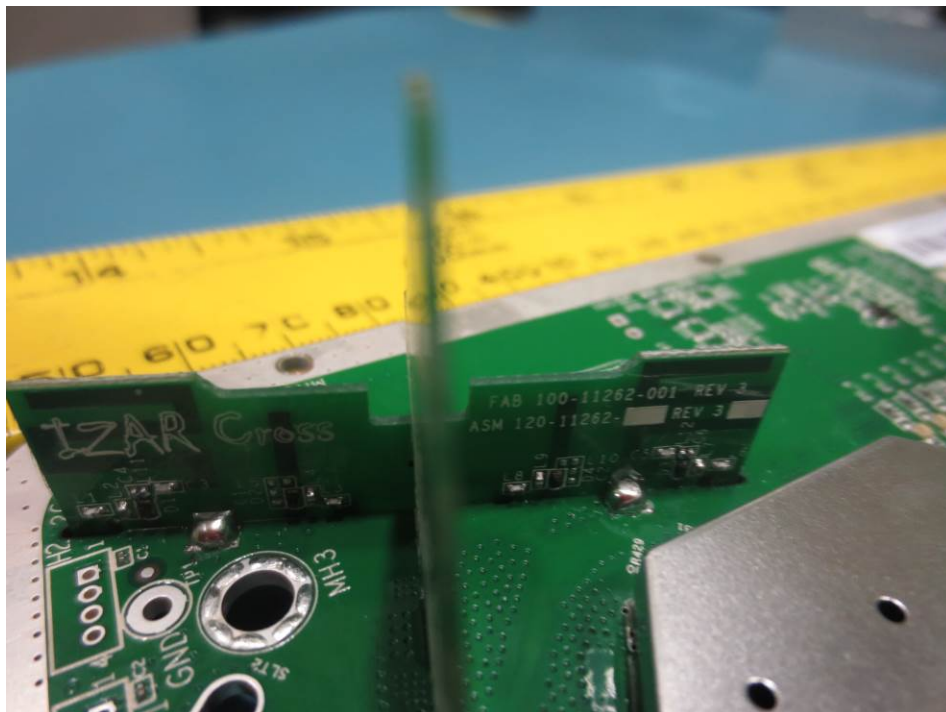

### 11.11 AC Adapter



--- END OF REPORT ---