



FCC RADIO TEST REPORT

FCC ID : S9GR760
Equipment : R760 Access Point
Brand Name : RUCKUS
Model Name : R760
Applicant : Ruckus Wireless Inc.
350 W. Java Dr., Sunnyvale CA 94089 USA
Manufacturer : Ruckus Wireless Inc.
350 W. Java Dr., Sunnyvale CA 94089 USA
Standard : FCC Part 15 Subpart E §15.407

The product was received on Jul. 28, 2021 and testing was performed from Aug. 15, 2021 to Feb. 07, 2023. We, Sporton International (USA) Inc., would like to declare that the tested sample has been evaluated in accordance with the test procedures and has been in compliance with the applicable technical standards.

The test results in this variant report apply exclusively to the tested model / sample. Without written approval from Sporton International (USA) Inc., the test report shall not be reproduced except in full.

Approved by: Neil Kao

Sporton International (USA) Inc.
1175 Montague Expressway, Milpitas, CA 95035



Table of Contents

History of this test report.....	3
Summary of Test Result.....	4
1 General Description	5
1.1 Product Feature of Equipment Under Test.....	5
1.2 Modification of EUT	6
1.3 Testing Location	7
1.4 Applicable Standards.....	7
2 Test Configuration of Equipment Under Test	8
2.1 Carrier Frequency and Channel	8
2.2 Test Mode.....	9
2.3 Connection Diagram of Test System.....	12
2.4 Support Unit used in test configuration and system	13
2.5 EUT Operation Test Setup	13
2.6 Measurement Results Explanation Example.....	14
3 Test Result	15
3.1 6dB and 26dB and 99% Occupied Bandwidth Measurement	15
3.2 Maximum Conducted Output Power Measurement	24
3.3 Power Spectral Density Measurement	26
3.4 Unwanted Emissions Measurement.....	40
3.5 AC Conducted Emission Measurement.....	46
3.6 Antenna Requirements.....	48
4 List of Measuring Equipment.....	52
5 Uncertainty of Evaluation.....	54
Appendix A. Conducted Test Results	
Appendix B. AC Conducted Emission Test Result	
Appendix C. Radiated Spurious Emission	
Appendix D. Radiated Spurious Emission Plots	
Appendix E. Duty Cycle Plots	
Appendix F. Setup Photographs	



Summary of Test Result

Report Clause	Ref Std. Clause	Test Items	Result (PASS/FAIL)	Remark
3.1	15.403(i)	6dB & 26dB Bandwidth	Pass	-
3.1	2.1049	99% Occupied Bandwidth	Reporting only	-
3.2	15.407(a)	Maximum Conducted Output Power	Pass	-
3.3	15.407(a)	Power Spectral Density	Pass	-
3.4	15.407(b)	Unwanted Emissions	Pass	0.31 dB under the limit at 11650.000 MHz
3.5	15.207	AC Conducted Emission	Pass	9.27 dB under the limit at 0.369 MHz
3.6	15.203 15.407(a)	Antenna Requirement	Pass	-

Note:

- 1. This is a variant report by adding Partial RU data. The FR210728001-04C report reuses Full RU and AC Conducted Emission data from the original report number FR210728001E.
- 2. This test report verifies the software change which is only associated with Partial Loaded RU. The maximum power and antenna design remain identical.

Conformity Assessment Condition:
1. The test results (PASS/FAIL) with all measurement uncertainty excluded are presented against the regulation limits or in accordance with the requirements stipulated by the applicant/manufacturer who shall bear all the risks of non-compliance that may potentially occur if measurement uncertainty is taken into account.
2. Please refer to the section " Uncertainty of Evaluation " for measurement uncertainty.
Comments and Explanations:
The product specifications of the EUT presented in the report are declared by the manufacturer who shall take full responsibility for the authenticity.



1 General Description

1.1 Product Feature of Equipment Under Test

The EUT is an indoor AP with radios including Bluetooth - LE, Wi-Fi 2.4GHz 802.11b/g/n/ac/ax, Wi-Fi 5GHz 802.11a/n/ac/ax, Wi-Fi 6GHz 802.11a/n/ac/ax, 802.15.4 (Zigbee), equipped with integrated antennas configured below:

Antenna Configuration	
Antenna Type	<p>WLAN 2.4GHz <Ant. A>: Omni Antenna <Ant. B>: Omni Antenna <Ant. C>: Omni Antenna <Ant. D>: Omni Antenna</p> <p>WLAN 5GHz Radio 1 and Radio 2: <Ant. A>: Omni Antenna <Ant. B>: Omni Antenna <Ant. C>: Omni Antenna <Ant. D>: Omni Antenna</p> <p>Radio 3: <Ant. E>: Omni Antenna <Ant. F>: Omni Antenna <Ant. G>: Omni Antenna <Ant. H>: Omni Antenna</p> <p>WLAN 6GHz <Ant. E>: Omni Antenna <Ant. F>: Omni Antenna <Ant. G>: Omni Antenna <Ant. H>: Omni Antenna</p> <p>Bluetooth-LE: <Ant. 1>Omni Antenna Zigbee: <Ant. 1>Omni Antenna</p>

Antenna information			
5725 MHz ~ 5850 MHz <Radio 2>	Peak Gain (dBi)	Vertical	<Ant. A>: 2.9 <Ant. D>: 2.9
		Horizontal	<Ant. B>: 2.9 <Ant. C>: 2.9
5725 MHz ~ 5850 MHz <Radio 3>	Peak Gain (dBi)	Vertical	<Ant. E>: 2.9 <Ant. H>: 2.9
		Horizontal	<Ant. F>: 2.9 <Ant. G>: 2.9

Remark:

1. The above EUT's information is declared by manufacturer. Please refer to Comments and Explanations in report summary.
2. The device is a special case of MIMO system with four outputs driving a cross-polarized pair of linearly polarized antennas (noted as "vertical" and "horizontal").
The antenna printed on the secondary board which is vertically/horizontally mounted on the main board.
3. The device has three radio circuits operational in WLAN 5GHz bands, the configuration of each circuit is listed in the following table:

Radio 1	UNII-1, UNII-2a
Radio 2	UNII-1, UNII-2a, UNII-2c, UNII-3
Radio 3	UNII-2c, UNII-3

1.2 Modification of EUT

No modifications made to the EUT during the testing.



1.3 Testing Location

Test Site	Sporton International (USA) Inc.
Test Site Location	1175 Montague Expressway, Milpitas, CA 95035 TEL : 408 9043300
Test Site No.	Sporton Site No. TH01-CA, CO01-CA, 03CH02-CA

Note: The test site complies with ANSI C63.4 2014 requirement.

FCC Designation No.: US1250

1.4 Applicable Standards

According to the specifications declared by the manufacturer, the EUT must comply with the requirements of the following standards:

- ♦ FCC Part 15 Subpart E
- ♦ FCC KDB 789033 D02 General UNII Test Procedures New Rules v02r01.
- ♦ FCC KDB 414788 D01 Radiated Test Site v01r01.
- ♦ FCC KDB 662911 D01 Multiple Transmitter Output v02r01.
- ♦ ANSI C63.10-2013

Remark:

All the test items were validated and recorded in accordance with the standards without any modification during the testing.



2 Test Configuration of Equipment Under Test

- a. The EUT has been associated with peripherals and configuration operated in a manner tended to maximize its emission characteristics in a typical application. Frequency range investigated: conduction emission (150 kHz to 30 MHz), radiation emission (9 kHz to the 10th harmonic of the highest fundamental frequency or to 40 GHz, whichever is lower). For radiated measurement, the measured emission level of the EUT was maximized by rotating the EUT on a turntable, adjusting the orientation of the EUT and EUT antenna in three orthogonal axis (X: flat, Y: portrait, Z: landscape), and adjusting the measurement antenna orientation, following C63.10 exploratory test procedures and find X Plane for Radio 2; Z Plane for Radio 3 as worst plane.
- b. AC power line Conducted Emission was tested under maximum output power.

2.1 Carrier Frequency and Channel

Frequency Band	Channel	Freq. (MHz)	Channel	Freq. (MHz)
5725-5850 MHz Band 4 (U-NII-3)	149	5745	157	5785
	151*	5755	159*	5795
	153	5765	161	5805
	155#	5775	165	5825

Note:

1. The above Frequency and Channel with "*" are 802.11n HT40 and 802.11ac VHT40 and 802.11ax HE40.
2. The above Frequency and Channel with "#" are 802.11ac VHT80 and 802.11ax HE80.



2.2 Test Mode

All modulation schemes/data rate are verified by conducted power test case, and the modulation schemes with highest power is used for all test cases. The final test items are considering the modulation schemes and the worst data rates as the table below.

CDD Mode

Modulation	Data Rate
802.11a	6 Mbps
802.11n HT20 (Covered by HE20)	MCS0
802.11n HT40 (Covered by HE40)	MCS0
802.11ac VHT20 (Covered by HE20)	MCS0
802.11ac VHT40 (Covered by HE40)	MCS0
802.11ac VHT80 (Covered by HE80)	MCS0
802.11ax HE20	MCS0
802.11ax HE20 partial RU 52*4	MCS0
802.11ax HE20 partial RU 106*2	MCS0
802.11ax HE40	MCS0
802.11ax HE80	MCS0

**TXBF Mode**

Modulation	Data Rate
802.11a	6 Mbps
802.11n HT20 (Covered by HE20)	MCS0
802.11n HT40 (Covered by HE40)	MCS0
802.11ac VHT20 (Covered by HE20)	MCS0
802.11ac VHT40 (Covered by HE40)	MCS0
802.11ac VHT80 (Covered by HE80)	MCS0
802.11ax HE20	MCS0
802.11ax HE40	MCS0
802.11ax HE80	MCS0

Note:

1. Since the verify power, the smaller power can be covered by the higher power. The SISO Mode is covered by MIMO Mode.
2. After preliminary scan designated by the manufacturer, CDD mode is determined to be the worst case compared to Beamforming mode, hence, all the radiated test is performed in CDD mode.
3. Partial RU 52*4 and 106*2 has smallest occupied spectrum BW among supported partial RU configuration.
4. The PSD of partial RU is reduced to be smaller than full RU according to TCB workshop interim guidance. The 242-tone RU is covered by 20MHz channel, 484-tone RU is covered by 40MHz channel and 996-tone RU is covered by 80MHz channel.
5. The setup method between CDD and Beamforming mode is identical except that one of the polarizations is disabled while Beamforming mode is activated so both modes share the same conducted power table. The only difference is how directional gain is calculated between two modes.



AC Conducted Emission Test Cases are listed in the following table:

Test Cases	
AC Conducted Emission	<p>Mode 1 : WLAN (2.4GHz) Link + Bluetooth - LE Idle + Zigbee Link + AC Adapter + LAN 1 Link+ WLAN (5GHz) (Radio 2) Link + WLAN (6GHz) Link + USB Flash Drive (Load) + LAN2 Link</p> <p>Mode 2 : WLAN (2.4GHz) Link + Bluetooth - LE Idle + Zigbee Link + AC Adapter + LAN 1 Link + WLAN (5GHz) (Radio 3) Link + WLAN (5GHz) (Iron 5G -QPQ190) Link + USB Flash Drive (Load) + LAN 2 Link</p> <p>Mode 3 : WLAN (2.4GHz) Link + Bluetooth – LE Tx + Zigbee Idle + AC Adapter + LAN 1 Link + WLAN (5GHz) (Radio 2) Link + WLAN (6GHz) Link + USB Flash Drive (Load) + LAN 2 Link</p>
Remark: The worst case of Conducted Emission is mode 1; only the test data of it was reported.	

Ch. #		Band IV : 5725-5850 MHz			
		802.11a	802.11ax HE20	802.11ax HE40	802.11ax HE80
L	Low	149	149	151	-
M	Middle	157	157	-	155
H	High	165	165	159	-

Remark: For radiation spurious emission, the modulation and the data rate picked for testing are determined by the Max. RF conducted power.

2.3 Connection Diagram of Test System

<AC Conducted Emission Mode>

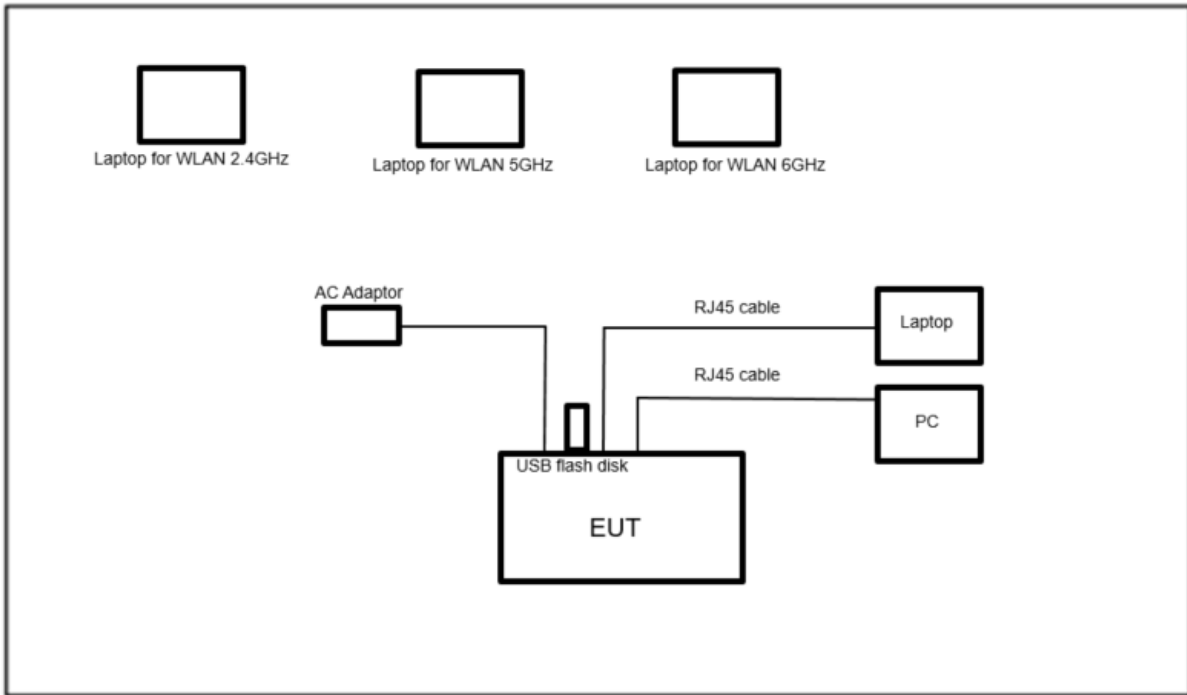

<Radiated Emission Mode>

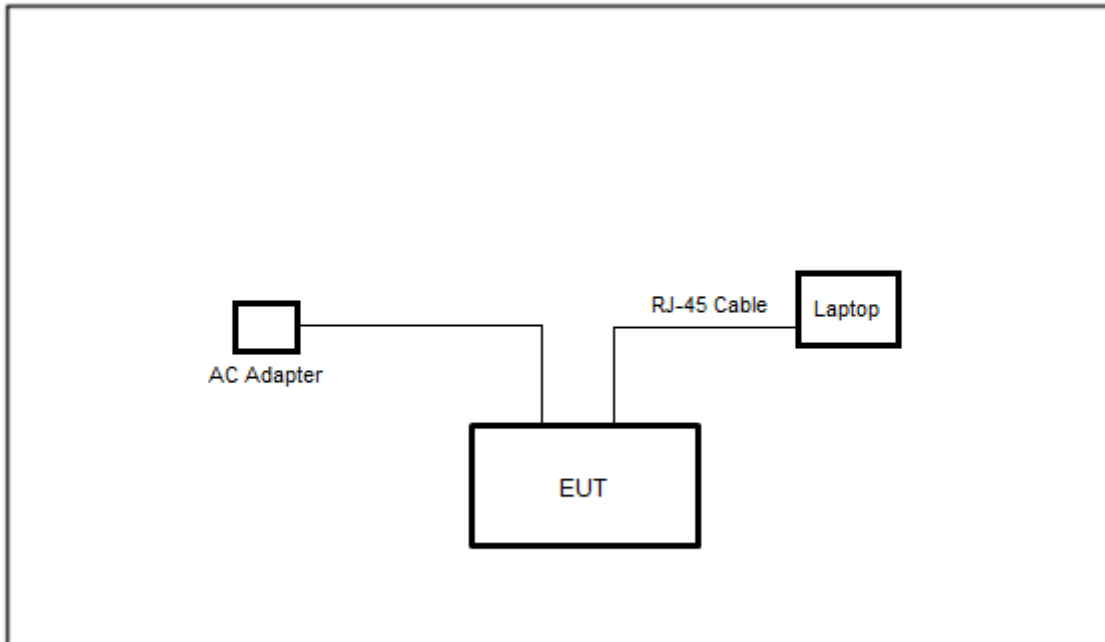



2.4 Support Unit used in test configuration and system

Item	Equipment	Brand Name	Model Name	FCC ID	Data Cable	Power Cord
1.	Notebook	ACER	Altos PS548-G1	FCC DoC	N/A	AC I/P: Unshielded, 1.2m DC O/P: Shielded, 1.8m
2.	Notebook	LENOVO	80RU	FCC DoC	N/A	AC I/P: Unshielded, 1.2m DC O/P: Shielded, 1.8m
3.	Notebook	MSI	MS-17F3	FCC DoC	N/A	AC I/P: Unshielded, 1.2m DC O/P: Shielded, 1.8m
4.	Notebook	ACER	Altos PS548-G1	FCC DoC	N/A	AC I/P: Unshielded, 1.2m DC O/P: Shielded, 1.8m
5.	Notebook	Lenovo	SL11H55466	TP00116F	N/A	AC I/P: Unshielded, 1.2m DC O/P: Shielded, 1.8m
6.	PC	Fractal	FD-C-DEF7A-01 (NETINTX550TR Intel X550T2BLK)	FCC DoC	N/A	AC I/P: Unshielded, 1.2m DC O/P: Shielded, 1.8m
7.	USB Flash drive	SanDisk	N/A	N/A	N/A	N/A
8.	AC Adaptor	Ruckus	740-64277-001	N/A	N/A	AC I/P: Unshielded, 1.2m

2.5 EUT Operation Test Setup

The RF test items, utility “PuTTY VRelease 0.75” was installed in Notebook which was programmed in order to make the EUT get into the engineering modes to provide channel selection, power level, data rate and the application type and for continuous transmitting signals.



2.6 Measurement Results Explanation Example

For all conducted test items:

The offset level is set in the spectrum analyzer to compensate the RF cable loss and attenuator factor between EUT conducted output port and spectrum analyzer. With the offset compensation, the spectrum analyzer reading level is exactly the EUT RF output level.

Example :

The spectrum analyzer offset is derived from RF cable loss and attenuator factor.

Offset = RF cable loss + attenuator factor.

Following shows an offset computation example with cable loss 4.2 dB and 10 dB attenuator.

$$\begin{aligned} \text{Offset(dB)} &= \text{RF cable loss(dB)} + \text{attenuator factor(dB)}. \\ &= 4.2 + 10 = 14.2 \text{ (dB)} \end{aligned}$$

3 Test Result

3.1 6dB and 26dB and 99% Occupied Bandwidth Measurement

3.1.1 Description of 6dB and 26dB and 99% Occupied Bandwidth

The minimum 6 dB bandwidth shall be at least 500 kHz.

26dB and 99% Occupied bandwidth are reporting only.

3.1.2 Measuring Instruments

Please refer to the measuring equipment list in this test report.

3.1.3 Test Procedures

1. The testing follows FCC KDB 789033 D02 General UNII Test Procedures New Rules v02r01. Section C) Emission bandwidth for the band 5.725-5.85 GHz
2. Set RBW = 100 kHz.
3. Set the VBW $\geq 3 \times$ RBW.
4. Detector = Peak.
5. Trace mode = max hold
6. Measure the maximum width of the emission that is 6 dB down from the peak of the emission.
7. Measure and record the results in the test report.

3.1.4 Test Setup

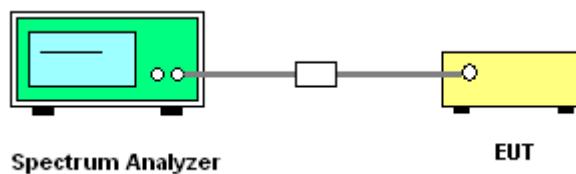

3.1.5 Test Result of 6dB and 26dB and 99% Occupied Bandwidth

Please refer to Appendix A.



<Radio 2>

<CDD Mode>

<802.11a CH149 Ant. A>

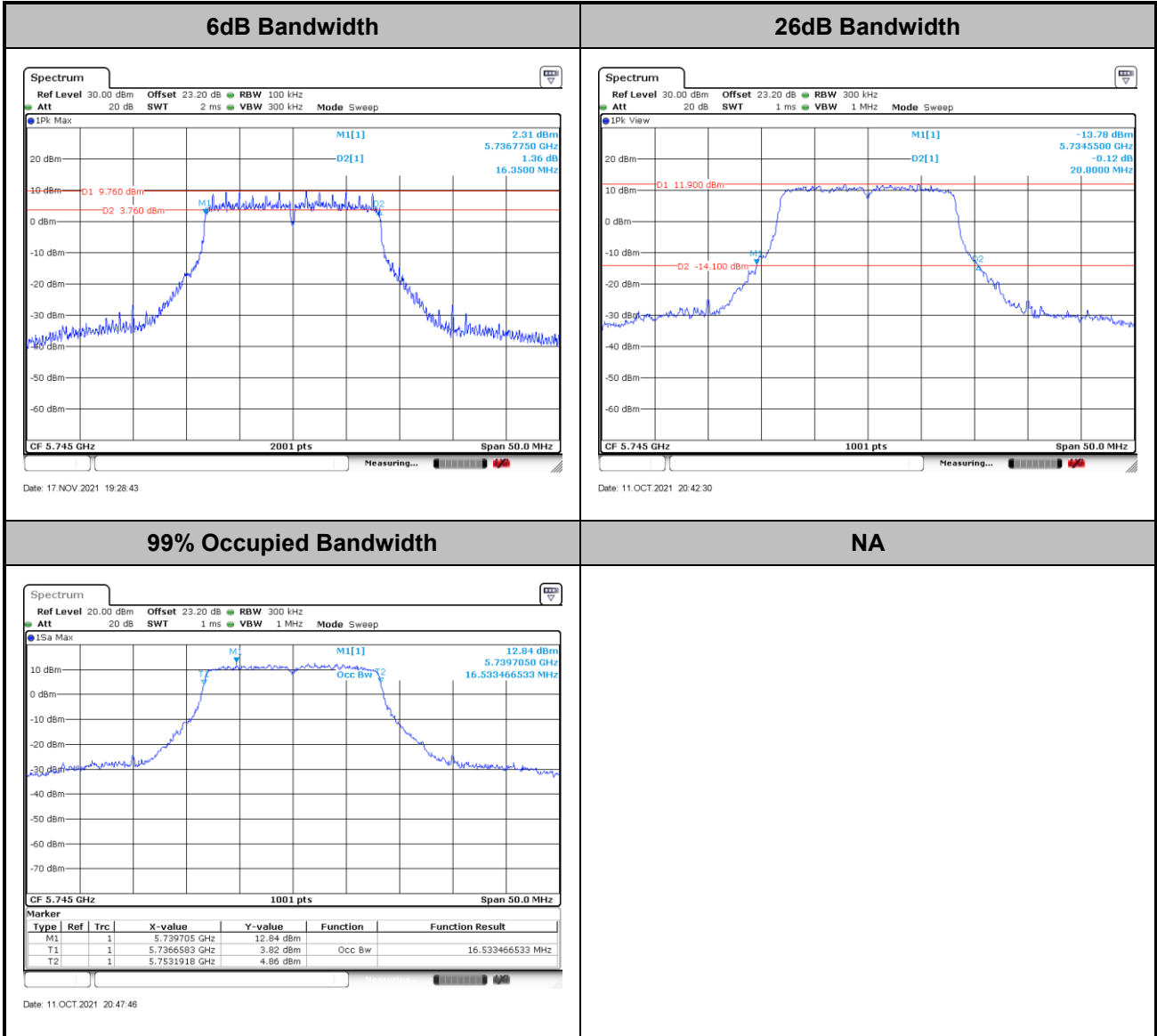

Note: The occupied channel bandwidth is maintained within the band of operation for all of the modulations.



<802.11ax HE20 CH149 Ant. A>

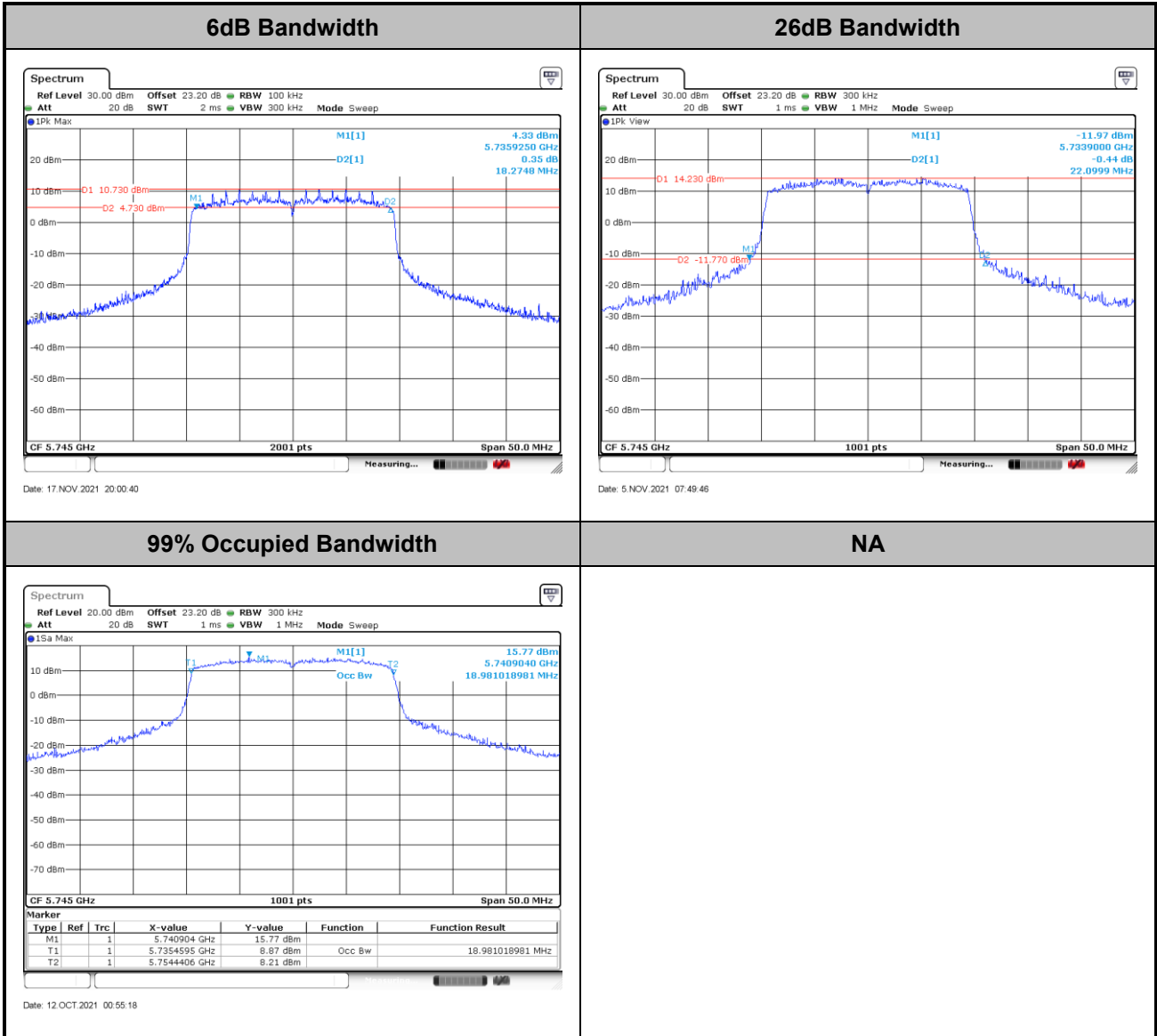

Note: The occupied channel bandwidth is maintained within the band of operation for all of the modulations.



<802.11ax HE40 CH151 Ant. A>

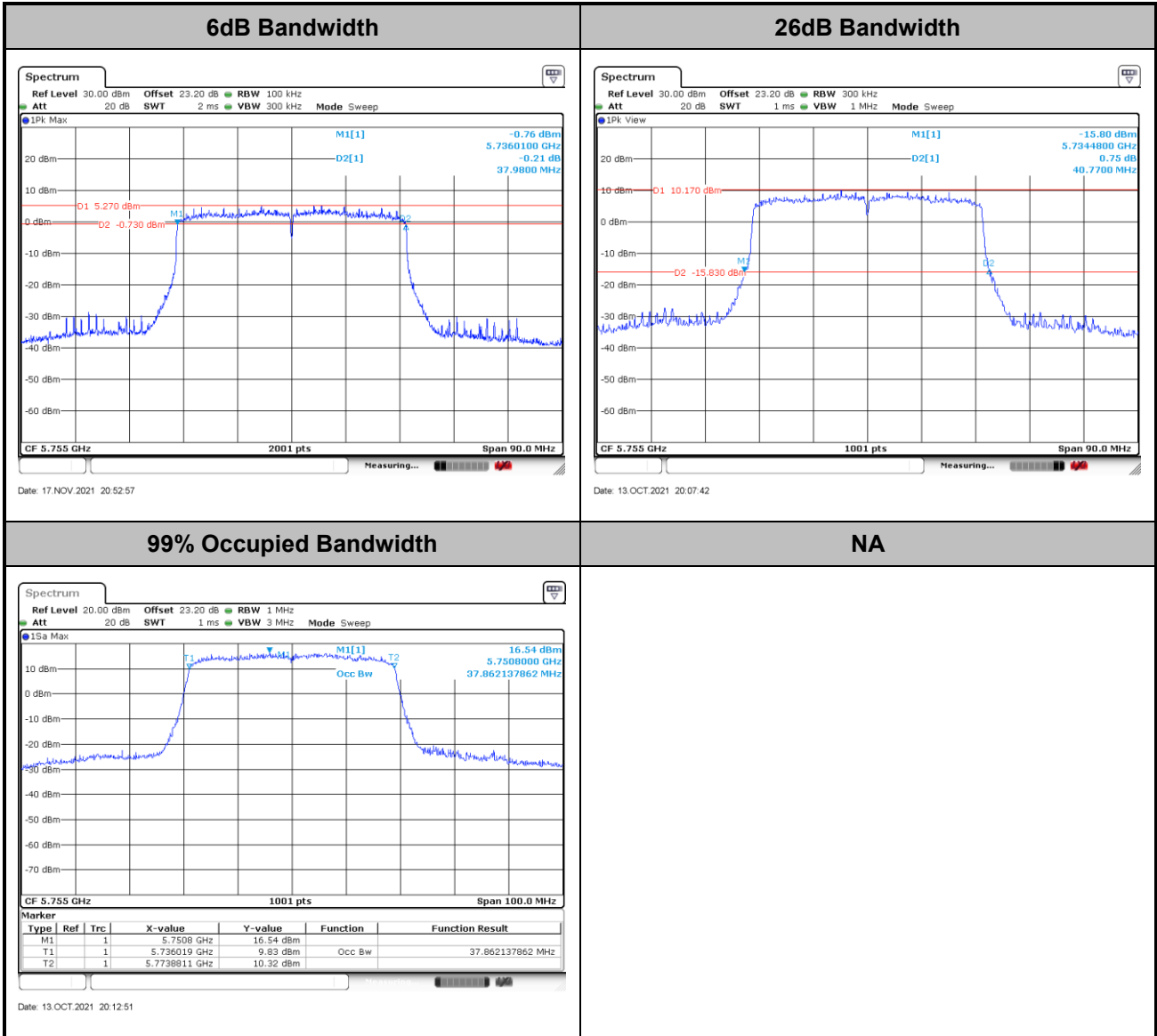

Note: The occupied channel bandwidth is maintained within the band of operation for all of the modulations.



<802.11ax HE80 CH155 Ant. A>

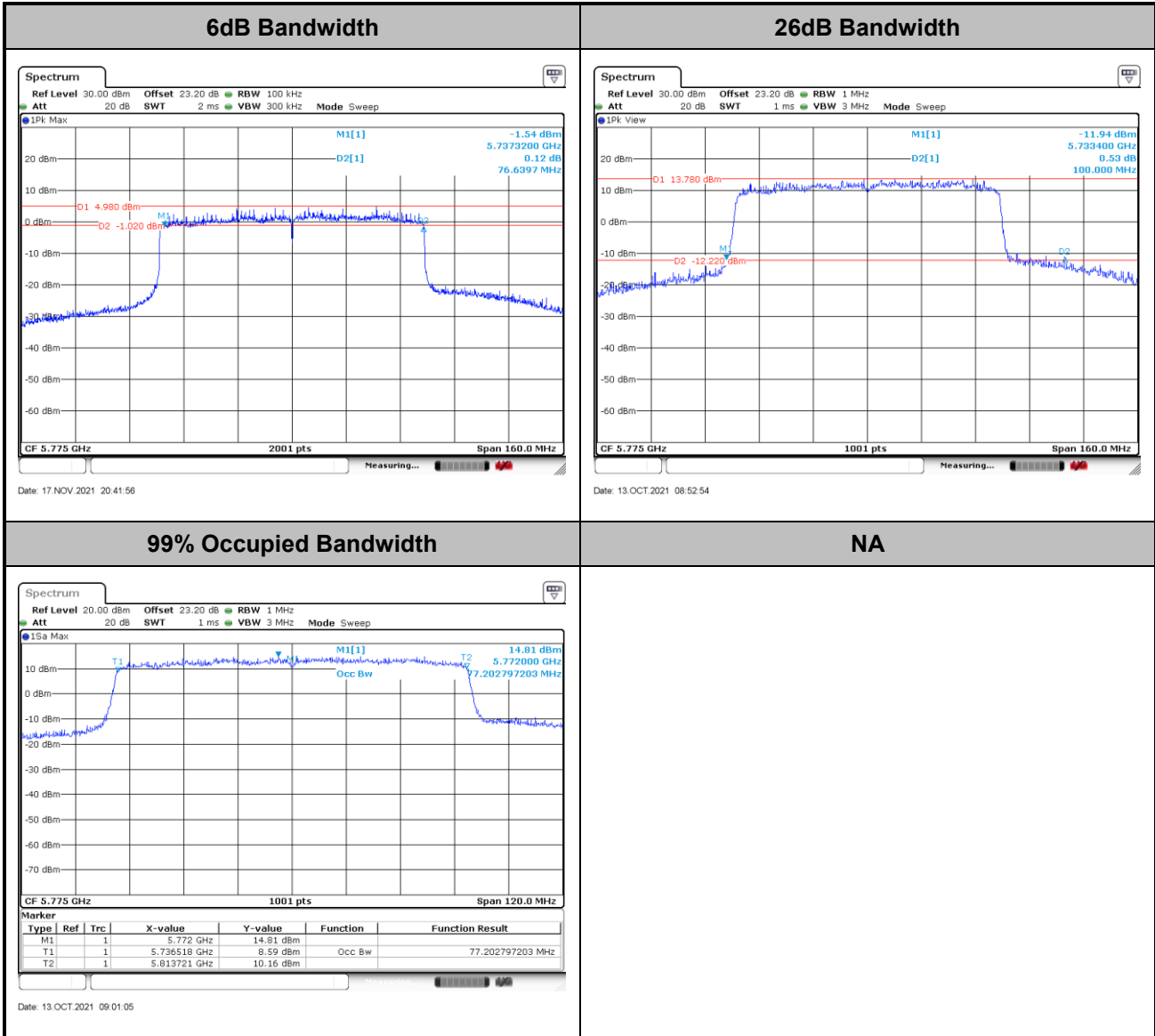

Note: The occupied channel bandwidth is maintained within the band of operation for all of the modulations.



<Radio 3>

<CDD Mode>

<802.11a CH149 Ant. E>

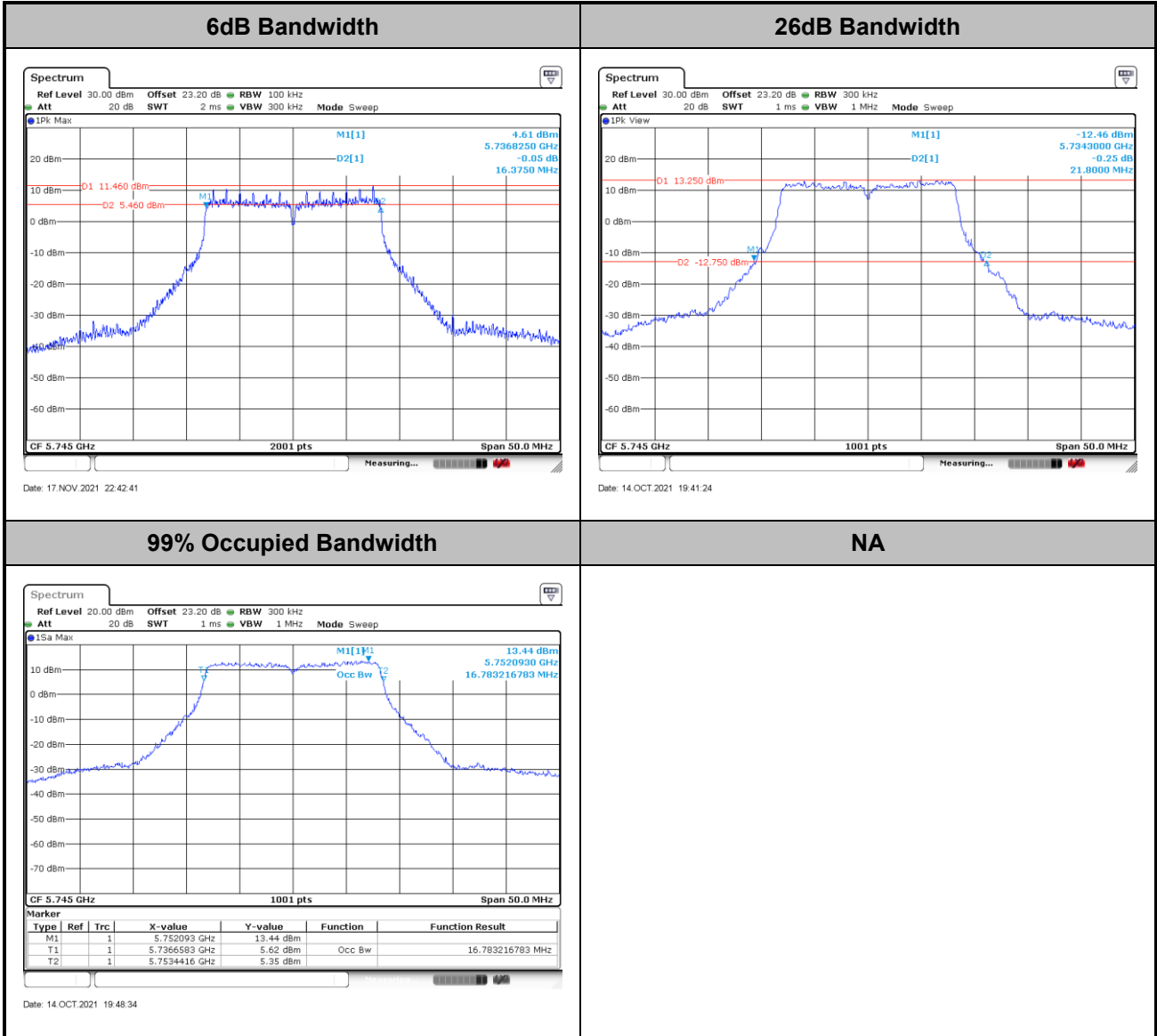

Note: The occupied channel bandwidth is maintained within the band of operation for all of the modulations.



<802.11ax HE20 CH149 Ant. E>

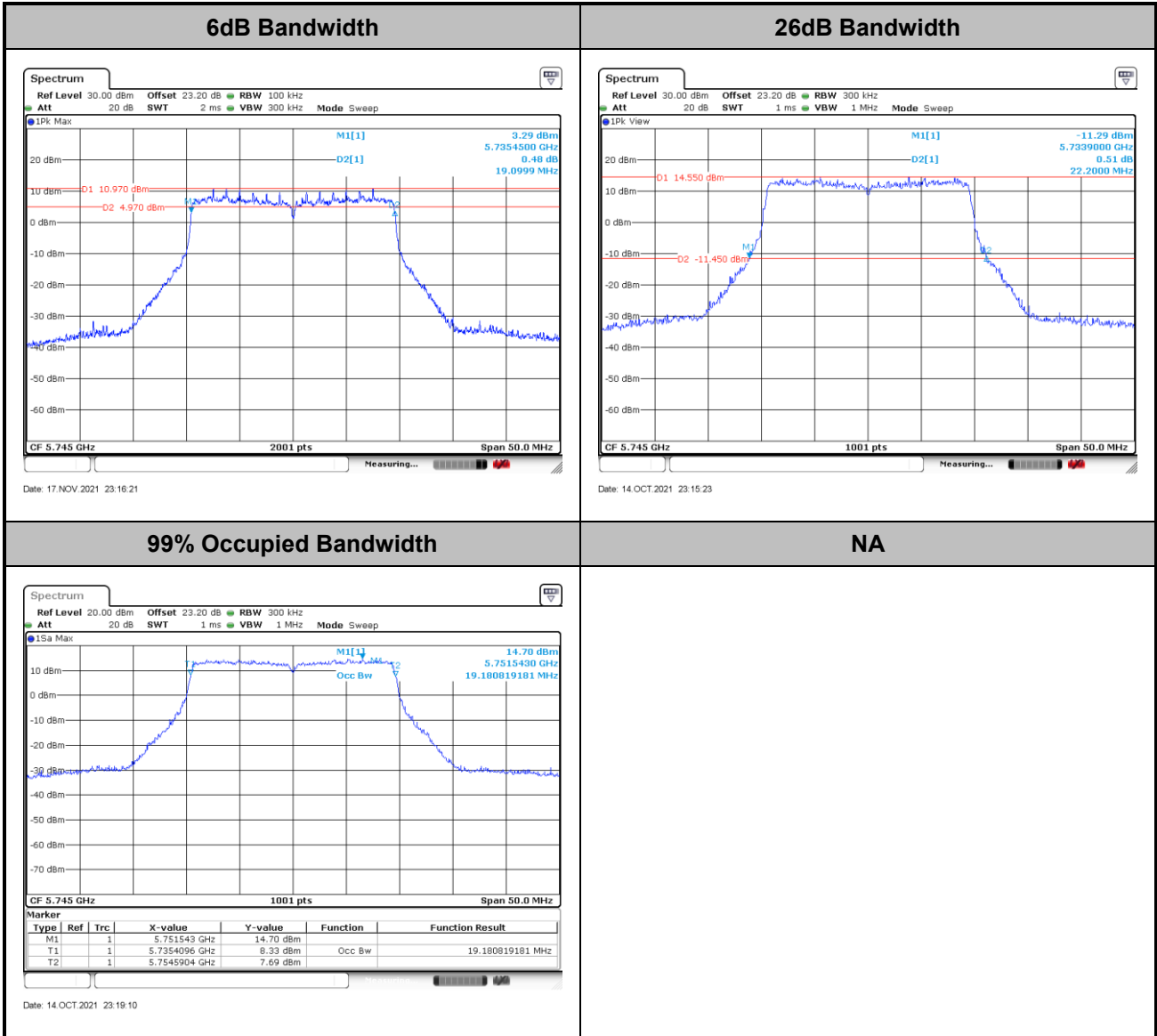

Note: The occupied channel bandwidth is maintained within the band of operation for all of the modulations.



<802.11ax HE40 CH151 Ant. E>

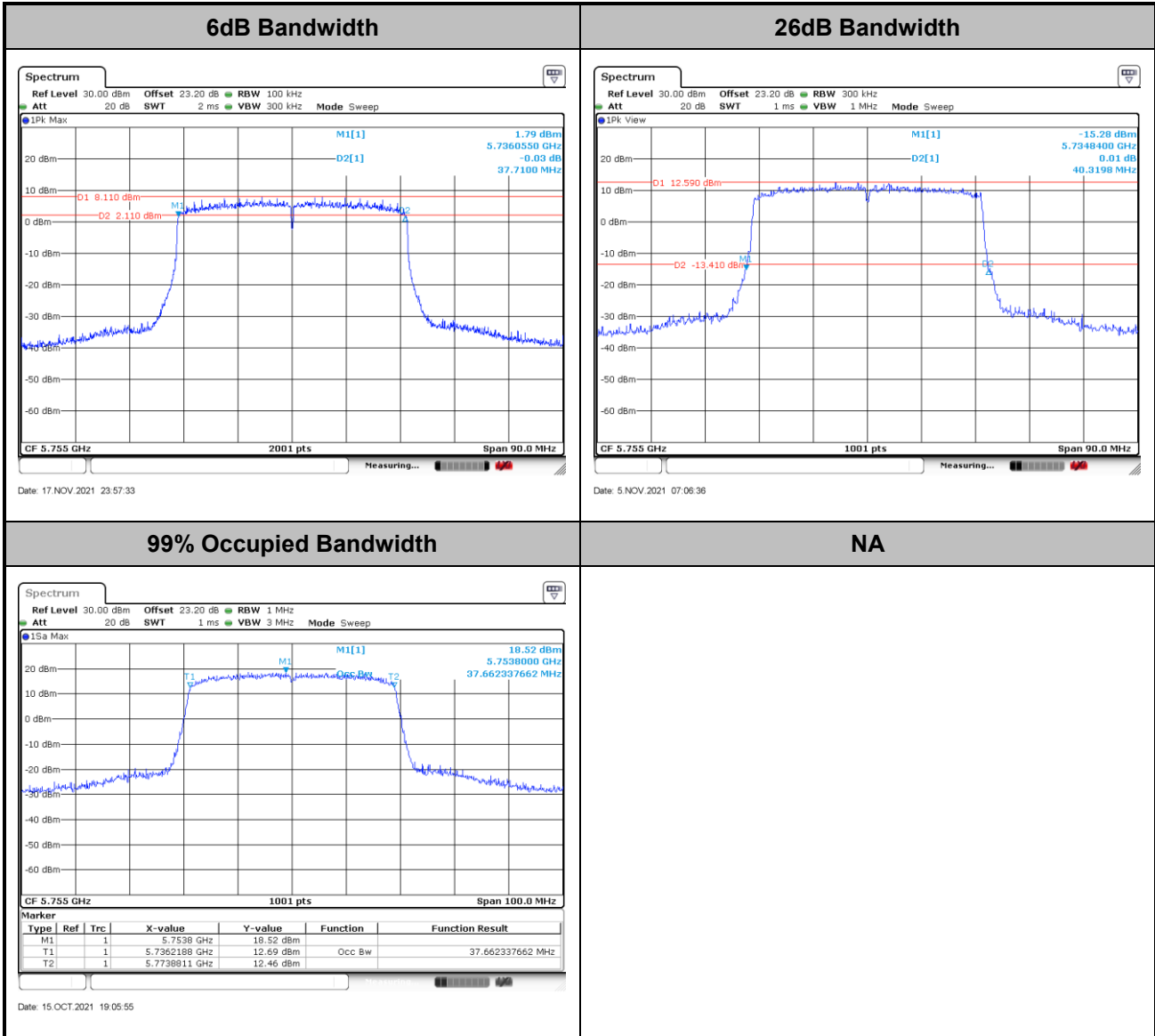

Note: The occupied channel bandwidth is maintained within the band of operation for all of the modulations.



<802.11ax HE80 CH155 Ant. E>

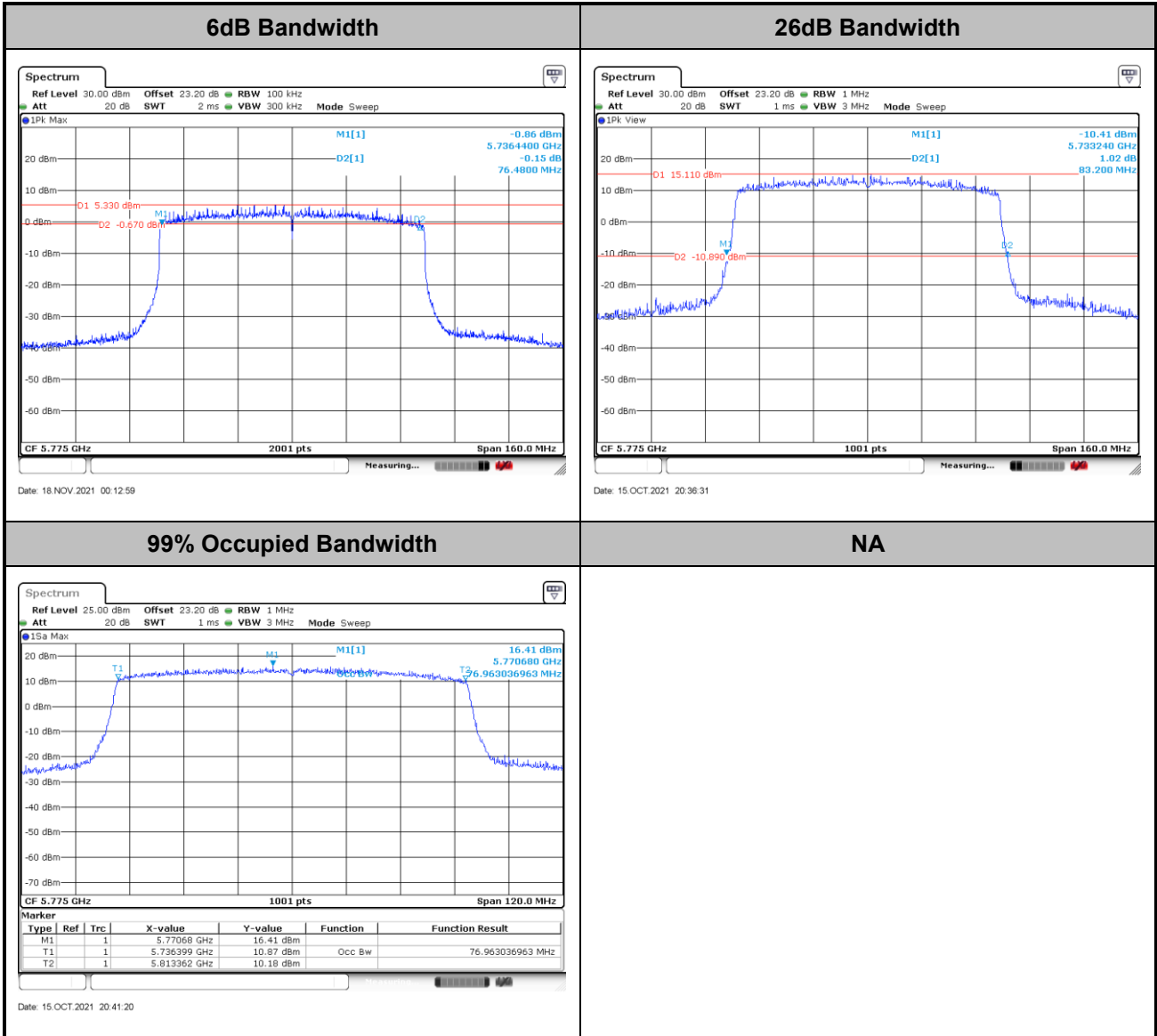

Note: The occupied channel bandwidth is maintained within the band of operation for all of the modulations.



3.2 Maximum Conducted Output Power Measurement

3.2.1 Limit of Maximum Conducted Output Power

For the band 5.725–5.85 GHz, the maximum conducted output power over the frequency band of operation shall not exceed 1 W.

If transmitting antennas of directional gain greater than 6 dBi are used, the peak output power shall be reduced by the amount in dB that the directional gain of the antenna exceeds 6 dBi.

3.2.2 Measuring Instruments

Please refer to the measuring equipment list in this test report.

3.2.3 Test Procedures

<CDD Modes>

The testing follows Method PM-G of FCC KDB 789033 D02 General UNII Test Procedures New Rules v02r01.

Method PM-G (Measurement using a gated RF average power meter):

1. Measurement is performed using a wideband RF power meter.
2. The EUT is configured to transmit at its maximum power control level.
3. Measure the average power of the transmitter.
4. Since the measurement is made only during the ON time of the transmitter, no duty cycle correction factor is required.
5. For MIMO mode, calculation method follows FCC KDB 662911 D01 Multiple Transmitter Output v02r01

<TXBF Modes>

The testing follows Method PM-G of FCC KDB 789033 D02 General UNII Test Procedures New Rules v02r01 for TXBF modes.

Method PM-G (Measurement using a gated RF average power meter):

1. Measurement is performed using a wideband RF power meter.
2. The EUT is configured to transmit at its maximum power control level.
3. Measure the average power of the transmitter
4. Since the measurement is made only during the ON time of the transmitter, no duty cycle correction factor is required.
5. For MIMO mode, calculation method follows FCC KDB 662911 D01 Multiple Transmitter Output v02r01.

3.2.4 Test Setup

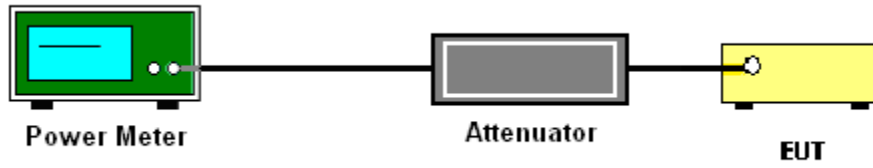

3.2.5 Test Result of Maximum Conducted Output Power

Please refer to Appendix A.



3.3 Power Spectral Density Measurement

3.3.1 Limit of Power Spectral Density

For the band 5.725–5.85 GHz, the maximum power spectral density shall not exceed 30 dBm in any 500-kHz band.

If transmitting antennas of directional gain greater than 6 dBi are used, the output power shall be reduced by the amount in dB that the directional gain of the antenna exceeds 6 dBi.

3.3.2 Measuring Instruments

Please refer to the measuring equipment list in this test report.

3.3.3 Test Procedures

The testing follows FCC KDB 789033 D02 General UNII Test Procedures New Rules v02r01. Section F) Maximum power spectral density.

<CDD Modes>

Method SA-2

(trace averaging across on and off times of the EUT transmissions, followed by duty cycle correction).

- Measure the duty cycle.
 - Set span to encompass the entire emission bandwidth (EBW) of the signal.
 - Set RBW = 300kHz.
 - Set VBW \geq 1 MHz.
 - Add $10 \log(500 \text{ kHz/RBW})$ to the measured result, whereas RBW (<500 kHz) is the reduced resolution bandwidth of the spectrum analyzer set during measurement
 - Number of points in sweep \geq 2 Span / RBW.
 - Sweep time = auto.
 - Detector = RMS
 - Trace average at least 100 traces in power averaging mode.
 - Add $10 \log(1/x)$, where x is the duty cycle, to the measured power in order to compute the average power during the actual transmission times. For example, add $10 \log(1/0.25) = 6 \text{ dB}$ if the duty cycle is 25 percent.
1. The RF output of EUT is connected to the spectrum analyzer by a low loss cable.
 2. Each plot has already offset with cable loss, and attenuator loss. Measure the PPSD and record it.
 3. For MIMO mode, calculation method follows FCC KDB 662911 D01 Multiple Transmitter Output v02r01.

Method (b): Measure and sum spectral maxima across the outputs.

With this technique, spectra are measured at each output of the device at the required resolution bandwidth. The maximum value (peak) of each spectrum is determined. These maximum values are then summed mathematically in linear power units across the outputs.

3.3.4 Test Setup

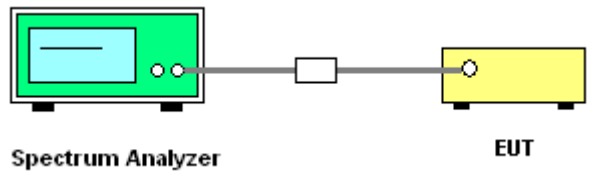

3.3.5 Test Result of Power Spectral Density

Please refer to Appendix A.



<Radio 2>

<CDD Modes>

Worst Case Power Density (dBm/MHz) 802.11a CH165

MIMO Ant. A

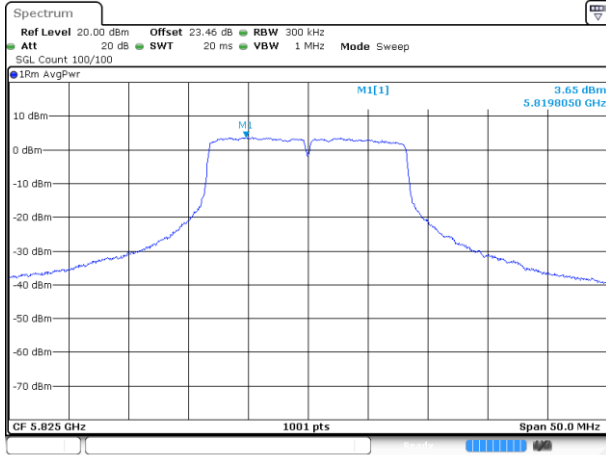

Date: 9 OCT 2021 00:19:01

MIMO Ant. D

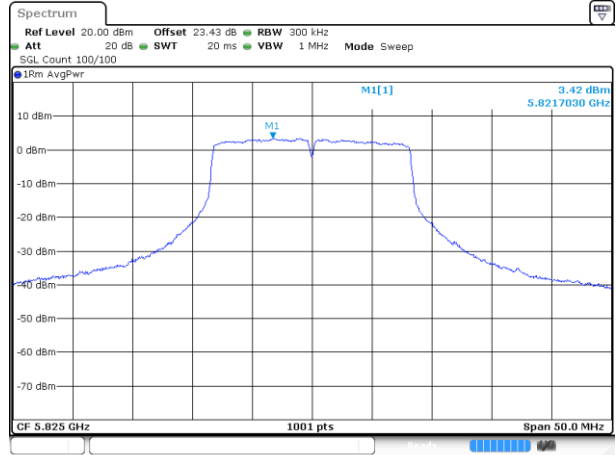

Date: 9 OCT 2021 00:19:35

MIMO Ant. B

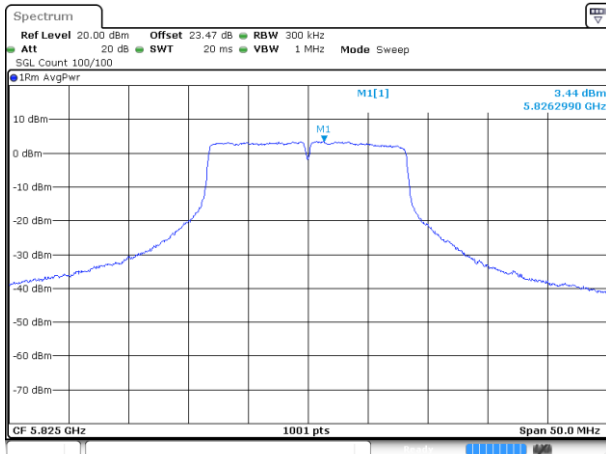

Date: 9 OCT 2021 00:23:18

MIMO Ant. C

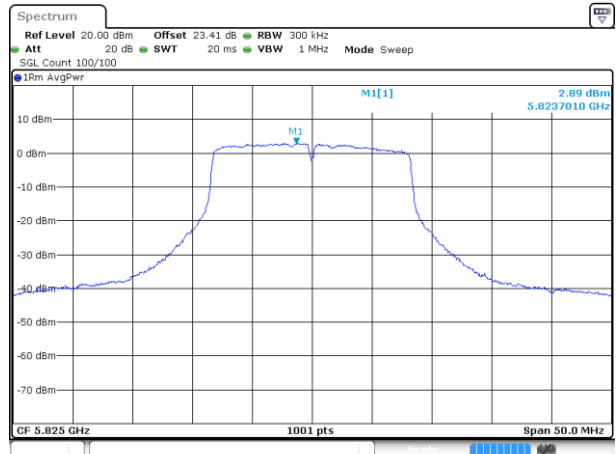

Date: 9 OCT 2021 00:20:54



<802.11ax HE20 Full RU Mode>

Worst Case Power Density (dBm/MHz) 802.11ax HE20 Full RU CH165

MIMO Ant. A

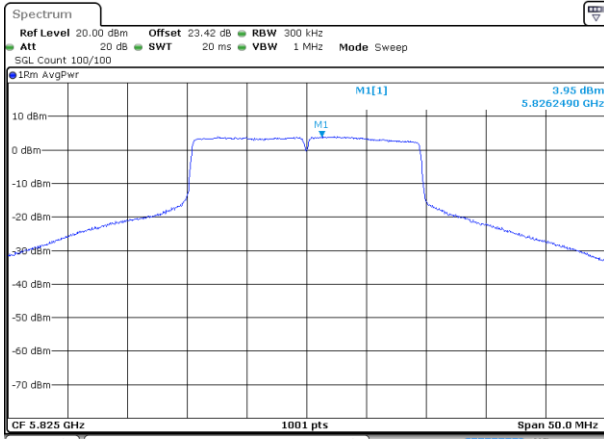

Date: 8 OCT.2021 23:53:48

MIMO Ant. D

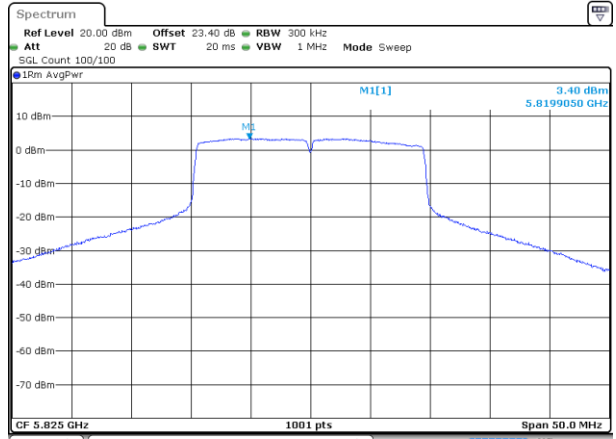

Date: 8 OCT.2021 23:55:06

MIMO Ant. B

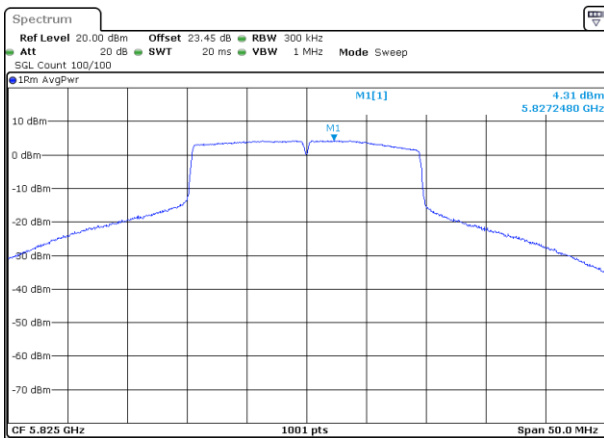

Date: 8 OCT.2021 23:55:45

MIMO Ant. C

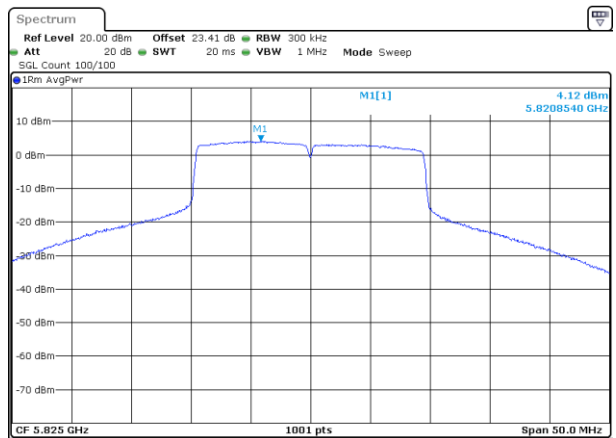

Date: 8 OCT.2021 23:57:25



<802.11ax HE20 partial RU 52*4 Mode>

Worst Case Power Density (dBm/MHz) 802.11ax HE20 partial RU 52*4

MIMO Ant. A

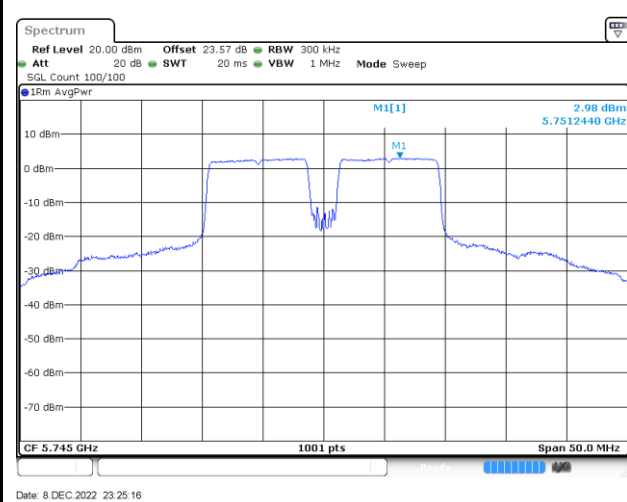

Date: 8 DEC.2022 23:25:16

MIMO Ant. D

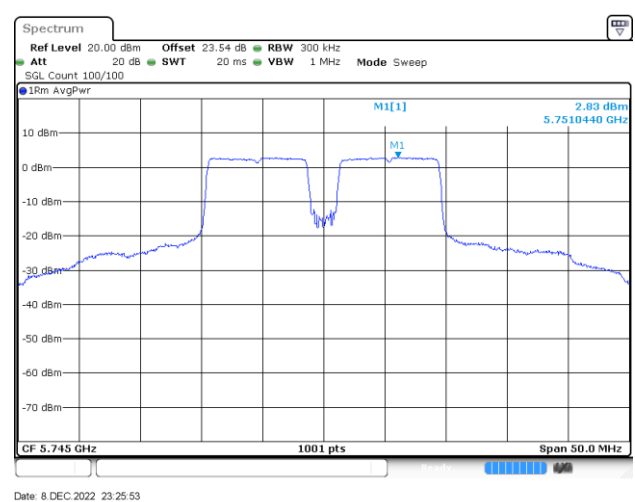

Date: 8 DEC.2022 23:25:53

MIMO Ant. B

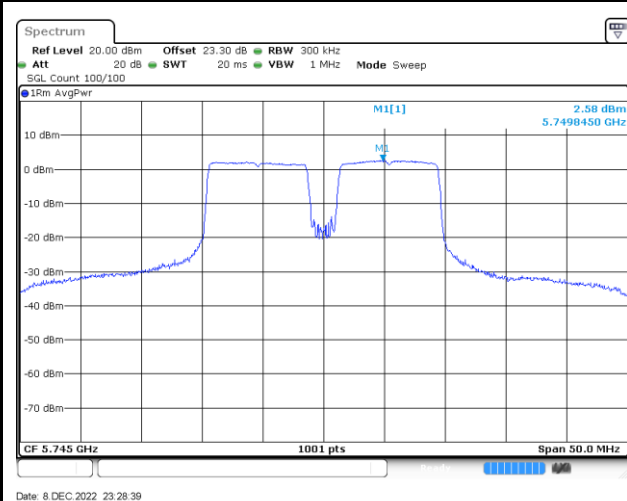

Date: 8 DEC.2022 23:28:39

MIMO Ant. C

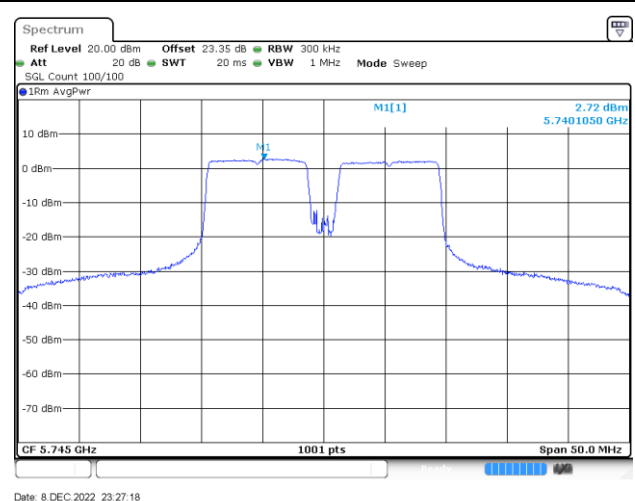

Date: 8 DEC.2022 23:27:18



<802.11ax HE20 partial RU 106*2 Mode>

Worst Case Power Density (dBm/MHz) 802.11ax HE20 partial RU 106*2

MIMO Ant. A

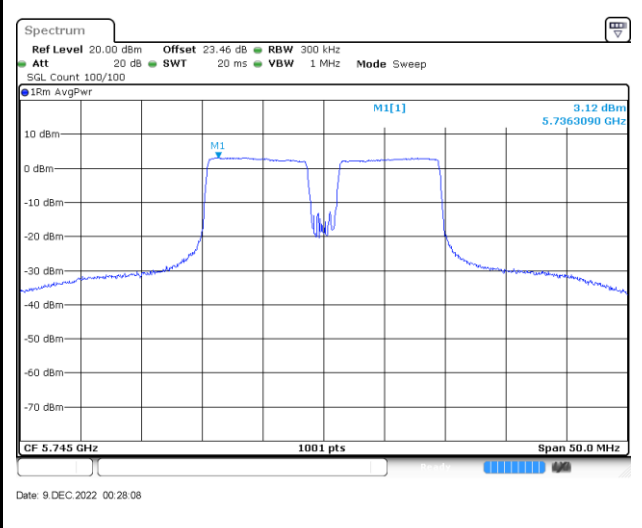

MIMO Ant. D

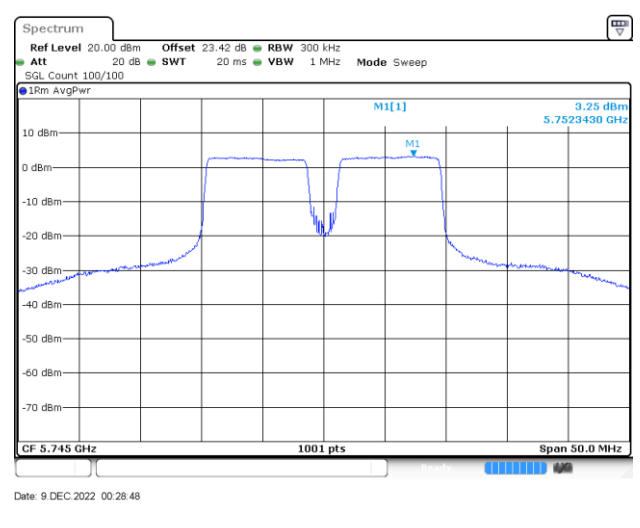

MIMO Ant. B

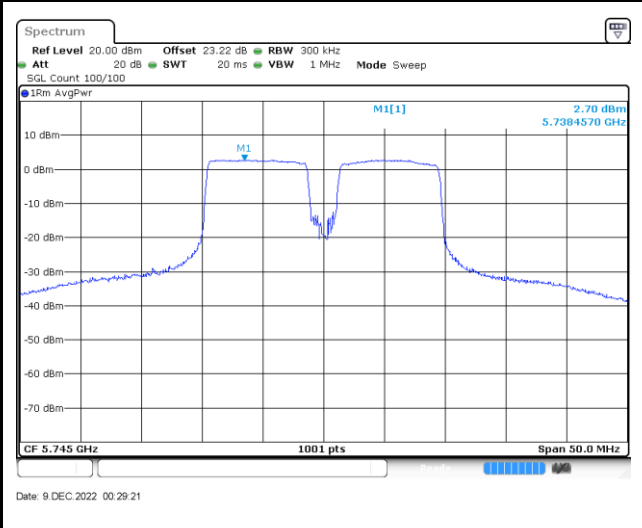

MIMO Ant. C

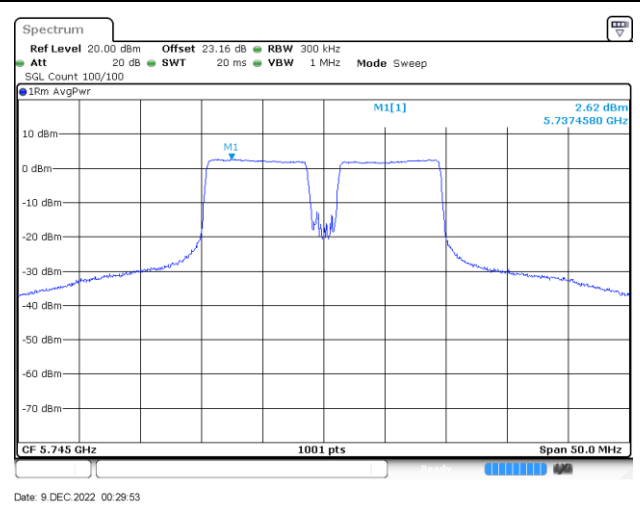



<802.11ax HE40 Mode>

Worst Case Power Density (dBm/MHz) 802.11ax HE40 CH151

MIMO Ant. A

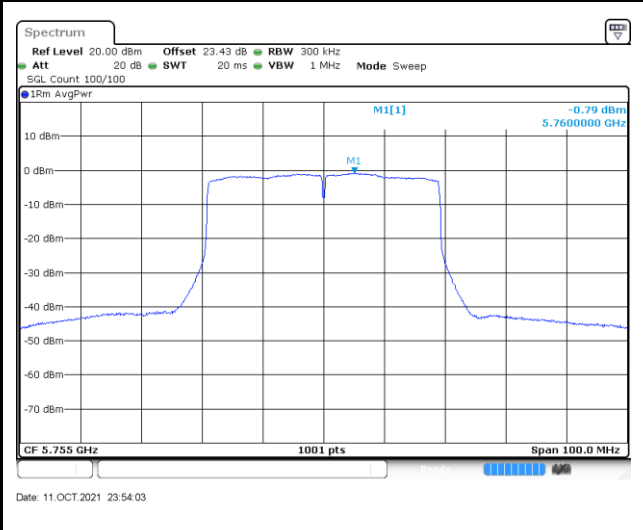

MIMO Ant. D

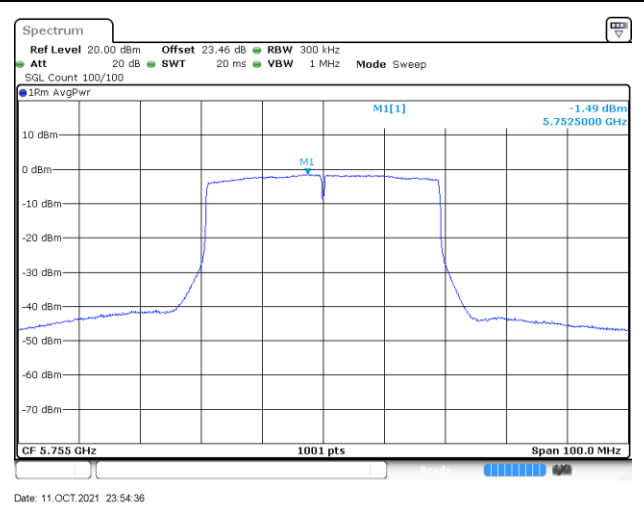

MIMO Ant. B

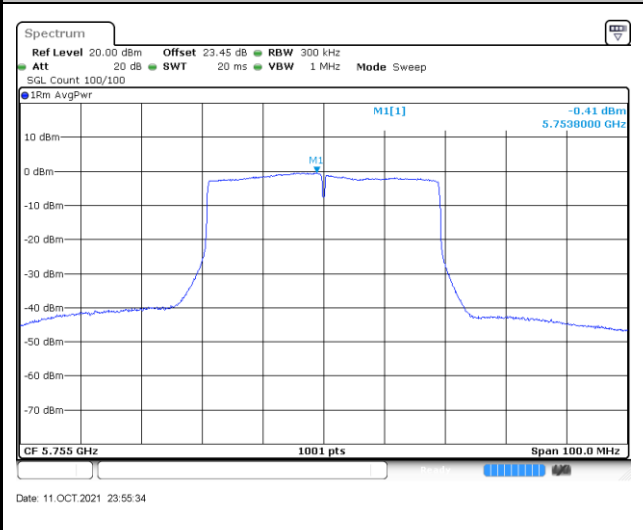

MIMO Ant. C

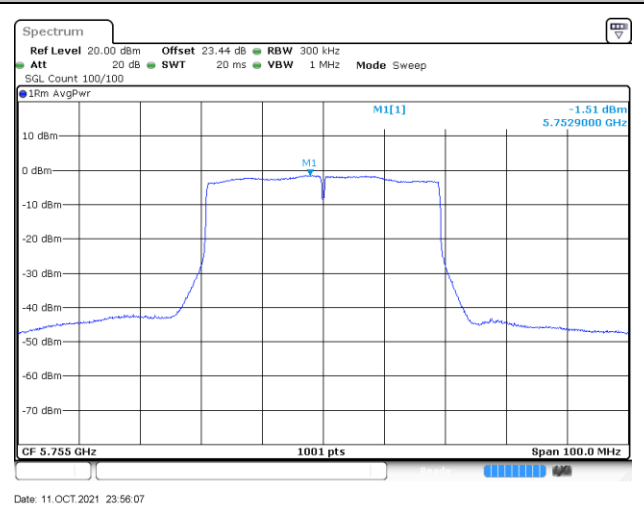



<802.11ax HE80 Mode>

Worst Case Power Density (dBm/MHz) 802.11ax HE80 CH155

MIMO Ant. A

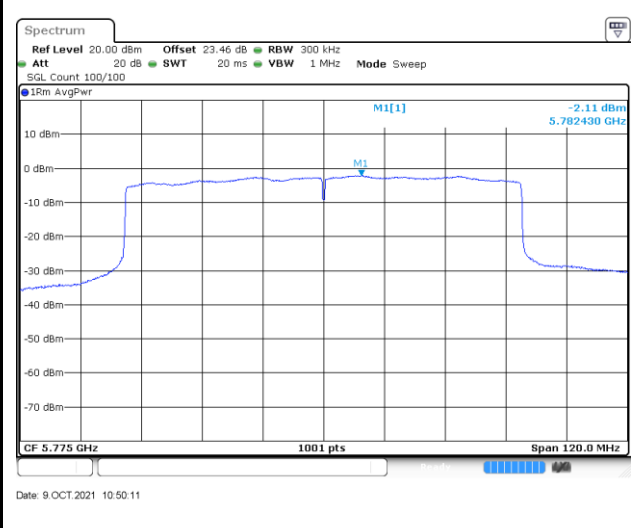

MIMO Ant. D

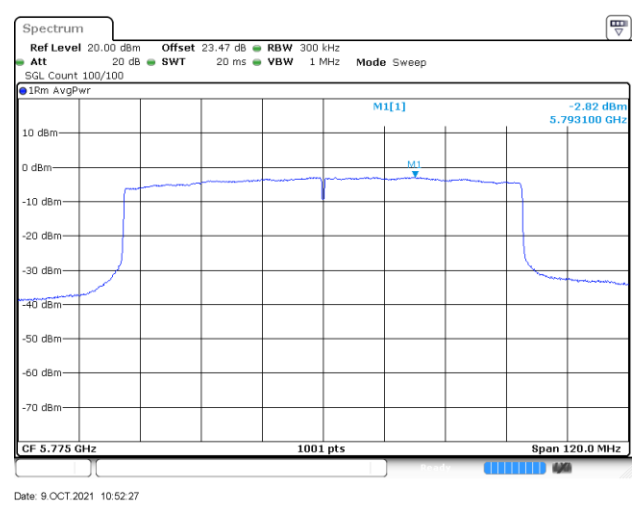

MIMO Ant. B

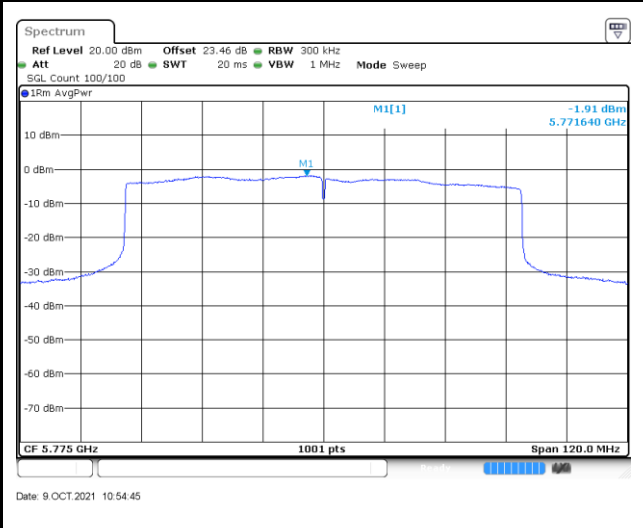

MIMO Ant. C

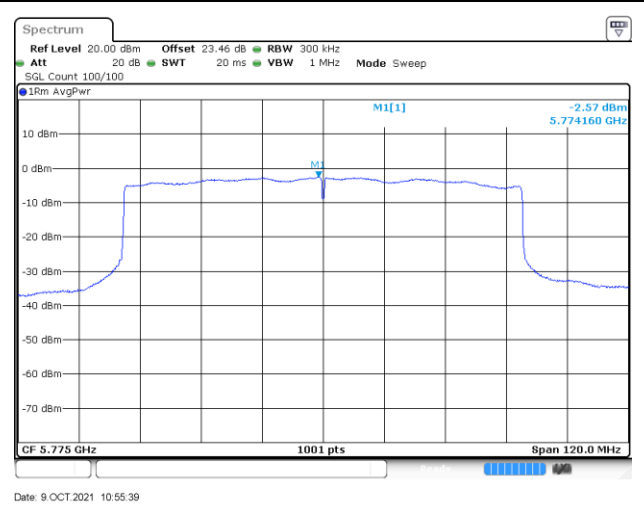



<Radio 3>

<CDD Modes>

Worst Case Power Density (dBm/MHz) 802.11a CH149

MIMO Ant. E

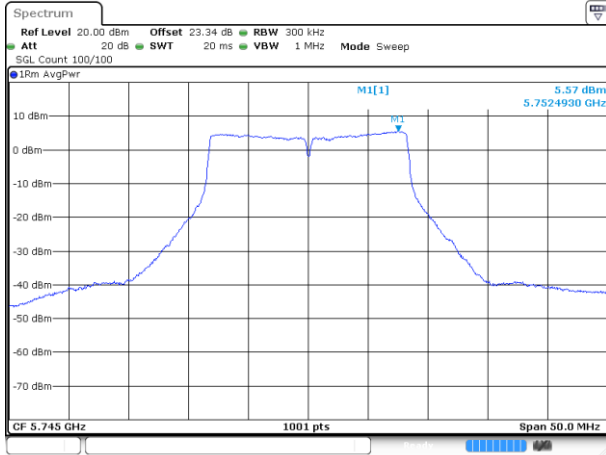

Date: 2.OCT.2021 06:15:47

MIMO Ant. H

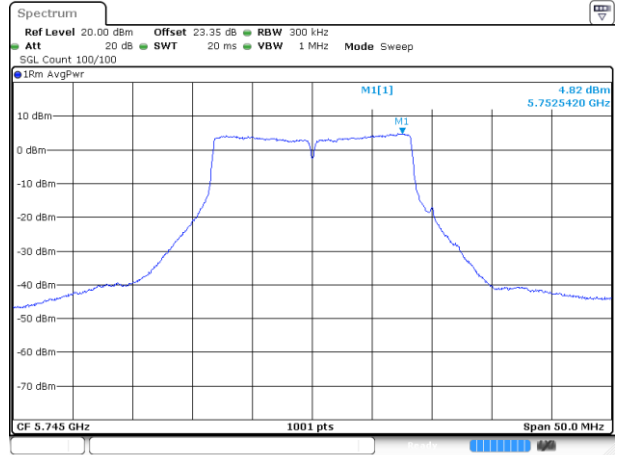

Date: 2.OCT.2021 06:17:05

MIMO Ant. F

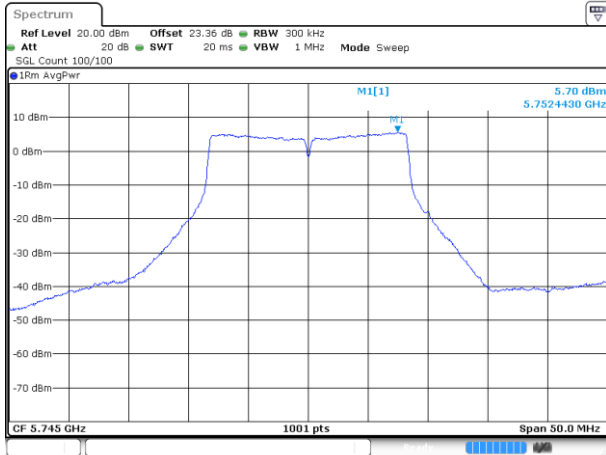

Date: 2.OCT.2021 06:17:33

MIMO Ant. G

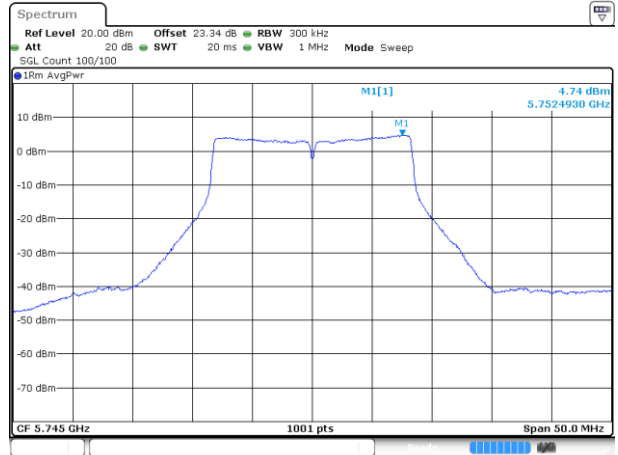

Date: 2.OCT.2021 06:18:10



<802.11ax HE20 Full RU Mode>

Worst Case Power Density (dBm/MHz) 802.11ax Full RU HE20 CH165

MIMO Ant. E

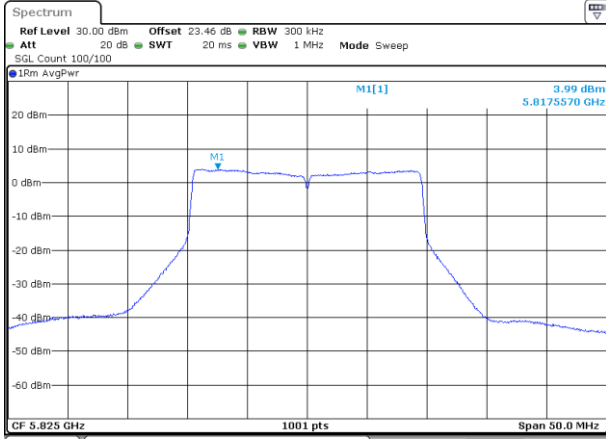

MIMO Ant. H

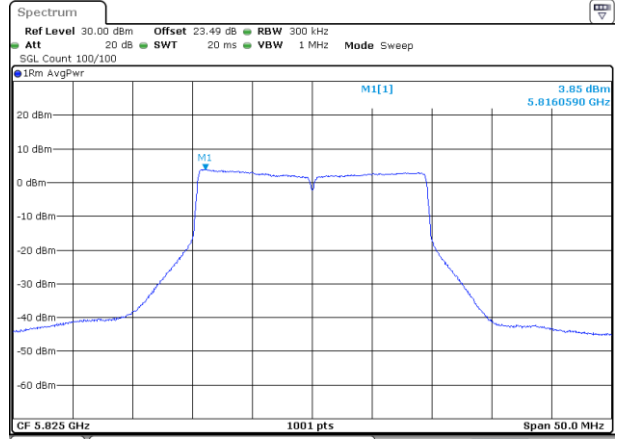

MIMO Ant. F

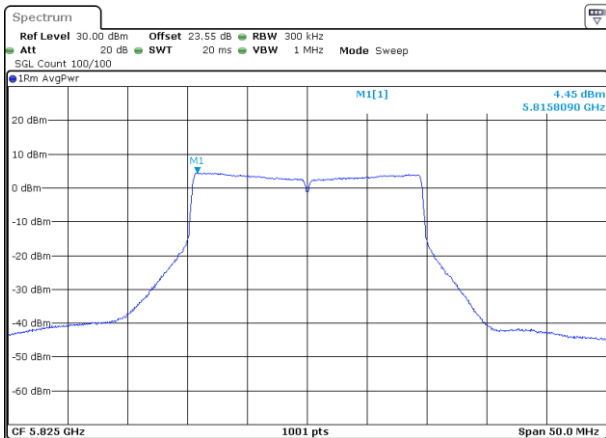

MIMO Ant. G

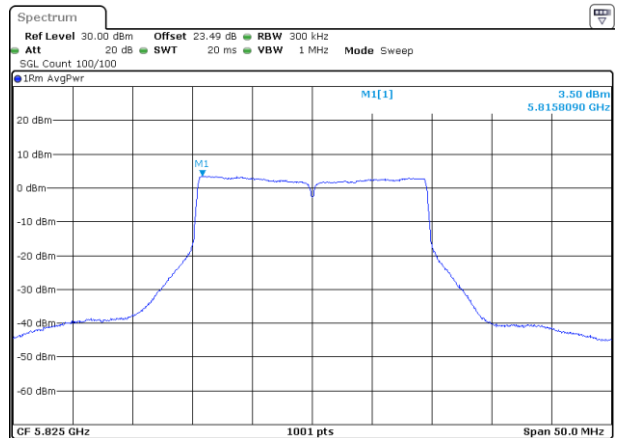



<802.11ax HE20 partial RU 52*4 Mode>

Worst Case Power Density (dBm/MHz) 802.11ax HE20 partial RU 52*4

MIMO Ant. E

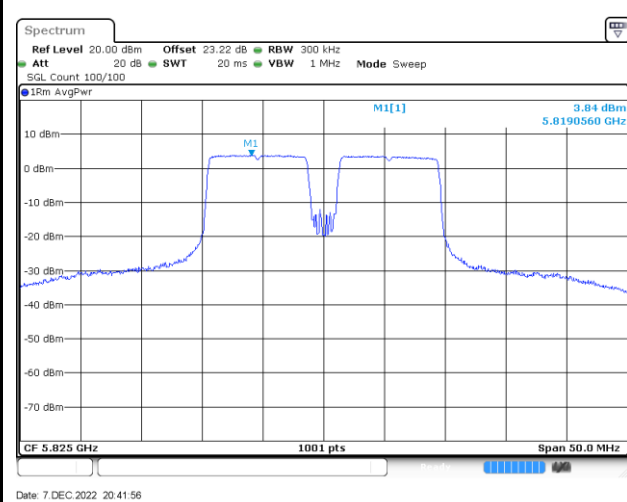

MIMO Ant. H

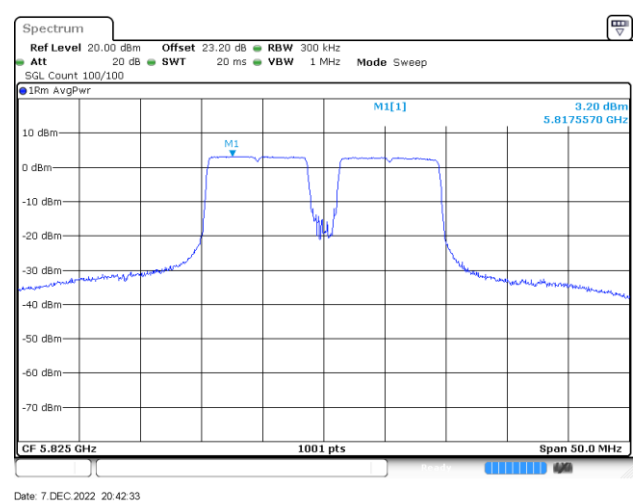

MIMO Ant. F

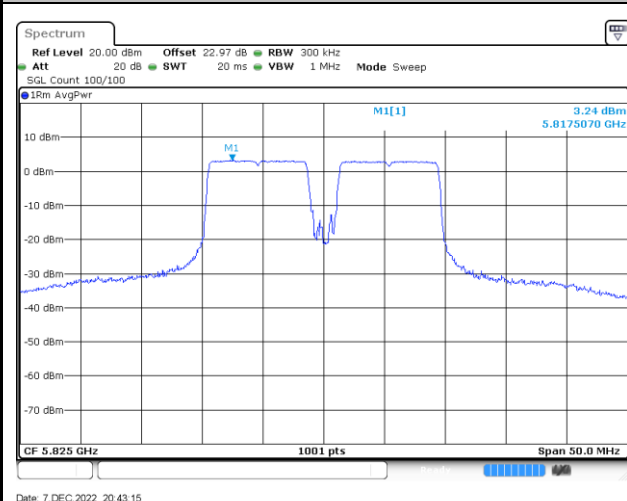

MIMO Ant. G

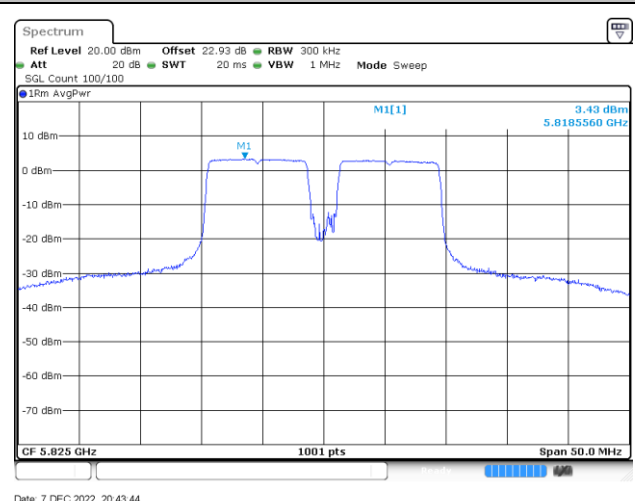



<802.11ax HE20 partial RU 106*2 Mode>

Worst Case Power Density (dBm/MHz) 802.11ax HE20 partial RU 106*2

MIMO Ant. E

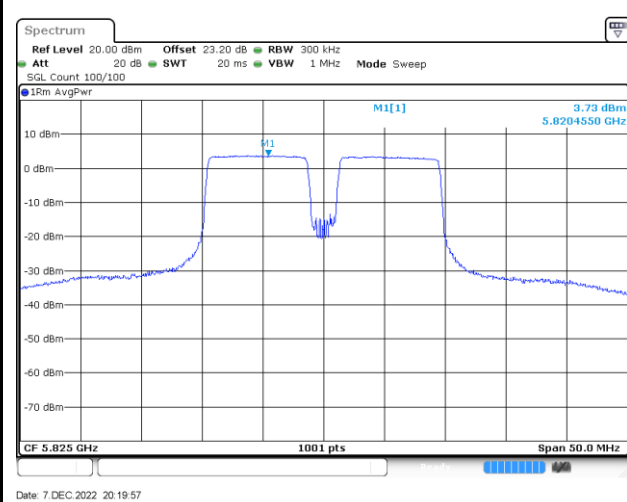

MIMO Ant. H

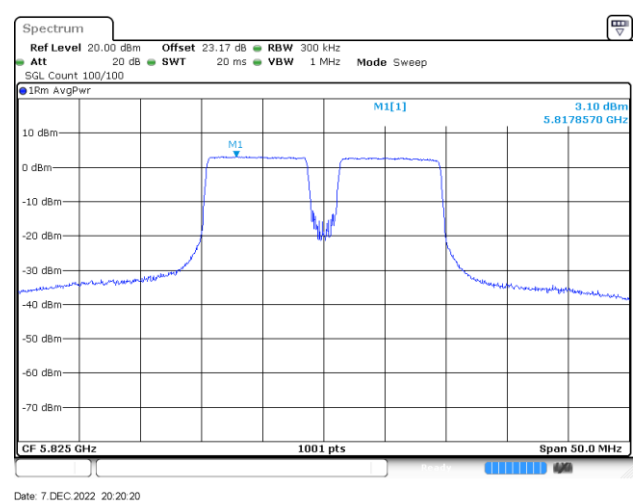

MIMO Ant. F

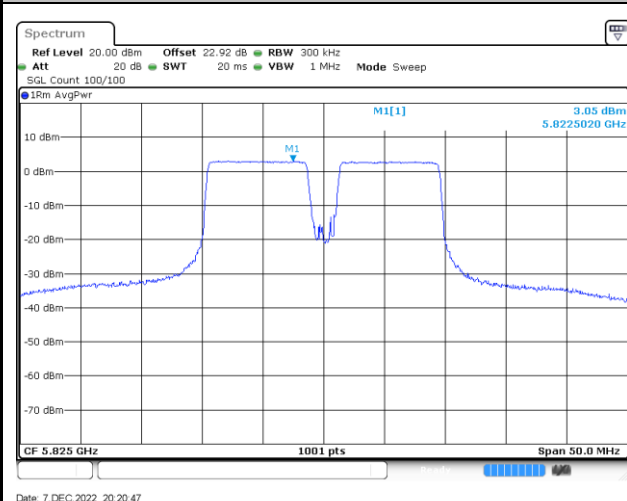

MIMO Ant. G

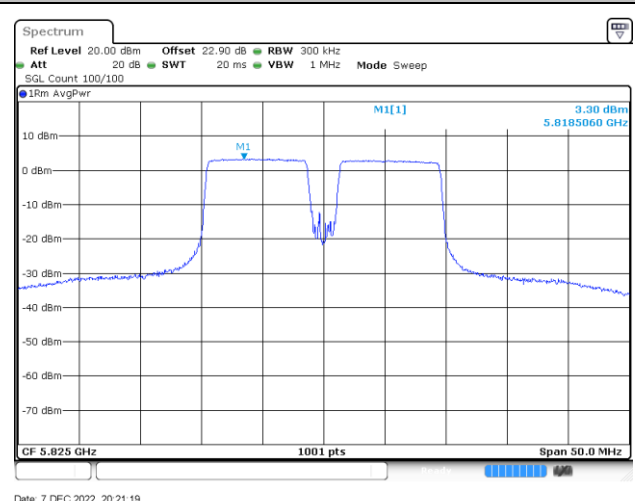



<802.11ax HE40 Mode>

Worst Case Power Density (dBm/MHz) 802.11ax HE40 CH151

MIMO Ant. E

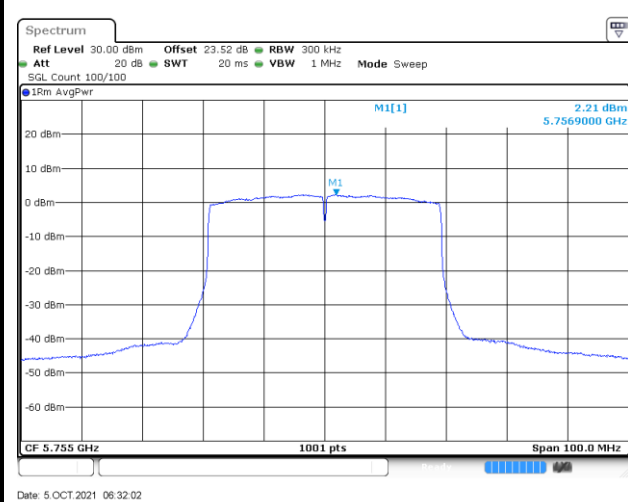

Date: 5.OCT.2021 06:32:02

MIMO Ant. H

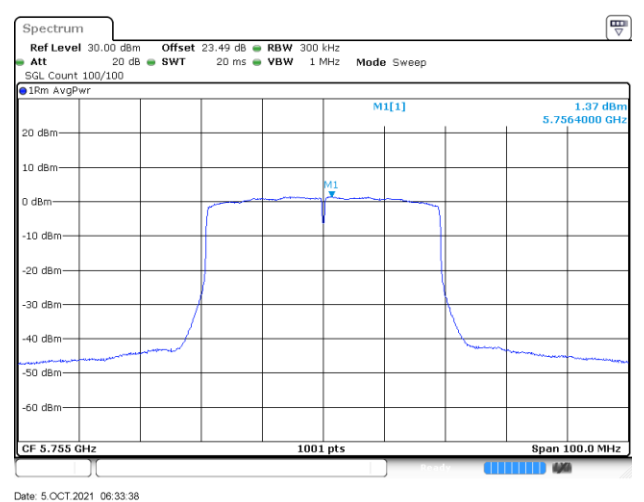

Date: 5.OCT.2021 06:33:38

MIMO Ant. F

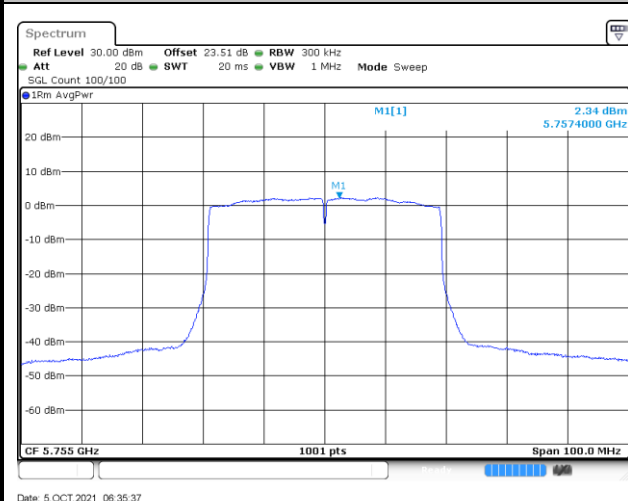

Date: 5.OCT.2021 06:35:37

MIMO Ant. G

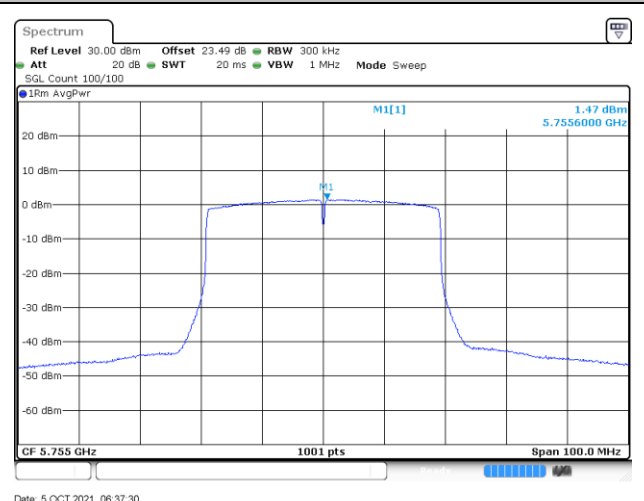

Date: 5.OCT.2021 06:37:30



<802.11ax HE80 Mode>

Worst Case Power Density (dBm/MHz) 802.11ax HE80 CH155

MIMO Ant. E

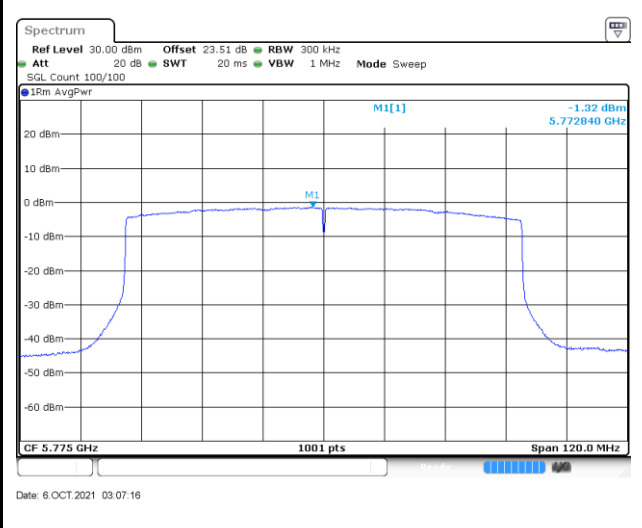

MIMO Ant. H

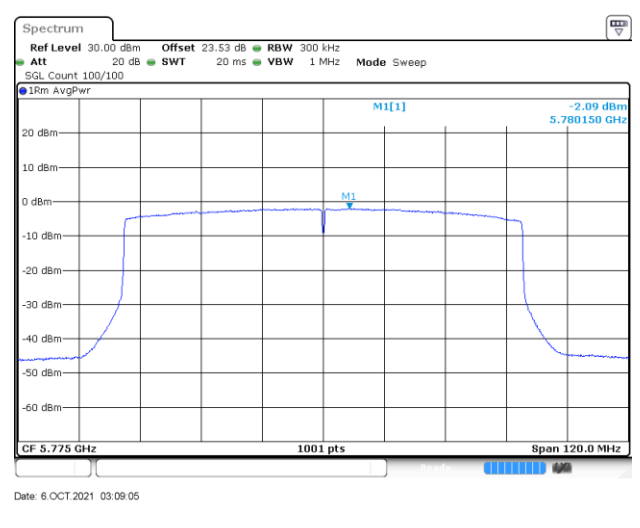

MIMO Ant. F

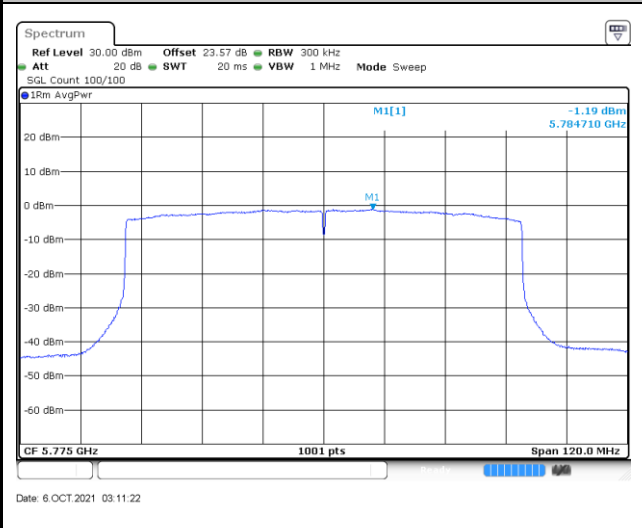

MIMO Ant. G

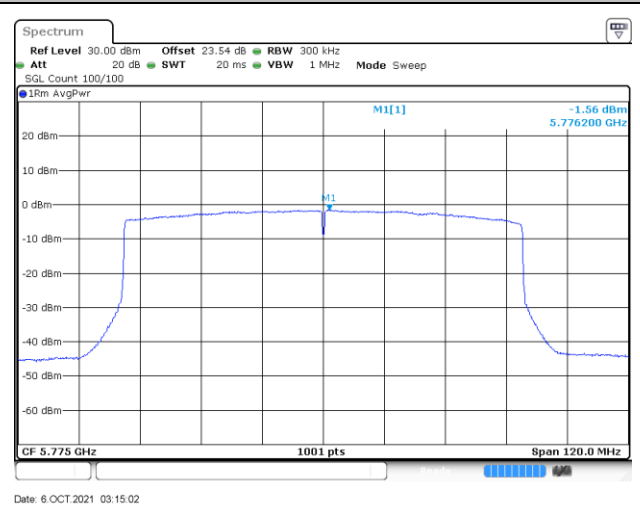



3.4 Unwanted Emissions Measurement

This section is to measure unwanted emissions through radiated measurement for band edge spurious emissions and out of band emissions measurement.

3.4.1 Limit of Unwanted Emissions

- (1) For transmitters operating in the 5.725-5.85 GHz band:
15.407(b)(4)(i) All emissions shall be limited to a level of -27 dBm/MHz at 75 MHz or more above or below the band edge increasing linearly to 10 dBm/MHz at 25 MHz above or below the band edge, and from 25 MHz above or below the band edge increasing linearly to a level of 15.6 dBm/MHz at 5 MHz above or below the band edge, and from 5 MHz above or below the band edge increasing linearly to a level of 27 dBm/MHz at the band edge.
- (2) Unwanted spurious emissions falls in restricted bands shall comply with the general field strength limits as below table,

Frequency (MHz)	Field Strength (microvolts/meter)	Measurement Distance (meters)
0.009 – 0.490	2400/F(kHz)	300
0.490 – 1.705	24000/F(kHz)	30
1.705 – 30.0	30	30
30 – 88	100	3
88 – 216	150	3
216 - 960	200	3
Above 960	500	3

Note: The following formula is used to convert the EIRP to field strength.

$$E = \frac{1000000\sqrt{30P}}{3} \text{ } \mu\text{V/m, where P is the eirp (Watts)}$$

EIRP (dBm)	Field Strength at 3m (dBμV/m)
- 27	68.3

- (3) KDB789033 D02 v02r01 G)2)c)
 - (i) Sections 15.407(b)(1-3) specifies the unwanted emissions limit for the U-NII-1 and U-NII-2 bands. As specified, emissions above 1000 MHz that are outside of the restricted bands are subject to a peak emission limit of -27 dBm/MHz.
 - (ii) Section 15.407(b)(4) specifies the unwanted emissions limit for the U-NII-3 band. A band emissions mask is specified in Section 15.407(b)(4)(i). The emission limits are based on the use of a peak detector.

3.4.2 Measuring Instruments

Please refer to the measuring equipment list in this test report.



3.4.3 Test Procedures

1. The testing follows FCC KDB 789033 D02 General UNII Test Procedures New Rules v02r01. Section G) Unwanted emissions measurement.
 - (1) Procedure for Unwanted Emissions Measurements Below 1000 MHz
 - RBW = 120 kHz
 - VBW = 300 kHz
 - Detector = Peak
 - Trace mode = max hold
 - (2) Procedure for Peak Unwanted Emissions Measurements Above 1000 MHz
 - RBW = 1 MHz
 - VBW \geq 3 MHz
 - Detector = Peak
 - Sweep time = auto
 - Trace mode = max hold
 - (3) Procedures for Average Unwanted Emissions Measurements Above 1000 MHz
 - RBW = 1 MHz
 - VBW = 10 Hz, when duty cycle is no less than 98 percent.
 - VBW \geq 1/T, when duty cycle is less than 98 percent where T is the minimum transmission duration over which the transmitter is on and is transmitting at its maximum power control level for the tested mode of operation.
2. The EUT is placed on a turntable with 0.8 meter for frequency below 1 GHz and 1.5 meter for frequency above 1 GHz respectively above ground.
3. The EUT is set 3 meters away from the receiving antenna which is mounted on the top of a variable height antenna tower.
4. The antenna is a broadband antenna and its height is adjusted between one meter and four meters above ground to find the maximum value of the field strength for both horizontal polarization and vertical polarization of the antenna.
5. For each suspected emission, the EUT is arranged to its worst case and then adjust the antenna tower (from 1 m to 4 m) and turntable (from 0 degree to 360 degrees) to find the maximum reading.
6. Radiated testing below 1 GHz is performed by adjusting the antenna tower from 1 m to 4 m and by rotating the turn table from 0 degree to 360 degrees to find the peak maximum hold reading. When there is no suspected emission found and the emission level is with at least 6 dB margin against QP limit line, the position is marked as “-“.
7. Radiated testing above 1 GHz is performed by adjusting the antenna tower from 1 m to 4 m and by rotating the turn table from 0 degree to 360 degrees to find the peak maximum hold reading for scanning all frequencies.
When there is no suspected emission found and the harmonic emission level is with at least 6 dB margin against average limit line, the position is marked as “-“.

3.4.4 Test Setup

For radiated emissions below 30MHz

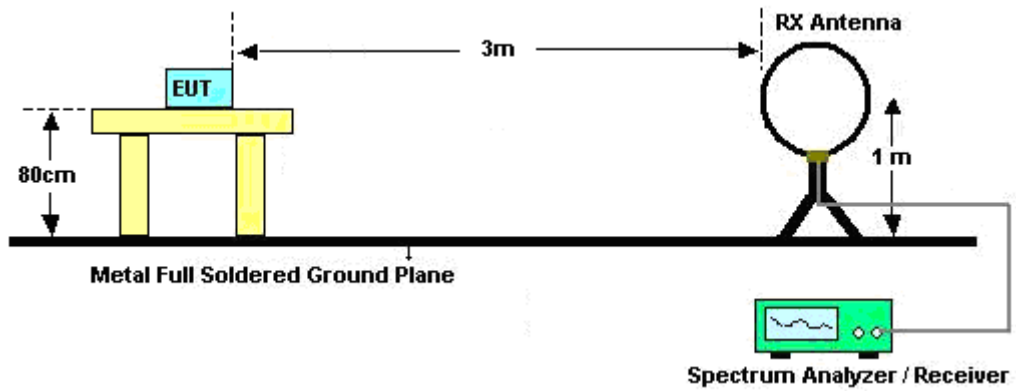

For radiated emissions from 30MHz to 1GHz

<CDD Mode>

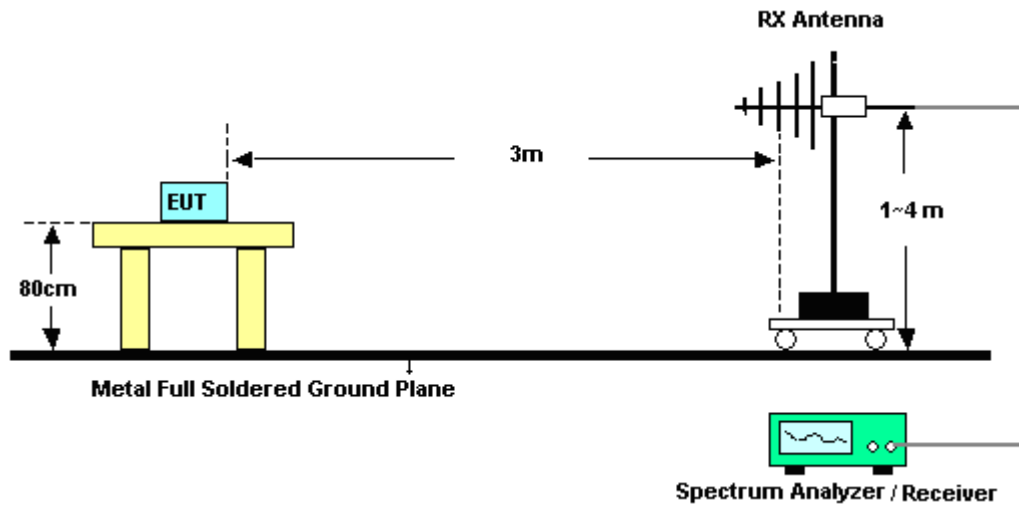

<TXBF Modes>

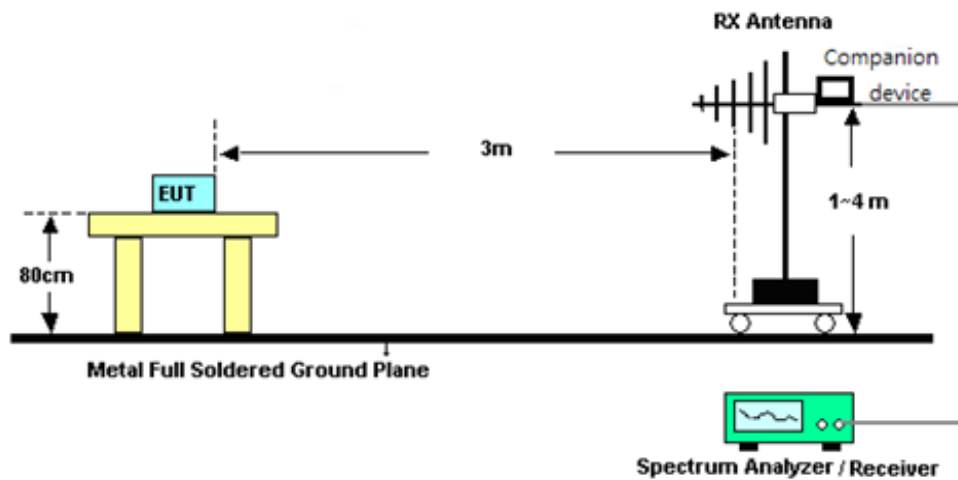

For radiated test from 1GHz to 18GHz

<CDD Mode>

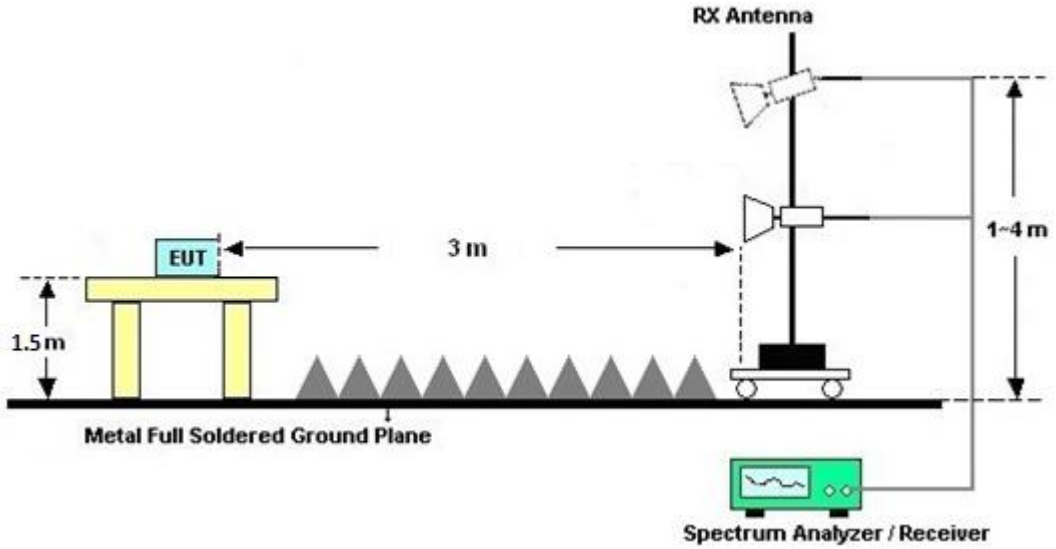

<TXBF Modes>

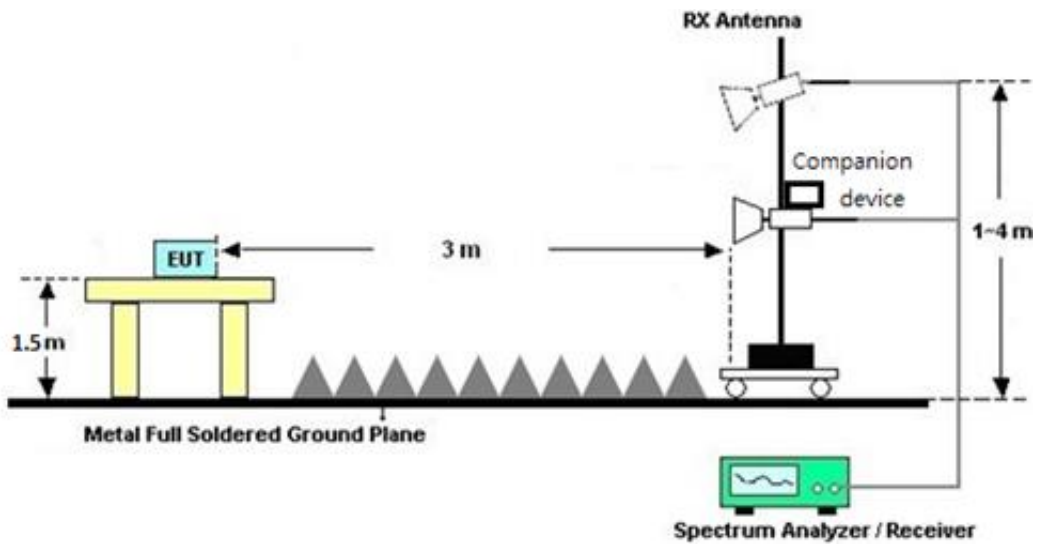

For radiated test above 18GHz

<CDD Mode>

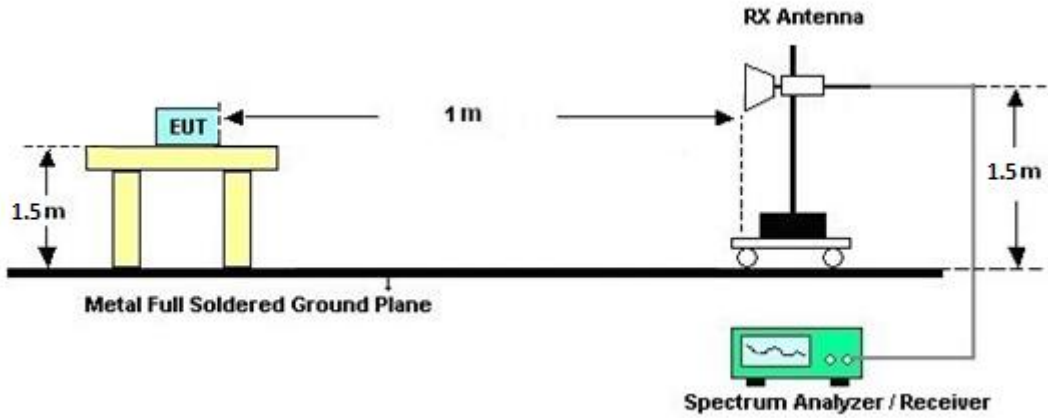

<TXBF Modes>

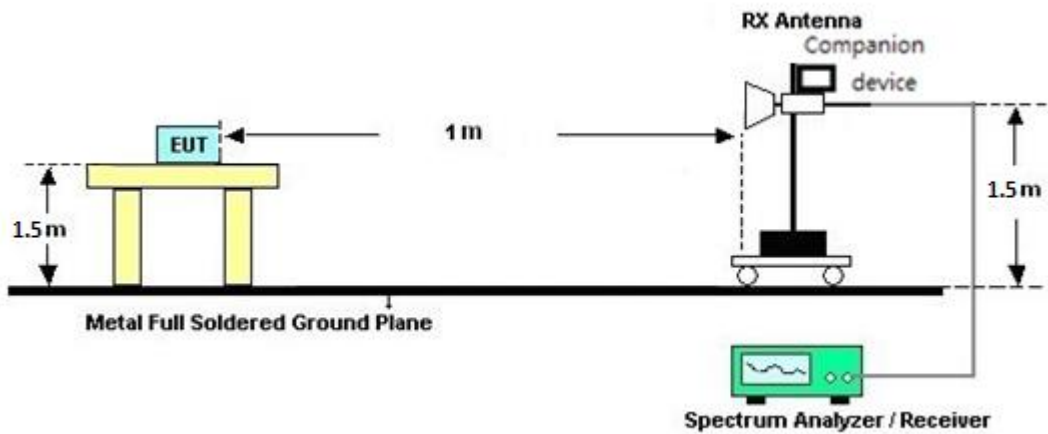



3.4.5 Test Results of Radiated Emissions (9 kHz ~ 30 MHz)

The low frequency, which starts from 9 kHz to 30 MHz, is pre-scanned and the result which is 20 dB lower than the limit line is not reported.

There is adequate comparison measurement of both open-field test site and alternative test site - semi-Anechoic chamber according to 414788 D01 Radiated Test Site v01r01, and the result came out very similar.

3.4.6 Test Result of Radiated Band Edges

Please refer to Appendix C and D.

3.4.7 Duty Cycle

Please refer to Appendix E.

3.4.8 Test Result of Unwanted Radiated Emission (30MHz ~ 10th Harmonic)

Please refer to Appendix C and D.



3.5 AC Conducted Emission Measurement

3.5.1 Limit of AC Conducted Emission

For equipment that is designed to be connected to the public utility (AC) power line, the radio frequency voltage that is conducted back onto the AC power line on any frequency or frequencies within the band 150 kHz to 30 MHz shall not exceed the limits in the following table.

Frequency of emission (MHz)	Conducted limit (dB μ V)	
	Quasi-peak	Average
0.15-0.5	66 to 56*	56 to 46*
0.5-5	56	46
5-30	60	50

*Decreases with the logarithm of the frequency.

3.5.2 Measuring Instruments

Please refer to the measuring equipment list in this test report.

3.5.3 Test Procedures

1. The EUT is placed 0.4 meter away from the conducting wall of the shielding room, and is kept at least 80 centimeters from any other grounded conducting surface.
2. Connect EUT to the power mains through a line impedance stabilization network (LISN).
3. All the support units are connecting to the other LISN.
4. The LISN provides 50 ohm coupling impedance for the measuring instrument.
5. The FCC states that a 50 ohm, 50 microhenry LISN shall be used.
6. Both Line and Neutral shall be tested in order to find out the maximum conducted emission.
7. The frequency range from 150 kHz to 30 MHz is scanned.
8. Set the test-receiver system to Peak Detect Function and specified bandwidth with Maximum Hold Mode.

3.5.4 Test Setup



3.5.5 Test Result of AC Conducted Emission

Please refer to Appendix B.



3.6 Antenna Requirements

3.6.1 Standard Applicable

If transmitting antenna directional gain is greater than 6 dBi, both the transmit power and the power spectral density shall be reduced by the amount in dB that the directional gain of the antenna exceeds 6 dBi.

3.6.2 Antenna Anti-Replacement Construction

An embedded-in antenna design is used.

3.6.3 Antenna Gain

The device is the special case of a MIMO system with four outputs driving a cross-polarized pair of linearly polarized antennas (noted as “vertical” and “horizontal”).

Refer to KDB 662911 D01 v02r01 F)2)c) for a system in which the antennas have fixed orientations relative to one another that ensure that the antennas are cross-polarized regardless of any user actions, the directional gain is computed as follows.

The total gain—including array gain—is computed separately for each of the two polarizations using the procedures presented in KDB 662911 D01 v02r01. The highest of the total gains shall apply.

CDD mode

For power measurements on IEEE 802.11 devices,

Directional gain = $G_{ANT} + \text{Array Gain}$, where Array Gain is as follows:

Array Gain = 0 dB (i.e., no array gain) for $N_{ANT} \leq 4$.

G_{ANT} is set equal to the gain of the antenna having the highest gain.

For PSD measurements, the directional gain calculation follows F)2)f)i) of KDB 662911 D01

Directional gain = $G_{ANT\ MAX} + 10 \log(N_{ANT}/N_{SS})$ dBi, where N_{SS} = the number of independent spatial streams of data and $G_{ANT\ MAX}$ is the gain of the antenna having the highest gain (in dBi).

The directional gain of EUT is listed in the following table.

<For Radio 2>

5GHz CDD mode	Ant A Vertical polarization (dBi)	Ant D Vertical polarization (dBi)	DG for Power (dBi)	DG for PSD (dBi)	Power Limit Reduction (dB)	PSD Limit Reduction (dB)
UNII-3	2.90	2.90	2.90	5.91	0	0
5GHz CDD mode	Ant B Horizontal polarization (dBi)	Ant C Horizontal polarization (dBi)	DG for Power (dBi)	DG for PSD (dBi)	Power Limit Reduction (dB)	PSD Limit Reduction (dB)
UNII-3	2.90	2.90	2.90	5.91	0	0

<For Radio 3>

5GHz CDD mode	Ant E Vertical polarization (dBi)	Ant H Vertical polarization (dBi)	DG for Power (dBi)	DG for PSD (dBi)	Power Limit Reduction (dB)	PSD Limit Reduction (dB)
UNII-3	2.90	2.90	2.90	5.91	0	0
5GHz CDD mode	Ant F Horizontal polarization (dBi)	Ant G Horizontal polarization (dBi)	DG for Power (dBi)	DG for PSD (dBi)	Power Limit Reduction (dB)	PSD Limit Reduction (dB)
UNII-3	2.90	2.90	2.90	5.91	0	0

Calculation:

Directional gain of power measurement:

$$= \max. \text{ antenna gain } (2.9\text{dBi}, 2.9\text{dBi}) + 0 = 2.9 \text{ dBi}$$

Directional gain of PSD measurement (Horizontal polarization):

$$= \max. \text{ antenna gain } (2.9\text{dBi}, 2.9\text{dBi}) + 10 \cdot \log(2/1) = 5.91\text{dBi}$$

Directional gain of PSD measurement (Vertical polarization):

$$= \max. \text{ antenna gain } (2.9\text{dBi}, 2.9\text{dBi}) + 10 \cdot \log(2/1) = 5.91\text{dBi}$$

Directional gain of PSD measurement:

$$= \max \text{ directional gain of Horizontal and Vertical}$$

$$= \max. \text{ directional gain } (5.91\text{dBi}, 5.91\text{dBi}) = 5.91 \text{ dBi}$$



TXBF modes

FCC KDB 662911 D01 Multiple Transmitter Output v02r01

For power and PSD measurement, the directional gain calculation follows F)2)e)ii) of KDB 662911 D01 Directional gain = $G_{ANT\ MAX} + 10 \log(N_{ANT}/N_{SS})$ dBi, where N_{SS} = the number of independent spatial streams of data and $G_{ANT\ MAX}$ is the gain of the antenna having the highest gain (in dBi).

The directional gain of EUT is listed in the following table.

<For Radio 2>

5GHz TXBF mode	Ant A Vertical polarization (dBi)	Ant D Vertical polarization (dBi)	DG for Power (dBi)	DG for PSD (dBi)	Power Limit Reduction (dB)	PSD Limit Reduction (dB)
UNII-3	2.90	2.90	5.91	5.91	0	0
5GHz TXBF mode	Ant B Horizontal polarization (dBi)	Ant C Horizontal polarization (dBi)	DG for Power (dBi)	DG for PSD (dBi)	Power Limit Reduction (dB)	PSD Limit Reduction (dB)
UNII-3	2.90	2.90	5.91	5.91	0	0



<For Radio 3>

5GHz TXBF mode	Ant E Vertical polarization (dBi)	Ant H Vertical polarization (dBi)	DG for Power (dBi)	DG for PSD (dBi)	Power Limit Reduction (dB)	PSD Limit Reduction (dB)
UNII-3	2.90	2.90	5.91	5.91	0	0
5GHz TXBF mode	Ant F Horizontal polarization (dBi)	Ant G Horizontal polarization (dBi)	DG for Power (dBi)	DG for PSD (dBi)	Power Limit Reduction (dB)	PSD Limit Reduction (dB)
UNII-3	2.90	2.90	5.91	5.91	0	0

Calculation:

Directional gain of power and PSD measurement (Horizontal polarization):

= max. antenna gain (2.9dBi, 2.9dBi)+10*log(2/1) = 5.91dBi

Directional gain of power and PSD measurement (Vertical polarization):

= max. antenna gain (2.9dBi, 2.9dBi)+10*log(2/1) = 5.91dBi

Directional gain of PSD measurement:

= max directional gain of Horizontal and Vertical

= max. directional gain (5.91dBi, 5.91dBi) = 5.91 dBi



4 List of Measuring Equipment

Instrument	Brand Name	Model No.	Serial No.	Characteristics	Calibration Date	Test Date	Due Date	Remark
Loop Antenna	R&S	HFH2-Z2E	100840	9kHz~30MHz	Jun. 21, 2021	Aug. 15, 2021~ Nov. 06, 2021	Jun. 20, 2022	Radiation (03CH02-CA)
Bilog Antenna	TESEQ	6111D	50392	30MHz~1GHz	Aug. 10, 2021	Aug. 15, 2021~ Nov. 06, 2021	Aug. 09, 2022	Radiation (03CH02-CA)
Horn Antenna	SCHWARZBECK	BBHA 9120D	02113	1GHz~18GHz	Jul. 08, 2021	Aug. 15, 2021~ Nov. 06, 2021	Jul. 07, 2022	Radiation (03CH02-CA)
Horn Antenna	SCHWARZBECK	BBHA 9170D	00842	18GHz~40GHz	Jul. 20, 2021	Aug. 15, 2021~ Nov. 06, 2021	Jul. 19, 2022	Radiation (03CH02-CA)
Amplifier	SONOMA	310N	372240	N/A	Aug. 09, 2021	Aug. 15, 2021~ Nov. 06, 2021	Aug. 08, 2022	Radiation (03CH02-CA)
Preamplifier	Keysight	83017A	MY53270323	1GHz~26.5GHz	Jul. 27, 2021	Aug. 15, 2021~ Nov. 06, 2021	Jul. 26, 2022	Radiation (03CH02-CA)
Preamplifier	E-instrument	ERA-100M-18G-56-01-A70	EC1900251	1GHz~18GHz	Mar. 30, 2021	Aug. 15, 2021~ Nov. 06, 2021	Mar. 29, 2022	Radiation (03CH02-CA)
Preamplifier	Jet-Power	JPA0118-55-303	17100018000 55004	1GHz~18GHz	Jul. 21, 2021	Aug. 15, 2021~ Nov. 06, 2021	Jul. 20, 2022	Radiation (03CH02-CA)
Preamplifier	EMEC	EMC18G40G	60725	18GHz-40GHz	Jul. 21, 2021	Aug. 15, 2021~ Nov. 06, 2021	Jul. 20, 2022	Radiation (03CH02-CA)
Spectrum Analyzer	Keysight	N9010A	MY54200485	10Hz~44GHz	Mar. 05, 2021	Aug. 15, 2021~ Nov. 06, 2021	Mar. 04, 2022	Radiation (03CH02-CA)
Filter	Wainwright	WHKX8-5872.5-6750-18000-40ST	SN08	6.75GHz High Pass Filter	Jul. 23, 2021	Aug. 15, 2021~ Nov. 06, 2021	Jul. 22, 2022	Radiation (03CH02-CA)
Filter	Wainwright	WHKX12-2700-3000-18000-60ST	SN10	3 GHz High Pass Filter	Jul. 23, 2021	Aug. 15, 2021~ Nov. 06, 2021	Jul. 22, 2022	Radiation (03CH02-CA)
Filter	Wainwright	WLK12-1200-1272-11000-40SS	SN1	1.2G Low Pass	Jul. 23, 2021	Aug. 15, 2021~ Nov. 06, 2021	Jul. 22, 2022	Radiation (03CH02-CA)
Hygrometer	TESEO	608-H1	45142602	N/A	Aug. 04, 2021	Aug. 15, 2021~ Nov. 06, 2021	Aug. 03, 2022	Radiation (03CH02-CA)
Controller	ChainTek	3000-1	N/A	Control Turn table & Ant Mast	N/A	Aug. 15, 2021~ Nov. 06, 2021	N/A	Radiation (03CH02-CA)
Antenna Mast	ChainTek	MBS-520-1	N/A	1m~4m	N/A	Aug. 15, 2021~ Nov. 06, 2021	N/A	Radiation (03CH02-CA)
Turn Table	ChainTek	T-200-S-1	N/A	0~360 Degree	N/A	Aug. 15, 2021~ Nov. 06, 2021	N/A	Radiation (03CH02-CA)
Software	Audix	E3	N/A	N/A	N/A	Aug. 15, 2021~ Nov. 06, 2021	N/A	Radiation (03CH02-CA)
Hygrometer	Testo	608-H1	45142595	N/A	Sep. 03, 2021	Oct. 01, 2021~ Dec. 01, 2021	Sep. 02, 2022	Conducted (TH01-CA)
Power Sensor	EM Electronics Corporation	RPR3006W	RPR6W-1901026	10MHz-6GHz	Jul. 26, 2021	Oct. 01, 2021~ Dec. 01, 2021	Jul. 25, 2022	Conducted (TH01-CA)
Switch Box & RF Cable	EM Electronics	EMSW26	1090304	N/A	Dec. 30, 2020	Oct. 01, 2021~ Dec. 01, 2021	Dec. 29, 2021	Conducted (TH01-CA)
Spectrum Analyzer	Rohde & Schwarz	FSV40	101089	10Hz-40GHz	Jun. 02, 2021	Oct. 01, 2021~ Dec. 01, 2021	Jun. 01, 2022	Conducted (TH01-CA)
Power Sensor	EM Electronics Corporation	RPR3006W #010	RPR6W-2101003	10MHz-8GHz	Apr. 15, 2021	Oct. 01, 2021~ Nov. 30, 2021	Apr. 14, 2022	Conducted (TH01-CA)



Instrument	Brand Name	Model No.	Serial No.	Characteristics	Calibration Date	Test Date	Due Date	Remark
LISN	TESEQ	NNB51	47407	N/A	Jul. 21, 2021	Dec. 17, 2021	Jul. 20, 2022	Conduction (CO01-CA)
EMI Test Receiver	R&S	ESR7	102177	9KHz~7GHz	Jun. 02, 2021	Dec. 17, 2021	Jun. 01, 2022	Conduction (CO01-CA)
Pulse limiter with 10dB attenuation	R&S	VTSD 9561-F N	9561-F-N00412	N/A	Jul. 07, 2021	Dec. 17, 2021	Jul. 06, 2022	Conduction (CO01-CA)
Test Software	R&S	EMC32 V10.30.0	N/A	N/A	N/A	Dec. 17, 2021	N/A	Conduction (CO01-CA)
Hygrometer	Testo	608-H1	45141354	N/A	Jul. 27, 2022	Dec. 01, 2022~ Dec. 14, 2022	Jul. 26, 2023	Conducted (TH01-CA)
USB Power Meter	EM Electronics Corporation	RPR3006W #010	RPR6W-2101003	10MHz-8GHz	May 04, 2022	Dec. 01, 2022~ Dec. 14, 2022	May 03, 2023	Conducted (TH01-CA)
Switch Box & RF Cable	EM Electronics	EMSW26	1090304	N/A	Mar. 30, 2022	Dec. 01, 2022~ Dec. 04, 2022	Mar. 29, 2023	Conducted (TH01-CA)
Switch Box & RF Cable	EM Electronics	EMSW26	1090304	N/A	Dec. 05, 2022	Dec. 05, 2022~ Dec. 14, 2022	Dec. 04, 2023	Conducted (TH01-CA)
Spectrum Analyzer	Rohde & Schwarz	FSV40	101089	10Hz-40GHz	Jun. 01, 2022	Dec. 01, 2022~ Dec. 14, 2022	May 31, 2023	Conducted (TH01-CA)
Horn Antenna	SCHWARZBECK	BBHA 9120D	02113	1GHz~18GHz	Jun. 22, 2022	Jan. 13, 2023~ Feb. 07, 2023	Jun. 21, 2023	Radiation (03CH02-CA)
Preamplifier	Keysight	83017A	MY53270323	1GHz~26.5GHz	May 11, 2022	Jan. 13, 2023~ Feb. 07, 2023	May 10, 2023	Radiation (03CH02-CA)
RF Cable	HUBER+SUHNER	SUCOFLEX 102	8024032/2, 802406/2, 802875/2	N/A	Jun. 22, 2022	Jan. 13, 2023~ Feb. 07, 2023	Jun. 21, 2023	Radiation (03CH02-CA)
Hygrometer	TESEO	608-H1	45142602	N/A	Sep.12, 2022	Jan. 13, 2023~ Feb. 07, 2023	Sep. 11, 2023	Radiation (03CH02-CA)
Controller	ChainTek	EM-1000	060876	NA	N/A	Jan. 13, 2023~ Feb. 07, 2023	N/A	Radiation (03CH02-CA)
Antenna Mast	ChainTek	MBS-520-1	N/A	1m~4m	N/A	Jan. 13, 2023~ Feb. 07, 2023	N/A	Radiation (03CH02-CA)
Turn Table	ChainTek	T-200-S-1	N/A	0~360 Degree	N/A	Jan. 13, 2023~ Feb. 07, 2023	N/A	Radiation (03CH02-CA)
Software	Audix	E3	N/A	N/A	N/A	Jan. 13, 2023~ Feb. 07, 2023	N/A	Radiation (03CH02-CA)



5 Uncertainty of Evaluation

Uncertainty of Conducted Emission Measurement (150kHz ~ 30MHz)

Measuring Uncertainty for a Level of Confidence of 95% ($U = 2Uc(y)$)	2.0 dB
---	--------

Uncertainty of Radiated Emission Measurement (30 MHz ~ 1000 MHz)

Measuring Uncertainty for a Level of Confidence of 95% ($U = 2Uc(y)$)	4.7 dB
---	--------

Uncertainty of Radiated Emission Measurement (1000 MHz ~ 18000 MHz)

Measuring Uncertainty for a Level of Confidence of 95% ($U = 2Uc(y)$)	6.2 dB
---	--------

Uncertainty of Radiated Emission Measurement (18000 MHz ~ 40000 MHz)

Measuring Uncertainty for a Level of Confidence of 95% ($U = 2Uc(y)$)	6.5 dB
---	--------

Appendix A. Test Result of Conducted Test Items

Test Engineer	Liliana Gonzalez and Andy Kao	Temperature	17.1~22.5	°C
Test Date	2021/10/1~2021/12/01	Relative Humidity	32.4~54.8	%

TEST RESULTS DATA
Average Power Table

<Radio 2>
 <CDD>

FCC UNII-3 MIMO 4Tx Mode Ant A + D + B + C												
Mod.	Data Rate	N _{TX}	CH.	Freq. (MHz)	Average Conducted Power (dBm)					FCC Conducted Power Limit (dBm)	DG (dBi)	Pass/Fail
					Ant A	Ant D	Ant B	Ant C	SUM	Ant A + D + B + C	Ant A + D + B + C	
11a	6Mbps	4	149	5745	20.24	19.68	19.94	18.95	25.75	30.00	2.90	Pass
11a	6Mbps	4	157	5785	19.62	19.17	19.40	18.52	25.22	30.00	2.90	Pass
11a	6Mbps	4	165	5825	20.24	19.80	20.03	19.27	25.87	30.00	2.90	Pass
HT20	MCS0	4	149	5745	21.10	20.60	21.00	20.60	26.85	30.00	2.90	Pass
HT20	MCS0	4	157	5785	21.15	20.52	21.05	20.91	26.93	30.00	2.90	Pass
HT40	MCS0	4	151	5755	19.19	18.59	19.09	18.34	24.84	30.00	2.90	Pass
HT40	MCS0	4	159	5795	18.23	17.53	18.33	17.80	24.01	30.00	2.90	Pass
VHT20	MCS0	4	149	5745	21.04	20.59	21.10	20.53	26.84	30.00	2.90	Pass
VHT20	MCS0	4	157	5785	21.07	20.64	21.11	20.80	26.93	30.00	2.90	Pass
VHT40	MCS0	4	151	5755	19.24	18.67	19.23	18.42	24.93	30.00	2.90	Pass
VHT40	MCS0	4	159	5795	18.16	17.56	18.36	17.80	24.00	30.00	2.90	Pass
VHT80	MCS0	4	155	5775	20.64	20.13	20.75	20.05	26.42	30.00	2.90	Pass

Note 1: The device has 4 antennas, each of which has one of two polarizations that are orthogonal to one another.

Each polarization has 2 antenna

Note 2: Directional Gain = G_{MAX} + Array Gain = 2.9 dBi + 0 dB = 2.9 dBi

Array Gain = 0 dBi for N_{ant} ≤ 4 in CDD mode.

TEST RESULTS DATA
Power Spectral Density

FCC UNII-3 MIMO 4Tx Mode Ant A + D + B + C																	
Mod.	Data Rate	NTX	CH.	Freq. (MHz)	Average Power Density (dBm/300kHz)				RBW factor (dB)	Average Power Density (dBm/500kHz)					Average PSD Limit (dBm/500kHz)	DG (dBi) (note.1)	Pass /Fail
					Ant A	Ant D	Ant B	Ant C		Ant A	Ant D	Ant B	Ant C	SUM			
11a	6Mbps	4	149	5745	3.51	3.08	3.44	2.40	2.22	5.73	5.30	5.66	4.62	11.37	30.00	5.91	Pass
11a	6Mbps	4	157	5785	2.78	2.42	2.91	1.88	2.22	5.00	4.64	5.13	4.10	10.75	30.00	5.91	Pass
11a	6Mbps	4	165	5825	3.65	3.42	3.44	2.89	2.22	5.87	5.64	5.66	5.11	11.60	30.00	5.91	Pass

Note 1: The device has 4 antennas, each of which has one of two polarizations that are orthogonal to one another. Each polarization has 2 antennas.

Note 2: Directional Gain = GMAX + Array Gain = 2.9dBi + 3.01 dB = 5.91dBi

Array Gain = $10 \cdot \log(N_{ant}/N_{ss}) = 10 \cdot \log(2/1) = 3.01 \text{ dB}$; $N_{ant}=2$ and $N_{ss}=1$

Note 3: $PSD(\text{dBm}/500\text{kHz}) = PSD(\text{dBm}/300\text{kHz}) + \text{RBW factor}$

RBW factor = $10 \cdot \log(500\text{kHz}/300\text{kHz})$

TEST RESULTS DATA
6dB and 99% OBW

FCC UNII-3 MIMO 4Tx Mode Ant A + D + B + C																		
Mod.	Data Rate	NTX	CH.	Freq. (MHz)	26dB Bandwidth (MHz)				6 dB Bandwidth (MHz)				99% Bandwidth (MHz)				6 dB Min. Limit (MHz)	Pass /Fail
					Ant A	Ant D	Ant B	Ant C	Ant A	Ant D	Ant B	Ant C	Ant A	Ant D	Ant B	Ant C		
11a	6Mbps	4	149	5745	20.80	20.75	20.65	20.20	16.35	16.35	16.35	16.35	16.53	16.48	16.48	16.43	0.5	Pass
11a	6Mbps	4	157	5785	20.70	20.70	20.70	20.15	16.33	16.40	16.35	16.30	16.53	16.43	16.53	16.38	0.5	Pass
11a	6Mbps	4	165	5825	21.40	20.85	21.90	20.90	15.78	16.35	16.35	16.35	16.63	16.53	16.63	16.43	0.5	Pass

TEST RESULTS DATA
Average Power Table

FCC UNII-3 MIMO 4Tx Mode Ant A + D + B + C													
Mod.	Data Rate	Ntx	CH.	Freq. (MHz)	RU Config	Average Conducted Power (dBm)					FCC Conducted Power Limit (dBm)	DG (dBi) (see note.1)	Pass/Fail
						Ant A	Ant D	Ant B	Ant C	SUM	Ant A + D + B + C	Ant A + D + B + C	
HE20	MCS0	4	149	5745	Full	21.28	20.66	20.94	20.45	26.86	30.00	2.90	Pass
HE20	MCS0	4	157	5785	Full	21.16	20.55	21.03	20.95	26.95	30.00	2.90	Pass
HE20	MCS0	4	165	5825	Full	21.22	20.68	21.36	20.89	27.07	30.00	2.90	Pass
HE40	MCS0	4	151	5755	Full	19.27	18.68	19.19	18.53	24.95	30.00	2.90	Pass
HE40	MCS0	4	159	5795	Full	18.16	17.57	18.32	17.91	24.02	30.00	2.90	Pass
HE80	MCS0	4	155	5775	Full	20.70	20.10	20.70	20.20	26.45	30.00	2.90	Pass

Note 1: The device has 4 antennas, each of which has one of two polarizations that are orthogonal to one another.

Each polarization has 2 antenna

Note 2: Directional Gain =GMAX + Array Gain = 2.9 dBi + 0 dB = 2.9 dBi

Array Gain = 0 dBi for Nant <= 4 in CDD mode.

TEST RESULTS DATA
Power Spectral Density

FCC UNII-3 MIMO 4Tx Mode Ant A + D + B + C																		
Mod.	Data Rate	Ntx	CH.	Freq. (MHz)	RU Config	Average Power Density (dBm/300kHz)				RBW factor (dB)	Average Power Density (dBm/500kHz)					Average PSD Limit (dBm/500kHz)	DG (dBi) (note.1)	Pass /Fail
						Ant A	Ant D	Ant B	Ant C		Ant A	Ant D	Ant B	Ant C	SUM			
HE20	MCS0	4	149	5745	Full	4.01	3.42	4.09	3.09	2.22	6.23	5.64	6.31	5.31	11.91	30.00	5.91	Pass
HE20	MCS0	4	157	5785	Full	3.95	3.17	4.05	3.80	2.22	6.17	5.39	6.27	6.02	11.99	30.00	5.91	Pass
HE20	MCS0	4	165	5825	Full	3.95	3.40	4.31	4.12	2.22	6.17	5.62	6.53	6.34	12.20	30.00	5.91	Pass
HE40	MCS0	4	151	5755	Full	-0.79	-1.49	-0.41	-1.51	2.22	1.43	0.73	1.81	0.71	7.21	30.00	5.91	Pass
HE40	MCS0	4	159	5795	Full	-1.44	-2.49	-1.28	-1.99	2.22	0.78	-0.27	0.94	0.23	6.46	30.00	5.91	Pass
HE80	MCS0	4	155	5775	Full	-2.11	-2.82	-1.91	-2.57	2.22	0.11	-0.60	0.31	-0.35	5.90	30.00	5.91	Pass

Note 1: The device has 4 antennas, each of which has one of two polarizations that are orthogonal to one another.

Each polarization has 2 antenna

Note 2: Directional Gain =GMAX + Array Gain = 2.9dBi + 3.01 dB= 5.91dBi

Array Gain = $10 \cdot \log(\text{Nant}/\text{Nss}) = 10 \cdot \log(2/1) = 3.01 \text{ dB}$; Nant=2 and Nss=1

Note 3: PSD(dBm/500kHz) = PSD(dBm/300kHz) + RBW factor

RBW factor = $10 \cdot \log(500\text{kHz}/300\text{kHz})$

TEST RESULTS DATA
6dB and 99% OBW

FCC UNII-3 MIMO 4Tx Mode Ant A + D + B + C																			
Mod.	Data Rate	Ntx	CH.	Freq. (MHz)	RU Config	26dB Bandwidth (MHz)				6 dB Bandwidth (MHz)				99% Bandwidth (MHz)				6 dB Min. Limit (MHz)	Pass /Fail
						Ant A	Ant D	Ant B	Ant C	Ant A	Ant D	Ant B	Ant C	Ant A	Ant D	Ant B	Ant C		
HE20	MCS0	4	149	5745	Full	22.10	22.60	21.65	21.70	18.27	18.95	18.65	18.95	18.98	18.98	18.93	18.98	0.5	Pass
HE20	MCS0	4	157	5785	Full	29.95	23.25	25.90	24.45	18.47	18.95	18.85	18.95	19.23	19.03	19.08	19.13	0.5	Pass
HE20	MCS0	4	165	5825	Full	32.20	26.85	37.40	27.55	18.65	19.00	18.95	19.00	19.53	19.28	19.98	19.48	0.5	Pass
HE40	MCS0	4	151	5755	Full	40.77	41.13	41.22	40.86	37.98	37.98	37.89	37.80	37.86	37.96	37.86	37.86	0.5	Pass
HE40	MCS0	4	159	5795	Full	40.86	41.04	40.77	41.04	37.89	37.98	37.89	37.98	37.86	37.86	37.86	37.86	0.5	Pass
HE80	MCS0	4	155	5775	Full	100.00	82.40	83.68	84.00	76.64	77.12	77.44	77.44	77.20	77.20	77.32	77.08	0.5	Pass

Report Number : FR210728001-04C

Test Engineer	LilianaGonzalez	Temperature	17.2~22	°C
Test Date	2022/12/01~2022/12/14	Relative Humidity	36.8~50.9	%

TEST RESULTS DATA
Average Power Table

FCC UNII-3 MIMO 4Tx Mode Ant A + D + B + C													
Mod.	Data Rate	N _{TX}	CH.	Freq. (MHz)	RU Config.	Average Conducted Power (dBm)					FCC Conducted Power Limit (dBm)	DG (dBi) (see note.1)	Pass/Fail
						Ant A	Ant D	Ant B	Ant C	SUM	Ant A + D + B + C	Ant A + D + B + C	
HE20	MCS0	4	149	5745	Full	21.28	20.66	20.94	20.45	26.86	30.00	2.90	Pass
HE20	MCS0	4	149	5745	52_52_52_52	19.33	18.57	19.17	18.68	24.97	30.00	2.90	Pass
HE20	MCS0	4	149	5745	106_106	19.44	18.75	18.93	18.89	25.03	30.00	2.90	Pass
HE20	MCS0	4	157	5785	Full	21.16	20.55	21.03	20.95	26.95	30.00	2.90	Pass
HE20	MCS0	4	157	5785	52_52_52_52	19.26	19.53	18.97	18.95	25.20	30.00	2.90	Pass
HE20	MCS0	4	157	5785	106_106	19.44	18.83	18.69	18.72	24.95	30.00	2.90	Pass
HE20	MCS0	4	165	5825	Full	21.22	20.68	21.36	20.89	27.07	30.00	2.90	Pass
HE20	MCS0	4	165	5825	52_52_52_52	19.15	18.50	18.64	18.42	24.71	30.00	2.90	Pass
HE20	MCS0	4	165	5825	106_106	19.31	18.90	18.80	18.60	24.93	30.00	2.90	Pass

Note 1: The device has 4 antennas, each of which has one of two polarizations that are orthogonal to one another.

Each polarization has 2 antenna

Note 2: Directional Gain = $G_{MAX} + \text{Array Gain} = 2.9 \text{ dBi} + 0 \text{ dB} = 2.9 \text{ dBi}$

Array Gain = 0 dBi for Nant <= 4 in CDD mode.

Note 3: The test results of full RU configs presented in the table are derived from the originally-granted test report (FR210728001E) for power and PSD compar

Note 4: The power setting of partial RU increases or decreases in one dB step, whereas the power setting in Full RU are half dB step.

TEST RESULTS DATA
Power Spectral Density

FCC UNII-3 MIMO 4Tx Mode Ant A + D + B + C																		
Mod.	Data Rate	NTX	CH.	Freq. (MHz)	RU Config.	Average Power Density (dBm/300kHz)				RBW factor (dB)	Average Power Density (dBm/500kHz)					Average PSD Limit (dBm/500kHz)	DG (dBi) (note.1)	Pass /Fail
						Ant A	Ant D	Ant B	Ant C		Ant A	Ant D	Ant B	Ant C	SUM			
HE20	MCS0	4	149	5745	Full	4.01	3.42	4.09	3.09	2.22	6.23	5.64	6.31	5.31	11.91	30.00	5.91	Pass
HE20	MCS0	4	149	5745	52_52_52_52	2.98	2.83	2.58	2.72	2.22	5.20	5.05	4.80	4.94	11.02	30.00	5.91	Pass
HE20	MCS0	4	149	5745	106_106	3.12	3.25	2.70	2.62	2.22	5.34	5.47	4.92	4.84	11.17	30.00	5.91	Pass
HE20	MCS0	4	157	5785	Full	3.95	3.17	4.05	3.80	2.22	6.17	5.39	6.27	6.02	11.99	30.00	5.91	Pass
HE20	MCS0	4	157	5785	52_52_52_52	2.76	1.79	2.33	1.97	2.22	4.98	4.01	4.55	4.19	10.47	30.00	5.91	Pass
HE20	MCS0	4	157	5785	106_106	3.11	2.98	2.53	2.84	2.22	5.33	5.20	4.75	5.06	11.11	30.00	5.91	Pass
HE20	MCS0	4	165	5825	Full	3.95	3.40	4.31	4.12	2.22	6.17	5.62	6.53	6.34	12.20	30.00	5.91	Pass
HE20	MCS0	4	165	5825	52_52_52_52	2.30	2.39	2.48	2.15	2.22	4.52	4.61	4.70	4.37	10.57	30.00	5.91	Pass
HE20	MCS0	4	165	5825	106_106	2.80	2.53	2.73	2.49	2.22	5.02	4.75	4.95	4.71	10.88	30.00	5.91	Pass

Note 1: The device has 4 antennas, each of which has one of two polarizations that are orthogonal to one another.

Each polarization has 2 antenna

Note 2: Directional Gain = GMAX + Array Gain = 2.9dBi + 3.01 dB = 5.91dBi

Array Gain = $10 \cdot \log(N_{ant}/N_{ss}) = 10 \cdot \log(2/1) = 3.01 \text{ dB}$; $N_{ant}=2$ and $N_{ss}=1$

Note 3: $\text{PSD}(\text{dBm}/500\text{kHz}) = \text{PSD}(\text{dBm}/300\text{kHz}) + \text{RBW factor}$

RBW factor = $10 \cdot \log(500\text{kHz}/300\text{kHz})$

TEST RESULTS DATA
6dB and 99% OBW

FCC UNII-3 MIMO 4Tx Mode Ant A + D + B + C																			
Mod.	Data Rate	Ntx	CH.	Freq. (MHz)	RU Config	26dB Bandwidth (MHz)				6 dB Bandwidth (MHz)				99% Bandwidth (MHz)				6 dB Min. Limit (MHz)	Pass /Fail
						Ant A	Ant D	Ant B	Ant C	Ant A	Ant D	Ant B	Ant C	Ant A	Ant D	Ant B	Ant C		
HE20	MCS0	4	149	5745	Full	22.10	22.60	21.65	21.70	18.27	18.95	18.65	18.95	18.98	18.98	18.93	18.98	0.5	Pass
HE20	MCS0	4	157	5785	Full	29.95	23.25	25.90	24.45	18.47	18.95	18.85	18.95	19.23	19.03	19.08	19.13	0.5	Pass
HE20	MCS0	4	165	5825	Full	32.20	26.85	37.40	27.55	18.65	19.00	18.95	19.00	19.53	19.28	19.98	19.48	0.5	Pass
HE40	MCS0	4	151	5755	Full	40.77	41.13	41.22	40.86	37.98	37.98	37.89	37.80	37.86	37.96	37.86	37.86	0.5	Pass
HE40	MCS0	4	159	5795	Full	40.86	41.04	40.77	41.04	37.89	37.98	37.89	37.98	37.86	37.86	37.86	37.86	0.5	Pass
HE80	MCS0	4	155	5775	Full	100.00	82.40	83.68	84.00	76.64	77.12	77.44	77.44	77.20	77.20	77.32	77.08	0.5	Pass

TEST RESULTS DATA
Average Power Table

<TXBF>

FCC UNII-3 Beamforming Mode Ant A + D + B + C												
Mod.	Data Rate	NTX	CH.	Freq. (MHz)	Average Conducted Power (dBm)					FCC Conducted Power Limit (dBm)	DG (dBi)	Pass/Fail
					Ant A	Ant D	Ant B	Ant C	SUM	Ant A + D + B + C	Ant A + D + B + C	
11a	6Mbps	4	149	5745	20.24	19.68	19.94	18.95	25.75	30.00	5.91	Pass
11a	6Mbps	4	157	5785	19.62	19.17	19.4	18.52	25.22	30.00	5.91	Pass
11a	6Mbps	4	165	5825	20.24	19.80	20.03	19.27	25.87	30.00	5.91	Pass
HT20	MCS0	4	149	5745	21.10	20.60	21.00	20.60	26.85	30.00	5.91	Pass
HT20	MCS0	4	157	5785	21.15	20.52	21.05	20.91	26.93	30.00	5.91	Pass
HT40	MCS0	4	151	5755	19.19	18.59	19.09	18.34	24.84	30.00	5.91	Pass
HT40	MCS0	4	159	5795	18.23	17.53	18.33	17.80	24.01	30.00	5.91	Pass
VHT20	MCS0	4	149	5745	21.04	20.59	21.10	20.53	26.84	30.00	5.91	Pass
VHT20	MCS0	4	157	5785	21.07	20.64	21.11	20.80	26.93	30.00	5.91	Pass
VHT40	MCS0	4	151	5755	19.24	18.67	19.23	18.42	24.93	30.00	5.91	Pass
VHT40	MCS0	4	159	5795	18.16	17.56	18.36	17.80	24.00	30.00	5.91	Pass
VHT80	MCS0	4	155	5775	20.64	20.13	20.75	20.05	26.42	30.00	5.91	Pass

Note 1: The device has 4 antennas, each of which has one of two polarizations that are orthogonal to one another.

Each polarization has 2 antenna

Note 2: Directional Gain = GMAX + Array Gain = 2.9 dBi + 3.01 dB = 5.91dBi

Array Gain = $10 \cdot \log(N_{ant}/N_{ss}) = 10 \cdot \log(2/1) = 3.01 \text{ dB}$; $N_{ant}=2$ and $N_{ss}=1$

TEST RESULTS DATA
Average Power Table

FCC UNII-3 Beamforming Mode Ant A + D + B + C													
Mod.	Data Rate	Ntx	CH.	Freq. (MHz)	RU Config	Average Conducted Power (dBm)					FCC Conducted Power Limit (dBm)	DG (dBi) (see note.1)	Pass/Fail
						Ant A	Ant D	Ant B	Ant C	SUM	Ant A + D + B + C	Ant A + D + B + C	
HE20	MCS0	4	149	5745	Full	21.28	20.66	20.94	20.45	26.86	30.00	2.90	Pass
HE20	MCS0	4	157	5785	Full	21.16	20.55	21.03	20.95	26.95	30.00	2.90	Pass
HE20	MCS0	4	165	5825	Full	21.22	20.68	21.36	20.89	27.07	30.00	2.90	Pass
HE40	MCS0	4	151	5755	Full	19.27	18.68	19.19	18.53	24.95	30.00	2.90	Pass
HE40	MCS0	4	159	5795	Full	18.16	17.57	18.32	17.91	24.02	30.00	2.90	Pass
HE80	MCS0	4	155	5775	Full	20.70	20.10	20.70	20.20	26.45	30.00	2.90	Pass

Note 1: The device has 4 antennas, each of which has one of two polarizations that are orthogonal to one another.

Each polarization has 2 antenna

Note 2: Directional Gain =GMAX + Array Gain = 2.9 dBi + 3.01 dB= 5.91 dBi

Array Gain = $10 \cdot \log(\text{Nant}/\text{Nss}) = 10 \cdot \log(2/1) = 3.01 \text{ dB}$; Nant=2 and Nss=1

TEST RESULTS DATA
Average Power Table

<Radio 3>

<CDD>

FCC UNII-3 MIMO 4Tx Mode Ant E + H + F + G												
Mod.	Data Rate	NTX	CH.	Freq. (MHz)	Average Conducted Power (dBm)					FCC Conducted Power Limit (dBm)	DG (dBi) (see note.1)	Pass/Fail
					Ant E	Ant H	Ant F	Ant G	SUM	Ant E + H + F + G	Ant E + H + F + G	
11a	6Mbps	4	149	5745	21.48	20.71	21.57	20.62	27.14	30.00	2.90	Pass
11a	6Mbps	4	157	5785	20.67	20.07	20.86	20.39	26.53	30.00	2.90	Pass
11a	6Mbps	4	165	5825	21.09	20.74	21.33	20.48	26.94	30.00	2.90	Pass
HT20	MCS0	4	149	5745	21.07	20.32	21.13	20.29	26.74	30.00	2.90	Pass
HT20	MCS0	4	157	5785	20.42	19.68	20.43	20.03	26.17	30.00	2.90	Pass
HT20	MCS0	4	165	5825	20.80	20.24	20.93	20.06	26.54	30.00	2.90	Pass
HT40	MCS0	4	151	5755	21.90	21.10	21.80	21.20	27.53	30.00	2.90	Pass
HT40	MCS0	4	159	5795	21.55	20.80	21.60	21.15	27.31	30.00	2.90	Pass
VHT20	MCS0	4	149	5745	21.04	20.28	21.11	20.28	26.72	30.00	2.90	Pass
VHT20	MCS0	4	157	5785	20.35	19.72	20.39	20.09	26.17	30.00	2.90	Pass
VHT20	MCS0	4	165	5825	20.68	20.29	20.89	20.03	26.51	30.00	2.90	Pass
VHT40	MCS0	4	151	5755	21.90	21.10	21.90	21.15	27.55	30.00	2.90	Pass
VHT40	MCS0	4	159	5795	21.53	20.84	21.59	21.15	27.31	30.00	2.90	Pass
VHT80	MCS0	4	155	5775	21.32	20.75	21.56	20.95	27.18	30.00	2.90	Pass

Note 1: The device has 4 antennas, each of which has one of two polarizations that are orthogonal to one another.

Each polarization has 2 antenna

Note 2: Directional Gain =GMAX + Array Gain = 2.9 dBi + 0 dB = 2.9 dBi

Array Gain = 0 dBi for Nant <= 4 in CDD mode.

TEST RESULTS DATA
Power Spectral Density

FCC UNII-3 MIMO 4Tx Mode Ant E + H + F + G																	
Mod.	Data Rate	N _{Tx}	CH.	Freq. (MHz)	Average Power Density (dBm/300kHz)				RBW factor (dB)	Average Power Density (dBm/500kHz)					Average PSD Limit (dBm/500kHz)	DG (dBi) (note.1)	Pass /Fail
					Ant E	Ant H	Ant F	Ant G		Ant E	Ant H	Ant F	Ant G	SUM			
11a	6Mbps	4	149	5745	5.57	4.82	5.70	4.74	2.22	7.79	7.04	7.92	6.96	13.47	30.00	5.91	Pass
11a	6Mbps	4	157	5785	4.54	4.18	4.77	4.40	2.22	6.76	6.40	6.99	6.62	12.72	30.00	5.91	Pass
11a	6Mbps	4	165	5825	5.00	4.46	5.19	4.57	2.22	7.22	6.68	7.41	6.79	13.05	30.00	5.91	Pass

Note 1: The device has 4 antennas, each of which has one of two polarizations that are orthogonal to one another.

Each polarization has 2 antenna

Note 2: Directional Gain =GMAX + Array Gain = 2.9dBi + 3.01 dB= 5.91dBi

Array Gain = $10 \cdot \log(N_{ant}/N_{ss}) = 10 \cdot \log(2/1) = 3.01 \text{ dB}$; $N_{ant}=2$ and $N_{ss}=1$

Note 3: $PSD(\text{dBm}/500\text{kHz}) = PSD(\text{dBm}/300\text{kHz}) + \text{RBW factor}$

RBW factor = $10 \cdot \log(500\text{kHz}/300\text{kHz})$

TEST RESULTS DATA
6dB and 99% OBW

Band IV MIMO 4Tx Mode Ant E + H + F + G																		
Mod.	Data Rate	NTX	CH.	Freq. (MHz)	26dB Bandwidth (MHz)				6 dB Bandwidth (MHz)				99% Bandwidth (MHz)				6 dB Min. Limit (MHz)	Pass /Fail
					Ant E	Ant H	Ant F	Ant G	Ant E	Ant H	Ant F	Ant G	Ant E	Ant H	Ant F	Ant G		
11a	6Mbps	4	149	5745	21.80	21.00	21.40	21.25	16.38	16.50	16.55	16.55	16.78	16.73	16.73	16.73	0.5	Pass
11a	6Mbps	4	157	5785	21.85	20.95	21.25	21.30	16.38	16.50	16.50	16.50	16.73	16.73	16.73	16.73	0.5	Pass
11a	6Mbps	4	165	5825	21.40	21.40	21.60	20.95	16.40	16.55	16.55	16.55	16.73	16.73	16.73	16.73	0.5	Pass

TEST RESULTS DATA
Average Power Table

FCC UNII-3 MIMO 4Tx Mode Ant E + H + F + G													
Mod.	Data Rate	NTX	CH.	Freq. (MHz)	RU Config	Average Conducted Power (dBm)					FCC Conducted Power Limit (dBm)	DG (dBi)	Pass/Fail
						Ant E	Ant H	Ant F	Ant G	SUM	Ant E + H + F + G	Ant E + H + F + G	
HE20	MCS0	4	149	5745	Full	21.26	20.46	21.20	20.35	26.86	30.00	2.90	Pass
HE20	MCS0	4	157	5785	Full	20.47	19.80	20.60	20.15	26.29	30.00	2.90	Pass
HE20	MCS0	4	165	5825	Full	20.85	20.42	21.18	20.33	26.73	30.00	2.90	Pass
HE40	MCS0	4	151	5755	Full	21.90	21.18	21.90	21.16	27.57	30.00	2.90	Pass
HE40	MCS0	4	159	5795	Full	21.61	20.82	21.59	21.20	27.34	30.00	2.90	Pass
HE80	MCS0	4	155	5775	Full	21.36	20.76	21.49	21.04	27.19	30.00	2.90	Pass

Note 1: The device has 4 antennas, each of which has one of two polarizations that are orthogonal to one another.

Each polarization has 2 antenna

Note 2: Directional Gain = GMAX + Array Gain = 2.9 dBi + 0 dB = 2.9 dBi

Array Gain = 0 dBi for Nant <= 4 in CDD mode.

TEST RESULTS DATA
Power Spectral Density

FCC UNII-3 MIMO 4Tx Mode Ant E + H + F + G																		
Mod.	Data Rate	NTx	CH.	Freq. (MHz)	RU Config	Average Power Density (dBm/300kHz)				RBW factor (dB)	Average Power Density (dBm/500kHz)					Average PSD Limit (dBm/500kHz)	DG (dBi) (note.1)	Pass /Fail
						Ant E	Ant H	Ant F	Ant G		Ant E	Ant H	Ant F	Ant G	SUM			
HE20	MCS0	4	149	5745	Full	3.99	3.37	4.50	3.33	2.22	6.21	5.59	6.72	5.55	12.06	30.00	5.91	Pass
HE20	MCS0	4	157	5785	Full	3.27	2.59	3.66	3.03	2.22	5.49	4.81	5.88	5.25	11.39	30.00	5.91	Pass
HE20	MCS0	4	165	5825	Full	3.99	3.85	4.45	3.50	2.22	6.21	6.07	6.67	5.72	12.20	30.00	5.91	Pass
HE40	MCS0	4	151	5755	Full	2.21	1.37	2.34	1.47	2.22	4.43	3.59	4.56	3.69	10.11	30.00	5.91	Pass
HE40	MCS0	4	159	5795	Full	1.89	1.20	1.99	1.64	2.22	4.11	3.42	4.21	3.86	9.93	30.00	5.91	Pass
HE80	MCS0	4	155	5775	Full	-1.32	-2.09	-1.19	-1.56	2.22	0.90	0.13	1.03	0.66	6.71	30.00	5.91	Pass

Note 1: The device has 4 antennas, each of which has one of two polarizations that are orthogonal to one another.

Each polarization has 2 antenna

Note 2: Directional Gain =GMAX + Array Gain = 2.9dBi + 3.01 dB= 5.91dBi

Array Gain = $10 \cdot \log(\text{Nant}/\text{Nss}) = 10 \cdot \log(2/1) = 3.01 \text{ dB}$; Nant=2 and Nss=1

Note 3: PSD(dBm/500kHz) = PSD(dBm/300kHz) + RBW factor

RBW factor = $10 \cdot \log(500\text{kHz}/300\text{kHz})$

TEST RESULTS DATA
6dB and 99% OBW

Band IV MIMO 4Tx Mode Ant E + H + F + G																			
Mod.	Data Rate	NTx	CH.	Freq. (MHz)	RU Config	26dB Bandwidth (MHz)				6 dB Bandwidth (MHz)				99% Bandwidth (MHz)				6 dB Min. Limit (MHz)	Pass /Fail
						Ant E	Ant H	Ant F	Ant G	Ant E	Ant H	Ant F	Ant G	Ant E	Ant H	Ant F	Ant G		
HE20	MCS0	4	149	5745	Full	22.20	22.70	22.85	22.65	19.10	19.15	19.15	19.10	19.18	19.18	19.13	19.18	0.5	Pass
HE20	MCS0	4	157	5785	Full	22.55	22.70	22.70	23.15	19.00	19.10	19.15	19.10	19.13	19.13	19.18	19.13	0.5	Pass
HE20	MCS0	4	165	5825	Full	22.85	22.50	22.75	22.65	19.03	19.10	19.15	19.10	19.13	19.13	19.13	19.13	0.5	Pass
HE40	MCS0	4	151	5755	Full	40.32	40.05	40.14	40.14	37.71	37.89	37.89	37.87	37.66	37.76	37.66	37.66	0.5	Pass
HE40	MCS0	4	159	5795	Full	40.14	39.96	40.32	40.05	37.49	37.62	37.80	37.80	37.66	37.66	37.66	37.66	0.5	Pass
HE80	MCS0	4	155	5775	Full	83.20	82.24	82.56	82.24	76.48	76.96	77.12	76.64	76.96	76.84	76.72	76.84	0.5	Pass

Report Number : FR210728001-04C

Test Engineer	LilianaGonzalez	Temperature	17.7~22	°C
Test Date	2022/12/01~2022/12/14	Relative Humidity	36.8~50.9	%

TEST RESULTS DATA
Average Power Table

FCC UNII-3 MIMO 4Tx Mode Ant E + H + F + G													
Mod.	Data Rate	NTx	CH.	Freq. (MHz)	RU Config.	Average Conducted Power (dBm)					FCC Conducted Power Limit (dBm)	DG (dBi)	Pass/Fail
						Ant E	Ant H	Ant F	Ant G	SUM	Ant E + H + F + G	Ant E + H + F + G	
HE20	MCS0	4	149	5745	Full	21.26	20.46	21.20	20.35	26.86	30.00	2.90	Pass
HE20	MCS0	4	149	5745	52_52_52_52	20.30	19.61	19.83	19.83	25.92	30.00	2.90	Pass
HE20	MCS0	4	149	5745	106_106	20.33	19.40	19.78	19.80	25.86	30.00	2.90	Pass
HE20	MCS0	4	157	5785	Full	20.47	19.80	20.60	20.15	26.29	30.00	2.90	Pass
HE20	MCS0	4	157	5785	52_52_52_52	20.35	19.24	19.74	19.59	25.77	30.00	2.90	Pass
HE20	MCS0	4	157	5785	106_106	20.22	19.01	19.65	19.49	25.63	30.00	2.90	Pass
HE20	MCS0	4	165	5825	Full	20.85	20.42	21.18	20.33	26.73	30.00	2.90	Pass
HE20	MCS0	4	165	5825	52_52_52_52	20.43	19.83	19.86	19.99	26.05	30.00	2.90	Pass
HE20	MCS0	4	165	5825	106_106	20.34	19.65	19.77	19.87	25.94	30.00	2.90	Pass

Note 1: The device has 4 antennas, each of which has one of two polarizations that are orthogonal to one another.

Each polarization has 2 antenna

Note 2: Directional Gain = $G_{MAX} + \text{Array Gain} = 2.9 \text{ dBi} + 0 \text{ dB} = 2.9 \text{ dBi}$

Array Gain = 0 dBi for Nant <= 4 in CDD mode.

Note 3: The test results of full RU configs presented in the table are derived from the originally-granted test report (FR210728001E) for power and PSD compa

Note 4: The power setting of partial RU increases or decreases in one dB step, whereas the power setting in Full RU are half dB step.

TEST RESULTS DATA
Power Spectral Density

FCC UNII-3 MIMO 4Tx Mode Ant E + H + F + G																		
Mod.	Data Rate	NTx	CH.	Freq. (MHz)	RU Config.	Average Power Density (dBm/300kHz)				RBW factor (dB)	Average Power Density (dBm/500kHz)					Average PSD Limit (dBm/500kHz)	DG (dBi) (note.1)	Pass /Fail
						Ant E	Ant H	Ant F	Ant G		Ant E	Ant H	Ant F	Ant G	SUM			
HE20	MCS0	4	149	5745	Full	3.99	3.37	4.50	3.33	2.22	6.21	5.59	6.72	5.55	12.06	30.00	5.91	Pass
HE20	MCS0	4	149	5745	52_52_52_52	3.67	2.79	3.25	3.11	2.22	5.89	5.01	5.47	5.33	11.46	30.00	5.91	Pass
HE20	MCS0	4	149	5745	106_106	3.64	2.66	2.99	3.26	2.22	5.86	4.88	5.21	5.48	11.39	30.00	5.91	Pass
HE20	MCS0	4	157	5785	Full	3.27	2.59	3.66	3.03	2.22	5.49	4.81	5.88	5.25	11.39	30.00	5.91	Pass
HE20	MCS0	4	157	5785	52_52_52_52	3.67	2.40	3.02	2.95	2.22	5.89	4.62	5.24	5.17	11.27	30.00	5.91	Pass
HE20	MCS0	4	157	5785	106_106	3.41	2.31	2.87	2.89	2.22	5.63	4.53	5.09	5.11	11.13	30.00	5.91	Pass
HE20	MCS0	4	165	5825	Full	3.99	3.85	4.45	3.50	2.22	6.21	6.07	6.67	5.72	12.20	30.00	5.91	Pass
HE20	MCS0	4	165	5825	52_52_52_52	3.84	3.20	3.24	3.43	2.22	6.06	5.42	5.46	5.65	11.67	30.00	5.91	Pass
HE20	MCS0	4	165	5825	106_106	3.73	3.10	3.05	3.30	2.22	5.95	5.32	5.27	5.52	11.54	30.00	5.91	Pass

Note 1: The device has 4 antennas, each of which has one of two polarizations that are orthogonal to one another.

Each polarization has 2 antenna

Note 2: Directional Gain = G_{MAX} + Array Gain = 2.9dBi + 3.01 dB = 5.91dBi

Array Gain = $10 \cdot \log(Nant/Nss) = 10 \cdot \log(2/1) = 3.01$ dB ; Nant=2 and Nss=1

Note 3: PSD(dBm/500kHz) = PSD(dBm/300kHz) + RBW factor

RBW factor = $10 \cdot \log(500kHz/300kHz)$

TEST RESULTS DATA
Average Power Table

<TXBF>

FCC UNII-3 Beamforming Mode Ant E + H + F + G													
Mod.	Data Rate	NTX	CH.	Freq. (MHz)	Average Conducted Power (dBm)					FCC Conducted Power Limit (dBm)	DG (dBi) (see note.1)	Pass/Fail	
					Ant E	Ant H	Ant F	Ant G	SUM	Ant E + H + F + G	Ant E + H + F + G		
11a	6Mbps	4	149	5745	21.48	20.71	21.57	20.62	27.14	30.00	5.91	Pass	
11a	6Mbps	4	157	5785	20.67	20.07	20.86	20.39	26.53	30.00	5.91	Pass	
11a	6Mbps	4	165	5825	21.09	20.74	21.33	20.48	26.94	30.00	5.91	Pass	
HT20	MCS0	4	149	5745	21.07	20.32	21.13	20.29	26.74	30.00	5.91	Pass	
HT20	MCS0	4	157	5785	20.42	19.68	20.43	20.03	26.17	30.00	5.91	Pass	
HT20	MCS0	4	165	5825	20.80	20.24	20.93	20.06	26.54	30.00	5.91	Pass	
HT40	MCS0	4	151	5755	21.90	21.10	21.80	21.20	27.53	30.00	5.91	Pass	
HT40	MCS0	4	159	5795	21.55	20.80	21.60	21.15	27.31	30.00	5.91	Pass	
VHT20	MCS0	4	149	5745	21.04	20.28	21.11	20.28	26.72	30.00	5.91	Pass	
VHT20	MCS0	4	157	5785	20.35	19.72	20.39	20.09	26.17	30.00	5.91	Pass	
VHT20	MCS0	4	165	5825	20.68	20.29	20.89	20.03	26.51	30.00	5.91	Pass	
VHT40	MCS0	4	151	5755	21.90	21.10	21.90	21.15	27.55	30.00	5.91	Pass	
VHT40	MCS0	4	159	5795	21.53	20.84	21.59	21.15	27.31	30.00	5.91	Pass	
VHT80	MCS0	4	155	5775	21.32	20.75	21.56	20.95	27.18	30.00	5.91	Pass	

Note 1: The device has 4 antennas, each of which has one of two polarizations that are orthogonal to one another.

Each polarization has 2 antenna

Note 2: Directional Gain = GMAX + Array Gain = 2.9 dBi + 3.01 dB = 5.91 dBi

Array Gain = $10 \cdot \log(N_{ant}/N_{ss}) = 10 \cdot \log(2/1) = 3.01 \text{ dB}$; $N_{ant}=2$ and $N_{ss}=1$

TEST RESULTS DATA
Average Power Table

FCC UNII-3 Beamforming Mode Ant E + H + F + G													
Mod.	Data Rate	NTX	CH.	Freq. (MHz)	RU Config	Average Conducted Power (dBm)					FCC Conducted Power Limit (dBm)	DG (dBi)	Pass/Fail
						Ant E	Ant H	Ant F	Ant G	SUM	Ant E + H + F + G	Ant E + H + F + G	
HE20	MCS0	4	149	5745	Full	21.26	20.46	21.20	20.35	26.86	30.00	5.91	Pass
HE20	MCS0	4	157	5785	Full	20.47	19.80	20.60	20.15	26.29	30.00	5.91	Pass
HE20	MCS0	4	165	5825	Full	20.85	20.42	21.18	20.33	26.73	30.00	5.91	Pass
HE40	MCS0	4	151	5755	Full	21.90	21.18	21.90	21.16	27.57	30.00	5.91	Pass
HE40	MCS0	4	159	5795	Full	21.61	20.82	21.59	21.20	27.34	30.00	5.91	Pass
HE80	MCS0	4	155	5775	Full	21.36	20.76	21.49	21.04	27.19	30.00	5.91	Pass

Note 1: The device has 4 antennas, each of which has one of two polarizations that are orthogonal to one another.

Each polarization has 2 antenna

Note 2: Directional Gain =GMAX + Array Gain = 2.9 dBi + 3.01 dB= 5.91 dBi

Array Gain = $10 \cdot \log(\text{Nant}/\text{Nss}) = 10 \cdot \log(2/1) = 3.01 \text{ dB}$; Nant=2 and Nss=1



Appendix B. AC Conducted Emission Test Results

Test Engineer :	Paul Lin	Temperature :	18~21°C
		Relative Humidity :	42~45%

EUT Information

Test Site Location : CO01-CA
 Power: 120Vac/60Hz
 Mode: 1
 Type: Line

Full Spectrum

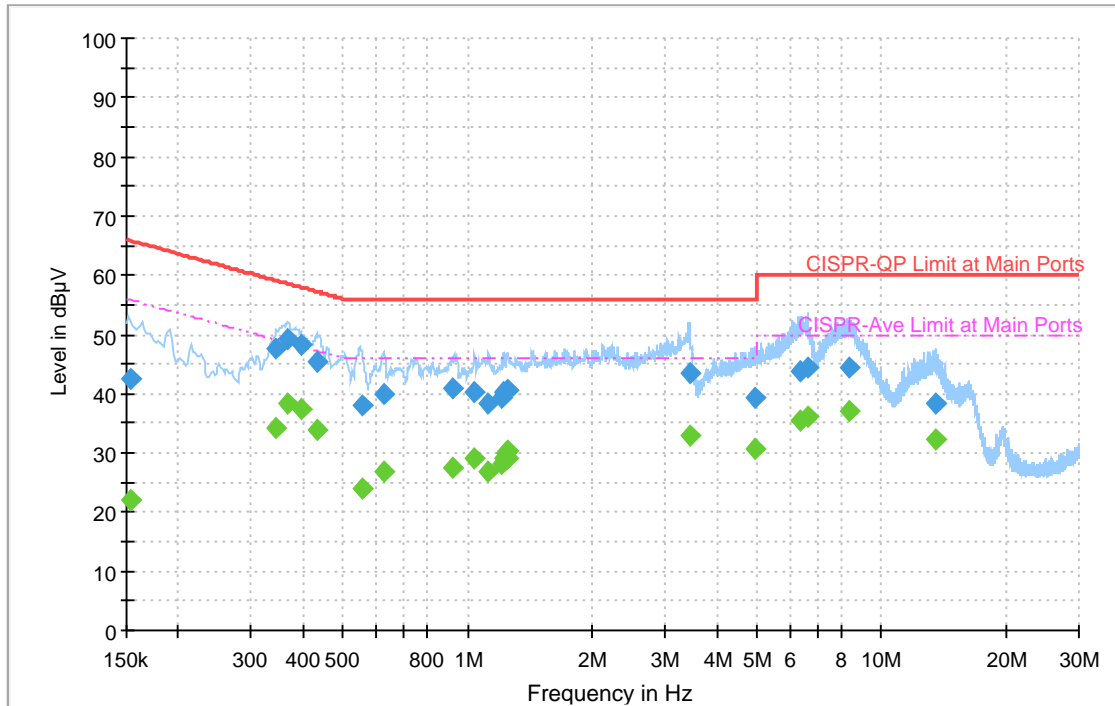

Final Result

Frequency (MHz)	QuasiPeak (dBµV)	CAverage (dBµV)	Limit (dBµV)	Margin (dB)	Line	Filter	Corr. (dB)
0.152842	---	22.07	55.84	33.77	L1	OFF	20.3
0.152842	42.47	---	65.84	23.37	L1	OFF	20.3
0.344679	---	34.08	49.09	15.01	L1	OFF	20.3
0.344679	47.68	---	59.09	11.41	L1	OFF	20.3
0.368988	---	38.28	48.52	10.24	L1	OFF	20.3
0.368988	49.25	---	58.52	9.27	L1	OFF	20.3
0.395673	---	37.35	47.94	10.59	L1	OFF	20.3
0.395673	48.33	---	57.94	9.61	L1	OFF	20.3
0.431682	---	33.88	47.22	13.34	L1	OFF	20.3
0.431682	45.30	---	57.22	11.92	L1	OFF	20.3
0.554001	---	24.08	46.00	21.92	L1	OFF	20.3
0.554001	37.99	---	56.00	18.01	L1	OFF	20.3
0.624975	---	26.87	46.00	19.13	L1	OFF	20.3
0.624975	39.81	---	56.00	16.19	L1	OFF	20.3
0.921750	---	27.42	46.00	18.58	L1	OFF	20.3
0.921750	40.99	---	56.00	15.01	L1	OFF	20.3
1.037688	---	29.05	46.00	16.95	L1	OFF	20.3
1.037688	40.23	---	56.00	15.77	L1	OFF	20.3
1.120443	---	26.86	46.00	19.14	L1	OFF	20.3
1.120443	38.19	---	56.00	17.81	L1	OFF	20.3
1.212459	---	28.21	46.00	17.79	L1	OFF	20.3

Frequency (MHz)	QuasiPeak (dBμV)	CAverage (dBμV)	Limit (dBμV)	Margin (dB)	Line	Filter	Corr. (dB)
1.212459	39.44	---	56.00	16.56	L1	OFF	20.3
1.226589	---	28.92	46.00	17.08	L1	OFF	20.3
1.226589	40.12	---	56.00	15.88	L1	OFF	20.3
1.236498	---	29.92	46.00	16.08	L1	OFF	20.3
1.236498	40.32	---	56.00	15.68	L1	OFF	20.3
1.244814	---	30.43	46.00	15.57	L1	OFF	20.3
1.244814	40.65	---	56.00	15.35	L1	OFF	20.3
1.244904	---	29.20	46.00	16.80	L1	OFF	20.3
1.244904	40.50	---	56.00	15.50	L1	OFF	20.3
3.431787	---	32.95	46.00	13.05	L1	OFF	20.4
3.431787	43.40	---	56.00	12.60	L1	OFF	20.4
4.930359	---	30.75	46.00	15.25	L1	OFF	20.4
4.930359	39.17	---	56.00	16.83	L1	OFF	20.4
6.328041	---	35.54	50.00	14.46	L1	OFF	20.4
6.328041	43.91	---	60.00	16.09	L1	OFF	20.4
6.612828	---	36.14	50.00	13.86	L1	OFF	20.4
6.612828	44.35	---	60.00	15.65	L1	OFF	20.4
8.328966	---	36.93	50.00	13.07	L1	OFF	20.5
8.328966	44.33	---	60.00	15.67	L1	OFF	20.5
13.504650	---	32.27	50.00	17.73	L1	OFF	20.5
13.504650	38.47	---	60.00	21.53	L1	OFF	20.5

EUT Information

Test Site Location : CO01-CA
 Power: 120Vac/60Hz
 Mode: 1
 Type: Neutral

Full Spectrum

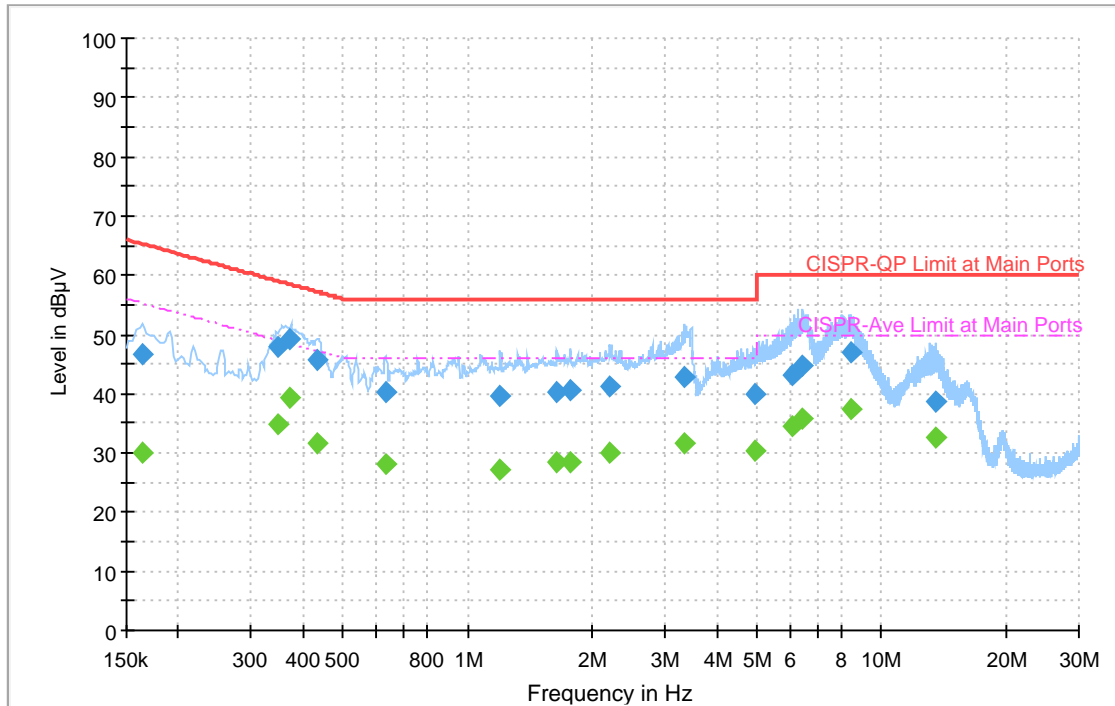

Final Result

Frequency (MHz)	QuasiPeak (dBµV)	CAverage (dBµV)	Limit (dBµV)	Margin (dB)	Line	Filter	Corr. (dB)
0.164013	---	30.02	55.26	25.24	N	OFF	20.2
0.164013	46.57	---	65.26	18.69	N	OFF	20.2
0.346686	---	34.68	49.04	14.36	N	OFF	20.3
0.346686	47.93	---	59.04	11.11	N	OFF	20.3
0.371220	---	39.19	48.47	9.28	N	OFF	20.3
0.371220	49.18	---	58.47	9.29	N	OFF	20.3
0.431466	---	31.61	47.22	15.61	N	OFF	20.3
0.431466	45.58	---	57.22	11.64	N	OFF	20.3
0.634965	---	28.24	46.00	17.76	N	OFF	20.3
0.634965	40.28	---	56.00	15.72	N	OFF	20.3
1.201767	---	27.19	46.00	18.81	N	OFF	20.3
1.201767	39.64	---	56.00	16.36	N	OFF	20.3
1.643937	---	28.28	46.00	17.72	N	OFF	20.3
1.643937	40.41	---	56.00	15.59	N	OFF	20.3
1.769316	---	28.56	46.00	17.44	N	OFF	20.3
1.769316	40.70	---	56.00	15.30	N	OFF	20.3
2.210307	---	29.92	46.00	16.08	N	OFF	20.3
2.210307	41.21	---	56.00	14.79	N	OFF	20.3
3.341571	---	31.60	46.00	14.40	N	OFF	20.3
3.341571	42.83	---	56.00	13.17	N	OFF	20.3
4.944102	---	30.33	46.00	15.67	N	OFF	20.4

Frequency (MHz)	QuasiPeak (dBμV)	CAverage (dBμV)	Limit (dBμV)	Margin (dB)	Line	Filter	Corr. (dB)
4.944102	39.82	---	56.00	16.18	N	OFF	20.4
6.084978	---	34.41	50.00	15.59	N	OFF	20.4
6.084978	43.29	---	60.00	16.71	N	OFF	20.4
6.428850	---	35.93	50.00	14.07	N	OFF	20.4
6.428850	44.78	---	60.00	15.22	N	OFF	20.4
8.447487	---	37.29	50.00	12.71	N	OFF	20.4
8.447487	46.85	---	60.00	13.15	N	OFF	20.4
13.513740	---	32.58	50.00	17.42	N	OFF	20.5
13.513740	38.75	---	60.00	21.25	N	OFF	20.5



Appendix C. Radiated Spurious Emission

Test Engineer :	Michael Bui and Daniel Lee	Temperature :	20~23.1°C
		Relative Humidity :	40~43.2%

<Radio 2>

MIMO <Ant. A+D+B+C>

UNII-3 - 5725~5850MHz

WIFI 802.11a (Band Edge @ 3m)

WIFI	Note	Frequency (MHz)	Level (dBµV/m)	Over Limit (dB)	Limit Line (dBµV/m)	Read Level (dBµV)	Antenna Factor (dB/m)	Path Loss (dB)	Preamp Factor (dB)	Ant Pos (cm)	Table Pos (deg)	Peak Avg. (P/A)	Pol. (H/V)	
802.11a CH 149 5745MHz		5648.6	56.91	-11.29	68.2	43.36	31.95	11.71	30.11	260	79	P	H	
		5657.2	56.8	-16.75	73.55	43.24	31.96	11.72	30.12	260	79	P	H	
		5720	67.99	-42.81	110.8	54.27	32.1	11.78	30.16	260	79	P	H	
		5725	79.13	-43.07	122.2	65.4	32.12	11.78	30.17	260	79	P	H	
	*	5745	122.47	-	-	108.68	32.18	11.78	30.17	260	79	P	H	
	*	5745	113.59	-	-	99.8	32.18	11.78	30.17	260	79	A	H	
			5647.4	57.36	-10.84	68.2	43.74	32.02	11.71	30.11	273	354	P	V
			5698.6	65.23	-38.94	104.17	51.49	32.12	11.78	30.16	273	354	P	V
			5718.6	79.76	-30.65	110.41	65.98	32.16	11.78	30.16	273	354	P	V
			5724.4	83.56	-37.27	120.83	69.77	32.17	11.78	30.16	273	354	P	V
	*		5745	124.35	-	-	110.52	32.22	11.78	30.17	273	354	P	V
	*		5745	116.34	-	-	102.51	32.22	11.78	30.17	273	354	A	V



WIFI	Note	Frequency (MHz)	Level (dBµV/m)	Over Limit (dB)	Limit Line (dBµV/m)	Read Level (dBµV)	Antenna Factor (dB/m)	Path Loss (dB)	Preamp Factor (dB)	Ant Pos (cm)	Table Pos (deg)	Peak Avg. (P/A)	Pol. (H/V)	
802.11a CH 157 5785MHz		5642.6	55.03	-13.17	68.2	41.48	31.95	11.71	30.11	235	163	P	H	
		5694.6	56.62	-44.6	101.22	42.97	32.03	11.77	30.15	235	163	P	H	
		5709.8	55.46	-52.49	107.95	41.77	32.07	11.78	30.16	235	163	P	H	
		5722.8	54.65	-62.53	117.18	40.92	32.11	11.78	30.16	235	163	P	H	
	*	5785	121.75	-	-	107.81	32.33	11.78	30.17	235	163	P	H	
	*	5785	113.66	-	-	99.72	32.33	11.78	30.17	235	163	A	H	
		5851.4	53.71	-65.3	119.01	39.58	32.44	11.87	30.18	235	163	P	H	
		5859.6	54.14	-55.37	109.51	39.99	32.45	11.89	30.19	235	163	P	H	
		5916.6	54.94	-19.45	74.39	40.69	32.51	11.98	30.24	235	163	P	H	
		5935.4	53.54	-14.66	68.2	39.25	32.53	12	30.24	235	163	P	H	
			5649	56.25	-11.95	68.2	42.63	32.02	11.71	30.11	278	350	P	V
			5684.4	57.6	-36.09	93.69	43.89	32.09	11.76	30.14	278	350	P	V
			5719.2	55.37	-55.21	110.58	41.59	32.16	11.78	30.16	278	350	P	V
			5724.8	55.93	-65.81	121.74	42.13	32.18	11.78	30.16	278	350	P	V
	*		5785	123.08	-	-	109.2	32.27	11.78	30.17	278	350	P	V
	*		5785	115.57	-	-	101.69	32.27	11.78	30.17	278	350	A	V
			5851.4	54.17	-64.84	119.01	40.02	32.46	11.87	30.18	278	350	P	V
			5871	54.62	-51.7	106.32	40.39	32.52	11.91	30.2	278	350	P	V
		5877	56.09	-47.62	103.71	41.85	32.53	11.92	30.21	278	350	P	V	
		5937	54.29	-13.91	68.2	39.89	32.64	12	30.24	278	350	P	V	



WIFI	Note	Frequency (MHz)	Level (dBµV/m)	Over Limit (dB)	Limit Line (dBµV/m)	Read Level (dBµV)	Antenna Factor (dB/m)	Path Loss (dB)	Preamp Factor (dB)	Ant Pos (cm)	Table Pos (deg)	Peak Avg. (P/A)	Pol. (H/V)	
802.11a CH 165 5825MHz	*	5825	120.5	-	-	106.44	32.41	11.82	30.17	270	76	P	H	
	*	5825	111.72	-	-	97.66	32.41	11.82	30.17	270	76	A	H	
		5850	72.43	-49.77	122.2	58.3	32.44	11.87	30.18	270	76	P	H	
		5855.6	67.28	-43.35	110.63	53.14	32.45	11.88	30.19	270	76	P	H	
		5877.6	54.69	-48.58	103.27	40.51	32.47	11.92	30.21	270	76	P	H	
		5948.4	53.48	-14.72	68.2	39.16	32.55	12.02	30.25	270	76	P	H	
	*	5825	123.99	-	-	109.97	32.37	11.82	30.17	266	349	P	V	
	*	5825	115.61	-	-	101.59	32.37	11.82	30.17	266	349	A	V	
		5854.4	79.25	-32.92	112.17	65.08	32.47	11.88	30.18	266	349	P	V	
		5855.6	79.65	-30.98	110.63	65.49	32.47	11.88	30.19	266	349	P	V	
		5875	65.02	-40.18	105.2	50.78	32.53	11.91	30.2	266	349	P	V	
		5941	54.05	-14.15	68.2	39.65	32.64	12.01	30.25	266	349	P	V	
Remark	1. No other spurious found. 2. All results are PASS against Peak and Average limit line.													



UNII-3 5725~5850MHz
WIFI 802.11a (Harmonic @ 3m)

WIFI	Note	Frequency (MHz)	Level (dBµV/m)	Over Limit (dB)	Limit Line (dBµV/m)	Read Level (dBµV)	Antenna Factor (dB/m)	Path Loss (dB)	Preamp Factor (dB)	Ant Pos (cm)	Table Pos (deg)	Peak Avg. (P/A)	Pol. (H/V)	
802.11a CH 149 5745MHz		11490	60.4	-13.6	74	70.25	40.14	17.61	67.6	399	126	P	H	
		11490	49.28	-4.72	54	59.13	40.14	17.61	67.6	399	126	A	H	
		13369	50.02	-23.98	74	58.92	39.56	19.23	67.69	-	-	P	H	
		13369	42.87	-11.13	54	51.77	39.56	19.23	67.69	-	-	A	H	
		14491	52.44	-21.56	74	58.38	41.76	20.04	67.74	-	-	P	H	
		14491	42.96	-11.04	54	48.9	41.76	20.04	67.74	-	-	A	H	
		17235	49.71	-18.49	68.2	56.84	39.77	22.17	69.07	-	-	P	H	
		18000	60.22	-13.78	74	58.2	48.43	23.01	69.42	-	-	P	H	
		18000	50.32	-3.68	54	48.3	48.43	23.01	69.42	-	-	A	H	
			11490	62.33	-11.67	74	72.08	40.24	17.61	67.6	100	117	P	V
			11490	53.59	-0.41	54	63.34	40.24	17.61	67.6	100	117	A	V
			13336	49.88	-24.12	74	58.92	39.46	19.21	67.71	-	-	P	V
			13336	40.99	-13.01	54	50.03	39.46	19.21	67.71	-	-	A	V
			14491	51.69	-22.31	74	57.76	41.63	20.04	67.74	-	-	P	V
			14491	42.84	-11.16	54	48.91	41.63	20.04	67.74	-	-	A	V
			17235	49.93	-18.27	68.2	56.88	39.95	22.17	69.07	-	-	P	V
			17967	60.1	-13.9	74	59.3	47.25	22.97	69.42	-	-	P	V
		17967	50.19	-3.81	54	49.39	47.25	22.97	69.42	-	-	A	V	



WIFI	Note	Frequency (MHz)	Level (dBμV/m)	Over Limit (dB)	Limit Line (dBμV/m)	Read Level (dBμV)	Antenna Factor (dB/m)	Path Loss (dB)	Preamp Factor (dB)	Ant Pos (cm)	Table Pos (deg)	Peak Avg. (P/A)	Pol. (H/V)	
802.11a CH 157 5785MHz		11570	59.22	-14.78	74	69.06	40.1	17.68	67.62	400	126	P	H	
		11570	49.72	-4.28	54	59.56	40.1	17.68	67.62	400	126	A	H	
		13303	49.72	-24.28	74	58.95	39.32	19.18	67.73	-	-	P	H	
		13303	43.02	-10.98	54	52.25	39.32	19.18	67.73	-	-	A	H	
		14491	51.56	-22.44	74	57.5	41.76	20.04	67.74	-	-	P	H	
		14491	43.92	-10.08	54	49.86	41.76	20.04	67.74	-	-	A	H	
		17355	50.01	-18.19	68.2	56.38	40.54	22.3	69.21	-	-	P	H	
		17989	60.23	-13.77	74	58.5	48.15	23	69.42	-	-	P	H	
		17989	50.13	-3.87	54	48.4	48.15	23	69.42	-	-	A	H	
			11570	60.87	-13.13	74	70.73	40.08	17.68	67.62	100	244	P	V
			11570	53.45	-0.55	54	63.31	40.08	17.68	67.62	100	244	A	V
			13358	49.64	-24.36	74	58.57	39.55	19.22	67.7	-	-	P	V
			13358	43.12	-10.88	54	52.05	39.55	19.22	67.7	-	-	A	V
			14491	51.04	-22.96	74	57.11	41.63	20.04	67.74	-	-	P	V
			14491	43.71	-10.29	54	49.78	41.63	20.04	67.74	-	-	A	V
			17355	50.49	-17.71	68.2	56.61	40.79	22.3	69.21	-	-	P	V
			17967	59.3	-14.7	74	58.5	47.25	22.97	69.42	-	-	P	V
		17967	49.5	-4.5	54	48.7	47.25	22.97	69.42	-	-	A	V	



WIFI	Note	Frequency (MHz)	Level (dBμV/m)	Over Limit (dB)	Limit Line (dBμV/m)	Read Level (dBμV)	Antenna Factor (dB/m)	Path Loss (dB)	Preamp Factor (dB)	Ant Pos (cm)	Table Pos (deg)	Peak Avg. (P/A)	Pol. (H/V)	
802.11a CH 165 5825MHz		11650	57.98	-16.02	74	68.18	39.69	17.76	67.65	400	244	P	H	
		11650	49.2	-4.8	54	59.4	39.69	17.76	67.65	400	244	A	H	
		13380	49.93	-24.07	74	58.77	39.6	19.24	67.68	-	-	P	H	
		13380	43.13	-10.87	54	51.97	39.6	19.24	67.68	-	-	A	H	
		14491	51.3	-22.7	74	57.24	41.76	20.04	67.74	-	-	P	H	
		14491	43.01	-10.99	54	48.95	41.76	20.04	67.74	-	-	A	H	
		17475	52.23	-15.97	68.2	57.52	41.64	22.43	69.36	-	-	P	H	
		18000	60.22	-13.78	74	58.2	48.43	23.01	69.42	-	-	P	H	
		18000	50.32	-3.68	54	48.3	48.43	23.01	69.42	-	-	A	H	
			11650	62.11	-11.89	74	72.19	39.81	17.76	67.65	100	246	P	V
			11650	53.36	-0.64	54	63.44	39.81	17.76	67.65	100	246	A	V
			13325	50.32	-23.68	74	59.42	39.42	19.2	67.72	-	-	P	V
			13325	42.62	-11.38	54	51.72	39.42	19.2	67.72	-	-	A	V
			14491	51.57	-22.43	74	57.64	41.63	20.04	67.74	-	-	P	V
			14491	43.17	-10.83	54	49.24	41.63	20.04	67.74	-	-	A	V
			17475	51.7	-16.5	68.2	56.93	41.7	22.43	69.36	-	-	P	V
			17967	59.2	-14.8	74	58.4	47.25	22.97	69.42	-	-	P	V
			17967	49.4	-4.6	54	48.6	47.25	22.97	69.42	-	-	A	V
Remark	<ol style="list-style-type: none"> No other spurious found. All results are PASS against Peak and Average limit line. The emission position marked as "-" means no suspected emission found and emission level has at least 6dB margin against limit or noise floor only. The emission level close to 18GHz is checked that the average emission level is noise floor only. 													



UNII-3 5725~5850MHz
WIFI 802.11ax HE20_Full (Band Edge @ 3m)

WIFI	Note	Frequency (MHz)	Level (dBμV/m)	Over Limit (dB)	Limit Line (dBμV/m)	Read Level (dBμV)	Antenna Factor (dB/m)	Path Loss (dB)	Preamp Factor (dB)	Ant Pos (cm)	Table Pos (deg)	Peak Avg. (P/A)	Pol. (H/V)	
802.11ax HE20 Full CH 149 5745MHz		5640.4	55.46	-12.74	68.2	41.91	31.96	11.7	30.11	250	162	P	H	
		5699.6	59.46	-45.45	104.91	45.8	32.04	11.78	30.16	250	162	P	H	
		5719.6	76.1	-34.59	110.69	62.38	32.1	11.78	30.16	250	162	P	H	
		5723.2	77.19	-40.91	118.1	63.46	32.11	11.78	30.16	250	162	P	H	
	*	5745	124.12	-	-	110.33	32.18	11.78	30.17	250	162	P	H	
	*	5745	112.63	-	-	98.84	32.18	11.78	30.17	250	162	A	H	
			5642.2	57.49	-10.71	68.2	43.88	32.02	11.7	30.11	273	350	P	V
			5700	65.17	-40.03	105.2	51.43	32.12	11.78	30.16	273	350	P	V
			5720	81.92	-28.88	110.8	68.14	32.16	11.78	30.16	273	350	P	V
			5725	83.97	-38.23	122.2	70.18	32.18	11.78	30.17	273	350	P	V
	*		5745	126.25	-	-	112.42	32.22	11.78	30.17	273	350	P	V
	*		5745	115.6	-	-	101.77	32.22	11.78	30.17	273	350	A	V



WIFI	Note	Frequency (MHz)	Level (dBμV/m)	Over Limit (dB)	Limit Line (dBμV/m)	Read Level (dBμV)	Antenna Factor (dB/m)	Path Loss (dB)	Preamp Factor (dB)	Ant Pos (cm)	Table Pos (deg)	Peak Avg. (P/A)	Pol. (H/V)	
802.11ax HE20 Full CH 157 5785MHz		5633.6	55	-13.2	68.2	41.46	31.96	11.69	30.11	301	81	P	H	
		5681.4	56.71	-34.76	91.47	43.08	32.01	11.76	30.14	301	81	P	H	
		5715	54.95	-54.45	109.4	41.24	32.09	11.78	30.16	301	81	P	H	
		5721.2	55.63	-57.91	113.54	41.9	32.11	11.78	30.16	301	81	P	H	
	*	5785	121.08	-	-	107.14	32.33	11.78	30.17	301	81	P	H	
	*	5785	112.03	-	-	98.09	32.33	11.78	30.17	301	81	A	H	
		5851.2	54.48	-64.98	119.46	40.35	32.44	11.87	30.18	301	81	P	H	
		5866.6	55.09	-52.46	107.55	40.93	32.46	11.9	30.2	301	81	P	H	
		5905.4	54.59	-28.08	82.67	40.35	32.5	11.97	30.23	301	81	P	H	
		5945.6	54.69	-13.51	68.2	40.38	32.55	12.01	30.25	301	81	P	H	



WIFI	Note	Frequency (MHz)	Level (dBμV/m)	Over Limit (dB)	Limit Line (dBμV/m)	Read Level (dBμV)	Antenna Factor (dB/m)	Path Loss (dB)	Preamp Factor (dB)	Ant Pos (cm)	Table Pos (deg)	Peak Avg. (P/A)	Pol. (H/V)	
802.11ax HE20 Full CH 165 5825MHz	*	5825	123.93	-	-	109.87	32.41	11.82	30.17	247	83	P	H	
	*	5825	113.27	-	-	99.21	32.41	11.82	30.17	247	83	A	H	
		5850	73.34	-48.86	122.2	59.21	32.44	11.87	30.18	247	83	P	H	
		5855	69.66	-41.14	110.8	55.52	32.44	11.88	30.18	247	83	P	H	
		5884.2	55.94	-42.43	98.37	41.74	32.48	11.93	30.21	247	83	P	H	
		5944	54.29	-13.91	68.2	39.99	32.54	12.01	30.25	247	83	P	H	
	*	5825	125.14	-	-	111.12	32.37	11.82	30.17	258	355	P	V	
	*	5825	114.65	-	-	100.63	32.37	11.82	30.17	258	355	A	V	
		5850.2	85.12	-36.62	121.74	70.98	32.45	11.87	30.18	258	355	P	V	
		5857	77.2	-33.04	110.24	63.04	32.47	11.88	30.19	258	355	P	V	
		5877.6	65.18	-38.09	103.27	50.93	32.54	11.92	30.21	258	355	P	V	
		5928.4	54.28	-13.92	68.2	39.9	32.63	11.99	30.24	258	355	P	V	
Remark	1. No other spurious found. 2. All results are PASS against Peak and Average limit line.													



UNII-3 5725~5850MHz
WIFI 802.11ax HE20 Full (Harmonic @ 3m)

WIFI	Note	Frequency (MHz)	Level (dBµV/m)	Over Limit (dB)	Limit Line (dBµV/m)	Read Level (dBµV)	Antenna Factor (dB/m)	Path Loss (dB)	Preamp Factor (dB)	Ant Pos (cm)	Table Pos (deg)	Peak Avg. (P/A)	Pol. (H/V)	
802.11ax HE20 Full CH 149 5745MHz		11490	57.96	-16.04	74	67.81	40.14	17.61	67.6	315	342	P	H	
		11490	48.81	-5.19	54	58.66	40.14	17.61	67.6	315	342	A	H	
		13314	49.53	-24.47	74	58.69	39.37	19.19	67.72	-	-	P	H	
		13314	42.17	-11.83	54	51.33	39.37	19.19	67.72	-	-	A	H	
		14491	51.17	-22.83	74	57.11	41.76	20.04	67.74	-	-	P	H	
		14491	43.16	-10.84	54	49.1	41.76	20.04	67.74	-	-	A	H	
		17325	50.73	-17.47	68.2	57.3	40.35	22.26	69.18	-	-	P	H	
		18000	60.32	-13.68	74	58.3	48.43	23.01	69.42	-	-	P	H	
		18000	50.42	-3.58	54	48.4	48.43	23.01	69.42	-	-	A	H	
			11490	61.52	-12.48	74	71.27	40.24	17.61	67.6	100	116	P	V
			11490	52.59	-1.41	54	62.34	40.24	17.61	67.6	100	116	A	V
			13292	49.51	-24.49	74	58.79	39.28	19.17	67.73	-	-	P	V
			13292	42.79	-11.21	54	52.07	39.28	19.17	67.73	-	-	A	V
			14491	50.41	-23.59	74	56.48	41.63	20.04	67.74	-	-	P	V
			14491	42.72	-11.28	54	48.79	41.63	20.04	67.74	-	-	A	V
			17325	50.43	-17.77	68.2	56.77	40.58	22.26	69.18	-	-	P	V
		17989	59.73	-14.27	74	58.39	47.76	23	69.42	-	-	P	V	
		17989	49.93	-4.07	54	48.59	47.76	23	69.42	-	-	A	V	



WIFI	Note	Frequency (MHz)	Level (dBµV/m)	Over Limit (dB)	Limit Line (dBµV/m)	Read Level (dBµV)	Antenna Factor (dB/m)	Path Loss (dB)	Preamp Factor (dB)	Ant Pos (cm)	Table Pos (deg)	Peak Avg. (P/A)	Pol. (H/V)	
802.11ax HE20 Full CH 157 5785MHz		11570	58.07	-15.93	74	67.91	40.1	17.68	67.62	325	340	P	H	
		11570	49.07	-4.93	54	58.91	40.1	17.68	67.62	325	340	A	H	
		13303	50	-24	74	59.23	39.32	19.18	67.73	-	-	P	H	
		13303	43.08	-10.92	54	52.31	39.32	19.18	67.73	-	-	A	H	
		14491	52.13	-21.87	74	58.07	41.76	20.04	67.74	-	-	P	H	
		14491	43.13	-10.87	54	49.07	41.76	20.04	67.74	-	-	A	H	
		17355	51.53	-16.67	68.2	57.9	40.54	22.3	69.21	-	-	P	H	
		17989	60.03	-13.97	74	58.3	48.15	23	69.42	-	-	P	H	
		17989	50.23	-3.77	54	48.5	48.15	23	69.42	-	-	A	H	
			11570	61.69	-12.31	74	71.55	40.08	17.68	67.62	100	245	P	V
			11570	53.43	-0.57	54	63.29	40.08	17.68	67.62	100	245	A	V
			13358	50.19	-23.81	74	59.12	39.55	19.22	67.7	-	-	P	V
			13358	42.86	-11.14	54	51.79	39.55	19.22	67.7	-	-	A	V
			14491	52.23	-21.77	74	58.3	41.63	20.04	67.74	-	-	P	V
			14491	43.31	-10.69	54	49.38	41.63	20.04	67.74	-	-	A	V
			17355	51.38	-16.82	68.2	57.5	40.79	22.3	69.21	-	-	P	V
		17989	59.83	-14.17	74	58.49	47.76	23	69.42	-	-	P	V	
		17989	49.53	-4.47	54	48.19	47.76	23	69.42	-	-	A	V	



WIFI	Note	Frequency (MHz)	Level (dBμV/m)	Over Limit (dB)	Limit Line (dBμV/m)	Read Level (dBμV)	Antenna Factor (dB/m)	Path Loss (dB)	Preamp Factor (dB)	Ant Pos (cm)	Table Pos (deg)	Peak Avg. (P/A)	Pol. (H/V)	
802.11ax HE20 Full CH 165 5825MHz		11650	59.19	-14.81	74	69.39	39.69	17.76	67.65	320	348	P	H	
		11650	50.49	-3.51	54	60.69	39.69	17.76	67.65	320	348	A	H	
		13380	50.13	-23.87	74	58.97	39.6	19.24	67.68	-	-	P	H	
		13380	42.6	-11.4	54	51.44	39.6	19.24	67.68	-	-	A	H	
		14491	50.92	-23.08	74	56.86	41.76	20.04	67.74	-	-	P	H	
		14491	43.01	-10.99	54	48.95	41.76	20.04	67.74	-	-	A	H	
		17475	52.46	-15.74	68.2	57.75	41.64	22.43	69.36	-	-	P	H	
		17989	60.13	-13.87	74	58.4	48.15	23	69.42	-	-	P	H	
		17989	50.03	-3.97	54	48.3	48.15	23	69.42	-	-	A	H	
			11650	61.82	-12.18	74	71.9	39.81	17.76	67.65	100	247	P	V
			11650	53.69	-0.31	54	63.77	39.81	17.76	67.65	100	247	A	V
			13380	49.91	-24.09	74	58.75	39.6	19.24	67.68	-	-	P	V
			13380	42.9	-11.1	54	51.74	39.6	19.24	67.68	-	-	A	V
			14491	50.88	-23.12	74	56.95	41.63	20.04	67.74	-	-	P	V
			14491	43.33	-10.67	54	49.4	41.63	20.04	67.74	-	-	A	V
			17475	51.81	-16.39	68.2	57.04	41.7	22.43	69.36	-	-	P	V
		17978	59.57	-14.43	74	58.5	47.5	22.99	69.42	-	-	P	V	
		17978	49.67	-4.33	54	48.6	47.5	22.99	69.42	-	-	A	V	
Remark	<ol style="list-style-type: none"> No other spurious found. All results are PASS against Peak and Average limit line. The emission position marked as "-" means no suspected emission found and emission level has at least 6dB margin against limit or noise floor only. The emission level close to 18GHz is checked that the average emission level is noise floor only. 													



UNII-3 - 5725~5850MHz

WIFI 802.11ax HE20_Partial RU 52 (Band Edge @ 3m)

WIFI	Note	Frequency	Level	Margin	Limit	Read	Antenna	Path	Preamp	Ant	Table	Peak	Pol.	
Ant.		(MHz)	(dBμV/m)	(dB)	(dBμV/m)	(dBμV)	(dB/m)	(dB)	(dB)	(cm)	(deg)	(P/A)	(H/V)	
802.11ax HE20 Partial RU 52_52_52_ 52 CH 149 5745MHz		5643	56.14	-12.06	68.2	40.85	33.25	12.44	30.4	400	150	P	H	
		5696.4	69.92	-32.63	102.55	54.39	33.44	12.51	30.42	400	150	P	H	
		5719.4	85.33	-25.30	110.63	69.63	33.58	12.54	30.42	400	150	P	H	
		5722.2	87.79	-28.03	115.82	72.07	33.6	12.54	30.42	400	150	P	H	
	*	5745	116.4	-	-	100.49	33.76	12.57	30.42	400	150	P	H	
	*	5745	110.32	-	-	94.41	33.76	12.57	30.42	400	150	A	H	
														H
														H
			5639.6	55.97	-12.23	68.2	40.69	33.25	12.43	30.4	277	33	P	V
			5696.6	69.35	-33.34	102.69	53.82	33.44	12.51	30.42	277	33	P	V
			5718.4	81.45	-28.90	110.35	65.76	33.58	12.53	30.42	277	33	P	V
			5724.8	87.88	-33.86	121.74	72.14	33.62	12.54	30.42	277	33	P	V
	*		5745	116.68	-	-	100.77	33.76	12.57	30.42	277	33	P	V
	*		5745	108.93	-	-	93.02	33.76	12.57	30.42	277	33	A	V
													V	
													V	



WIFI Ant.	Note	Frequency (MHz)	Level (dBμV/m)	Margin (dB)	Limit Line (dBμV/m)	Read Level (dBμV)	Antenna Factor (dB/m)	Path Loss (dB)	Preamp Factor (dB)	Ant Pos (cm)	Table Pos (deg)	Peak Avg. (P/A)	Pol. (H/V)	
802.11ax HE20 Partial RU 52_52_52_ 52 CH 165 5825MHz	*	5825	118.51	-	-	102.1	34.19	12.67	30.45	394	149	P	H	
	*	5825	111.39	-	-	94.98	34.19	12.67	30.45	394	149	A	H	
		5851.8	88.69	-29.41	118.1	72.23	34.23	12.7	30.47	394	149	P	H	
		5855.4	81.12	-29.57	110.69	64.66	34.23	12.7	30.47	394	149	P	H	
		5875	67.71	-37.49	105.2	51.24	34.24	12.72	30.49	394	149	P	H	
		5931.6	56.08	-12.12	68.2	39.6	34.21	12.78	30.51	394	149	P	H	
														H
														H
	*	5825	116.12	-	-	99.71	34.19	12.67	30.45	273	23	P	V	
	*	5825	109.35	-	-	92.94	34.19	12.67	30.45	273	23	A	V	
		5850.4	86.64	-34.65	121.29	70.18	34.23	12.7	30.47	273	23	P	V	
		5855.4	80.09	-30.60	110.69	63.63	34.23	12.7	30.47	273	23	P	V	
		5877	70.31	-33.40	103.71	53.84	34.24	12.72	30.49	273	23	P	V	
		5928.4	55.43	-12.77	68.2	38.94	34.22	12.78	30.51	273	23	P	V	
														V
													V	
Remark	1. No other spurious found. 2. All results are PASS against Peak and Average limit line.													



UNII-3 5725~5850MHz
WIFI 802.11ax HE40_Full (Band Edge @ 3m)

WIFI	Note	Frequency (MHz)	Level (dBμV/m)	Over Limit (dB)	Limit Line (dBμV/m)	Read Level (dBμV)	Antenna Factor (dB/m)	Path Loss (dB)	Preamp Factor (dB)	Ant Pos (cm)	Table Pos (deg)	Peak Avg. (P/A)	Pol. (H/V)	
802.11ax HE40 Full CH 151 5755MHz		5640.6	57.38	-10.82	68.2	43.83	31.96	11.7	30.11	260	81	P	H	
		5697.2	77.02	-26.12	103.14	63.36	32.04	11.78	30.16	260	81	P	H	
		5718.2	88.71	-21.59	110.3	74.99	32.1	11.78	30.16	260	81	P	H	
		5720	88	-22.8	110.8	74.28	32.1	11.78	30.16	260	81	P	H	
	*	5755	120.02	-	-	106.2	32.21	11.78	30.17	260	81	P	H	
	*	5755	111.46	-	-	97.64	32.21	11.78	30.17	260	81	A	H	
		5854.4	56.1	-56.07	112.17	41.96	32.44	11.88	30.18	260	81	P	H	
		5866.2	57.59	-50.07	107.66	43.43	32.46	11.9	30.2	260	81	P	H	
		5921.8	55.15	-15.41	70.56	40.88	32.52	11.99	30.24	260	81	P	H	
		5934.2	54.42	-13.78	68.2	40.13	32.53	12	30.24	260	81	P	H	
			5648.6	60.88	-7.32	68.2	47.26	32.02	11.71	30.11	297	352	P	V
			5695.2	76.97	-24.69	101.66	63.25	32.11	11.77	30.16	297	352	P	V
			5716.2	87.08	-22.66	109.74	73.3	32.16	11.78	30.16	297	352	P	V
			5721.6	92.33	-22.12	114.45	78.54	32.17	11.78	30.16	297	352	P	V
	*		5755	121.02	-	-	107.17	32.24	11.78	30.17	297	352	P	V
	*		5755	113.4	-	-	99.55	32.24	11.78	30.17	297	352	A	V
			5850	63.63	-58.57	122.2	49.49	32.45	11.87	30.18	297	352	P	V
			5856.8	63.17	-47.13	110.3	49.01	32.47	11.88	30.19	297	352	P	V
		5876.2	58.83	-45.48	104.31	44.59	32.53	11.92	30.21	297	352	P	V	
		5941	54.5	-13.7	68.2	40.1	32.64	12.01	30.25	297	352	P	V	



WIFI	Note	Frequency (MHz)	Level (dBμV/m)	Over Limit (dB)	Limit Line (dBμV/m)	Read Level (dBμV)	Antenna Factor (dB/m)	Path Loss (dB)	Preamp Factor (dB)	Ant Pos (cm)	Table Pos (deg)	Peak Avg. (P/A)	Pol. (H/V)	
802.11ax HE40 Full CH 159 5795MHz		5644.2	56.02	-12.18	68.2	42.47	31.95	11.71	30.11	271	28	P	H	
		5695.8	65.54	-36.56	102.1	51.9	32.03	11.77	30.16	271	28	P	H	
		5714.8	74.57	-34.78	109.35	60.86	32.09	11.78	30.16	271	28	P	H	
		5724.8	68.97	-52.77	121.74	55.23	32.12	11.78	30.16	271	28	P	H	
	*	5795	121.6	-	-	107.62	32.37	11.78	30.17	271	28	P	H	
	*	5795	111.62	-	-	97.64	32.37	11.78	30.17	271	28	A	H	
		5853.8	71.54	-42	113.54	57.4	32.44	11.88	30.18	271	28	P	H	
		5856.4	71.92	-38.49	110.41	57.78	32.45	11.88	30.19	271	28	P	H	
		5876.2	63.34	-40.97	104.31	49.16	32.47	11.92	30.21	271	28	P	H	
		5945.2	54.89	-13.31	68.2	40.58	32.55	12.01	30.25	271	28	P	H	
			5645.4	56.18	-12.02	68.2	42.56	32.02	11.71	30.11	279	352	P	V
			5696	62.89	-39.36	102.25	49.17	32.11	11.77	30.16	279	352	P	V
			5714.6	72.64	-36.65	109.29	58.87	32.15	11.78	30.16	279	352	P	V
			5723.6	75.81	-43.2	119.01	62.02	32.17	11.78	30.16	279	352	P	V
	*		5795	121.39	-	-	107.5	32.28	11.78	30.17	279	352	P	V
	*		5795	112.99	-	-	99.1	32.28	11.78	30.17	279	352	A	V
			5850	77.58	-44.62	122.2	63.44	32.45	11.87	30.18	279	352	P	V
			5856.2	76.28	-34.18	110.46	62.12	32.47	11.88	30.19	279	352	P	V
		5875.6	70.6	-34.15	104.75	56.36	32.53	11.92	30.21	279	352	P	V	
		5934.2	55.03	-13.17	68.2	40.63	32.64	12	30.24	279	352	P	V	
Remark	1. No other spurious found. 2. All results are PASS against Peak and Average limit line.													



UNII-3 5725~5850MHz
WIFI 802.11ax HE40_Full (Harmonic @ 3m)

WIFI	Note	Frequency (MHz)	Level (dBµV/m)	Over Limit (dB)	Limit Line (dBµV/m)	Read Level (dBµV)	Antenna Factor (dB/m)	Path Loss (dB)	Preamp Factor (dB)	Ant Pos (cm)	Table Pos (deg)	Peak Avg. (P/A)	Pol. (H/V)	
802.11ax HE40 Full CH 151 5755MHz		11510	55.2	-18.8	74	56.69	40.15	17.63	59.27	400	290	P	H	
		11510	47.4	-6.6	54	48.89	40.15	17.63	59.27	400	290	A	H	
		13369	51.59	-22.41	74	53.77	39.56	19.23	60.97	-	-	P	H	
		13369	42.38	-11.62	54	44.56	39.56	19.23	60.97	-	-	A	H	
		14491	51.92	-22.08	74	51.41	41.76	20.04	61.29	-	-	P	H	
		14491	40.46	-13.54	54	39.95	41.76	20.04	61.29	-	-	A	H	
		17265	51.67	-16.53	68.2	47.56	39.94	22.2	58.03	-	-	P	H	
		18000	60.88	-13.12	74	45.6	48.43	23.01	56.16	-	-	P	H	
		18000	50.18	-3.82	54	34.9	48.43	23.01	56.16	-	-	A	H	
			11510	60.45	-13.55	74	61.86	40.23	17.63	59.27	100	243	P	V
			11510	53.14	-0.86	54	54.55	40.23	17.63	59.27	100	243	A	V
			13391	52.57	-21.43	74	54.66	39.63	19.25	60.97	-	-	P	V
			13391	41.77	-12.23	54	43.86	39.63	19.25	60.97	-	-	A	V
			14491	52.26	-21.74	74	51.88	41.63	20.04	61.29	-	-	P	V
			14491	39.85	-14.15	54	39.47	41.63	20.04	61.29	-	-	A	V
			17265	53	-15.2	68.2	48.69	40.14	22.2	58.03	-	-	P	V
		17989	60.66	-13.34	74	46.09	47.76	23	56.19	-	-	P	V	
		17989	49.76	-4.24	54	35.19	47.76	23	56.19	-	-	A	V	



WIFI	Note	Frequency (MHz)	Level (dBμV/m)	Over Limit (dB)	Limit Line (dBμV/m)	Read Level (dBμV)	Antenna Factor (dB/m)	Path Loss (dB)	Preamp Factor (dB)	Ant Pos (cm)	Table Pos (deg)	Peak Avg. (P/A)	Pol. (H/V)	
802.11ax HE40 Full CH 159 5795MHz		11590	56.47	-17.53	74	58.09	40.03	17.7	59.35	400	288	P	H	
		11590	48.47	-5.53	54	50.09	40.03	17.7	59.35	400	288	A	H	
		13380	51.5	-22.5	74	53.63	39.6	19.24	60.97	-	-	P	H	
		13380	42.95	-11.05	54	45.08	39.6	19.24	60.97	-	-	A	H	
		14491	51.93	-22.07	74	51.42	41.76	20.04	61.29	-	-	P	H	
		14491	41.68	-12.32	54	41.17	41.76	20.04	61.29	-	-	A	H	
		17385	54.19	-14.01	68.2	48.69	40.78	22.33	57.61	-	-	P	H	
		17989	61.16	-12.84	74	46.2	48.15	23	56.19	-	-	P	H	
		17989	50.16	-3.84	54	35.2	48.15	23	56.19	-	-	A	H	
			11590	60.37	-13.63	74	62.04	39.98	17.7	59.35	100	244	P	V
			11590	53.41	-0.59	54	55.08	39.98	17.7	59.35	100	244	A	V
			13369	51.6	-22.4	74	53.77	39.57	19.23	60.97	-	-	P	V
			13369	42.6	-11.4	54	44.77	39.57	19.23	60.97	-	-	A	V
			14491	52.04	-21.96	74	51.66	41.63	20.04	61.29	-	-	P	V
			14491	41.94	-12.06	54	41.56	41.63	20.04	61.29	-	-	A	V
			17385	53.78	-14.42	68.2	48.02	41.04	22.33	57.61	-	-	P	V
		17967	60.57	-13.43	74	46.6	47.25	22.97	56.25	-	-	P	V	
		17967	49.67	-4.33	54	35.7	47.25	22.97	56.25	-	-	A	V	
Remark	<ol style="list-style-type: none"> No other spurious found. All results are PASS against Peak and Average limit line. The emission position marked as "-" means no suspected emission found and emission level has at least 6dB margin against limit or noise floor only. The emission level close to 18GHz is checked that the average emission level is noise floor only. 													



UNII-3 5725~5850MHz
WIFI 802.11ax HE80_Full (Band Edge @ 3m)

WIFI	Note	Frequency (MHz)	Level (dBμV/m)	Over Limit (dB)	Limit Line (dBμV/m)	Read Level (dBμV)	Antenna Factor (dB/m)	Path Loss (dB)	Preamp Factor (dB)	Ant Pos (cm)	Table Pos (deg)	Peak Avg. (P/A)	Pol. (H/V)	
802.11ax HE80 Full CH 155 5775MHz		5640.6	65.05	-3.15	68.2	51.5	31.96	11.7	30.11	244	81	P	H	
		5695.4	77.25	-24.56	101.81	63.61	32.03	11.77	30.16	244	81	P	H	
		5718	81.81	-28.43	110.24	68.09	32.1	11.78	30.16	244	81	P	H	
		5721.6	78.41	-36.04	114.45	64.68	32.11	11.78	30.16	244	81	P	H	
	*	5775	117.5	-	-	103.6	32.29	11.78	30.17	244	81	P	H	
	*	5775	107.13	-	-	93.23	32.29	11.78	30.17	244	81	A	H	
		5855	72.2	-38.6	110.8	58.06	32.44	11.88	30.18	244	81	P	H	
		5855.4	76.93	-33.76	110.69	62.8	32.44	11.88	30.19	244	81	P	H	
		5876.8	65.28	-38.58	103.86	51.1	32.47	11.92	30.21	244	81	P	H	
		5946.4	54.48	-13.72	68.2	40.16	32.55	12.02	30.25	244	81	P	H	
			5642.4	66.15	-2.05	68.2	52.53	32.02	11.71	30.11	298	351	P	V
			5695	76.19	-25.32	101.51	62.47	32.11	11.77	30.16	298	351	P	V
			5716.6	81.57	-28.28	109.85	67.79	32.16	11.78	30.16	298	351	P	V
			5722.2	83.28	-32.54	115.82	69.49	32.17	11.78	30.16	298	351	P	V
	*		5775	116.97	-	-	103.1	32.26	11.78	30.17	298	351	P	V
	*		5775	108.88	-	-	95.01	32.26	11.78	30.17	298	351	A	V
			5850	77.85	-44.35	122.2	63.71	32.45	11.87	30.18	298	351	P	V
			5857.4	77.73	-32.4	110.13	63.57	32.47	11.88	30.19	298	351	P	V
		5877	69.4	-34.31	103.71	55.16	32.53	11.92	30.21	298	351	P	V	
		5930.6	53.93	-14.27	68.2	39.54	32.63	12	30.24	298	351	P	V	
Remark	1. No other spurious found. 2. All results are PASS against Peak and Average limit line.													



UNII-3 5725~5850MHz
WIFI 802.11ax HE80_Full (Harmonic @ 3m)

WIFI	Note	Frequency (MHz)	Level (dBµV/m)	Over Limit (dB)	Limit Line (dBµV/m)	Read Level (dBµV)	Antenna Factor (dB/m)	Path Loss (dB)	Preamp Factor (dB)	Ant Pos (cm)	Table Pos (deg)	Peak Avg. (P/A)	Pol. (H/V)	
802.11ax HE80 Full CH 155 5775MHz		11550	55.95	-18.05	74	57.39	40.18	17.67	59.29	400	286	P	H	
		11550	48.35	-5.65	54	49.79	40.18	17.67	59.29	400	286	A	H	
		13270	51.82	-22.18	74	54.42	39.2	19.15	60.95	-	-	P	H	
		13270	42.03	-11.97	54	44.63	39.2	19.15	60.95	-	-	A	H	
		14491	53.03	-20.97	74	52.52	41.76	20.04	61.29	-	-	P	H	
		14491	42.28	-11.72	54	41.77	41.76	20.04	61.29	-	-	A	H	
		17325	53.29	-14.91	68.2	48.5	40.35	22.26	57.82	-	-	P	H	
		17945	61.48	-12.52	74	47.8	47.04	22.95	56.31	-	-	P	H	
		17945	49.98	-4.02	54	36.3	47.04	22.95	56.31	-	-	A	H	

Remark

- No other spurious found.
- All results are PASS against Peak and Average limit line.
- The emission position marked as "-" means no suspected emission found and emission level has at least 6dB margin against limit or noise floor only.
- The emission level close to 18GHz is checked that the average emission level is noise floor only.



Emission above 18GHz

5GHz WIFI 802.11ax HE20 Full (SHF @ 1m)

WIFI	Note	Frequency (MHz)	Level (dBμV/m)	Over Limit (dB)	Limit Line (dBμV/m)	Read Level (dBμV)	Antenna Factor (dB/m)	Path Loss (dB)	Preamp Factor (dB)	Ant Pos (cm)	Table Pos (deg)	Peak Avg. (P/A)	Pol. (H/V)
802.11ax HE20 Full CH165 5825MHz SHF		36480	47.14	-26.86	74	37.47	42.54	21.91	54.78	-	-	P	H
		39670	52.77	-21.23	74	37.77	44.75	24.37	54.12	-	-	P	H
		39670	45.04	-8.96	54	30.04	44.75	24.37	54.12	-	-	A	H
			36480	47.31	-26.69	74	37.59	42.59	21.91	54.78	-	-	P
		39802	52.93	-21.07	74	37.14	44.63	24.46	53.3	-	-	P	V
		39802	45.1	-8.9	54	29.31	44.63	24.46	53.3	-	-	A	V
Remark	<ol style="list-style-type: none"> No other spurious found. All results are PASS against Peak and Average limit line. The emission position marked as "-" means no suspected emission found and emission level has at least 6dB margin against limit or noise floor only. 												



**Emission below 1GHz
5GHz WIFI 802.11ax HE20 Full (LF @ 3m)**

WIFI	Note	Frequency (MHz)	Level (dBµV/m)	Over Limit (dB)	Limit Line (dBµV/m)	Read Level (dBµV)	Antenna Factor (dB/m)	Path Loss (dB)	Preamp Factor (dB)	Ant Pos (cm)	Table Pos (deg)	Peak Avg. (P/A)	Pol. (H/V)	
802.11ax HE20 Full CH165 5825MHz LF		62.01	30.74	-9.26	40	50.09	11.7	1.38	32.43	-	-	P	H	
		329.73	31.38	-14.62	46	41.14	19.69	3	32.45	-	-	P	H	
		420.91	32.05	-13.95	46	38.46	22.52	3.58	32.51	-	-	P	H	
		749.74	35.38	-10.62	46	35.11	27.99	4.66	32.38	-	-	P	H	
		874.87	38.16	-7.84	46	35.9	29.1	4.94	31.78	132	204	Q	H	
		874.87	41.66	-4.34	46	39.4	29.1	4.94	31.78	132	204	P	H	
		948.59	39.04	-6.96	46	34.36	30.67	5.22	31.21	-	-	P	H	
			39.7	33.81	-6.19	40	45.29	19.88	1.08	32.44	-	-	P	V
			62.01	33.78	-6.22	40	53.13	11.7	1.38	32.43	-	-	P	V
			423.82	37.64	-8.36	46	43.99	22.58	3.58	32.51	-	-	P	V
			746.83	35.24	-10.76	46	35.04	27.94	4.65	32.39	-	-	P	V
			874.87	37.83	-8.17	46	35.57	29.1	4.94	31.78	-	-	P	V
			936.95	35.78	-10.22	46	31.8	30.12	5.18	31.32	-	-	P	V
Remark	<ol style="list-style-type: none"> No other spurious found. All results are PASS against Peak and Average limit line. The emission position marked as "-" means no suspected emission found and emission level has at least 6dB margin against limit or noise floor only. 													



<Radio 3>

MIMO <Ant. E+H+F+G>

UNII-3 - 5725~5850MHz

WIFI 802.11a (Band Edge @ 3m)

WIFI	Note	Frequency	Level	Over Limit	Limit Line	Read Level	Antenna Factor	Path Loss	Preamp Factor	Ant Pos	Table Pos	Peak Avg.	Pol.	
		(MHz)	(dBμV/m)	(dB)	(dBμV/m)	(dBμV)	(dB/m)	(dB)	(dB)	(cm)	(deg)	(P/A)	(H/V)	
802.11a CH 149 5745MHz		5617.4	55.1	-13.1	68.2	41.57	31.98	11.67	30.12	303	299	P	H	
		5699.6	58.89	-46.02	104.91	45.23	32.04	11.78	30.16	303	299	P	H	
		5720	69.09	-41.71	110.8	55.37	32.1	11.78	30.16	303	299	P	H	
		5721.6	69.82	-44.63	114.45	56.09	32.11	11.78	30.16	303	299	P	H	
	*	5745	122.66	-	-	108.87	32.18	11.78	30.17	303	299	P	H	
	*	5745	115.62	-	-	101.83	32.18	11.78	30.17	303	299	A	H	
			5612.2	54.79	-13.41	68.2	41.2	32.04	11.67	30.12	298	39	P	V
			5695.8	55.02	-47.08	102.1	41.3	32.11	11.77	30.16	298	39	P	V
			5718.2	65.05	-45.25	110.3	51.27	32.16	11.78	30.16	298	39	P	V
			5722	64.03	-51.33	115.36	50.24	32.17	11.78	30.16	298	39	P	V
	*		5745	120.54	-	-	106.71	32.22	11.78	30.17	298	39	P	V
	*		5745	113.59	-	-	99.76	32.22	11.78	30.17	298	39	A	V



WIFI	Note	Frequency (MHz)	Level (dBμV/m)	Over Limit (dB)	Limit Line (dBμV/m)	Read Level (dBμV)	Antenna Factor (dB/m)	Path Loss (dB)	Preamp Factor (dB)	Ant Pos (cm)	Table Pos (deg)	Peak Avg. (P/A)	Pol. (H/V)	
802.11a CH 157 5785MHz		5644.8	54.95	-13.25	68.2	41.4	31.95	11.71	30.11	297	300	P	H	
		5657.6	54.55	-19.3	73.85	40.99	31.96	11.72	30.12	297	300	P	H	
		5716.4	53.89	-55.9	109.79	40.18	32.09	11.78	30.16	297	300	P	H	
		5720.2	55.11	-56.15	111.26	41.39	32.1	11.78	30.16	297	300	P	H	
	*	5785	121.74	-	-	107.8	32.33	11.78	30.17	297	300	P	H	
	*	5785	114.49	-	-	100.55	32.33	11.78	30.17	297	300	A	H	
		5851.4	54.15	-64.86	119.01	40.02	32.44	11.87	30.18	297	300	P	H	
		5874	53.76	-51.72	105.48	39.59	32.46	11.91	30.2	297	300	P	H	
		5880.8	54.63	-46.26	100.89	40.44	32.47	11.93	30.21	297	300	P	H	
		5939.8	54.38	-13.82	68.2	40.08	32.54	12.01	30.25	297	300	P	H	
			5614.8	55.73	-12.47	68.2	42.14	32.04	11.67	30.12	243	45	P	V
			5681.6	54.84	-36.78	91.62	41.14	32.08	11.76	30.14	243	45	P	V
			5709.2	54.09	-53.69	107.78	40.33	32.14	11.78	30.16	243	45	P	V
			5722.2	53.18	-62.64	115.82	39.39	32.17	11.78	30.16	243	45	P	V
	*		5785	120.44	-	-	106.56	32.27	11.78	30.17	243	45	P	V
	*		5785	113.49	-	-	99.61	32.27	11.78	30.17	243	45	A	V
			5855	53.84	-56.96	110.8	39.67	32.47	11.88	30.18	243	45	P	V
			5858.6	54.66	-55.13	109.79	40.48	32.48	11.89	30.19	243	45	P	V
		5905.4	54.16	-28.51	82.67	39.81	32.61	11.97	30.23	243	45	P	V	
		5949.6	54.89	-13.31	68.2	40.47	32.65	12.02	30.25	243	45	P	V	



WIFI	Note	Frequency (MHz)	Level (dBμV/m)	Over Limit (dB)	Limit Line (dBμV/m)	Read Level (dBμV)	Antenna Factor (dB/m)	Path Loss (dB)	Preamp Factor (dB)	Ant Pos (cm)	Table Pos (deg)	Peak Avg. (P/A)	Pol. (H/V)	
802.11a CH 165 5825MHz	*	5825	122.76	-	-	108.7	32.41	11.82	30.17	294	300	P	H	
	*	5825	115.31	-	-	101.25	32.41	11.82	30.17	294	300	A	H	
		5852.6	71.17	-45.1	116.27	57.04	32.44	11.87	30.18	294	300	P	H	
		5857.6	69.13	-40.94	110.07	54.99	32.45	11.88	30.19	294	300	P	H	
		5919.6	54.32	-17.86	72.18	40.06	32.52	11.98	30.24	294	300	P	H	
		5949.8	54.77	-13.43	68.2	40.45	32.55	12.02	30.25	294	300	P	H	
	*	5825	121.31	-	-	107.29	32.37	11.82	30.17	242	45	P	V	
	*	5825	114.33	-	-	100.31	32.37	11.82	30.17	242	45	A	V	
		5853	66.49	-48.87	115.36	52.33	32.46	11.88	30.18	242	45	P	V	
		5857.8	68.19	-41.82	110.01	54.02	32.48	11.88	30.19	242	45	P	V	
		5875.8	55.02	-49.59	104.61	40.78	32.53	11.92	30.21	242	45	P	V	
		5940	54.8	-13.4	68.2	40.4	32.64	12.01	30.25	242	45	P	V	
Remark	1. No other spurious found. 2. All results are PASS against Peak and Average limit line.													



UNII-3 5725~5850MHz
WIFI 802.11a (Harmonic @ 3m)

WIFI	Note	Frequency (MHz)	Level (dBµV/m)	Over Limit (dB)	Limit Line (dBµV/m)	Read Level (dBµV)	Antenna Factor (dB/m)	Path Loss (dB)	Preamp Factor (dB)	Ant Pos (cm)	Table Pos (deg)	Peak Avg. (P/A)	Pol. (H/V)	
802.11a CH 149 5745MHz		11490	56.53	-17.47	74	66.38	40.14	17.61	67.6	212	290	P	H	
		11490	45.59	-8.41	54	55.44	40.14	17.61	67.6	212	290	A	H	
		13358	50.76	-23.24	74	59.71	39.53	19.22	67.7	-	-	P	H	
		13358	43.1	-10.9	54	52.05	39.53	19.22	67.7	-	-	A	H	
		14491	52.88	-21.12	74	58.82	41.76	20.04	67.74	-	-	P	H	
		14491	43.25	-10.75	54	49.19	41.76	20.04	67.74	-	-	A	H	
		17235	51.2	-17	68.2	58.33	39.77	22.17	69.07	-	-	P	H	
		18000	59.07	-14.93	74	57.05	48.43	23.01	69.42	-	-	P	H	
		18000	50.68	-3.32	54	48.66	48.43	23.01	69.42	-	-	A	H	
			11490	57.16	-16.84	74	66.91	40.24	17.61	67.6	209	16	P	V
			11490	46.6	-7.4	54	56.35	40.24	17.61	67.6	209	16	A	V
			13358	50.38	-23.62	74	59.31	39.55	19.22	67.7	-	-	P	V
			13358	42.86	-11.14	54	51.79	39.55	19.22	67.7	-	-	A	V
			14491	51.74	-22.26	74	57.81	41.63	20.04	67.74	-	-	P	V
			14491	43.54	-10.46	54	49.61	41.63	20.04	67.74	-	-	A	V
			17235	49.97	-18.23	68.2	56.92	39.95	22.17	69.07	-	-	P	V
		18000	59.18	-14.82	74	57.58	48.01	23.01	69.42	-	-	P	V	
		18000	50.28	-3.72	54	48.68	48.01	23.01	69.42	-	-	A	V	



WIFI	Note	Frequency (MHz)	Level (dBμV/m)	Over Limit (dB)	Limit Line (dBμV/m)	Read Level (dBμV)	Antenna Factor (dB/m)	Path Loss (dB)	Preamp Factor (dB)	Ant Pos (cm)	Table Pos (deg)	Peak Avg. (P/A)	Pol. (H/V)	
802.11a CH 157 5785MHz		11570	58.36	-15.64	74	68.2	40.1	17.68	67.62	393	34	P	H	
		11570	47.78	-6.22	54	57.62	40.1	17.68	67.62	393	34	A	H	
		13303	49.54	-24.46	74	58.77	39.32	19.18	67.73	-	-	P	H	
		13303	42.83	-11.17	54	52.06	39.32	19.18	67.73	-	-	A	H	
		14491	51.18	-22.82	74	57.12	41.76	20.04	67.74	-	-	P	H	
		14491	42.97	-11.03	54	48.91	41.76	20.04	67.74	-	-	A	H	
		17355	51.19	-17.01	68.2	57.56	40.54	22.3	69.21	-	-	P	H	
		18000	59.77	-14.23	74	57.75	48.43	23.01	69.42	-	-	P	H	
		18000	50.65	-3.35	54	48.63	48.43	23.01	69.42	-	-	A	H	
			11570	56.75	-17.25	74	66.61	40.08	17.68	67.62	106	27	P	V
			11570	46.31	-7.69	54	56.17	40.08	17.68	67.62	106	27	A	V
			13391	49.88	-24.12	74	58.68	39.63	19.25	67.68	-	-	P	V
			13391	43.52	-10.48	54	52.32	39.63	19.25	67.68	-	-	A	V
			14491	51.94	-22.06	74	58.01	41.63	20.04	67.74	-	-	P	V
			14491	42.93	-11.07	54	49	41.63	20.04	67.74	-	-	A	V
			17355	51.38	-16.82	68.2	57.5	40.79	22.3	69.21	-	-	P	V
			18000	59.15	-14.85	74	57.55	48.01	23.01	69.42	-	-	P	V
		18000	50.38	-3.62	54	48.78	48.01	23.01	69.42	-	-	A	V	



WIFI	Note	Frequency (MHz)	Level (dBμV/m)	Over Limit (dB)	Limit Line (dBμV/m)	Read Level (dBμV)	Antenna Factor (dB/m)	Path Loss (dB)	Preamp Factor (dB)	Ant Pos (cm)	Table Pos (deg)	Peak Avg. (P/A)	Pol. (H/V)	
802.11a CH 165 5825MHz		11650	60.71	-13.29	74	70.91	39.69	17.76	67.65	100	83	P	H	
		11650	49.65	-4.35	54	59.85	39.69	17.76	67.65	100	83	A	H	
		13391	49.48	-24.52	74	58.27	39.64	19.25	67.68	-	-	P	H	
		13391	43.44	-10.56	54	52.23	39.64	19.25	67.68	-	-	A	H	
		14491	52.16	-21.84	74	58.1	41.76	20.04	67.74	-	-	P	H	
		14491	42.97	-11.03	54	48.91	41.76	20.04	67.74	-	-	A	H	
		17475	53.52	-14.68	68.2	58.81	41.64	22.43	69.36	-	-	P	H	
		18000	59.91	-14.09	74	57.89	48.43	23.01	69.42	-	-	P	H	
		18000	50.61	-3.39	54	48.59	48.43	23.01	69.42	-	-	A	H	
			11650	60.95	-13.05	74	71.03	39.81	17.76	67.65	400	10	P	V
			11650	50.36	-3.64	54	60.44	39.81	17.76	67.65	400	10	A	V
			13369	50.47	-23.53	74	59.36	39.57	19.23	67.69	-	-	P	V
			13369	42.95	-11.05	54	51.84	39.57	19.23	67.69	-	-	A	V
			14491	51.88	-22.12	74	57.95	41.63	20.04	67.74	-	-	P	V
			14491	43.09	-10.91	54	49.16	41.63	20.04	67.74	-	-	A	V
			17475	52.91	-15.29	68.2	58.14	41.7	22.43	69.36	-	-	P	V
			18000	60.36	-13.64	74	58.76	48.01	23.01	69.42	-	-	P	V
		18000	50.34	-3.66	54	48.74	48.01	23.01	69.42	-	-	A	V	
Remark	<ol style="list-style-type: none"> No other spurious found. All results are PASS against Peak and Average limit line. The emission position marked as "-" means no suspected emission found and emission level has at least 6dB margin against limit or noise floor only. The emission level close to 18GHz is checked that the average emission level is noise floor only. 													



**UNII-3 5725~5850MHz
WIFI 802.11ax HE20_Full (Band Edge @ 3m)**

WIFI	Note	Frequency (MHz)	Level (dBμV/m)	Over Limit (dB)	Limit Line (dBμV/m)	Read Level (dBμV)	Antenna Factor (dB/m)	Path Loss (dB)	Preamp Factor (dB)	Ant Pos (cm)	Table Pos (deg)	Peak Avg. (P/A)	Pol. (H/V)	
802.11ax HE20 Full CH 149 5745MHz		5646.8	54.89	-13.31	68.2	41.34	31.95	11.71	30.11	299	298	P	H	
		5694.2	57.7	-43.22	100.92	44.05	32.03	11.77	30.15	299	298	P	H	
		5720	68.55	-42.25	110.8	54.83	32.1	11.78	30.16	299	298	P	H	
		5721	72.05	-41.03	113.08	58.32	32.11	11.78	30.16	299	298	P	H	
	*	5745	122.69	-	-	108.9	32.18	11.78	30.17	299	298	P	H	
	*	5745	114.64	-	-	100.85	32.18	11.78	30.17	299	298	A	H	
			5638.4	54.28	-13.92	68.2	40.67	32.02	11.7	30.11	398	48	P	V
			5700	55.62	-49.58	105.2	41.88	32.12	11.78	30.16	398	48	P	V
			5719.2	70.26	-40.32	110.58	56.48	32.16	11.78	30.16	398	48	P	V
			5720.2	71.12	-40.14	111.26	57.33	32.17	11.78	30.16	398	48	P	V
	*		5745	122.31	-	-	108.48	32.22	11.78	30.17	398	48	P	V
	*		5745	112.98	-	-	99.15	32.22	11.78	30.17	398	48	A	V



WIFI	Note	Frequency (MHz)	Level (dBµV/m)	Over Limit (dB)	Limit Line (dBµV/m)	Read Level (dBµV)	Antenna Factor (dB/m)	Path Loss (dB)	Preamp Factor (dB)	Ant Pos (cm)	Table Pos (deg)	Peak Avg. (P/A)	Pol. (H/V)	
802.11ax HE20 Full CH 157 5785MHz		5619.2	54.46	-13.74	68.2	40.93	31.98	11.67	30.12	299	300	P	H	
		5681.6	54.24	-37.38	91.62	40.61	32.01	11.76	30.14	299	300	P	H	
		5709.6	53.74	-54.15	107.89	40.05	32.07	11.78	30.16	299	300	P	H	
		5724.8	53.35	-68.39	121.74	39.61	32.12	11.78	30.16	299	300	P	H	
	*	5785	122.19	-	-	108.25	32.33	11.78	30.17	299	300	P	H	
	*	5785	113.58	-	-	99.64	32.33	11.78	30.17	299	300	A	H	
		5851.4	53.85	-65.16	119.01	39.72	32.44	11.87	30.18	299	300	P	H	
		5868.6	53.84	-53.15	106.99	39.68	32.46	11.9	30.2	299	300	P	H	
		5900.4	54.4	-31.96	86.36	40.18	32.49	11.96	30.23	299	300	P	H	
		5927	54.94	-13.26	68.2	40.67	32.52	11.99	30.24	299	300	P	H	
			5602.8	54.89	-13.31	68.2	41.31	32.05	11.65	30.12	375	52	P	V
			5674.4	54.39	-31.91	86.3	40.7	32.07	11.75	30.13	375	52	P	V
			5715.2	53.4	-56.06	109.46	39.63	32.15	11.78	30.16	375	52	P	V
			5724.8	52.63	-69.11	121.74	38.83	32.18	11.78	30.16	375	52	P	V
	*		5785	121.02	-	-	107.14	32.27	11.78	30.17	375	52	P	V
	*		5785	112.19	-	-	98.31	32.27	11.78	30.17	375	52	A	V
			5854.6	53.45	-58.26	111.71	39.28	32.47	11.88	30.18	375	52	P	V
		5865.6	54.05	-53.78	107.83	39.85	32.5	11.9	30.2	375	52	P	V	
		5894.8	55.42	-35.09	90.51	41.1	32.59	11.95	30.22	375	52	P	V	
		5936.2	54.67	-13.53	68.2	40.27	32.64	12	30.24	375	52	P	V	



WIFI	Note	Frequency (MHz)	Level (dBμV/m)	Over Limit (dB)	Limit Line (dBμV/m)	Read Level (dBμV)	Antenna Factor (dB/m)	Path Loss (dB)	Preamp Factor (dB)	Ant Pos (cm)	Table Pos (deg)	Peak Avg. (P/A)	Pol. (H/V)	
802.11ax HE20 Full CH 165 5825MHz	*	5825	122.37	-	-	108.31	32.41	11.82	30.17	309	300	P	H	
	*	5825	113.53	-	-	99.47	32.41	11.82	30.17	309	300	A	H	
		5852.6	68.56	-47.71	116.27	54.43	32.44	11.87	30.18	309	300	P	H	
		5860.4	66.72	-42.57	109.29	52.57	32.45	11.89	30.19	309	300	P	H	
		5907.4	54.86	-26.33	81.19	40.62	32.5	11.97	30.23	309	300	P	H	
		5925.4	55.05	-13.15	68.2	40.78	32.52	11.99	30.24	309	300	P	H	
	*	5825	121.65	-	-	107.63	32.37	11.82	30.17	388	50	P	V	
	*	5825	112.83	-	-	98.81	32.37	11.82	30.17	388	50	A	V	
		5853.4	60.66	-53.79	114.45	46.5	32.46	11.88	30.18	388	50	P	V	
		5858.2	65.66	-44.24	109.9	51.49	32.48	11.88	30.19	388	50	P	V	
		5879.4	55.73	-46.2	101.93	41.48	32.54	11.92	30.21	388	50	P	V	
		5939.4	54.95	-13.25	68.2	40.55	32.64	12.01	30.25	388	50	P	V	
Remark	1. No other spurious found. 2. All results are PASS against Peak and Average limit line.													



UNII-3 5725~5850MHz
WIFI 802.11ax HE20 Full (Harmonic @ 3m)

WIFI	Note	Frequency (MHz)	Level (dBμV/m)	Over Limit (dB)	Limit Line (dBμV/m)	Read Level (dBμV)	Antenna Factor (dB/m)	Path Loss (dB)	Preamp Factor (dB)	Ant Pos (cm)	Table Pos (deg)	Peak Avg. (P/A)	Pol. (H/V)	
802.11ax HE20 Full CH 149 5745MHz		11490	57.83	-16.17	74	67.68	40.14	17.61	67.6	201	288	P	H	
		11490	46.97	-7.03	54	56.82	40.14	17.61	67.6	201	288	A	H	
		13325	50.23	-23.77	74	59.34	39.41	19.2	67.72	-	-	P	H	
		13325	42.98	-11.02	54	52.09	39.41	19.2	67.72	-	-	A	H	
		14491	51.5	-22.5	74	57.44	41.76	20.04	67.74	-	-	P	H	
		14491	43.01	-10.99	54	48.95	41.76	20.04	67.74	-	-	A	H	
		17235	50.33	-17.87	68.2	57.46	39.77	22.17	69.07	-	-	P	H	
		18000	59.98	-14.02	74	57.96	48.43	23.01	69.42	-	-	P	H	
		18000	50.33	-3.67	54	48.31	48.43	23.01	69.42	-	-	A	H	
			11490	58.6	-15.4	74	68.35	40.24	17.61	67.6	210	16	P	V
			11490	48.19	-5.81	54	57.94	40.24	17.61	67.6	210	16	A	V
			13314	50.01	-23.99	74	59.17	39.37	19.19	67.72	-	-	P	V
			13314	42.27	-11.73	54	51.43	39.37	19.19	67.72	-	-	A	V
			14491	51.43	-22.57	74	57.5	41.63	20.04	67.74	-	-	P	V
			14491	42.89	-11.11	54	48.96	41.63	20.04	67.74	-	-	A	V
			17235	50.3	-17.9	68.2	57.25	39.95	22.17	69.07	-	-	P	V
		18000	59.78	-14.22	74	58.18	48.01	23.01	69.42	-	-	P	V	
		18000	50.68	-3.32	54	49.08	48.01	23.01	69.42	-	-	A	V	



WIFI	Note	Frequency (MHz)	Level (dBµV/m)	Over Limit (dB)	Limit Line (dBµV/m)	Read Level (dBµV)	Antenna Factor (dB/m)	Path Loss (dB)	Preamp Factor (dB)	Ant Pos (cm)	Table Pos (deg)	Peak Avg. (P/A)	Pol. (H/V)	
802.11ax HE20 Full CH 157 5785MHz		11570	58.5	-15.5	74	68.34	40.1	17.68	67.62	392	31	P	H	
		11570	47.45	-6.55	54	57.29	40.1	17.68	67.62	392	31	A	H	
		13336	50.16	-23.84	74	59.21	39.45	19.21	67.71	-	-	P	H	
		13336	42.58	-11.42	54	51.63	39.45	19.21	67.71	-	-	A	H	
		14491	52.56	-21.44	74	58.5	41.76	20.04	67.74	-	-	P	H	
		14491	43.46	-10.54	54	49.4	41.76	20.04	67.74	-	-	A	H	
		17355	50.79	-17.41	68.2	57.16	40.54	22.3	69.21	-	-	P	H	
		18000	60.43	-13.57	74	58.41	48.43	23.01	69.42	-	-	P	H	
		18000	50.3	-3.7	54	48.28	48.43	23.01	69.42	-	-	A	H	
			11570	57.89	-16.11	74	67.75	40.08	17.68	67.62	111	26	P	V
			11570	47.7	-6.3	54	57.56	40.08	17.68	67.62	111	26	A	V
			13281	50.12	-23.88	74	59.47	39.23	19.16	67.74	-	-	P	V
			13281	42.61	-11.39	54	51.96	39.23	19.16	67.74	-	-	A	V
			14491	51.99	-22.01	74	58.06	41.63	20.04	67.74	-	-	P	V
			14491	42.61	-11.39	54	48.68	41.63	20.04	67.74	-	-	A	V
			17355	51.11	-17.09	68.2	57.23	40.79	22.3	69.21	-	-	P	V
		18000	60.23	-13.77	74	58.63	48.01	23.01	69.42	-	-	P	V	
		18000	50.87	-3.13	54	49.27	48.01	23.01	69.42	-	-	A	V	



WIFI	Note	Frequency (MHz)	Level (dBμV/m)	Over Limit (dB)	Limit Line (dBμV/m)	Read Level (dBμV)	Antenna Factor (dB/m)	Path Loss (dB)	Preamp Factor (dB)	Ant Pos (cm)	Table Pos (deg)	Peak Avg. (P/A)	Pol. (H/V)	
802.11ax HE20 Full CH 165 5825MHz		11650	60.58	-13.42	74	70.78	39.69	17.76	67.65	104	83	P	H	
		11650	50.19	-3.81	54	60.39	39.69	17.76	67.65	104	83	A	H	
		13314	50.48	-23.52	74	59.64	39.37	19.19	67.72	-	-	P	H	
		13314	42.5	-11.5	54	51.66	39.37	19.19	67.72	-	-	A	H	
		14491	52.64	-21.36	74	58.58	41.76	20.04	67.74	-	-	P	H	
		14491	43.83	-10.17	54	49.77	41.76	20.04	67.74	-	-	A	H	
		17475	52.61	-15.59	68.2	57.9	41.64	22.43	69.36	-	-	P	H	
		18000	60.09	-13.91	74	58.07	48.43	23.01	69.42	-	-	P	H	
		18000	50.27	-3.73	54	48.25	48.43	23.01	69.42	-	-	A	H	
			11650	61.71	-12.29	74	71.79	39.81	17.76	67.65	400	9	P	V
			11650	51.19	-2.81	54	61.27	39.81	17.76	67.65	400	9	A	V
			13358	50.57	-23.43	74	59.5	39.55	19.22	67.7	-	-	P	V
			13358	42.77	-11.23	54	51.7	39.55	19.22	67.7	-	-	A	V
			14491	51.74	-22.26	74	57.81	41.63	20.04	67.74	-	-	P	V
			14491	42.7	-11.3	54	48.77	41.63	20.04	67.74	-	-	A	V
		17475	52.06	-16.14	68.2	57.29	41.7	22.43	69.36	-	-	P	V	
		18000	60.78	-13.22	74	59.18	48.01	23.01	69.42	-	-	P	V	
		18000	50.36	-3.64	54	48.76	48.01	23.01	69.42	-	-	A	V	
Remark	<ol style="list-style-type: none"> No other spurious found. All results are PASS against Peak and Average limit line. The emission position marked as "-" means no suspected emission found and emission level has at least 6dB margin against limit or noise floor only. The emission level close to 18GHz is checked that the average emission level is noise floor only. 													



UNII-3 - 5725~5850MHz

WIFI 802.11ax HE20_Partial RU 52 (Band Edge @ 3m)

WIFI	Note	Frequency	Level	Margin	Limit	Read	Antenna	Path	Preamp	Ant	Table	Peak	Pol.	
Ant.		(MHz)	(dBμV/m)	(dB)	(dBμV/m)	(dBμV)	(dB/m)	(dB)	(dB)	(cm)	(deg)	(P/A)	(H/V)	
802.11ax HE20 Partial RU 52_52_52_ 52 CH 149 5745MHz		5604.2	55.7	-12.50	68.2	40.46	33.23	12.39	30.38	247	99	P	H	
		5699.6	68.24	-36.67	104.91	52.7	33.45	12.51	30.42	247	99	P	H	
		5720	82.73	-28.07	110.8	67.02	33.59	12.54	30.42	247	99	P	H	
		5724.4	87.49	-33.34	120.83	71.75	33.62	12.54	30.42	247	99	P	H	
	*	5745	121.32	-	-	105.41	33.76	12.57	30.42	247	99	P	H	
	*	5745	113.79	-	-	97.88	33.76	12.57	30.42	247	99	A	H	
														H
														H
			5608.2	55.41	-12.79	68.2	40.17	33.23	12.39	30.38	268	242	P	V
			5698	70.32	-33.41	103.73	54.79	33.44	12.51	30.42	268	242	P	V
			5718.2	81.91	-28.39	110.3	66.23	33.57	12.53	30.42	268	242	P	V
			5724	87.71	-32.21	119.92	71.98	33.61	12.54	30.42	268	242	P	V
	*		5745	122.43	-	-	106.52	33.76	12.57	30.42	268	242	P	V
	*		5745	114.06	-	-	98.15	33.76	12.57	30.42	268	242	A	V
														V
													V	



WIFI Ant.	Note	Frequency (MHz)	Level (dBμV/m)	Margin (dB)	Limit Line (dBμV/m)	Read Level (dBμV)	Antenna Factor (dB/m)	Path Loss (dB)	Preamp Factor (dB)	Ant Pos (cm)	Table Pos (deg)	Peak Avg. (P/A)	Pol. (H/V)	
802.11ax HE20 Partial RU 52_52_52_ 52 CH 165 5825MHz	*	5825	121.93	-	-	105.52	34.19	12.67	30.45	245	90	P	H	
	*	5825	113.8	-	-	97.39	34.19	12.67	30.45	245	90	A	H	
		5850.8	85.31	-35.07	120.38	68.85	34.23	12.7	30.47	245	90	P	H	
		5855.6	79.1	-31.53	110.63	62.64	34.23	12.7	30.47	245	90	P	H	
		5875	67.63	-37.57	105.2	51.16	34.24	12.72	30.49	245	90	P	H	
		5926	55.31	-12.89	68.2	38.82	34.22	12.78	30.51	245	90	P	H	
														H
														H
	*	5825	121.2	-	-	104.79	34.19	12.67	30.45	280	358	P	V	
	*	5825	113.74	-	-	97.33	34.19	12.67	30.45	280	358	A	V	
		5850.2	83.45	-38.29	121.74	66.99	34.23	12.7	30.47	280	358	P	V	
		5856.4	82.66	-27.75	110.41	66.2	34.23	12.7	30.47	280	358	P	V	
		5875.8	68.05	-36.56	104.61	51.58	34.24	12.72	30.49	280	358	P	V	
		5947.8	55.72	-12.48	68.2	39.23	34.2	12.8	30.51	280	358	P	V	
														V
														V
Remark	1. No other spurious found. 2. All results are PASS against Peak and Average limit line.													



UNII-3 5725~5850MHz
WIFI 802.11ax HE40_Full (Band Edge @ 3m)

WIFI	Note	Frequency (MHz)	Level (dBμV/m)	Over Limit (dB)	Limit Line (dBμV/m)	Read Level (dBμV)	Antenna Factor (dB/m)	Path Loss (dB)	Preamp Factor (dB)	Ant Pos (cm)	Table Pos (deg)	Peak Avg. (P/A)	Pol. (H/V)	
802.11ax HE40 Full CH 151 5755MHz		5643.4	55.95	-12.25	68.2	42.4	31.95	11.71	30.11	262	299	P	H	
		5683.8	63.8	-29.45	93.25	50.17	32.01	11.76	30.14	262	299	P	H	
		5702.8	70.52	-35.47	105.99	56.85	32.05	11.78	30.16	262	299	P	H	
		5722.8	78.5	-38.68	117.18	64.77	32.11	11.78	30.16	262	299	P	H	
	*	5755	120.91	-	-	107.09	32.21	11.78	30.17	262	299	P	H	
	*	5755	112.02	-	-	98.2	32.21	11.78	30.17	262	299	A	H	
		5850.6	56.52	-64.31	120.83	42.39	32.44	11.87	30.18	262	299	P	H	
		5862.4	55.11	-53.62	108.73	40.96	32.45	11.89	30.19	262	299	P	H	
		5896	55.38	-34.24	89.62	41.17	32.49	11.95	30.23	262	299	P	H	
		5932	54.31	-13.89	68.2	40.02	32.53	12	30.24	262	299	P	H	
			5615.4	55.72	-12.48	68.2	42.13	32.04	11.67	30.12	378	48	P	V
			5690.6	63.97	-34.3	98.27	50.25	32.1	11.77	30.15	378	48	P	V
			5710.4	70.53	-37.58	108.11	56.77	32.14	11.78	30.16	378	48	P	V
			5722	68.95	-46.41	115.36	55.16	32.17	11.78	30.16	378	48	P	V
	*		5755	119.95	-	-	106.1	32.24	11.78	30.17	378	48	P	V
	*		5755	111.66	-	-	97.81	32.24	11.78	30.17	378	48	A	V
			5851.8	56.43	-61.67	118.1	42.28	32.46	11.87	30.18	378	48	P	V
			5860.4	54.28	-55.01	109.29	40.1	32.48	11.89	30.19	378	48	P	V
		5924.5	54.89	-13.68	68.57	40.51	32.63	11.99	30.24	378	48	P	V	
		5925	54.89	-13.31	68.2	40.51	32.63	11.99	30.24	378	48	P	V	



WIFI	Note	Frequency (MHz)	Level (dBµV/m)	Over Limit (dB)	Limit Line (dBµV/m)	Read Level (dBµV)	Antenna Factor (dB/m)	Path Loss (dB)	Preamp Factor (dB)	Ant Pos (cm)	Table Pos (deg)	Peak Avg. (P/A)	Pol. (H/V)	
802.11ax HE40 Full CH 159 5795MHz		5615.2	54.73	-13.47	68.2	41.2	31.98	11.67	30.12	260	300	P	H	
		5695	54.37	-47.14	101.51	40.73	32.03	11.77	30.16	260	300	P	H	
		5705	59.75	-46.85	106.6	46.07	32.06	11.78	30.16	260	300	P	H	
		5723.8	62.95	-56.51	119.46	49.22	32.11	11.78	30.16	260	300	P	H	
	*	5795	119.75	-	-	105.77	32.37	11.78	30.17	260	300	P	H	
	*	5795	111.5	-	-	97.52	32.37	11.78	30.17	260	300	A	H	
		5851.2	64.73	-54.73	119.46	50.6	32.44	11.87	30.18	260	300	P	H	
		5863.4	63.45	-45	108.45	49.3	32.45	11.89	30.19	260	300	P	H	
		5875	55.07	-50.13	105.2	40.89	32.47	11.91	30.2	260	300	P	H	
		5941.4	54.9	-13.3	68.2	40.6	32.54	12.01	30.25	260	300	P	H	
			5647.8	55.27	-12.93	68.2	41.65	32.02	11.71	30.11	400	75	P	V
			5675.2	54.36	-32.53	86.89	40.68	32.07	11.75	30.14	400	75	P	V
			5717.8	60.7	-49.48	110.18	46.92	32.16	11.78	30.16	400	75	P	V
			5720.8	58.5	-54.12	112.62	44.71	32.17	11.78	30.16	400	75	P	V
	*		5795	118.73	-	-	104.84	32.28	11.78	30.17	400	75	P	V
	*		5795	109.51	-	-	95.62	32.28	11.78	30.17	400	75	A	V
			5854.4	63.09	-49.08	112.17	48.92	32.47	11.88	30.18	400	75	P	V
		5856.8	66.91	-43.39	110.3	52.75	32.47	11.88	30.19	400	75	P	V	
		5878.4	55.72	-46.95	102.67	41.47	32.54	11.92	30.21	400	75	P	V	
		5941.4	54.2	-14	68.2	39.8	32.64	12.01	30.25	400	75	P	V	
Remark	1. No other spurious found. 2. All results are PASS against Peak and Average limit line.													



UNII-3 5725~5850MHz
WIFI 802.11ax HE40_Full (Harmonic @ 3m)

WIFI	Note	Frequency (MHz)	Level (dBµV/m)	Over Limit (dB)	Limit Line (dBµV/m)	Read Level (dBµV)	Antenna Factor (dB/m)	Path Loss (dB)	Preamp Factor (dB)	Ant Pos (cm)	Table Pos (deg)	Peak Avg. (P/A)	Pol. (H/V)	
802.11ax HE40 Full CH 151 5755MHz		11510	57.1	-16.9	74	66.91	40.15	17.63	67.59	206	290	P	H	
		11510	46.87	-7.13	54	56.68	40.15	17.63	67.59	206	290	A	H	
		13281	50.12	-23.88	74	59.46	39.24	19.16	67.74	-	-	P	H	
		13281	42.05	-11.95	54	51.39	39.24	19.16	67.74	-	-	A	H	
		14491	52.36	-21.64	74	58.3	41.76	20.04	67.74	-	-	P	H	
		14491	42.97	-11.03	54	48.91	41.76	20.04	67.74	-	-	A	H	
		17265	49.99	-18.21	68.2	56.95	39.94	22.2	69.1	-	-	P	H	
		18000	60.38	-13.62	74	58.36	48.43	23.01	69.42	-	-	P	H	
		18000	50.22	-3.78	54	48.2	48.43	23.01	69.42	-	-	A	H	
			11510	56.26	-17.74	74	65.99	40.23	17.63	67.59	292	29	P	V
			11510	47.47	-6.53	54	57.2	40.23	17.63	67.59	292	29	A	V
			13336	49.64	-24.36	74	58.68	39.46	19.21	67.71	-	-	P	V
			13336	42.17	-11.83	54	51.21	39.46	19.21	67.71	-	-	A	V
			14491	51.6	-22.4	74	57.67	41.63	20.04	67.74	-	-	P	V
			14491	43.66	-10.34	54	49.73	41.63	20.04	67.74	-	-	A	V
			17265	50.05	-18.15	68.2	56.81	40.14	22.2	69.1	-	-	P	V
		18000	60.14	-13.86	74	58.54	48.01	23.01	69.42	-	-	P	V	
		18000	50.85	-3.15	54	49.25	48.01	23.01	69.42	-	-	A	V	



WIFI	Note	Frequency (MHz)	Level (dBμV/m)	Over Limit (dB)	Limit Line (dBμV/m)	Read Level (dBμV)	Antenna Factor (dB/m)	Path Loss (dB)	Preamp Factor (dB)	Ant Pos (cm)	Table Pos (deg)	Peak Avg. (P/A)	Pol. (H/V)	
802.11ax HE40 Full CH 159 5795MHz		11590	56.57	-17.43	74	66.47	40.03	17.7	67.63	391	33	P	H	
		11590	47.61	-6.39	54	57.51	40.03	17.7	67.63	391	33	A	H	
		13292	50.36	-23.64	74	59.64	39.28	19.17	67.73	-	-	P	H	
		13292	42.31	-11.69	54	51.59	39.28	19.17	67.73	-	-	A	H	
		14491	52.25	-21.75	74	58.19	41.76	20.04	67.74	-	-	P	H	
		14491	43.75	-10.25	54	49.69	41.76	20.04	67.74	-	-	A	H	
		17385	51.68	-16.52	68.2	57.82	40.78	22.33	69.25	-	-	P	H	
		18000	60.7	-13.3	74	58.68	48.43	23.01	69.42	-	-	P	H	
		18000	50.18	-3.82	54	48.16	48.43	23.01	69.42	-	-	A	H	
			11590	57.3	-16.7	74	67.25	39.98	17.7	67.63	113	27	P	V
			11590	46.94	-7.06	54	56.89	39.98	17.7	67.63	113	27	A	V
			13270	50.08	-23.92	74	59.49	39.19	19.15	67.75	-	-	P	V
			13270	42.35	-11.65	54	51.76	39.19	19.15	67.75	-	-	A	V
			14491	51.99	-22.01	74	58.06	41.63	20.04	67.74	-	-	P	V
			14491	43.65	-10.35	54	49.72	41.63	20.04	67.74	-	-	A	V
			17385	52.19	-16.01	68.2	58.07	41.04	22.33	69.25	-	-	P	V
		18000	60.24	-13.76	74	58.64	48.01	23.01	69.42	-	-	P	V	
		18000	50.78	-3.22	54	49.18	48.01	23.01	69.42	-	-	A	V	
Remark	<ol style="list-style-type: none"> No other spurious found. All results are PASS against Peak and Average limit line. The emission position marked as "-" means no suspected emission found and emission level has at least 6dB margin against limit or noise floor only. The emission level close to 18GHz is checked that the average emission level is noise floor only. 													



UNII-3 5725~5850MHz
WIFI 802.11ax HE80_Full (Band Edge @ 3m)

WIFI	Note	Frequency (MHz)	Level (dBμV/m)	Over Limit (dB)	Limit Line (dBμV/m)	Read Level (dBμV)	Antenna Factor (dB/m)	Path Loss (dB)	Preamp Factor (dB)	Ant Pos (cm)	Table Pos (deg)	Peak Avg. (P/A)	Pol. (H/V)	
802.11ax HE80 Full CH 155 5775MHz		5643.8	61.5	-6.7	68.2	47.95	31.95	11.71	30.11	259	301	P	H	
		5684.2	69.29	-24.25	93.54	55.66	32.01	11.76	30.14	259	301	P	H	
		5703	72.58	-33.46	106.04	58.91	32.05	11.78	30.16	259	301	P	H	
		5723.2	73.94	-44.16	118.1	60.21	32.11	11.78	30.16	259	301	P	H	
	*	5775	116.36	-	-	102.46	32.29	11.78	30.17	259	301	P	H	
	*	5775	108.26	-	-	94.36	32.29	11.78	30.17	259	301	A	H	
		5850.4	70.87	-50.42	121.29	56.74	32.44	11.87	30.18	259	301	P	H	
		5863	68.45	-40.11	108.56	54.3	32.45	11.89	30.19	259	301	P	H	
		5876.2	62.19	-42.12	104.31	48.01	32.47	11.92	30.21	259	301	P	H	
		5941	54.37	-13.83	68.2	40.07	32.54	12.01	30.25	259	301	P	H	
			5642.6	61.09	-7.11	68.2	47.47	32.02	11.71	30.11	243	44	P	V
			5700	68.94	-36.26	105.2	55.2	32.12	11.78	30.16	243	44	P	V
			5700.6	71.93	-33.44	105.37	58.19	32.12	11.78	30.16	243	44	P	V
			5722	73.6	-41.76	115.36	59.81	32.17	11.78	30.16	243	44	P	V
	*		5775	116.73	-	-	102.86	32.26	11.78	30.17	243	44	P	V
	*		5775	108.12	-	-	94.25	32.26	11.78	30.17	243	44	A	V
			5850	67.67	-54.53	122.2	53.53	32.45	11.87	30.18	243	44	P	V
			5862.4	69.86	-38.87	108.73	55.67	32.49	11.89	30.19	243	44	P	V
		5880.4	62.16	-39.03	101.19	47.91	32.54	11.92	30.21	243	44	P	V	
		5936.4	55.01	-13.19	68.2	40.61	32.64	12	30.24	243	44	P	V	
Remark	1. No other spurious found. 2. All results are PASS against Peak and Average limit line.													



UNII-3 5725~5850MHz
WIFI 802.11ax HE80_Full (Harmonic @ 3m)

WIFI	Note	Frequency (MHz)	Level (dBμV/m)	Over Limit (dB)	Limit Line (dBμV/m)	Read Level (dBμV)	Antenna Factor (dB/m)	Path Loss (dB)	Preamp Factor (dB)	Ant Pos (cm)	Table Pos (deg)	Peak Avg. (P/A)	Pol. (H/V)	
802.11ax HE80 Full CH 155 5775MHz		11550	48.86	-25.14	74	58.62	40.18	17.67	67.61	244	110	P	H	
		11550	39.77	-14.23	54	49.53	40.18	17.67	67.61	244	110	A	H	
		13358	50.27	-23.73	74	59.22	39.53	19.22	67.7	-	-	P	H	
		13358	42.19	-11.81	54	51.14	39.53	19.22	67.7	-	-	A	H	
		14491	51.9	-22.1	74	57.84	41.76	20.04	67.74	-	-	P	H	
		14491	43.78	-10.22	54	49.72	41.76	20.04	67.74	-	-	A	H	
		17325	51.25	-16.95	68.2	57.82	40.35	22.26	69.18	-	-	P	H	
		18000	59.62	-14.38	74	57.6	48.43	23.01	69.42	-	-	P	H	
		18000	50.47	-3.53	54	48.45	48.43	23.01	69.42	-	-	A	H	
	Remark	<ol style="list-style-type: none"> No other spurious found. All results are PASS against Peak and Average limit line. The emission position marked as "-" means no suspected emission found and emission level has at least 6dB margin against limit or noise floor only. The emission level close to 18GHz is checked that the average emission level is noise floor only. 												



Emission above 18GHz

5GHz WIFI 802.11ax HE20 Full (SHF @ 1m)

WIFI	Note	Frequency (MHz)	Level (dBμV/m)	Over Limit (dB)	Limit Line (dBμV/m)	Read Level (dBμV)	Antenna Factor (dB/m)	Path Loss (dB)	Preamp Factor (dB)	Ant Pos (cm)	Table Pos (deg)	Peak Avg. (P/A)	Pol. (H/V)
802.11ax HE20 Full CH165 5825MHz SHF		36480	46.7	-27.3	74	37.03	42.54	21.91	54.78	-	-	P	H
		39780	52.46	-21.54	74	36.66	44.81	24.44	53.45	-	-	P	H
		39780	45.57	-8.43	54	29.77	44.81	24.44	53.45	-	-	A	H
Remark	1. No other spurious found. 2. All results are PASS against limit line. 3. The emission position marked as "-" means no suspected emission found and emission level has at least 6dB margin against limit or noise floor only.												



**Emission below 1GHz
5GHz WIFI 802.11ax HE20 Full (LF @ 3m)**

WIFI	Note	Frequency (MHz)	Level (dBµV/m)	Over Limit (dB)	Limit Line (dBµV/m)	Read Level (dBµV)	Antenna Factor (dB/m)	Path Loss (dB)	Preamp Factor (dB)	Ant Pos (cm)	Table Pos (deg)	Peak Avg. (P/A)	Pol. (H/V)	
802.11ax HE20 Full CH165 5825MHz LF		62.98	32.45	-7.55	40	51.69	11.8	1.39	32.43	-	-	P	H	
		105.66	27.47	-16.03	43.5	41.58	16.57	1.73	32.41	-	-	P	H	
		160.95	27.89	-15.61	43.5	41.71	16.5	2.08	32.4	-	-	P	H	
		198.78	28.23	-15.27	43.5	43.39	14.9	2.34	32.4	-	-	P	H	
		425.76	37.98	-8.02	46	44.35	22.62	3.52	32.51	-	-	P	H	
		874.87	40.26	-5.74	46	37.91	29.1	5.03	31.78	-	-	P	H	
			37.76	34.59	-5.41	40	44.96	21.02	1.05	32.44	-	-	P	V
			62.01	34.95	-5.05	40	54.31	11.7	1.37	32.43	-	-	P	V
			105.66	30.94	-12.56	43.5	45.05	16.57	1.73	32.41	-	-	P	V
			428.67	35.02	-10.98	46	41.33	22.67	3.53	32.51	-	-	P	V
			754.59	34.96	-11.04	46	34.74	28	4.59	32.37	-	-	P	V
		874.87	37.19	-8.81	46	34.84	29.1	5.03	31.78	-	-	P	V	
Remark	<ol style="list-style-type: none"> No other spurious found. All results are PASS against limit line. The emission position marked as "-" means no suspected emission found and emission level has at least 6dB margin against limit or noise floor only. 													



Note symbol

*	Fundamental Frequency which can be ignored. However, the level of any unwanted emissions shall not exceed the level of the fundamental frequency.
!	Test result is over limit line.
P/A	Peak or Average
H/V	Horizontal or Vertical



A calculation example for radiated spurious emission is shown as below:

WIFI	Note	Frequency	Level	Over	Limit	Read	Antenna	Path	Preamp	Ant	Table	Peak	Pol.
		(MHz)	(dBµV/m)	(dB)	Limit Line	Level	Factor	Loss	Factor	Pos	Pos	Avg.	
					(dBµV/m)	(dBµV)	(dB/m)	(dB)	(dB)	(cm)	(deg)	(P/A)	(H/V)
802.11a CH 149 5745MHz		5648.6	56.91	-11.29	68.2	43.36	31.95	11.71	30.11	260	79	P	H

1. Path Loss(dB) = Cable loss(dB) + Filter loss(dB) + Attenuator loss(dB)
2. Level(dBµV/m) = Antenna Factor(dB/m) + Path Loss(dB) + Read Level(dBµV) - Preamp Factor(dB)
3. Over Limit(dB) = Level(dBµV/m) – Limit Line(dBµV/m)

For Peak Limit @ 5648.6MHz:

1. Level(dBµV/m)
= Antenna Factor(dB/m) + Path Loss(dB) + Read Level(dBµV) - Preamp Factor(dB)
= 31.95 (dB/m) + 11.71 (dB) + 43.36 (dBµV) – 30.11 (dB)
= 56.91 (dBµV/m)
2. Over Limit(dB)
= Level(dBµV/m) – Limit Line(dBµV/m)
= 56.91 (dBµV/m) – 68.2 (dBµV/m)
= -11.29 (dB)

Both peak and average measured complies with the limit line, so test result is “PASS”.



Appendix D. Radiated Spurious Emission Plots

Test Engineer :	Michael Bui and Daniel Lee	Temperature :	20~23.1°C
		Relative Humidity :	40~43.2%

<Radio 2>

MIMO <Ant. A+D+B+C>

UNII-3 - 5725~5850MHz
WIFI 802.11a (Band Edge @ 3m)

WIFI	UNII-3 5725~5850MHz Band Edge @ 3m	
	802.11a CH149 5745MHz	
	Horizontal	Fundamental
Peak	<p>Site : 03CH02-CA Condition : PEAK_BE(B4)_16-24 3m HORN 9120D-HF_02113 HORIZONTAL : RBW:1000.000KHz VBW:3000.000KHz SWT:Auto</p>	<p>Site : 03CH02-CA Condition : PEAK(U)1 3m HORN 9120D-HF_02113 HORIZONTAL : RBW:1000.000KHz VBW:3000.000KHz SWT:Auto</p>

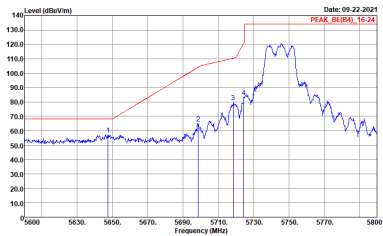
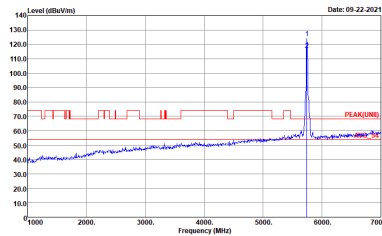

WIFI	UNII-3 5725~5850MHz Band Edge @ 3m	
802.11a CH149 5745MHz		
Vertical		Fundamental
Peak	 <p>Site : 03CH02-CA Condition : PEAK_BE(B4)_16-24 3m HORN 9120D-HF_02113 VERTICAL : RBW:1000.000KHz VBW:3000.000KHz SWT:Auto</p>	 <p>Site : 03CH02-CA Condition : PEAK(LINE3) 3m HORN 9120D-HF_02113 VERTICAL : RBW:1000.000KHz VBW:3000.000KHz SWT:Auto</p>

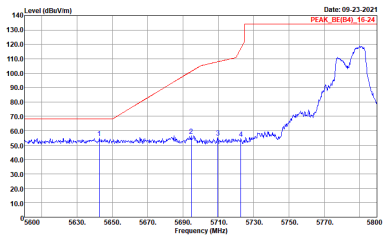
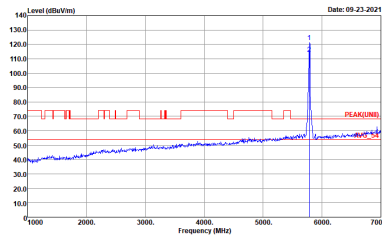
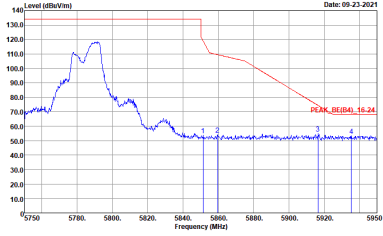

WIFI	UNII-3 5725~5850MHz Band Edge @ 3m	
802.11a CH157 5785MHz		
Horizontal		Fundamental
Peak	 <p>Site : 03CH02-CA Condition : PEAK_BE(B4)_16-24 3m HORN 91200-HF_02113 HORIZONTAL : RBW:1000.000KHz VBW:3000.000KHz SWT:Auto</p>	 <p>Site : 03CH02-CA Condition : PEAK(LINE) 3m HORN 91200-HF_02113 HORIZONTAL : RBW:1000.000KHz VBW:3000.000KHz SWT:Auto</p>
Peak	 <p>Site : 03CH02-CA Condition : PEAK_BE(B4)_16-24 3m HORN 91200-HF_02113 HORIZONTAL : RBW:1000.000KHz VBW:3000.000KHz SWT:Auto</p>	Left blank

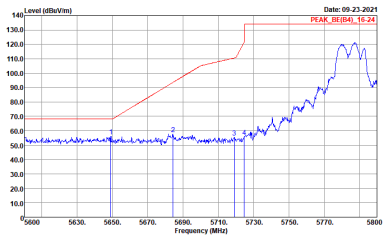
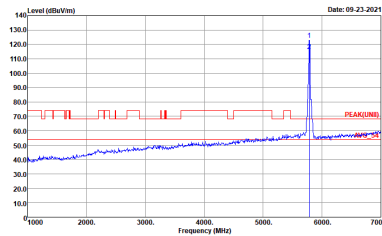
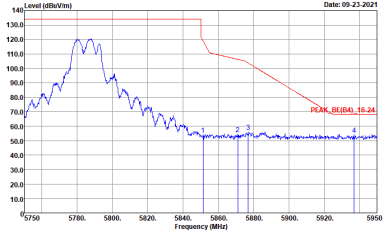

WIFI	UNII-3 5725~5850MHz Band Edge @ 3m	
802.11a CH157 5785MHz		
Vertical		Fundamental
Peak	 <p>Site : 03CH02-CA Condition : PEAK_BE(B4)_16-24 3m HORN 9120D-HF_02113 VERTICAL : RBW:1000.000KHz VBW:3000.000KHz SWT:Auto</p>	 <p>Site : 03CH02-CA Condition : PEAK(LINE) 3m HORN 9120D-HF_02113 VERTICAL : RBW:1000.000KHz VBW:3000.000KHz SWT:Auto</p>
Peak	 <p>Site : 03CH02-CA Condition : PEAK_BE(B4)_16-24 3m HORN 9120D-HF_02113 VERTICAL : RBW:1000.000KHz VBW:3000.000KHz SWT:Auto</p>	Left blank

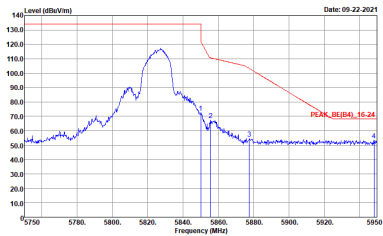
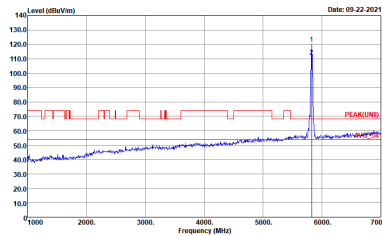

WIFI	UNII-3 5725~5850MHz Band Edge @ 3m	
802.11a CH165 5825MHz		
Horizontal		Fundamental
Peak	 <p>Site : 03CH02-CA Condition : PEAK_BI(BA)_16-24 3m HORN 91200-HF_02113 HORIZONTAL : RBW:1000.000KHz VBW:3000.000KHz SWT:Auto</p>	 <p>Site : 03CH02-CA Condition : PEAK(LINE) 3m HORN 91200-HF_02113 HORIZONTAL : RBW:1000.000KHz VBW:3000.000KHz SWT:Auto</p>



WIFI	UNII-3 5725~5850MHz Band Edge @ 3m	
802.11a CH165 5825MHz		
Vertical		Fundamental
Peak	<p>Site : 03CH02-CA Condition : PEAK_BI(BA)_16-24 3m HORN 91200-HF_02113 VERTICAL : RBW:1000.000KHz VBW:3000.000KHz SWT:Auto</p>	<p>Site : 03CH02-CA Condition : PEAK(LINE) 3m HORN 91200-HF_02113 VERTICAL : RBW:1000.000KHz VBW:3000.000KHz SWT:Auto</p>



UNII-3 5725~5850MHz
WIFI 802.11ax HE20 Full (Band Edge @ 3m)

WIFI	UNII-3 5725~5850MHz Band Edge @ 3m	
	802.11ax HE20 Full CH149 5745MHz	
	Horizontal	Fundamental
Peak	<p>Horizontal spectrum plot showing Level (dBuV/m) vs Frequency (MHz) for UNII-3 5725~5850MHz. A peak is labeled PEAK_BE(84)_16-24. Site: 03CH02-CA, Condition: PEAK_BE(84)_16-24 3m HORN 91200-HF_02113 HORIZONTAL, RBW:1000.000KHz VBW:3000.000KHz SWT:Auto.</p>	<p>Fundamental spectrum plot showing Level (dBuV/m) vs Frequency (MHz) for UNII-3 5725~5850MHz. A peak is labeled PEAK(UN3). Site: 03CH02-CA, Condition: PEAK(UNII) 3m HORN 91200-HF_02113 HORIZONTAL, RBW:1000.000KHz VBW:3000.000KHz SWT:Auto.</p>

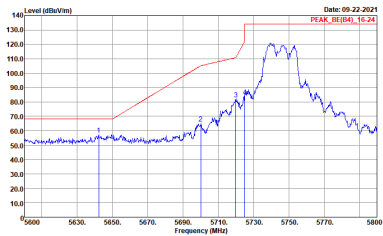
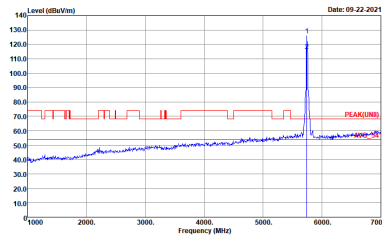

WIFI	UNII-3 5725~5850MHz Band Edge @ 3m	
	802.11ax HE20 Full CH149 5745MHz	
	Vertical	Fundamental
Peak	 <p>Site : 03CH02-CA Condition : PEAK_BE(B4)_16-24 3m HORN 91200-HF_02113 VERTICAL : RBW:1000.000KHz VBW:3000.000KHz SWT:Auto</p>	 <p>Site : 03CH02-CA Condition : PEAK(LINE) 3m HORN 91200-HF_02113 VERTICAL : RBW:1000.000KHz VBW:3000.000KHz SWT:Auto</p>



WIFI	UNII-3 5725~5850MHz Band Edge @ 3m	
	802.11ax HE20 Full CH157 5785MHz	
	Horizontal	Fundamental
Peak	<p>Date: 09-23-2021 PEAK_BE(B4)_16-24</p> <p>Site : 03CH02-CA Condition : PEAK_BE(B4)_16-24 3m HORN 91200-HF_02113 HORIZONTAL : RBW:1000.000KHz VBW:3000.000KHz SWT:Auto</p>	<p>Date: 09-23-2021 PEAK(LINE)</p> <p>Site : 03CH02-CA Condition : PEAK(LINE) 3m HORN 91200-HF_02113 HORIZONTAL : RBW:1000.000KHz VBW:3000.000KHz SWT:Auto</p>
Peak	<p>Date: 09-23-2021 PEAK_BE(B4)_16-24</p> <p>Site : 03CH02-CA Condition : PEAK_BE(B4)_16-24 3m HORN 91200-HF_02113 HORIZONTAL : RBW:1000.000KHz VBW:3000.000KHz SWT:Auto</p>	Left blank

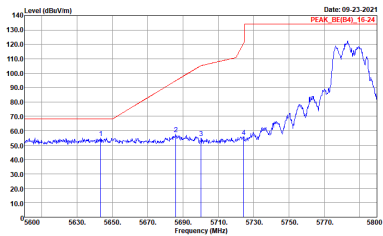
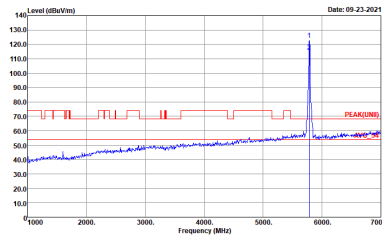
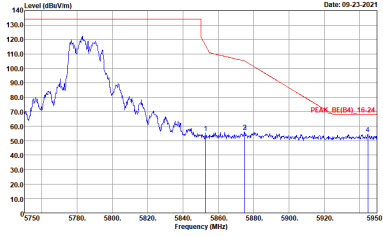

WIFI	UNII-3 5725~5850MHz Band Edge @ 3m	
802.11ax HE20 Full CH157 5785MHz		
Vertical		Fundamental
Peak	 <p>Site : 03CH02-CA Condition : PEAK_BE(B4)_16-24 3m HORN 91200-HF_02113 VERTICAL : RBW:1000.000KHz VBW:3000.000KHz SWT:Auto</p>	 <p>Site : 03CH02-CA Condition : PEAK(LINE) 3m HORN 91200-HF_02113 VERTICAL : RBW:1000.000KHz VBW:3000.000KHz SWT:Auto</p>
Peak	 <p>Site : 03CH02-CA Condition : PEAK_BE(B4)_16-24 3m HORN 91200-HF_02113 VERTICAL : RBW:1000.000KHz VBW:3000.000KHz SWT:Auto</p>	Left blank

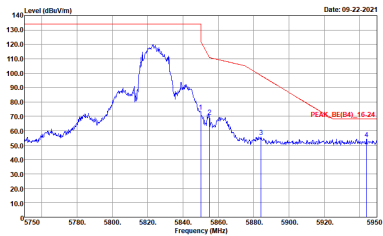
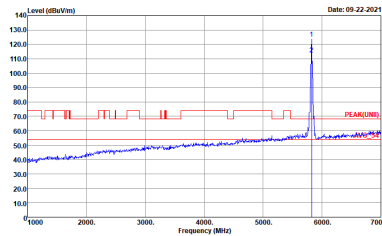

WIFI	UNII-3 5725~5850MHz Band Edge @ 3m	
	802.11ax HE20 Full CH165 5825MHz	
	Horizontal	Fundamental
Peak	 <p>Site : 03CH02-CA Condition : PEAK_BI(BA)_16-24 3m HORN 91200-HF_02113 HORIZONTAL : RBW:1000.000KHz VBW:3000.000KHz SWT:Auto</p>	 <p>Site : 03CH02-CA Condition : PEAK(LINE) 3m HORN 91200-HF_02113 HORIZONTAL : RBW:1000.000KHz VBW:3000.000KHz SWT:Auto</p>



WIFI	UNII-3 5725~5850MHz Band Edge @ 3m	
802.11ax HE20 Full CH165 5825MHz		
Vertical		Fundamental
Peak	<p>Site : 03CH02-CA Condition : PEAK_BU(BU)_16-24 3m HORN 91200-HF_02113 VERTICAL : RBW:1000.000KHz VBW:3000.000KHz SWT:Auto</p>	<p>Site : 03CH02-CA Condition : PEAK(LINE) 3m HORN 91200-HF_02113 VERTICAL : RBW:1000.000KHz VBW:3000.000KHz SWT:Auto</p>



UNII-3 - 5725~5850MHz

WIFI 802.11ax HE20 Partial RU 52 (Band Edge @ 3m)

WIFI	UNII-3 5725~5850MHz Band Edge @ 3m	
ANT	802.11ax HE20 Partial RU 52_52_52_52 CH149 5745MHz	
	Horizontal	Fundamental
Peak	<p>Site : 03CH02-CA Condition : PEAK_BE(B4)_16-21 3m HORN_02113_220622 HORIZONTAL :RBW:1000.0000Hz VBW:3000.0000Hz SWT:Auto</p>	<p>Site : 03CH02-CA Condition : PEAK(UNII) 3m HORN_02113_220622 HORIZONTAL :RBW:1000.0000Hz VBW:3000.0000Hz SWT:Auto</p>
Avg	<p>Left blank</p> <p>Site : 03CH02-CA Condition : AVG_54 3m HORN_02113_220622 HORIZONTAL :RBW:1000.0000Hz VBW:0.3000Hz SWT:Auto</p>	

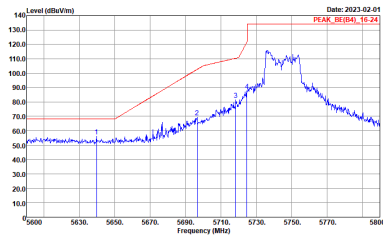
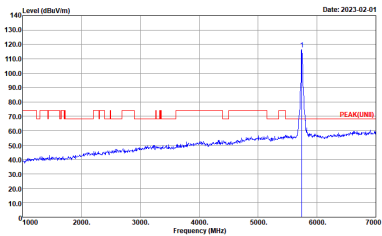
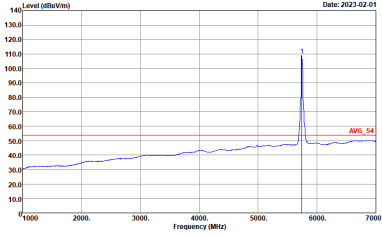

WIFI	UNII-3 5725~5850MHz Band Edge @ 3m	
ANT	802.11ax HE20 Partial RU 52_52_52_52 CH149 5745MHz	
Peak	<p style="text-align: center;">Vertical</p>  <p>Site : 03CH02-CA Condition : PEAK_BE(B4)_16-24 3m HORN_02113_220622 VERTICAL : RBW:1000.0000Hz VBW:3000.0000Hz SWT:Auto</p>	<p style="text-align: center;">Fundamental</p>  <p>Site : 03CH02-CA Condition : PEAK(UN1) 3m HORN_02113_220622 VERTICAL : RBW:1000.0000Hz VBW:3000.0000Hz SWT:Auto</p>
	<p style="text-align: center;">Avg</p>	<p style="text-align: center;">Left blank</p>  <p>Site : 03CH02-CA Condition : AVG_54 3m HORN_02113_220622 VERTICAL : RBW:1000.0000Hz VBW:3000.0000Hz SWT:Auto</p>

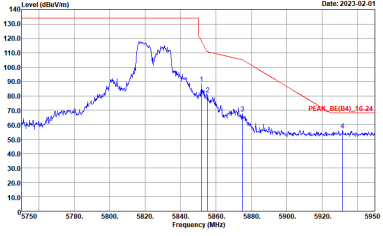
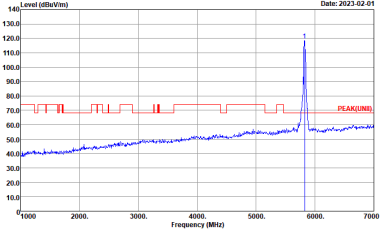
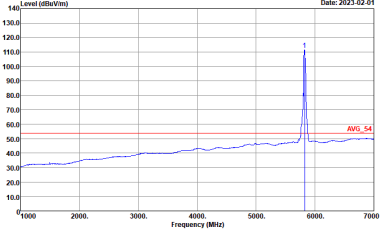

WIFI	UNII-3 5725~5850MHz Band Edge @ 3m	
ANT	802.11ax HE20 Partial RU 52_52_52_52 CH165 5825MHz	
	Horizontal	Fundamental
Peak	 <p>Level (dBm/1m) vs Frequency (MHz) plot showing a peak at approximately 5825 MHz. The y-axis ranges from 10.0 to 140.0 dBm/1m, and the x-axis ranges from 5750 to 5950 MHz. A red line indicates the peak level at 16.24 dBm/1m.</p> <p>Site : 03CH02-CA Condition : PEAK_BED04_16-24 3m HORN_02113_220622 HORIZONTAL : RBW:1000.000kHz VBW:3000.000kHz SWT:Auto</p>	 <p>Level (dBm/1m) vs Frequency (MHz) plot showing a sharp peak at approximately 5825 MHz. The y-axis ranges from 10.0 to 140.0 dBm/1m, and the x-axis ranges from 1000 to 7000 MHz. A red line indicates the peak level at 16.24 dBm/1m.</p> <p>Site : 03CH02-CA Condition : PEAK(UN1) 3m HORN_02113_220622 HORIZONTAL : RBW:1000.000kHz VBW:3000.000kHz SWT:Auto</p>
Avg	Left blank	
		 <p>Level (dBm/1m) vs Frequency (MHz) plot showing a sharp peak at approximately 5825 MHz. The y-axis ranges from 10.0 to 140.0 dBm/1m, and the x-axis ranges from 1000 to 7000 MHz. A red line indicates the average level at 54 dBm/1m.</p> <p>Site : 03CH02-CA Condition : AVG_54 3m HORN_02113_220622 HORIZONTAL : RBW:1000.000kHz VBW:3000.000kHz SWT:Auto</p>

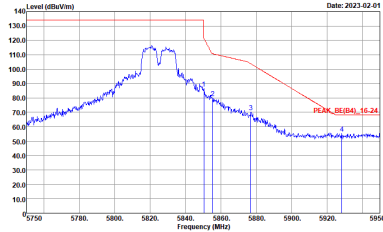
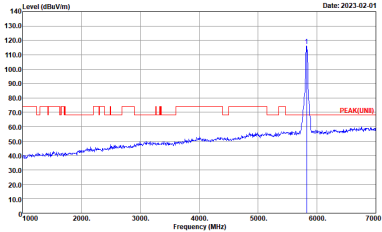
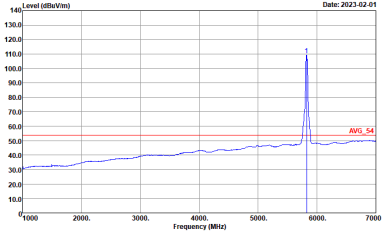

WIFI	UNII-3 5725~5850MHz Band Edge @ 3m	
ANT	802.11ax HE20 Partial RU 52_52_52_52 CH165 5825MHz	
	Vertical	Fundamental
Peak	 <p>Site : 03CH02-CA Condition : PEAK_B0(B4)_16-24 3m HORN_02113_220622 VERTICAL : RBW:1000.000kHz VBW:3000.000kHz SWT:Auto</p>	 <p>Site : 03CH02-CA Condition : PEAK(UIN) 3m HORN_02113_220622 VERTICAL : RBW:1000.000kHz VBW:3000.000kHz SWT:Auto</p>
Avg	Left blank	
		 <p>Site : 03CH02-CA Condition : AVG_54 3m HORN_02113_220622 VERTICAL : RBW:1000.000kHz VBW:3000.000kHz SWT:Auto</p>



UNII-3 5725~5850MHz
WIFI 802.11ax HE40 Full (Band Edge @ 3m)

Table with 2 columns (WIFI) and 2 rows (Peak). Headers include 'UNII-3 5725~5850MHz Band Edge @ 3m' and '802.11ax HE40 Full CH151 5755MHz'. Content includes 'Horizontal' and 'Fundamental' plots with Level (dBm/Vm) vs Frequency (MHz) graphs and associated site/condition details.

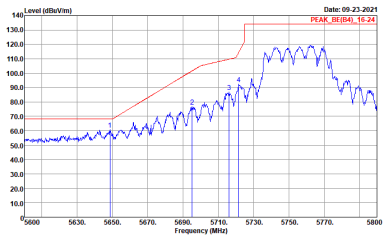
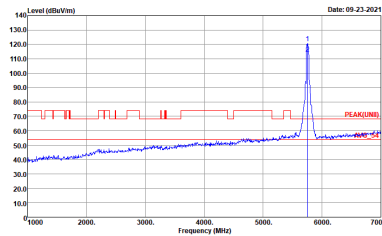
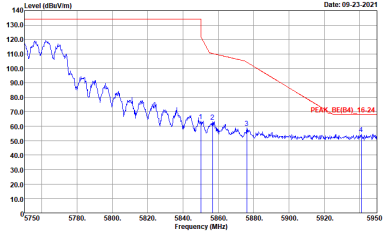

WIFI	UNII-3 5725~5850MHz Band Edge @ 3m	
802.11ax HE40 Full CH151 5755MHz		
Vertical		Fundamental
Peak	 <p>Date: 09-23-2021 PEAK_BE(B4)_16-24</p> <p>Site : 03CH02-CA Condition : PEAK_BE(B4)_16-24 3m HORN 91200-HF_02113 VERTICAL : RBW:1000.000KHz VBW:3000.000KHz SWT:Auto</p>	 <p>Date: 09-23-2021 PEAK(LINE)</p> <p>Site : 03CH02-CA Condition : PEAK(LINE) 3m HORN 91200-HF_02113 VERTICAL : RBW:1000.000KHz VBW:3000.000KHz SWT:Auto</p>
Peak	 <p>Date: 09-23-2021 PEAK_BE(B4)_16-24</p> <p>Site : 03CH02-CA Condition : PEAK_BE(B4)_16-24 3m HORN 91200-HF_02113 VERTICAL : RBW:1000.000KHz VBW:3000.000KHz SWT:Auto</p>	Left blank

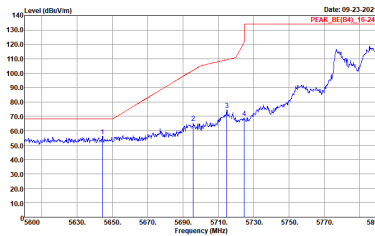
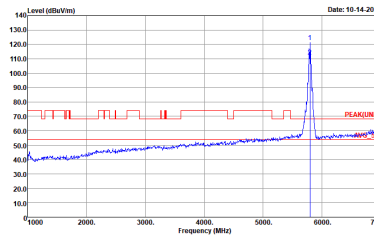
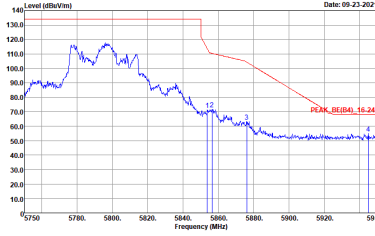

WIFI	UNII-3 5725~5850MHz Band Edge @ 3m	
	802.11ax HE40 Full HT40 CH159 5795MHz	
	Horizontal	Fundamental
Peak	 <p>Date: 09-23-2021 PEAK_BE(B4)_16-24</p> <p>Site : 03CH02-CA Condition : PEAK_BE(B4)_16-24 3m HORN 91200-HF_02113 HORIZONTAL : RBW:1000.000KHz VBW:3000.000KHz SWT:Auto</p>	 <p>Date: 10-14-2021 PEAK(LINE)</p> <p>Site : 03CH02-CA Condition : PEAK(LINE) 3m HORN 91200-HF_02113 HORIZONTAL : RBW:1000.000KHz VBW:3000.000KHz SWT:Auto</p>
Peak	 <p>Date: 09-23-2021 PEAK_BE(B4)_16-24</p> <p>Site : 03CH02-CA Condition : PEAK_BE(B4)_16-24 3m HORN 91200-HF_02113 HORIZONTAL : RBW:1000.000KHz VBW:3000.000KHz SWT:Auto</p>	Left blank