

R760 Antenna Gains

Engineer	Manager
Jim Jervis	Anand Krishnamachari
03/15/2023	03/15/2023
Revision History	
Revision and Date	Note
1.0 - 01/31/2022	Initial release
2.0 – 02/21/2023	Antenna patterns updated as per FCC new requirements
2.1 – 03/15/2023	Test setup pictures added

Ruckus Wireless Inc.

350 West Java Dr.

Sunnyvale, CA 94089, USA

Tel: (650) 265-4200

Fax: (408) 738-2065

This document provides the azimuth cuts containing the maximum antenna gain at the listed frequencies

Frequency Bands

No	Operational Band	Center Freq.	Designator
1	2400 - 2483.5 MHz	2.45 GHz	ISM
2	5150 - 5250 MHz	5.15 GHz	UNII-1
3	5250 – 5725 MHz	5.5 GHz	UNII-2
4	5725 – 5850 MHz	5.8 GHz	UNII-3
5		5.9 GHz	UNII-4 (Not used; data not provided)
6	5925 – 6425 MHz	6.2 GHz	UNII-5
7	6425 – 6525 MHz	6.5 GHz	UNII-6
8	6525 – 6875 MHz	6.65 GHz	UNII-7
9	6875 – 7125 MHz	7 GHz	UNII-8

All antennas of access point R760 were measured in a Satimo Stargate quasi-nearfield range with Jim Jervis as operator. Each antenna was measured over the 2.4 GHz band and over each of the UNII bands. The maximum gain was taken from the measurements and is listed in the table on the following page. All antennas are omni-directional and are integrated within the product. The product is in development and therefore the test unit has no serial number.

The product has 5 antennas: a horizontally polarized 6 GHz antenna, a horizontally polarized dual band (2.4 and 5 GHz) dual-band antenna, a vertically polarized dual-band antenna (2.4 and 5 GHz), a vertically polarized vertical antenna for 6 GHz, and an IOT antenna, mostly vertically polarized.

Location of antennas are shown below:

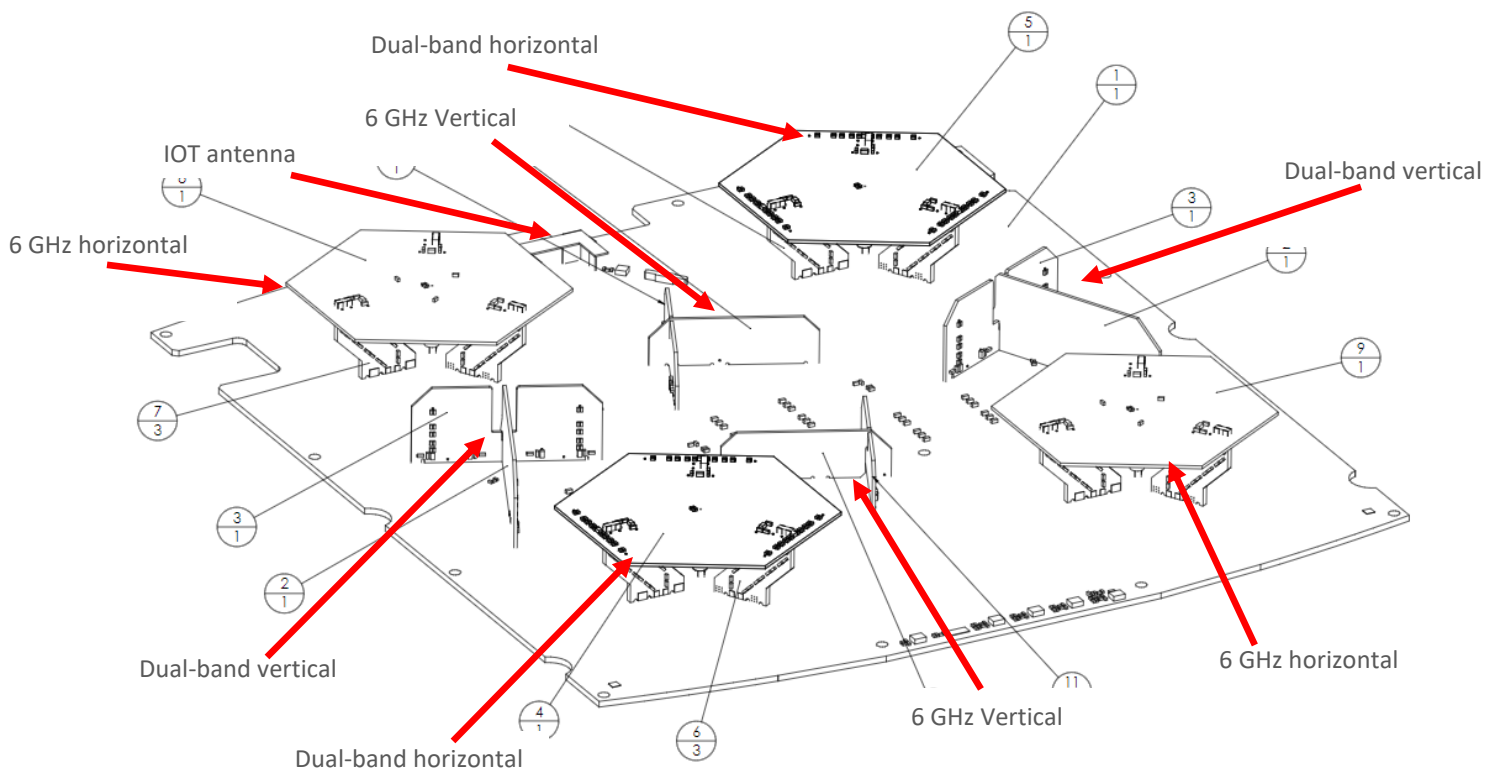

This Product deploy distinct MIMO system where dual RF outputs for each WiFi radio are connected each to linearly cross polarized antennas which are mounted on Main board as indicated in Exhibits - Internal pictures.

Horizontal and Vertical internal antennas are cross-polarized to ensure transmitting outputs are 90-degree phase-shifted replica of each other and the phase centers of the two antennas are co-located.

Antenna Gain Table		
Antenna	Frequency band	Max Gain (dBi)
Dual-band vertical	2.4 GHz	2.5
Dual-band vertical	UNII-1	2.9
Dual-band vertical	UNII-2	2.9
Dual-band vertical	UNII-3	2.9
Dual-band horizontal	2.4 GHz	0.1
Dual-band horizontal	UNII-1	2.9
Dual-band horizontal	UNII-2	2.9
Dual-band horizontal	UNII-3	2.9
6 GHz vertical	UNII-5	3.7
6 GHz vertical	UNII-6	3.7
6 GHz vertical	UNII-7	3.7
6 GHz vertical	UNII-8	3.7
6 GHz horizontal	UNII-5	3.8
6 GHz horizontal	UNII-6	3.8
6 GHz horizontal	UNII-7	3.8
6 GHz horizontal	UNII-8	3.8
IOT	2.4 GHz	3

Antenna Patterns:

Antennas A and D, Dual band (2.4 GHz and 5 GHz) vertical 2.4 GHz
 Max gain 2.5 dBi 2.4 GHz band

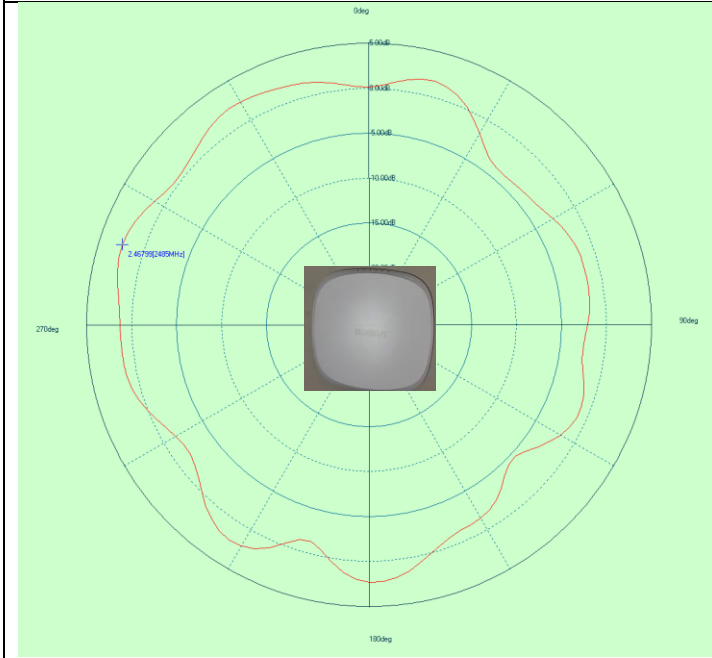

Antennas A and D, Dual band (2.4 GHz and 5 GHz) vertical
 Max gain 2.9 dBi at 5.15 GHz band UNII-1 band

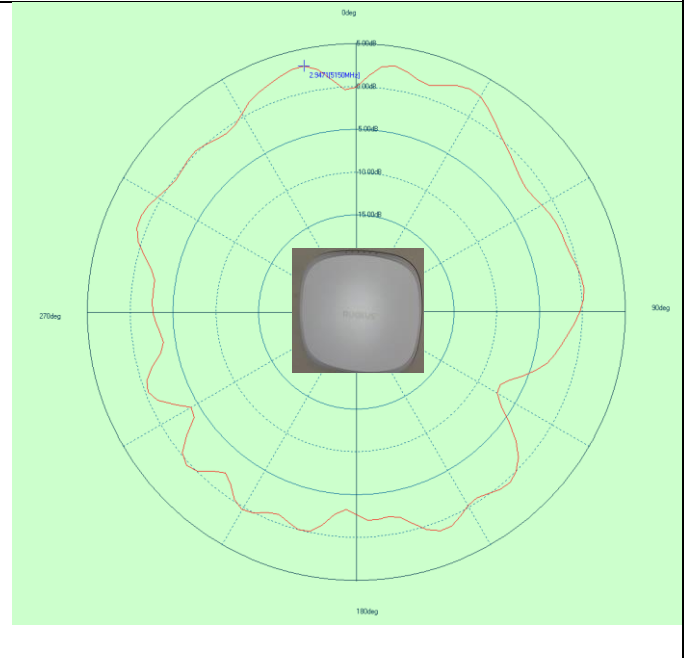

Antennas A and D, Dual band (2.4 GHz and 5 GHz) vertical
 Max gain 2.9 dBi at 5.4 GHz band UNII-2 band

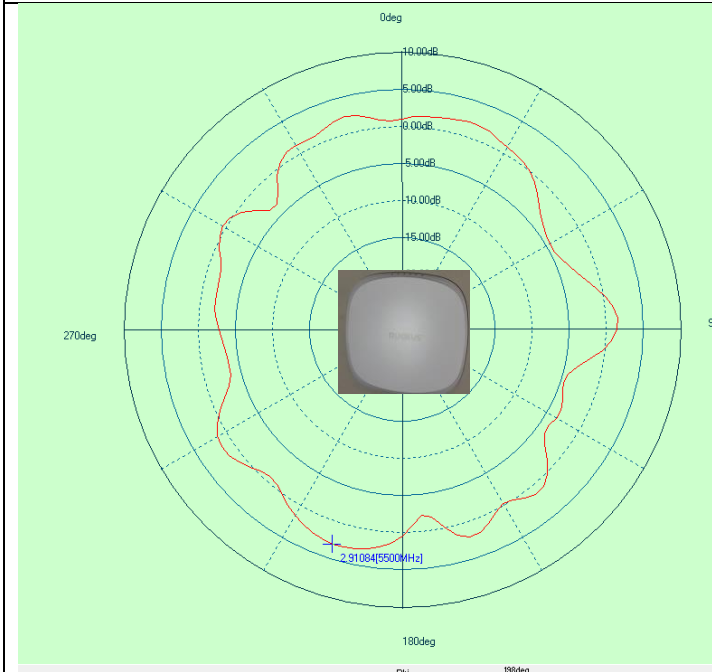

Antennas A and D, Dual band (2.4 GHz and 5 GHz) vertical
 Max gain 2.9 dBi at 5.8 GHz band UNII-3 band

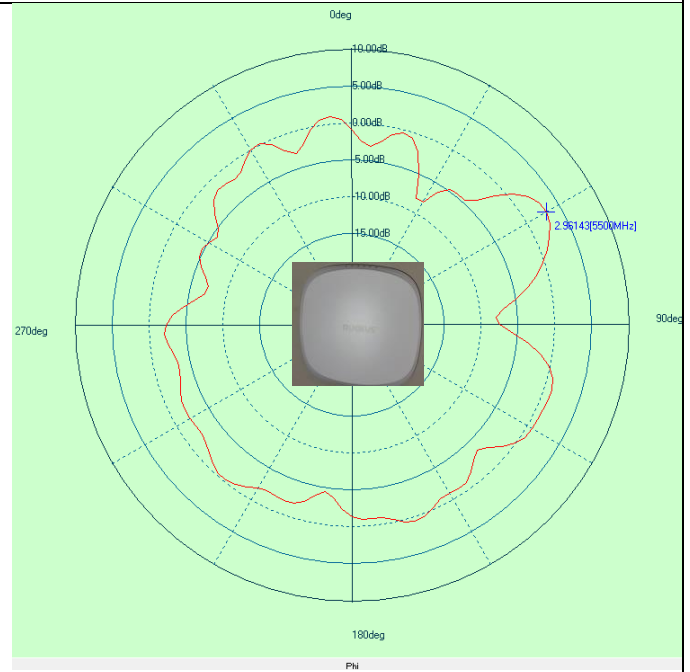

Antennas B and C Dual band (2.4 GHz and 5 GHz) horizontal
 Max gain 0.1 dBi in 2.4 GHz band

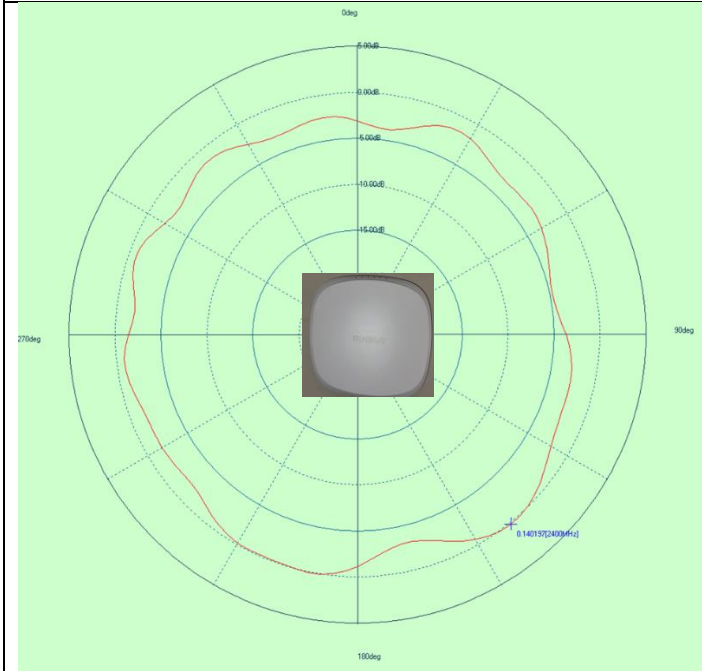

Antennas B and C, Dual band (2.4 GHz and 5 GHz) horizontal
 Max gain 2.9 dBi in 5.15 GHz UNII-1 band

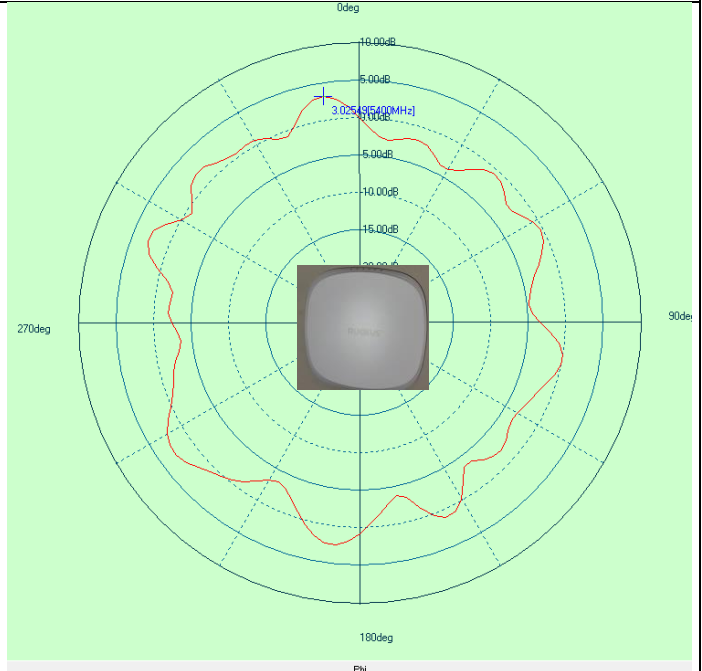

Antennas B and C, Dual band (2.4 GHz and 5 GHz) horizontal
 Max gain 2.9 dBi in 5.4 GHz UNII-2 band

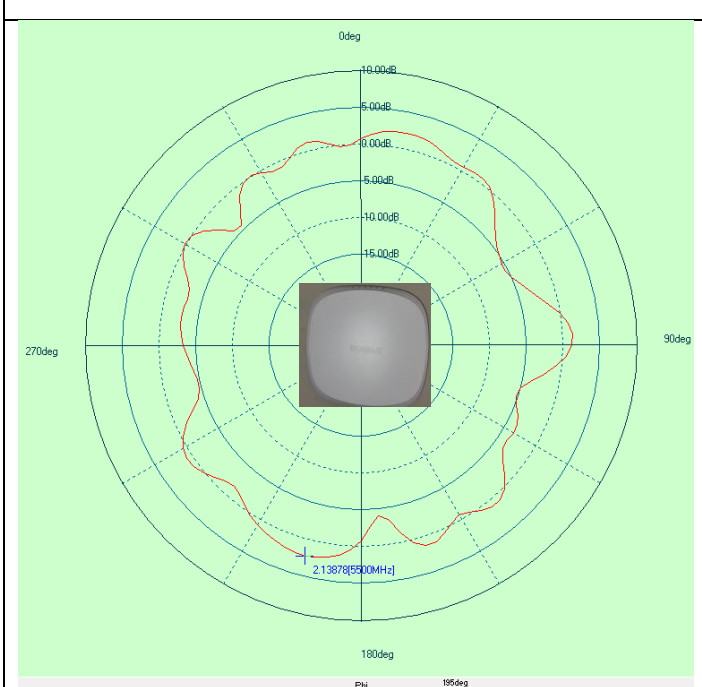

Antennas B and C, Dual band (2.4 GHz and 5 GHz) horizontal
 Max gain 2.9 dBi in 5.8 GHz UNII-3 band

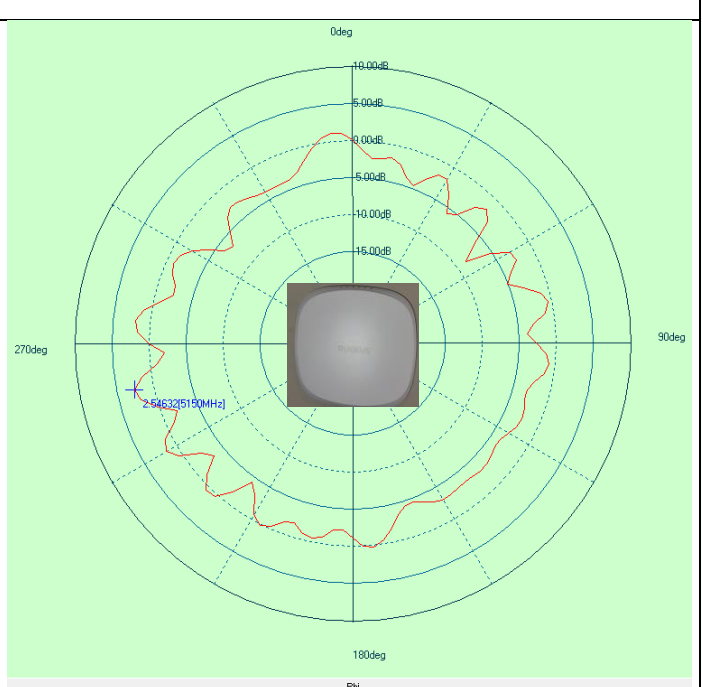

Antennas E and H, 6 GHz vertical
 Max gain 3.7 dBi in 6.2 GHz UNII-5 band

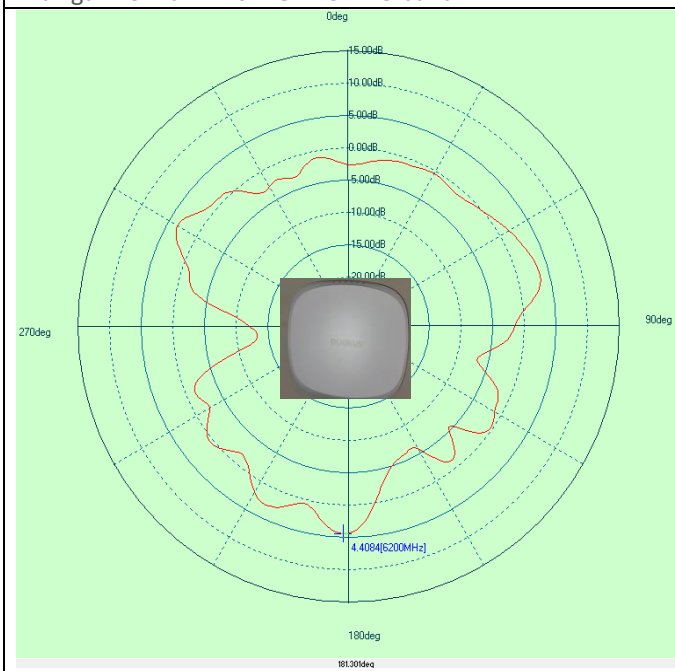

Antennas E and H, 6 GHz vertical
 Max gain 3.7 dBi in 6.5 GHz UNII-6 band

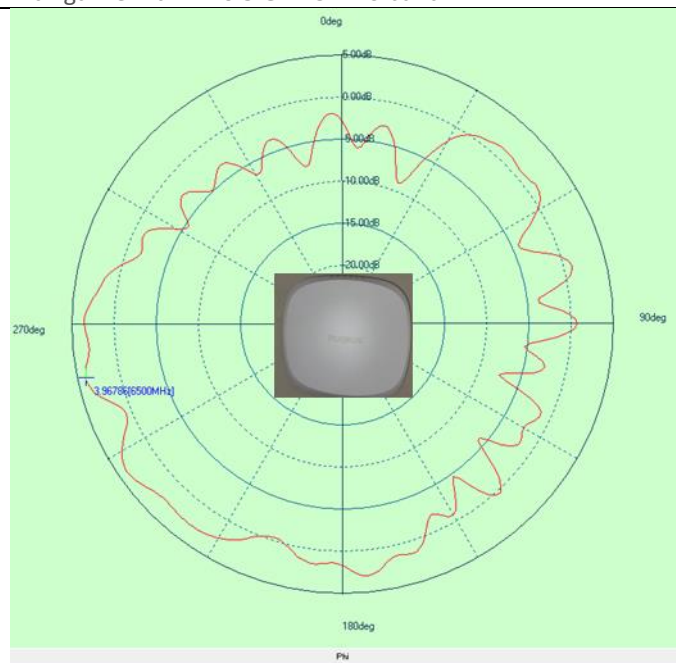

Antennas E and H, 6 GHz vertical
 Max gain 3.7 dBi in 6.65 GHz UNII-7 band

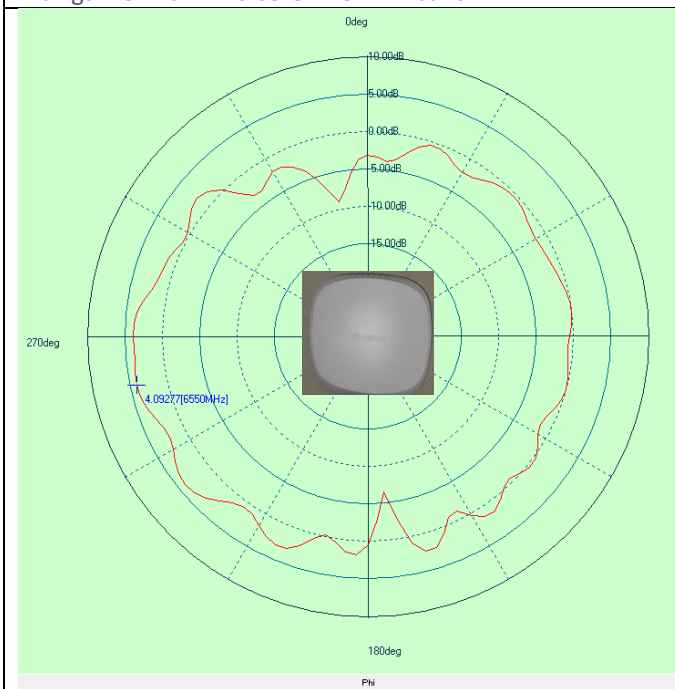

Antennas E and H, 6 GHz vertical
 Max gain 3.71 dBi in 7 GHz UNII-8 band

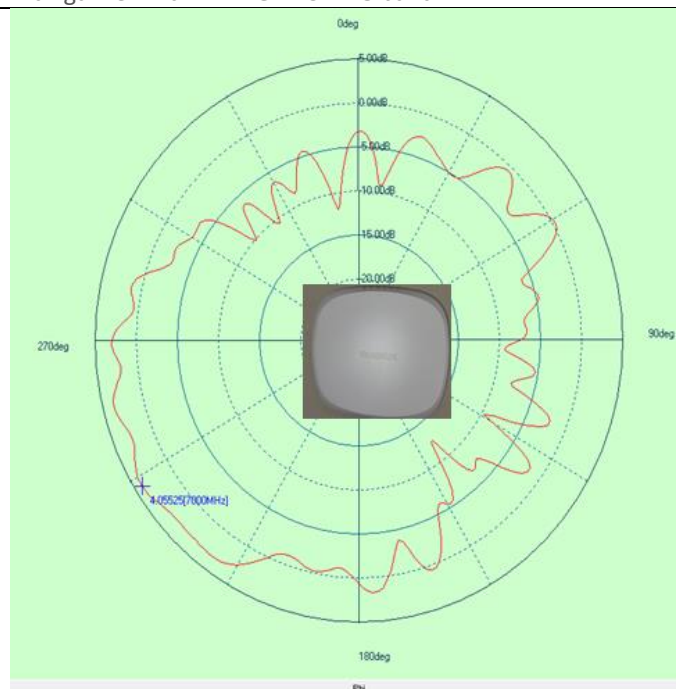

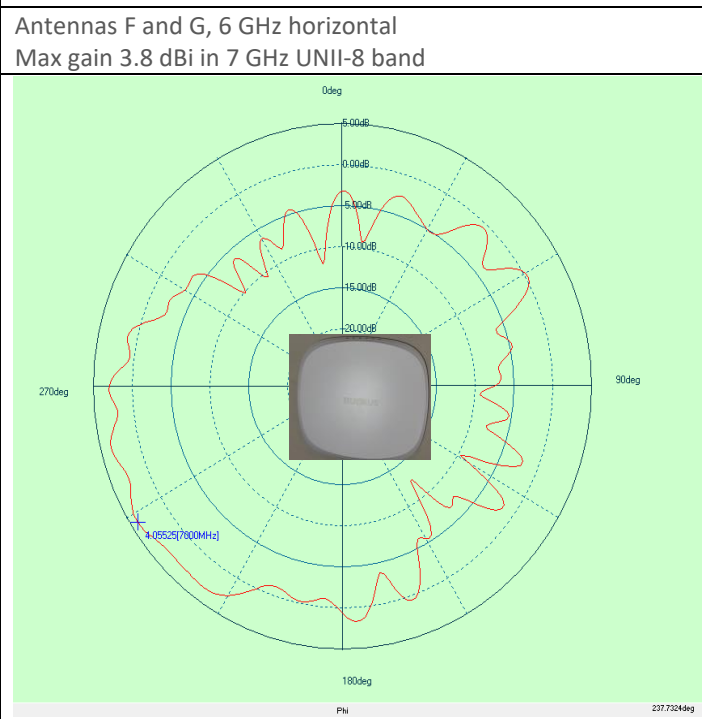
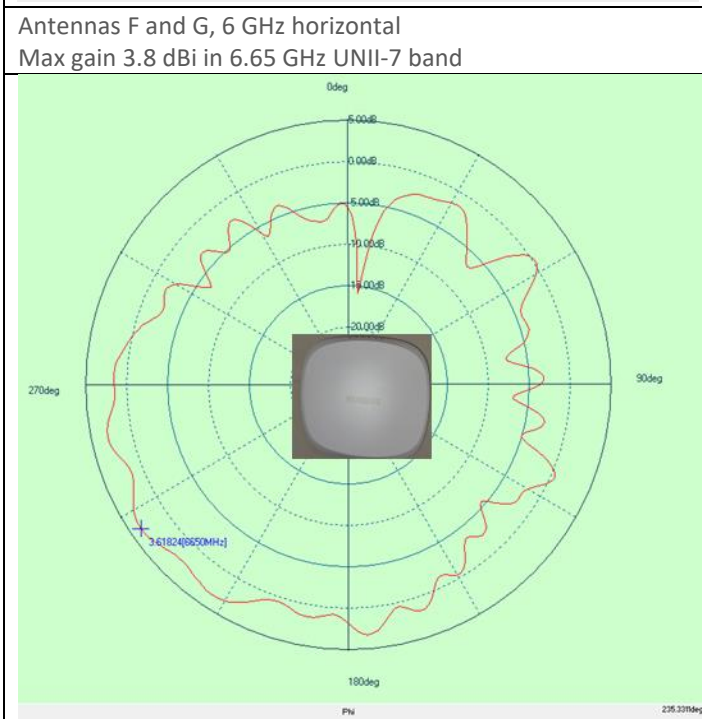
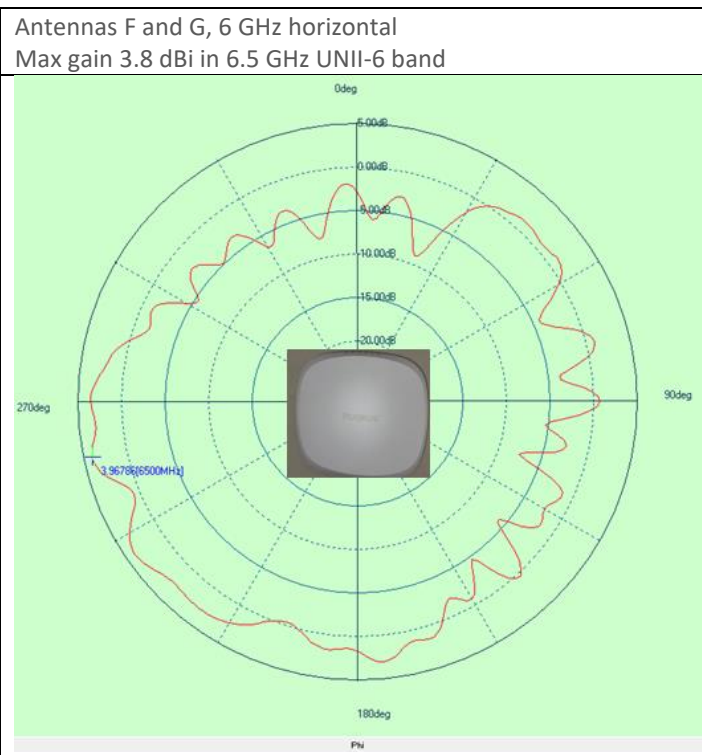
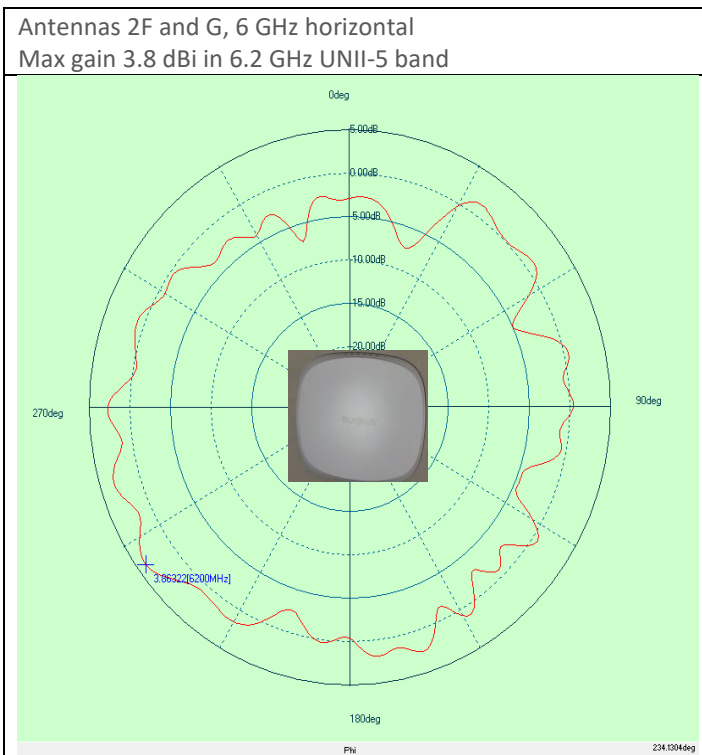

Antenna 5, 2.4 GHz IOT antenna
Max Gain 3.0 dBi in 2.4 GHz band

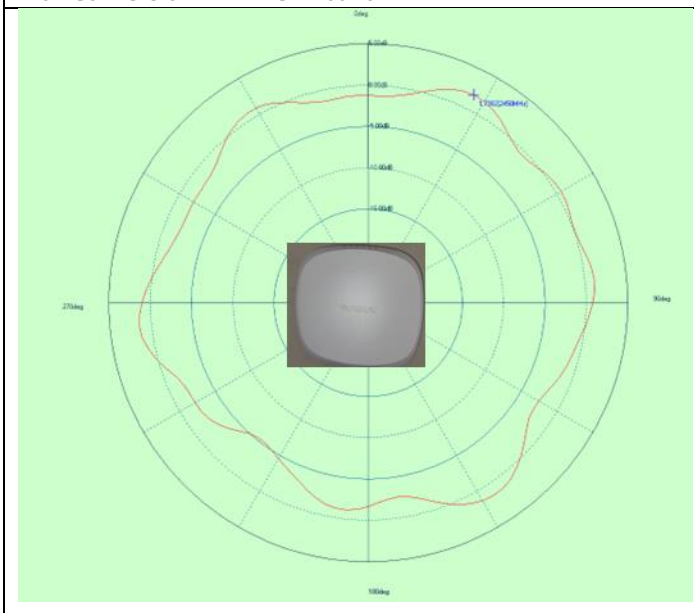

Test setup pictures – MIMO Anechoic chamber

