



# FCC RADIO TEST REPORT

**FCC ID** : S9GR760  
**Equipment** : R760 Access Point  
**Brand Name** : RUCKUS  
**Model Name** : R760  
**Applicant** : Ruckus Wireless Inc.  
350 W. Java Dr., Sunnyvale CA 94089 USA  
**Manufacturer** : Ruckus Wireless Inc.  
350 W. Java Dr., Sunnyvale CA 94089 USA  
**Standard** : FCC PART 15 Subpart C §15.247

The product was received on Jul. 28, 2021 and testing was performed from Aug. 15, 2021 to Dec. 17, 2021. We, Sporton International (USA) Inc., would like to declare that the tested sample has been evaluated in accordance with the test procedures and has been in compliance with the applicable technical standards.

The test results in this report apply exclusively to the tested model / sample. Without written approval from Sporton International (USA) Inc., the test report shall not be reproduced except in full.

Approved by: Neil Kao

**Sporton International (USA) Inc.**  
1175 Montague Expressway, Milpitas, CA 95035



## Table of Contents

History of this test report.....	3
Summary of Test Result.....	4
<b>1 General Description .....</b>	<b>5</b>
1.1 Product Feature of Equipment Under Test.....	5
1.2 Modification of EUT .....	6
1.3 Testing Location .....	6
1.4 Applicable Standards.....	6
<b>2 Test Configuration of Equipment Under Test .....</b>	<b>7</b>
2.1 Carrier Frequency and Channel .....	7
2.2 Test Mode.....	8
2.3 Connection Diagram of Test System.....	10
2.4 Support Unit used in test configuration and system .....	11
2.5 EUT Operation Test Setup .....	11
2.6 Measurement Results Explanation Example.....	11
<b>3 Test Result .....</b>	<b>12</b>
3.1 6dB and 99% Bandwidth Measurement .....	12
3.2 Output Power Measurement.....	15
3.3 Power Spectral Density Measurement .....	16
3.4 Conducted Band Edges and Spurious Emission Measurement .....	21
3.5 Radiated Band Edges and Spurious Emission Measurement .....	70
3.6 AC Conducted Emission Measurement.....	74
3.7 Antenna Requirements .....	76
<b>4 List of Measuring Equipment.....</b>	<b>79</b>
<b>5 Uncertainty of Evaluation.....</b>	<b>80</b>
<b>Appendix A. Conducted Test Results</b>	
<b>Appendix B. AC Conducted Emission Test Result</b>	
<b>Appendix C. Radiated Spurious Emission</b>	
<b>Appendix D. Radiated Spurious Emission Plots</b>	
<b>Appendix E. Duty Cycle Plots</b>	
<b>Appendix F. Setup Photographs</b>	



## Summary of Test Result

Report Clause	Ref Std. Clause	Test Items	Result (PASS/FAIL)	Remark
3.1	15.247(a)(2)	6dB Bandwidth	Pass	-
3.1	2.1049	99% Occupied Bandwidth	Reporting only	-
3.2	15.247(b)	Power Output Measurement	Pass	-
3.3	15.247(e)	Power Spectral Density	Pass	-
3.4	15.247(d)	Conducted Band Edges	Pass	-
		Conducted Spurious Emission	Pass	-
3.5	15.247(d)	Radiated Band Edges and Radiated Spurious Emission	Pass	0.19 dB under the limit at 2390.000 MHz
3.6	15.207	AC Conducted Emission	Pass	9.27 dB under the limit at 0.369 MHz
3.7	15.203 & 15.247(b)	Antenna Requirement	Pass	-

**Declaration of Conformity:**

The test results with all measurement uncertainty excluded are presented in accordance with the regulation limits or requirements declared by manufacturers.

**Comments and Explanations:**

The product specifications of the EUT presented in the report are declared by the manufacturer who shall take full responsibility for the authenticity.



# 1 General Description

## 1.1 Product Feature of Equipment Under Test

The EUT is an indoor AP with radios including Bluetooth - LE, Wi-Fi 2.4GHz 802.11b/g/n/ac/ax, Wi-Fi 5GHz 802.11a/n/ac/ax, Wi-Fi 6GHz 802.11a/n/ac/ax, 802.15.4 (Zigbee), equipped with integrated antennas configured below:

Antenna Configuration			
Antenna Type	<b>WLAN 2.4GHz</b> <Ant. A>: Omni Antenna <Ant. B>: Omni Antenna <Ant. C>: Omni Antenna <Ant. D>: Omni Antenna <b>WLAN 5GHz</b> <b>Radio 1 and Radio 2:</b> <Ant. A>: Omni Antenna <Ant. B>: Omni Antenna <Ant. C>: Omni Antenna <Ant. D>: Omni Antenna <b>Radio 3:</b> <Ant. E>: Omni Antenna <Ant. F>: Omni Antenna <Ant. G>: Omni Antenna <Ant. H>: Omni Antenna <b>WLAN 6GHz</b> <Ant. E>: Omni Antenna <Ant. F>: Omni Antenna <Ant. G>: Omni Antenna <Ant. H>: Omni Antenna <b>Bluetooth-LE:</b> <Ant. 1>Omni Antenna <b>Zigbee:</b> <Ant. 1>Omni Antenna		
	<b>Antenna information</b>		
2400 MHz ~ 2483.5 MHz	Peak Gain (dBi)	Vertical	<Ant. A>: 2.5 <Ant. D>: 2.5
		Horizontal	<Ant. B>: 0.1 <Ant. C>: 0.1

**Remark:**

1. The above EUT's information is declared by manufacturer. Please refer to Comments and Explanations in report summary.
2. The device is a special case of MIMO system with four outputs driving a cross-polarized pair of linearly polarized antennas (noted as "vertical" and "horizontal").  
The antenna printed on the secondary board which is vertically/horizontally mounted on the main board.



## 1.2 Modification of EUT

No modifications made to the EUT during the testing.

## 1.3 Testing Location

Test Site	Sporton International (USA) Inc.
Test Site Location	1175 Montague Expressway, Milpitas, CA 95035 TEL : 408 9043300
Test Site No.	<b>Sporton Site No.</b> TH01-CA, CO01-CA, 03CH02-CA

**Note:** The test site complies with ANSI C63.4 2014 requirement.

## 1.4 Applicable Standards

According to the specifications declared by the manufacturer, the EUT must comply with the requirements of the following standards:

- ♦ FCC Part 15 Subpart C §15.247
- ♦ FCC KDB Publication No. 558074 D01 DTS Meas. Guidance v05r02
- ♦ FCC KDB 414788 D01 Radiated Test Site v01r01.
- ♦ FCC KDB 662911 D01 Multiple Transmitter Output v02r01.
- ♦ ANSI C63.10-2013

**Remark:** All test items were verified and recorded according to the standards without any deviation during the test.



## 2 Test Configuration of Equipment Under Test

- a. The EUT has been associated with peripherals and configuration operated in a manner tended to maximize its emission characteristics in a typical application. Frequency range investigated: conduction emission (150 kHz to 30 MHz), radiation emission (9 kHz to the 10th harmonic of the highest fundamental frequency or to 40 GHz, whichever is lower). For radiated measurement, the measured emission level of the EUT was maximized by rotating the EUT on a turntable, adjusting the orientation of the EUT and EUT antenna in three orthogonal axis (X: flat, Y: portrait, Z: landscape), and adjusting the measurement antenna orientation, following C63.10 exploratory test procedures and find Z plane as worst plane.
  
- b. AC power line Conducted Emission was tested under maximum output power.

### 2.1 Carrier Frequency and Channel

Frequency Band	Channel	Freq. (MHz)	Channel	Freq. (MHz)
2400-2483.5 MHz 20MHz channel	1	2412	7	2442
	2	2417	8	2447
	3	2422	9	2452
	4	2427	10	2457
	5	2432	11	2462
	6	2437		
2400-2483.5 MHz 40MHz channel	3	2422	8	2447
	4	2427	9	2452
	5	2432	10	2457
	6	2437	11	2462
	7	2442		



## 2.2 Test Mode

All modulation schemes/data rate are verified by conducted power test case, and the modulation schemes with highest power is used for all test cases. The final test items are considering the modulation schemes and the worst data rates as the table below.

### CDD Mode

Modulation	MCS index /Data Rate
802.11b	1 Mbps
802.11g	6 Mbps
802.11n HT20 (Covered by HE20)	MCS0
802.11n HT40 (Covered by HE40)	MCS0
802.11ac VHT20 (Covered by HE20)	MCS0
802.11ac VHT40 (Covered by HE40)	MCS0
802.11ax HE20	MCS0
802.11ax HE40	MCS0

### TXBF Mode

Modulation	MCS index /Data Rate
802.11n HT20 (Covered by HE20)	MCS0
802.11n HT40 (Covered by HE40)	MCS0
802.11ac VHT20 (Covered by HE20)	MCS0
802.11ac VHT40 (Covered by HE40)	MCS0
802.11ax HE20	MCS0
802.11ax HE40	MCS0

### Remark:

1. Since the verify power, the smaller power can be covered by the higher power. The SISO Mode is covered by MIMO Mode.
2. The 802.11ax covers the 802.11n, 802.11ac due to same modulation family scheme. For 802.11ax, only full resource unit assignment mode is tested.
3. After preliminary scan designated by the manufacturer, CDD mode is determined to be the worst case compared to Beamforming mode, hence, all the radiated test is performed in CDD mode.
4. The setup method between CDD and Beamforming mode is identical except that one of the polarizations is disabled while Beamforming mode is activated so both modes share the same conducted power table. The only difference is how directional gain is calculated between two modes.
5. Partial RUs are not supported at the current product stage, the test report and test results do not cover any Partial RU test assessments.





RF test channels are listed in the following table:

	2400-2483.5 MHz			
	802.11b	802.11g	802.11ax HE20	802.11ax HE40
Ch. #	01	01	01	03
	06	06	06	06
	11	11	11	09

**Remark:** For radiation spurious emission, the final modulation and the worst data rate was reference the max RF conducted power.

AC Conducted Emission Test Cases are listed in the following table:

Test Cases	
<b>AC Conducted Emission</b>	<p>Mode 1: WLAN (2.4GHz) Link + Bluetooth – LE Idle + Zigbee Link + WLAN (5GHz) Radio 2 Link + WLAN (6GHz) Link + AC Adapter + LAN 1 Link+ LAN 2 Link + USB Flash Drive (Load)</p> <p>Mode 2: WLAN (2.4GHz) Link + Bluetooth – LE Idle + Zigbee Link + WLAN (5GHz) Radio 3 Link + WLAN (5GHz) Radio 1 Link + AC Adapter + LAN 1 Link + LAN 2 Link + USB Flash Drive (Load)</p> <p>Mode 3: WLAN (2.4GHz) Link + Bluetooth – LE Link + Zigbee Idle + WLAN (5GHz) Radio 2 Link + WLAN (6GHz) Link + AC Adapter + LAN 1 Link + LAN 2 Link + USB Flash Drive (Load)</p>
<b>Remark:</b> The worst case of Conducted Emission is mode 1; only the test data of it was reported.	

## 2.3 Connection Diagram of Test System

<AC Conducted Emission Mode>

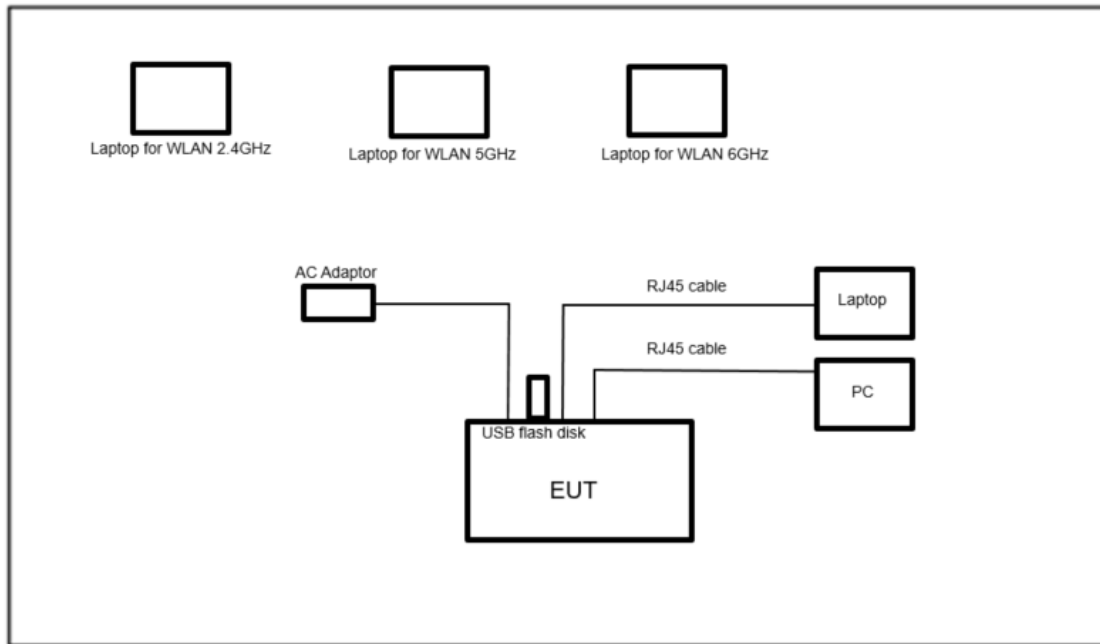

<Radiated Emission Mode>

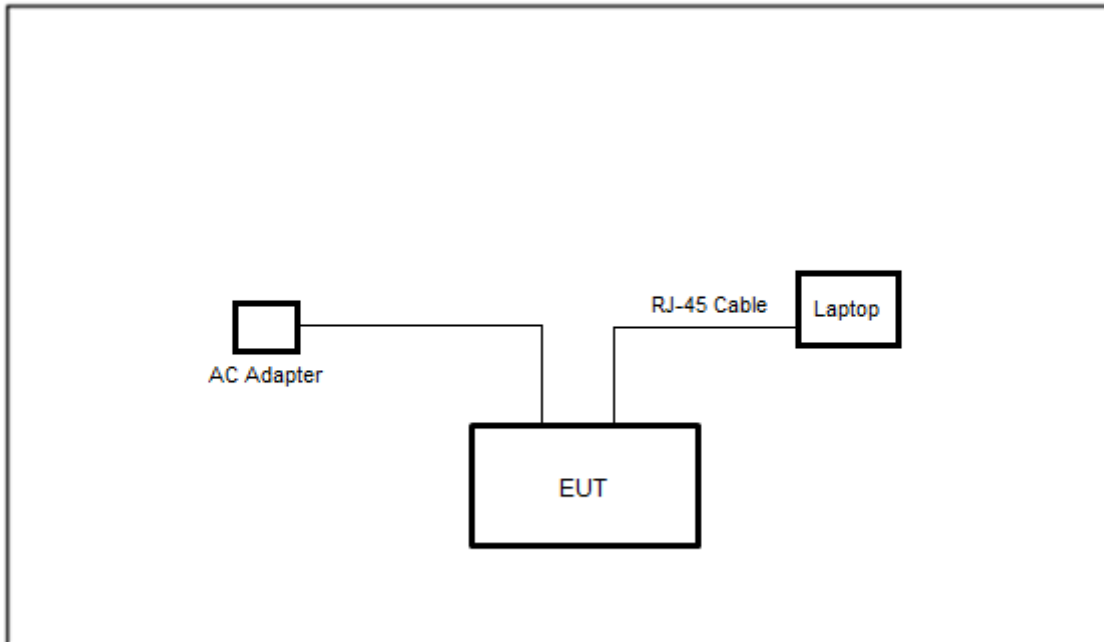

## 2.4 Support Unit used in test configuration and system

Item	Equipment	Brand Name	Model Name	FCC ID	Data Cable	Power Cord
1.	Notebook	ACER	Altos PS548-G1	FCC DoC	N/A	AC I/P: Unshielded, 1.2m DC O/P: Shielded, 1.8m
2.	Notebook	LENOVO	80RU	FCC DoC	N/A	AC I/P: Unshielded, 1.2m DC O/P: Shielded, 1.8m
3.	Notebook	MSI	MS-17F3	FCC DoC	N/A	AC I/P: Unshielded, 1.2m DC O/P: Shielded, 1.8m
4.	PC	Fractal	FD-C-DEF7A-01 (NETINTX550TR Intel X550T2BLK)	FCC DoC	N/A	AC I/P: Unshielded, 1.2m DC O/P: Shielded, 1.8m
5.	USB Flash Drive	SanDisk	N/A	N/A	N/A	N/A
6.	AC Adaptor	Ruckus	740-64277-001	N/A	N/A	Unshielded, 1.2m

## 2.5 EUT Operation Test Setup

The RF test items, utility “PuTTY Release 0.75” was installed in Notebook which was programmed in order to make the EUT get into the engineering modes to provide channel selection, power level, data rate and the application type and for continuous transmitting signals.

## 2.6 Measurement Results Explanation Example

**For all conducted test items:**

The offset level is set in the spectrum analyzer to compensate the RF cable loss and attenuator factor between EUT conducted output port and spectrum analyzer. With the offset compensation, the spectrum analyzer reading level is exactly the EUT RF output level.

Example:

The spectrum analyzer offset is derived from RF cable loss and attenuator factor.

*Offset = RF cable loss + attenuator factor.*

Following shows an offset computation example with cable loss 4.2 dB and 10 dB attenuator.

$$\begin{aligned} \text{Offset(dB)} &= \text{RF cable loss(dB)} + \text{attenuator factor(dB)}. \\ &= 4.2 + 10 = 14.2 \text{ (dB)} \end{aligned}$$

### 3 Test Result

#### 3.1 6dB and 99% Bandwidth Measurement

##### 3.1.1 Limit of 6dB and 99% Bandwidth

The minimum 6 dB bandwidth shall be at least 500 kHz.

##### 3.1.2 Measuring Instruments

Please refer to the measuring equipment list in this test report.

##### 3.1.3 Test Procedures

1. The testing follows the ANSI C63.10 Section 6.9.3 (OBW) and 11.8.1 (6dB BW).
2. The RF output of EUT is connected to the spectrum analyzer by RF cable and attenuator. The path loss is compensated to the results for each measurement.
3. Set the maximum power setting and enable the EUT to transmit continuously.
4. Make the measurement with the spectrum analyzer's resolution bandwidth (RBW) = 100 kHz. Set the Video bandwidth (VBW) = 300 kHz. In order to make an accurate measurement. The 6 dB bandwidth must be greater than 500 kHz.
5. For 99% Bandwidth Measurement, the spectrum analyzer's resolution bandwidth (RBW) is set 1-5% of the emission bandwidth and set the Video bandwidth (VBW)  $\geq 3 * RBW$ .
6. Measure and record the results in the test report.

##### 3.1.4 Test Setup



##### 3.1.5 Test Result of 6dB and 99% Occupied Bandwidth

Please refer to Appendix A.



<CDD Modes>

<802.11b>

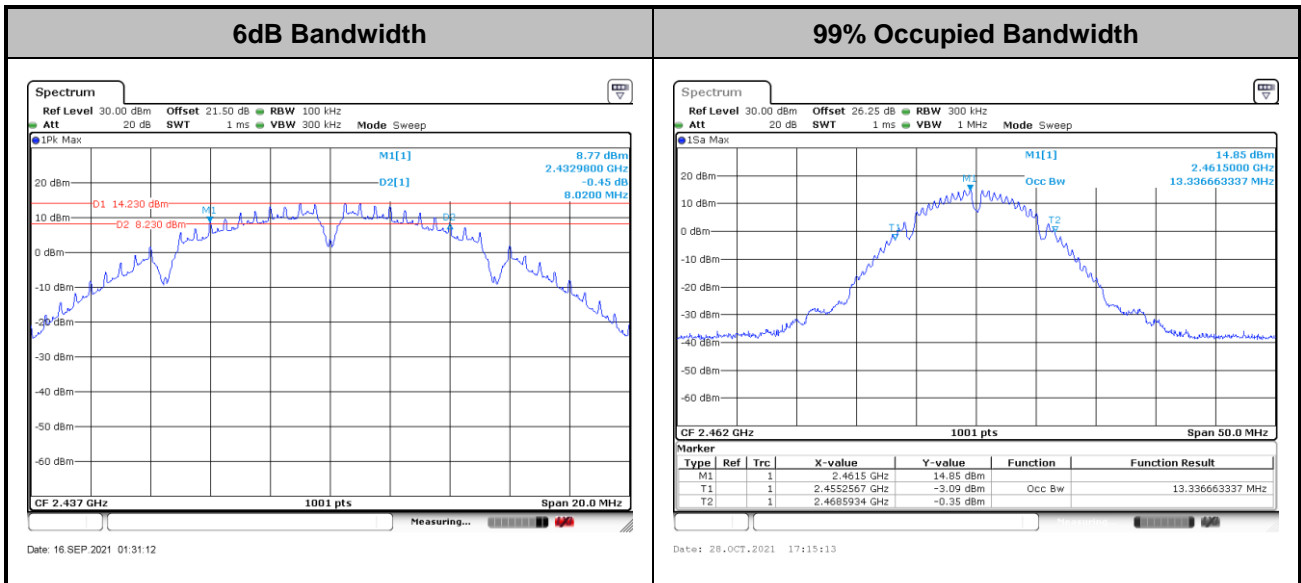

**Note:** The occupied channel bandwidth is maintained within the band of operation.

<802.11g>

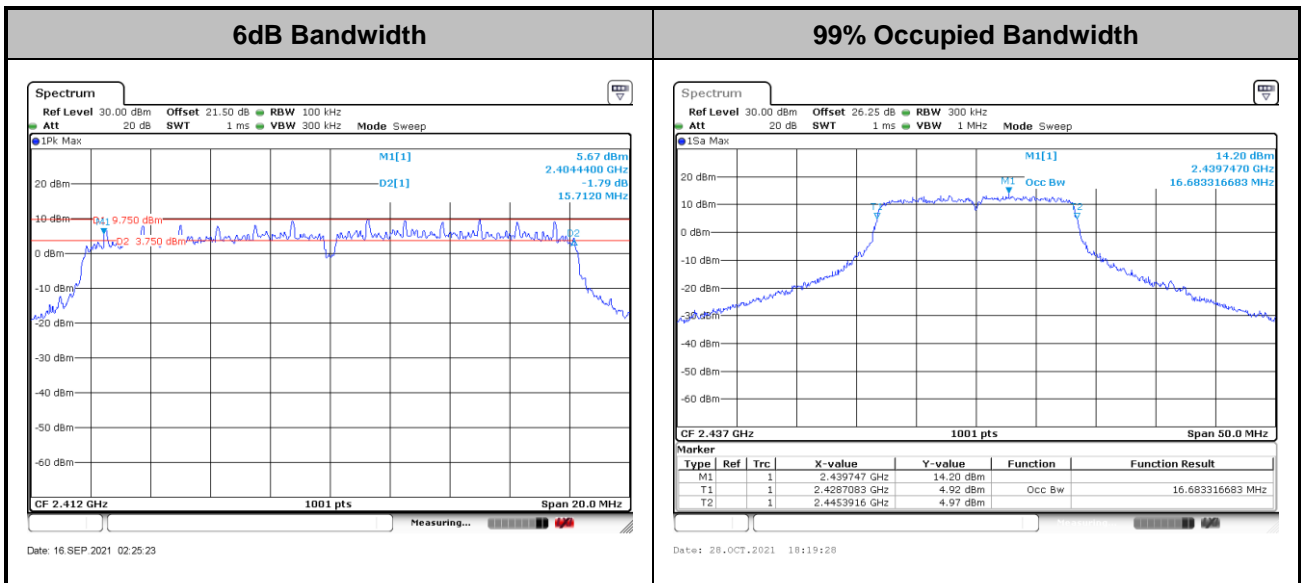

**Note:** The occupied channel bandwidth is maintained within the band of operation.



<802.11ax HE20>

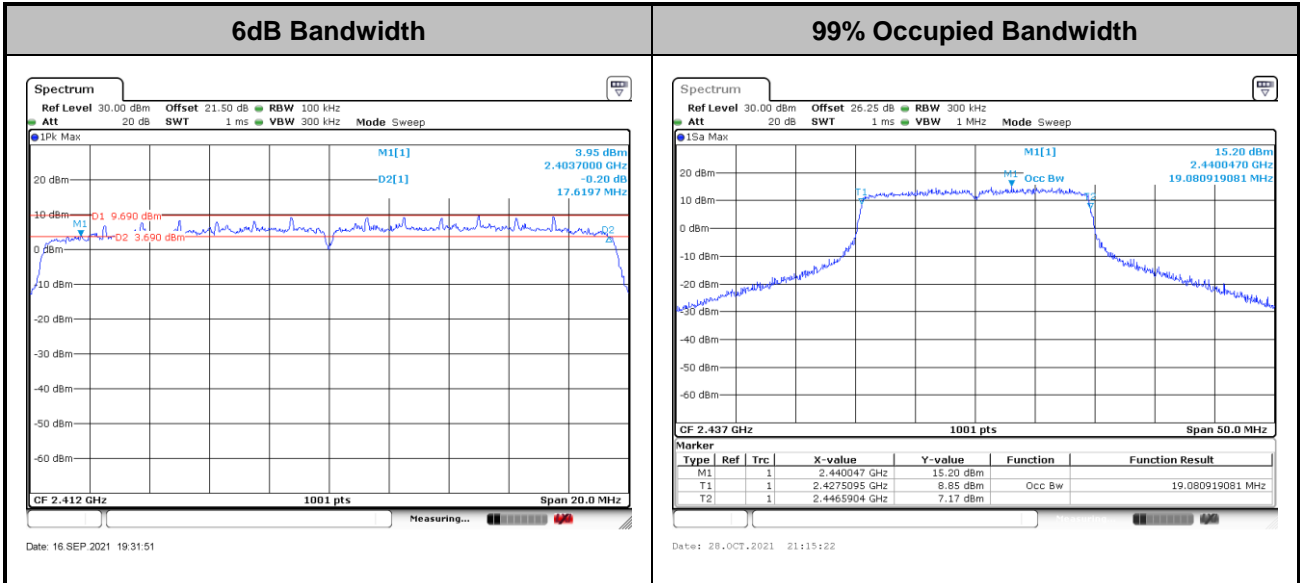

**Note:** The occupied channel bandwidth is maintained within the band of operation.

<802.11ax HE40>

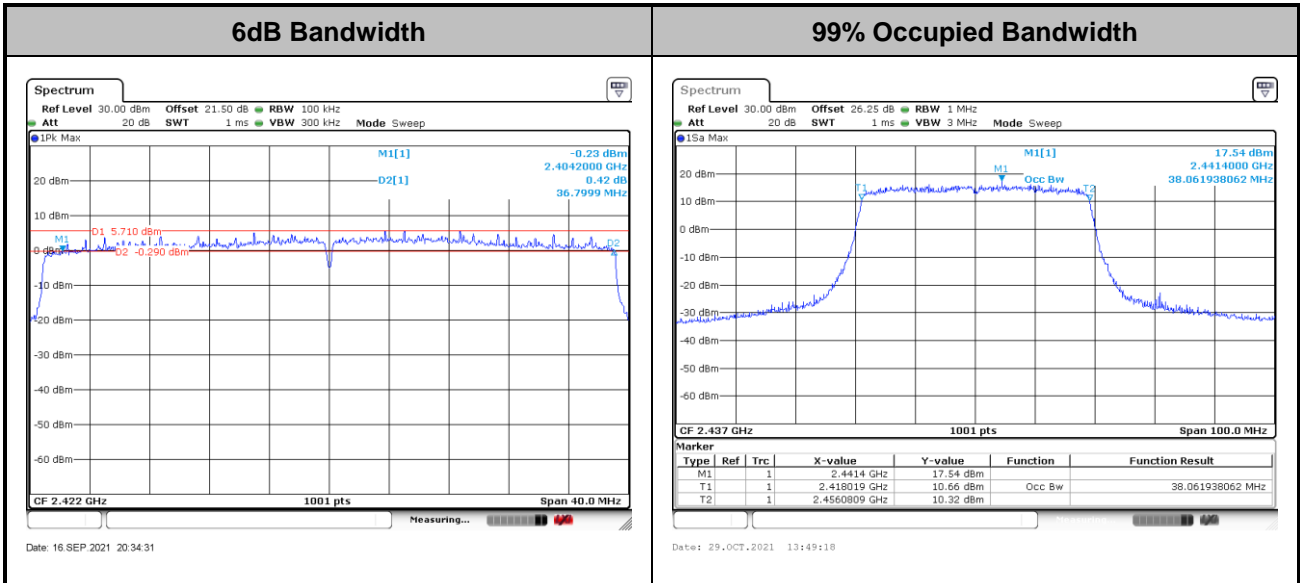

**Note:** The occupied channel bandwidth is maintained within the band of operation.

## 3.2 Output Power Measurement

### 3.2.1 Limit of Output Power

For systems using digital modulation in the 2400-2483.5 MHz, the limit for output power is 30 dBm. If transmitting antenna with directional gain greater than 6 dBi is used, the output power from the intentional radiator shall be reduced below the above stated value by the amount in dB that the directional gain of the antenna exceeds 6 dBi. In case of point-to-point operation, the limit has to be reduced by 1 dB for every 3 dB that the directional gain of the antenna exceeds 6 dBi.

### 3.2.2 Measuring Instruments

Please refer to the measuring equipment list in this test report.

### 3.2.3 Test Procedures

1. For Average Power, the testing follows ANSI C63.10 Section
2. The RF output of EUT is connected to the power meter by RF cable and attenuator. The path loss is compensated to the results for each measurement.
3. Set the maximum power setting and enable the EUT to transmit continuously.
4. Measure the conducted output power and record the results in the test report.
5. For MIMO mode, calculation method follows FCC KDB 662911 D01 Multiple Transmitter Output v02r01.

### 3.2.4 Test Setup

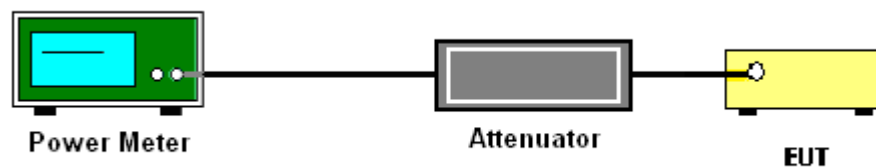

### 3.2.5 Test Result of Average Output Power

Please refer to Appendix A.

### 3.3 Power Spectral Density Measurement

#### 3.3.1 Limit of Power Spectral Density

The peak power spectral density shall not be greater than 8 dBm in any 3 kHz band at any time interval of continuous transmission.

#### 3.3.2 Measuring Instruments

Please refer to the measuring equipment list in this test report.

#### 3.3.3 Test Procedures

##### <CDD Modes>

##### Method AVGPSD-2

1. The testing follows the ANSI C63.10 Section 11.10.5 Method AVGPSD-2.
2. The RF output of EUT is connected to the spectrum analyzer by RF cable and attenuator. The path loss is compensated to the results for each measurement.
3. Set the maximum power setting and enable the EUT to transmit continuously.
4. Make the measurement with the spectrum analyzer's resolution bandwidth (RBW) = 10 kHz. Video bandwidth VBW = 30 kHz In order to make an accurate measurement, set the span to 1.5 times DTS Channel Bandwidth. (6dB BW).
5. Number of points in sweep  $\geq 2$  Span / RBW. (This ensures that bin-to-bin spacing is  $\leq$  RBW/2, so that narrowband signals are not lost between frequency bins).
6. Detector = RMS, Sweep time = auto couple.
7. Trace average at least 100 traces in power averaging mode.
8. Add  $10 \log(1/x)$ , where  $x$  is the duty cycle, to the measured power in order to compute the average power during the actual transmission times. For example, add  $10 \log(1/0.25) = 6$  dB if the duty cycle is 25 percent.
9. Measure and record the results in the test report.
10. For MIMO mode, calculation method follows FCC KDB 662911 D01 Multiple Transmitter Output v02r01.

Method (c): Measure and add  $10 \log(N_{\text{ANT}})$  dB.

With this technique, spectrum measurements are performed at each output of the device, but rather than summing the spectra or the spectral peaks across the outputs, the quantity  $10 \log(N_{\text{ANT}})$  dB is added to each spectrum value before comparing to the emission limit. The addition of  $10 \log(N_{\text{ANT}})$  dB serves to apportion the emission limit among the  $N_{\text{ANT}}$  outputs so that each output is permitted to contribute no more than  $1/N_{\text{ANT}}^{\text{th}}$  of the PSD limit .



### 3.3.4 Test Setup

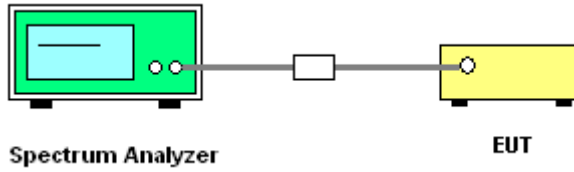

### 3.3.5 Test Result of Power Spectral Density

Please refer to Appendix A.

<CDD Modes>

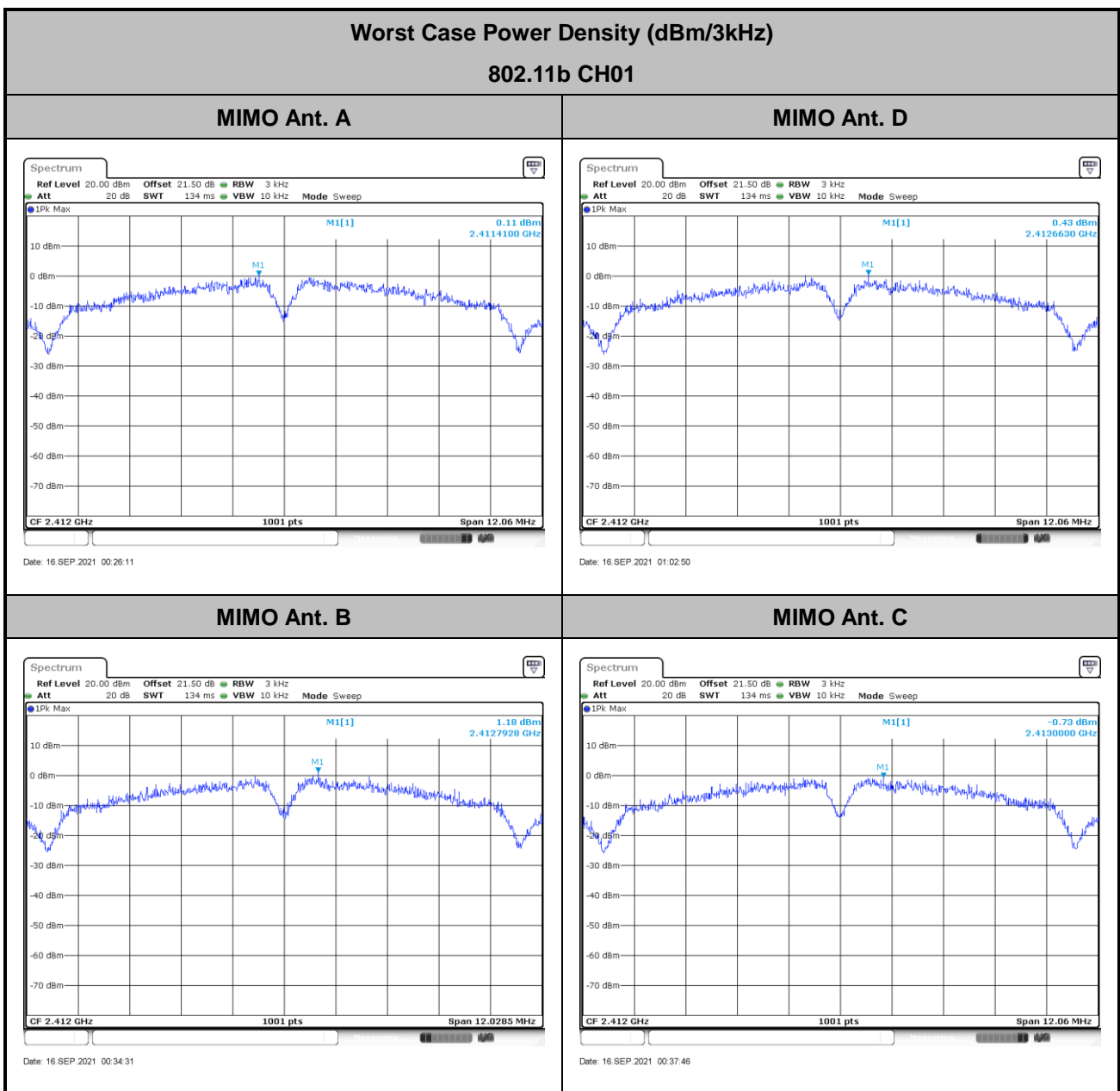



Worst Case Power Density (dBm/3kHz)  
802.11g CH06

MIMO Ant. A

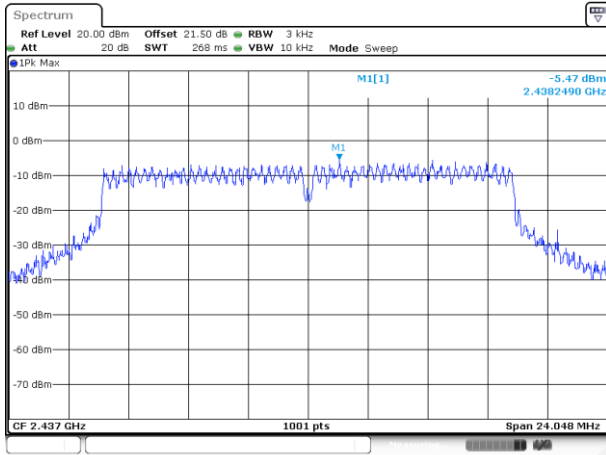

Date: 16 SEP 2021 02:47:36

MIMO Ant. D

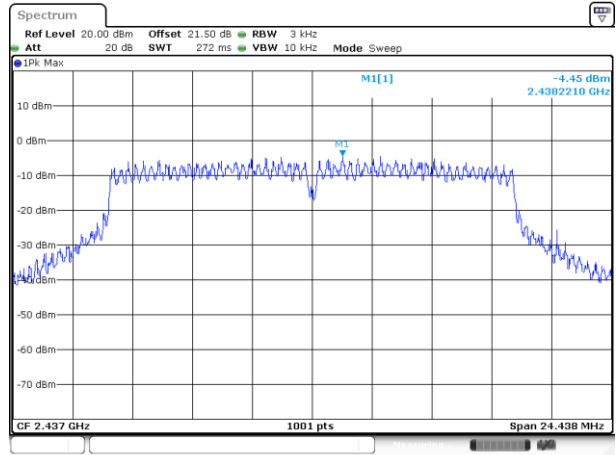

Date: 16 SEP 2021 02:52:21

MIMO Ant. B

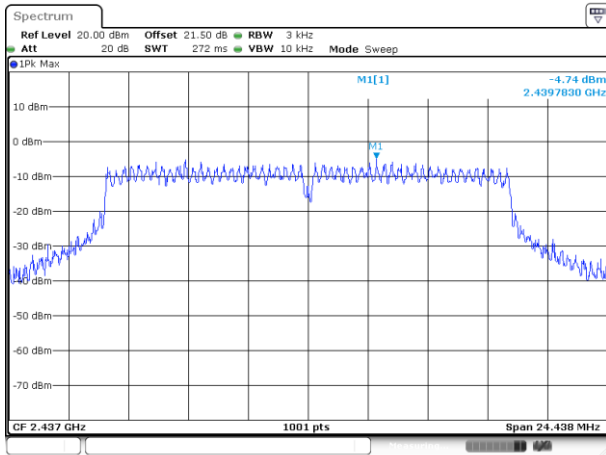

Date: 16 SEP 2021 03:09:19

MIMO Ant. C

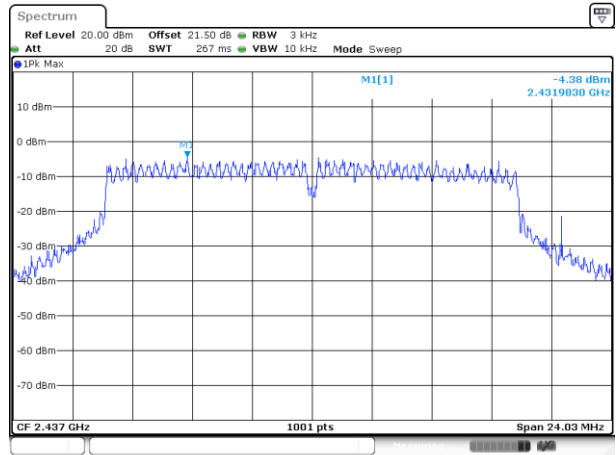

Date: 16 SEP 2021 03:19:30



Worst Case Power Density (dBm/3kHz)  
802.11ax HE20 CH06

MIMO Ant. A

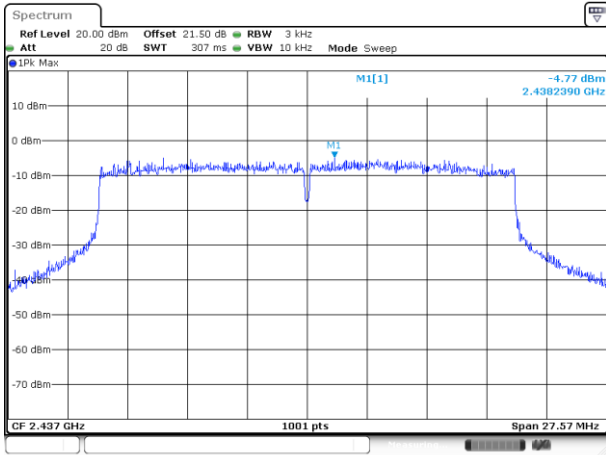

MIMO Ant. D

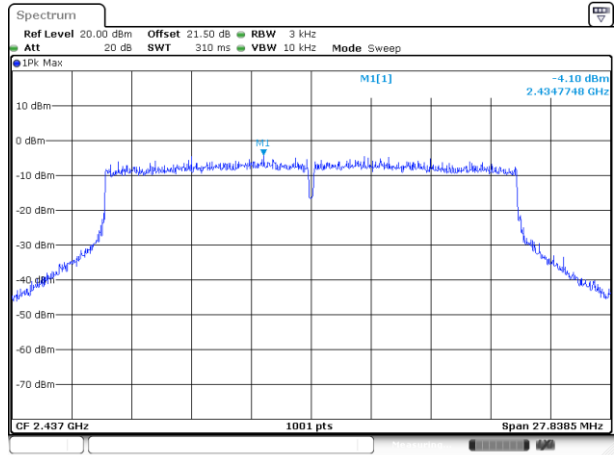

MIMO Ant. B

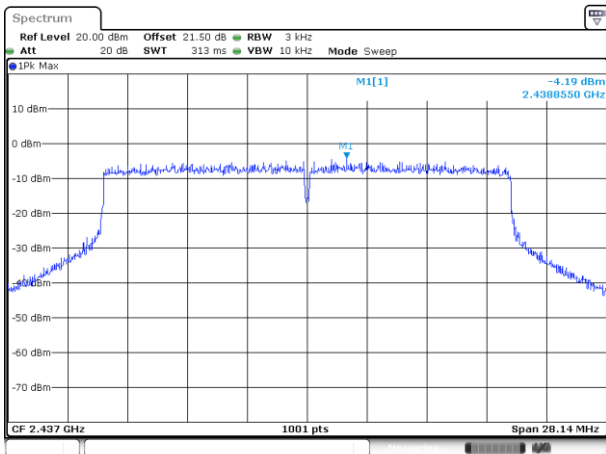

MIMO Ant. C

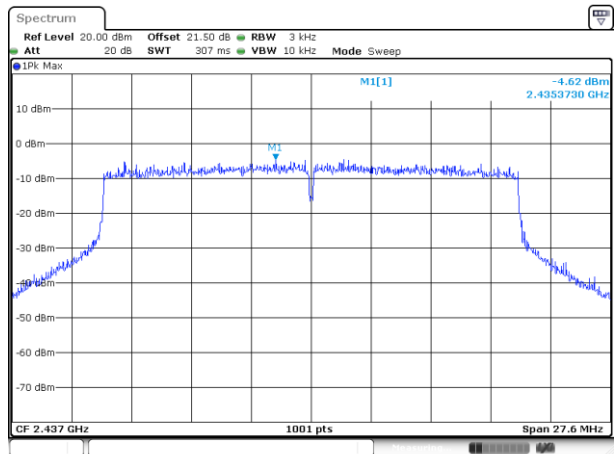



Worst Case Power Density (dBm/3kHz)  
802.11ax HE40 CH03

MIMO Ant. A

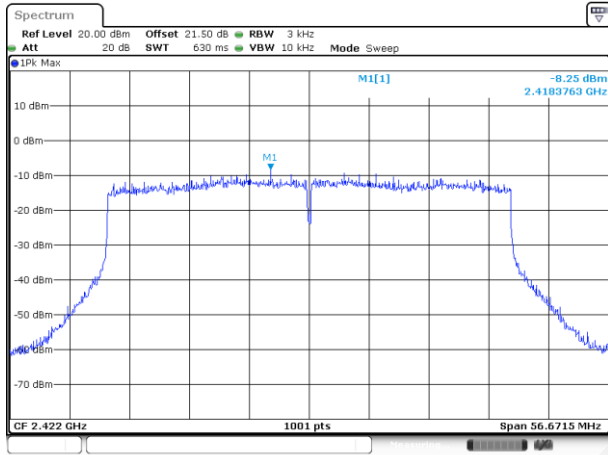

Date: 16 SEP 2021 20:25:35

MIMO Ant. D

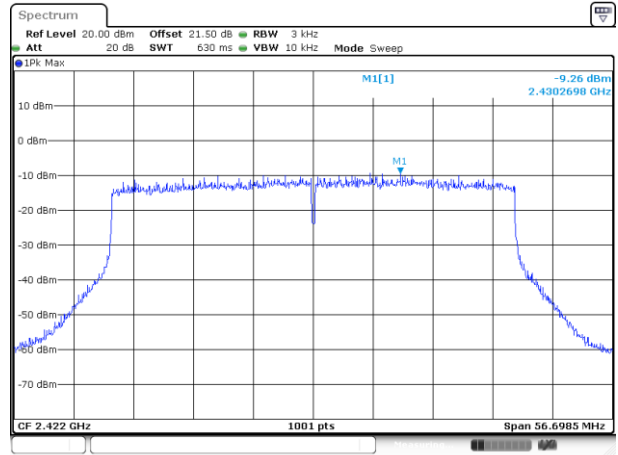

Date: 16 SEP 2021 20:28:33

MIMO Ant. B

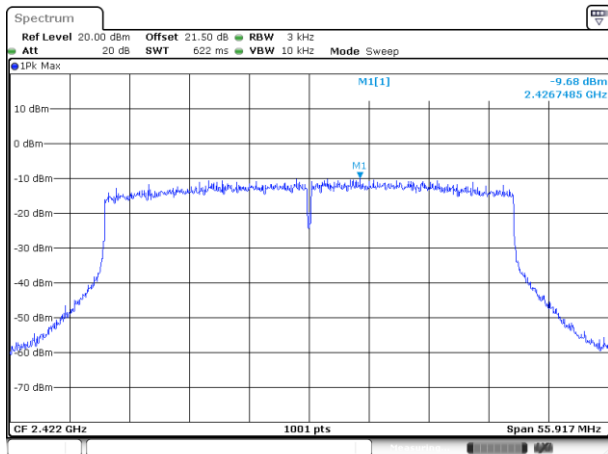

Date: 16 SEP 2021 20:31:18

MIMO Ant. C

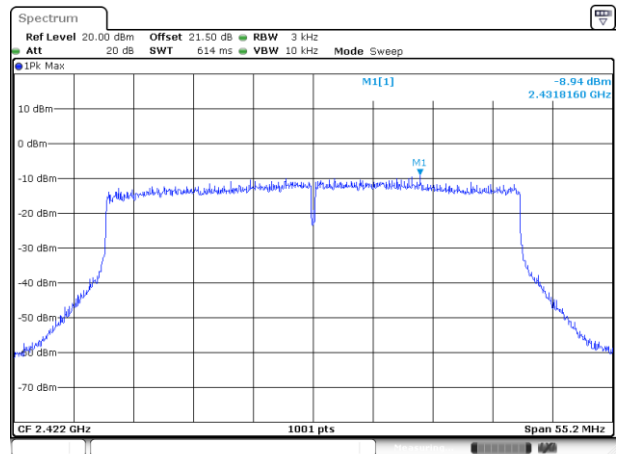

Date: 16 SEP 2021 20:35:15

## 3.4 Conducted Band Edges and Spurious Emission Measurement

### 3.4.1 Limit of Conducted Band Edges and Spurious Emission Measurement

In any 100 kHz bandwidth outside of the authorized frequency band, the emissions which fall in the non-restricted bands shall be attenuated at least 20 dB / 30dB relative to the maximum PSD level in 100 kHz by RF conducted measurement.

### 3.4.2 Measuring Instruments

Please refer to the measuring equipment list in this test report.

### 3.4.3 Test Procedures

1. The testing follows the ANSI C63.10 Section 11.11.3 Emission level measurement
2. The RF output of EUT is connected to the spectrum analyzer by RF cable and attenuator. The path loss is compensated to the results for each measurement.
3. Set the maximum power setting and enable the EUT to transmit continuously.
4. Set RBW = 100 kHz, VBW = 300 kHz, Peak Detector. Unwanted Emissions measured in any 100 kHz bandwidth outside of the authorized frequency band shall be attenuated by at least 20 dB relative to the maximum in-band peak PSD level in 100 kHz when maximum peak conducted output power procedure is used. If the transmitter complies with the conducted power limits based on the use of RMS averaging over a time interval, the attenuation required under this paragraph shall be 30 dB instead of 20 dB per 15.247(d).
5. Measure and record the results in the test report.
6. The RF fundamental frequency should be excluded against the limit line in the operating frequency band.

### 3.4.4 Test Setup

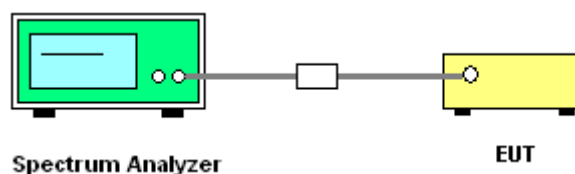



### 3.4.5 Test Result of Conducted Band Edges and Spurious Emission

<CDD Mode>

Number of TX = 4, Ant. A (Measured)

Test Mode :	802.11b	Test Channel :	01
-------------	---------	----------------	----

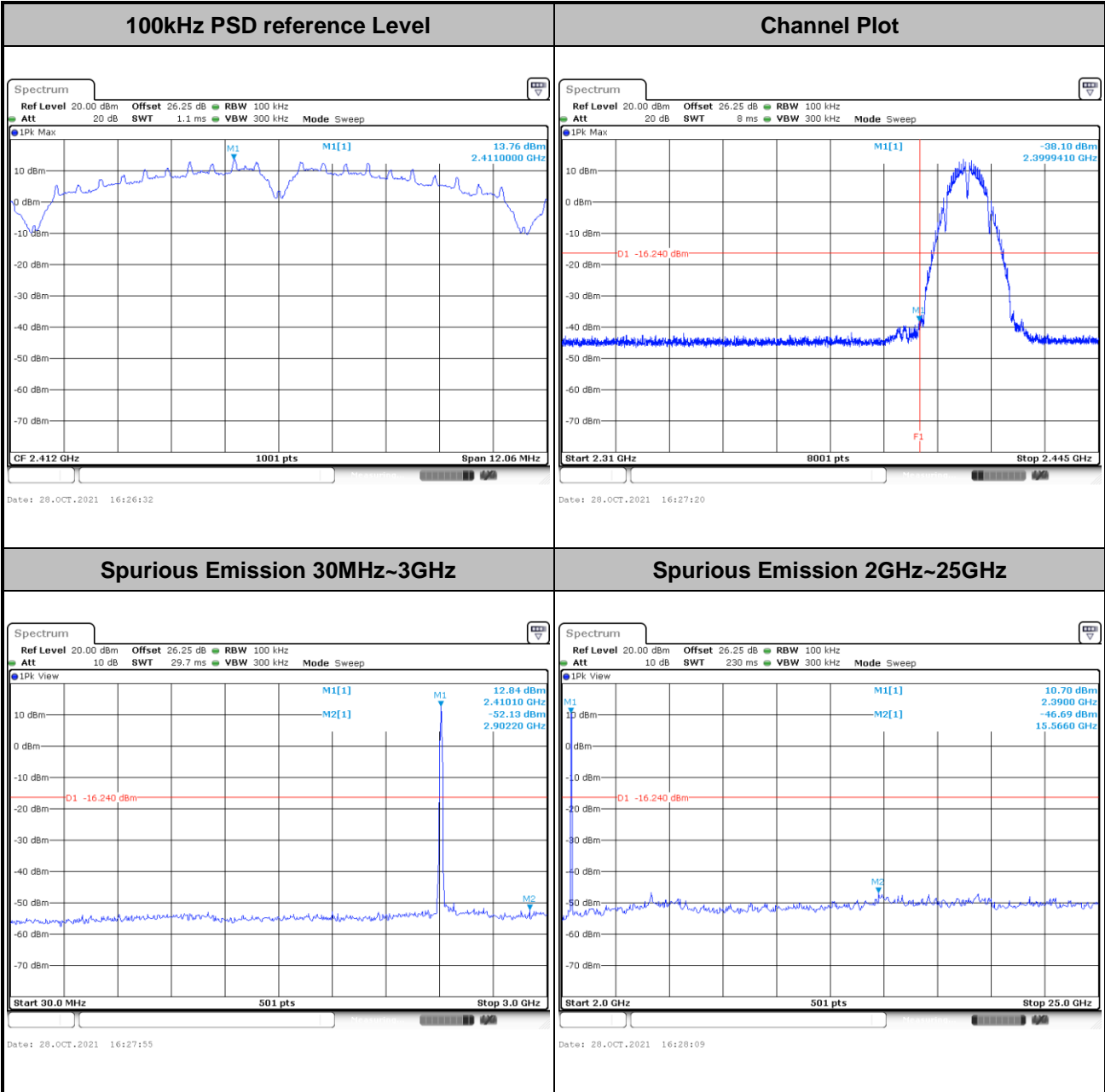



Test Mode :	802.11b	Test Channel :	06
-------------	---------	----------------	----

<b>100kHz PSD reference Level</b>	<b>Channel Plot</b>
-----------------------------------	---------------------

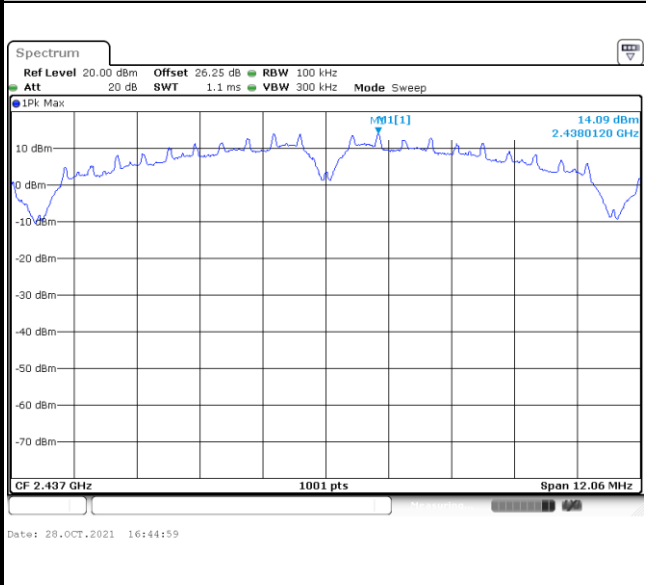

<b>Spurious Emission 30MHz~3GHz</b>	<b>Spurious Emission 2GHz~25GHz</b>
-------------------------------------	-------------------------------------

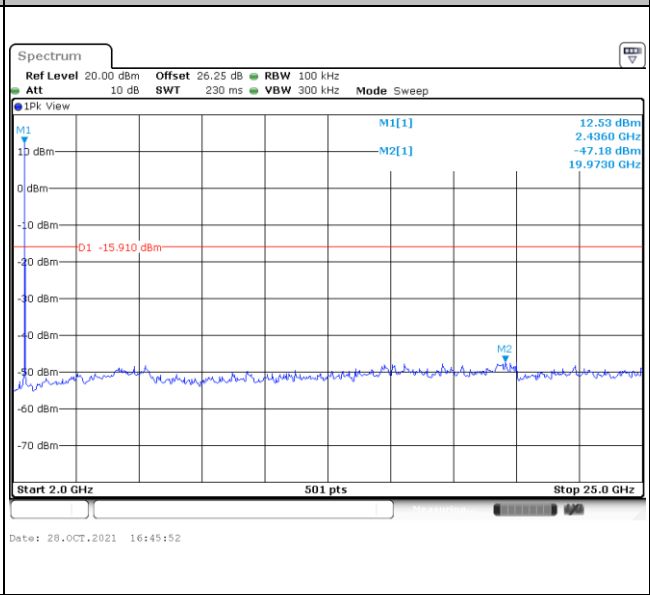
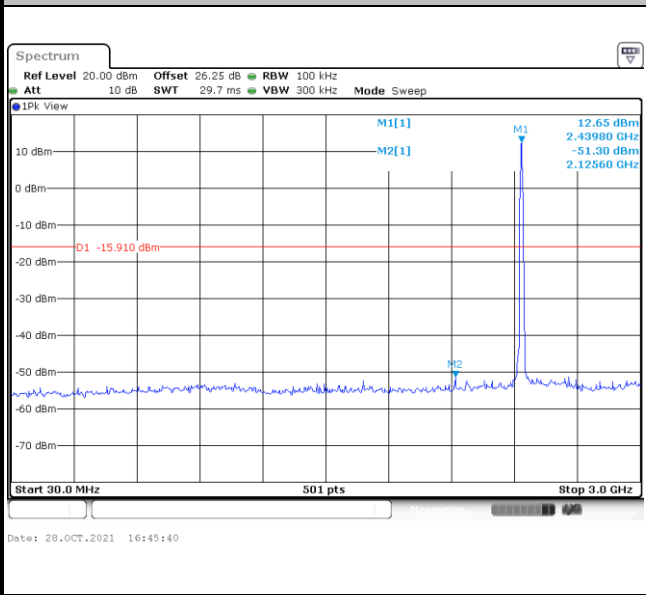



Test Mode :	802.11b	Test Channel :	11
-------------	---------	----------------	----

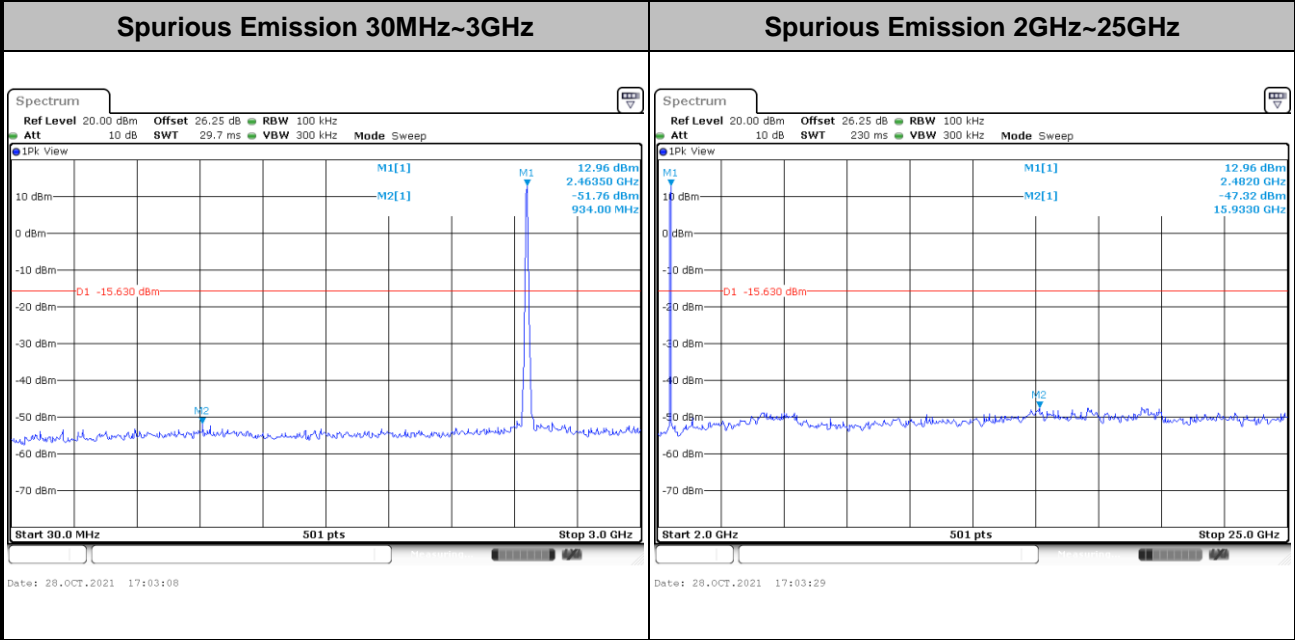
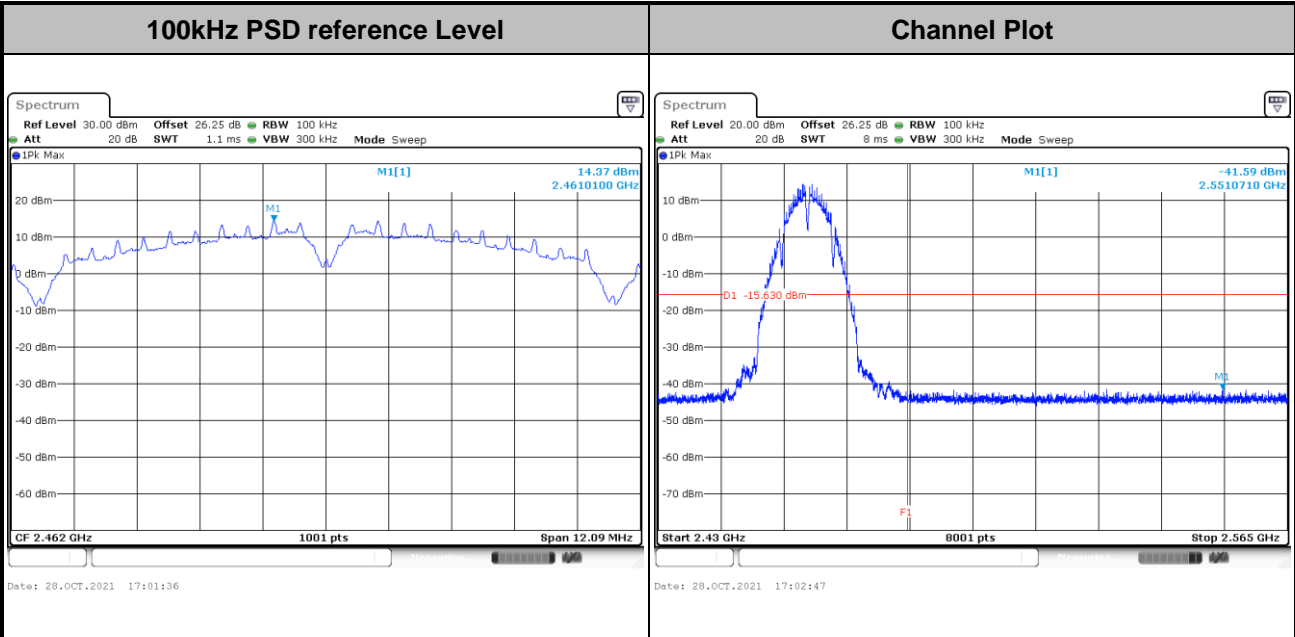





Test Mode :	802.11g	Test Channel :	01
-------------	---------	----------------	----

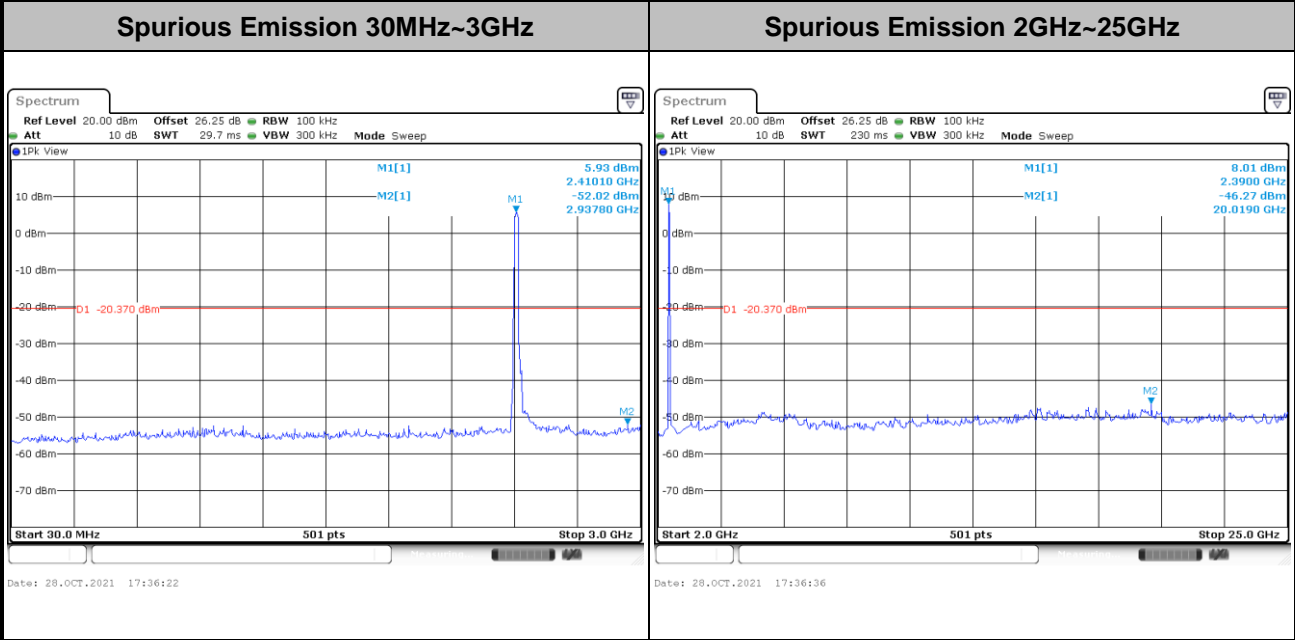
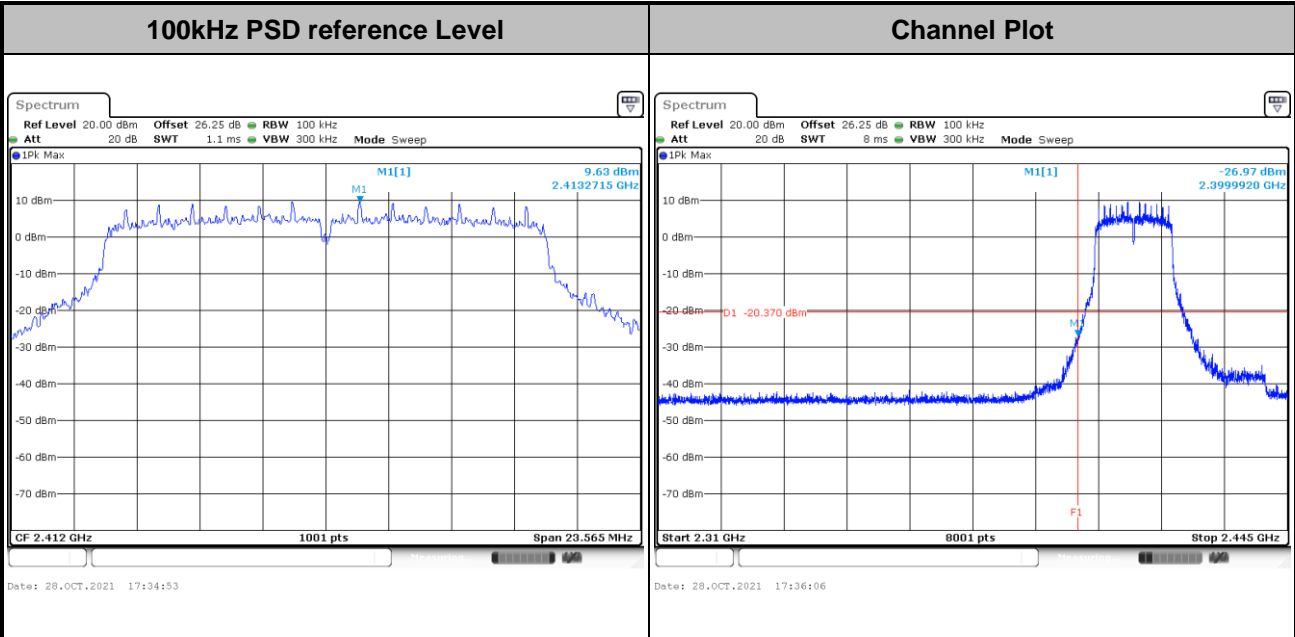



Test Mode :	802.11g	Test Channel :	06
-------------	---------	----------------	----

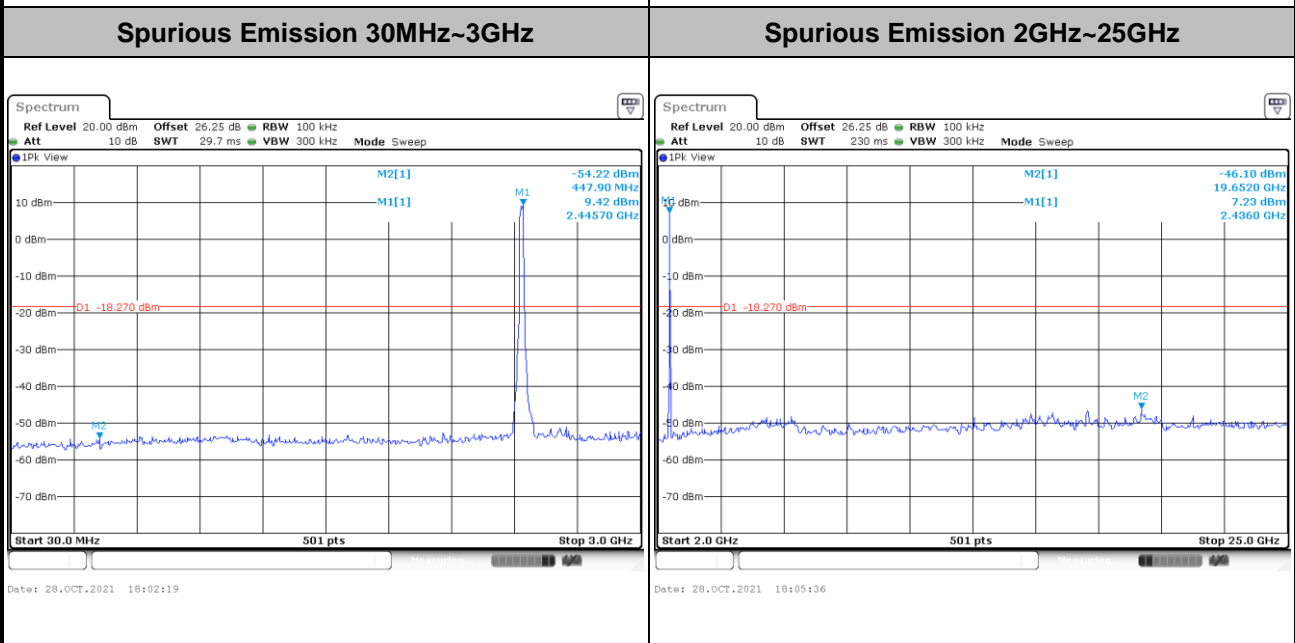
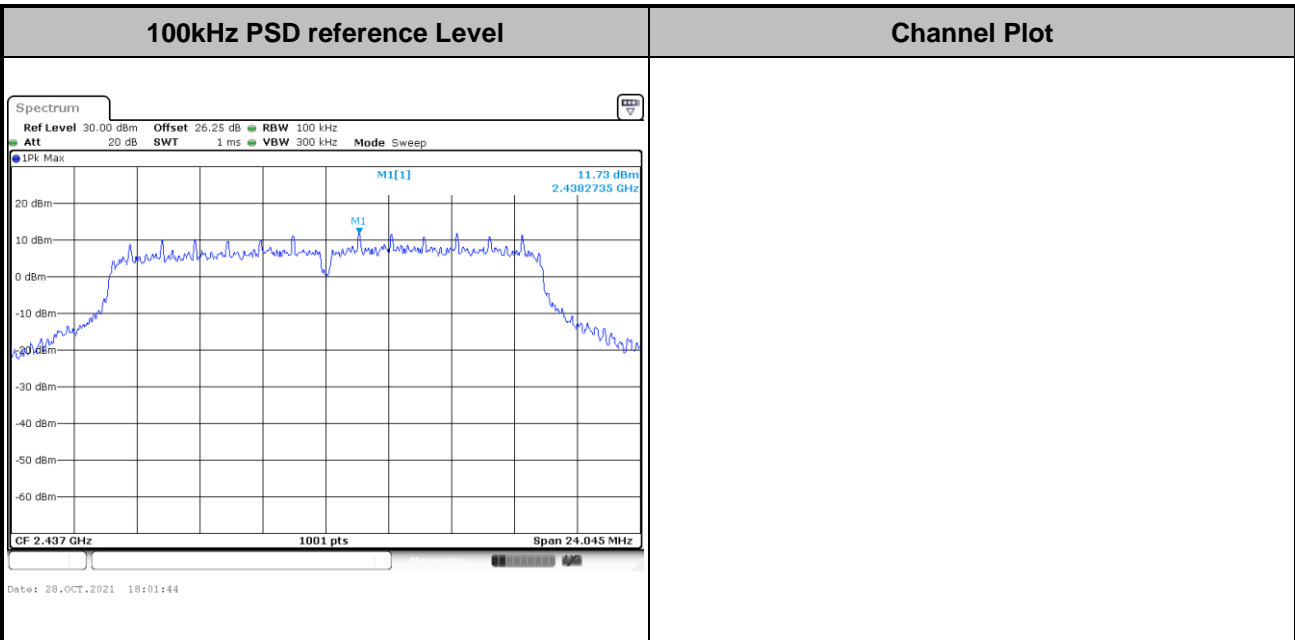



Test Mode : 802.11g      Test Channel : 11

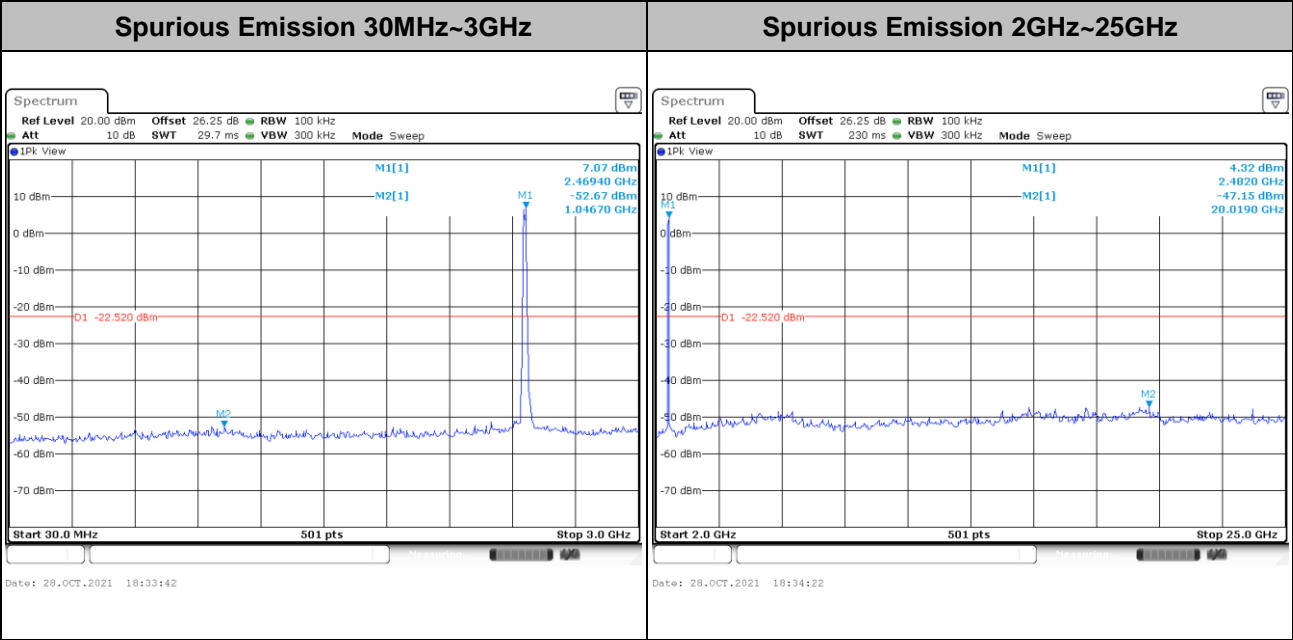
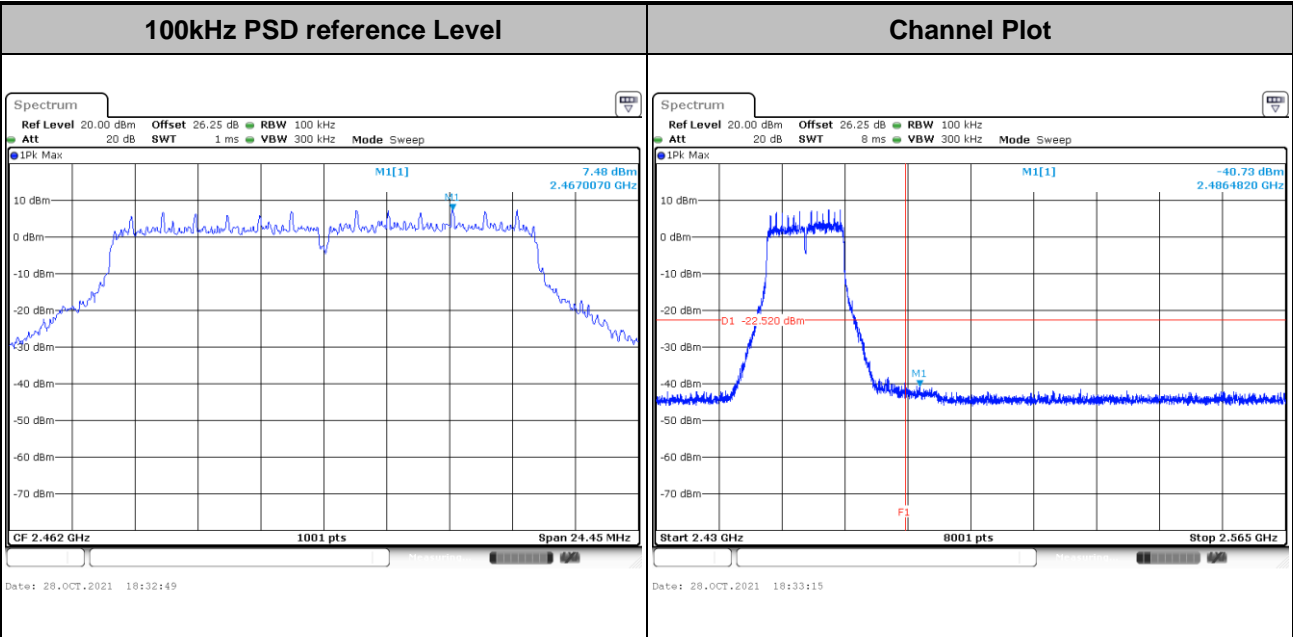



Test Mode : 802.11ax HE20 Test Channel : 01 Full RU

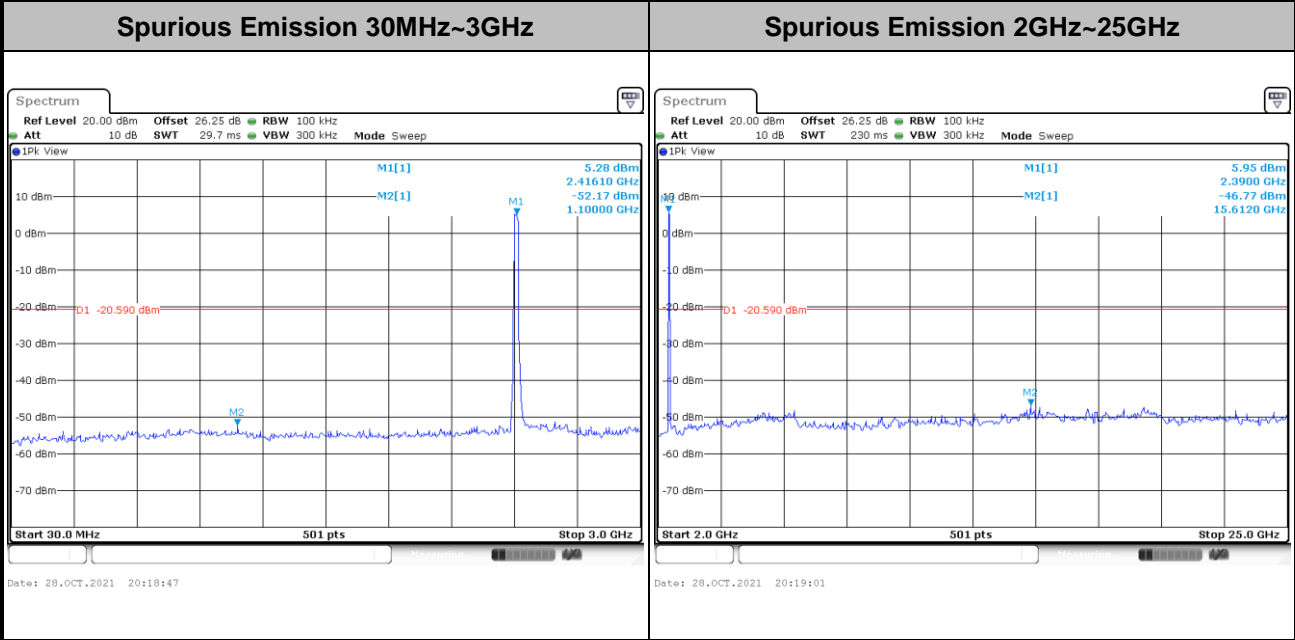
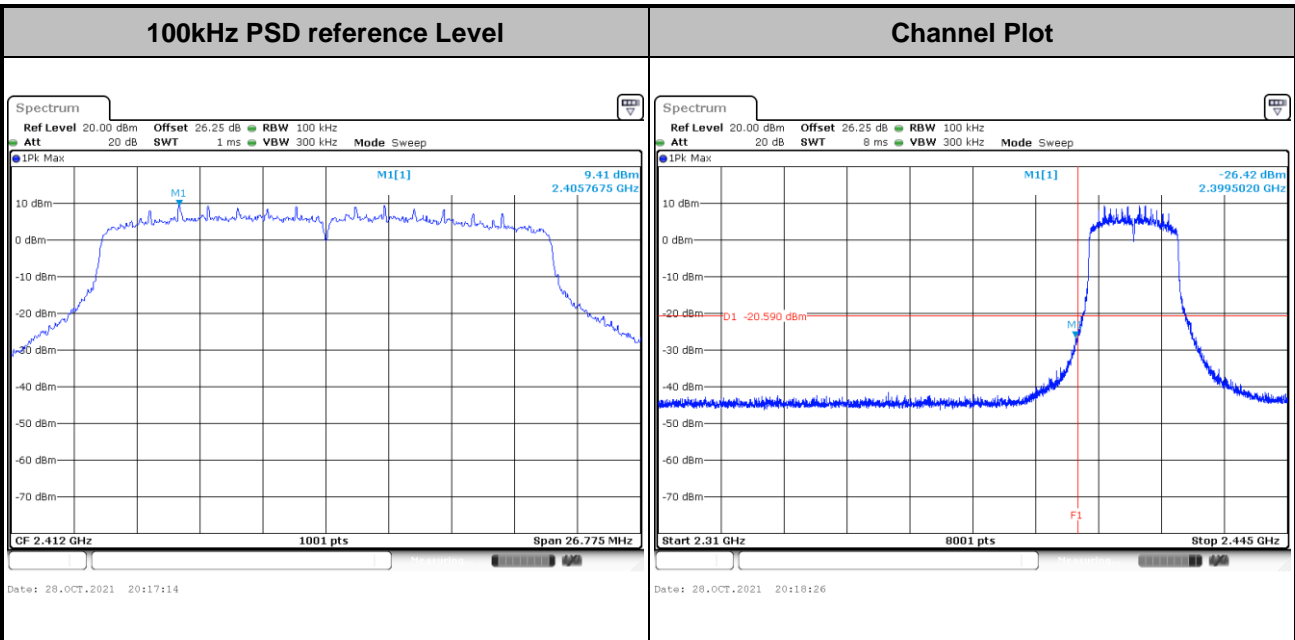



<b>Test Mode :</b>	802.11ax HE20	<b>Test Channel :</b>	06 Full RU
--------------------	---------------	-----------------------	------------

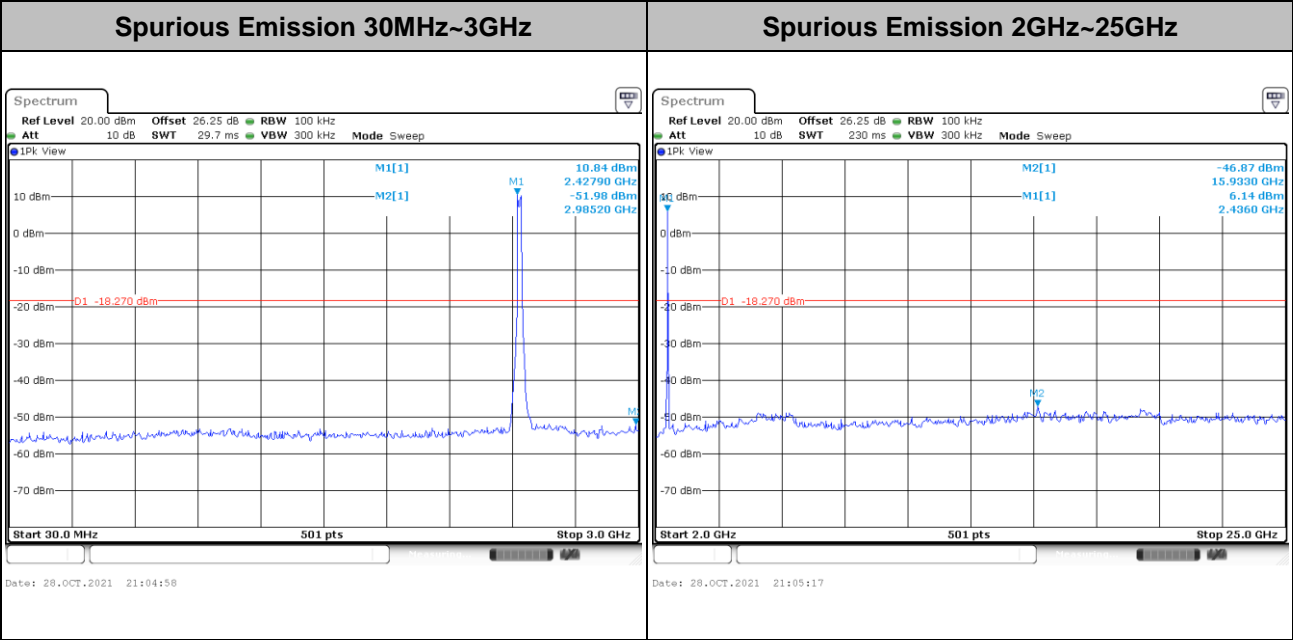
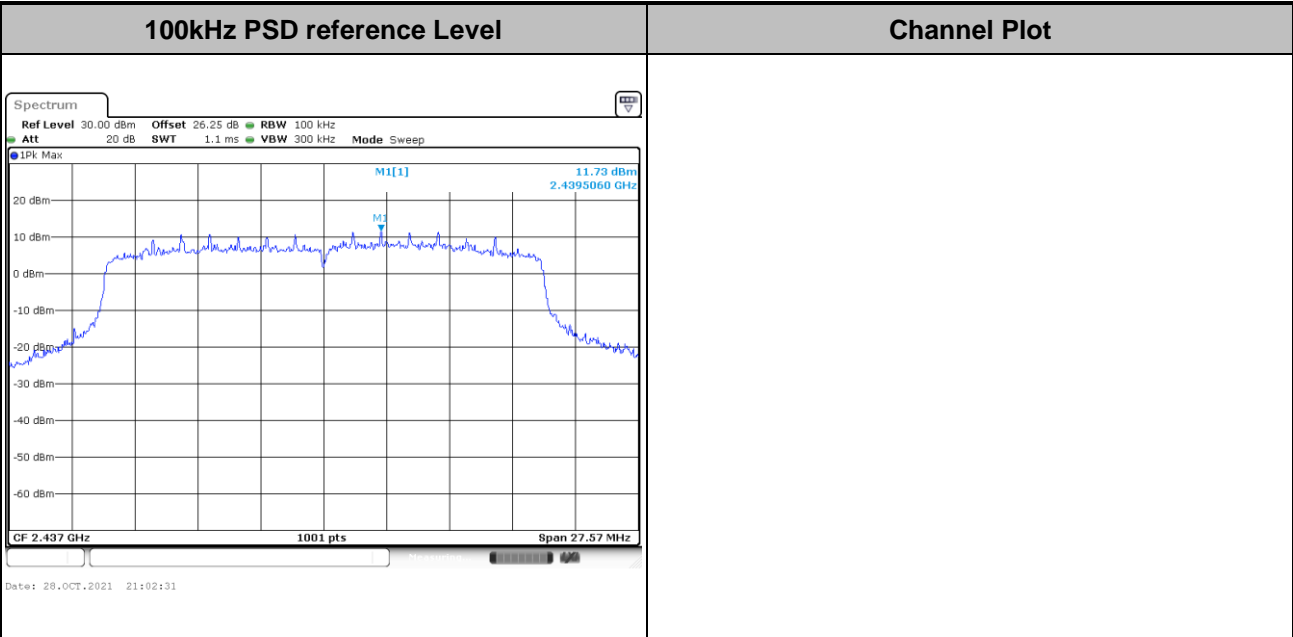



Test Mode :	802.11ax HE20	Test Channel :	11 Full RU
-------------	---------------	----------------	------------

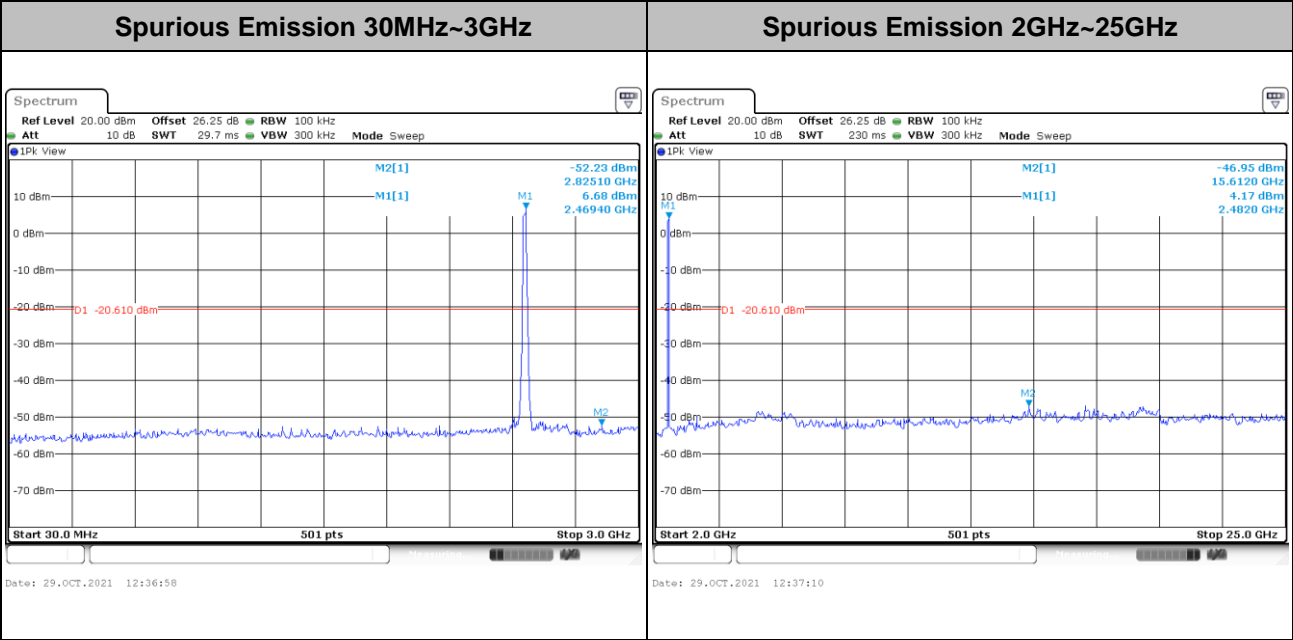
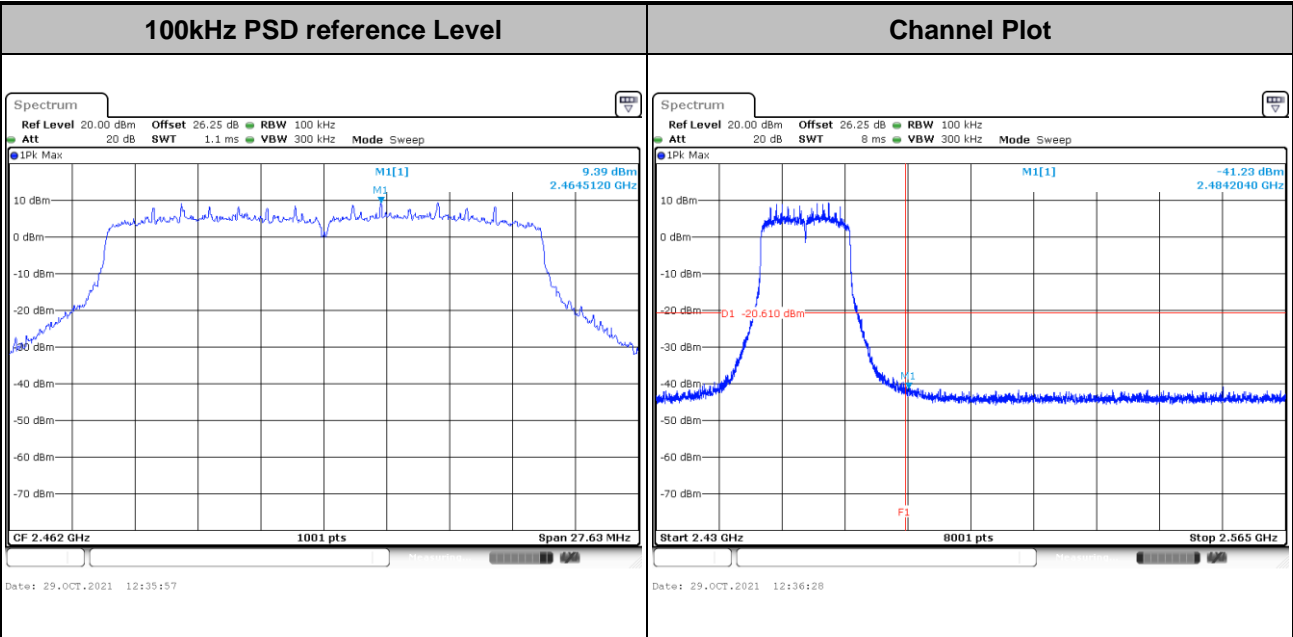



Test Mode : 802.11ax HE40      Test Channel : 03 Full RU

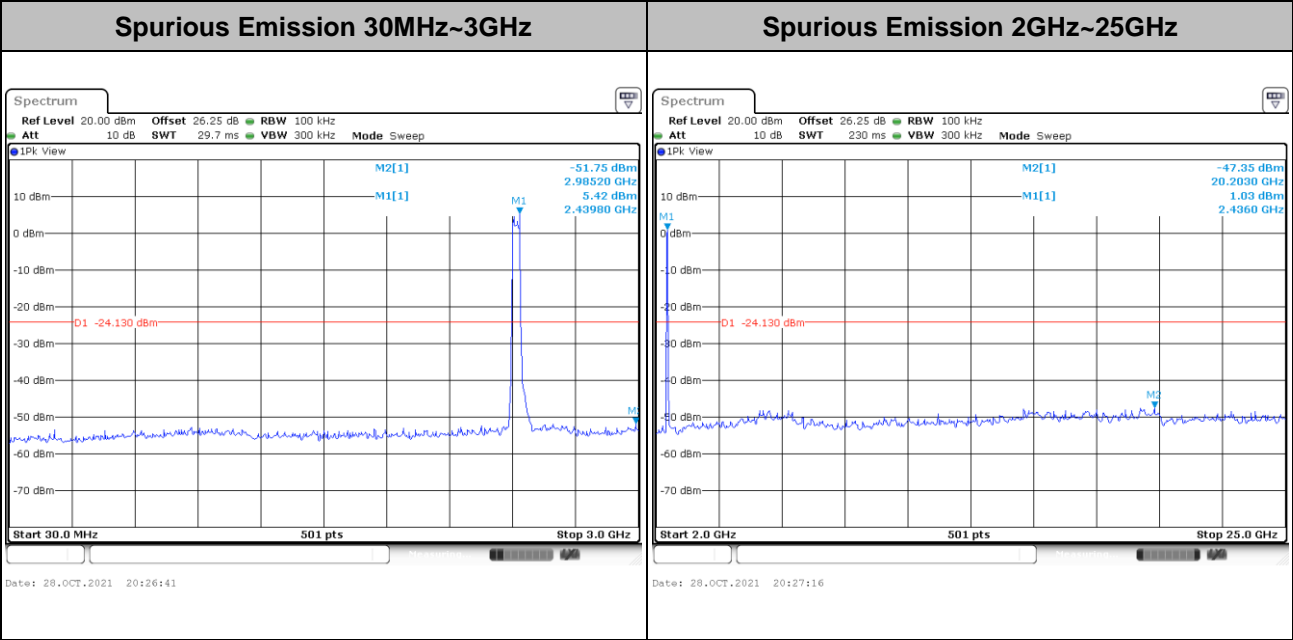
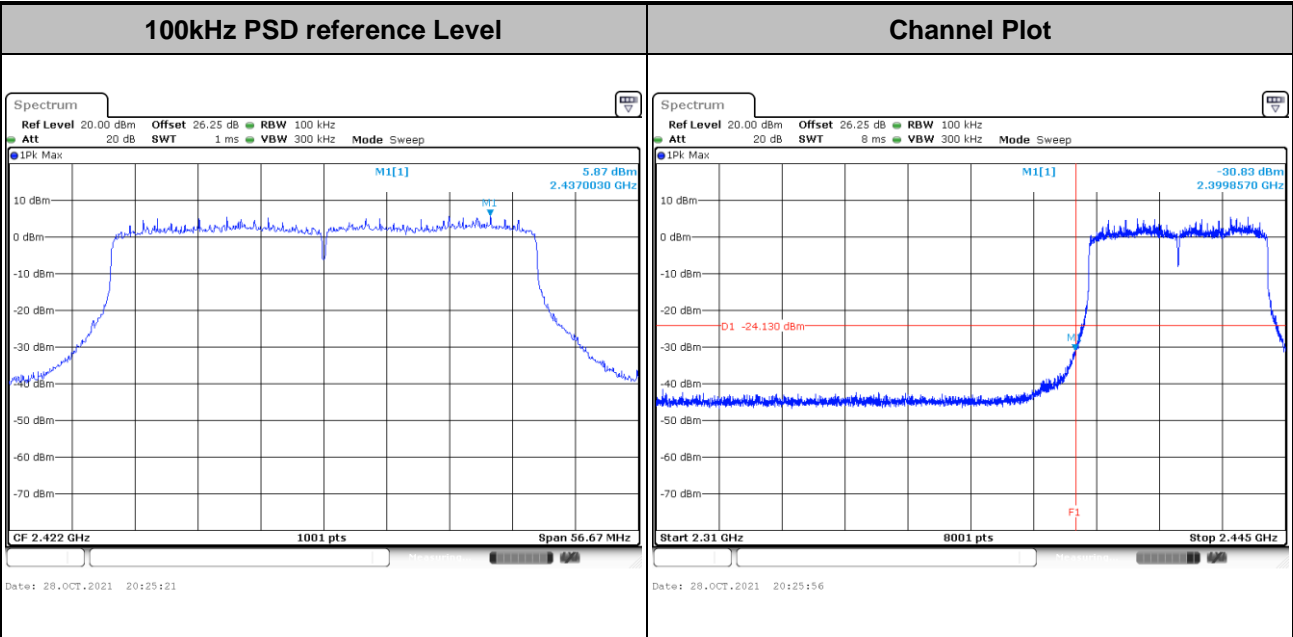



<b>Test Mode :</b>	802.11ax HE40	<b>Test Channel :</b>	06 Full RU
--------------------	---------------	-----------------------	------------

<b>100kHz PSD reference Level</b>	<b>Channel Plot</b>
-----------------------------------	---------------------

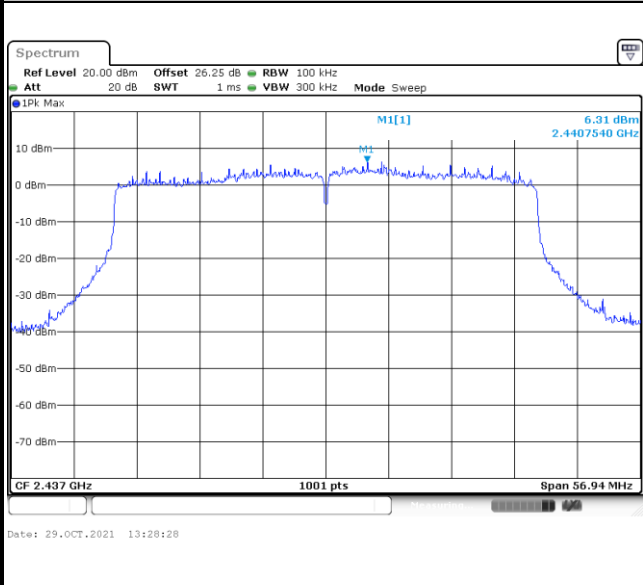

<b>Spurious Emission 30MHz~3GHz</b>	<b>Spurious Emission 2GHz~25GHz</b>
-------------------------------------	-------------------------------------

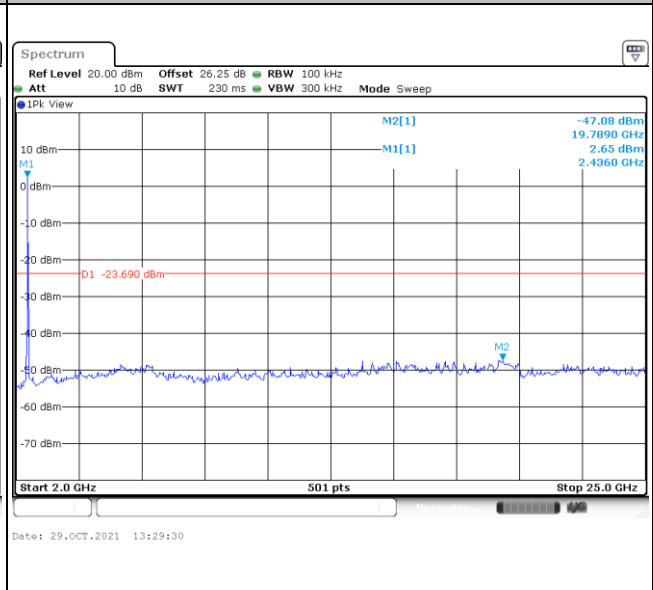
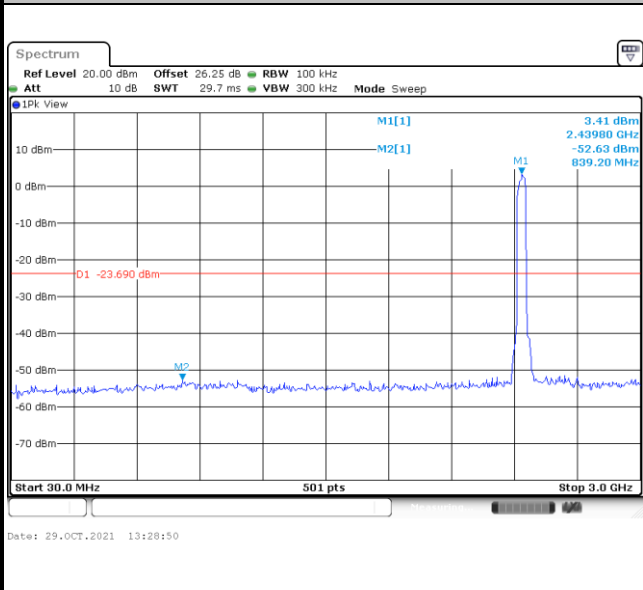





Test Mode :	802.11ax HE40	Test Channel :	09 Full RU
-------------	---------------	----------------	------------

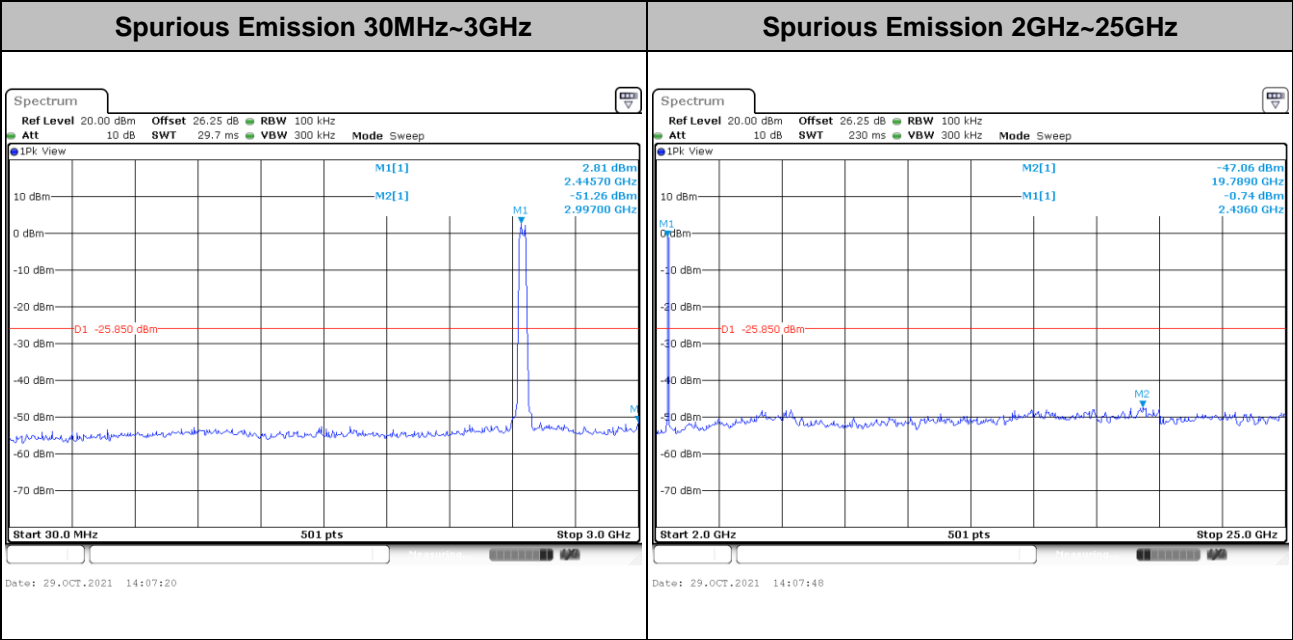
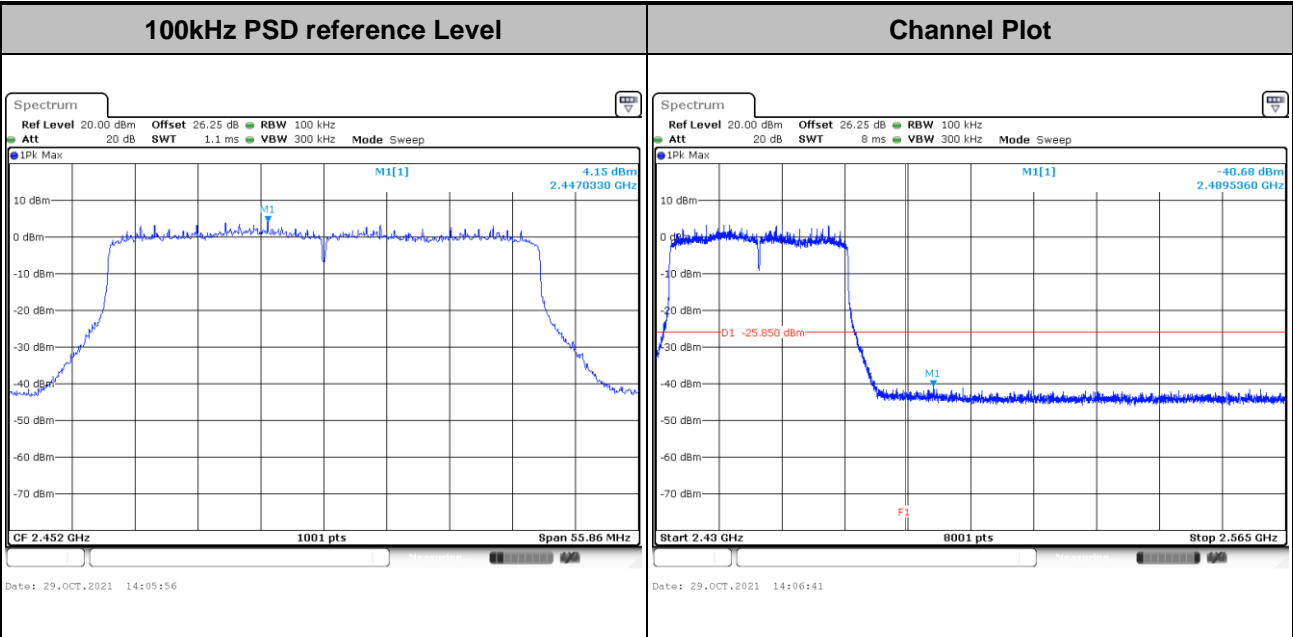



Number of TX = 4, Ant. D (Measured)

Test Mode :	802.11b	Test Channel :	01
-------------	---------	----------------	----

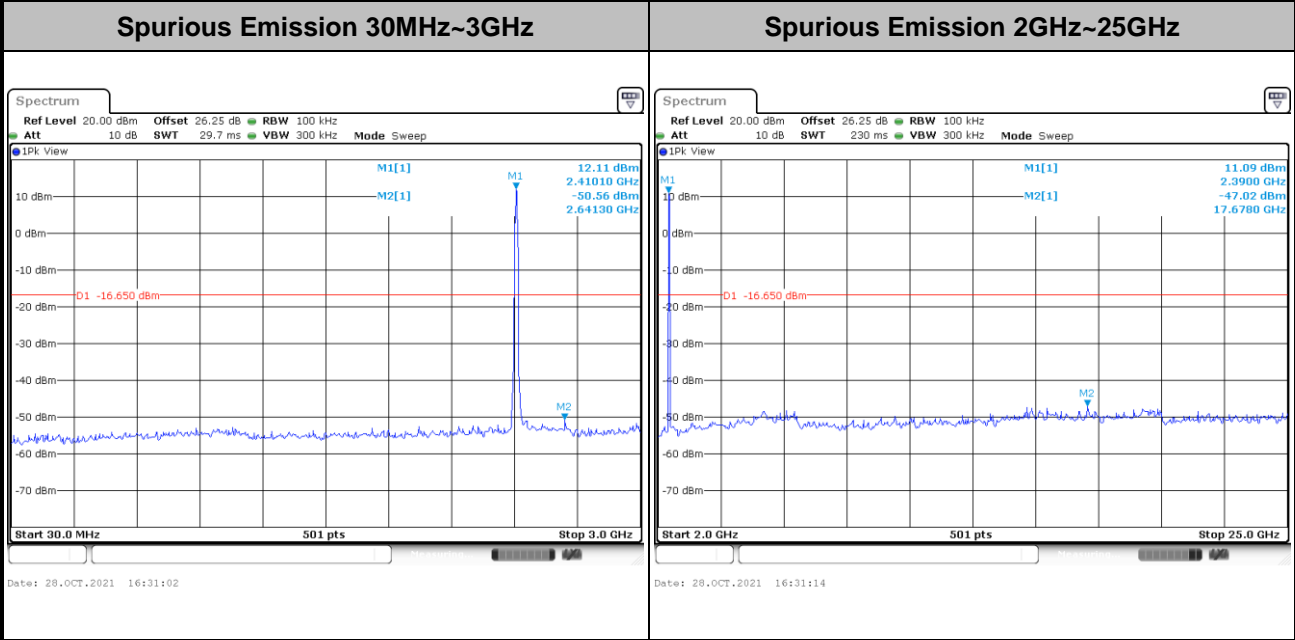
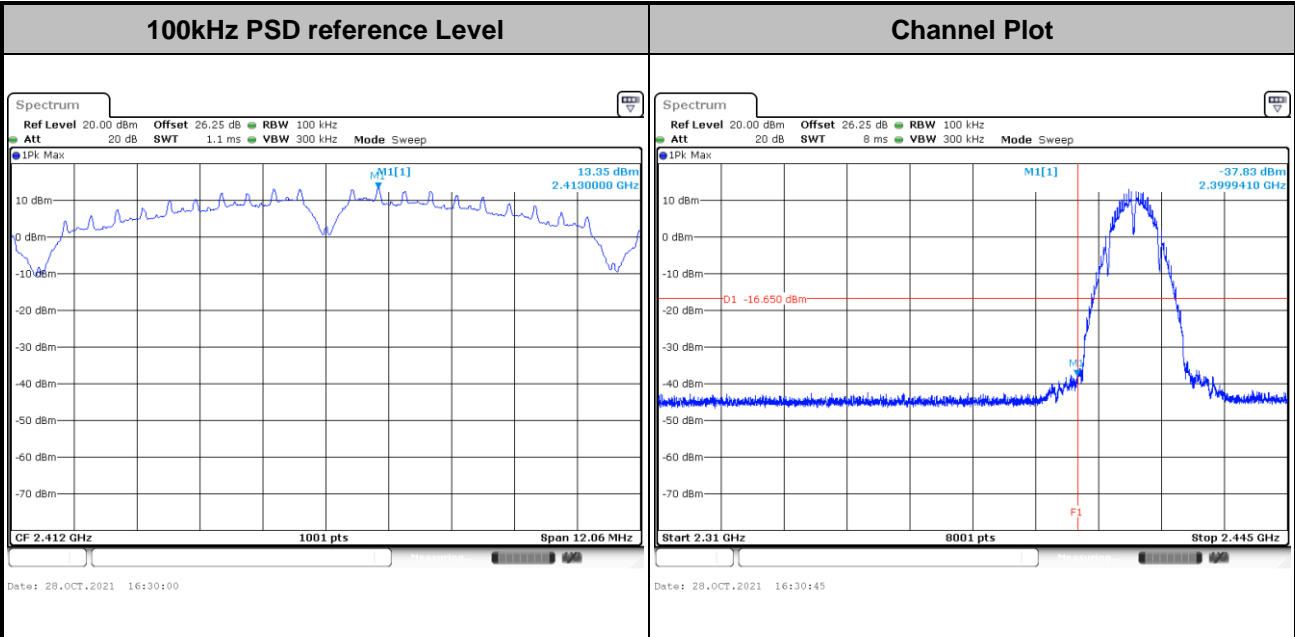



Test Mode :	802.11b	Test Channel :	06
-------------	---------	----------------	----

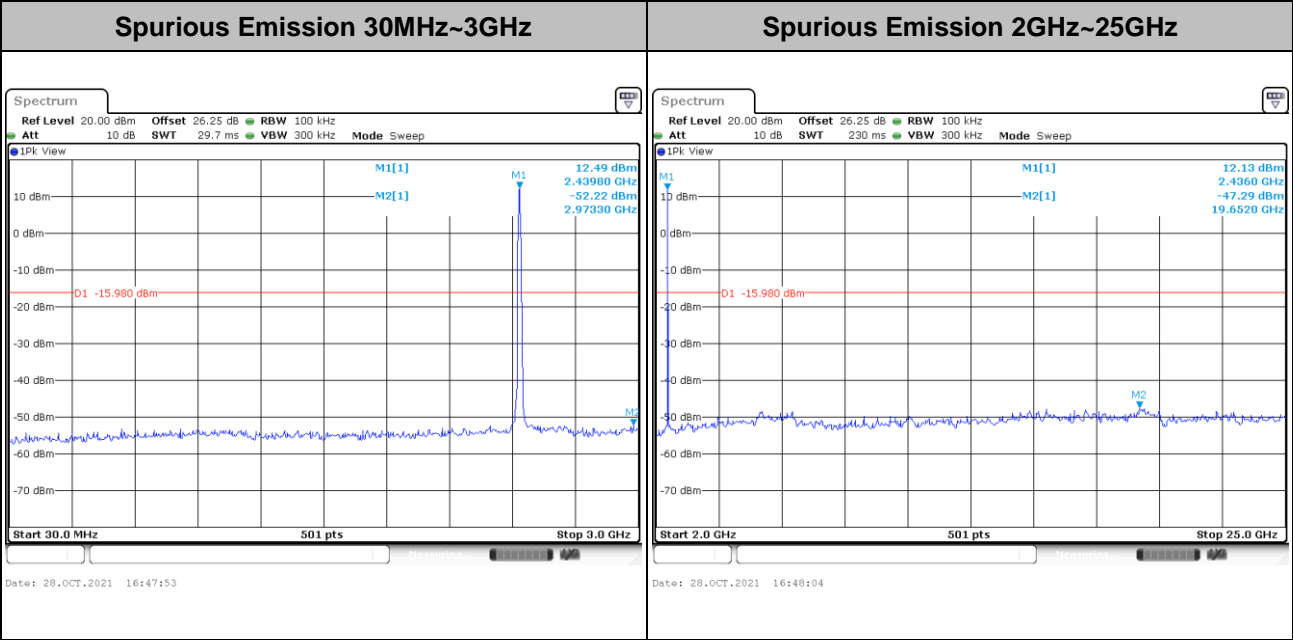
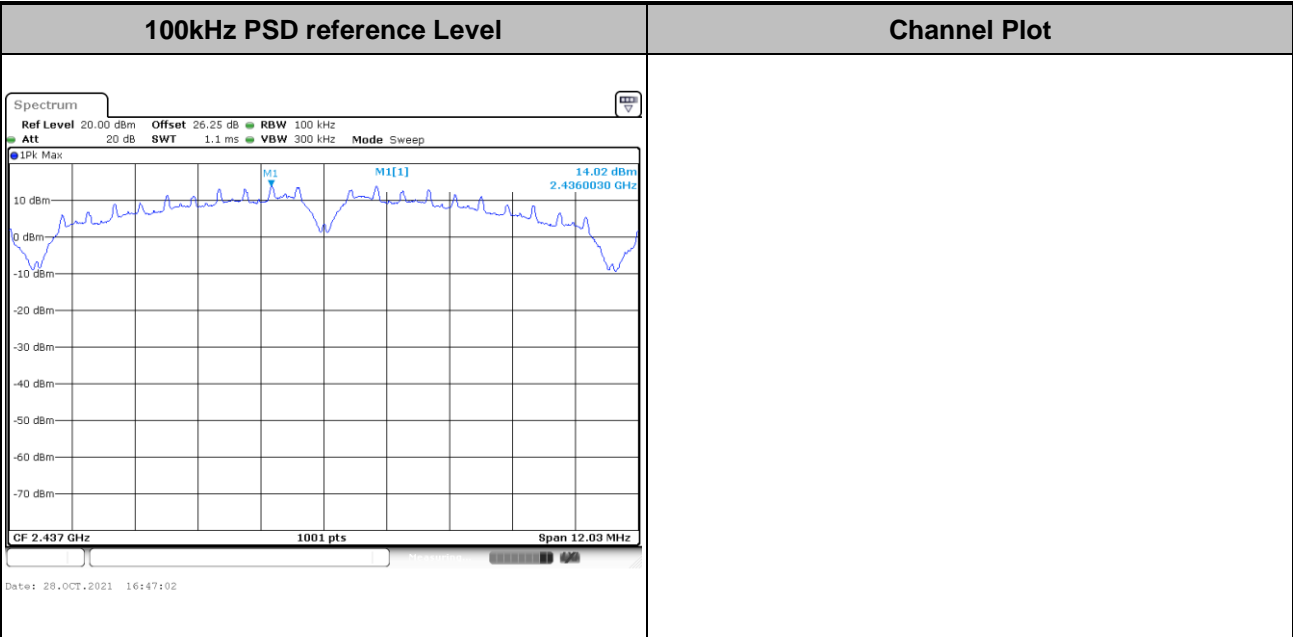



Test Mode :	802.11b	Test Channel :	11
-------------	---------	----------------	----

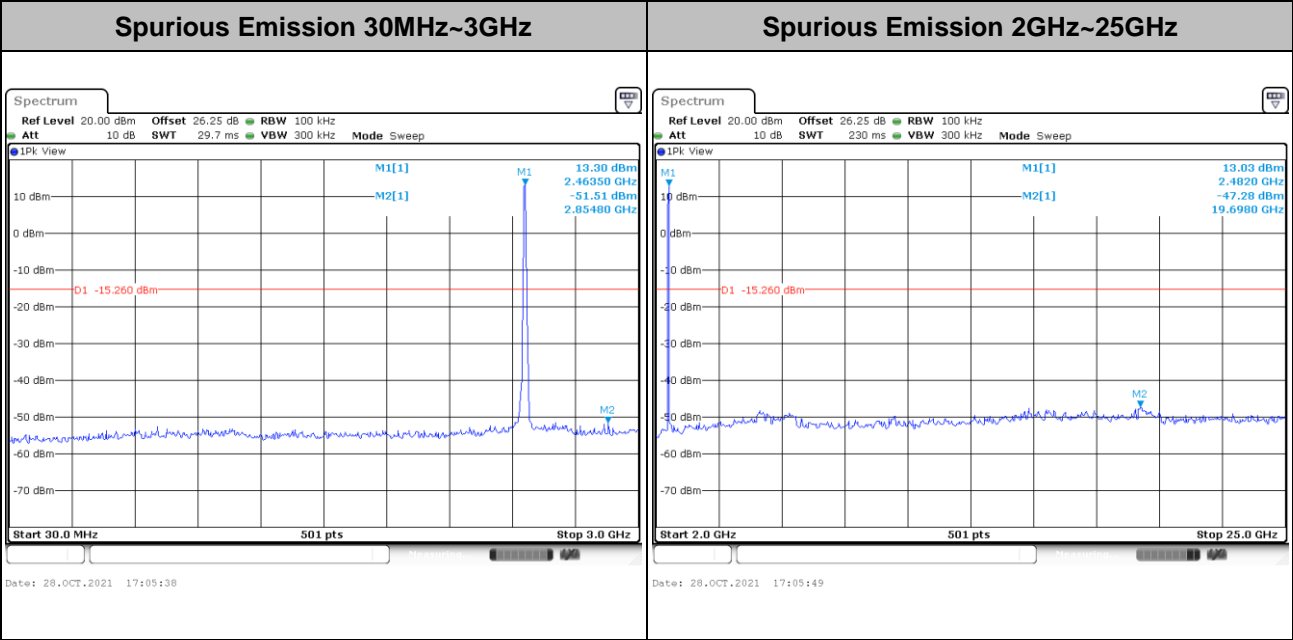
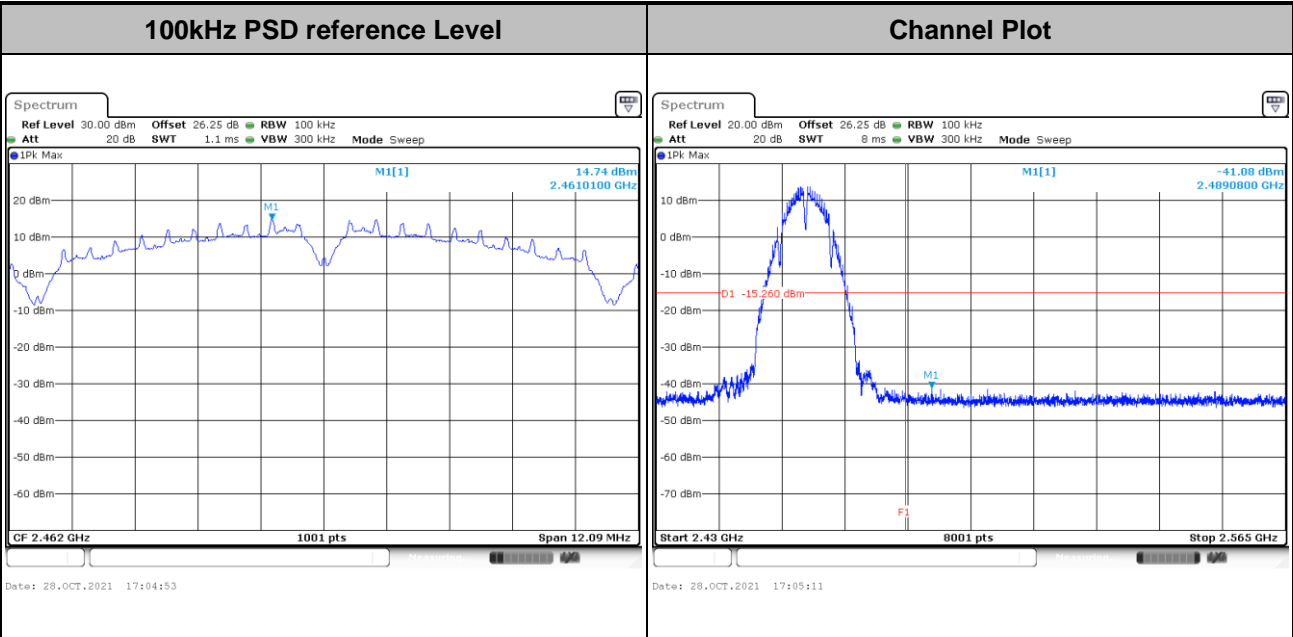



Test Mode : 802.11g Test Channel : 01

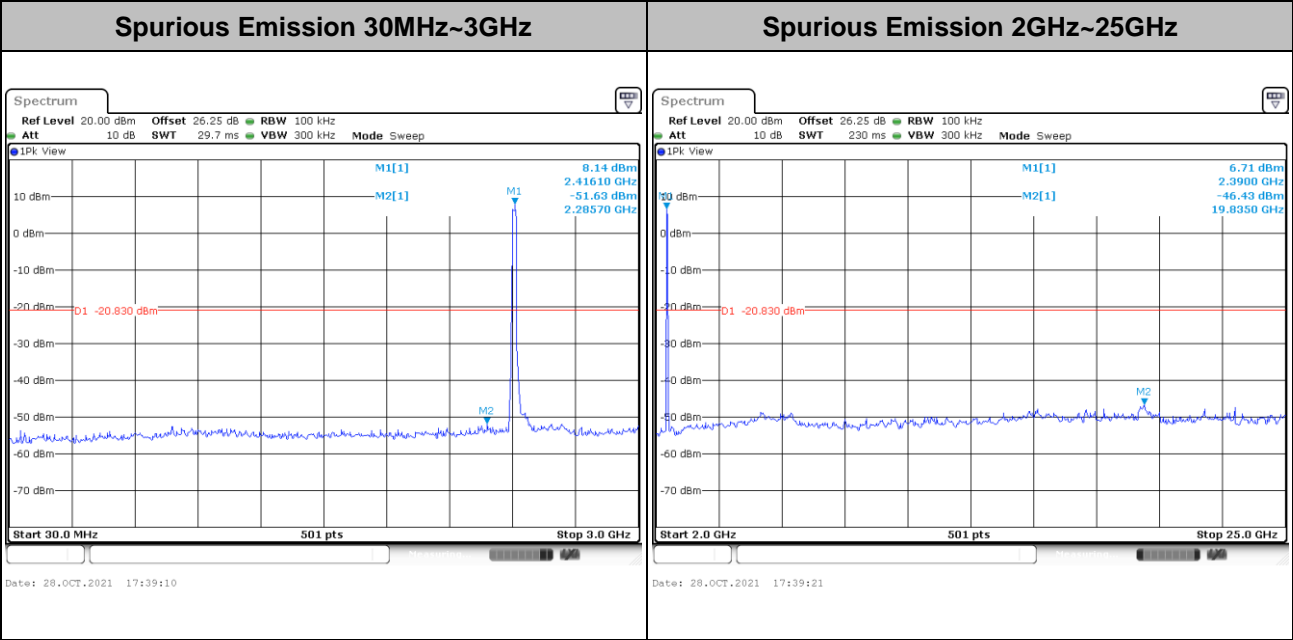
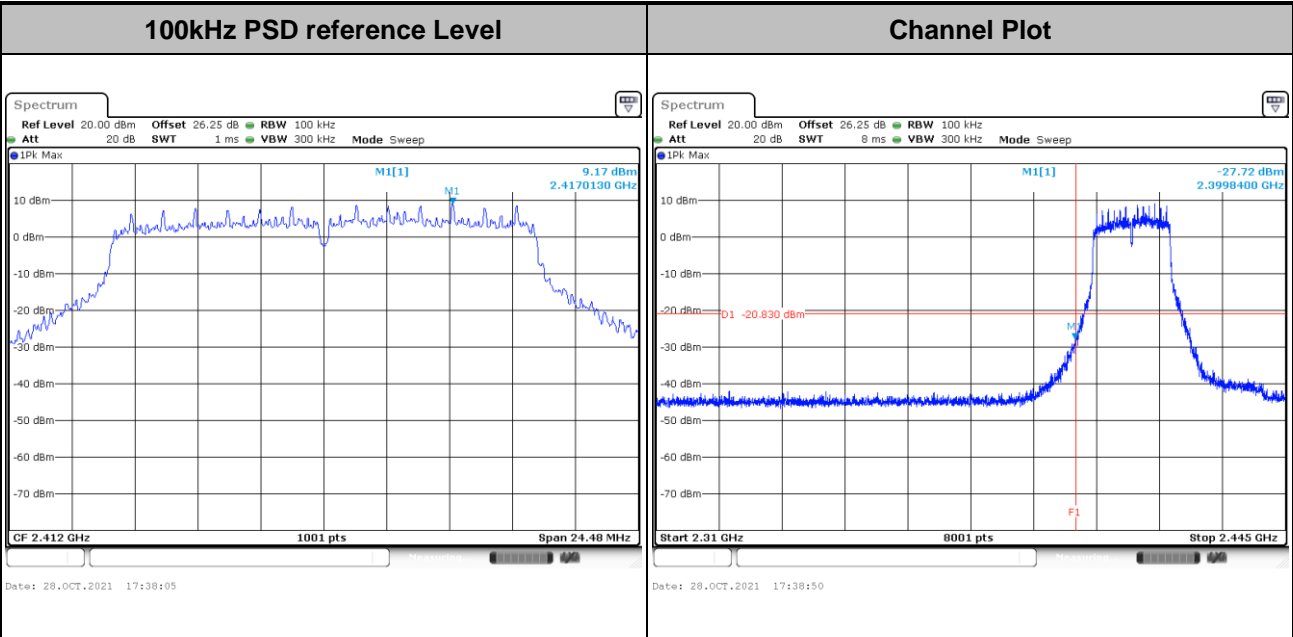



Test Mode :	802.11g	Test Channel :	06
-------------	---------	----------------	----

<b>100kHz PSD reference Level</b>	<b>Channel Plot</b>
-----------------------------------	---------------------

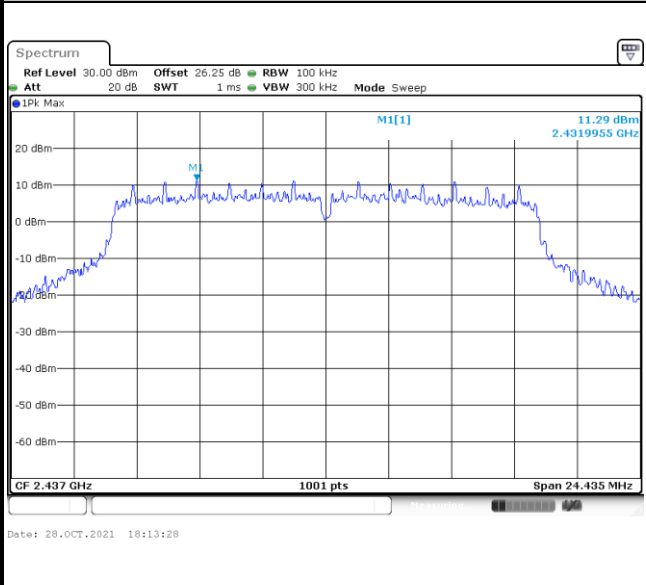

**Spurious Emission 30MHz~3GHz**

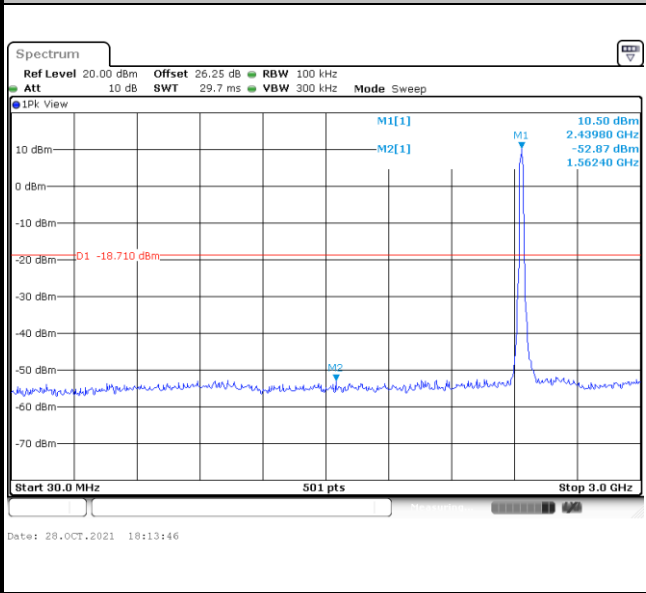

**Spurious Emission 2GHz~25GHz**

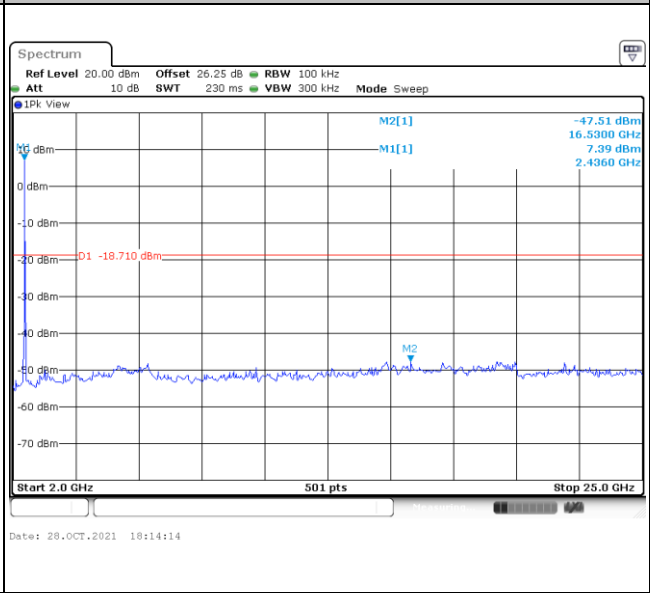



Test Mode :	802.11g	Test Channel :	11
-------------	---------	----------------	----

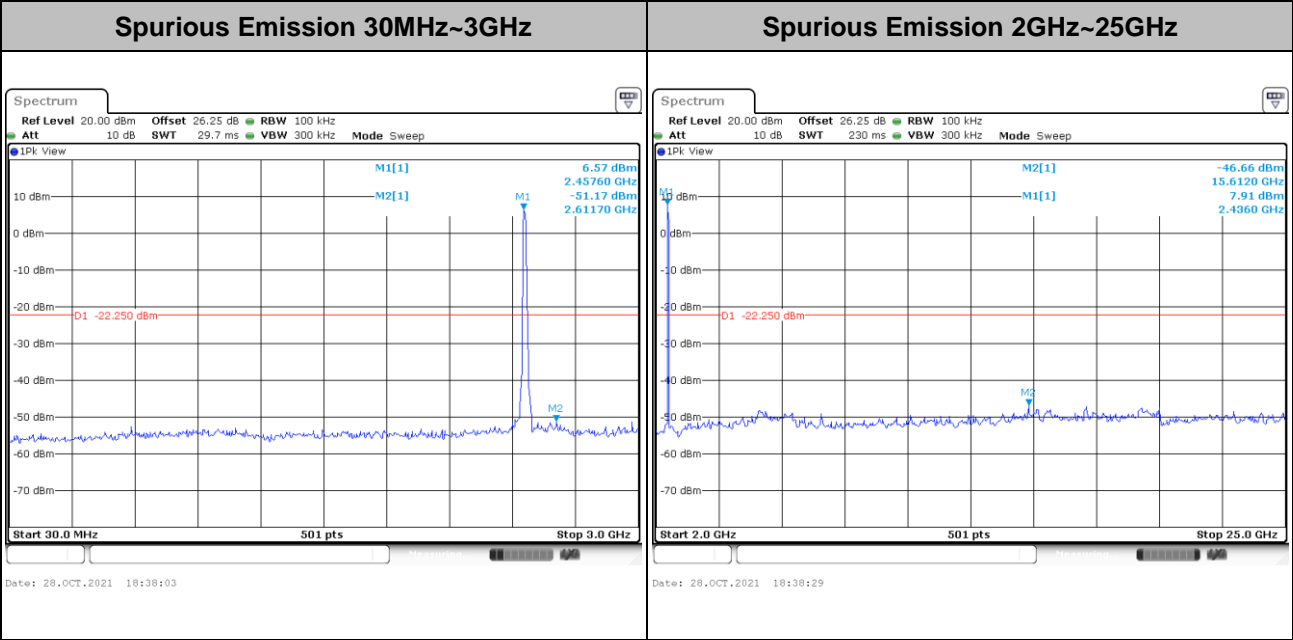
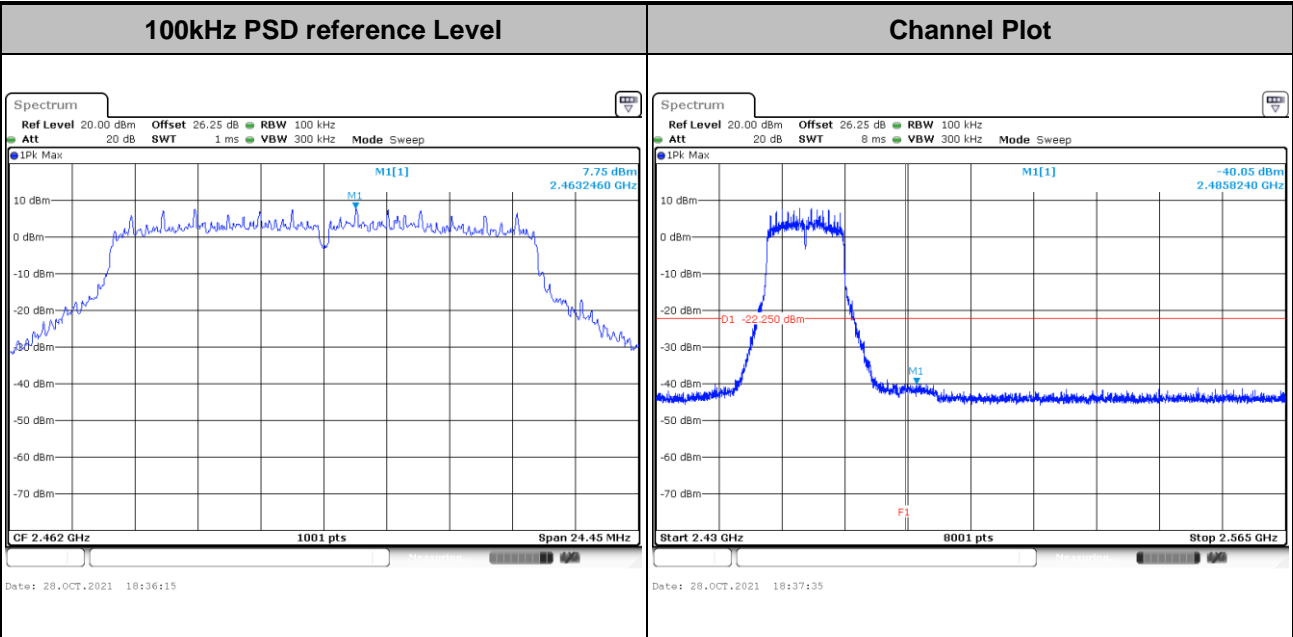



<b>Test Mode :</b>	802.11ax HE20	<b>Test Channel :</b>	01 Full RU
--------------------	---------------	-----------------------	------------

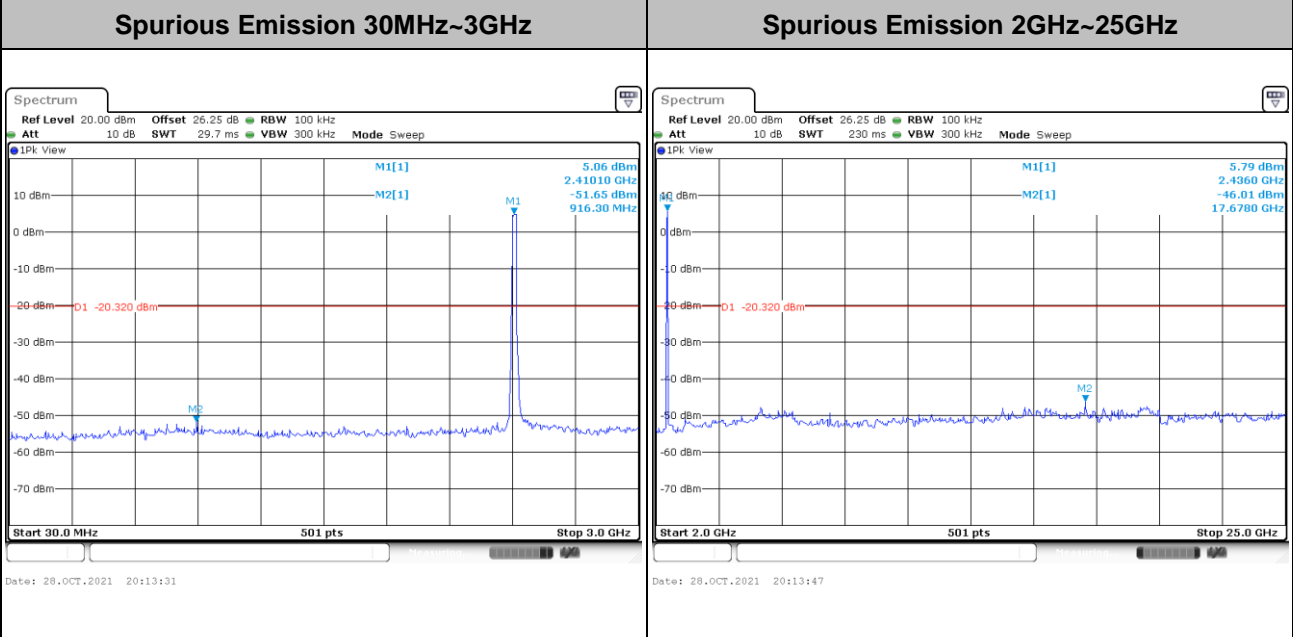
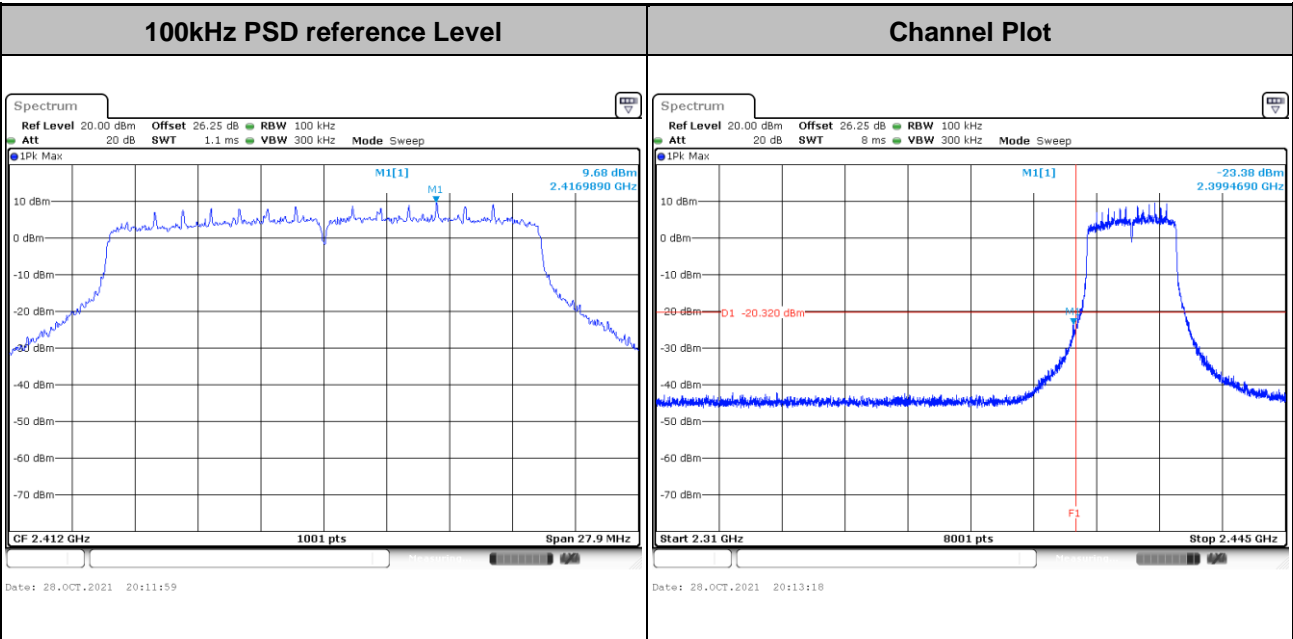





<b>Test Mode :</b>	802.11ax HE20	<b>Test Channel :</b>	06 Full RU
--------------------	---------------	-----------------------	------------

<b>100kHz PSD reference Level</b>	<b>Channel Plot</b>
-----------------------------------	---------------------

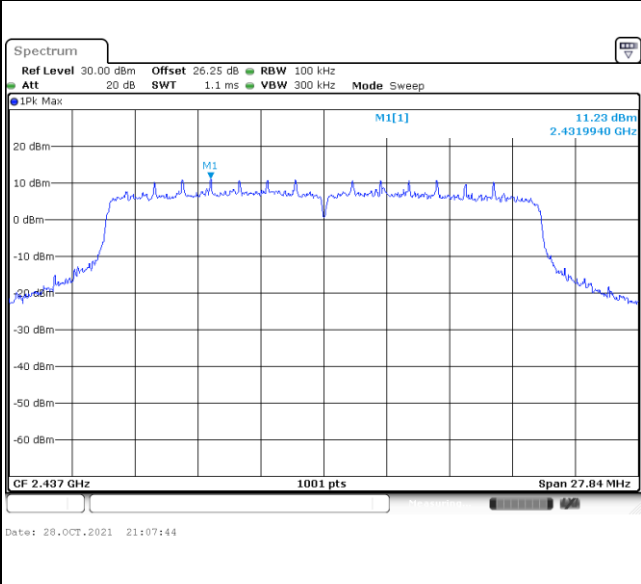

<b>Spurious Emission 30MHz~3GHz</b>	<b>Spurious Emission 2GHz~25GHz</b>
-------------------------------------	-------------------------------------

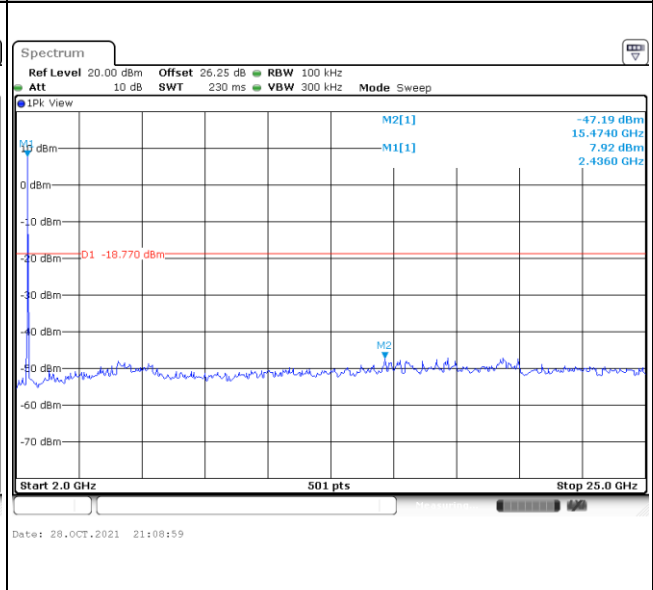
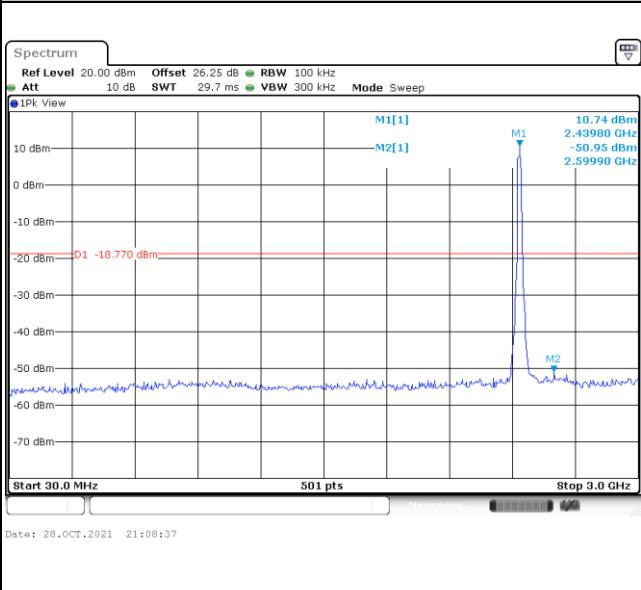



Test Mode : 802.11ax HE20 Test Channel : 11 Full RU

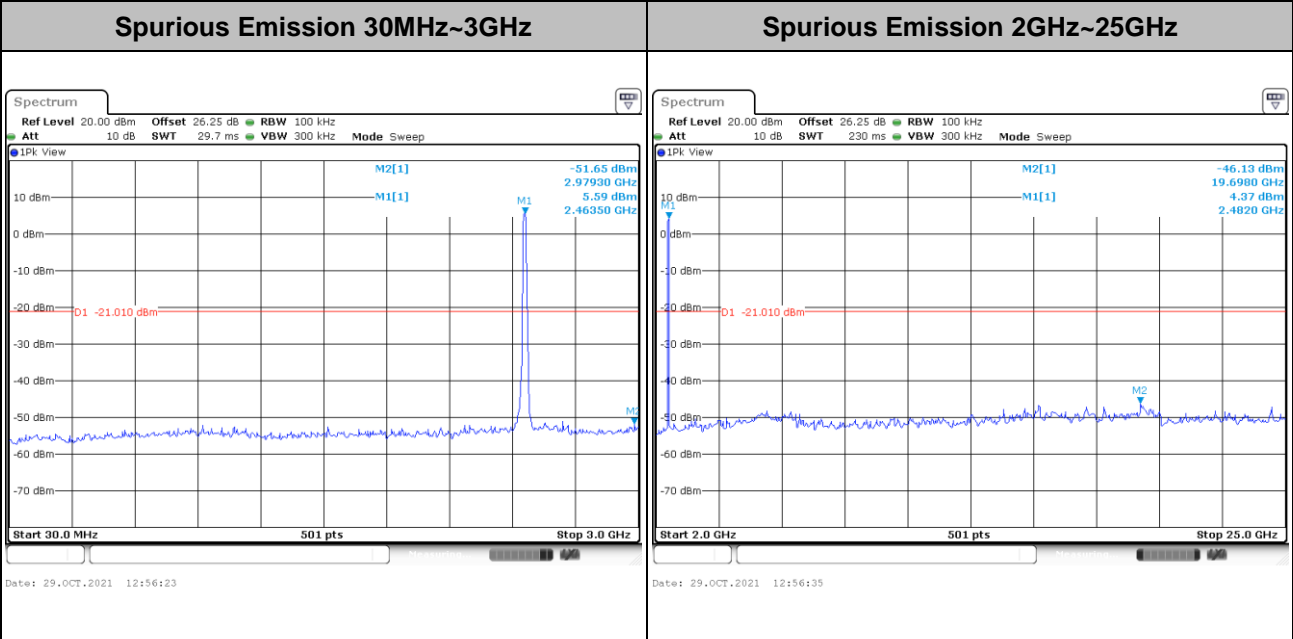
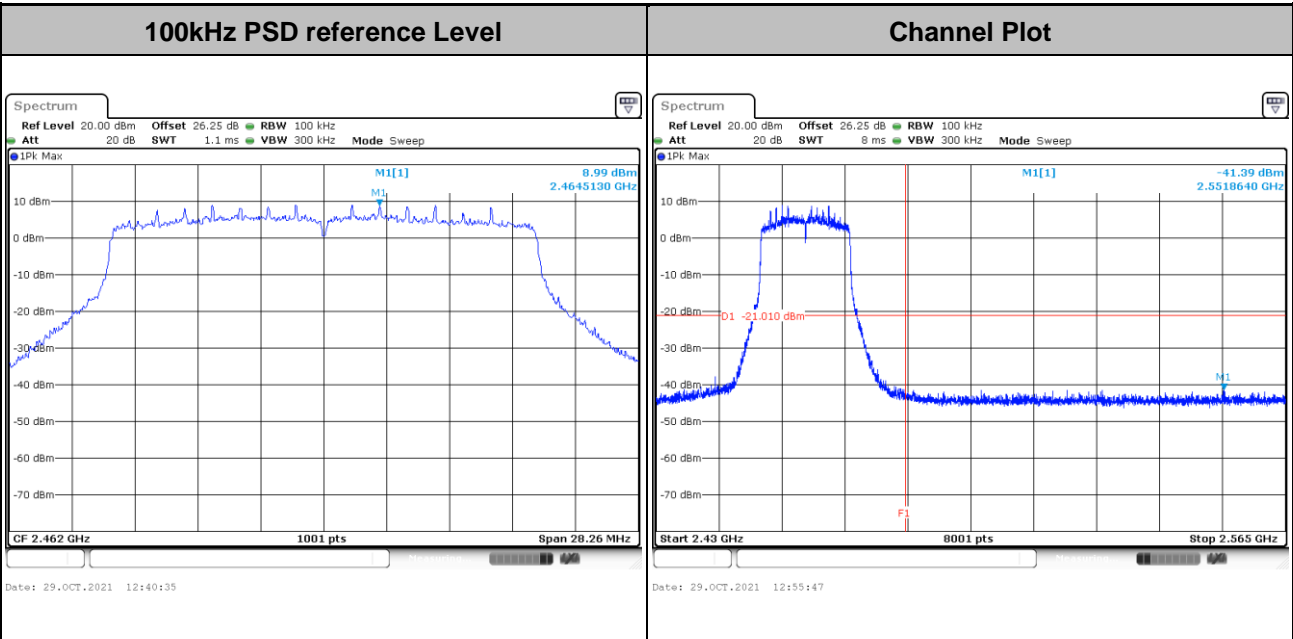



Test Mode : 802.11ax HE40      Test Channel : 03 Full RU

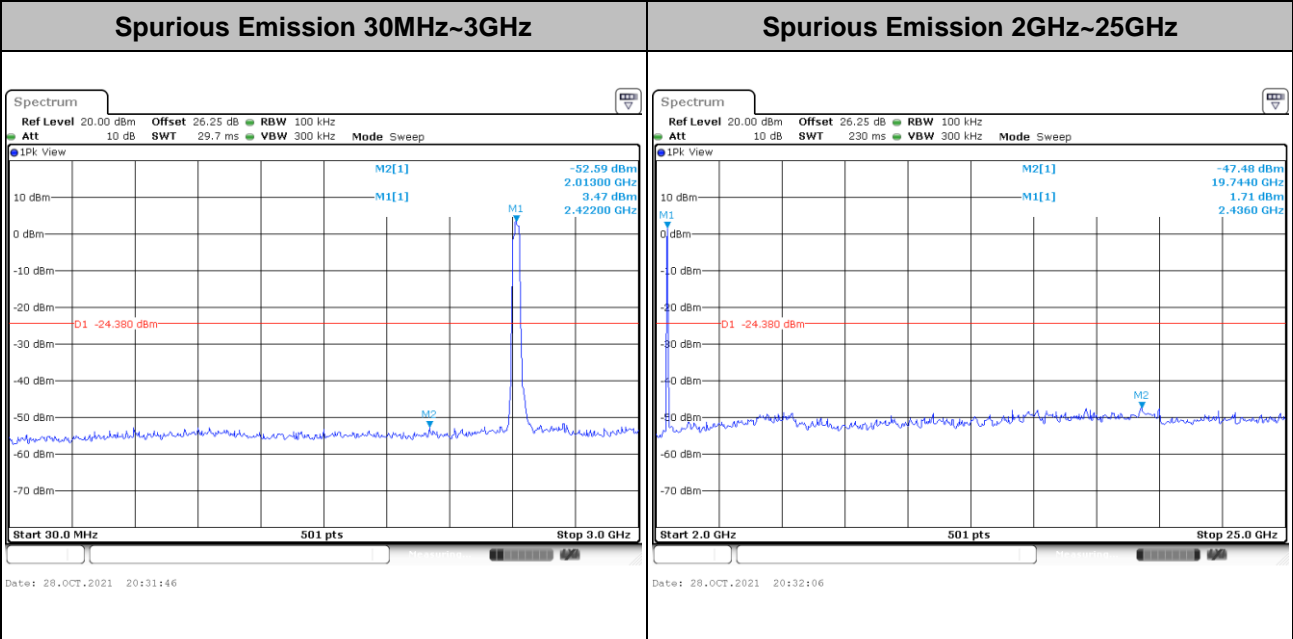
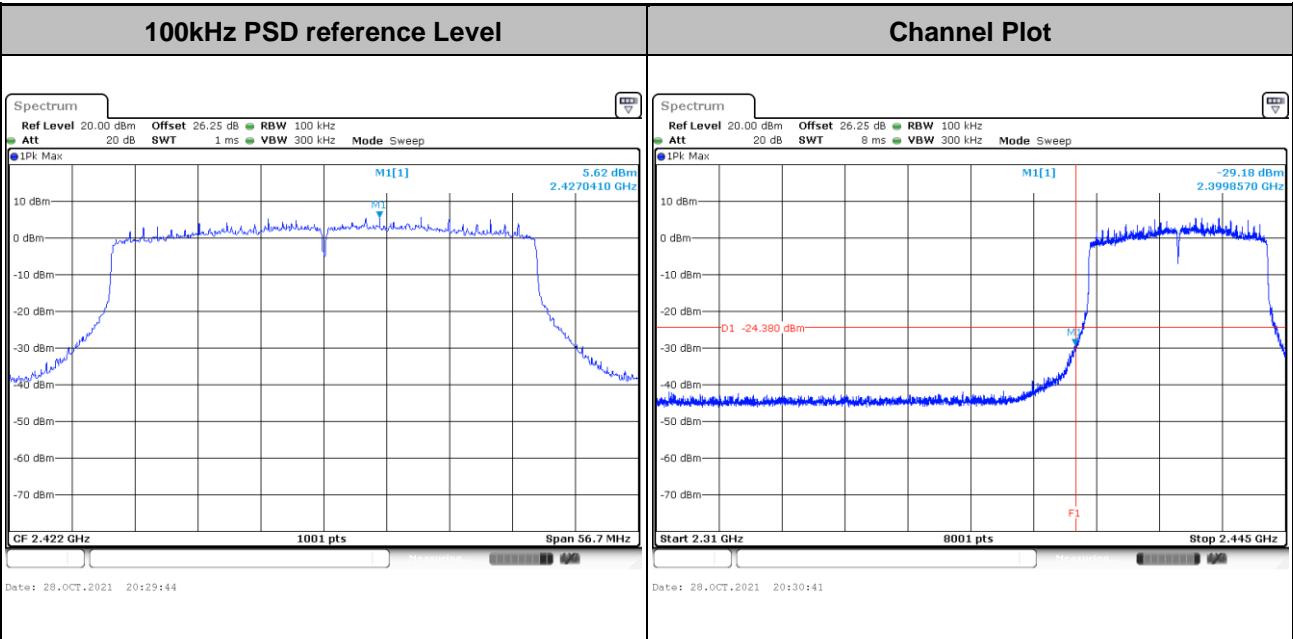



Test Mode :	802.11ax HE40	Test Channel :	06 Full RU
-------------	---------------	----------------	------------

<b>100kHz PSD reference Level</b>	<b>Channel Plot</b>
-----------------------------------	---------------------

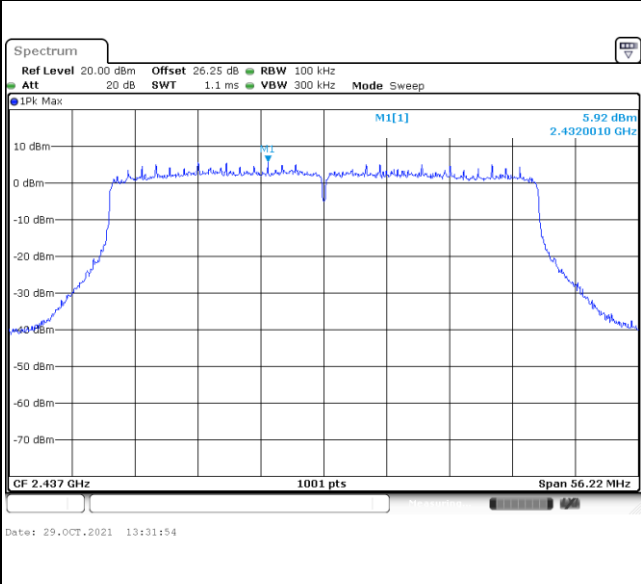

<b>Spurious Emission 30MHz~3GHz</b>	<b>Spurious Emission 2GHz~25GHz</b>
-------------------------------------	-------------------------------------

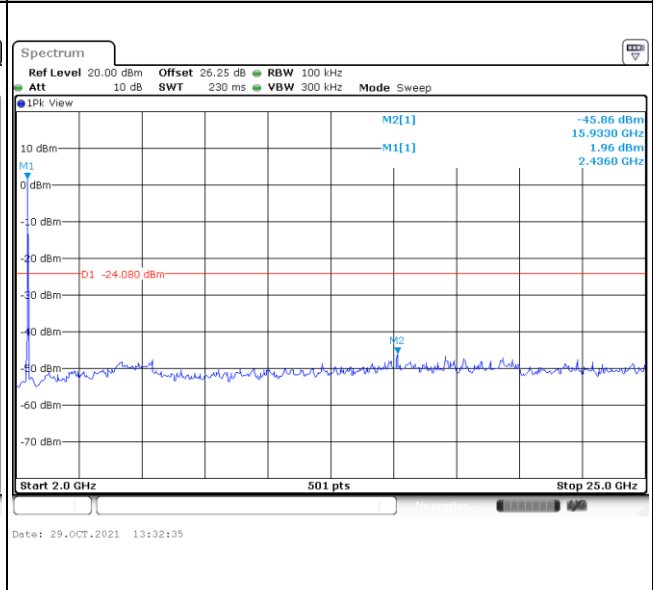
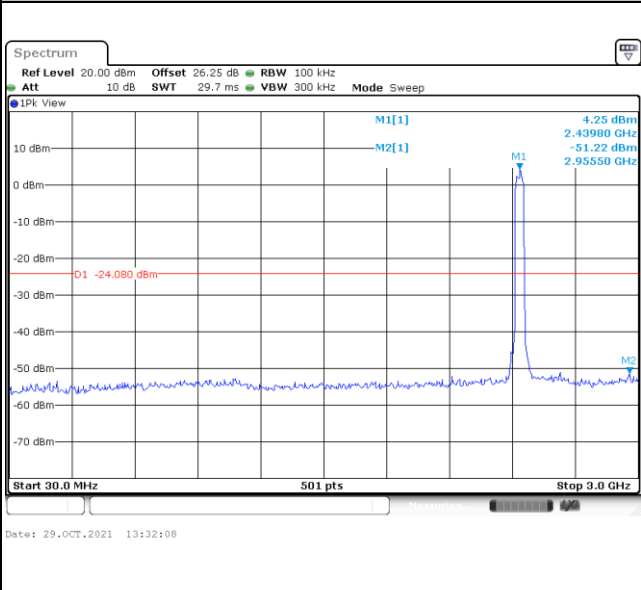



<b>Test Mode :</b> 802.11ax HE40	<b>Test Channel :</b> 09 Full RU
----------------------------------	----------------------------------

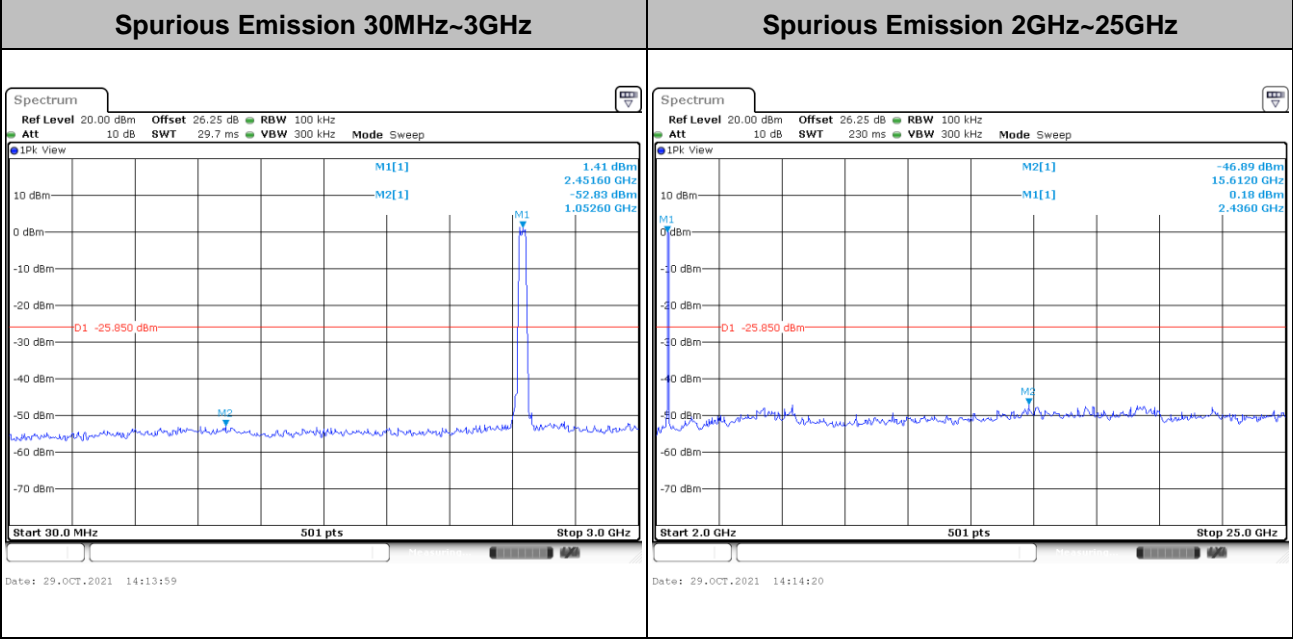
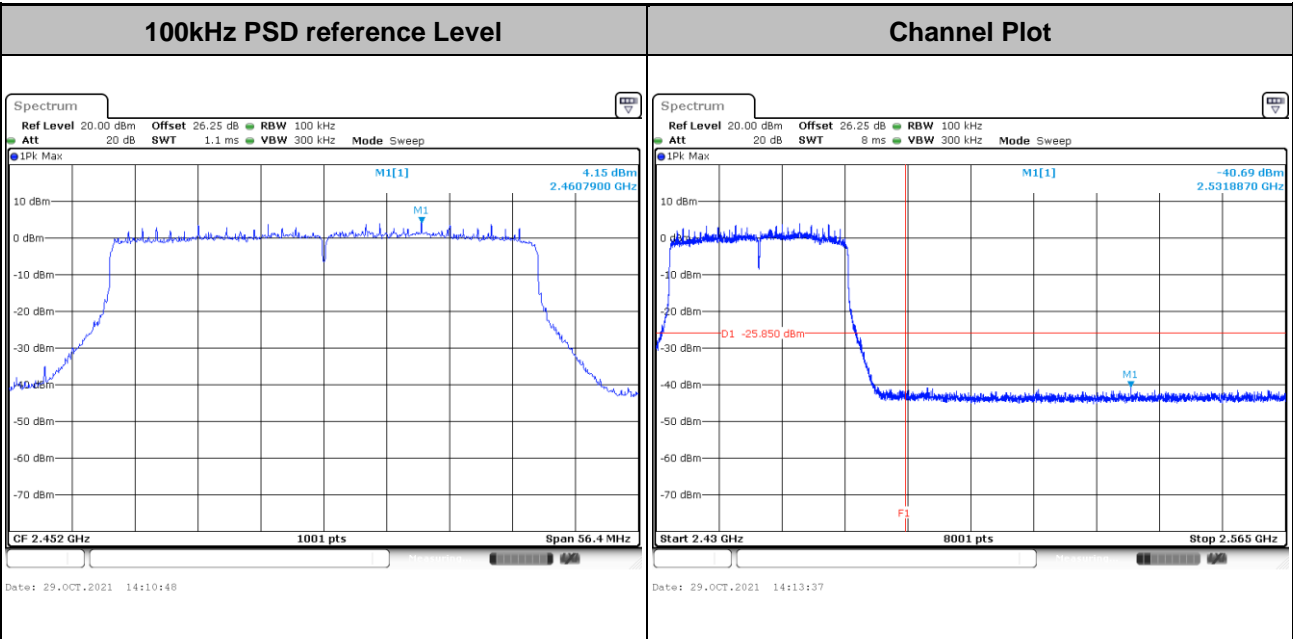



Number of TX = 4, Ant. B (Measured)

Test Mode :	802.11b	Test Channel :	01
-------------	---------	----------------	----

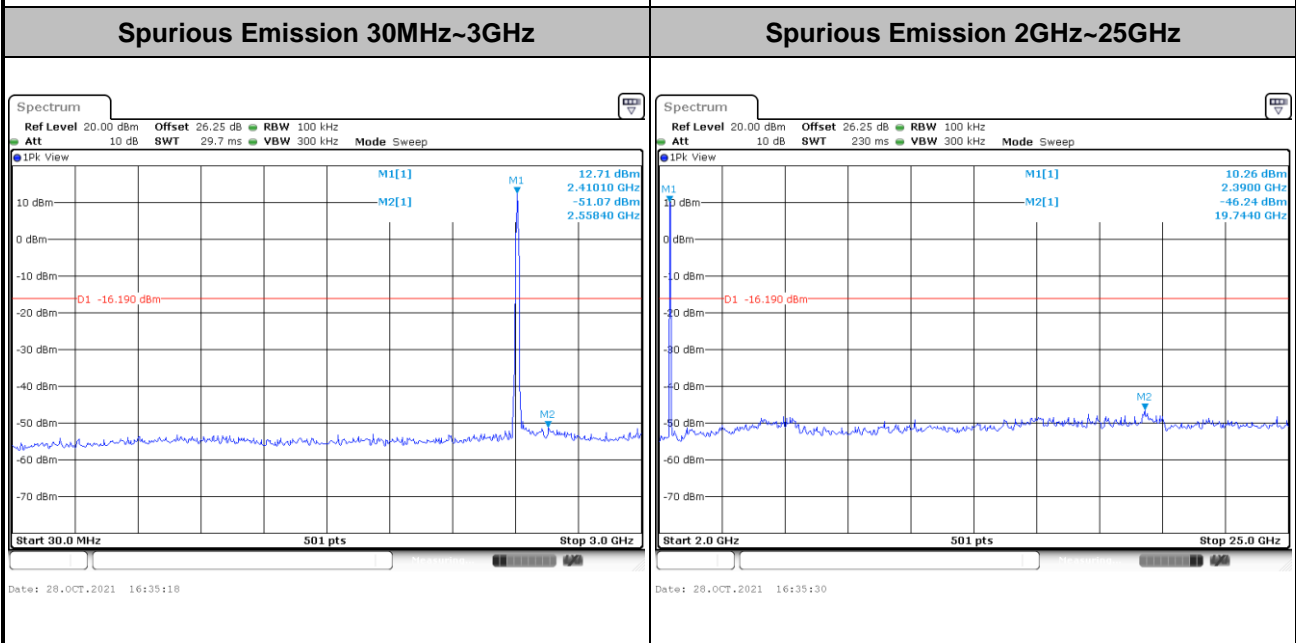
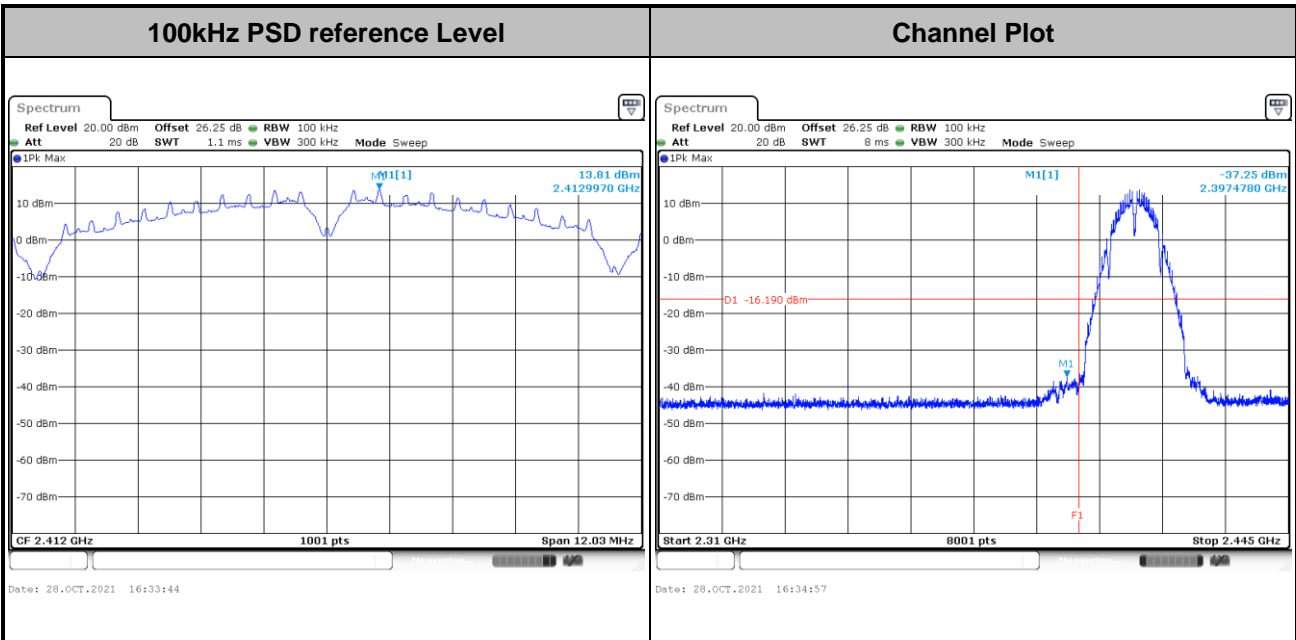



Test Mode :	802.11b	Test Channel :	06
-------------	---------	----------------	----

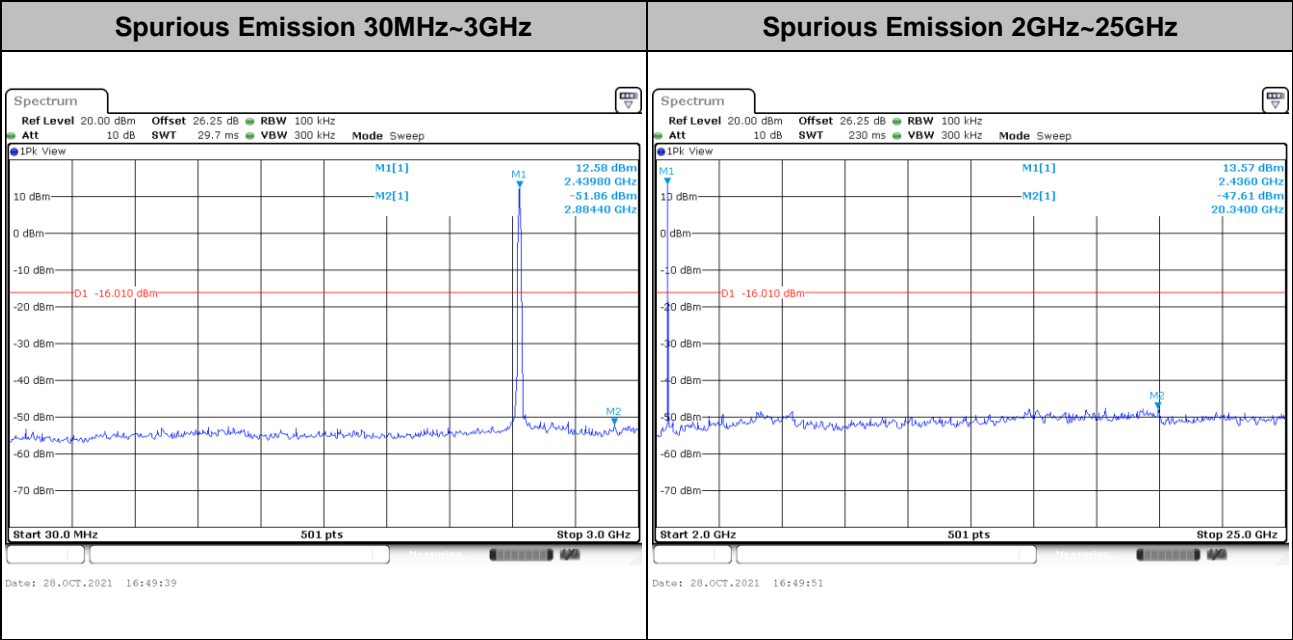
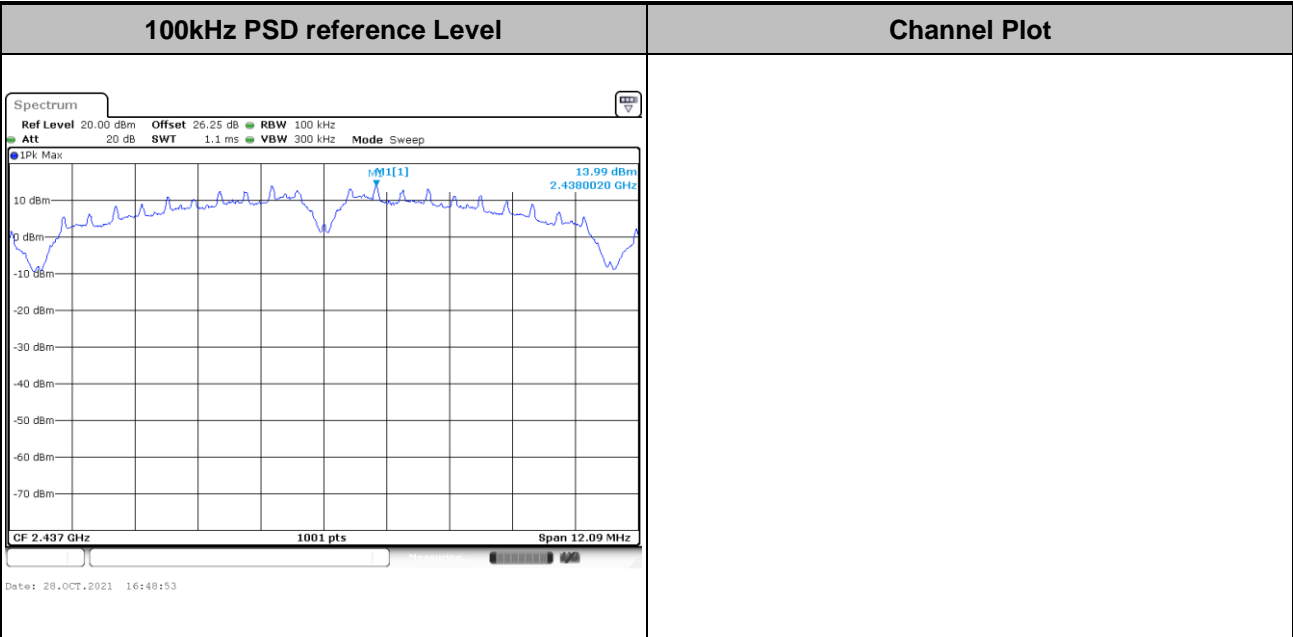



Test Mode :	802.11b	Test Channel :	11
-------------	---------	----------------	----

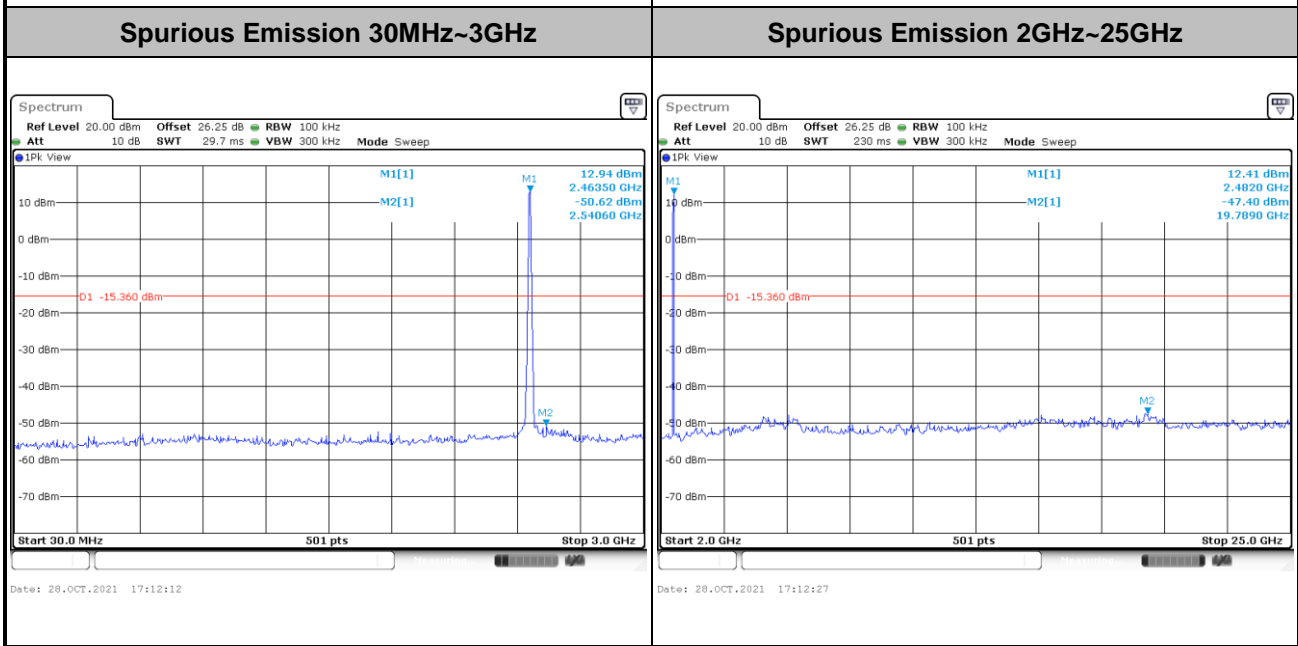
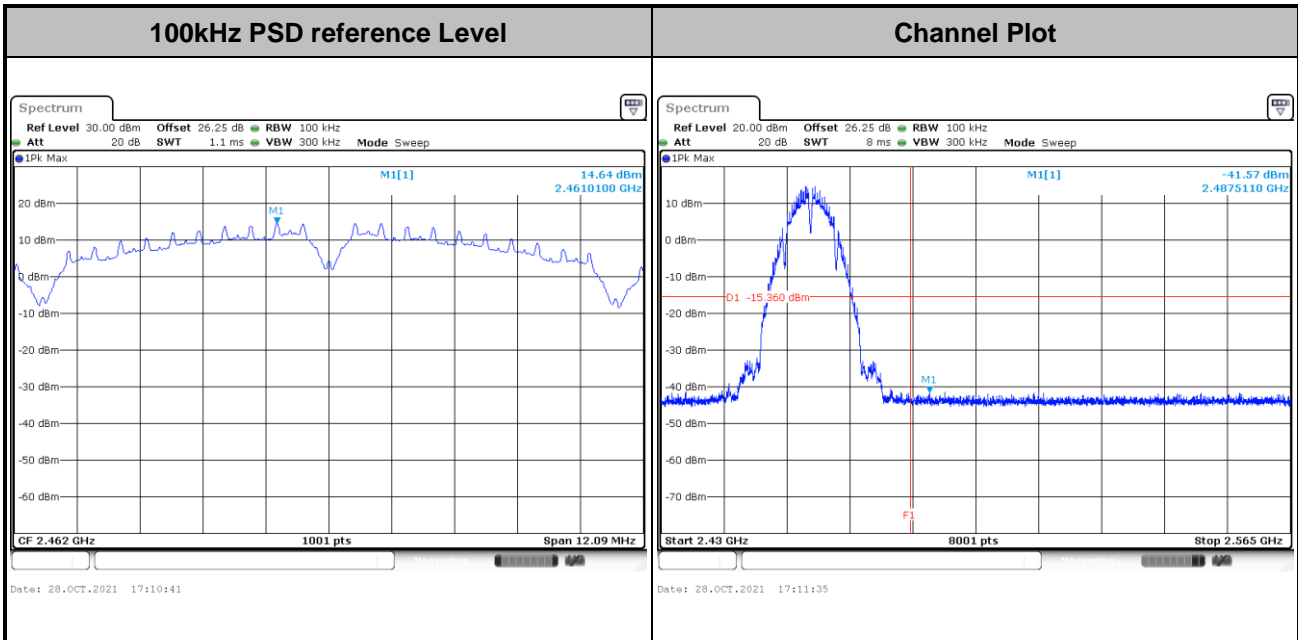





Test Mode :	802.11g	Test Channel :	01
-------------	---------	----------------	----

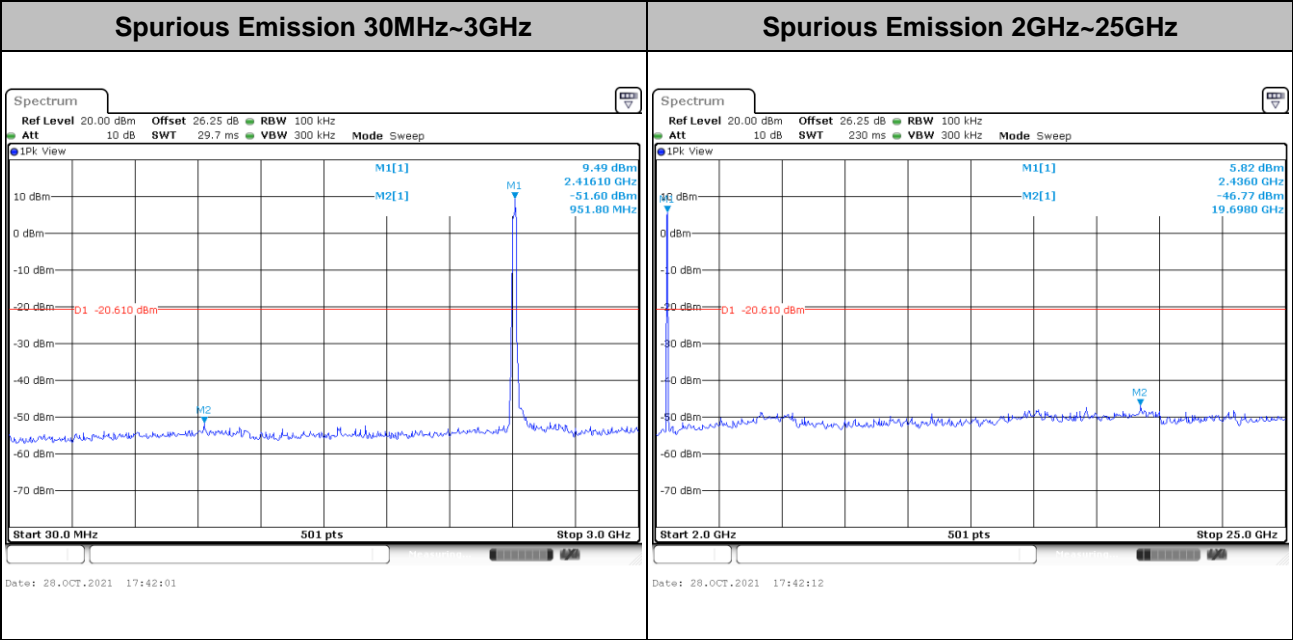
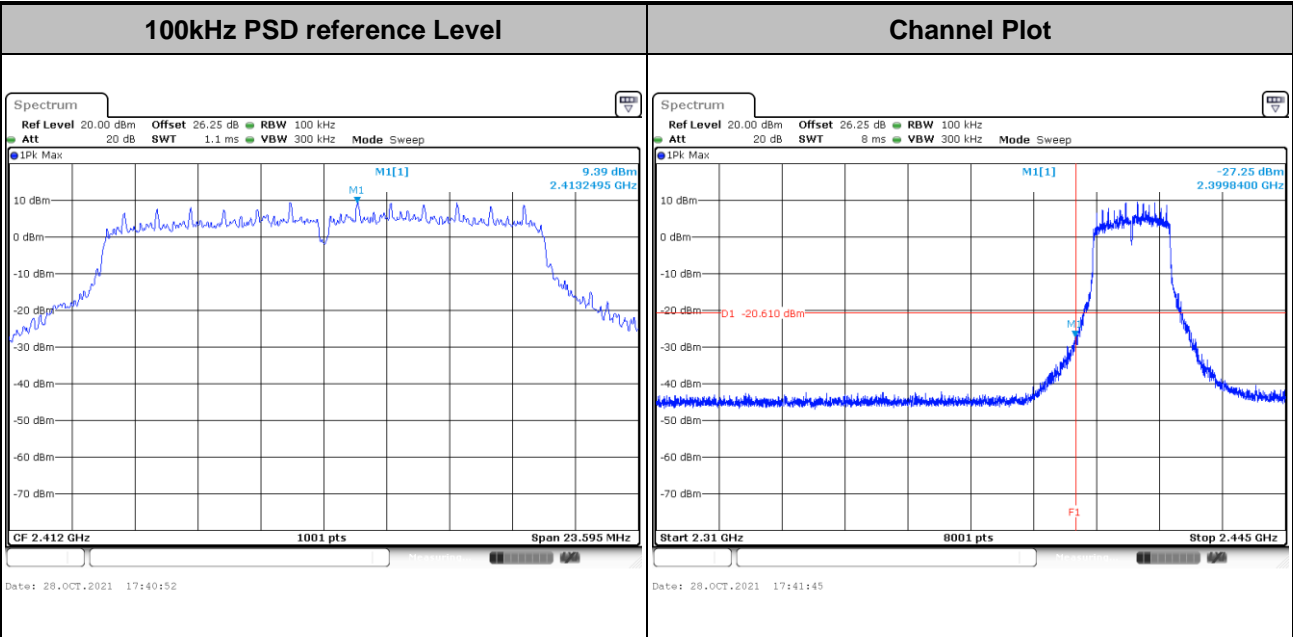



Test Mode :	802.11g	Test Channel :	06
-------------	---------	----------------	----

<b>100kHz PSD reference Level</b>	<b>Channel Plot</b>
-----------------------------------	---------------------

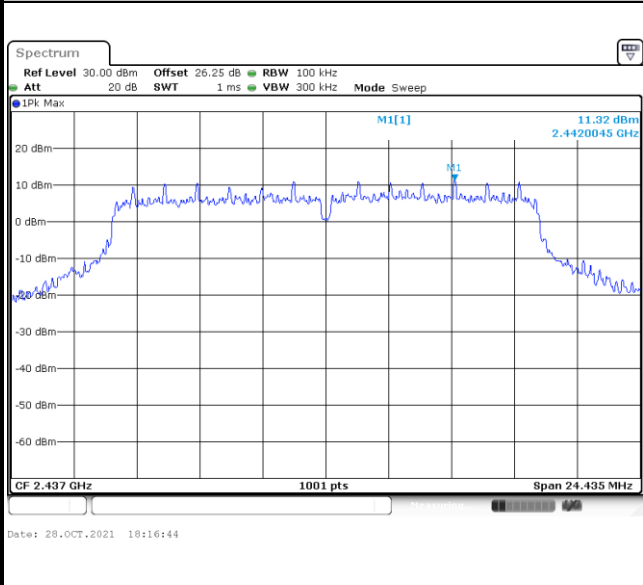

**Spurious Emission 30MHz~3GHz**

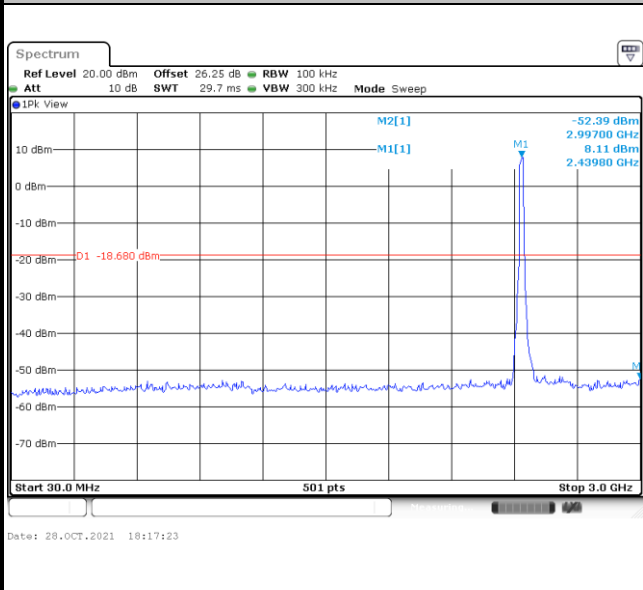

**Spurious Emission 2GHz~25GHz**

