



FCC RADIO TEST REPORT

FCC ID : S9GR760
Equipment : R760 Access Point
Brand Name : RUCKUS
Model Name : R760
Applicant : Ruckus Wireless Inc.
350 W. Java Dr., Sunnyvale CA 94089 USA
Manufacturer : Ruckus Wireless Inc.
350 W. Java Dr., Sunnyvale CA 94089 USA
Standard : FCC Part 15 Subpart E §15.407

The product was received on Jul. 28, 2021 and testing was performed from Aug. 15, 2021 to Jan. 04, 2022. We, Sporton International (USA) Inc., would like to declare that the tested sample has been evaluated in accordance with the test procedures and has been in compliance with the applicable technical standards.

The test results in this report apply exclusively to the tested model / sample. Without written approval from Sporton International (USA) Inc., the test report shall not be reproduced except in full.

Approved by: Neil Kao

Sporton International (USA) Inc.

1175 Montague Expressway, Milpitas, CA 95035



Table of Contents

| | |
|---|------------|
| History of this test report..... | 3 |
| Summary of Test Result..... | 4 |
| 1 General Description | 5 |
| 1.1 Product Feature of Equipment Under Test..... | 5 |
| 1.2 Modification of EUT | 7 |
| 1.3 Testing Location | 7 |
| 1.4 Applicable Standards..... | 7 |
| 2 Test Configuration of Equipment Under Test | 8 |
| 2.1 Carrier Frequency and Channel | 8 |
| 2.2 Test Mode..... | 10 |
| 2.3 Connection Diagram of Test System..... | 13 |
| 2.4 Support Unit used in test configuration and system | 14 |
| 2.5 EUT Operation Test Setup | 15 |
| 2.6 Measurement Results Explanation Example..... | 15 |
| 3 Test Result | 16 |
| 3.1 26dB & 99% Occupied Bandwidth Measurement | 16 |
| 3.2 Maximum conducted Output Power and Fundamental Maximum EIRP Measurement | 22 |
| 3.3 Fundamental Power Spectral Density Measurement | 24 |
| 3.4 In-Band Emissions (Channel Mask) | 31 |
| 3.5 Contention Based Protocol..... | 89 |
| 3.6 Unwanted Emissions Measurement..... | 102 |
| 3.7 AC Conducted Emission Measurement..... | 107 |
| 3.8 Antenna Requirements | 109 |
| 4 List of Measuring Equipment..... | 112 |
| 5 Uncertainty of Evaluation | 114 |
| Appendix A. Conducted Test Results | |
| Appendix B. AC Conducted Emission Test Result | |
| Appendix C. Radiated Spurious Emission | |
| Appendix D. Radiated Spurious Emission Plots | |
| Appendix E. Duty Cycle Plots | |
| Appendix F. Setup Photographs | |



History of this test report

| Report No. | Version | Description | Issue Date |
|--------------|---------|--|---------------|
| FR210728001F | 01 | Initial issue of report | Feb. 21, 2022 |
| FR210728001F | 02 | 1. Revise Limit in Section 3.2.1 and 3.3.1 2. Revise Test Summary of Contention Based Protocol Test | Mar. 15, 2022 |
| FR210728001F | 03 | Revise note for Test Summary of Contention Based Protocol Test | Mar. 31, 2022 |
| FR210728001F | 04 | Revise remark description in test mode | Apr. 19, 2022 |
| | | | |
| | | | |
| | | | |
| | | | |
| | | | |
| | | | |
| | | | |
| | | | |
| | | | |
| | | | |
| | | | |
| | | | |



Summary of Test Result

| Report Clause | Ref Std. Clause | Test Items | Result (PASS/FAIL) | Remark |
|---------------|----------------------------|------------------------------------|--------------------|---|
| 3.1 | 15.403(i) 15.407(a)(10) | 26dB Emission Bandwidth | Pass | - |
| 3.1 | 2.1049 | 99% Occupied Bandwidth | Reporting only | - |
| 3.2 | 15.407(a)(8) | Maximum Conducted Output Power | Reporting only | - |
| 3.2 | 15.407(a)(8) | Fundamental Maximum EIRP | Pass | - |
| 3.3 | 15.407(a)(8) | Fundamental Power Spectral Density | Pass | - |
| 3.4 | 15.407(b)(6) | In-Band Emissions (Channel Mask) | Pass | - |
| 3.5 | 15.407(d)(6) | Contention Based Protocol | Pass | - |
| 3.6 | 15.407(b) | Unwanted Emissions | Pass | 0.70 dB under the limit at 5912.680 MHz |
| 3.7 | 15.207 | AC Conducted Emission | Pass | 9.27 dB under the limit at 0.369 MHz |
| 3.8 | 15.203 15.407(a) | Antenna Requirement | Pass | - |

Declaration of Conformity:

The test results with all measurement uncertainty excluded are presented in accordance with the regulation limits or requirements declared by manufacturers.

Comments and Explanations:

The product specifications of the EUT presented in the report are declared by the manufacturer who shall take full responsibility for the authenticity.



1 General Description

1.1 Product Feature of Equipment Under Test

The EUT is an indoor AP with radios including Bluetooth - LE, Wi-Fi 2.4GHz 802.11b/g/n/ac/ax, Wi-Fi 5GHz 802.11a/n/ac/ax, Wi-Fi 6GHz 802.11a/n/ac/ax, 802.15.4 (Zigbee), equipped with integrated antennas configured below:

| Antenna Configuration | |
|-----------------------|---|
| Antenna Type | <p>WLAN 2.4GHz <Ant. A>: Omni Antenna <Ant. B>: Omni Antenna <Ant. C>: Omni Antenna <Ant. D>: Omni Antenna</p> <p>WLAN 5GHz Radio 1 and Radio 2: <Ant. A>: Omni Antenna <Ant. B>: Omni Antenna <Ant. C>: Omni Antenna <Ant. D>: Omni Antenna Radio 3: <Ant. E>: Omni Antenna <Ant. F>: Omni Antenna <Ant. G>: Omni Antenna <Ant. H>: Omni Antenna</p> <p>WLAN 6GHz <Ant. E>: Omni Antenna <Ant. F>: Omni Antenna <Ant. G>: Omni Antenna <Ant. H>: Omni Antenna</p> <p>Bluetooth-LE: <Ant. 1>Omni Antenna Zigbee: <Ant. 1>Omni Antenna</p> |



| Antenna information | | | |
|---------------------|-----------------|------------|--------------------------------|
| 5925 MHz ~ 6425 MHz | Peak Gain (dBi) | Vertical | <Ant. E>: 3.7 <Ant. H>: 3.7 |
| | | Horizontal | <Ant. F>: 3.8 <Ant. G>: 3.8 |
| 6425 MHz ~ 6525 MHz | Peak Gain (dBi) | Vertical | <Ant. E>: 3.7 <Ant. H>: 3.7 |
| | | Horizontal | <Ant. F>: 3.8 <Ant. G>: 3.8 |
| 6525 MHz ~ 6875 MHz | Peak Gain (dBi) | Vertical | <Ant. E>: 3.7 <Ant. H>: 3.7 |
| | | Horizontal | <Ant. F>: 3.8 <Ant. G>: 3.8 |
| 6875 MHz ~ 7125 MHz | Peak Gain (dBi) | Vertical | <Ant. E>: 3.7 <Ant. H>: 3.7 |
| | | Horizontal | <Ant. F>: 3.8 <Ant. G>: 3.8 |

Remark:

1. The above EUT's information is declared by manufacturer. Please refer to Comments and Explanations in report summary.
2. The device is a special case of MIMO system with four outputs driving a cross-polarized pair of linearly polarized antennas (noted as "vertical" and "horizontal").

The antenna printed on the secondary board which is vertically/horizontally mounted on the main board. Horizontal and Vertical antennas are cross-polarization antenna and the transmitter outputs is a 90-degree phase-shifted replica of the other and the phase centers of the two antennas orientations are co-located.



1.2 Modification of EUT

No modifications made to the EUT during the testing.

1.3 Testing Location

| | |
|--------------------|---|
| Test Site | Sporton International (USA) Inc. |
| Test Site Location | 1175 Montague Expressway, Milpitas, CA 95035 TEL : 408 9043300 |
| Test Site No. | Sporton Site No. TH01-CA, CO01-CA, 03CH02-CA, DFS01-CA |

Note: The test site complies with ANSI C63.4 2014 requirement.

1.4 Applicable Standards

According to the specifications declared by the manufacturer, the EUT must comply with the requirements of the following standards:

- ♦ FCC Part 15 Subpart E
- ♦ FCC KDB 789033 D02 General UNII Test Procedures New Rules v02r01.
- ♦ FCC KDB 987594 D02 U-NII 6 GHz EMC Measurement v01
- ♦ FCC KDB 414788 D01 Radiated Test Site v01r01.
- ♦ FCC KDB 662911 D01 Multiple Transmitter Output v02r01.
- ♦ ANSI C63.10-2013

Remark:

1. All the test items were validated and recorded in accordance with the standards without any modification during the testing.
2. This EUT has also been tested and complied with the requirements of FCC Part 15, Subpart B, recorded in a separate test report.



2 Test Configuration of Equipment Under Test

- a. The EUT has been associated with peripherals and configuration operated in a manner tended to maximize its emission characteristics in a typical application. Frequency range investigated: conduction emission (150 kHz to 30 MHz), radiation emission (9 kHz to the 10th harmonic of the highest fundamental frequency or to 40 GHz, whichever is lower). For radiated measurement, , the measured emission level of the EUT was maximized by rotating the EUT on a turntable, adjusting the orientation of the EUT and EUT antenna in three orthogonal axis (X: flat, Y: portrait, Z: landscape), and adjusting the measurement antenna orientation, following C63.10 exploratory test procedures and find Y plane as worst plane.
- b. AC power line Conducted Emission was tested under maximum output power.

2.1 Carrier Frequency and Channel

| | | | | | | | | | |
|---------|-------------|------|------|------|------|------|------|------|------|
| BW 20M | Channel | 1 | 5 | 9 | 13 | 17 | 21 | 25 | 29 |
| | Freq. (MHz) | 5955 | 5975 | 5995 | 6015 | 6035 | 6055 | 6075 | 6095 |
| BW 40M | Channel | 3 | | 11 | | 19 | | 27 | |
| | Freq. (MHz) | 5965 | | 6005 | | 6045 | | 6085 | |
| BW 80M | Channel | 7 | | | | 23 | | | |
| | Freq. (MHz) | 5985 | | | | 6065 | | | |
| BW 160M | Channel | 15 | | | | | | | |
| | Freq. (MHz) | 6025 | | | | | | | |

| | | | | | | | | | |
|---------|-------------|------|------|------|------|------|------|------|------|
| BW 20M | Channel | 33 | 37 | 41 | 45 | 49 | 53 | 57 | 61 |
| | Freq. (MHz) | 6115 | 6135 | 6155 | 6175 | 6195 | 6215 | 6235 | 6255 |
| BW 40M | Channel | 35 | | 43 | | 51 | | 59 | |
| | Freq. (MHz) | 6125 | | 6165 | | 6205 | | 6245 | |
| BW 80M | Channel | 39 | | | | 55 | | | |
| | Freq. (MHz) | 6145 | | | | 6225 | | | |
| BW 160M | Channel | 47 | | | | | | | |
| | Freq. (MHz) | 6185 | | | | | | | |



| | | | | | | | | | |
|----------------|--------------------|------|------|------|------|------|------|------|------|
| BW 20M | Channel | 65 | 69 | 73 | 77 | 81 | 85 | 89 | 93 |
| | Freq. (MHz) | 6275 | 6295 | 6315 | 6335 | 6355 | 6375 | 6395 | 6415 |
| BW 40M | Channel | 67 | | 75 | | 83 | | 91 | |
| | Freq. (MHz) | 6285 | | 6325 | | 6365 | | 6405 | |
| BW 80M | Channel | 71 | | | | 87 | | | |
| | Freq. (MHz) | 6305 | | | | 6385 | | | |
| BW 160M | Channel | 79 | | | | | | | |
| | Freq. (MHz) | 6345 | | | | | | | |

| | | | | | | | | | |
|----------------|--------------------|------|------|------|------|------|------|------|------|
| BW 20M | Channel | 97 | 101 | 105 | 109 | 113 | 117 | 121 | 125 |
| | Freq. (MHz) | 6435 | 6455 | 6475 | 6495 | 6515 | 6535 | 6555 | 6575 |
| BW 40M | Channel | 99 | | 107 | | 115 | | 123 | |
| | Freq. (MHz) | 6445 | | 6485 | | 6525 | | 6565 | |
| BW 80M | Channel | 103 | | | | 119 | | | |
| | Freq. (MHz) | 6465 | | | | 6545 | | | |
| BW 160M | Channel | 111 | | | | | | | |
| | Freq. (MHz) | 6505 | | | | | | | |

| | | | | | | | | | |
|----------------|--------------------|------|------|------|------|------|------|------|------|
| BW 20M | Channel | 129 | 133 | 137 | 141 | 145 | 149 | 153 | 157 |
| | Freq. (MHz) | 6595 | 6615 | 6635 | 6655 | 6675 | 6695 | 6715 | 6735 |
| BW 40M | Channel | 131 | | 139 | | 147 | | 155 | |
| | Freq. (MHz) | 6605 | | 6645 | | 6685 | | 6725 | |
| BW 80M | Channel | 135 | | | | 151 | | | |
| | Freq. (MHz) | 6625 | | | | 6705 | | | |
| BW 160M | Channel | 143 | | | | | | | |
| | Freq. (MHz) | 6665 | | | | | | | |

| | | | | | | | | | |
|----------------|--------------------|------|------|------|------|------|------|------|------|
| BW 20M | Channel | 161 | 165 | 169 | 173 | 177 | 181 | 185 | 189 |
| | Freq. (MHz) | 6755 | 6775 | 6795 | 6815 | 6835 | 6855 | 6875 | 6895 |
| BW 40M | Channel | 163 | | 171 | | 179 | | 187 | |
| | Freq. (MHz) | 6765 | | 6805 | | 6845 | | 6885 | |
| BW 80M | Channel | 167 | | | | 183 | | | |
| | Freq. (MHz) | 6785 | | | | 6865 | | | |
| BW 160M | Channel | 175 | | | | | | | |
| | Freq. (MHz) | 6825 | | | | | | | |



| | | | | | | | | | |
|----------------|--------------------|------|------|------|------|------|------|------|------|
| BW 20M | Channel | 193 | 197 | 201 | 205 | 209 | 213 | 217 | 221 |
| | Freq. (MHz) | 6915 | 6935 | 6955 | 6975 | 6995 | 7015 | 7035 | 7055 |
| BW 40M | Channel | 195 | | 203 | | 211 | | 219 | |
| | Freq. (MHz) | 6925 | | 6965 | | 7005 | | 7045 | |
| BW 80M | Channel | 199 | | | | 215 | | | |
| | Freq. (MHz) | 6945 | | | | 7025 | | | |
| BW 160M | Channel | 207 | | | | | | | |
| | Freq. (MHz) | 6985 | | | | | | | |
| BW 20M | Channel | 225 | | | | 229 | | | |
| | Freq. (MHz) | 7075 | | | | 7095 | | | |
| BW 40M | Channel | 227 | | | | | | | |
| | Freq. (MHz) | 7085 | | | | | | | |

2.2 Test Mode

All modulation schemes/data rate are verified by conducted power test case, and the modulation schemes with highest power is used for all test cases. The final test items are considering the modulation schemes and the worst data rates as the table below.

CDD Mode

| Modulation | Data Rate |
|---|------------------|
| 802.11a | 6 Mbps |
| 802.11n HT20 (Covered by HE20) | MCS0 |
| 802.11n HT40 (Covered by HE40) | MCS0 |
| 802.11ac VHT20 (Covered by HE20) | MCS0 |
| 802.11ac VHT40 (Covered by HE40) | MCS0 |
| 802.11ac VHT80 (Covered by HE80) | MCS0 |
| 802.11ac VHT160 (Covered by HE160) | MCS0 |
| 802.11ax HE20 | MCS0 |
| 802.11ax HE40 | MCS0 |
| 802.11ax HE80 | MCS0 |
| 802.11ax HE160 | MCS0 |



TXBF Mode

| Modulation | Data Rate |
|----------------|-----------|
| 802.11a | 6 Mbps |
| 802.11n HT20 | MCS0 |
| 802.11n HT40 | MCS0 |
| 802.11ac VHT20 | MCS0 |
| 802.11ac VHT40 | MCS0 |
| 802.11ac VHT80 | MCS0 |
| 802.11ax HE20 | MCS0 |
| 802.11ax HE40 | MCS0 |
| 802.11ax HE80 | MCS0 |
| 802.11ax HE160 | MCS0 |

Note:

1. Since the verify power, the smaller power can be covered by the higher power. The SISO Mode is covered by MIMO Mode.
2. The 802.11ax covers the 802.11n and 11ac due to same modulation family scheme.

AC Conducted Emission Test Cases are listed in the following table:

| Test Cases | |
|---|---|
| AC Conducted Emission | <p>Mode 1 : WLAN (2.4GHz) Link + Bluetooth – LE Idle + Zigbee Link + WLAN (5GHz) Radio 2 Link + WLAN (6GHz) Link + AC Adapter + LAN 1 Link + LAN 2 Link + USB Flash Drive (Load)</p> <p>Mode 2 : WLAN (2.4GHz) Link + Bluetooth – LE Idle + Zigbee Link + WLAN (5GHz) Radio 3 Link + WLAN (5GHz) (Iron 5G -QPQ190) Link + AC Adapter + LAN1 Link + LAN 2 Link + USB Flash Drive (Load)</p> <p>Mode 3 : WLAN (2.4GHz) Link + Bluetooth – LE Link + Zigbee Idle + WLAN (5GHz) Radio 2 Link + WLAN (6GHz) Link + AC Adapter + LAN 1 Link + LAN 2 Link + USB Flash Drive (Load)</p> |
| Remark: The worst case of Conducted Emission is mode 1; only the test data of it was reported. | |



RF test channels are listed in the following table:

| Ch. # | | UNII-5 (5925-6425 MHz) | UNII-6 (6425-6525 MHz) | UNII-7 (6525-6875 MHz) | UNII-8 (6875-7125 MHz) |
|----------|--------|---------------------------|---------------------------|---------------------------|---------------------------|
| | | 802.11a | 802.11a | 802.11a | 802.11a |
| L | Low | 001 | 097 | 117 | 189 |
| M | Middle | 045 | 105 | 149 | 209 |
| H | High | 093 | 113 | 181 | 229 |
| Straddle | | - | - | 185 | - |

| Ch. # | | UNII-5 (5925-6425 MHz) | UNII-6 (6425-6525 MHz) | UNII-7 (6525-6875 MHz) | UNII-8 (6875-7125 MHz) |
|----------|--------|---------------------------|---------------------------|---------------------------|---------------------------|
| | | 802.11ax HE20 | 802.11ax HE20 | 802.11ax HE20 | 802.11ax HE20 |
| L | Low | 001 | 097 | 117 | 189 |
| M | Middle | 045 | 105 | 149 | 209 |
| H | High | 093 | 113 | 181 | 229 |
| Straddle | | - | - | 185 | - |

| Ch. # | | UNII-5 (5925-6425 MHz) | UNII-6 (6425-6525 MHz) | UNII-7 (6525-6875 MHz) | UNII-8 (6875-7125 MHz) |
|----------|--------|---------------------------|---------------------------|---------------------------|---------------------------|
| | | 802.11ax HE40 | 802.11ax HE40 | 802.11ax HE40 | 802.11ax HE40 |
| L | Low | 003 | 099 | 123 | 195 |
| M | Middle | 043 | - | 147 | 211 |
| H | High | 091 | 107 | 179 | 227 |
| Straddle | | - | 115 | 187 | - |

| Ch. # | | UNII-5 (5925-6425 MHz) | UNII-6 (6425-6525 MHz) | UNII-7 (6525-6875 MHz) | UNII-8 (6875-7125 MHz) |
|----------|--------|---------------------------|---------------------------|---------------------------|---------------------------|
| | | 802.11ax HE80 | 802.11ax HE80 | 802.11ax HE80 | 802.11ax HE80 |
| L | Low | 007 | 103 | 135 | 199 |
| M | Middle | 039 | | 151 | - |
| H | High | 087 | | 167 | 215 |
| Straddle | | - | 119 | 183 | - |

| Ch. # | | UNII-5 (5925-6425 MHz) | UNII-6 (6425-6525 MHz) | UNII-7 (6525-6875 MHz) | UNII-8 (6875-7125 MHz) |
|----------|--------|---------------------------|---------------------------|---------------------------|---------------------------|
| | | 802.11ax HE160 | 802.11ax HE160 | 802.11ax HE160 | 802.11ax HE160 |
| L | Low | 015 | - | 143 | 207 |
| M | Middle | 047 | | | |
| H | High | 079 | | | |
| Straddle | | - | 111 | 175 | - |

Remark:

1. For radiation spurious emission, the modulation and the data rate picked for testing are determined by the Max. RF conducted power.
2. RF power on each chain in MIMO mode is greater than SISO mode. The SISO Mode is covered by MIMO Mode.
3. After preliminary scan designated by the manufacturer, CDD mode is determined to be the worst case compared to Beamforming mode, hence, all the radiated test is performed in CDD mode.
4. The setup method between CDD and Beamforming mode is identical except that one of the polarizations is disabled while Beamforming mode is activated so both modes share the same conducted power table. The only difference is how directional gain is calculated between two modes.
5. Partial RUs are not supported at the current product stage, the test report and test results do not cover any Partial RU test assessments.

2.3 Connection Diagram of Test System

<AC Conducted Emission Mode>

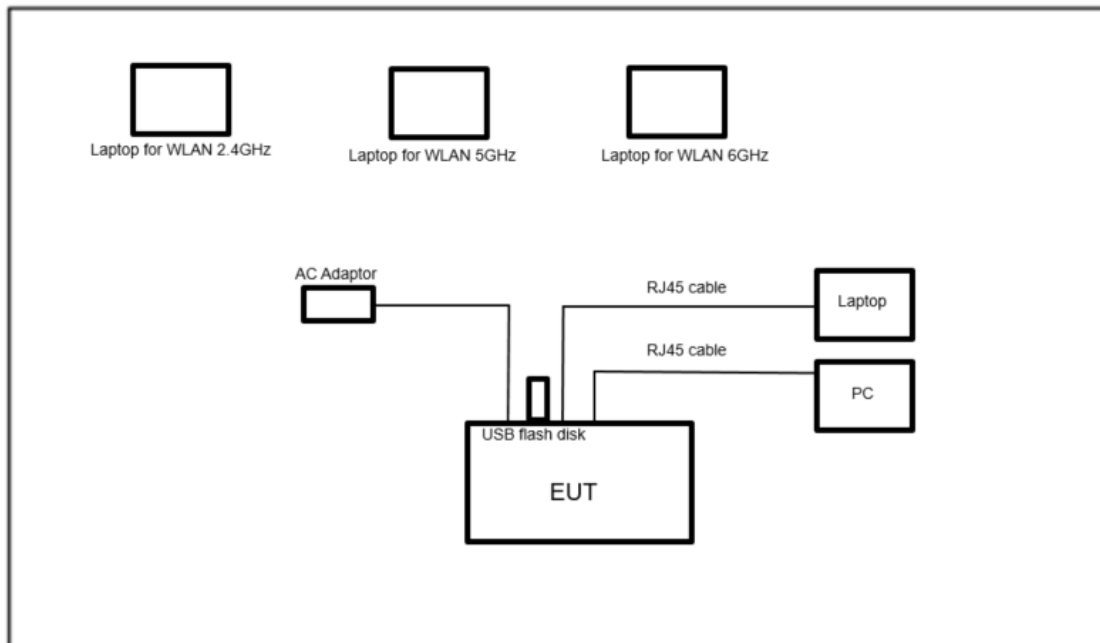

<Radiated Emission Mode>

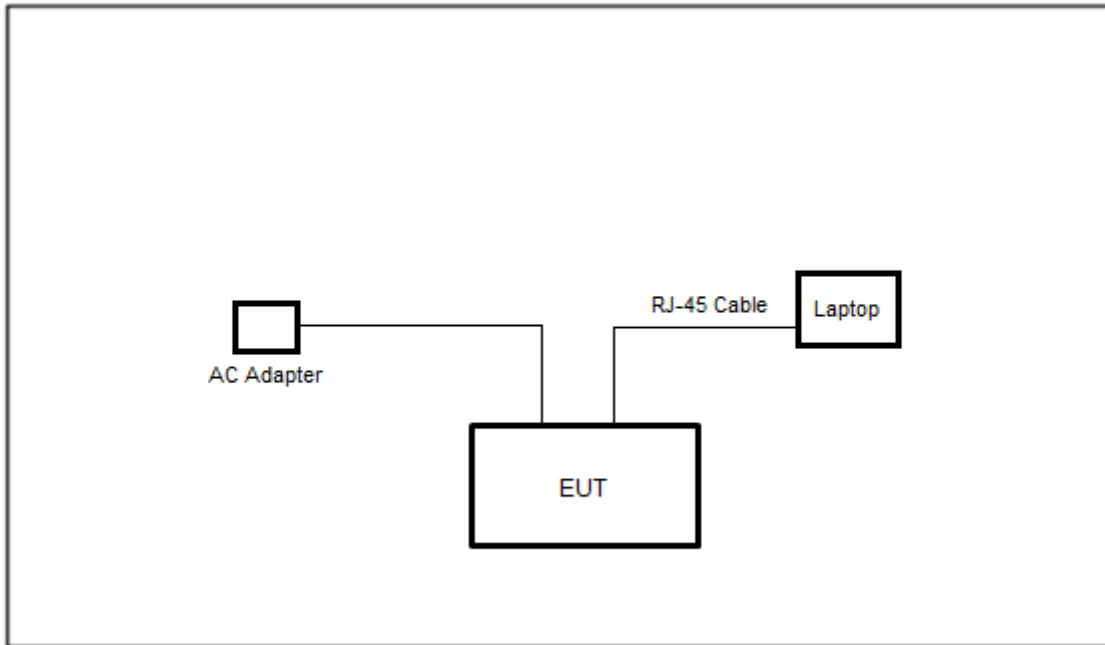

2.4 Support Unit used in test configuration and system

| Item | Equipment | Brand Name | Model Name | FCC ID | Data Cable | Power Cord |
|------|-----------------|------------|--|---------|------------|--|
| 1. | Notebook | ACER | Altos PS548-G1 | FCC DoC | N/A | AC I/P: Unshielded, 1.2m DC O/P: Shielded, 1.8m |
| 2. | Notebook | LENOVO | 80RU | FCC DoC | N/A | AC I/P: Unshielded, 1.2m DC O/P: Shielded, 1.8m |
| 3. | Notebook | MSI | MS-17F3 | FCC DoC | N/A | AC I/P: Unshielded, 1.2m DC O/P: Shielded, 1.8m |
| 4. | PC | Fractal | FD-C-DEF7A-01 (NETINTX550TR Intel X550T2BLK) | FCC DoC | N/A | AC I/P: Unshielded, 1.2m DC O/P: Shielded, 1.8m |
| 5. | USB Flash drive | SanDisk | N/A | N/A | N/A | N/A |
| 6. | AC Adaptor | Ruckus | 740-64277-001 | N/A | N/A | AC I/P: Unshielded, 1.2m |



2.5 EUT Operation Test Setup

The RF test items, utility “PuTTY Release 0.75” was installed in Notebook which was programmed in order to make the EUT get into the engineering modes to provide channel selection, power level, data rate and the application type and for continuous transmitting signals.

2.6 Measurement Results Explanation Example

For all conducted test items:

The offset level is set in the spectrum analyzer to compensate the RF cable loss and attenuator factor between EUT conducted output port and spectrum analyzer. With the offset compensation, the spectrum analyzer reading level is exactly the EUT RF output level.

Example :

The spectrum analyzer offset is derived from RF cable loss and attenuator factor.

Offset = RF cable loss + attenuator factor.

Following shows an offset computation example with cable loss 4.2 dB and 10dB attenuator.

$$\begin{aligned} \text{Offset(dB)} &= \text{RF cable loss(dB)} + \text{attenuator factor(dB)}. \\ &= 4.2 + 10 = 14.2 \text{ (dB)} \end{aligned}$$

3 Test Result

3.1 26dB & 99% Occupied Bandwidth Measurement

3.1.1 Limit of 26dB & 99% Occupied Bandwidth

<FCC 14-30 CFR 15.407>

(a)(10) The maximum transmitter channel bandwidth for U-NII devices in the 5.925-7.125 GHz band is 320 megahertz.

3.1.2 Measuring Instruments

Please refer to the measuring equipment list in this test report.

3.1.3 Test Procedures

1. The testing follows FCC KDB 789033 D02 General UNII Test Procedures New Rules v02r01. Section C) Emission bandwidth
2. Set RBW = approximately 1% of the emission bandwidth.
3. Set the VBW > RBW.
4. Detector = Peak.
5. Trace mode = max hold
6. Measure the maximum width of the emission that is 26 dB down from the peak of the emission. Compare this with the RBW setting of the analyzer. Readjust RBW and repeat measurement as needed until the RBW/EBW ratio is approximately 1%.
7. For 99% Bandwidth Measurement, the spectrum analyzer's resolution bandwidth (RBW) is set 1-5% of the emission bandwidth and set the Video bandwidth (VBW) $\geq 3 * RBW$.
8. Measure and record the results in the test report.

3.1.4 Test Setup

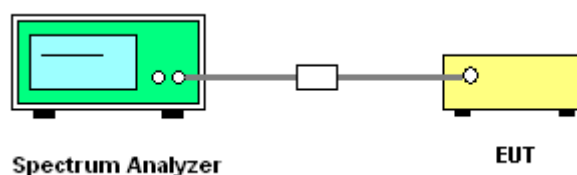

3.1.5 Test Result of 26dB & 99% Occupied Bandwidth

Please refer to Appendix A.



<802.11a 5955MHz>

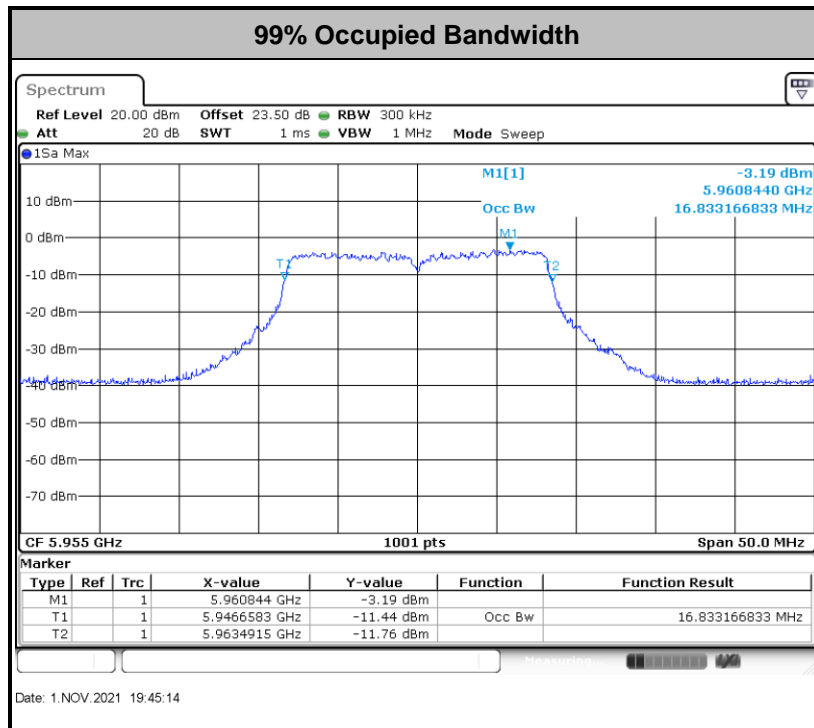
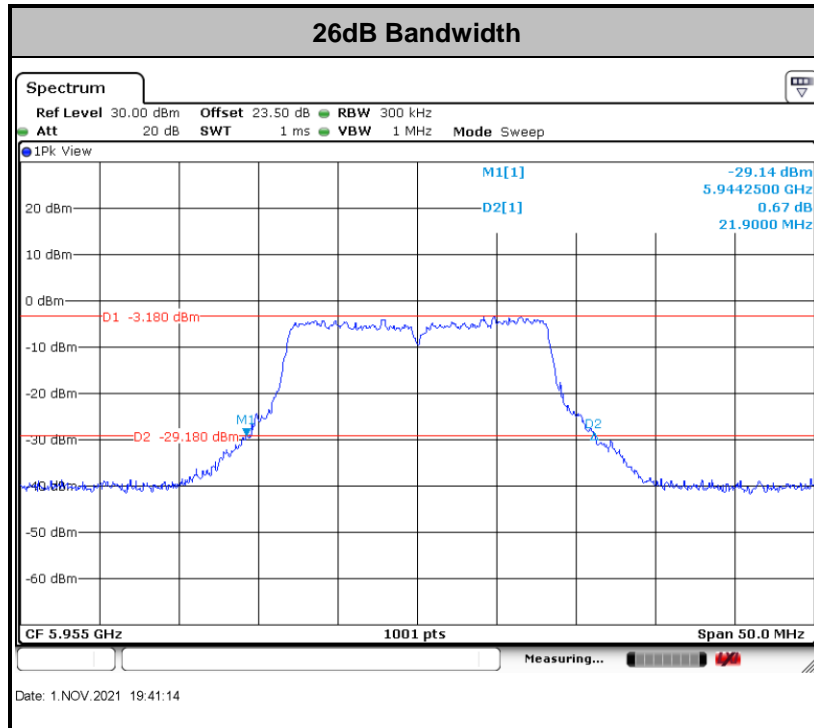

Note: The occupied channel bandwidth is maintained within the band of operation for all of the modulations.



<802.11ax HE 20 5955MHz>

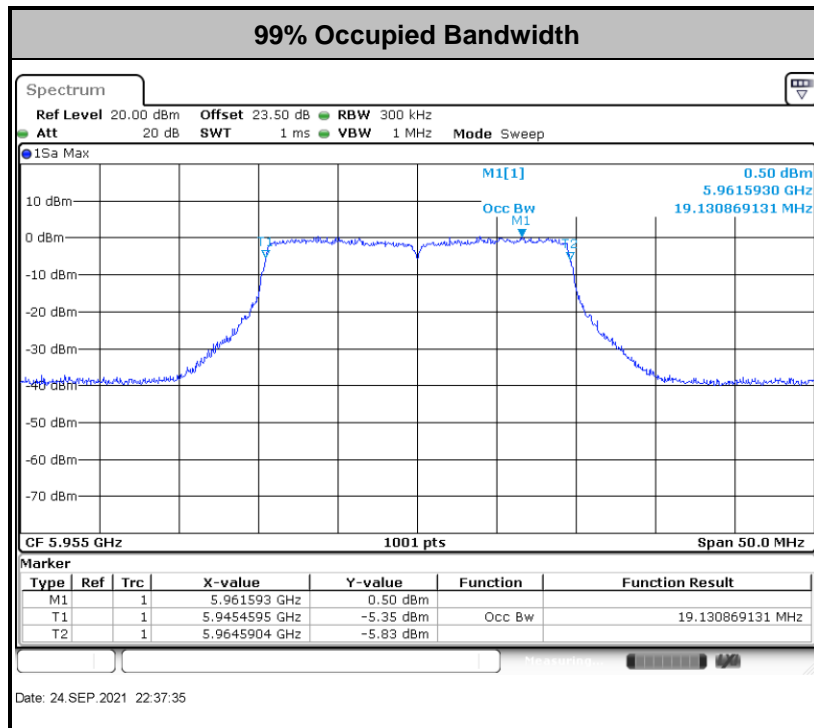
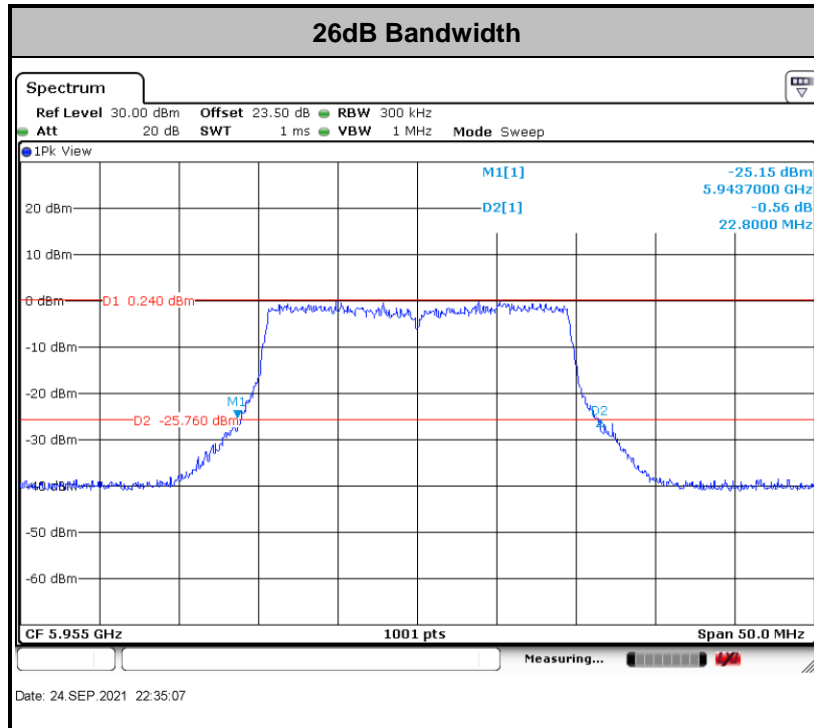

Note: The occupied channel bandwidth is maintained within the band of operation for all of the modulations.



<802.11ax HE 40 5965MHz>

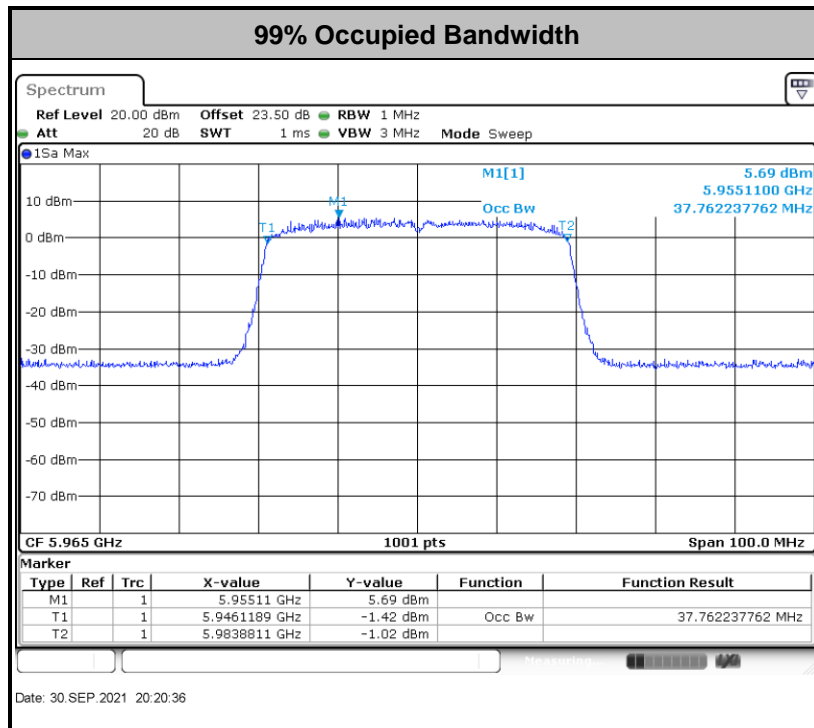
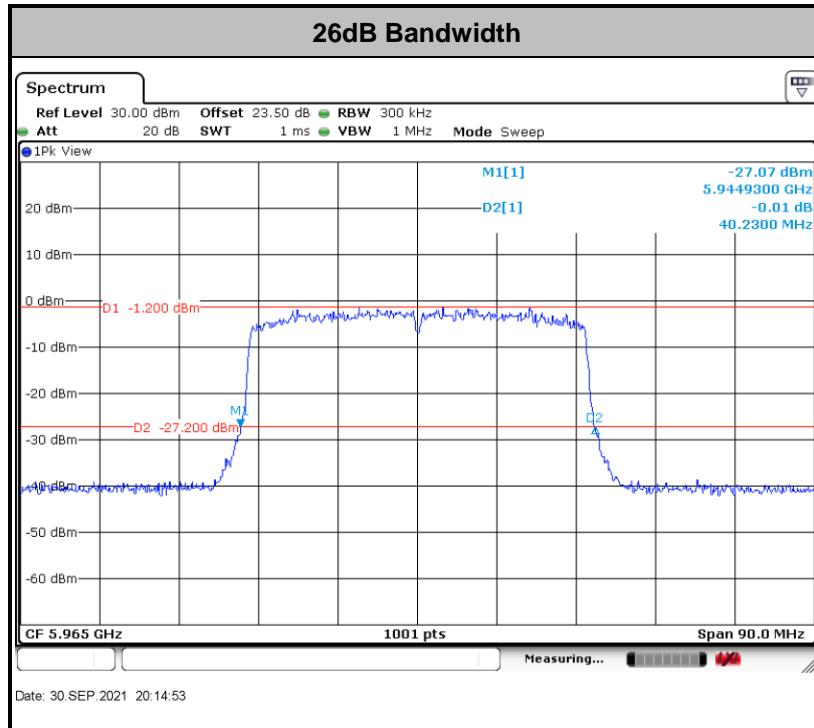

Note: The occupied channel bandwidth is maintained within the band of operation for all of the modulations.



<802.11ax HE 80 5985MHz>

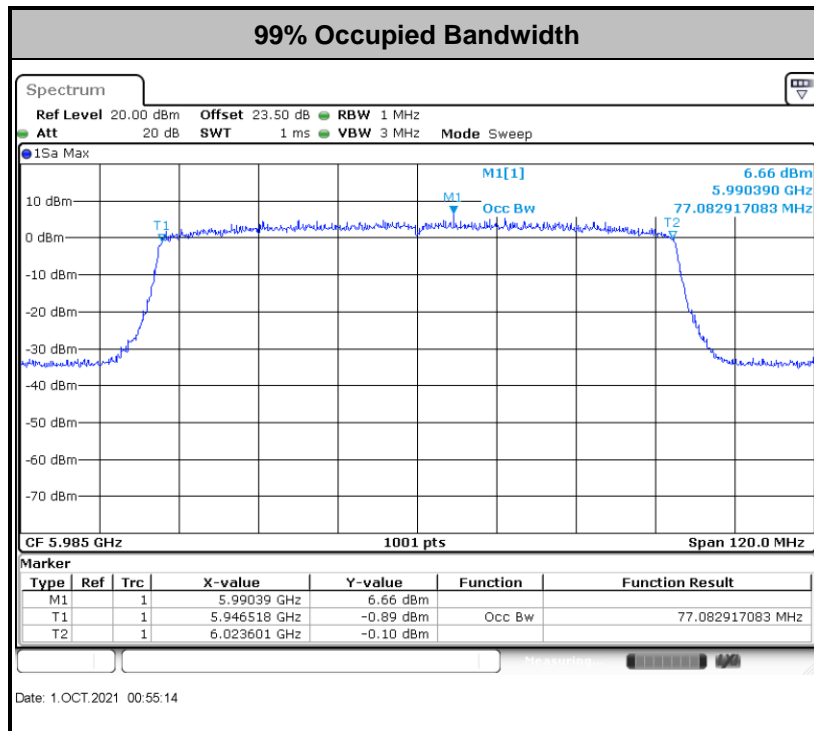
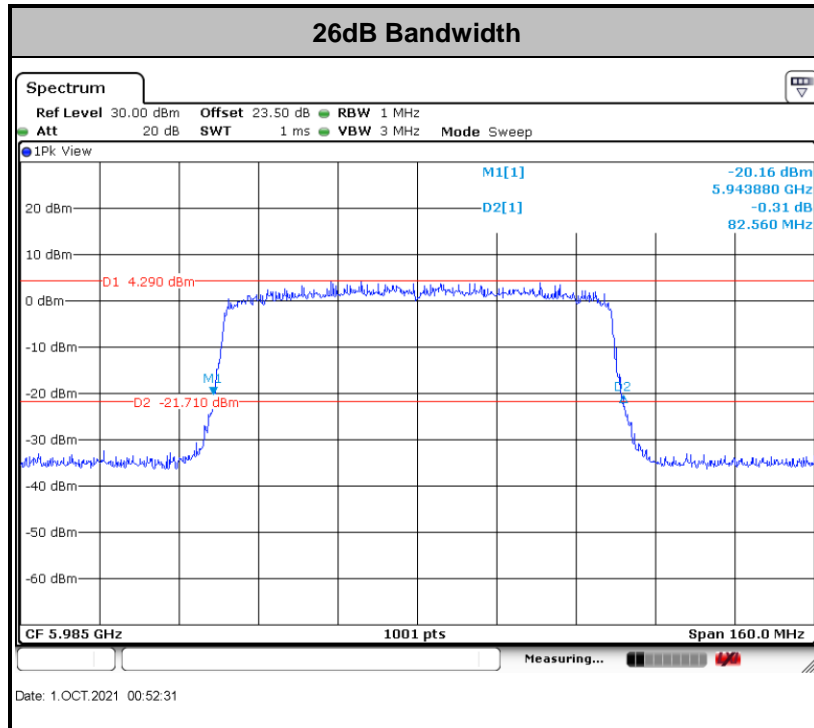

Note: The occupied channel bandwidth is maintained within the band of operation for all of the modulations.



<802.11ax HE 160 6025MHz>

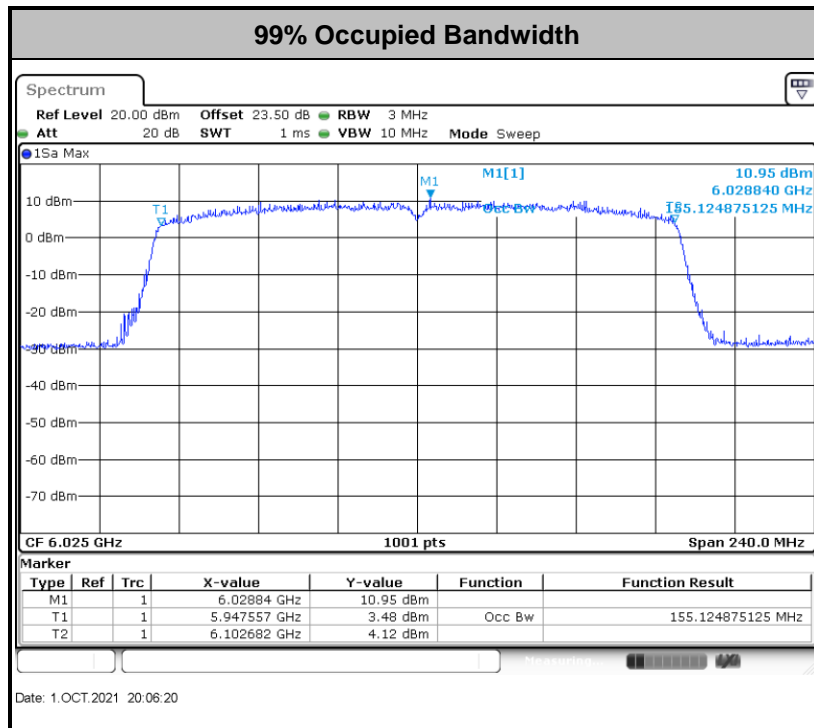
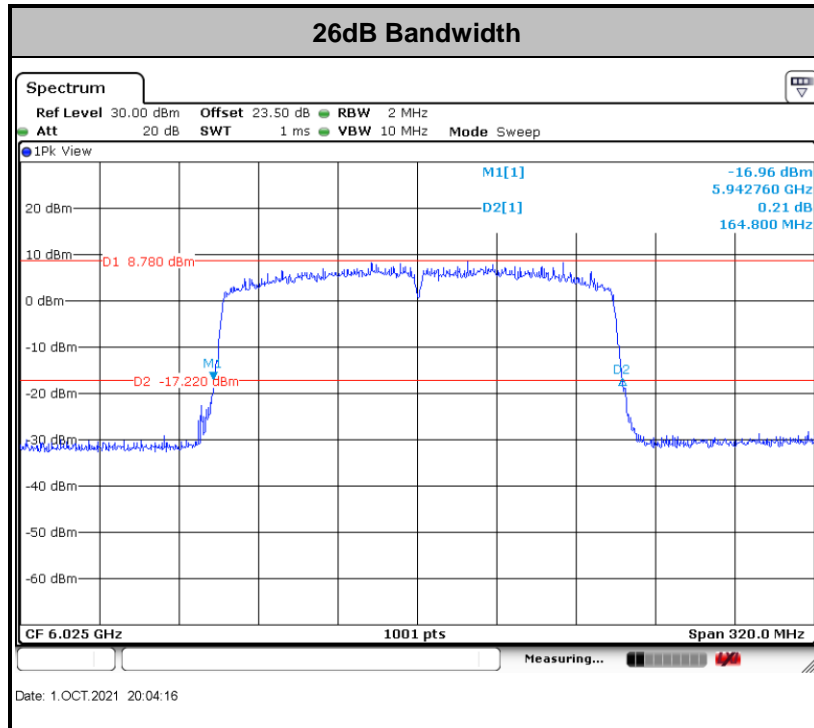

Note: The occupied channel bandwidth is maintained within the band of operation for all of the modulations.



3.2 Maximum conducted Output Power and Fundamental Maximum EIRP Measurement

3.2.1 Limit of Fundamental Maximum EIRP

<FCC 14-30 CFR 15.407>

(a)(5) For an indoor access point operating in the 5.925-7.125 GHz band, the maximum e.i.r.p. over the frequency band of operation must not exceed 30 dBm.

3.2.2 Measuring Instruments

Please refer to the measuring equipment list in this test report.

3.2.3 Test Procedures

<CDD Modes>

The testing follows Method PM-G of FCC KDB 789033 D02 General UNII Test Procedures New Rules v02r01.

Method PM-G (Measurement using a gated RF average power meter):

1. Measurement is performed using a wideband RF power meter.
2. The EUT is configured to transmit at its maximum power control level.
3. Measure the average power of the transmitter.
4. Since the measurement is made only during the ON time of the transmitter, no duty cycle correction factor is required.
5. For MIMO mode, calculation method follows FCC KDB 662911 D01 Multiple Transmitter Output v02r01.

<TXBF Modes>

The testing follows Method PM-G of FCC KDB 789033 D02 General UNII Test Procedures New Rules v02r01.

Method PM-G (Measurement using a gated RF average power meter):

1. Measurement is performed using a wideband RF power meter.
2. The EUT is configured to transmit at its maximum power control level.
3. Measure the average power of the transmitter
4. Since the measurement is made only during the ON time of the transmitter, no duty cycle correction factor is required.
5. For MIMO mode, calculation method follows FCC KDB 662911 D01 Multiple Transmitter Output v02r01.

3.2.4 Test Setup

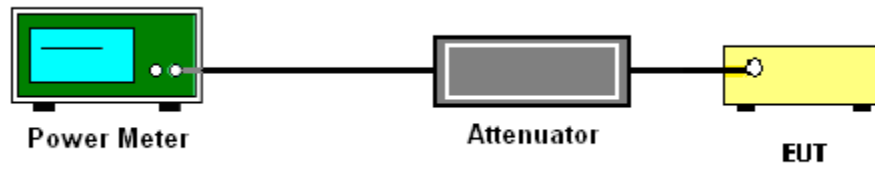

3.2.5 Test Result of Fundamental Maximum EIRP

Please refer to Appendix A.



3.3 Fundamental Power Spectral Density Measurement

3.3.1 Limit of Fundamental Power Spectral Density

<FCC 14-30 CFR 15.407>

(a)(5) For an indoor access point operating in the 5.925-7.125 GHz band, the maximum power spectral density must not exceed 5 dBm e.i.r.p. in any 1-megahertz band. In addition, the maximum e.i.r.p. over the frequency band of operation must not exceed 30 dBm.

3.3.2 Measuring Instruments

Please refer to the measuring equipment list in this test report.

3.3.3 Test Procedures

The testing follows FCC KDB 789033 D02 General UNII Test Procedures New Rules v02r01.

Section F) Maximum power spectral density.

<CDD Modes>

Method SA-2

(trace averaging across on and off times of the EUT transmissions, followed by duty cycle correction).

- Measure the duty cycle.
- Set span to encompass the entire emission bandwidth (EBW) of the signal.
- Set RBW = 1 MHz.
- Set VBW \geq 3 MHz.
- Number of points in sweep \geq 2 Span / RBW.
- Sweep time = auto.
- Detector = RMS
- Trace average at least 100 traces in power averaging mode.
- Add $10 \log(1/x)$, where x is the duty cycle, to the measured power in order to compute the average power during the actual transmission times. For example, add $10 \log(1/0.25) = 6$ dB if the duty cycle is 25 percent.

1. The RF output of EUT was connected to the spectrum analyzer by a low loss cable.
2. Each plot has already offset with cable loss, and attenuator loss. Measure the PPSD and record it.
3. For MIMO mode, calculation method follows FCC KDB 662911 D01 Multiple Transmitter Output v02r01.

Method (a): Measure and sum the spectra across the outputs.

The total final Power Spectral Density is from a device with 2 transmitter outputs. The spectrum measurements of the individual outputs are all performed with the same span and number of points; the spectrum value in the first spectral bin of output 1 is summed with that in the first spectral bin of output 2 to obtain the value for the first frequency bin of the summed spectrum.

3.3.4 Test Setup

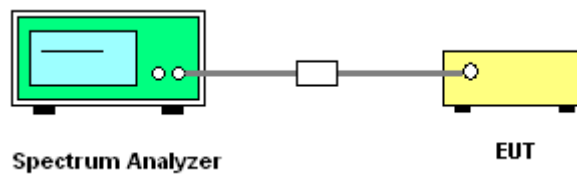

3.3.5 Test Result of Power Spectral Density

Please refer to Appendix A.



<802.11a Mode>

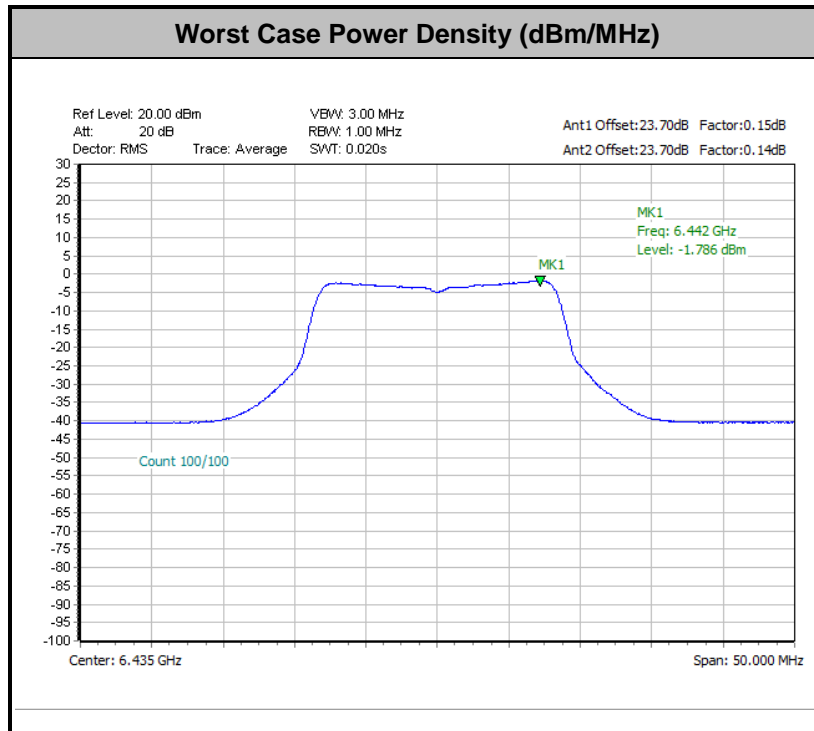

Remark: The test plot is showing a bin by bin combined result mathematically adds two traces.

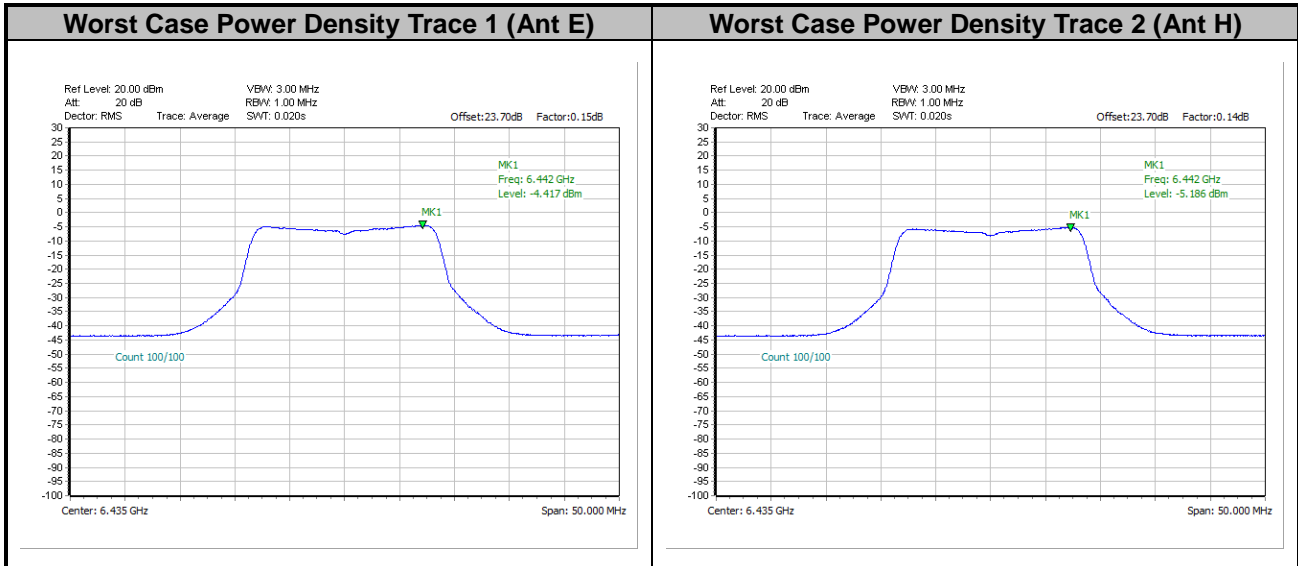



<802.11ax HE20 Modes>

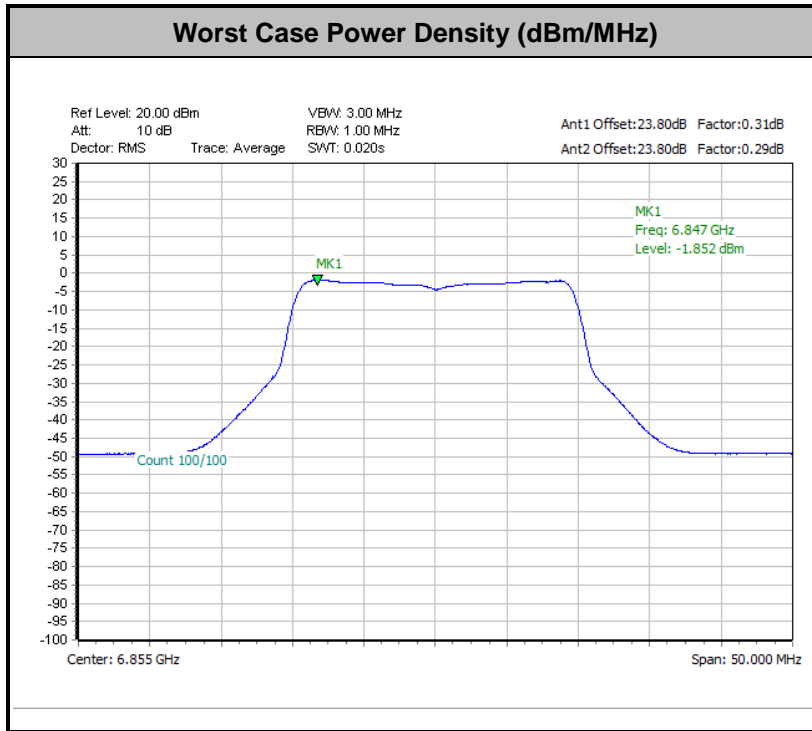

Remark: The test plot is showing a bin by bin combined result mathematically adds two traces.

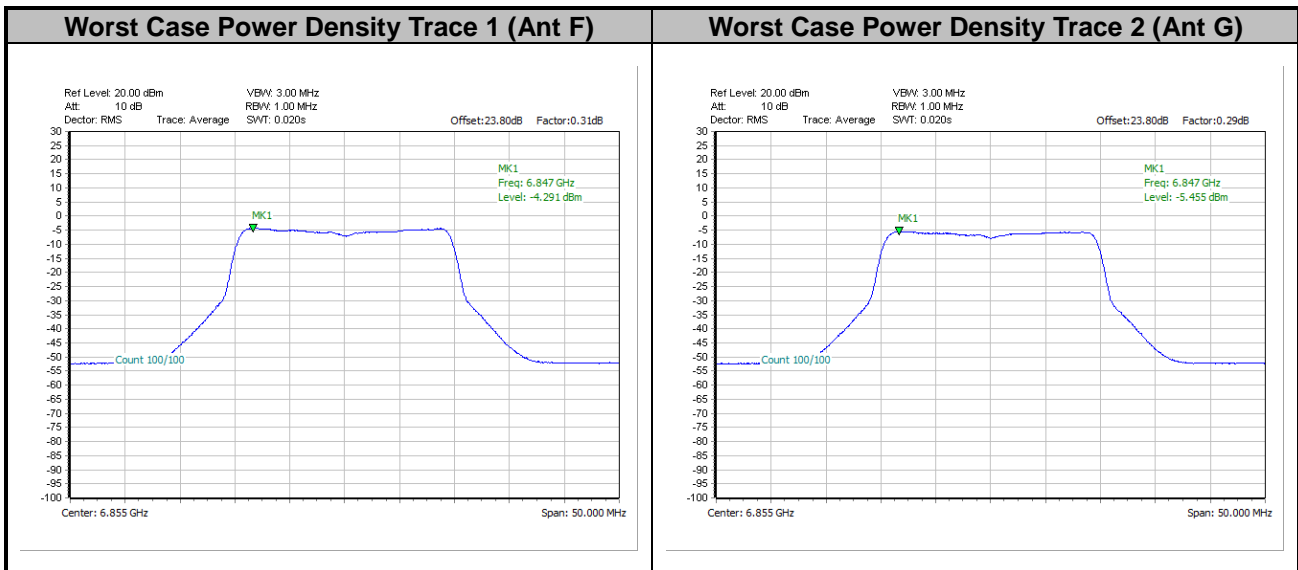



<802.11ax HE40 Modes>

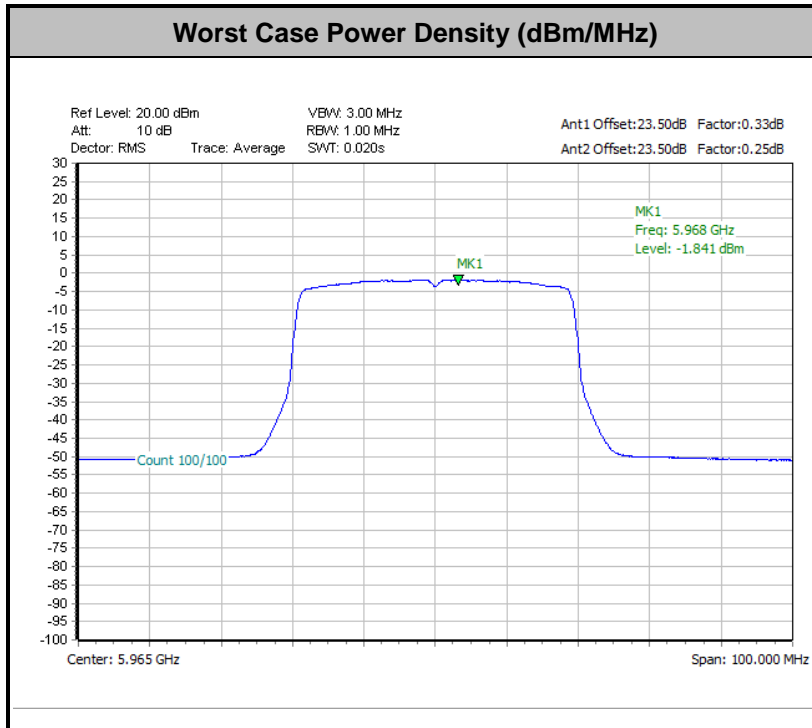

Remark: The test plot is showing a bin by bin combined result mathematically adds two traces.

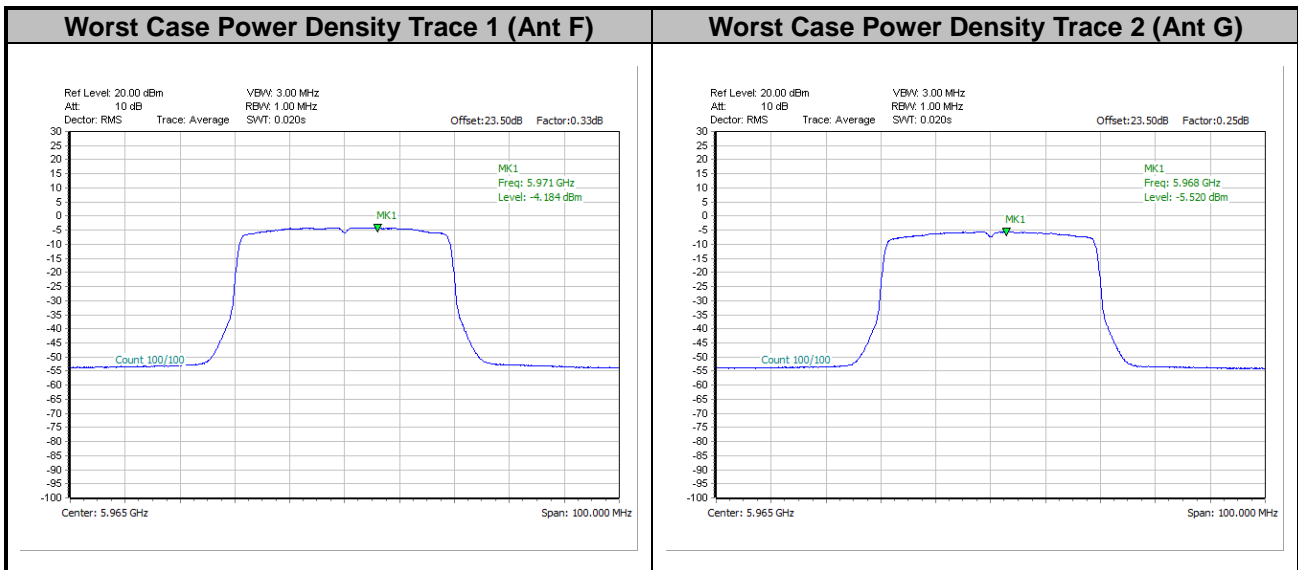



<802.11ax HE80 Modes>

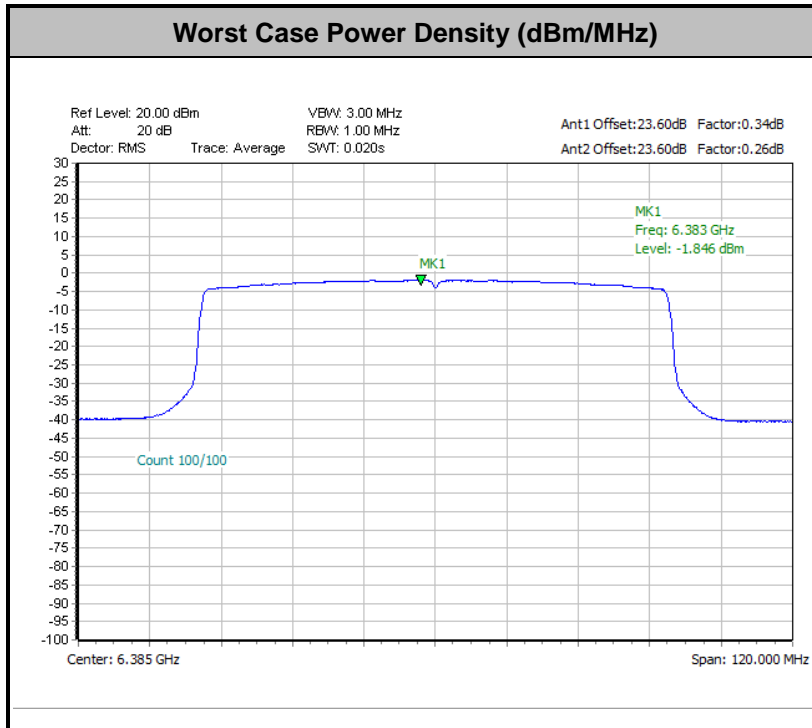

Remark: The test plot is showing a bin by bin combined result mathematically adds two traces.

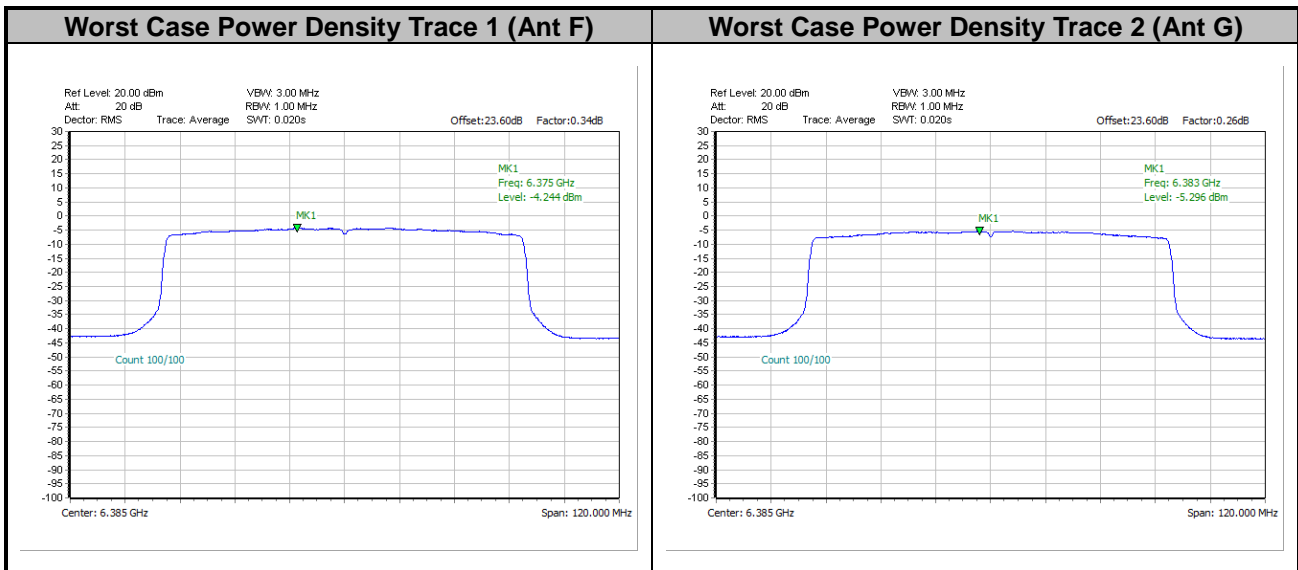



<802.11ax HE160 Modes>

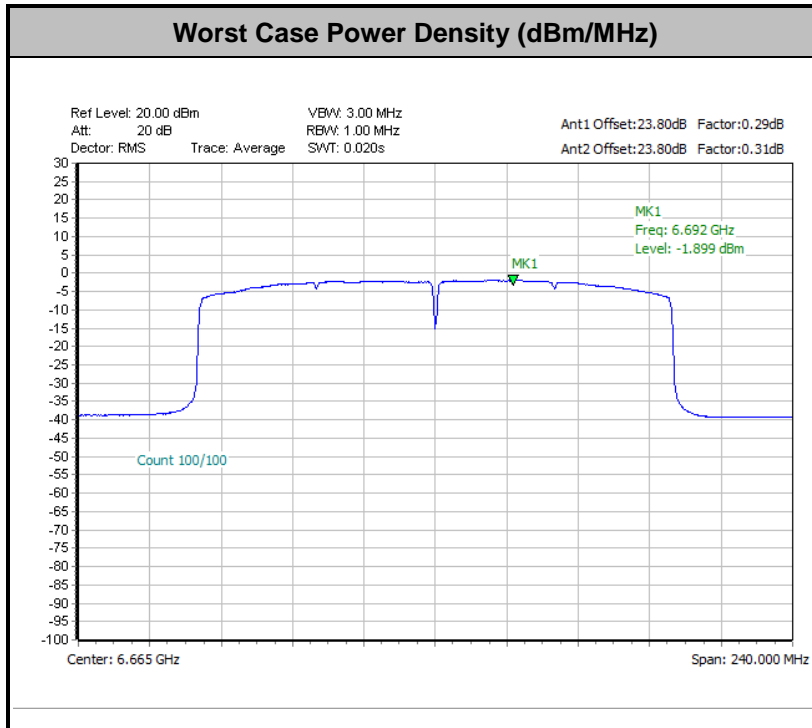

Remark: The test plot is showing a bin by bin combined result mathematically adds two traces.

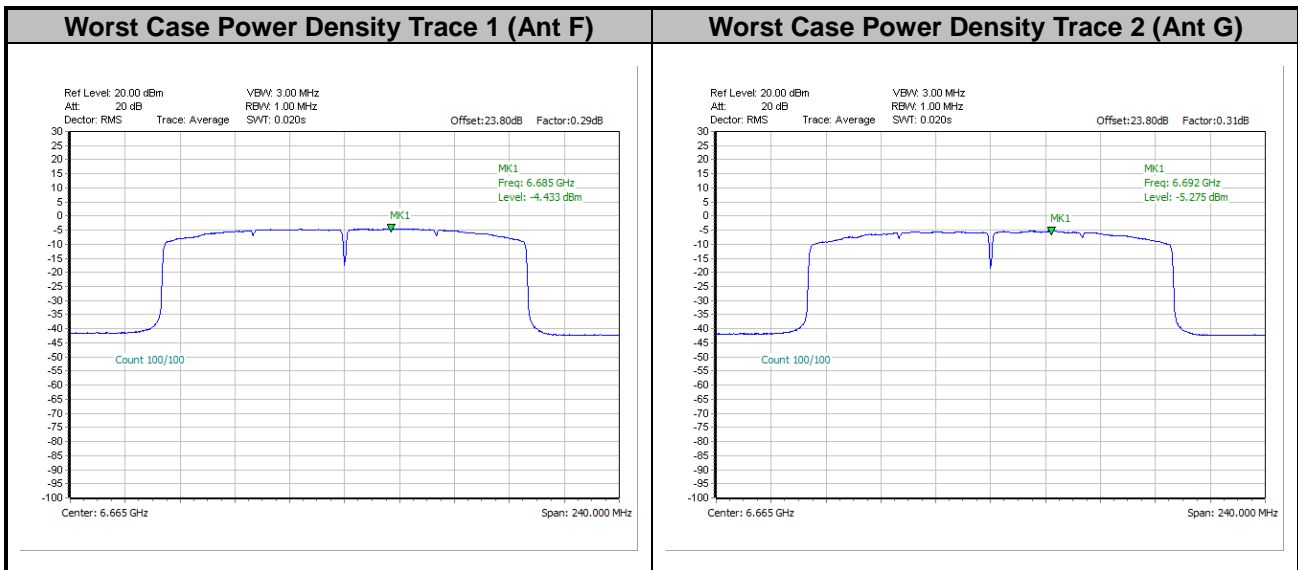



3.4 In-Band Emissions (Channel Mask)

3.4.1 Limit of Unwanted Emissions

<FCC 14-30 CFR 15.407>

(a)(6) For transmitters operating within the 5.925-7.125 GHz bands: Power spectral density must be suppressed by 20 dB at 1 MHz outside of channel edge, by 28 dB at one channel bandwidth from the channel center, and by 40 dB at one- and one-half times the channel bandwidth away from channel center. At frequencies between one megahertz outside an unlicensed device's channel edge and one channel bandwidth from the center of the channel, the limits must be linearly interpolated between 20 dB and 28 dB suppression, and at frequencies between one and one- and one-half times an unlicensed device's channel bandwidth, the limits must be linearly interpolated between 28 dB and 40 dB suppression. Emissions removed from the channel center by more than one- and one-half times the channel bandwidth must be suppressed by at least 40 dB.

3.4.2 Measuring Instruments

Please refer to the measuring equipment list in this test report.

3.4.3 Test Procedures

The testing follows FCC KDB 987594 D02 U-NII 6GHz EMC Measurement v01.

Section J) In-Band Emissions.

1. Take nominal bandwidth as reference channel bandwidth provided that 26 dB emission bandwidth is always larger than nominal bandwidth
2. Measure the power spectral density (which will be used for emissions mask reference) using the following procedure:
 - a) Set the span to encompass the entire 26 dB EBW of the signal.
 - b) Set RBW = same RBW used for 26 dB EBW measurement.
 - c) Set VBW $\geq 3 \times$ RBW
 - d) Number of points in sweep $\geq [2 \times \text{span} / \text{RBW}]$.
 - e) Sweep time = auto.
 - f) Detector = RMS (i.e., power averaging)
 - g) Trace average at least 100 traces in power averaging (rms) mode.
 - h) Use the peak search function on the instrument to find the peak of the spectrum.
3. Using the measuring equipment limit line function, develop the emissions mask based on the following requirements. The emissions power spectral density must be reduced below the peak power spectral density (in dB) as follows:
 - a. Suppressed by 20 dB at 1 MHz outside of the channel edge.
 - b. Suppressed by 28 dB at one channel bandwidth from the channel center.
 - c. Suppressed by 40 dB at one- and one-half times the channel bandwidth from the channel center.

4. Adjust the span to encompass the entire mask as necessary.
5. Clear trace.
6. Trace average at least 100 traces in power averaging (rms) mode.
7. Adjust the reference level as necessary so that the crest of the channel touches the top of the emission mask.

3.4.4 Test Setup

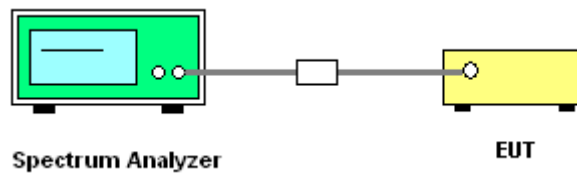



3.4.5 Test Result

MIMO <Ant. E+H(E)>

EUT Mode : 802.11a

Plot on Channel 5955MHz

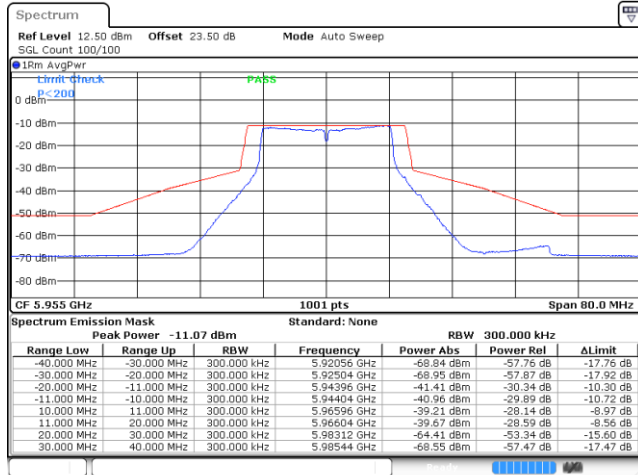

Date: 1.NOV.2021 19:45:44

Plot on Channel 6175MHz

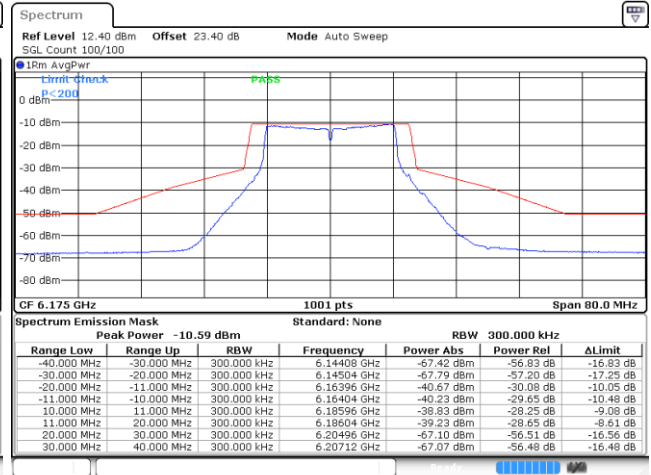

Date: 1.NOV.2021 20:00:42

Plot on Channel 6415MHz

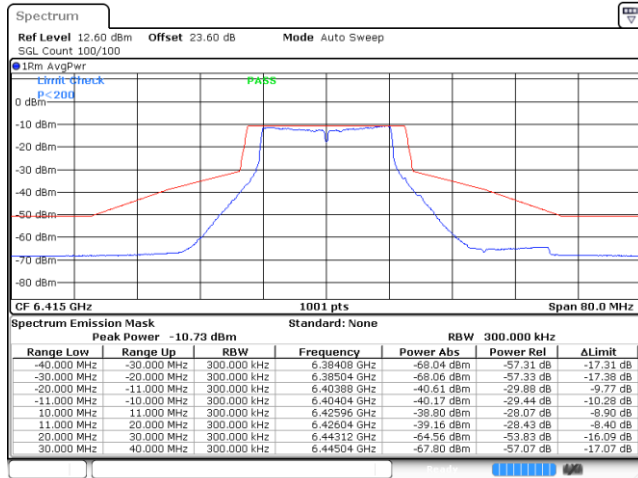

Date: 1.NOV.2021 21:52:06

Plot on Channel 6435MHz

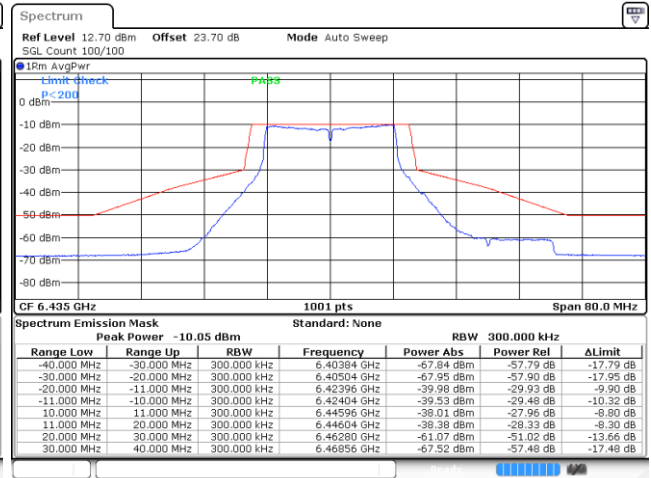

Date: 2.NOV.2021 23:14:02



Plot on Channel 6475MHz

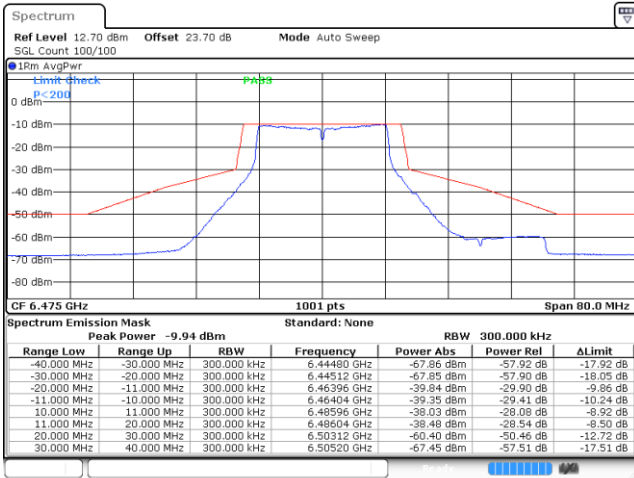

Date: 9 NOV. 2021 22:42:08

Plot on Channel 6515MHz

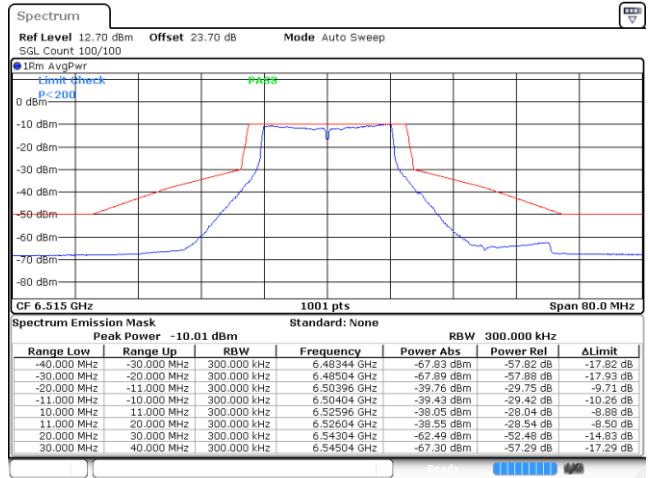

Date: 9 NOV. 2021 23:03:28

Plot on Channel 6535MHz

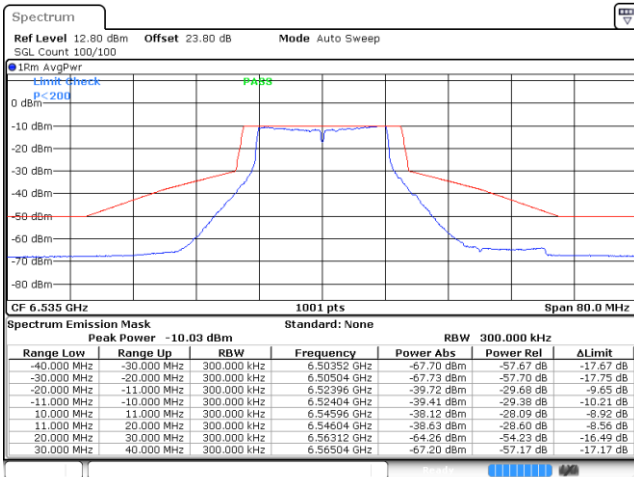

Date: 9 NOV. 2021 23:35:50

Plot on Channel 6695MHz

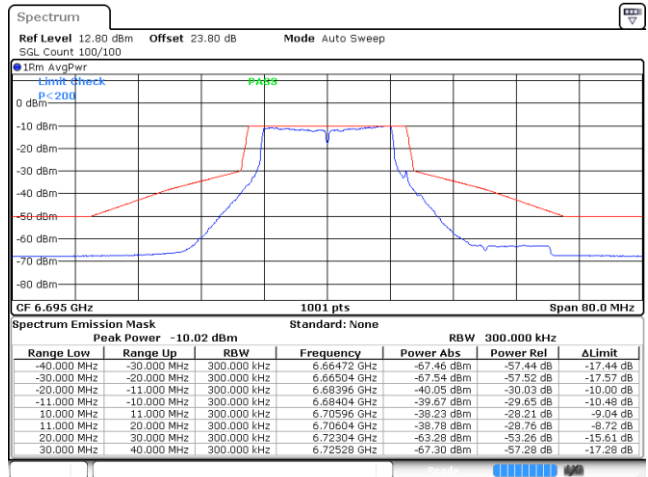

Date: 10 NOV. 2021 00:01:06



Plot on Channel 6855MHz

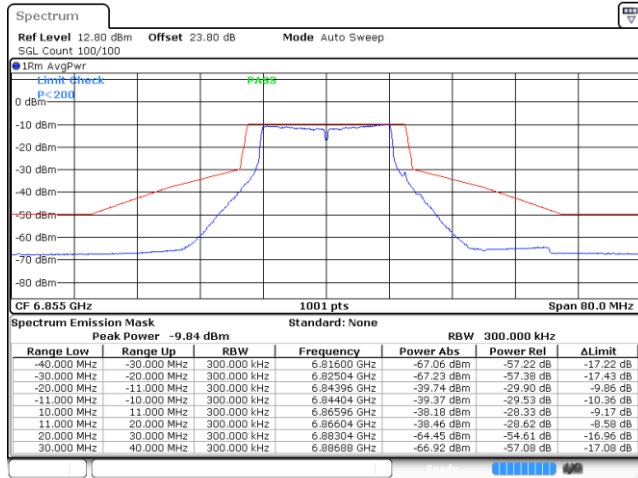

Date: 10 NOV 2021 00:16:48

Plot on Channel 6875MHz

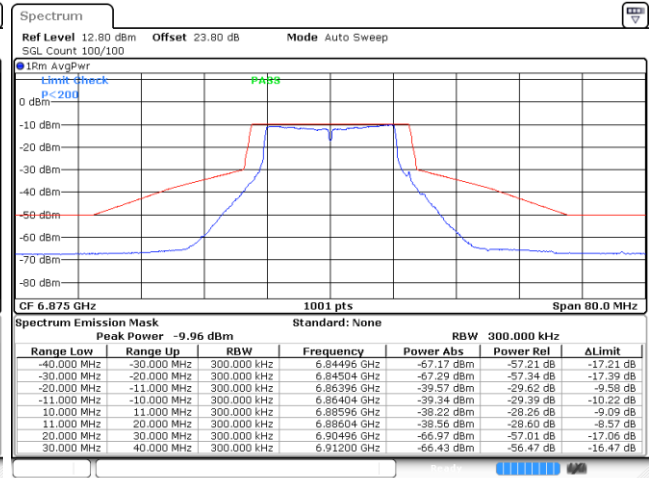

Date: 10 NOV 2021 00:49:08

Plot on Channel 6895MHz

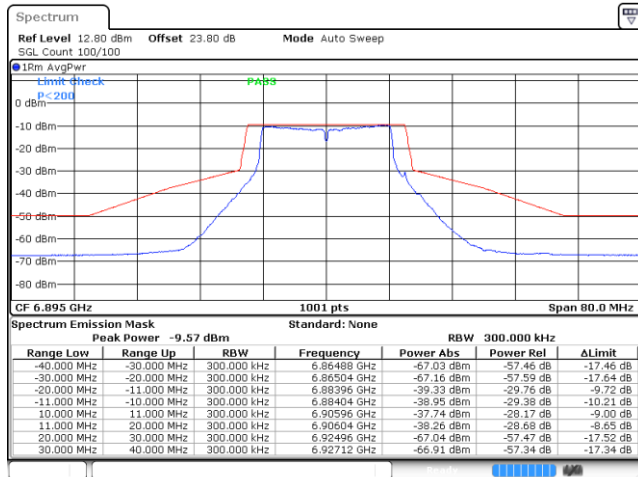

Date: 10 NOV 2021 01:11:13

Plot on Channel 6995MHz

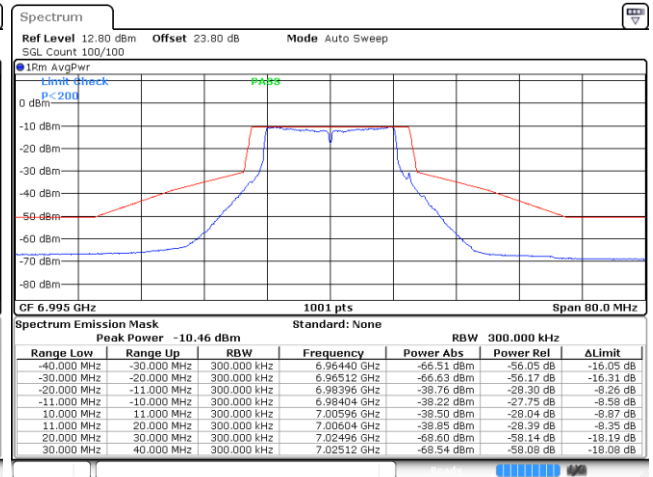

Date: 10 NOV 2021 01:28:49

Plot on Channel 7095MHz

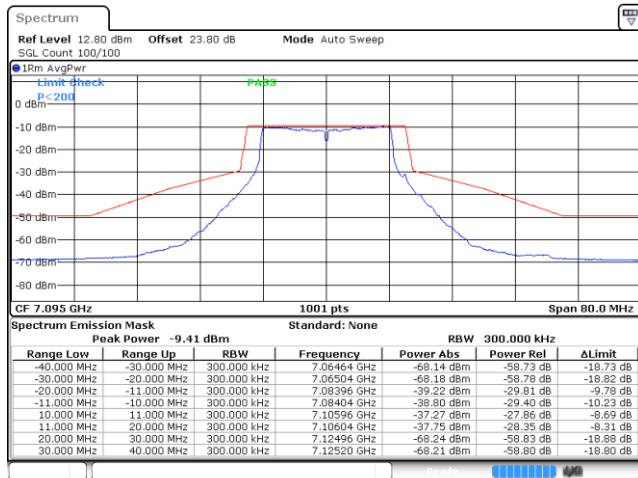

Date: 23 NOV 2021 19:25:58



EUT Mode : 802.11ax HE20

Plot on Channel 5955MHz

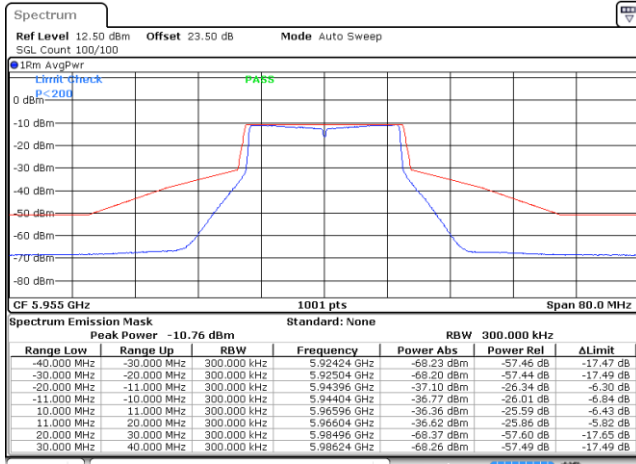

Date: 24 SEP. 2021 22:38:14

Plot on Channel 6175MHz

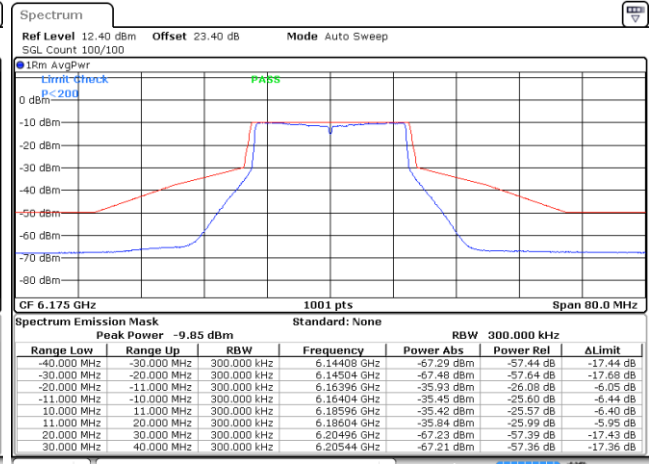

Date: 24 SEP. 2021 22:57:46

Plot on Channel 6415MHz

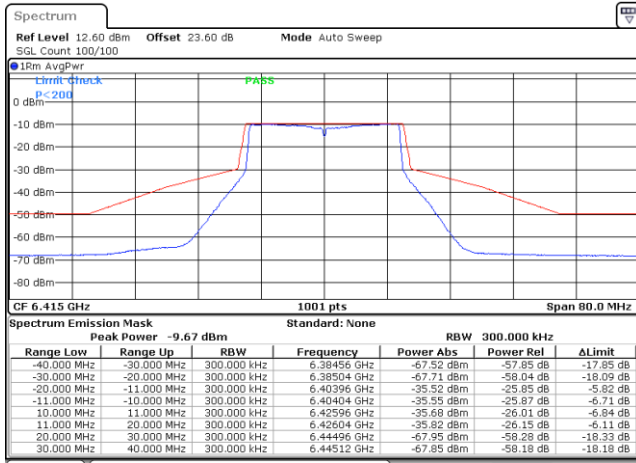

Date: 24 SEP. 2021 23:23:59

Plot on Channel 6435MHz

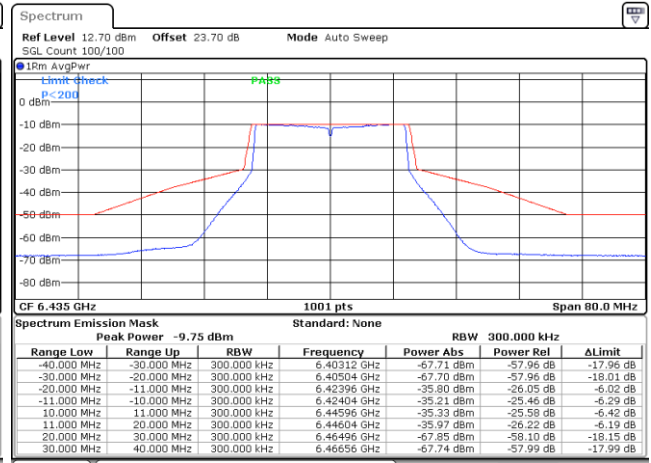

Date: 24 SEP. 2021 23:48:22



Plot on Channel 6475MHz

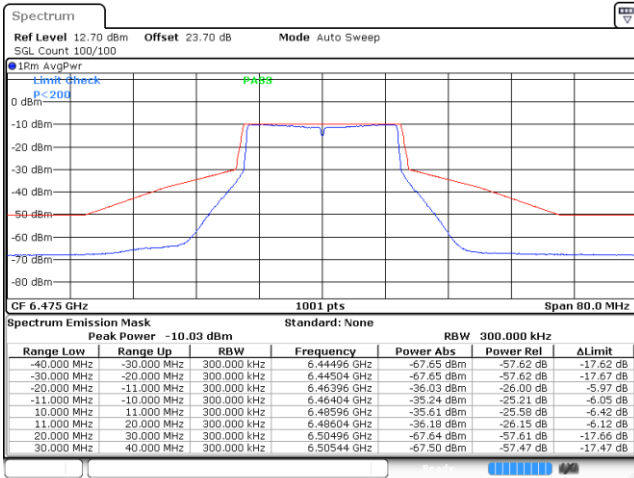

Date: 25 SEP. 2021 00:17:11

Plot on Channel 6515MHz

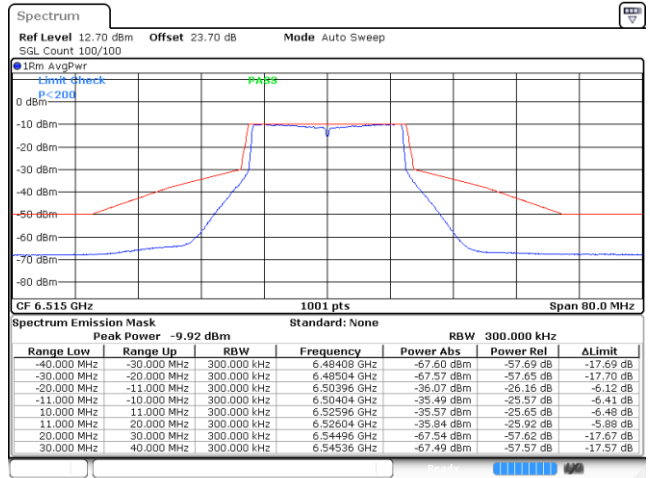

Date: 25 SEP. 2021 00:46:21

Plot on Channel 6535MHz

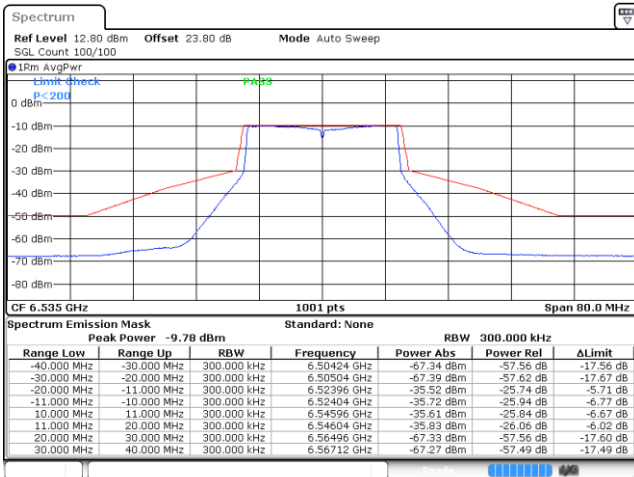

Date: 25 SEP. 2021 01:21:07

Plot on Channel 6695MHz

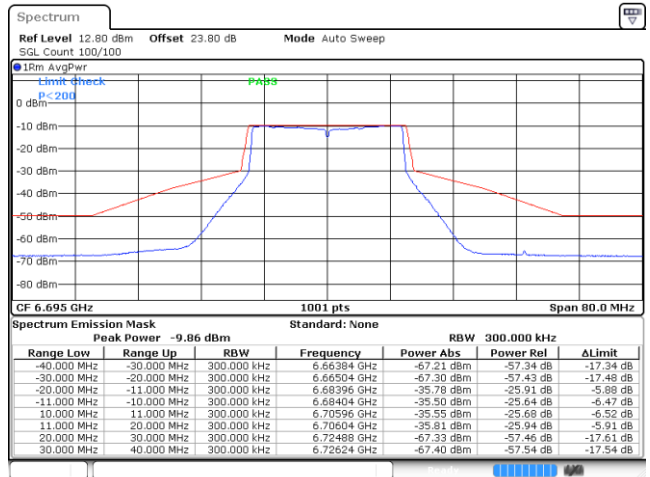

Date: 25 SEP. 2021 01:41:09



Plot on Channel 6855MHz

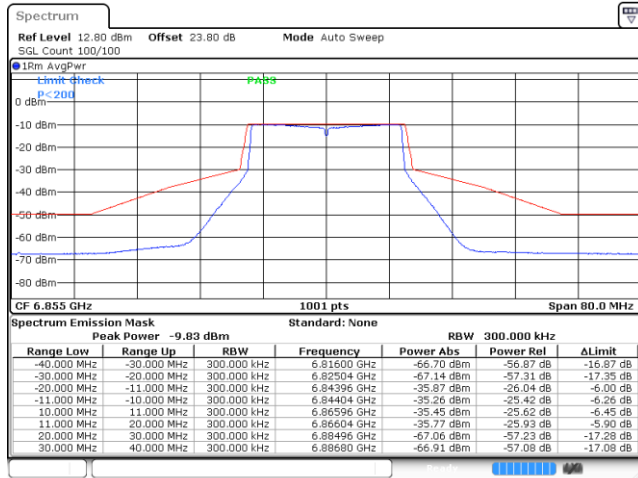

Date: 25.SEP.2021 01:55:43

Plot on Channel 6875MHz

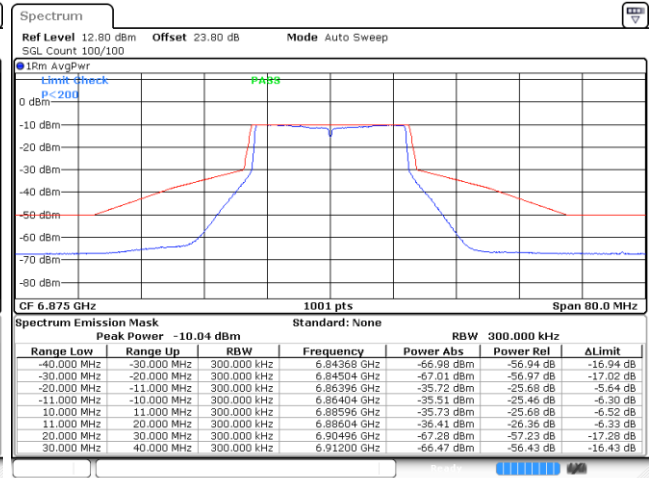

Date: 25.SEP.2021 02:15:08

Plot on Channel 6895MHz

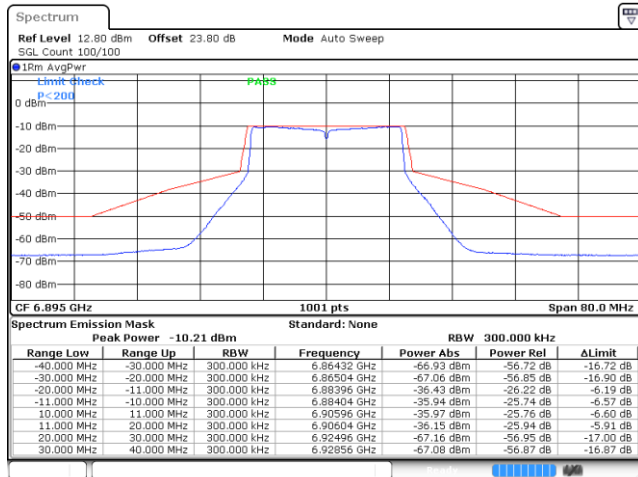

Date: 27.SEP.2021 18:38:25

Plot on Channel 6995MHz

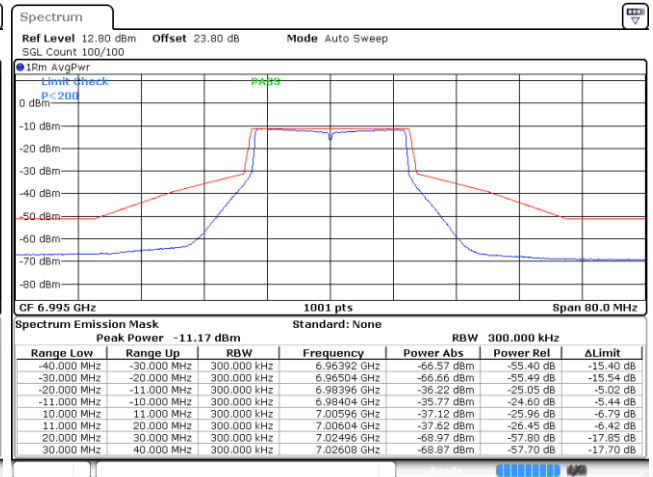

Date: 30.SEP.2021 19:08:26

Plot on Channel 7095MHz

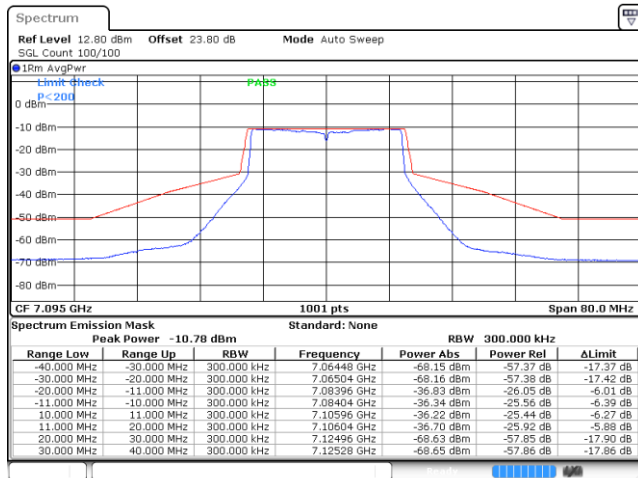

Date: 30.SEP.2021 19:29:30



EUT Mode : 802.11ax HE40

Plot on Channel 5965MHz

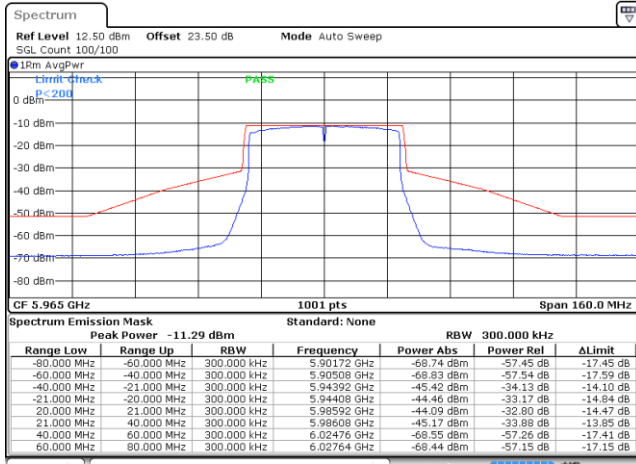

Date: 30 SEP.2021 20:21:20

Plot on Channel 6165MHz

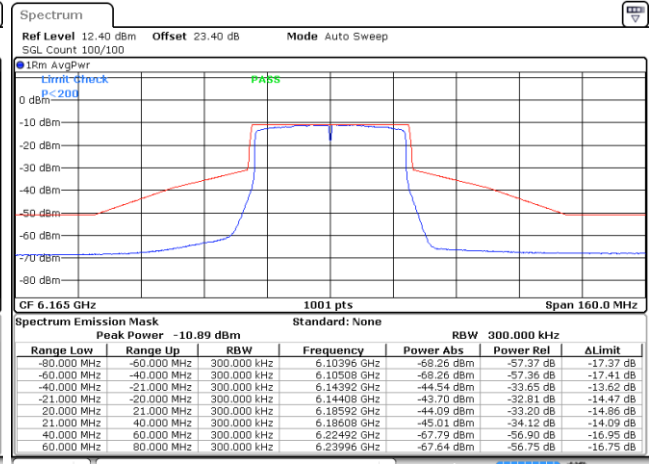

Date: 30 SEP.2021 20:37:05

Plot on Channel 6405MHz

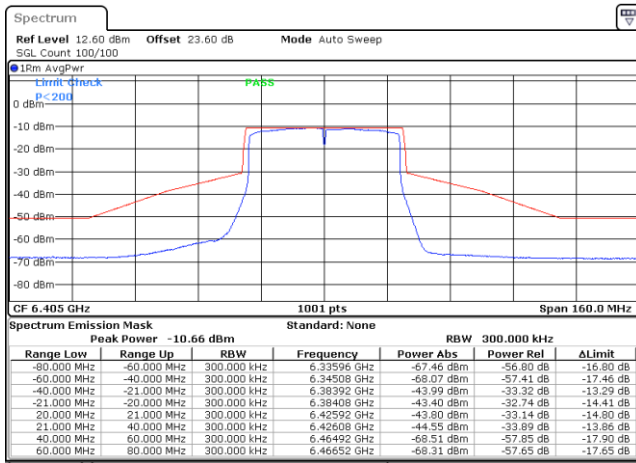

Date: 30 SEP.2021 20:52:28

Plot on Channel 6445MHz

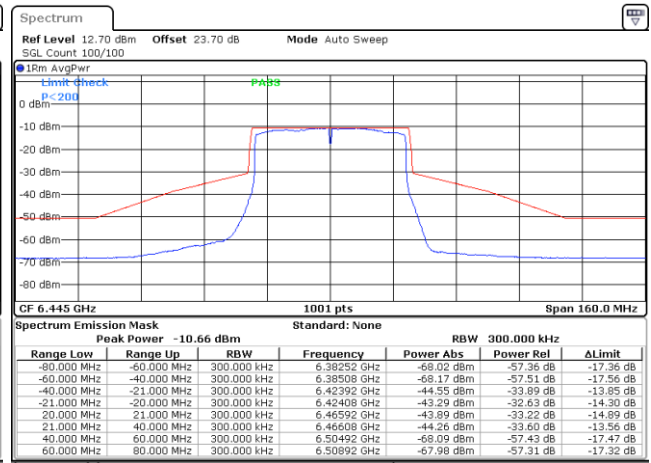

Date: 30 SEP.2021 22:26:52



Plot on Channel 6485MHz

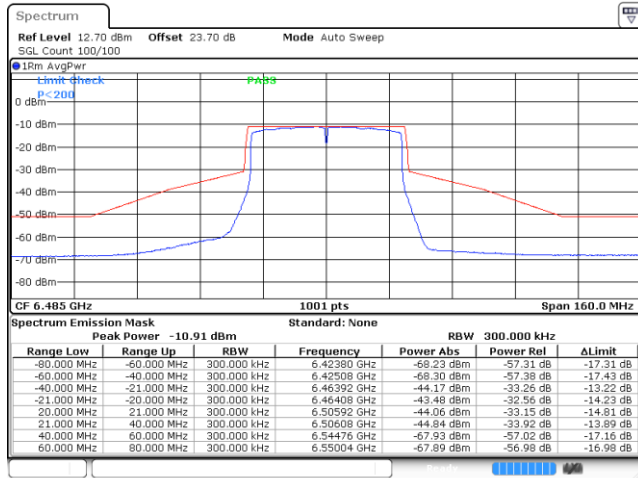

Date: 30 SEP.2021 22:40:36

Plot on Channel 6525MHz

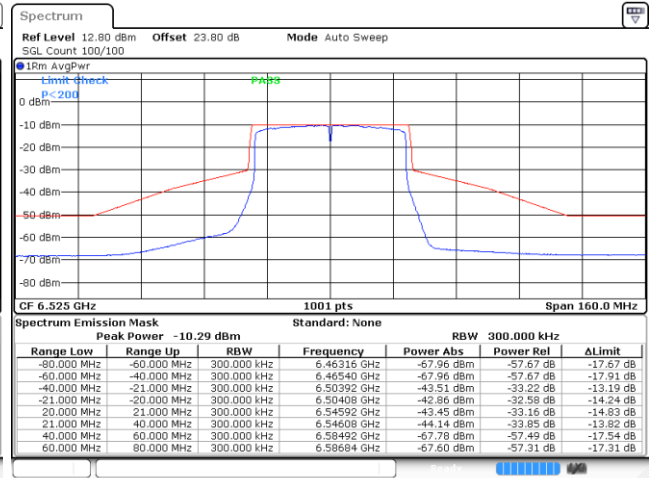

Date: 30 SEP.2021 22:54:26

Plot on Channel 6565MHz

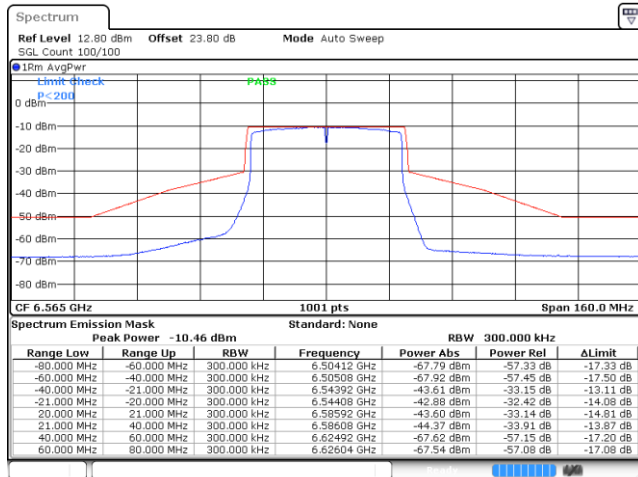

Date: 30 SEP.2021 23:08:25

Plot on Channel 6685MHz

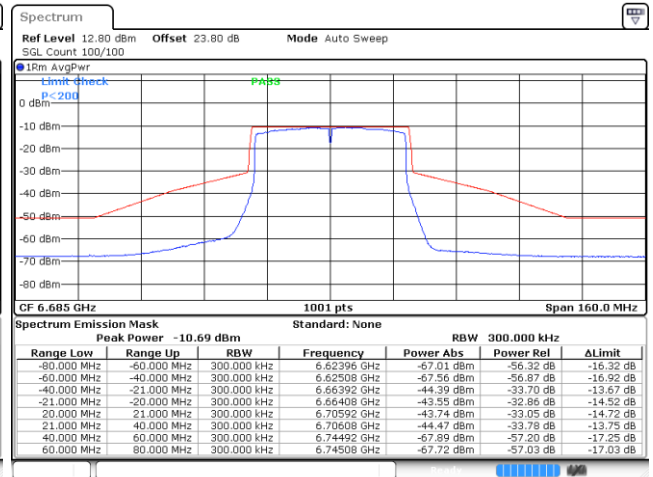

Date: 30 SEP.2021 23:23:42



Plot on Channel 6845MHz

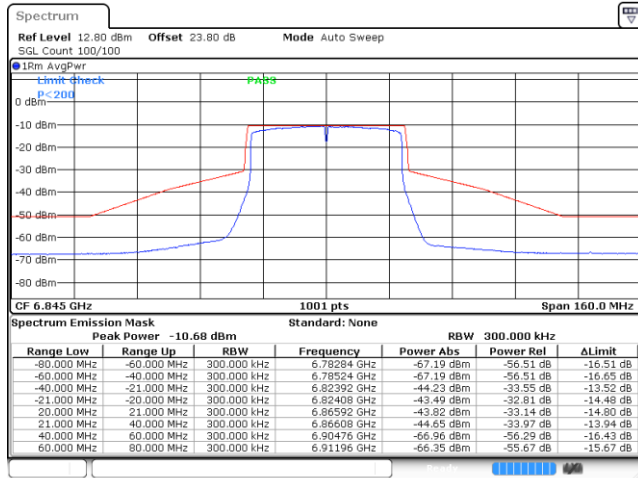

Date: 30 SEP.2021 23:39:19

Plot on Channel 6885MHz

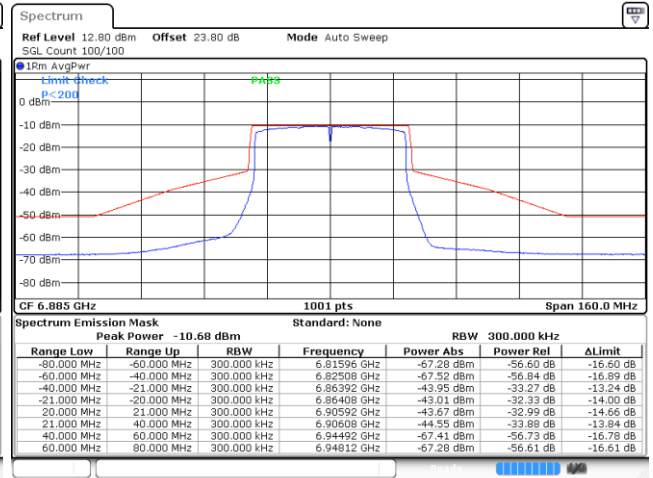

Date: 30 SEP.2021 23:55:18

Plot on Channel 6925MHz

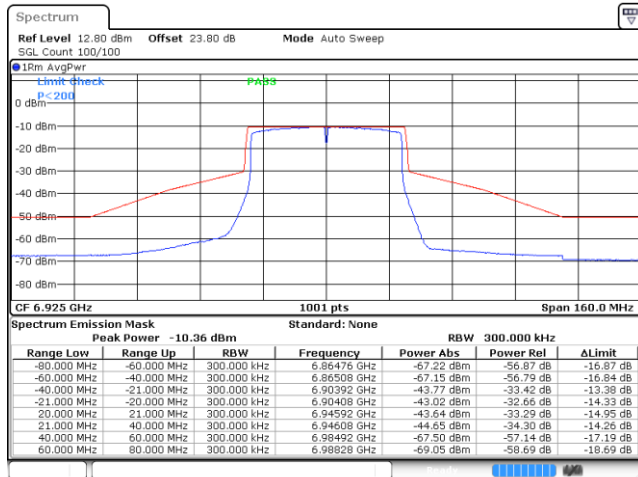

Date: 1.OCT.2021 00:10:10

Plot on Channel 7005MHz

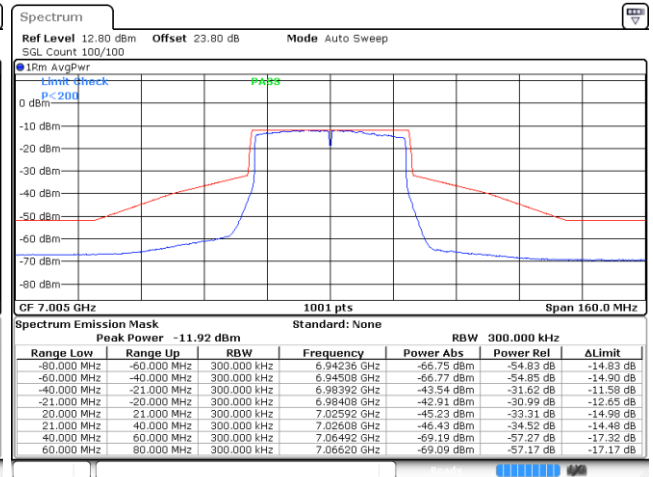

Date: 1.OCT.2021 00:25:32

Plot on Channel 7085MHz

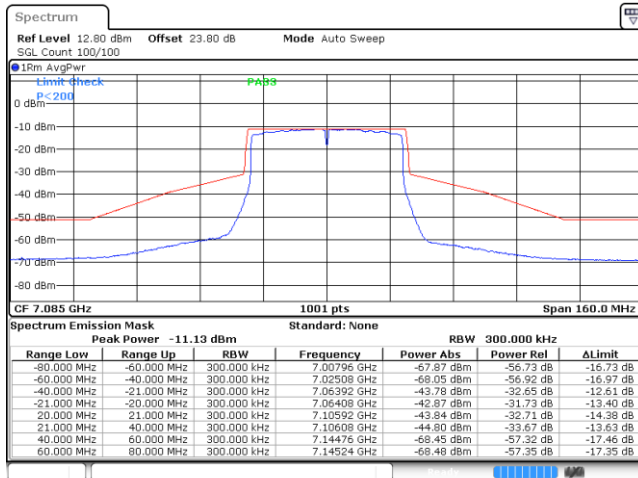

Date: 1.OCT.2021 00:39:09



EUT Mode : 802.11ax HE80

Plot on Channel 5985MHz

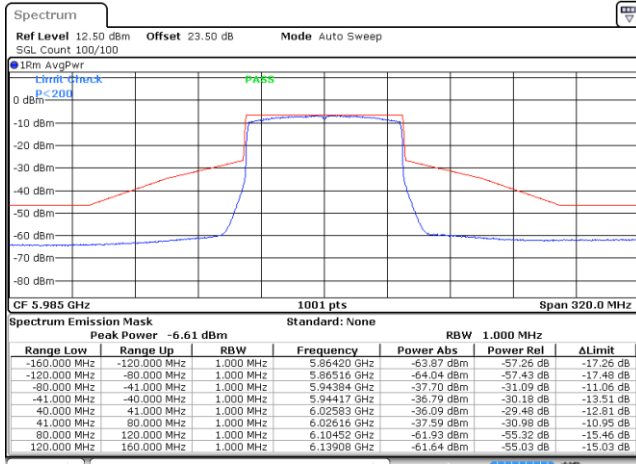

Date: 1.OCT.2021 00:55:44

Plot on Channel 6145MHz

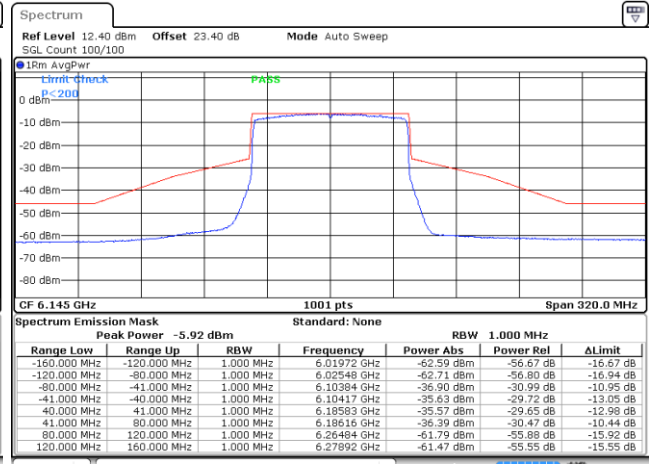

Date: 1.OCT.2021 01:08:46

Plot on Channel 6385MHz

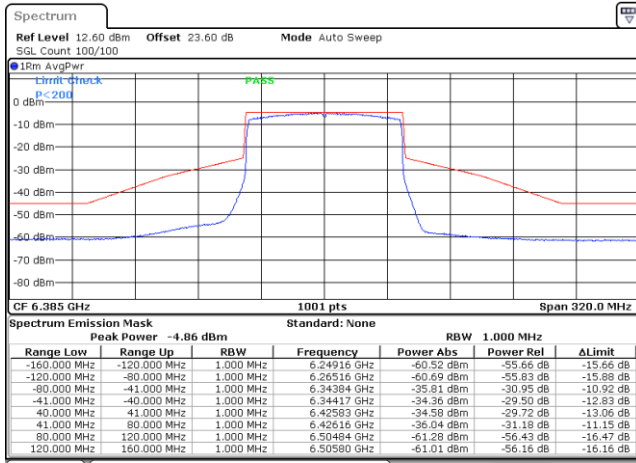

Date: 1.OCT.2021 01:23:18

Plot on Channel 6465MHz

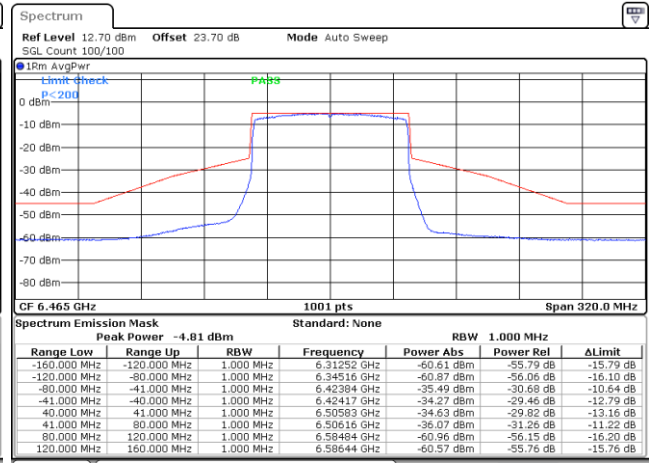

Date: 1.OCT.2021 01:38:59



Plot on Channel 6545MHz

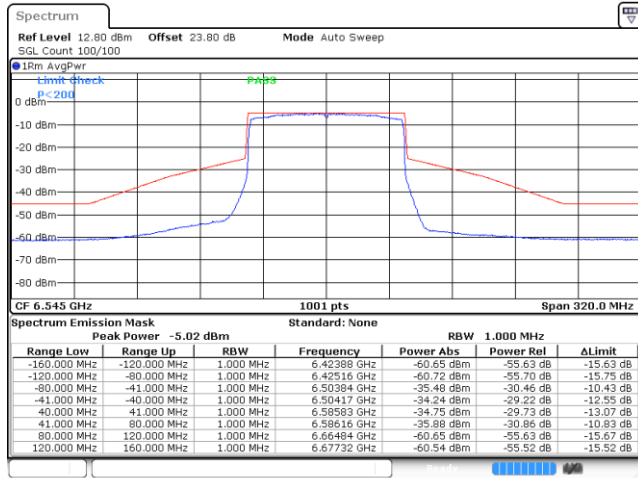

Date: 1.OCT.2021 01:55:15

Plot on Channel 6625MHz

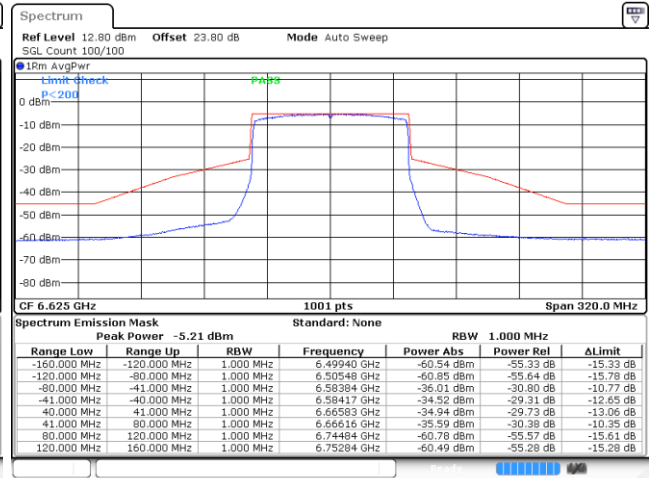

Date: 1.OCT.2021 02:09:49

Plot on Channel 6705MHz

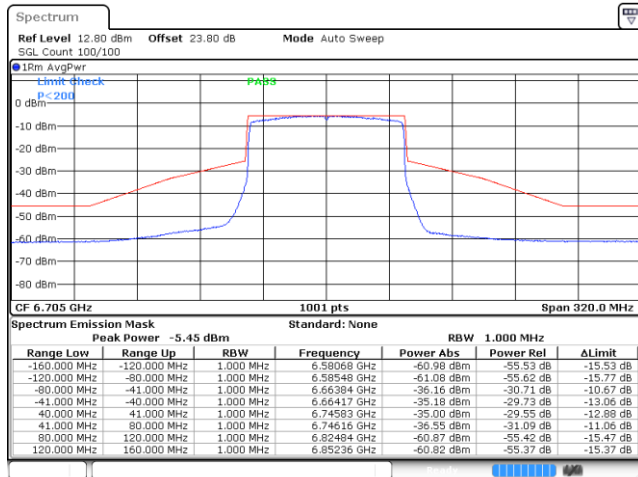

Date: 1.OCT.2021 18:41:28

Plot on Channel 6785MHz

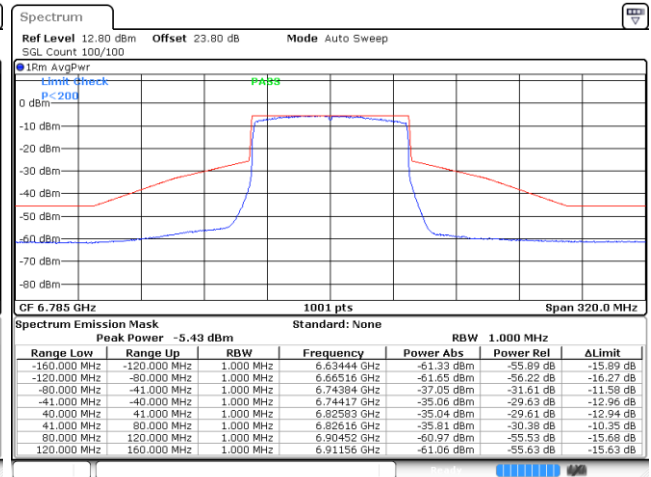

Date: 1.OCT.2021 18:57:52



Plot on Channel 6865MHz

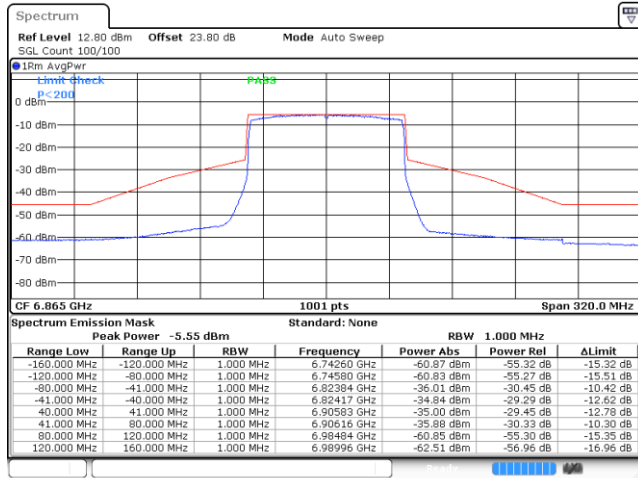

Date: 1.OCT.2021 19:14:29

Plot on Channel 6945MHz

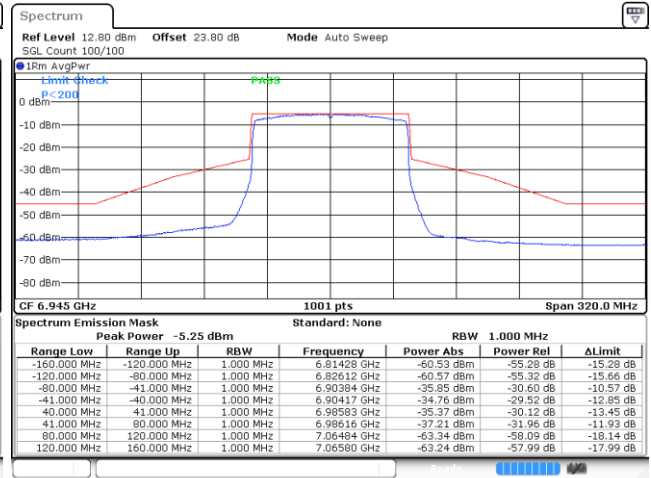

Date: 1.OCT.2021 19:28:28

Plot on Channel 7025MHz

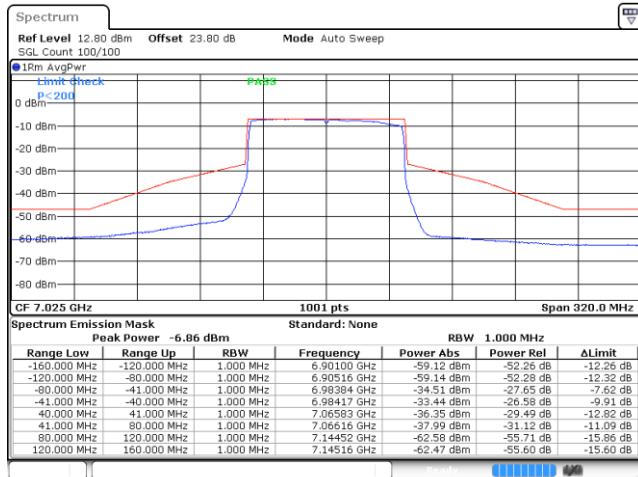

Date: 1.OCT.2021 19:47:34



EUT Mode : 802.11ax HE160

Plot on Channel 6025MHz

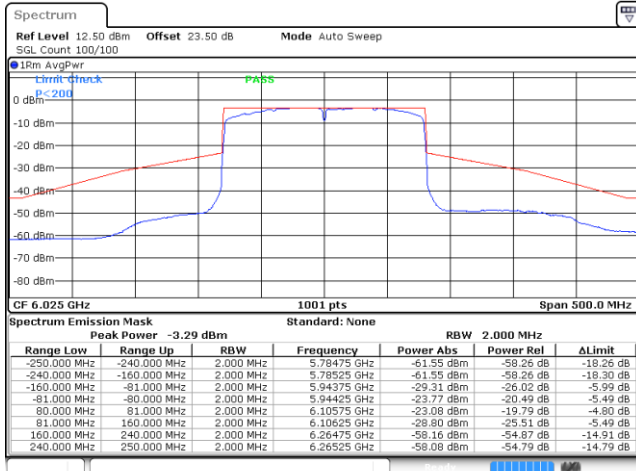

Date: 1.OCT.2021 20:07:13

Plot on Channel 6185MHz

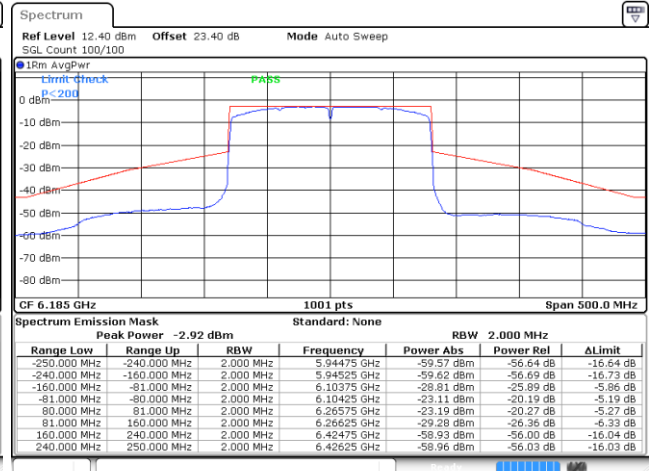

Date: 1.OCT.2021 20:24:50

Plot on Channel 6345MHz

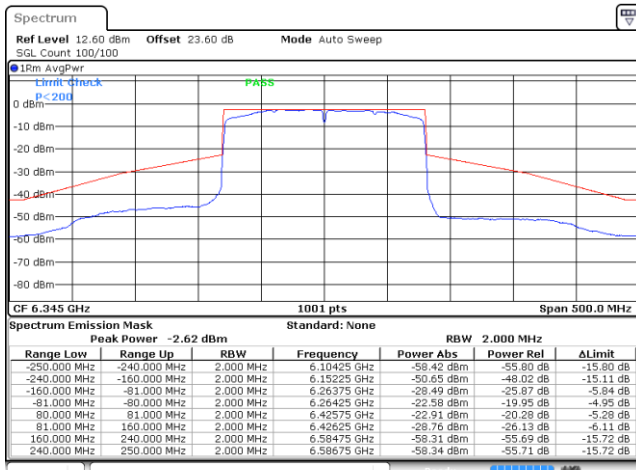

Date: 1.OCT.2021 20:42:22

Plot on Channel 6505MHz

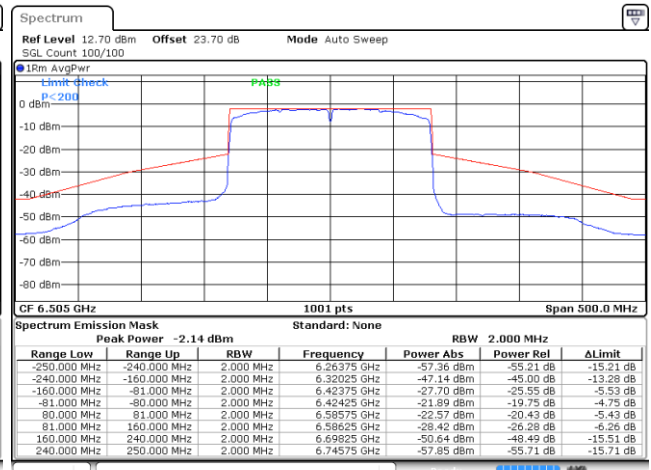

Date: 1.OCT.2021 20:55:25



Plot on Channel 6665MHz

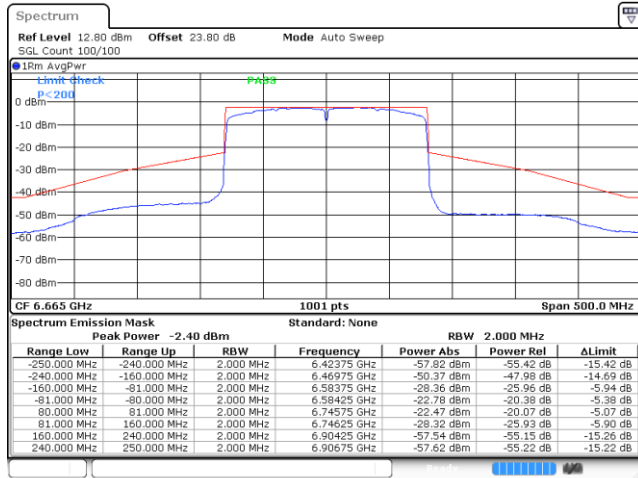

Date: 1.OCT.2021 22:32:09

Plot on Channel 6825MHz

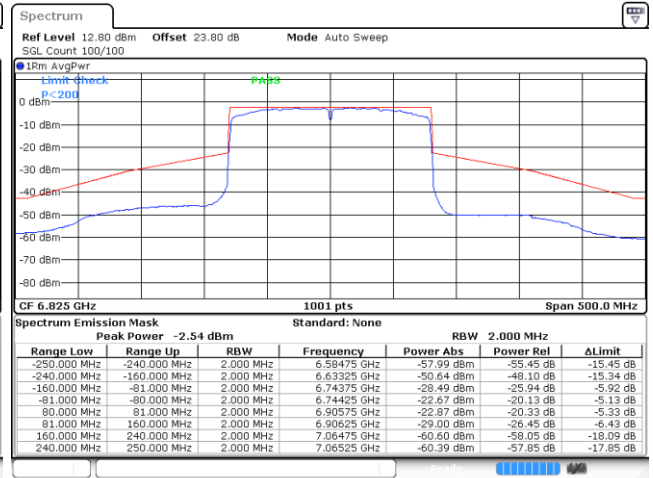

Date: 1.OCT.2021 22:49:22

Plot on Channel 6985MHz

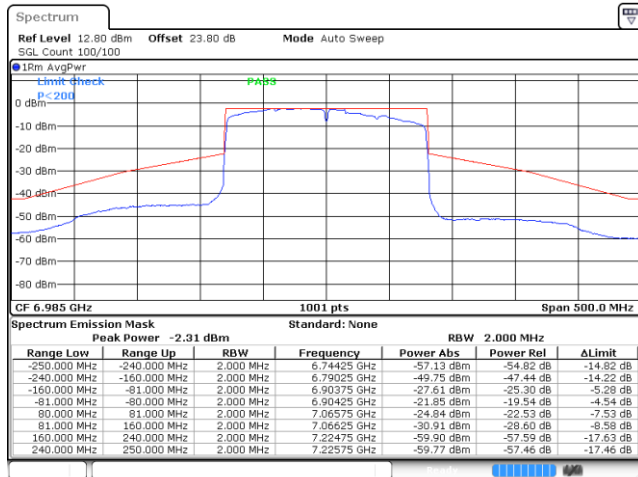

Date: 1.OCT.2021 23:09:27



MIMO <Ant. E+H(H)>

EUT Mode : 802.11a

Plot on Channel 5955MHz

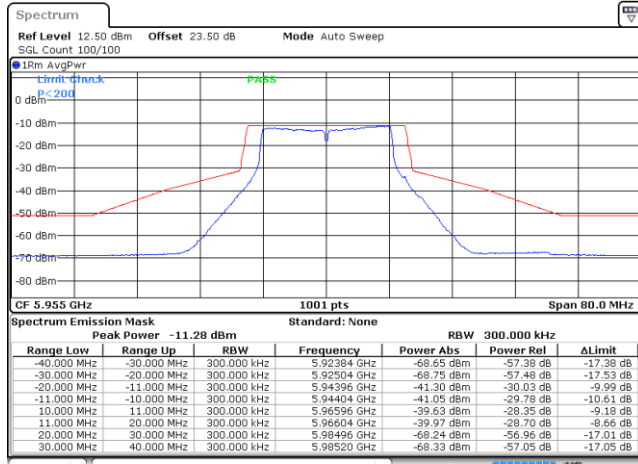

Date: 1.NOV.2021 19:49:24

Plot on Channel 6175MHz

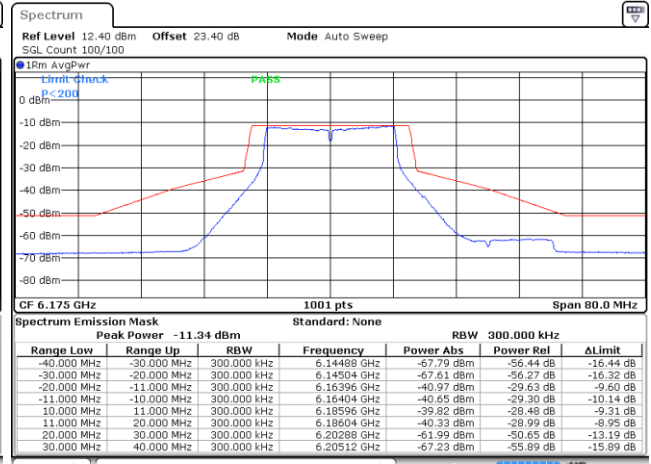

Date: 1.NOV.2021 20:04:13

Plot on Channel 6415MHz

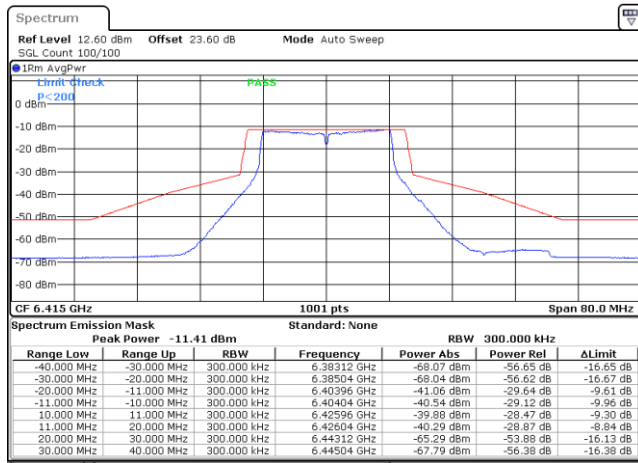

Date: 1.NOV.2021 21:54:52

Plot on Channel 6435MHz

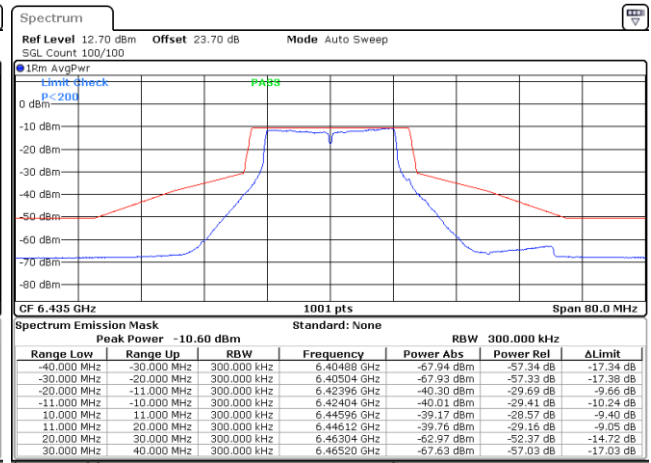

Date: 2.NOV.2021 23:17:00



Plot on Channel 6475MHz

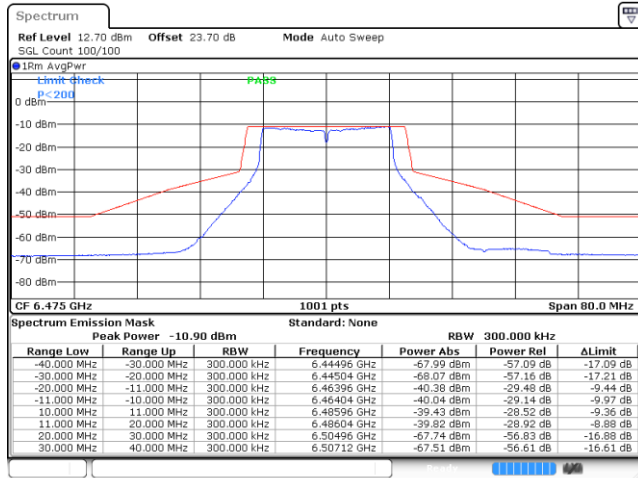

Date: 9 NOV 2021 22:45:47

Plot on Channel 6515MHz

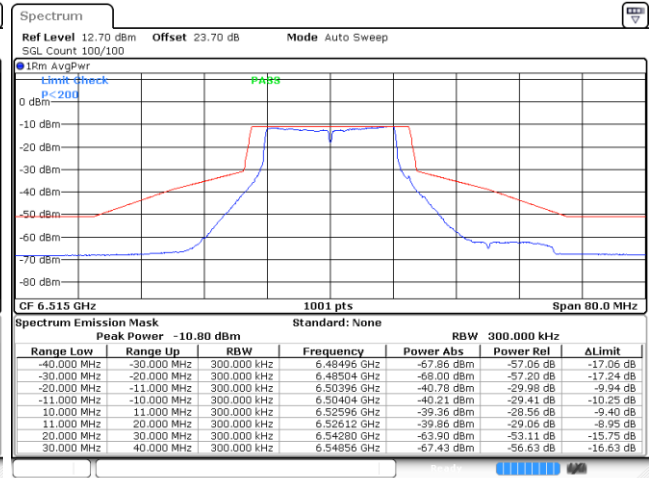

Date: 9 NOV 2021 23:07:17

Plot on Channel 6535MHz

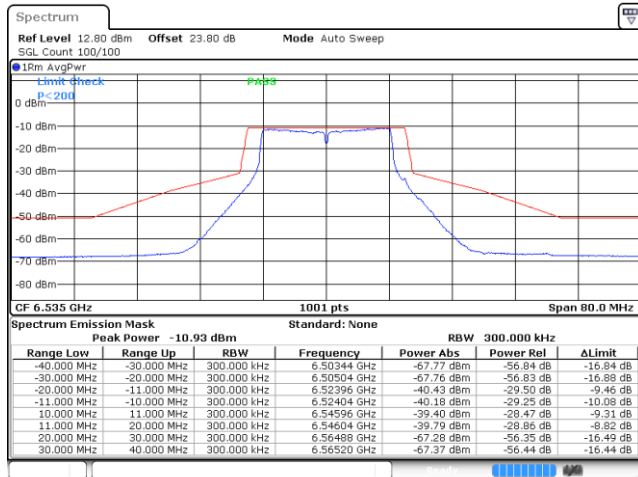

Date: 9 NOV 2021 23:40:10

Plot on Channel 6695MHz

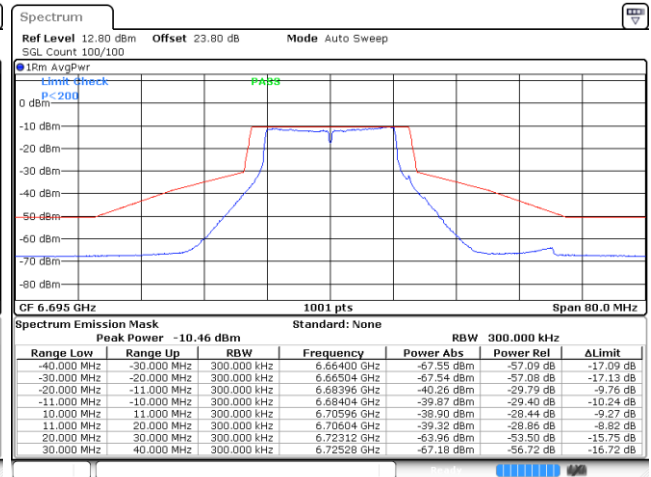

Date: 10 NOV 2021 00:04:21