



FCC DFS TEST REPORT

FCC ID : S9GR760
Equipment : R760 Access Point
Brand Name : RUCKUS
Model Name : R760
Applicant : Ruckus Wireless Inc.
350 W. Java Dr., Sunnyvale CA 94089 USA
Manufacturer : Ruckus Wireless Inc.
350 W. Java Dr., Sunnyvale CA 94089 USA
Standard : FCC Part 15 Subpart E

The product was received on Jul. 28, 2021 and testing was started from Nov. 05, 2021 and completed on Jan. 14, 2022. We, Sporton International (USA) Inc., would like to declare that the tested sample has been evaluated in accordance with the procedures given in FCC Part 15 Subpart E and shown compliance with the applicable technical standards.

The test results in this report apply exclusively to the tested model / sample. Without written approval of Sporton International (USA) Inc., the test report shall not be reproduced except in full.

Approved by: Neil Kao

Sporton International (USA) Inc.
1175 Montague Expressway, Milpitas, CA 95035



Table of Contents

History of this test report.....3

Summary of Test Result.....4

1 General Description5

 1.1 Feature of Equipment Under Test5

 1.2 Modification of EUT6

 1.3 Testing Site6

 1.4 Applied Standards7

 1.5 Support Unit used in test configuration and system7

2 Requirements and Parameters for DFS Test.....8

 2.1 Summary of Dynamic Frequency Selection Test8

 2.2 Applicability of DFS Requirements9

 2.3 DFS Detection Thresholds.....11

 2.4 DFS Response requirement values.....12

 2.5 Short Pulse Radar Test Waveforms13

 2.6 Long Pulse Radar Test Waveform15

 2.7 Frequency Hopping Radar Test Waveform17

3 Calibration Setup and DFS Test Results18

 3.1 Calibration of Radar Waveform18

 3.2 U-NII Detection Bandwidth35

 3.3 Channel Availability Check55

 3.4 In-Service Monitoring: Channel Move Time, Channel Closing Transmission Time and
 Non-Occupancy Period.....63

 3.5 Statistical Performance Check80

4 List of Measuring Equipment.....105

Appendix A. DFS Radar Parameters

Appendix B. Setup Photographs



Summary of Test Result

Report Clause	Ref Std. Clause	Test Items	Result (PASS/FAIL)	Remark
3.2	7.8.1	U-NII Detection Bandwidth	Pass	-
3.3	7.8.2	Channel Availability Check Time	Pass	-
3.4	7.8.3	Channel Move Time	Pass	-
		Channel Closing Transmission Time	Pass	-
		Non-Occupancy Period Test	Pass	-
3.5	7.8.4	Statistical Performance Check	Pass	-

Declaration of Conformity:

The test results (PASS/FAIL) with all measurement uncertainty excluded are presented in accordance with the regulation limits or requirements declared by manufacturers.
It's means measurement values may risk exceeding the limit of regulation standards, if measurement uncertainty is include in test results.

Comments and Explanations:

The product specifications of the EUT presented in the report are declared by the manufacturer who shall take full responsibility for the authenticity.



1 General Description

1.1 Feature of Equipment Under Test

The EUT is an indoor AP with radios including Bluetooth - LE, Wi-Fi 2.4GHz 802.11b/g/n/ac/ax, Wi-Fi 5GHz 802.11a/n/ac/ax, Wi-Fi 6GHz 802.11a/n/ac/ax, 802.15.4 (Zigbee), equipped with integrated antennas configured below:

Antenna Configuration	
Antenna Type	<p>WLAN 2.4GHz <Ant. A>: Omni Antenna <Ant. B>: Omni Antenna <Ant. C>: Omni Antenna <Ant. D>: Omni Antenna</p> <p>WLAN 5GHz Radio 1 and Radio 2: <Ant. A>: Omni Antenna <Ant. B>: Omni Antenna <Ant. C>: Omni Antenna <Ant. D>: Omni Antenna Radio 3: <Ant. E>: Omni Antenna <Ant. F>: Omni Antenna <Ant. G>: Omni Antenna <Ant. H>: Omni Antenna</p> <p>WLAN 6GHz <Ant. E>: Omni Antenna <Ant. F>: Omni Antenna <Ant. G>: Omni Antenna <Ant. H>: Omni Antenna</p> <p>Bluetooth-LE: <Ant. 1>Omni Antenna Zigbee: <Ant. 1>Omni Antenna</p>

Remark: The above EUT's information is declared by the manufacturer. Please refer to Comments and Explanations in report summary.



Antenna information			
5260 MHz ~ 5320 MHz <Radio 1>	Peak Gain (dBi)	Vertical	<Ant. A>: 2.9 <Ant. D>: 2.9
5260 MHz ~ 5320 MHz 5500 MHz ~ 5720 MHz <Radio 2>		Horizontal	<Ant. B>: 2.9 <Ant. C>: 2.9
5500 MHz ~ 5720 MHz <Radio 3>	Peak Gain (dBi)	Vertical	<Ant. E>: 2.9 <Ant. H>: 2.9
		Horizontal	<Ant. F>: 2.9 <Ant. G>: 2.9

Remark:

1. For other wireless features of this EUT, test report will be issued separately.
2. The above EUT's information was declared by manufacturer. Please refer to Comments and Explanations in report summary.
3. The device has three radio circuits operational in WLAN 5GHz bands, the configuration of each circuit is listed in the following table:

Radio 1	UNII-1, UNII-2a
Radio 2	UNII-1, UNII-2a, UNII-2c, UNII-3
Radio 3	UNII-2c, UNII-3

Channel bandwidth 80+80MHz is only supported on channel 42+58 and channel 106+122 and only supported by Radio 1 and Radio 2.

Channel bandwidth 160MHz is only supported by Radio 3.

1.2 Modification of EUT

No modifications are made to the EUT during all test items.

1.3 Testing Site

Test Site	Sporton International (USA) Inc.
Test Site Location	1175 Montague Expressway, Milpitas, CA 95035 TEL : 408 9043300
Test Site No.	Sporton Site No.
	DFS01-CA



1.4 Applied Standards

According to the specifications of the manufacturer, the EUT must comply with the requirements of the following standards:

- ♦ FCC Part 15 Subpart E
- ♦ FCC KDB 905462 D02 UNII DFS Compliance Procedures New Rules v02
- ♦ FCC KDB 905462 D03 UNII Clients Without Radar Detection New Rules v01r02

Remark: All test items were verified and recorded according to the standards and without any deviation during the test.

1.5 Support Unit used in test configuration and system

Item	Equipment	Brand Name	Model Name	FCC ID	HW / FW Version	Power Cord
1.	Notebook	MSI	MS-1615	PD93165NG	N/A	AC I/P: Unshielded, 1.2 m DC O/P: Shielded, 1.8 m
2.	Notebook	HP	15t-cu000	PD97265NG	N/A	AC I/P: Unshielded, 1.2 m DC O/P: Shielded, 1.8 m



2 Requirements and Parameters for DFS Test

2.1 Summary of Dynamic Frequency Selection Test

UNII	Description	Limit
U-NII Band 2-A 5250-5350 MHz	Channel Availability Check Time	> 60sec
	U-NII Detection Bandwidth	> 100% of the U-NII 99% transmission power bandwidth
	Statistical Performance Check	Type 1,2,3,4 >= 60% Type 1~4 and 5 >= 80% Type 6 >= 70%
	Channel Move Time	< 10 sec
	Channel Closing Transmission Time	< 200 ms + aggregate of 60 ms over remaining 10 s period
	Non-Occupancy Period Test	> 30 minutes
U-NII Band 2-C 5470-5725 MHz	Channel Availability Check Time	> 60sec
	U-NII Detection Bandwidth	> 100% of the U-NII 99% transmission power bandwidth
	Statistical Performance Check	Type 1,2,3,4 >= 60% Type 1~4 and 5 >= 80% Type 6 >= 70%
	Channel Move Time	< 10 sec
	Channel Closing Transmission Time	< 200 ms + aggregate of 60 ms over remaining 10 s period
	Non-Occupancy Period Test	> 30 minutes



2.2 Applicability of DFS Requirements

EUT is considered as a master device.

Table 1: Applicability of DFS Requirements Prior to Use of a Channel

Requirement	Operational Mode		
	Master	Client Without Radar Detection	Client With Radar Detection
Non-Occupancy Period	Yes	Not required	Yes
DFS Detection Threshold	Yes	Not required	Yes
Channel Availability Check Time	Yes	Not required	Not required
U-NII Detection Bandwidth	Yes	Not required	Yes



Table 2: Applicability of DFS requirements during normal operation

Requirement	Operational Mode		
	Master	Client Without Radar Detection	Client With Radar Detection
DFS Detection Threshold	Yes	Not required	Yes
Channel Closing Transmission Time	Yes	Yes	Yes
Channel Move Time	Yes	Yes	Yes
U-NII Detection Bandwidth	Yes	Not required	Yes
Client Beacon Test	N/A	Yes	Yes

Additional requirements for devices with multiple bandwidth modes	Operational Mode	
	Master or Client With Radar Detection	Client Without Radar Detection
U-NII Detection Bandwidth and Statistical Performance Check	All BW modes must be tested	Not required
Channel Move Time and Channel Closing Transmission Time	Test using widest BW mode available	Test using the widest BW mode available for the link
All other tests	Any single BW mode	Not required

Note

Frequencies selected for statistical performance check (Section 7.8.4) should include several frequencies within the radar detection bandwidth and frequencies near the edge of the radar detection bandwidth. For 802.11 devices it is suggested to select frequencies in each of the bonded 20 MHz channels and the channel center frequency.



2.3 DFS Detection Thresholds

Table 3 below provides the DFS Detection Thresholds for Master Devices as well as Client Devices incorporating In-Service Monitoring.

Table 3: DFS Detection Thresholds for Master Devices

Maximum Transmit Power	Value (see notes 1, 2, and 3)
EIRP \geq 200 milliwatt	-64 dBm
EIRP < 200 milliwatt and power spectral density < 10 dBm/MHz	-62 dBm
EIRP < 200 milliwatt that do not meet the power spectral density requirement	-64 dBm

Note 1: This is the level at the input of the receiver assuming a 0 dBi receive antenna.
Note 2: Throughout these test procedures an additional 1 dB has been added to the amplitude of the test transmission waveforms to account for variations in measurement equipment. This will ensure that the test signal is at or above the detection threshold level to trigger a DFS response.
Note 3: EIRP is based on the highest antenna gain. For MIMO devices refer to KDB Publication 662911 D01.

The radar Detection Threshold, lowest antenna gain is the parameter of Interference radar DFS detection threshold, The Interference Detection Threshold is the -64 dBm.



2.4 DFS Response requirement values

Table 4 provides the response requirements for Master and Client Devices incorporating DFS.

Table 4: DFS Response Requirement Values

Parameter	Value
Non-occupancy period	Minimum 30 minutes
Channel Availability Check Time	60 seconds
Channel Move Time	10 seconds See Note 1.
Channel Closing Transmission Time	200 milliseconds + an aggregate of 60 milliseconds over remaining 10 second period. See Notes 1 and 2.
U-NII Detection Bandwidth	Minimum 100% of the 99% power bandwidth See Note 3.

Note 1: Channel Move Time and the Channel Closing Transmission Time should be performed with Radar Type 0. The measurement timing begins at the end of the Radar Type 0 burst.

Note 2: The Channel Closing Transmission Time is comprised of 200 milliseconds starting at the beginning of the Channel Move Time plus any additional intermittent control signals required to facilitate Channel changes (an aggregate of 60 milliseconds) during the remainder of the 10 second period. The aggregate duration of control signals will not count quiet periods in between transmissions.

Note 3: During the U-NII Detection Bandwidth detection test, radar type 0 is used and for each frequency step the minimum percentage of detection is 90%. Measurements are performed with no data traffic.



2.5 Short Pulse Radar Test Waveforms

Radar Type 0 was used in the evaluation of the Client device for the purpose of measuring the Channel Move Time and the Channel Closing Transmission Time.

Radar Type	Pulse Width (μsec)	PRI (μsec)	Number of Pulses	Minimum Percentage of Successful Detection	Minimum Trials
0	1	1428	18	See Note 1.	See Note 1.
1	1	Test A Test B	Roundup $\left\{ \begin{matrix} \left(\frac{1}{360} \right) \cdot \\ \left(\frac{19 \cdot 10^6}{PRI_{\mu sec}} \right) \end{matrix} \right\}$	60%	30
2	1-5	150-230	23-29	60%	30
3	6-10	200-500	16-18	60%	30
4	11-20	200-500	12-16	60%	30
Aggregate (Radar Types 1-4)				80%	120
Note 1: Short Pulse Radar Type 0 should be used for the detection bandwidth test, channel move time, and channel closing time tests.					

Test A: 15 unique PRI values randomly selected from the list of 23 PRI values in Table 5a

Test B: 15 unique PRI values randomly selected within the range of 518-3066 μsec, with a minimum increment of 1 μsec, excluding PRI values selected in Test A

A minimum of 30 unique waveforms are required for each of the Short Pulse Radar Types 2 through 4. If more than 30 waveforms are used for Short Pulse Radar Types 2 through 4, then each additional waveform must also be unique and not repeated from the previous waveforms.

If more than 30 waveforms are used for Short Pulse Radar Type 1, then each additional waveform is generated with Test B and must also be unique and not repeated from the previous waveforms in Tests A or B.

The aggregate is the average of the percentage of successful detections of short pulse radar types 1-4.



Table 5a - Pulse Repetition Intervals Values for Test A

Pulse Repetition Frequency Number (1 to 23)	Pulse Repetition Frequency (Pulses Per Second)	Pulse Repetition Interval (Microseconds)
1	1930.5	518
2	1858.7	538
3	1792.1	558
4	1730.1	578
5	1672.2	598
6	1618.1	618
7	1567.4	638
8	1519.8	658
9	1474.9	678
10	1432.7	698
11	1392.8	718
12	1355.0	738
13	1319.3	758
14	1285.3	778
15	1253.1	798
16	1222.5	818
17	1193.3	838
18	1165.5	858
19	1139.0	878
20	1113.6	898
21	1089.3	918
22	1066.1	938
23	326.2	3066



2.6 Long Pulse Radar Test Waveform

Radar Type	Pulse Width (µsec)	Chirp Width (MHz)	PRI (µsec)	Number of Pulses per Burst	Number of Bursts	Minimum Percentage of Successful Detection	Minimum Trials
5	50-100	5-20	1000-2000	1-3	8-20	80%	30

The parameters for this waveform are randomly chosen. Thirty unique waveforms are required for the Long Pulse radar test signal. If more than 30 waveforms are used for the Long Pulse radar test signal, then each additional waveform must also be unique and not repeated from the previous waveforms. Each waveform is defined as follows:

Note: The center frequency for each of the 30 trials of the Bin 5 radar shall be randomly selected within 80% of the Occupied Bandwidth.

- (1) The transmission period for the Long Pulse Radar test signal is 12 seconds.
- (2) There are a total of 8 to 20 Bursts in the 12 second period, with the number of Bursts being randomly chosen. This number is Burst_Count.
- (3) Each Burst consists of 1 to 3 pulses, with the number of pulses being randomly chosen. Each Burst within the 12 second sequence may have a different number of pulses.
- (4) The pulse width is between 50 and 100 microseconds, with the pulse width being randomly chosen. Each pulse within a Burst will have the same pulse width. Pulses in different Bursts may have different pulse widths.
- (5) Each pulse has a linear frequency modulated chirp between 5 and 20 MHz, with the chirp width being randomly chosen. Each pulse within a **transmission period** will have the same chirp width. The chirp is centered on the pulse. For example, with a radar frequency of 5300 MHz and a 20 MHz chirped signal, the chirp starts at 5290 MHz and ends at 5310 MHz
- (6) If more than one pulse is present in a Burst, the time between the pulses will be between 1000 and 2000 microseconds, with the time being randomly chosen. If three pulses are present in a Burst, the time between the first and second pulses is chosen independently of the time between the second and third pulses.
- (7) The 12 second transmission period is divided into even intervals. The number of intervals is equal to Burst_Count. Each interval is of length $(12,000,000 / \text{Burst_Count})$ microseconds. Each interval contains one Burst. The start time for the Burst, relative to the beginning of the interval, is between 1 and $[(12,000,000 / \text{Burst_Count}) - (\text{Total Burst Length}) + (\text{One Random PRI Interval})]$ microseconds, with the start time being randomly chosen. The step interval for the start time is 1 microsecond. The start time for each Burst is chosen independently.

A representative example of a Long Pulse radar test waveform:

- (1) The total test signal length is 12 seconds.
- (2) 8 Bursts are randomly generated for the Burst_Count.
- (3) Burst 1 has 2 randomly generated pulses.
- (4) The pulse width (for both pulses) is randomly selected to be 75 microseconds.
- (5) The PRI is randomly selected to be at 1213 microseconds.
- (6) Bursts 2 through 8 are generated using steps 3 – 5.
- (7) Each Burst is contained in even intervals of 1,500,000 microseconds. The starting location for Pulse 1, Burst 1 is randomly generated (1 to 1,500,000 minus the total Burst 1 length + 1 random PRI interval) at the 325,001 microsecond step. Bursts 2 through 8 randomly fall in successive 1,500,000 microsecond intervals (i.e. Burst 2 falls in the 1,500,001 – 3,000,000 microsecond range).

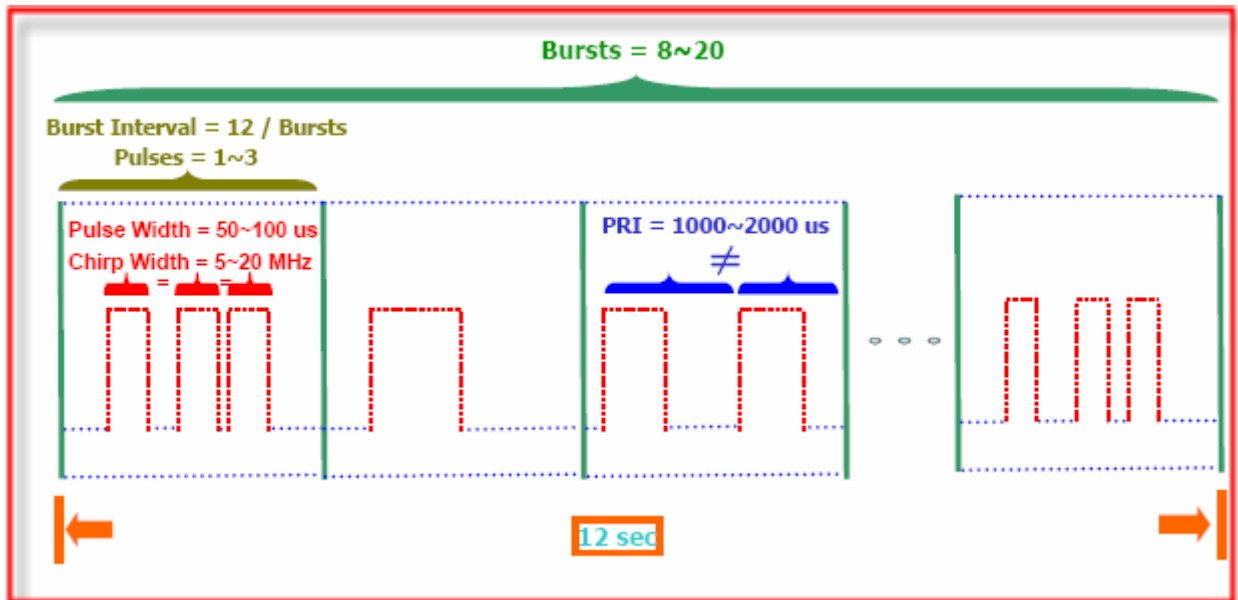

2.7 Frequency Hopping Radar Test Waveform

Radar Type	Pulse Width (µsec)	PRI (µsec)	Pulses per Hop	Hopping Rate (kHz)	Hopping Sequence Length (msec)	Minimum Percentage of Successful Detection	Minimum Trials
6	1	333	9	0.333	300	70%	30

For the Frequency Hopping Radar Type, the same Burst parameters are used for each waveform. The hopping sequence is different for each waveform and a 100-length segment is selected from the hopping sequence defined by the following algorithm:

The first frequency in a hopping sequence is selected randomly from the group of 475 integer frequencies from 5250 – 5724 MHz. Next, the frequency that was just chosen is removed from the group and a frequency is randomly selected from the remaining 474 frequencies in the group. This process continues until all 475 frequencies are chosen for the set. For selection of a random frequency, the frequencies remaining within the group are always treated as equally likely.

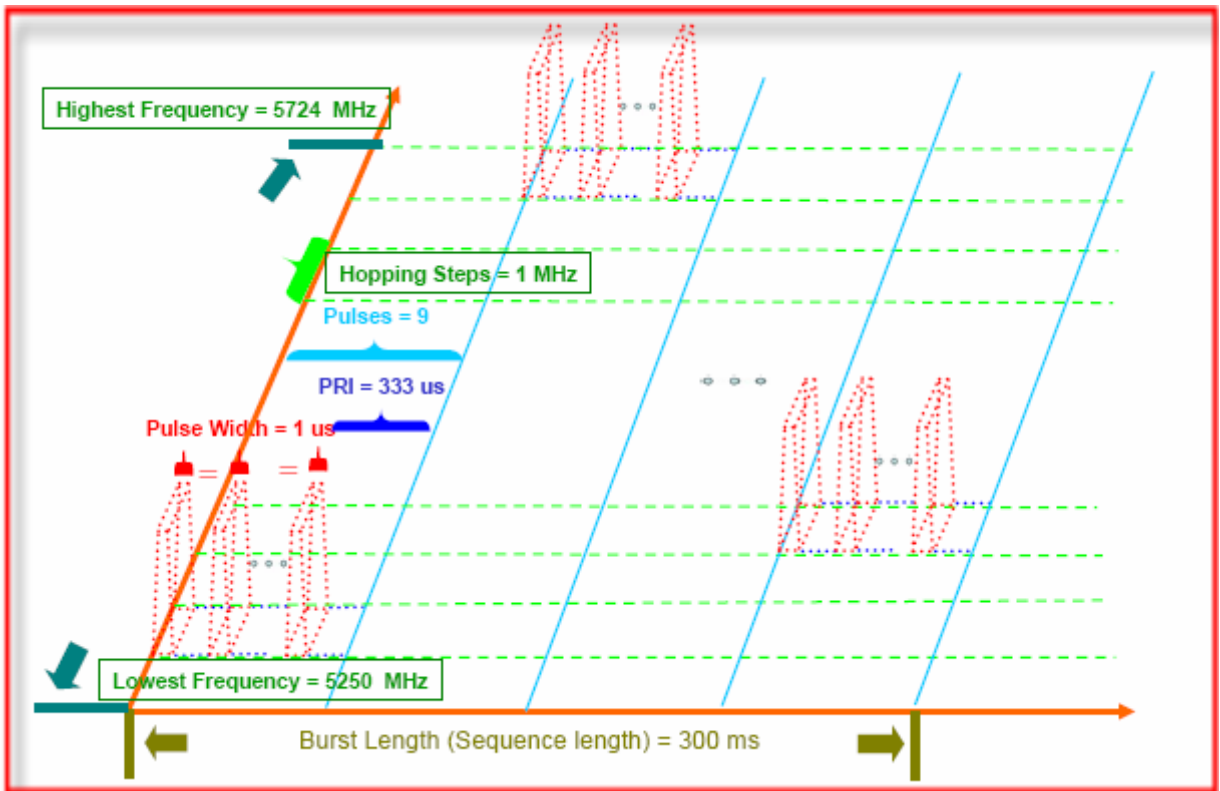

3 Calibration Setup and DFS Test Results

3.1 Calibration of Radar Waveform

3.1.1 Radar Waveform Calibration Procedure

The Interference Radar Detection Threshold Level is (-64) dBm that had been taken into account the output power range and antenna gain. The following equipment setup was used to calibrate the conducted Radar Waveform. A vector signal generator was utilized to establish the test signal level for radar type 0~6. During this process there were no transmissions by either the Master or Client Device. The spectrum analyzer was switched to the zero span (Time Domain) at the frequency of the Radar Waveform generator. Peak detection was used. The spectrum analyzer resolution bandwidth (RBW) and video bandwidth (VBW) were set to 3 MHz to measure the radar waveform. The vector signal generator amplitude was set so that the power level measured at the spectrum analyzer was (-64) dBm. Capture the spectrum analyzer plots on radar waveform.

3.1.2 Calibration Setup

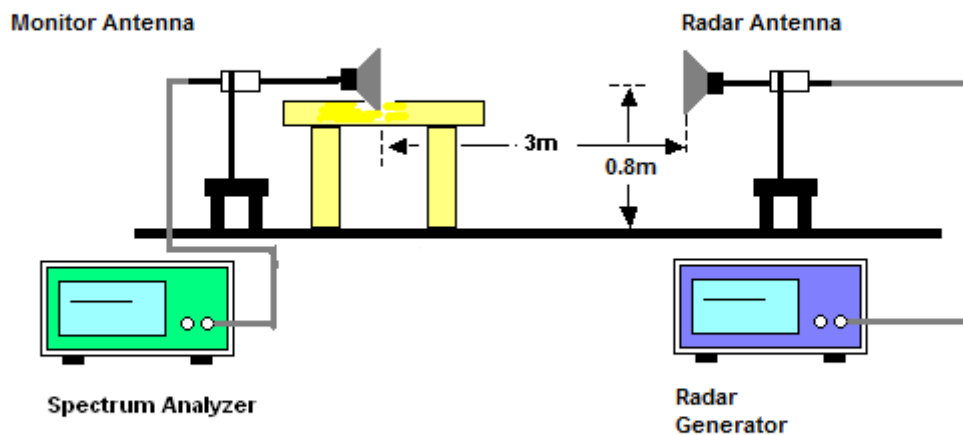

3.1.3 Calibration Deviation

There is no deviation with the original standard.



3.1.4 Radar Waveform Calibration Result

<20MHz / 5300MHz>

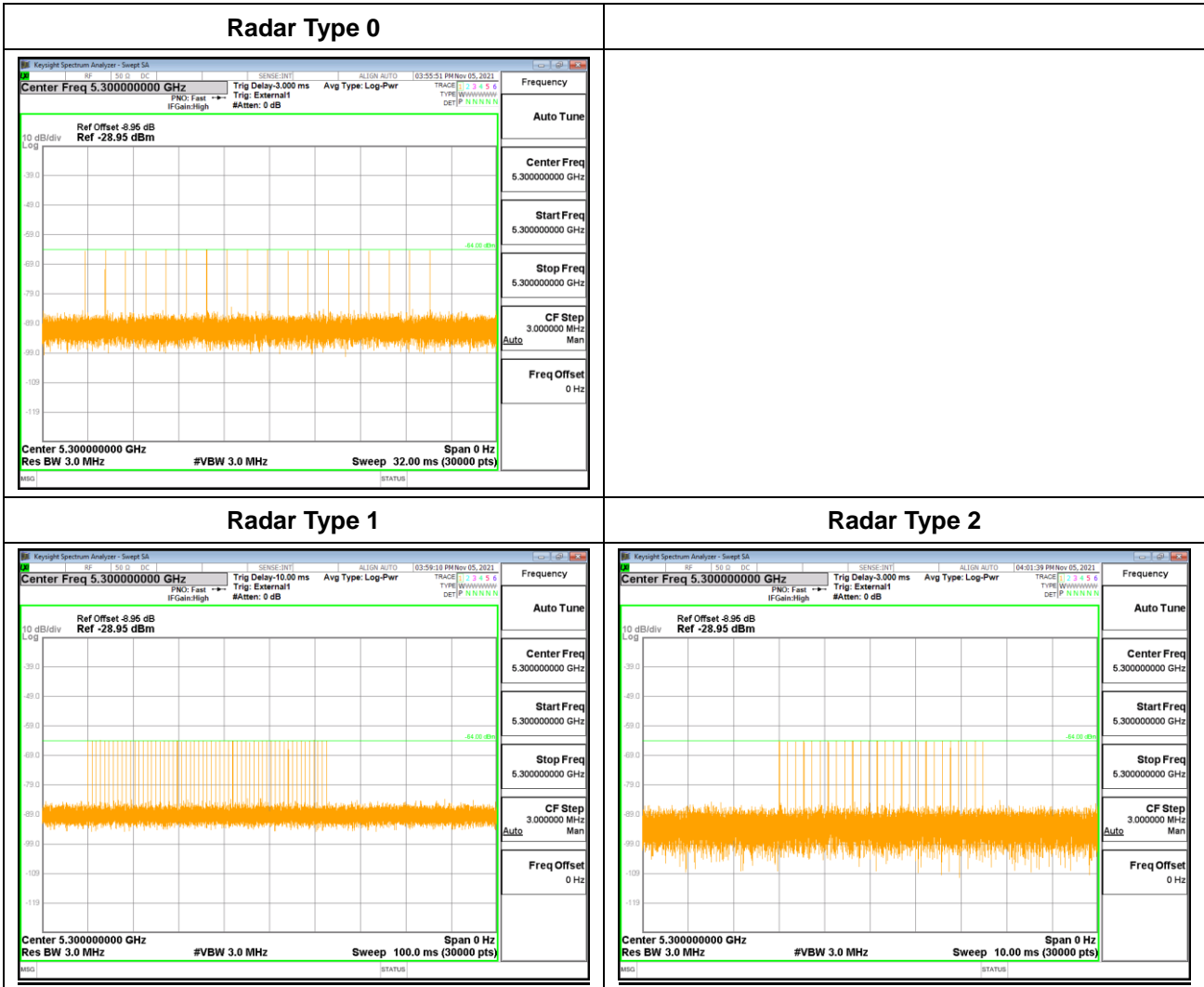



Radars Type 3

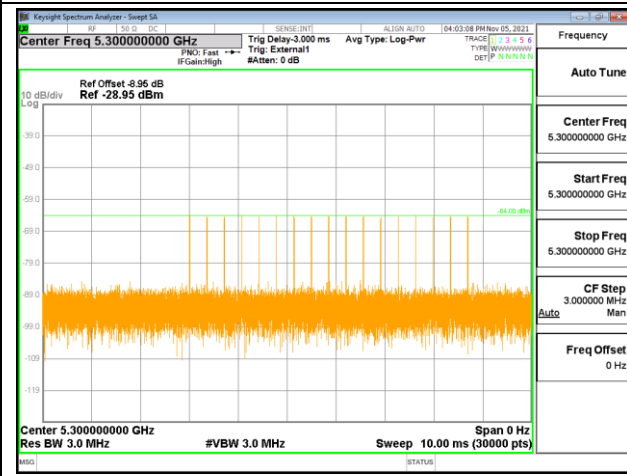

Radars Type 4

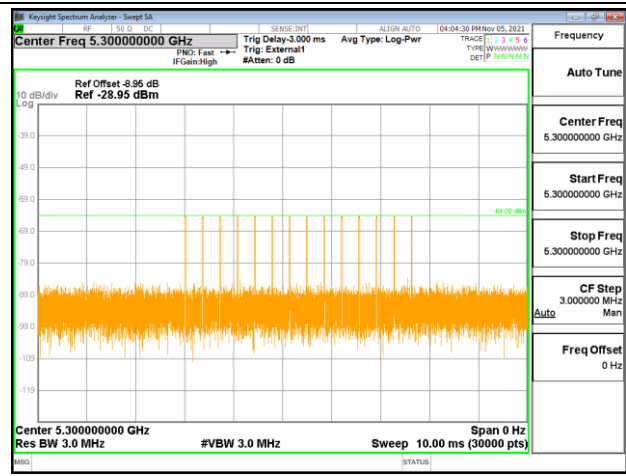

Single Burst of Radar Type 5

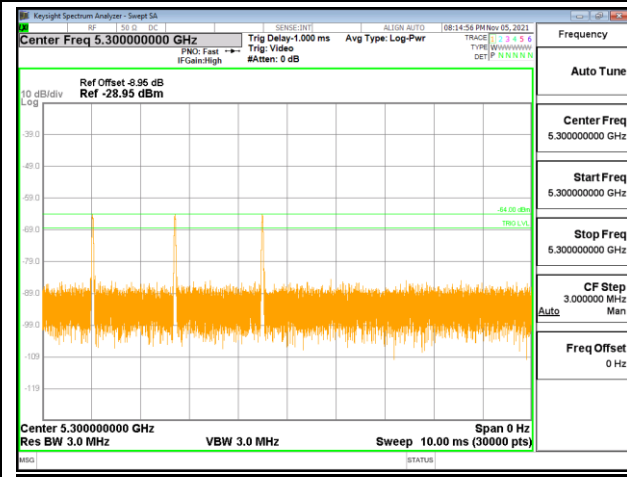

Single Burst of Radar Type 6

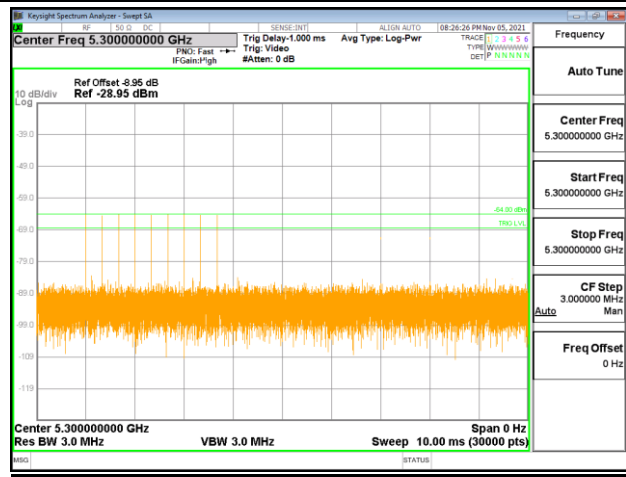



<40MHz / 5310MHz>

Radars Type 0

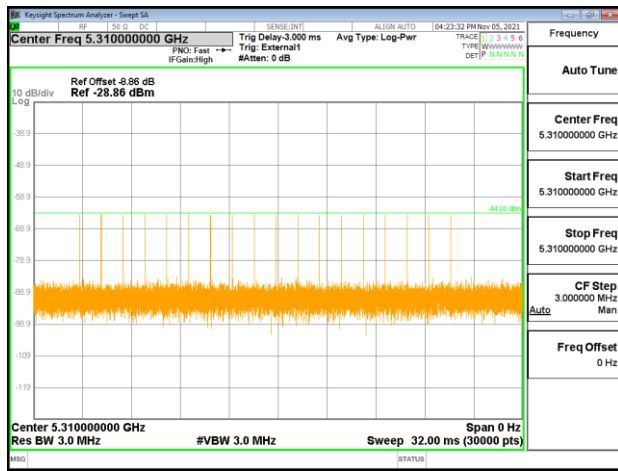

Radars Type 1

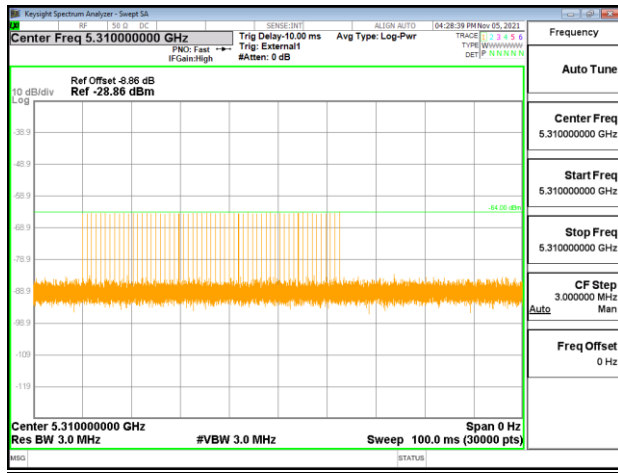

Radars Type 2

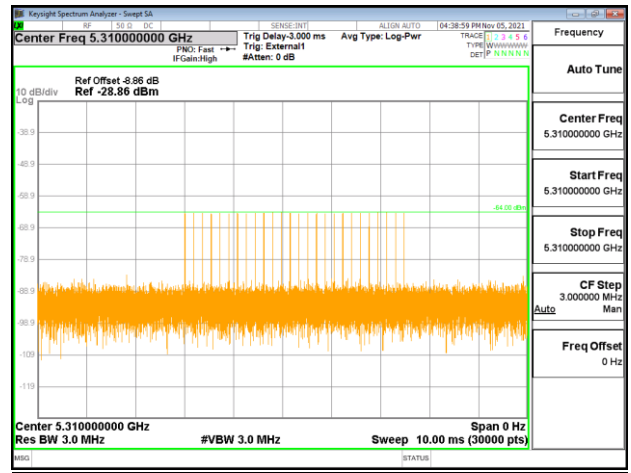



Radars Type 3

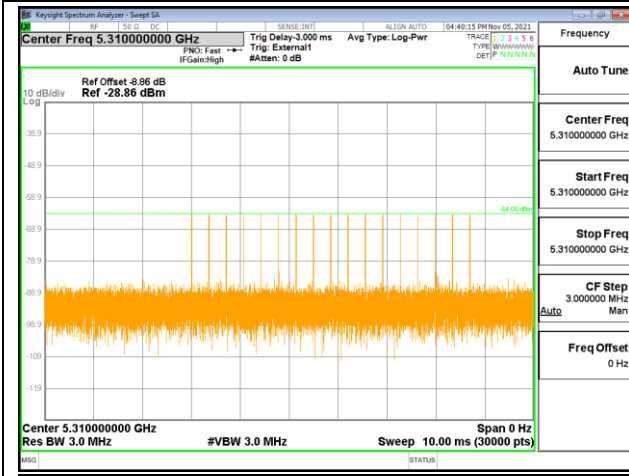

Radars Type 4

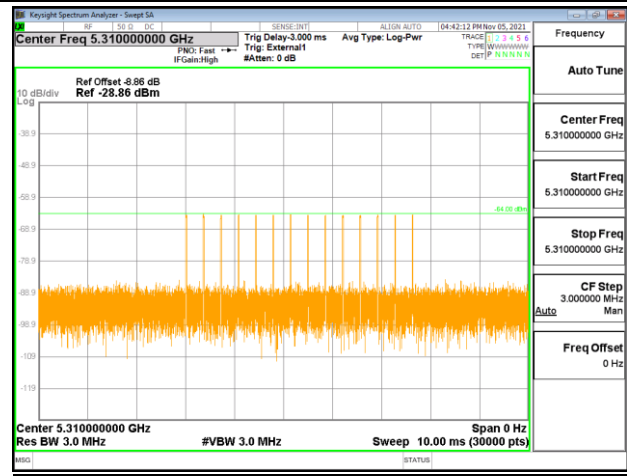

Single Burst of Radar Type 5

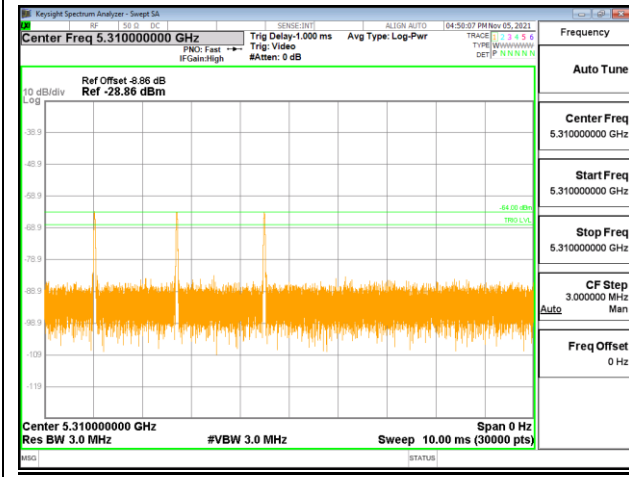

Single Burst of Radar Type 6

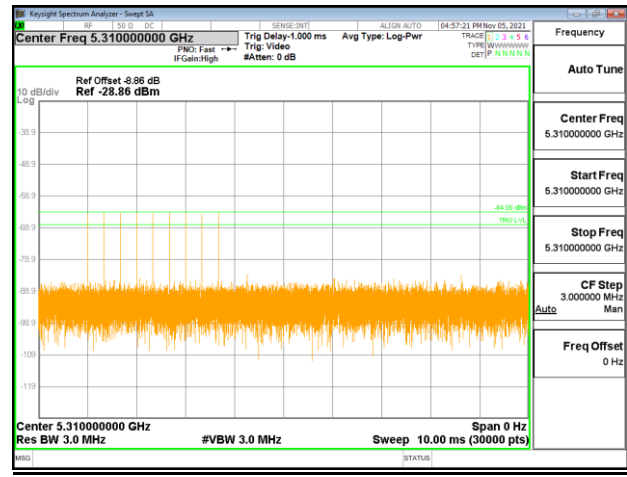



< 80+80MHz / 160MHz / 80MHz / 5290MHz >

Radars Type 0

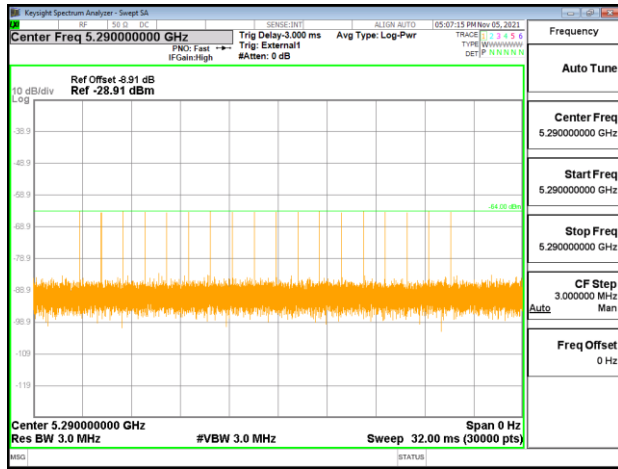

Radars Type 1

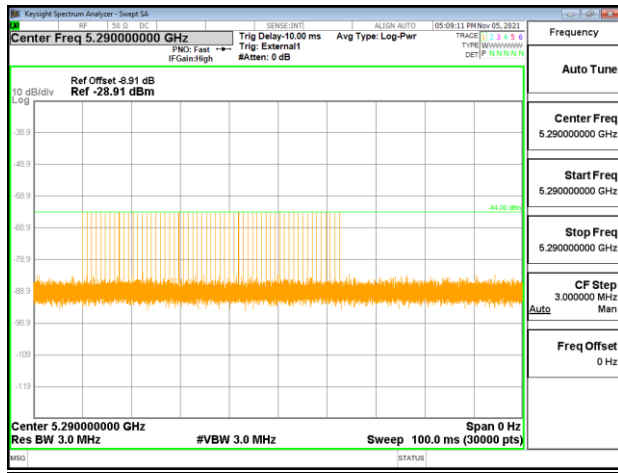

Radars Type 2

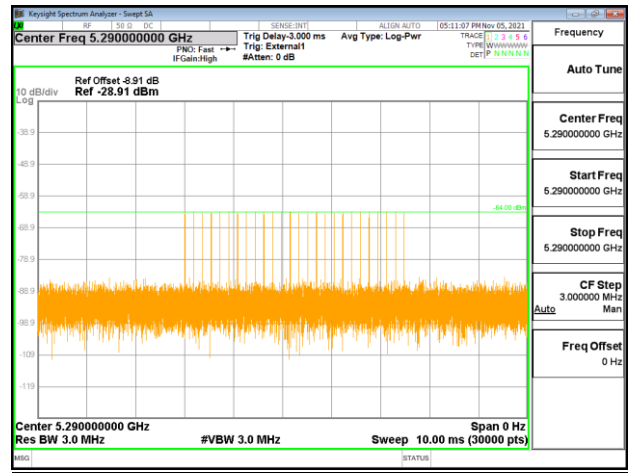



Radars Type 3

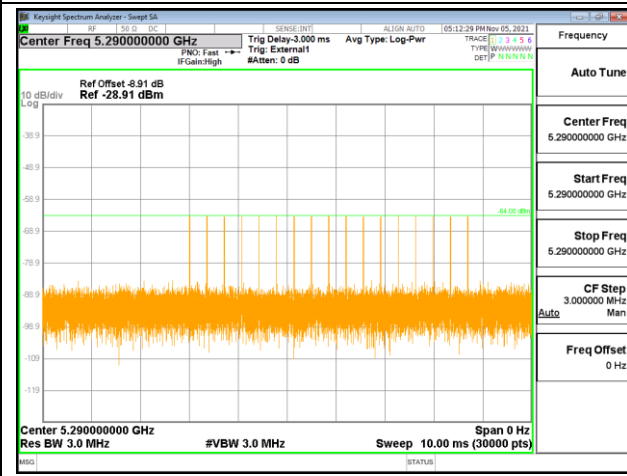

Radars Type 4

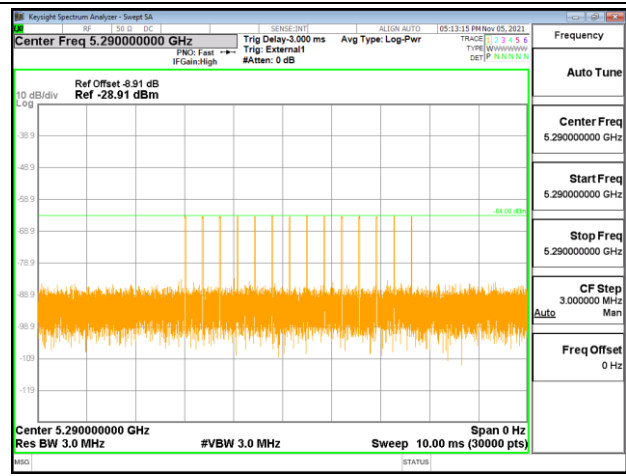

Single Burst of Radar Type 5

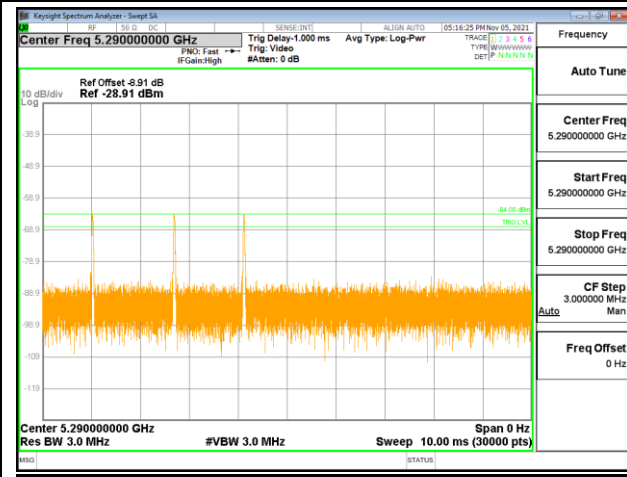

Single Burst of Radar Type 6

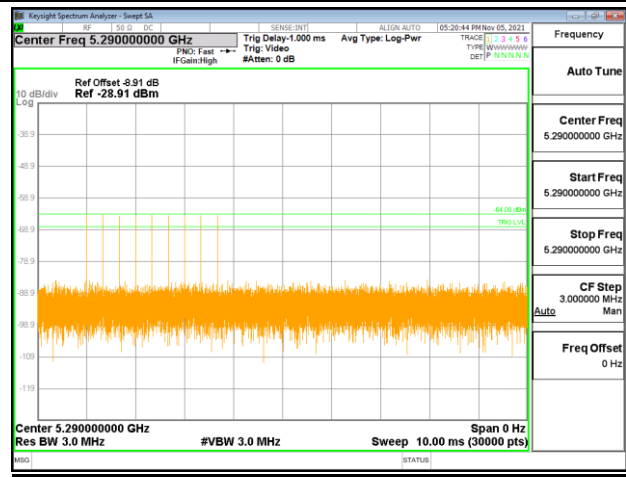



<20MHz / 5500MHz>

Radars Type 0

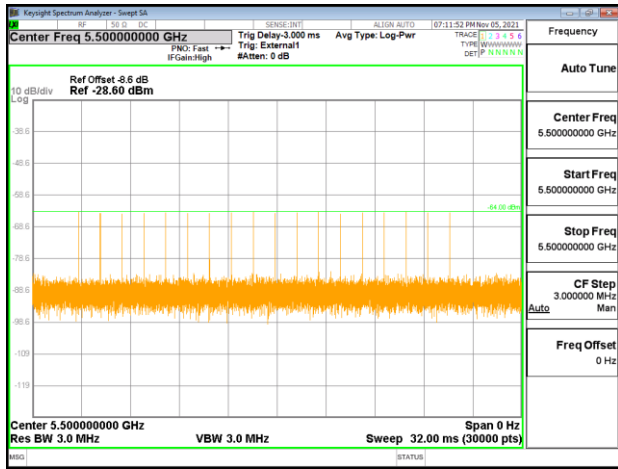

Radars Type 1

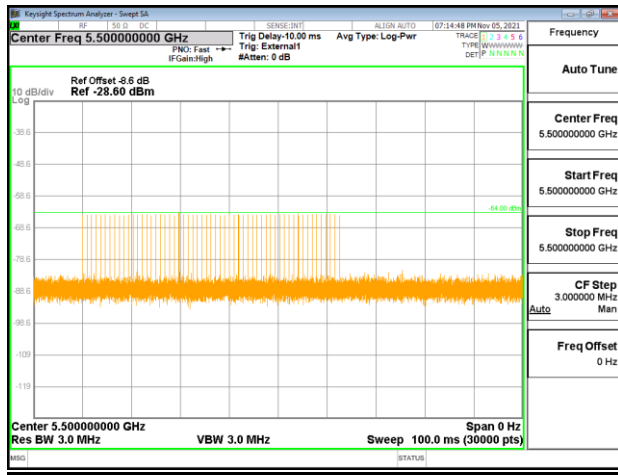

Radars Type 2

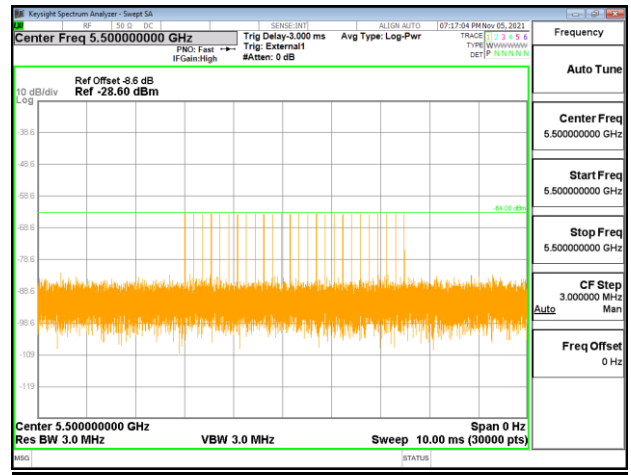



Radars Type 3

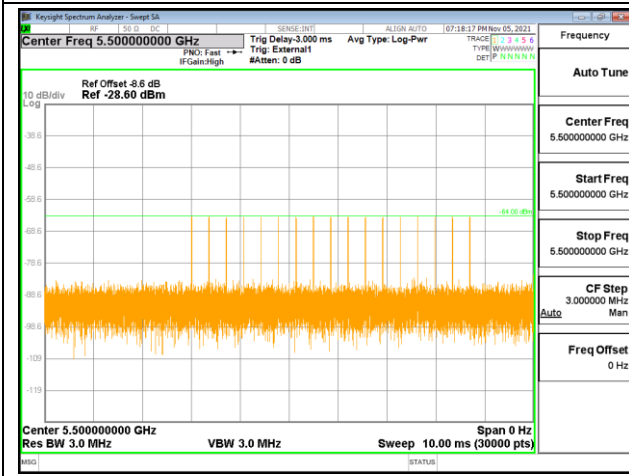

Radars Type 4

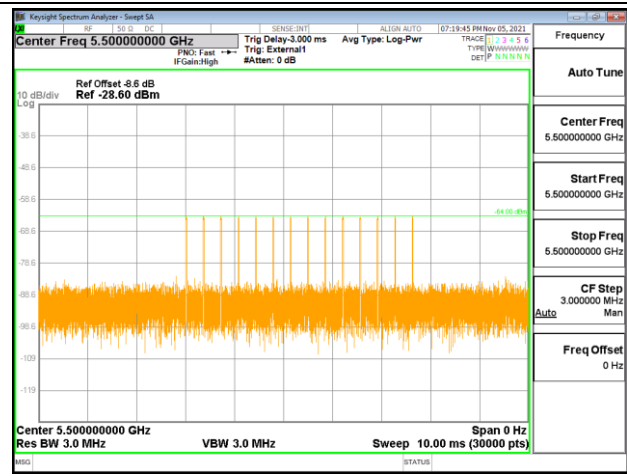

Single Burst of Radar Type 5

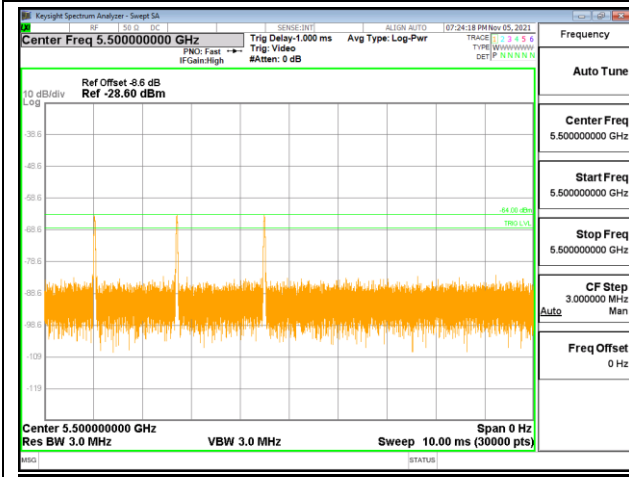

Single Burst of Radar Type 6

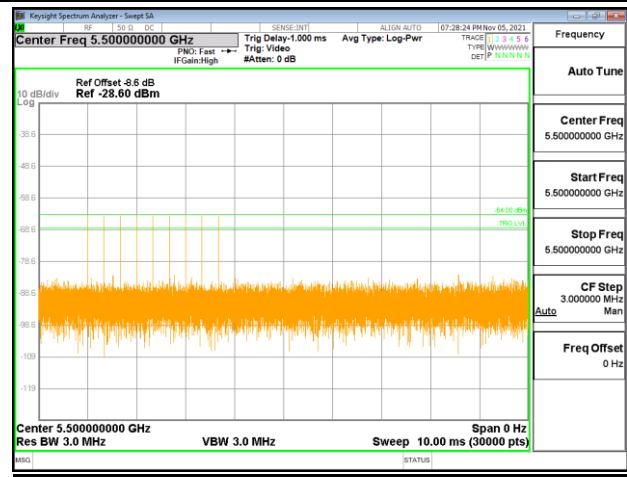



<40MHz / 5510MHz>

Radars Type 0

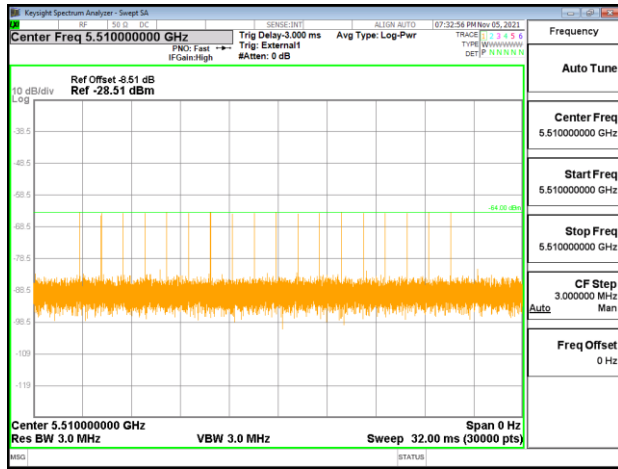

Radars Type 1

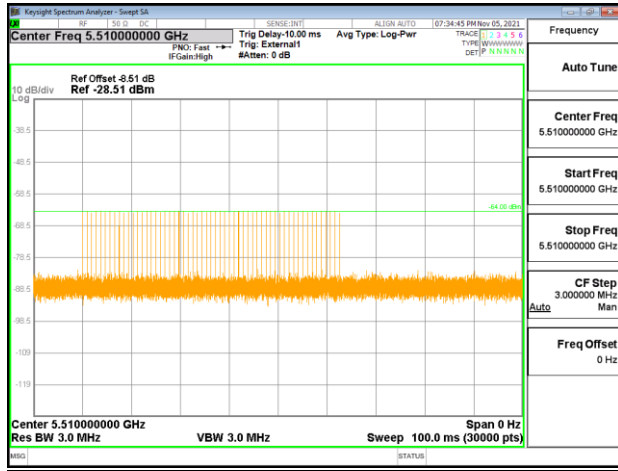

Radars Type 2

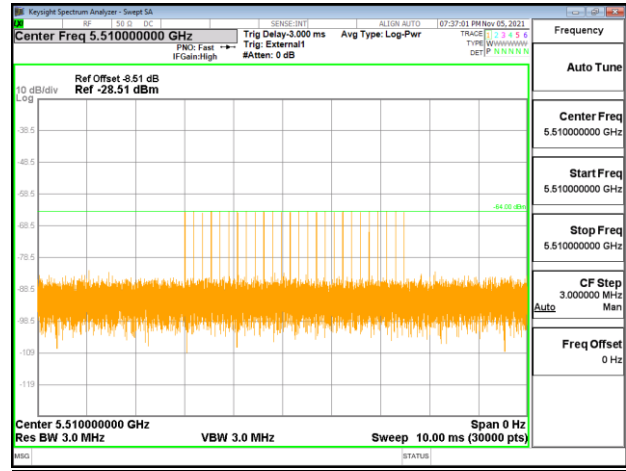



Radars Type 3

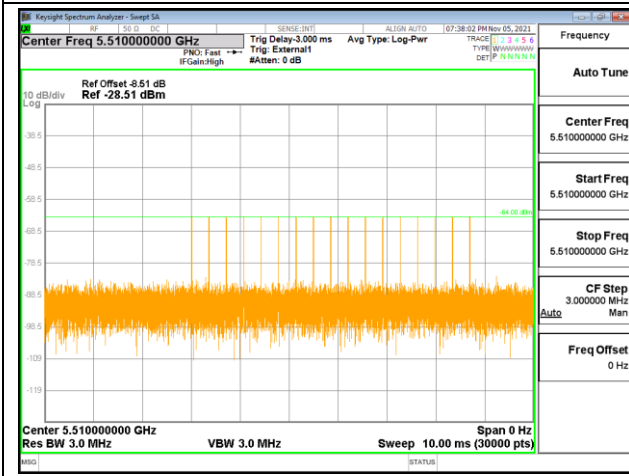

Radars Type 4

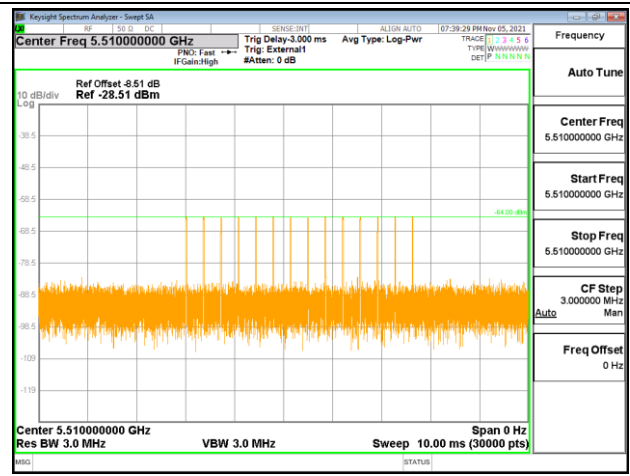

Single Burst of Radar Type 5

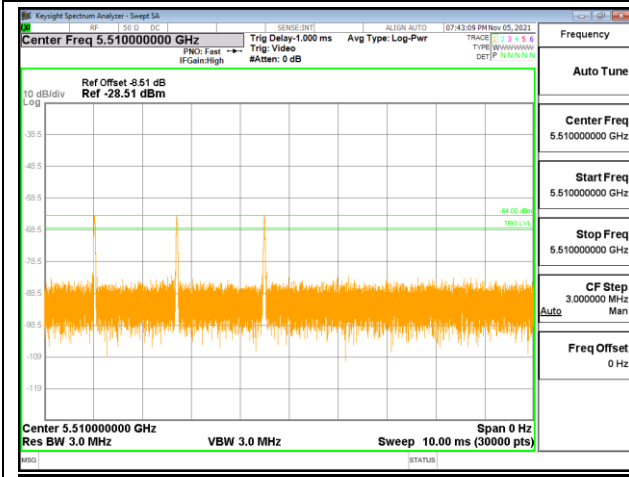

Single Burst of Radar Type 6

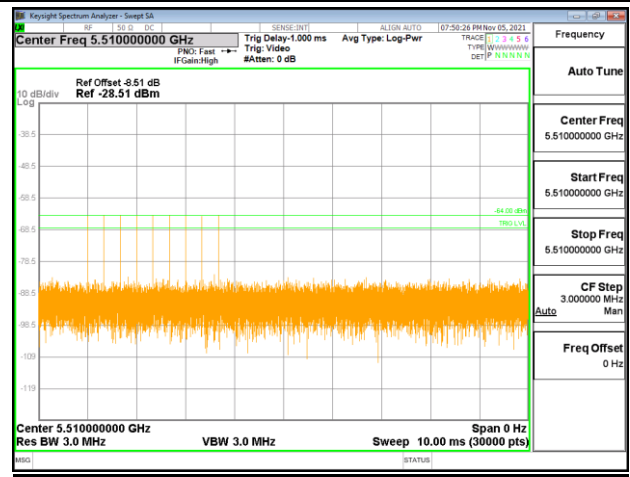



< 80+80MHz / 80MHz / 5530MHz >

Radars Type 0

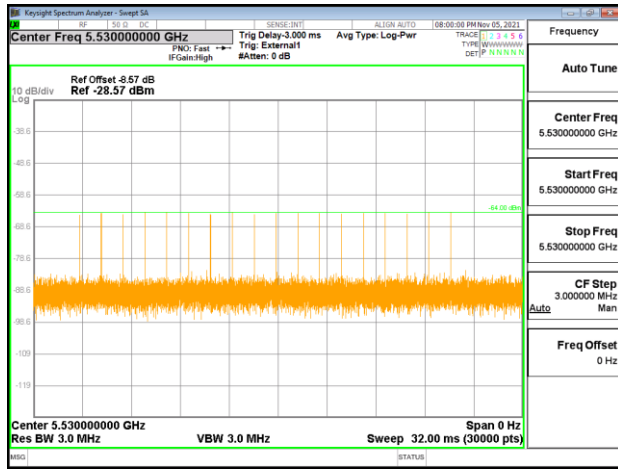

Radars Type 1

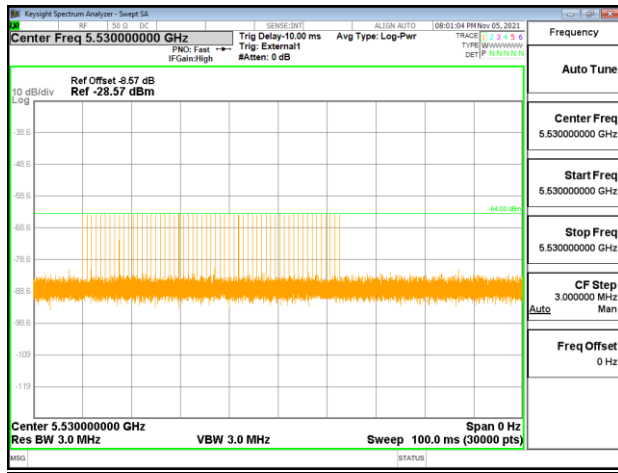

Radars Type 2

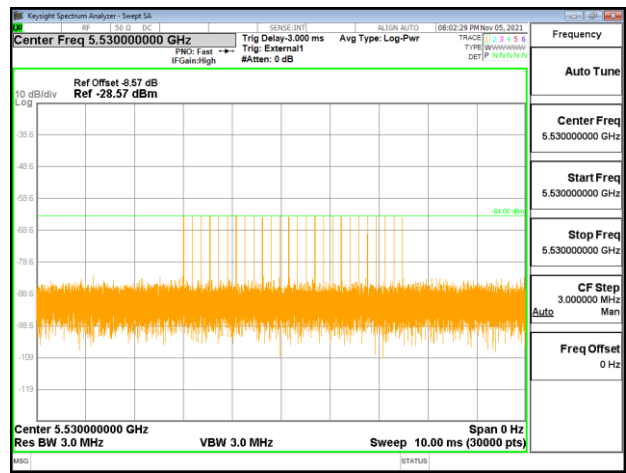



Radars Type 3

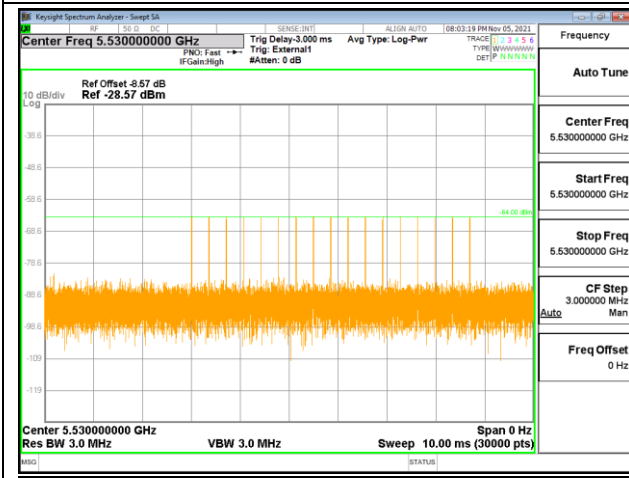

Radars Type 4

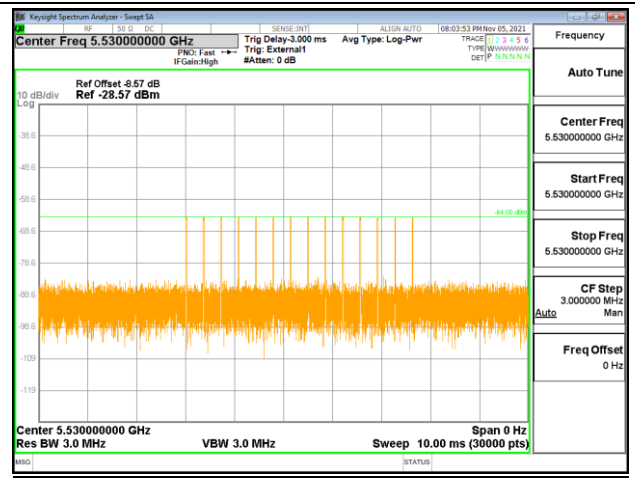

Single Burst of Radar Type 5

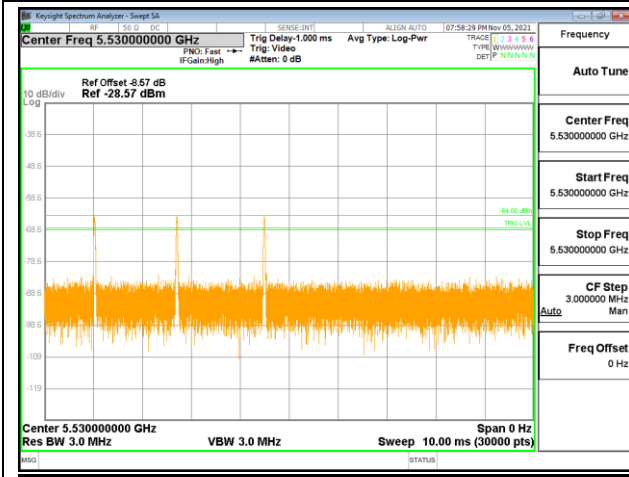

Single Burst of Radar Type 6

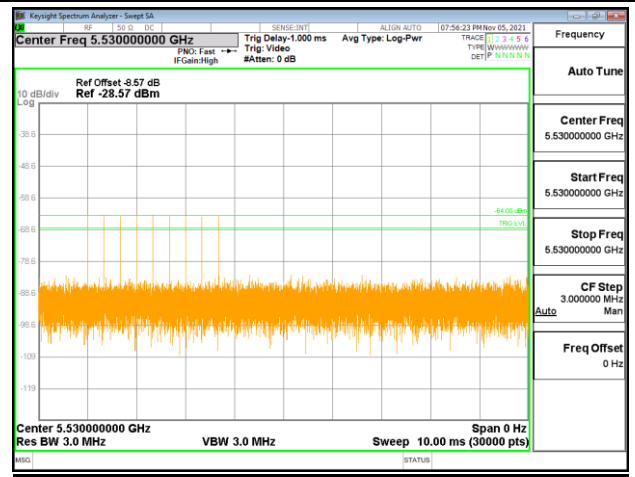



< 80+80MHz / 5610MHz >

Radars Type 0

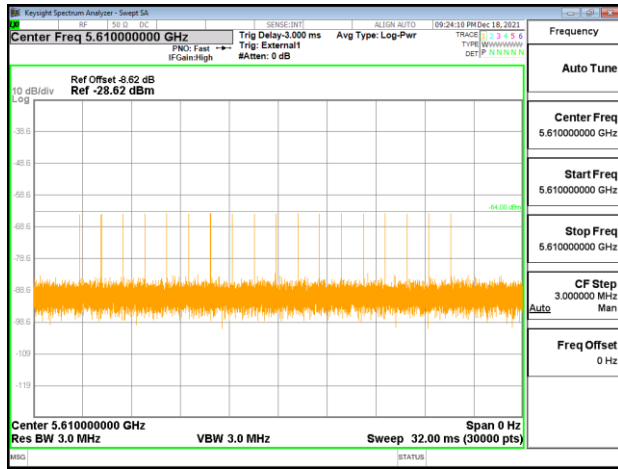

Radars Type 1

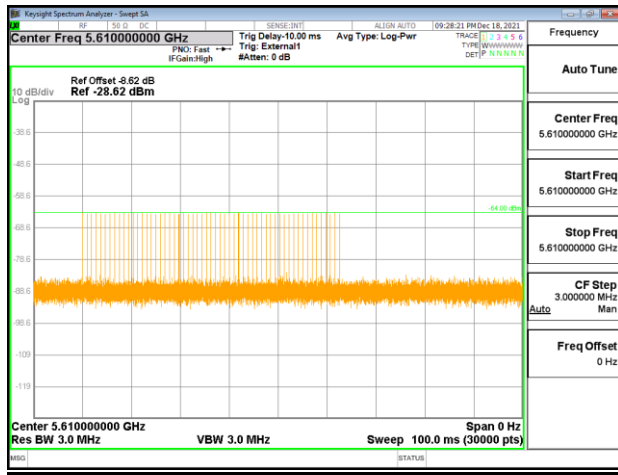

Radars Type 2

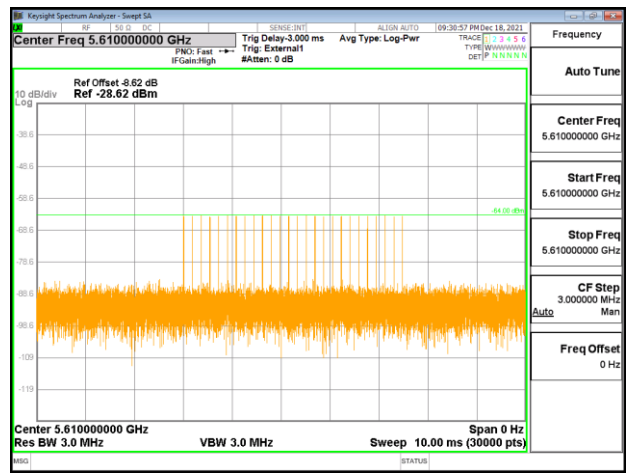



Radars Type 3

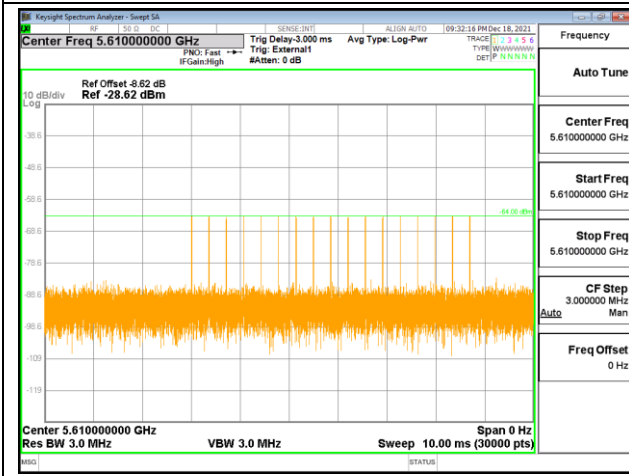

Radars Type 4

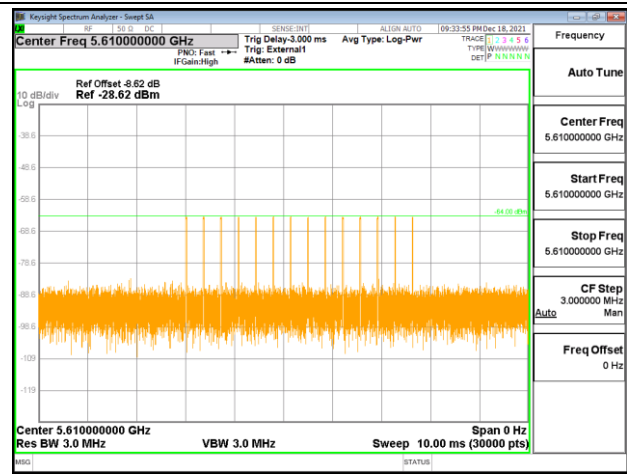

Single Burst of Radar Type 5

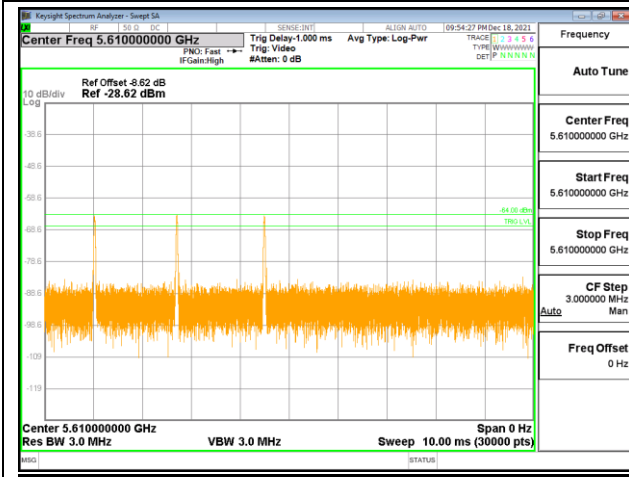

Single Burst of Radar Type 6

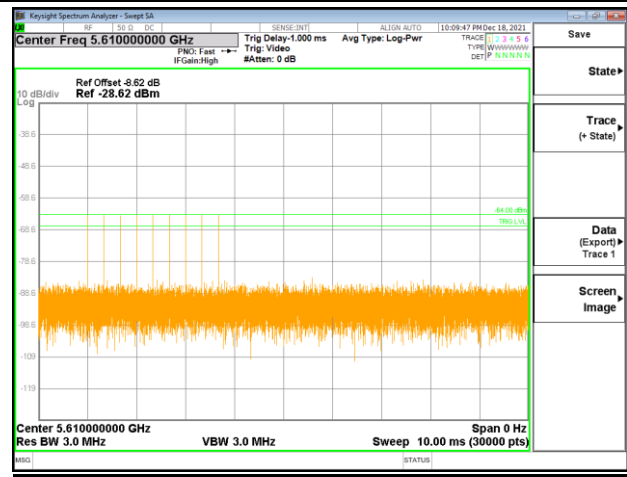



<160MHz / 5570MHz>

Radars Type 0

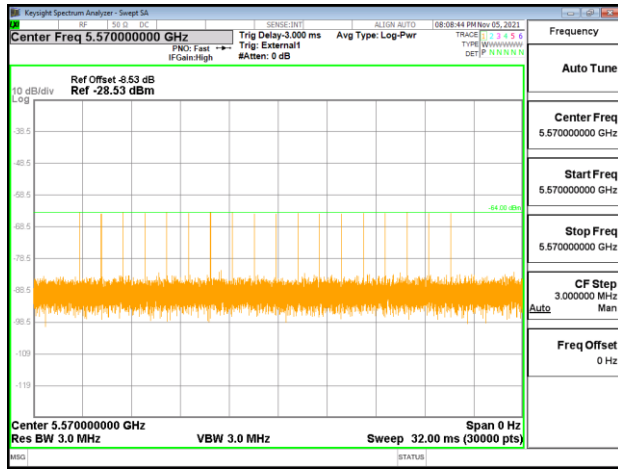

Radars Type 1

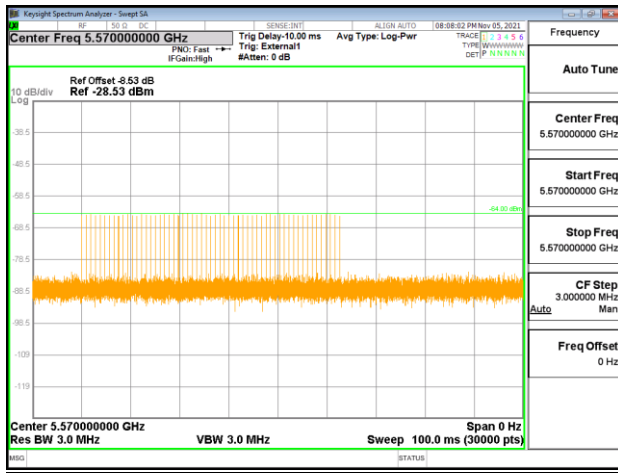

Radars Type 2

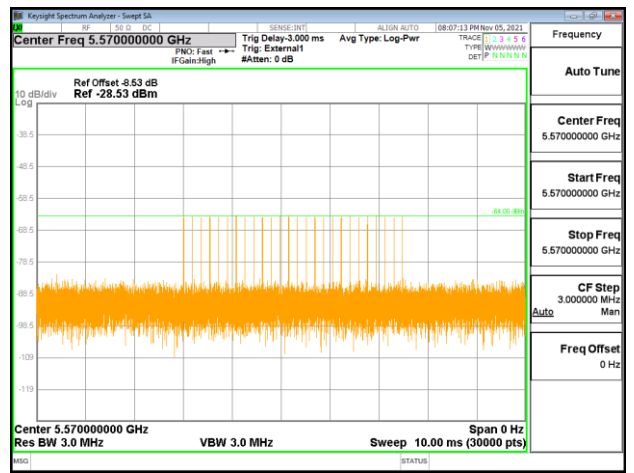



Radars Type 3

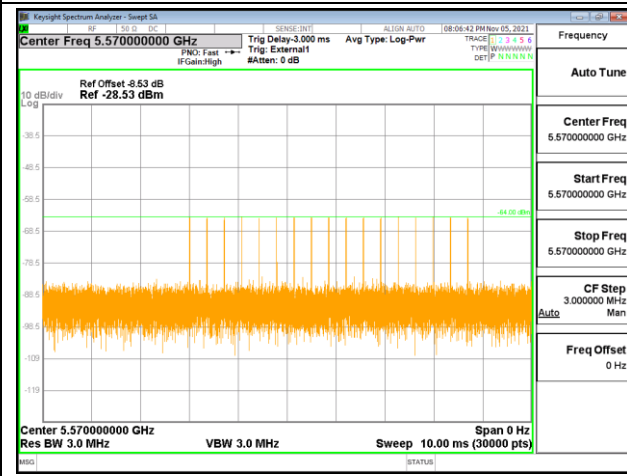

Radars Type 4

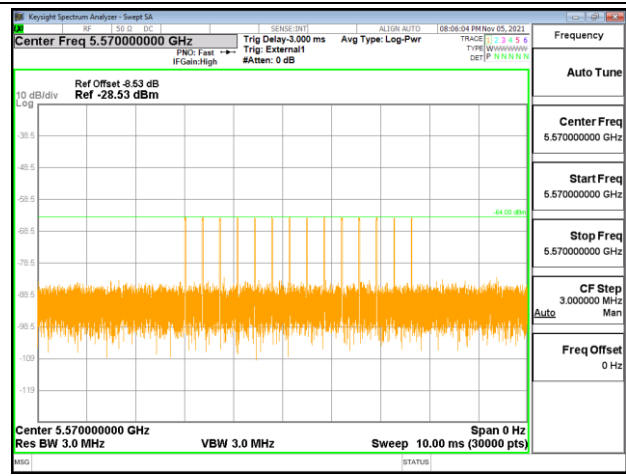

Single Burst of Radar Type 5

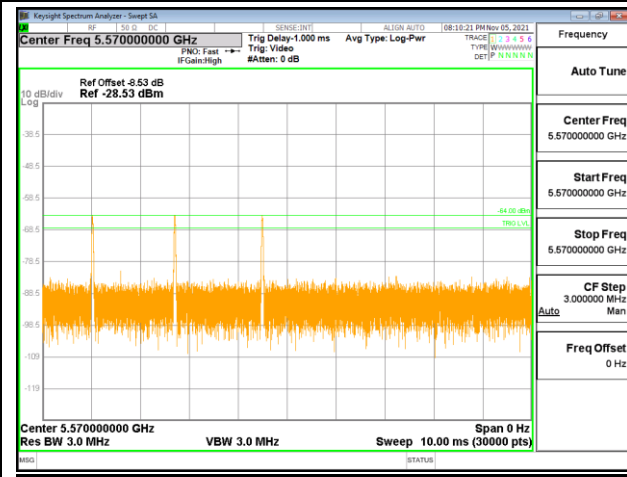

Single Burst of Radar Type 6

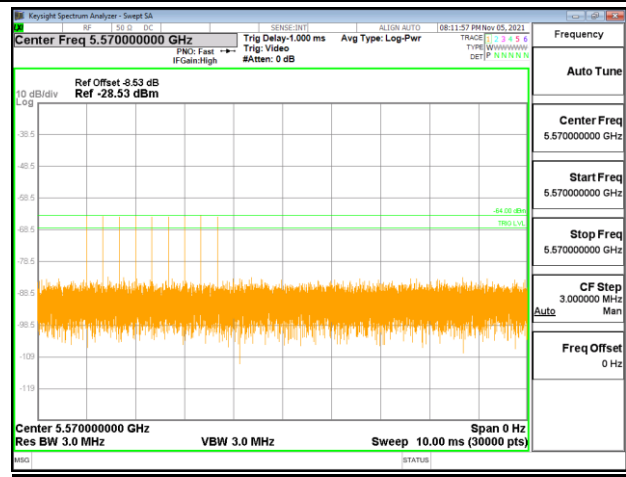



3.2 U-NII Detection Bandwidth

3.2.1 Limit of U-NII Detection Bandwidth

The U-NII Detection Bandwidth shall contain minimum 100% of the 99% power bandwidth. During the U-NII Detection Bandwidth detection test, radar type 0 is used and for each frequency step the minimum percentage of detection is 90%. Measurements are performed with no data traffic.

3.2.2 Test Procedures

- (1) Adjust the equipment to produce a single burst of the Short Pulse Radar Type 0 at the center frequency of the EUT Operating Channel at the specified DFS Detection Threshold level.
- (2) Set the EUT up as a standalone device (no associated Client or Master, as appropriate) and no traffic. Frame based systems will be set to a talk/listen ratio of 0%/100% during this test.
- (3) Generate a single radar burst, and note the response of the EUT. Repeat for a minimum of 10 trials. The EUT must detect the Radar Waveform using the specified U-NII Detection Bandwidth criterion.
- (4) Starting at the center frequency of the EUT operating Channel, increase the radar frequency in 5 MHz steps, repeating the above test sequence, until the detection rate falls below the U-NII Detection Bandwidth criterion specified in report clause 2.3. Repeat this measurement in 1MHz steps at frequencies 5 MHz below where the detection rate begins to fall. Record the highest frequency (denote as F_H) at which detection is greater than or equal to the U-NII Detection Bandwidth criterion. Recording the detection rate at frequencies above F_H is not required to demonstrate compliance.
- (5) Starting at the center frequency of the EUT operating Channel, decrease the radar frequency in 5 MHz steps, repeating the above test sequence, until the detection rate falls below the U-NII Detection Bandwidth criterion specified in report clause 2.3. Repeat this measurement in 1MHz steps at frequencies 5 MHz above where the detection rate begins to fall. Record the lowest frequency (denote as F_L) at which detection is greater than or equal to the U-NII Detection Bandwidth criterion. Recording the detection rate at frequencies below F_L is not required to demonstrate compliance.
- (6) The U-NII Detection Bandwidth is calculated as follows:
U-NII Detection Bandwidth = $F_H - F_L$

3.2.3 Test Setup

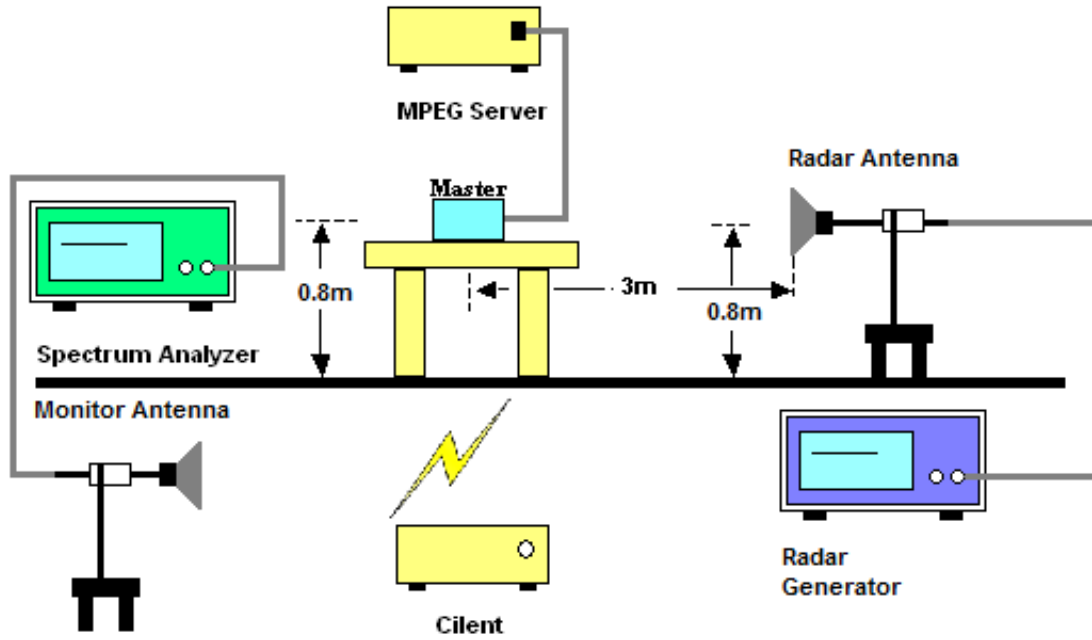

3.2.4 Test Deviation

There is no deviation with the original standard.



3.2.5 Result of U-NII Detection Bandwidth

<Radio 1>

<20MHz / 5300MHz>

Frequency (MHz)	Fc	Trial Number (Detection = Y, No Detection = N)										Rate (%)	F _H /F _L	
		1	2	3	4	5	6	7	8	9	10			
5289	-11	N	N	N	N	N	N	N	N	N	N	N	0%	
5290	-10	Y	Y	Y	Y	Y	Y	Y	Y	Y	Y	Y	100%	F _L
5291	-9	Y	Y	Y	Y	Y	Y	Y	Y	Y	Y	Y	100%	
5292	-8	Y	Y	Y	Y	Y	Y	Y	Y	Y	Y	Y	100%	
5293	-7	Y	Y	Y	Y	Y	Y	Y	Y	Y	Y	Y	100%	
5294	-6	Y	Y	Y	Y	Y	Y	Y	Y	Y	Y	Y	100%	
5295	-5	Y	Y	Y	Y	Y	Y	Y	Y	Y	Y	Y	100%	
5300	0	Y	Y	Y	Y	Y	Y	Y	Y	Y	Y	Y	100%	
5305	+5	Y	Y	Y	Y	Y	Y	Y	Y	Y	Y	Y	100%	
5306	+6	Y	Y	Y	Y	Y	Y	Y	Y	Y	Y	Y	100%	
5307	+7	Y	Y	Y	Y	Y	Y	Y	Y	Y	Y	Y	100%	
5308	+8	Y	Y	Y	Y	Y	Y	Y	Y	Y	Y	Y	100%	
5309	+9	Y	Y	Y	Y	Y	Y	Y	Y	Y	Y	Y	100%	
5310	+10	Y	Y	Y	Y	Y	Y	Y	Y	Y	Y	N	90%	F _H
5311	+11	N	N	N	N	N	N	N	N	N	N	N	0%	

Detection Bandwidth = F_H - F_L = 5310 - 5290 = 20 MHz
 EUT 99% Bandwidth = 19.022 MHz (Refer to channel 60)



<40MHz / 5310MHz>

Frequency (MHz)	Fc	Trial Number (Detection = V, No Detection = N)										Rate (%)	F _H /F _L
		1	2	3	4	5	6	7	8	9	10		
5289	-21	N	N	N	N	N	N	N	N	N	N	0%	
5290	-20	Y	Y	Y	Y	Y	Y	Y	Y	Y	Y	100%	F _L
5291	-19	Y	Y	Y	Y	Y	Y	Y	Y	Y	Y	100%	
5292	-18	Y	Y	Y	Y	Y	Y	Y	Y	Y	Y	100%	
5293	-17	Y	Y	Y	Y	Y	Y	Y	Y	Y	Y	100%	
5294	-16	Y	Y	Y	Y	Y	Y	Y	Y	Y	Y	100%	
5295	-15	Y	Y	Y	Y	Y	Y	Y	Y	Y	Y	100%	
5300	-10	Y	Y	Y	Y	Y	Y	Y	Y	Y	Y	100%	
5305	-5	Y	Y	Y	Y	Y	Y	Y	Y	Y	Y	100%	
5310	0	Y	Y	Y	Y	Y	Y	Y	Y	Y	Y	100%	
5315	+5	Y	Y	Y	Y	Y	Y	Y	Y	Y	Y	100%	
5320	+10	Y	Y	Y	Y	Y	Y	Y	Y	Y	Y	100%	
5325	+15	Y	Y	Y	Y	Y	Y	Y	Y	Y	Y	100%	
5326	+16	Y	Y	Y	Y	Y	Y	Y	Y	Y	Y	100%	
5327	+17	Y	Y	Y	Y	Y	Y	Y	Y	Y	Y	100%	
5328	+18	Y	Y	Y	Y	Y	Y	Y	Y	Y	Y	100%	
5329	+19	Y	Y	Y	Y	Y	Y	Y	Y	Y	Y	100%	
5330	+20	Y	Y	Y	Y	Y	Y	Y	Y	Y	Y	100%	F _H
5331	+21	N	N	N	N	N	N	N	N	N	N	0%	

Detection Bandwidth = F_H – F_L = 5330 – 5290 = 40 MHz
EUT 99% Bandwidth = 36.905 MHz (Refer to channel 62)



<80MHz / 5290MHz>

Frequency (MHz)	Fc	Trial Number (Detection = Y, No Detection = N)										Rate (%)	F _H /F _L
		1	2	3	4	5	6	7	8	9	10		
5250	-40	Y	Y	Y	Y	Y	Y	Y	Y	Y	Y	100%	F _L
5251	-39	Y	Y	Y	Y	Y	Y	Y	Y	Y	Y	100%	
5252	-38	Y	Y	Y	Y	Y	Y	Y	Y	Y	Y	100%	
5253	-37	Y	Y	Y	Y	Y	Y	Y	Y	Y	Y	100%	
5254	-36	Y	Y	Y	Y	Y	Y	Y	Y	Y	Y	100%	
5255	-35	Y	Y	Y	Y	Y	Y	Y	Y	Y	Y	100%	
5260	-30	Y	Y	Y	Y	Y	Y	Y	Y	Y	Y	100%	
5265	-25	Y	Y	Y	Y	Y	Y	Y	Y	Y	Y	100%	
5270	-20	Y	Y	Y	Y	Y	Y	Y	Y	Y	Y	100%	
5275	-15	Y	Y	Y	Y	Y	Y	Y	Y	Y	Y	100%	
5380	-10	Y	Y	Y	Y	Y	Y	Y	Y	Y	Y	100%	
5285	-5	Y	Y	Y	Y	Y	Y	Y	Y	Y	Y	100%	
5290	0	Y	Y	Y	Y	Y	Y	Y	Y	Y	Y	100%	
5295	+5	Y	Y	Y	Y	Y	Y	Y	Y	Y	Y	100%	
5300	+10	Y	Y	Y	Y	Y	Y	Y	Y	Y	Y	100%	
5305	+15	Y	Y	Y	Y	Y	Y	Y	Y	Y	Y	100%	
5310	+20	Y	Y	Y	Y	Y	Y	Y	Y	Y	Y	100%	
5315	+25	Y	Y	Y	Y	Y	Y	Y	Y	Y	Y	100%	
5320	+30	Y	Y	Y	Y	Y	Y	Y	Y	Y	Y	100%	
5325	+35	Y	Y	Y	Y	Y	Y	Y	Y	Y	Y	100%	
5326	+36	Y	Y	Y	Y	Y	Y	Y	Y	Y	Y	100%	
5327	+37	Y	Y	Y	Y	Y	Y	Y	Y	Y	Y	100%	
5328	+38	Y	Y	Y	Y	Y	Y	Y	Y	Y	Y	100%	
5329	+39	Y	Y	Y	Y	Y	Y	Y	Y	Y	Y	100%	
5330	+40	Y	Y	Y	Y	Y	Y	Y	Y	Y	Y	100%	F _H
5331	+41	N	N	N	N	N	N	N	N	N	N	0%	

Detection Bandwidth = F_H – F_L = 5330 – 5250 = 80 MHz

EUT 99% Bandwidth = 76.870 MHz (Refer to channel 58)



< 80+80MHz / 5290MHz >

Frequency (MHz)	Fc	Trial Number (Detection = V, No Detection = N)										Rate (%)	F _H /F _L
		1	2	3	4	5	6	7	8	9	10		
5250	0	Y	Y	Y	Y	Y	Y	Y	Y	Y	Y	100%	F _L
5255	+5	Y	Y	Y	Y	Y	Y	Y	Y	Y	Y	100%	
5260	+10	Y	Y	Y	Y	Y	Y	Y	Y	Y	Y	100%	
5265	+15	Y	Y	Y	Y	Y	Y	Y	Y	Y	Y	100%	
5270	+20	Y	Y	Y	Y	Y	Y	Y	Y	Y	Y	100%	
5275	+25	Y	Y	Y	Y	Y	Y	Y	Y	Y	Y	100%	
5280	+30	Y	Y	Y	Y	Y	Y	Y	Y	Y	Y	100%	
5285	+35	Y	Y	Y	Y	Y	Y	Y	Y	Y	Y	100%	
5290	+40	Y	Y	Y	Y	Y	Y	Y	Y	Y	Y	100%	
5295	+45	Y	Y	Y	Y	Y	Y	Y	Y	Y	Y	100%	
5300	+50	Y	Y	Y	Y	Y	Y	Y	Y	Y	Y	100%	
5305	+55	Y	Y	Y	Y	Y	Y	Y	Y	Y	Y	100%	
5310	+60	Y	Y	Y	Y	Y	Y	Y	Y	Y	Y	100%	
5315	+65	Y	Y	Y	Y	Y	Y	Y	Y	Y	Y	100%	
5320	+70	Y	Y	Y	Y	Y	Y	Y	Y	Y	Y	100%	
5325	+75	Y	Y	Y	Y	Y	Y	Y	Y	Y	Y	100%	
5326	+76	Y	Y	Y	Y	Y	Y	Y	Y	Y	Y	100%	
5327	+77	Y	Y	Y	Y	Y	Y	Y	Y	Y	Y	100%	
5328	+78	Y	Y	Y	Y	Y	Y	Y	Y	Y	Y	100%	
5329	+79	Y	Y	Y	Y	Y	Y	Y	Y	Y	Y	100%	
5330	+80	Y	Y	Y	Y	Y	Y	Y	Y	Y	Y	100%	F _H
5331	+81	N	N	N	N	N	N	N	N	N	N	0%	

Detection Bandwidth = F_H - F_L = 5330 - 5250 = 80 MHz

EUT 99% Bandwidth = 76.870 MHz (Refer to upper 80MHz of channel 42+58)



<Radio 2>

<20MHz / 5300MHz>

Frequency (MHz)	Fc	Trial Number (Detection = Y, No Detection = N)										Rate (%)	F _H /F _L
		1	2	3	4	5	6	7	8	9	10		
5289	-11	N	N	N	N	N	N	N	N	N	N	0%	
5290	-10	Y	Y	Y	Y	Y	Y	Y	Y	Y	Y	100%	F _L
5291	-9	Y	Y	Y	Y	Y	Y	Y	Y	Y	Y	100%	
5292	-8	Y	Y	Y	Y	Y	Y	Y	Y	Y	Y	100%	
5293	-7	Y	Y	Y	Y	Y	Y	Y	Y	Y	Y	100%	
5294	-6	Y	Y	Y	Y	Y	Y	Y	Y	Y	Y	100%	
5295	-5	Y	Y	Y	Y	Y	Y	Y	Y	Y	Y	100%	
5300	0	Y	Y	Y	Y	Y	Y	Y	Y	Y	Y	100%	
5305	+5	Y	Y	Y	Y	Y	Y	Y	Y	Y	Y	100%	
5306	+6	Y	Y	Y	Y	Y	Y	Y	Y	Y	Y	100%	
5307	+7	Y	Y	Y	Y	Y	Y	Y	Y	Y	Y	100%	
5308	+8	Y	Y	Y	Y	Y	Y	Y	Y	Y	Y	100%	
5309	+9	Y	Y	Y	Y	Y	Y	Y	Y	Y	Y	100%	
5310	+10	Y	Y	Y	Y	Y	Y	Y	Y	Y	Y	100%	F _H
5311	+11	N	N	N	N	N	N	N	N	N	N	0%	
Detection Bandwidth = F _H – F _L = 5310 – 5290 = 20 MHz EUT 99% Bandwidth = 19.188 MHz (Refer to channel 60)													



<40MHz / 5310MHz>

Frequency (MHz)	Fc	Trial Number (Detection = V, No Detection = N)										Rate (%)	F _H /F _L
		1	2	3	4	5	6	7	8	9	10		
5289	-21	N	N	N	N	N	N	N	N	N	N	0%	
5290	-20	Y	Y	Y	Y	Y	Y	Y	Y	Y	Y	100%	F _L
5291	-19	Y	Y	Y	Y	Y	Y	Y	Y	Y	Y	100%	
5292	-18	Y	Y	Y	Y	Y	Y	Y	Y	Y	Y	100%	
5293	-17	Y	Y	Y	Y	Y	Y	Y	Y	Y	Y	100%	
5294	-16	Y	Y	Y	Y	Y	Y	Y	Y	Y	Y	100%	
5295	-15	Y	Y	Y	Y	Y	Y	Y	Y	Y	Y	100%	
5300	-10	Y	Y	Y	Y	Y	Y	Y	Y	Y	Y	100%	
5305	-5	Y	Y	Y	Y	Y	Y	Y	Y	Y	Y	100%	
5310	0	Y	Y	Y	Y	Y	Y	Y	Y	Y	Y	100%	
5315	+5	Y	Y	Y	Y	Y	Y	Y	Y	Y	Y	100%	
5320	+10	Y	Y	Y	Y	Y	Y	Y	Y	Y	Y	100%	
5325	+15	Y	Y	Y	Y	Y	Y	Y	Y	Y	Y	100%	
5326	+16	Y	Y	Y	Y	Y	Y	Y	Y	Y	Y	100%	
5327	+17	Y	Y	Y	Y	Y	Y	Y	Y	Y	Y	100%	
5328	+18	Y	Y	Y	Y	Y	Y	Y	Y	Y	Y	100%	
5329	+19	Y	Y	Y	Y	Y	Y	Y	Y	Y	Y	100%	
5330	+20	Y	Y	Y	Y	Y	Y	Y	Y	Y	Y	100%	F _H
5331	+21	N	N	N	N	N	N	N	N	N	N	0%	

Detection Bandwidth = F_H – F_L = 5330 – 5290 = 40 MHz
EUT 99% Bandwidth = 37.696 MHz (Refer to channel 62)



<80MHz / 5290MHz>

Frequency (MHz)	Fc	Trial Number (Detection = V, No Detection = N)										Rate (%)	F _H /F _L
		1	2	3	4	5	6	7	8	9	10		
5250	-40	Y	Y	Y	Y	Y	Y	Y	Y	Y	Y	100%	F _L
5251	-39	Y	Y	Y	Y	Y	Y	Y	Y	Y	Y	100%	
5252	-38	Y	Y	Y	Y	Y	Y	Y	Y	Y	Y	100%	
5253	-37	Y	Y	Y	Y	Y	Y	Y	Y	Y	Y	100%	
5254	-36	Y	Y	Y	Y	Y	Y	Y	Y	Y	Y	100%	
5255	-35	Y	Y	Y	Y	Y	Y	Y	Y	Y	Y	100%	
5260	-30	Y	Y	Y	Y	Y	Y	Y	Y	Y	Y	100%	
5265	-25	Y	Y	Y	Y	Y	Y	Y	Y	Y	Y	100%	
5270	-20	Y	Y	Y	Y	Y	Y	Y	Y	Y	Y	100%	
5275	-15	Y	Y	Y	Y	Y	Y	Y	Y	Y	Y	100%	
5380	-10	Y	Y	Y	Y	Y	Y	Y	Y	Y	Y	100%	
5285	-5	Y	Y	Y	Y	Y	Y	Y	Y	Y	Y	100%	
5290	0	Y	Y	Y	Y	Y	Y	Y	Y	Y	Y	100%	
5295	+5	Y	Y	Y	Y	Y	Y	Y	Y	Y	Y	100%	
5300	+10	Y	Y	Y	Y	Y	Y	Y	Y	Y	Y	100%	
5305	+15	Y	Y	Y	Y	Y	Y	Y	Y	Y	Y	100%	
5310	+20	Y	Y	Y	Y	Y	Y	Y	Y	Y	Y	100%	
5315	+25	Y	Y	Y	Y	Y	Y	Y	Y	Y	Y	100%	
5320	+30	Y	Y	Y	Y	Y	Y	Y	Y	Y	Y	100%	
5325	+35	Y	Y	Y	Y	Y	Y	Y	Y	Y	Y	100%	
5326	+36	Y	Y	Y	Y	Y	Y	Y	Y	Y	Y	100%	
5327	+37	Y	Y	Y	Y	Y	Y	Y	Y	Y	Y	100%	
5328	+38	Y	Y	Y	Y	Y	Y	Y	Y	Y	Y	100%	
5329	+39	Y	Y	Y	Y	Y	Y	Y	Y	Y	Y	100%	
5330	+40	Y	Y	Y	Y	Y	Y	Y	Y	Y	Y	100%	F _H
5331	+41	N	N	N	N	N	N	N	N	N	N	0%	

Detection Bandwidth = F_H – F_L = 5330 – 5250 = 80 MHz

EUT 99% Bandwidth = 77.067 MHz (Refer to channel 58)



< 80+80MHz / 5290MHz >

Frequency (MHz)	Fc	Trial Number (Detection = V, No Detection = N)										Rate (%)	F _H /F _L
		1	2	3	4	5	6	7	8	9	10		
5250	0	Y	Y	Y	Y	Y	Y	Y	Y	Y	Y	100%	F _L
5255	+5	Y	Y	Y	Y	Y	Y	Y	Y	Y	Y	100%	
5260	+10	Y	Y	Y	Y	Y	Y	Y	Y	Y	Y	100%	
5265	+15	Y	Y	Y	Y	Y	Y	Y	Y	Y	Y	100%	
5270	+20	Y	Y	Y	Y	Y	Y	Y	Y	Y	Y	100%	
5275	+25	Y	Y	Y	Y	Y	Y	Y	Y	Y	Y	100%	
5280	+30	Y	Y	Y	Y	Y	Y	Y	Y	Y	Y	100%	
5285	+35	Y	Y	Y	Y	Y	Y	Y	Y	Y	Y	100%	
5290	+40	Y	Y	Y	Y	Y	Y	Y	Y	Y	Y	100%	
5295	+45	Y	Y	Y	Y	Y	Y	Y	Y	Y	Y	100%	
5300	+50	Y	Y	Y	Y	Y	Y	Y	Y	Y	Y	100%	
5305	+55	Y	Y	Y	Y	Y	Y	Y	Y	Y	Y	100%	
5310	+60	Y	Y	Y	Y	Y	Y	Y	Y	Y	Y	100%	
5315	+65	Y	Y	Y	Y	Y	Y	Y	Y	Y	Y	100%	
5320	+70	Y	Y	Y	Y	Y	Y	Y	Y	Y	Y	100%	
5325	+75	Y	Y	Y	Y	Y	Y	Y	Y	Y	Y	100%	
5326	+76	Y	Y	Y	Y	Y	Y	Y	Y	Y	Y	100%	
5327	+77	Y	Y	Y	Y	Y	Y	Y	Y	Y	Y	100%	
5328	+78	Y	Y	Y	Y	Y	Y	Y	Y	Y	Y	100%	
5329	+79	Y	Y	Y	Y	Y	Y	Y	Y	Y	Y	100%	
5330	+80	Y	Y	Y	Y	Y	Y	Y	Y	Y	Y	100%	F _H
5331	+81	N	N	N	N	N	N	N	N	N	N	0%	

Detection Bandwidth = F_H - F_L = 5330 - 5250 = 80 MHz

EUT 99% Bandwidth = 77.067 MHz (Refer to upper 80MHz of channel 42+58)



<20MHz / 5500MHz>

Frequency (MHz)	Fc	Trial Number (Detection = Y, No Detection = N)										Rate (%)	F _H /F _L
		1	2	3	4	5	6	7	8	9	10		
5489	-11	N	N	N	N	N	N	N	N	N	N	0%	
5490	-10	Y	Y	Y	Y	Y	Y	Y	Y	Y	Y	100%	F _L
5491	-9	Y	Y	Y	Y	Y	Y	Y	Y	Y	Y	100%	
5492	-8	Y	Y	Y	Y	Y	Y	Y	Y	Y	Y	100%	
5493	-7	Y	Y	Y	Y	Y	Y	Y	Y	Y	Y	100%	
5494	-6	Y	Y	Y	Y	Y	Y	Y	Y	Y	Y	100%	
5495	-5	Y	Y	Y	Y	Y	Y	Y	Y	Y	Y	100%	
5500	0	Y	Y	Y	Y	Y	Y	Y	Y	Y	Y	100%	
5505	+5	Y	Y	Y	Y	Y	Y	Y	Y	Y	Y	100%	
5506	+6	Y	Y	Y	Y	Y	Y	Y	Y	Y	Y	100%	
5507	+7	Y	Y	Y	Y	Y	Y	Y	Y	Y	Y	100%	
5508	+8	Y	Y	Y	Y	Y	Y	Y	Y	Y	Y	100%	
5509	+9	Y	Y	Y	Y	Y	Y	Y	Y	Y	Y	100%	
5510	+10	Y	Y	Y	Y	Y	Y	Y	Y	Y	Y	100%	F _H
5511	+11	N	N	N	N	N	N	N	N	N	N	0%	

Detection Bandwidth = F_H - F_L = 5510 - 5490 = 20 MHz
EUT 99% Bandwidth = 18.986 MHz (Refer to channel 100)



<40MHz / 5510MHz>

Frequency (MHz)	Fc	Trial Number (Detection = V, No Detection = N)										Rate (%)	F _H /F _L
		1	2	3	4	5	6	7	8	9	10		
5489	-21	N	N	N	N	N	N	N	N	N	N	0%	
5490	-20	Y	Y	Y	Y	Y	Y	Y	Y	Y	Y	100%	F _L
5491	-19	Y	Y	Y	Y	Y	Y	Y	Y	Y	Y	100%	
5492	-18	Y	Y	Y	Y	Y	Y	Y	Y	Y	Y	100%	
5493	-17	Y	Y	Y	Y	Y	Y	Y	Y	Y	Y	100%	
5494	-16	Y	Y	Y	Y	Y	Y	Y	Y	Y	Y	100%	
5495	-15	Y	Y	Y	Y	Y	Y	Y	Y	Y	Y	100%	
5500	-10	Y	Y	Y	Y	Y	Y	Y	Y	Y	Y	100%	
5505	-5	Y	Y	Y	Y	Y	Y	Y	Y	Y	Y	100%	
5510	0	Y	Y	Y	Y	Y	Y	Y	Y	Y	Y	100%	
5515	+5	Y	Y	Y	Y	Y	Y	Y	Y	Y	Y	100%	
5520	+10	Y	Y	Y	Y	Y	Y	Y	Y	Y	Y	100%	
5525	+15	Y	Y	Y	Y	Y	Y	Y	Y	Y	Y	100%	
5526	+16	Y	Y	Y	Y	Y	Y	Y	Y	Y	Y	100%	
5527	+17	Y	Y	Y	Y	Y	Y	Y	Y	Y	Y	100%	
5528	+18	Y	Y	Y	Y	Y	Y	Y	Y	Y	Y	100%	
5529	+19	Y	Y	Y	Y	Y	Y	Y	Y	Y	Y	100%	
5530	+20	Y	Y	Y	Y	Y	Y	Y	Y	Y	Y	100%	F _H
5531	+21	N	N	N	N	N	N	N	N	N	N	0%	

Detection Bandwidth = F_H – F_L = 5530 – 5490 = 40 MHz
EUT 99% Bandwidth = 37.932 MHz (Refer to channel 102)



<80MHz / 5530MHz>

Frequency (MHz)	Fc	Trial Number (Detection = V, No Detection = N)										Rate (%)	F _H /F _L
		1	2	3	4	5	6	7	8	9	10		
5489	-41	N	N	N	N	N	N	N	N	N	N	0%	
5490	-40	Y	Y	Y	Y	Y	Y	Y	Y	Y	Y	100%	F _L
5491	-39	Y	Y	Y	Y	Y	Y	Y	Y	Y	Y	100%	
5492	-38	Y	Y	Y	Y	Y	Y	Y	Y	Y	Y	100%	
5493	-37	Y	Y	Y	Y	Y	Y	Y	Y	Y	Y	100%	
5494	-36	Y	Y	Y	Y	Y	Y	Y	Y	Y	Y	100%	
5495	-35	Y	Y	Y	Y	Y	Y	Y	Y	Y	Y	100%	
5500	-30	Y	Y	Y	Y	Y	Y	Y	Y	Y	Y	100%	
5505	-25	Y	Y	Y	Y	Y	Y	Y	Y	Y	Y	100%	
5510	-20	Y	Y	Y	Y	Y	Y	Y	Y	Y	Y	100%	
5515	-15	Y	Y	Y	Y	Y	Y	Y	Y	Y	Y	100%	
5520	-10	Y	Y	Y	Y	Y	Y	Y	Y	Y	Y	100%	
5525	-5	Y	Y	Y	Y	Y	Y	Y	Y	Y	Y	100%	
5530	0	Y	Y	Y	Y	Y	Y	Y	Y	Y	Y	100%	
5535	+5	Y	Y	Y	Y	Y	Y	Y	Y	Y	Y	100%	
5540	+10	Y	Y	Y	Y	Y	Y	Y	Y	Y	Y	100%	
5545	+15	Y	Y	Y	Y	Y	Y	Y	Y	Y	Y	100%	
5550	+20	Y	Y	Y	Y	Y	Y	Y	Y	Y	Y	100%	
5555	+25	Y	Y	Y	Y	Y	Y	Y	Y	Y	Y	100%	
5560	+30	Y	Y	Y	Y	Y	Y	Y	Y	Y	Y	100%	
5565	+35	Y	Y	Y	Y	Y	Y	Y	Y	Y	Y	100%	
5566	+36	Y	Y	Y	Y	Y	Y	Y	Y	Y	Y	100%	
5567	+37	Y	Y	Y	Y	Y	Y	Y	Y	Y	Y	100%	
5568	+38	Y	Y	Y	Y	Y	Y	Y	Y	Y	Y	100%	
5569	+39	Y	Y	Y	Y	Y	Y	Y	Y	Y	Y	100%	
5570	+40	Y	Y	Y	Y	Y	Y	Y	Y	Y	Y	100%	F _H
5571	+41	N	N	N	N	N	N	N	N	N	N	0%	

Detection Bandwidth = F_H – F_L = 5570 – 5490 = 80 MHz
EUT 99% Bandwidth = 77.327 MHz (Refer to channel 106)



< 80+80MHz / 5530MHz >

Frequency (MHz)	Fc	Trial Number (Detection = V, No Detection = N)										Rate (%)	F _H /F _L
		1	2	3	4	5	6	7	8	9	10		
5489	-41	N	N	N	N	N	N	N	N	N	N	0%	
5490	-40	Y	Y	Y	Y	Y	Y	Y	Y	Y	Y	100%	F _L
5491	-39	Y	Y	Y	Y	Y	Y	Y	Y	Y	Y	100%	
5492	-38	Y	Y	Y	Y	Y	Y	Y	Y	Y	Y	100%	
5493	-37	Y	Y	Y	Y	Y	Y	Y	Y	Y	Y	100%	
5494	-36	Y	Y	Y	Y	Y	Y	Y	Y	Y	Y	100%	
5495	-35	Y	Y	Y	Y	Y	Y	Y	Y	Y	Y	100%	
5500	-30	Y	Y	Y	Y	Y	Y	Y	Y	Y	Y	100%	
5505	-25	Y	Y	Y	Y	Y	Y	Y	Y	Y	Y	100%	
5510	-20	Y	Y	Y	Y	Y	Y	Y	Y	Y	Y	100%	
5515	-15	Y	Y	Y	Y	Y	Y	Y	Y	Y	Y	100%	
5520	-10	Y	Y	Y	Y	Y	Y	Y	Y	Y	Y	100%	
5525	-5	Y	Y	Y	Y	Y	Y	Y	Y	Y	Y	100%	
5530	0	Y	Y	Y	Y	Y	Y	Y	Y	Y	Y	100%	
5535	+5	Y	Y	Y	Y	Y	Y	Y	Y	Y	Y	100%	
5540	+10	Y	Y	Y	Y	Y	Y	Y	Y	Y	Y	100%	
5545	+15	Y	Y	Y	Y	Y	Y	Y	Y	Y	Y	100%	
5550	+20	Y	Y	Y	Y	Y	Y	Y	Y	Y	Y	100%	
5555	+25	Y	Y	Y	Y	Y	Y	Y	Y	Y	Y	100%	
5560	+30	Y	Y	Y	Y	Y	Y	Y	Y	Y	Y	100%	
5565	+35	Y	Y	Y	Y	Y	Y	Y	Y	Y	Y	100%	
5566	+36	Y	Y	Y	Y	Y	Y	Y	Y	Y	Y	100%	
5567	+37	Y	Y	Y	Y	Y	Y	Y	Y	Y	Y	100%	
5568	+38	Y	Y	Y	Y	Y	Y	Y	Y	Y	Y	100%	
5569	+39	Y	Y	Y	Y	Y	Y	Y	Y	Y	Y	100%	F _H
5570	+40	N	N	N	N	N	N	N	N	N	N	100%	
5571	+41	N	N	N	N	N	N	N	N	N	N	0%	

Detection Bandwidth = F_H – F_L = 5569 – 5490 = 79 MHz
EUT 99% Bandwidth = 77.327 MHz (Refer to lower 80Mhz of channel 106+122)



< 80+80MHz / 5610MHz >

Frequency (MHz)	Fc	Trial Number (Detection = Y, No Detection = N)										Rate (%)	F _H /F _L
		1	2	3	4	5	6	7	8	9	10		
5569	-41	N	N	N	N	N	N	N	N	N	N	0%	
5570	-40	Y	Y	Y	Y	Y	Y	Y	Y	Y	Y	100%	F _L
5571	-39	Y	Y	Y	Y	Y	Y	Y	Y	Y	Y	100%	
5572	-38	Y	Y	Y	Y	Y	Y	Y	Y	Y	Y	100%	
5573	-37	Y	Y	Y	Y	Y	Y	Y	Y	Y	Y	100%	
5574	-36	Y	Y	Y	Y	Y	Y	Y	Y	Y	Y	100%	
5575	-35	Y	Y	Y	Y	Y	Y	Y	Y	Y	Y	100%	
5580	-30	Y	Y	Y	Y	Y	Y	Y	Y	Y	Y	100%	
5585	-25	Y	Y	Y	Y	Y	Y	Y	Y	Y	Y	100%	
5590	-20	Y	Y	Y	Y	Y	Y	Y	Y	Y	Y	100%	
5595	-15	Y	Y	Y	Y	Y	Y	Y	Y	Y	Y	100%	
5600	-10	Y	Y	Y	Y	Y	Y	Y	Y	Y	Y	100%	
5605	-5	Y	Y	Y	Y	Y	Y	Y	Y	Y	Y	100%	
5610	0	Y	Y	Y	Y	Y	Y	Y	Y	Y	Y	100%	
5615	+5	Y	Y	Y	Y	Y	Y	Y	Y	Y	Y	100%	
5620	+10	Y	Y	Y	Y	Y	Y	Y	Y	Y	Y	100%	
5625	+15	Y	Y	Y	Y	Y	Y	Y	Y	Y	Y	100%	
5630	+20	Y	Y	Y	Y	Y	Y	Y	Y	Y	Y	100%	
5635	+25	Y	Y	Y	Y	Y	Y	Y	Y	Y	Y	100%	
5640	+30	Y	Y	Y	Y	Y	Y	Y	Y	Y	Y	100%	
5645	+35	Y	Y	Y	Y	Y	Y	Y	Y	Y	Y	100%	
5646	+36	Y	Y	Y	Y	Y	Y	Y	Y	Y	Y	100%	
5647	+37	Y	Y	Y	Y	Y	Y	Y	Y	Y	Y	100%	
5648	+38	Y	Y	Y	Y	Y	Y	Y	Y	Y	Y	100%	
5649	+39	Y	Y	Y	Y	Y	Y	Y	Y	Y	Y	100%	
5650	+40	Y	Y	Y	Y	Y	Y	Y	Y	Y	Y	100%	F _H
5651	+41	N	N	N	N	N	N	N	N	N	N	0%	

Detection Bandwidth = F_H – F_L = 5650 – 5570 = 80 MHz
EUT 99% Bandwidth = 77.283 MHz (Refer to upper 80MHz of channel 106+122)



<Radio 3>

<20MHz / 5500MHz>

Frequency (MHz)	Fc	Trial Number (Detection = Y, No Detection = N)										Rate (%)	F _H /F _L
		1	2	3	4	5	6	7	8	9	10		
5489	-11	N	N	N	N	N	N	N	N	N	N	0%	
5490	-10	Y	Y	Y	Y	Y	Y	Y	Y	Y	Y	100%	F _L
5491	-9	Y	Y	Y	Y	Y	Y	Y	Y	Y	Y	100%	
5492	-8	Y	Y	Y	Y	Y	Y	Y	Y	Y	Y	100%	
5493	-7	Y	Y	Y	Y	Y	Y	Y	Y	Y	Y	100%	
5494	-6	Y	Y	Y	Y	Y	Y	Y	Y	Y	Y	100%	
5495	-5	Y	Y	Y	Y	Y	Y	Y	Y	Y	Y	100%	
5500	0	Y	Y	Y	Y	Y	Y	Y	Y	Y	Y	100%	
5505	+5	Y	Y	Y	Y	Y	Y	Y	Y	Y	Y	100%	
5506	+6	Y	Y	Y	Y	Y	Y	Y	Y	Y	Y	100%	
5507	+7	Y	Y	Y	Y	Y	Y	Y	Y	Y	Y	100%	
5508	+8	Y	Y	Y	Y	Y	Y	Y	Y	Y	Y	100%	
5509	+9	Y	Y	Y	Y	Y	Y	Y	Y	Y	Y	100%	
5510	+10	Y	Y	Y	Y	Y	Y	Y	Y	Y	Y	100%	F _H
5511	+11	N	N	N	N	N	N	N	N	N	N	0%	
Detection Bandwidth = F _H – F _L = 5510 – 5490 = 20 MHz EUT 99% Bandwidth = 19.080 MHz (Refer to channel 100)													



<40MHz / 5510MHz>

Frequency (MHz)	Fc	Trial Number (Detection = V, No Detection = N)										Rate (%)	F _H /F _L
		1	2	3	4	5	6	7	8	9	10		
5489	-21	N	N	N	N	N	N	N	N	N	N	0%	
5490	-20	Y	Y	Y	Y	Y	Y	Y	Y	Y	Y	100%	F _L
5491	-19	Y	Y	Y	Y	Y	Y	Y	Y	Y	Y	100%	
5492	-18	Y	Y	Y	Y	Y	Y	Y	Y	Y	Y	100%	
5493	-17	Y	Y	Y	Y	Y	Y	Y	Y	Y	Y	100%	
5494	-16	Y	Y	Y	Y	Y	Y	Y	Y	Y	Y	100%	
5495	-15	Y	Y	Y	Y	Y	Y	Y	Y	Y	Y	100%	
5500	-10	Y	Y	Y	Y	Y	Y	Y	Y	Y	Y	100%	
5505	-5	Y	Y	Y	Y	Y	Y	Y	Y	Y	Y	100%	
5510	0	Y	Y	Y	Y	Y	Y	Y	Y	Y	Y	100%	
5515	+5	Y	Y	Y	Y	Y	Y	Y	Y	Y	Y	100%	
5520	+10	Y	Y	Y	Y	Y	Y	Y	Y	Y	Y	100%	
5525	+15	Y	Y	Y	Y	Y	Y	Y	Y	Y	Y	100%	
5526	+16	Y	Y	Y	Y	Y	Y	Y	Y	Y	Y	100%	
5527	+17	Y	Y	Y	Y	Y	Y	Y	Y	Y	Y	100%	
5528	+18	Y	Y	Y	Y	Y	Y	Y	Y	Y	Y	100%	
5529	+19	Y	Y	Y	Y	Y	Y	Y	Y	Y	Y	100%	
5530	+20	Y	Y	Y	Y	Y	Y	Y	Y	Y	Y	100%	F _H
5531	+21	N	N	N	N	N	N	N	N	N	N	0%	

Detection Bandwidth = F_H – F_L = 5530 – 5490 = 40 MHz
EUT 99% Bandwidth = 37.664 MHz (Refer to channel 102)



<80MHz / 5530MHz>

Frequency (MHz)	Fc	Trial Number (Detection = V, No Detection = N)										Rate (%)	F _H /F _L
		1	2	3	4	5	6	7	8	9	10		
5489	-41	N	N	N	N	N	N	N	N	N	N	0%	
5490	-40	Y	Y	Y	Y	Y	Y	Y	Y	Y	Y	100%	F _L
5491	-39	Y	Y	Y	Y	Y	Y	Y	Y	Y	Y	100%	
5492	-38	Y	Y	Y	Y	Y	Y	Y	Y	Y	Y	100%	
5493	-37	Y	Y	Y	Y	Y	Y	Y	Y	Y	Y	100%	
5494	-36	Y	Y	Y	Y	Y	Y	Y	Y	Y	Y	100%	
5495	-35	Y	Y	Y	Y	Y	Y	Y	Y	Y	Y	100%	
5500	-30	Y	Y	Y	Y	Y	Y	Y	Y	Y	Y	100%	
5505	-25	Y	Y	Y	Y	Y	Y	Y	Y	Y	Y	100%	
5510	-20	Y	Y	Y	Y	Y	Y	Y	Y	Y	Y	100%	
5515	-15	Y	Y	Y	Y	Y	Y	Y	Y	Y	Y	100%	
5520	-10	Y	Y	Y	Y	Y	Y	Y	Y	Y	Y	100%	
5525	-5	Y	Y	Y	Y	Y	Y	Y	Y	Y	Y	100%	
5530	0	Y	Y	Y	Y	Y	Y	Y	Y	Y	Y	100%	
5535	+5	Y	Y	Y	Y	Y	Y	Y	Y	Y	Y	100%	
5540	+10	Y	Y	Y	Y	Y	Y	Y	Y	Y	Y	100%	
5545	+15	Y	Y	Y	Y	Y	Y	Y	Y	Y	Y	100%	
5550	+20	Y	Y	Y	Y	Y	Y	Y	Y	Y	Y	100%	
5555	+25	Y	Y	Y	Y	Y	Y	Y	Y	Y	Y	100%	
5560	+30	Y	Y	Y	Y	Y	Y	Y	Y	Y	Y	100%	
5565	+35	Y	Y	Y	Y	Y	Y	Y	Y	Y	Y	100%	
5566	+36	Y	Y	Y	Y	Y	Y	Y	Y	Y	Y	100%	
5567	+37	Y	Y	Y	Y	Y	Y	Y	Y	Y	Y	100%	
5568	+38	Y	Y	Y	Y	Y	Y	Y	Y	Y	Y	100%	
5569	+39	Y	Y	Y	Y	Y	Y	Y	Y	Y	Y	100%	
5570	+40	Y	Y	Y	Y	Y	Y	Y	Y	Y	Y	100%	F _H
5571	+41	N	N	N	N	N	N	N	N	N	N	0%	

Detection Bandwidth = F_H – F_L = 5570 – 5490 = 80 MHz
EUT 99% Bandwidth = 76.685 MHz (Refer to channel 106)



<160MHz / 5570MHz>

Frequency (MHz)	Fc	Trial Number (Detection = V, No Detection = N)										Rate (%)	F _H /F _L
		1	2	3	4	5	6	7	8	9	10		
5489	-81	N	N	N	N	N	N	N	N	N	N	0%	
5490	-80	Y	Y	Y	Y	Y	Y	Y	Y	Y	Y	100%	F _L
5491	-79	Y	Y	Y	Y	Y	Y	Y	Y	Y	Y	100%	
5492	-78	Y	Y	Y	Y	Y	Y	Y	Y	Y	Y	100%	
5493	-77	Y	Y	Y	Y	Y	Y	Y	Y	Y	Y	100%	
5494	-76	Y	Y	Y	Y	Y	Y	Y	Y	Y	Y	100%	
5495	-75	Y	Y	Y	Y	Y	Y	Y	Y	Y	Y	100%	
5500	-70	Y	Y	Y	Y	Y	Y	Y	Y	Y	Y	100%	
5505	-65	Y	Y	Y	Y	Y	Y	Y	Y	Y	Y	100%	
5510	-60	Y	Y	Y	Y	Y	Y	Y	Y	Y	Y	100%	
5515	-55	Y	Y	Y	Y	Y	Y	Y	Y	Y	Y	100%	
5520	-50	Y	Y	Y	Y	Y	Y	Y	Y	Y	Y	100%	
5525	-45	Y	Y	Y	Y	Y	Y	Y	Y	Y	Y	100%	
5530	-40	Y	Y	Y	Y	Y	Y	Y	Y	Y	Y	100%	
5535	-35	Y	Y	Y	Y	Y	Y	Y	Y	Y	Y	100%	
5540	-30	Y	Y	Y	Y	Y	Y	Y	Y	Y	Y	100%	
5545	-25	Y	Y	Y	Y	Y	Y	Y	Y	Y	Y	100%	
5550	-20	Y	Y	Y	Y	Y	Y	Y	Y	Y	Y	100%	
5555	-15	Y	Y	Y	Y	Y	Y	Y	Y	Y	Y	100%	
5560	-10	Y	Y	Y	Y	Y	Y	Y	Y	Y	Y	100%	
5565	-5	Y	Y	Y	Y	Y	Y	Y	Y	Y	Y	100%	



Frequency (MHz)	Fc	Trial Number (Detection = V, No Detection = N)										Rate (%)	F _H /F _L
		1	2	3	4	5	6	7	8	9	10		
5570	0	Y	Y	Y	Y	Y	Y	Y	Y	Y	Y	100%	
5575	5	Y	Y	Y	Y	Y	Y	Y	Y	Y	Y	100%	
5580	10	Y	Y	Y	Y	Y	Y	Y	Y	Y	Y	100%	
5585	15	Y	Y	Y	Y	Y	Y	Y	Y	Y	Y	100%	
5590	20	Y	Y	Y	Y	Y	Y	Y	Y	Y	Y	100%	
5595	25	Y	Y	Y	Y	Y	Y	Y	Y	Y	Y	100%	
5600	30	Y	Y	Y	Y	Y	Y	Y	Y	Y	Y	100%	
5605	35	Y	Y	Y	Y	Y	Y	Y	Y	Y	Y	100%	
5610	40	Y	Y	Y	Y	Y	Y	Y	Y	Y	Y	100%	
5615	45	Y	Y	Y	Y	Y	Y	Y	Y	Y	Y	100%	
5620	50	Y	Y	Y	Y	Y	Y	Y	Y	Y	Y	100%	
5625	55	Y	Y	Y	Y	Y	Y	Y	Y	Y	Y	100%	
5630	60	Y	Y	Y	Y	Y	Y	Y	Y	Y	Y	100%	
5635	65	Y	Y	Y	Y	Y	Y	Y	Y	Y	Y	100%	
5640	70	Y	Y	Y	Y	Y	Y	Y	Y	Y	Y	100%	
5645	75	Y	Y	Y	Y	Y	Y	Y	Y	Y	Y	100%	
5646	76	Y	Y	Y	Y	Y	Y	Y	Y	Y	Y	100%	
5647	77	Y	Y	Y	Y	Y	Y	Y	Y	Y	Y	100%	
5648	78	Y	Y	Y	Y	Y	Y	Y	Y	Y	Y	100%	
5649	79	Y	Y	Y	Y	Y	Y	Y	Y	Y	Y	100%	
5650	80	Y	Y	Y	Y	Y	Y	Y	Y	Y	Y	100%	F _H
5651	81	N	N	N	N	N	N	N	N	N	N	0%	

Detection Bandwidth = F_H – F_L = **5650 – 5490 = 160 MHz**

EUT 99% Bandwidth = 156.08 MHz (Refer to channel 114)



3.3 Channel Availability Check

3.3.1 Limit of Channel Availability Check

The Initial Channel Availability Check Time tests that the EUT does not emit beacon, control, or data signals on the test Channel until the power-up sequence has been completed and the U-NII device checks for radar waveforms for **one minute** on the test Channel.

3.3.2 Test Procedures of Initial Channel Availability Check Time

This test does not use any radar waveforms and only needs to be performed one time.

- (1) The U-NII devices will be powered on and be instructed to operate on the appropriate U-NII Channel that must incorporate DFS functions. At the same time the EUT is powered on, the spectrum analyzer will be set to zero span mode with a 3 MHz RBW and 3 MHz VBW on the Channel occupied by the radar (Chr) with a 2.5 minute sweep time. The spectrum analyzer's sweep will be started at the same time power is applied to the U-NII device.
- (2) The EUT should not transmit any beacon or data transmissions until at least 1 minute after the completion of the power-on cycle.

3.3.3 Radar Burst at the Beginning of the Channel Availability Check Time

The steps below define the procedure to verify successful radar detection on the test Channel during a period equal to the Channel Availability Check Time and avoidance of operation on that Channel when a radar Burst with a level equal to the DFS Detection Threshold + 1 dB occurs at the beginning of the Channel Availability Check Time. This is illustrated in Figure 15.

- (1) The Radar Waveform generator and EUT are connected using the applicable test setup and the power of the EUT is switched off.
- (2) The EUT is powered on at T_0 . T_1 denotes the instant when the EUT has completed its power-up sequence (T_{power_up}). The Channel Availability Check Time commences on Chr at instant T_1 and will end no sooner than $T_1 + T_{ch_avail_check}$.
- (3) A single Burst of one of the Short Pulse Radar Types 1-4 will commence within a 6 second window starting at T_1 . An additional 1 dB is added to the radar test signal to ensure it is at or above the DFS Detection Threshold, accounting for equipment variations/errors.
- (4) Visual indication or measured results on the EUT of successful detection of the radar Burst will be recorded and reported. Observation of Chr for EUT emissions will continue for 2.5 minutes after the radar Burst has been generated.
- (5) Verify that during the 2.5 minute measurement window no EUT transmissions occurred on Chr. The Channel Availability Check results will be recorded.

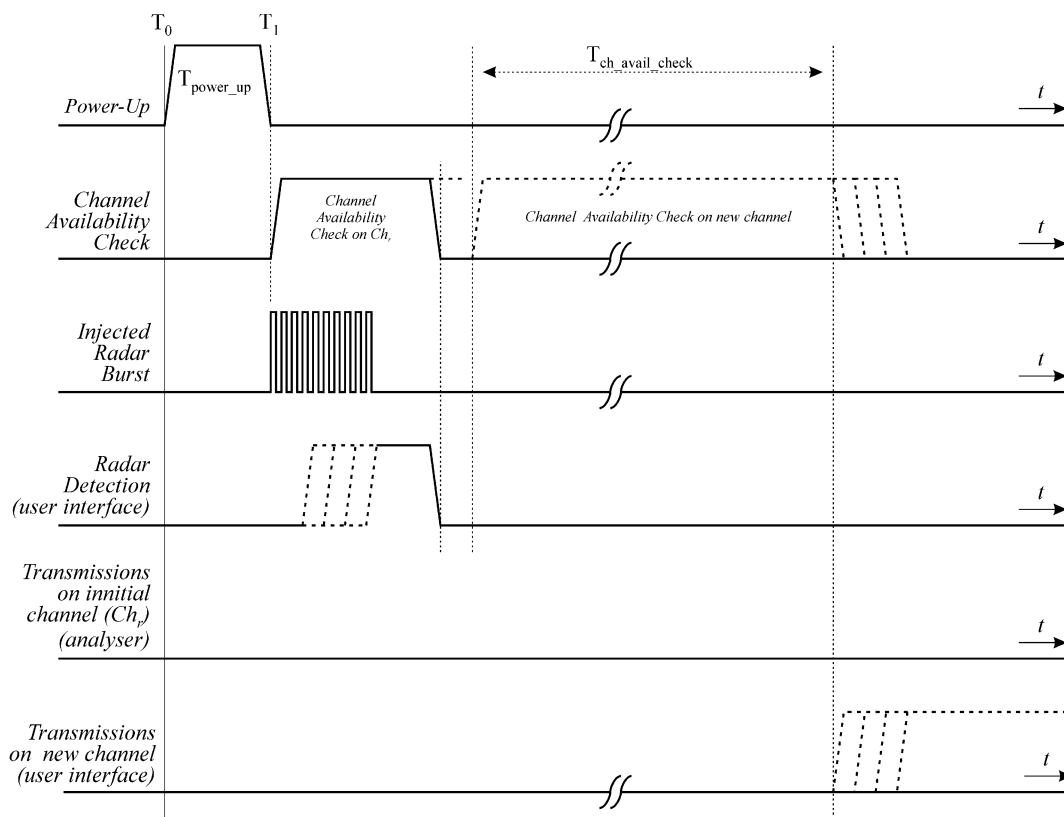

Figure 15: Example of timing for radar testing at the beginning of the Channel Availability Check Time

3.3.4 Radar Burst at the End of the Channel Availability Check Time

The steps below define the procedure to verify successful radar detection on the test Channel during a period equal to the Channel Availability Check Time and avoidance of operation on that Channel when a radar Burst with a level equal to the DFS Detection Threshold + 1dB occurs at the end of the Channel Availability Check Time. This is illustrated in Figure 16.

- (1) The Radar Waveform generator and EUT are connected using the applicable test setup and the power of the EUT is switched off.
- (2) The EUT is powered on at T_0 . T_1 denotes the instant when the EUT has completed its power-up sequence (T_{power_up}). The Channel Availability Check Time commences on Chr at instant T_1 and will end no sooner than $T_1 + T_{ch_avail_check}$.
- (3) A single Burst of one of the Short Pulse Radar Types 1-4 will commence within a 6 second window starting at $T_1 + 54$ seconds. An additional 1 dB is added to the radar test signal to ensure it is at or above the DFS Detection Threshold, accounting for equipment variations/errors.
- (4) Visual indication or measured results on the EUT of successful detection of the radar Burst will be recorded and reported. Observation of Chr for EUT emissions will continue for 2.5 minutes after the radar Burst has been generated.
- (5) Verify that during the 2.5 minute measurement window no EUT transmissions occurred on Chr. The Channel Availability Check results will be recorded.

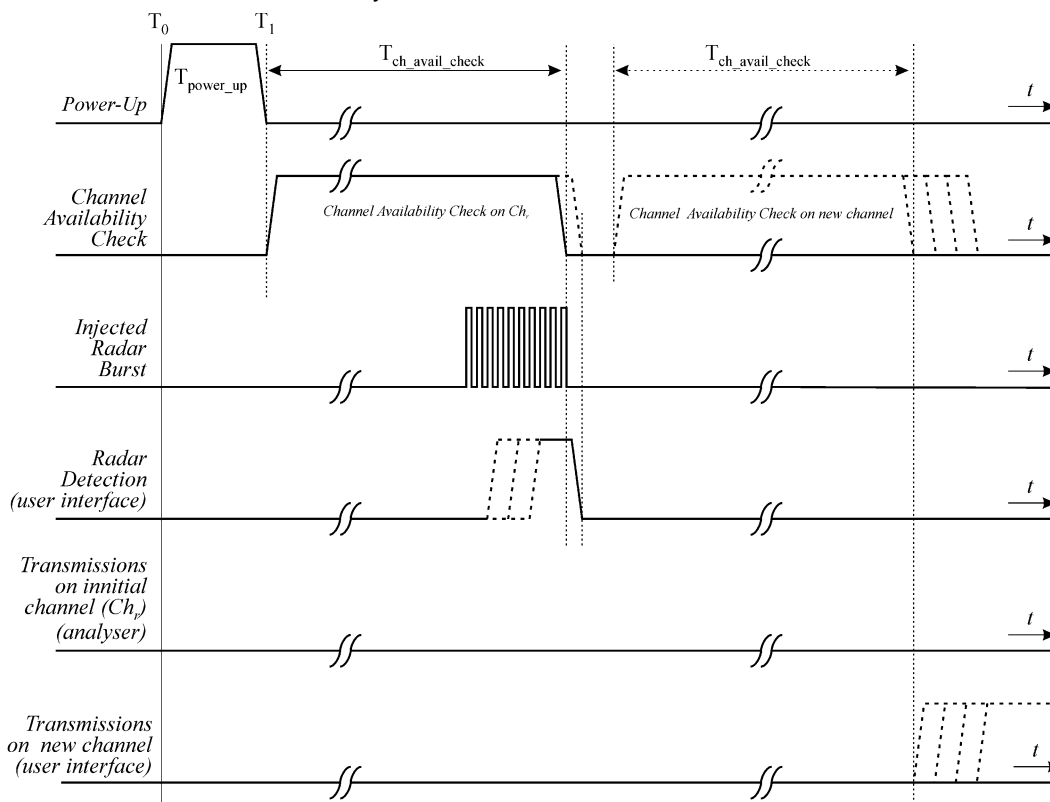
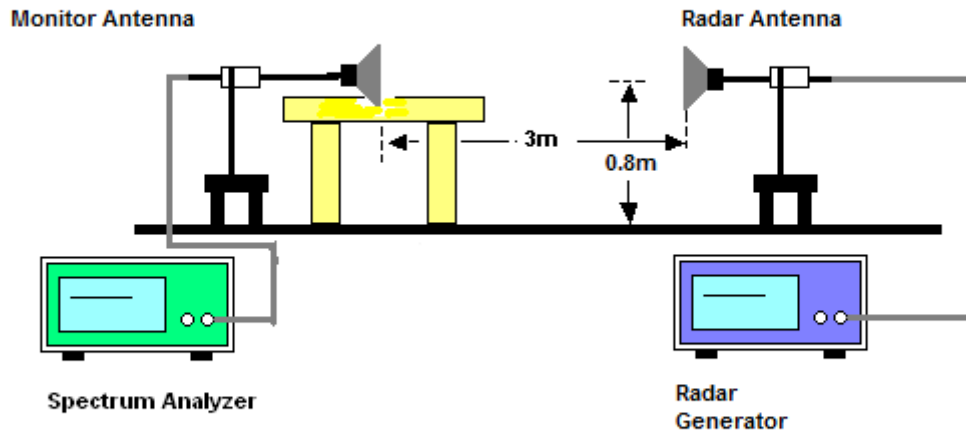

Figure 16: Example of timing for radar testing towards the end of the Channel Availability Check Time

3.3.5 Test Setup



3.3.6 Test Deviation

There is no deviation with the original standard.



3.3.7 Result of Channel Availability Check Time

<Radio 1>

<80MHz / 5290MHz>



- Marker 1(Delta 2): 60 seconds before End of Channel Availability Check
- Marker 2: End of Channel Availability Check
- Marker 3: 54 seconds or 6 seconds before End of Channel Availability Check



<Radio 2>

<80MHz / 5290MHz>

EUT Power up and Initial Channel Availability Check Time



Radar Burst at the Beginning of the Channel Availability Check Time



Radar Burst at the End of the Channel Availability Check Time



Marker 1(Delta 2): 60 seconds before End of Channel Availability Check

Marker 2: End of Channel Availability Check

Marker 3: 54 seconds or 6 seconds before End of Channel Availability Check



<80MHz / 5530MHz>

EUT Power up and Initial Channel Availability Check Time



Radar Burst at the Beginning of the Channel Availability Check Time



Radar Burst at the End of the Channel Availability Check Time



Marker 1(Delta 2): 60 seconds before End of Channel Availability Check

Marker 2: End of Channel Availability Check

Marker 3: 54 seconds or 6 seconds before End of Channel Availability Check