



# FCC RADIO TEST REPORT

FCC ID : S9GR760  
Equipment : R760 Access Point  
Brand Name : RUCKUS  
Model Name : R760  
Applicant : Ruckus Wireless Inc.  
350 W. Java Dr., Sunnyvale CA 94089 USA  
Manufacturer : Ruckus Wireless Inc.  
350 W. Java Dr., Sunnyvale CA 94089 USA  
Standard : FCC Part 15 Subpart C §15.247

The product was received on Jul. 28, 2021 and testing was performed from Aug. 15, 2021 to Dec. 17, 2021. We, Sporton International (USA) Inc., would like to declare that the tested sample has been evaluated in accordance with the test procedures and has been in compliance with the applicable technical standards.

The test results in this report apply exclusively to the tested model / sample. Without written approval from Sporton International (USA) Inc., the test report shall not be reproduced except in full.

Approved by: Neil Kao

**Sporton International (USA) Inc.**  
1175 Montague Expressway, Milpitas, CA 95035



## Table of Contents

History of this test report.....	3
Summary of Test Result.....	4
<b>1 General Description.....</b>	<b>5</b>
1.1 Product Feature of Equipment Under Test.....	5
1.2 Modification of EUT .....	5
1.3 Testing Location .....	6
1.4 Applicable Standards.....	6
<b>2 Test Configuration of Equipment Under Test .....</b>	<b>7</b>
2.1 Carrier Frequency Channel .....	7
2.2 Test Mode.....	8
2.3 Connection Diagram of Test System.....	9
2.4 Support Unit used in test configuration and system .....	10
2.5 EUT Operation Test Setup .....	10
2.6 Measurement Results Explanation Example.....	10
<b>3 Test Result.....</b>	<b>11</b>
3.1 6dB and 99% Bandwidth Measurement .....	11
3.2 Output Power Measurement.....	14
3.3 Power Spectral Density Measurement .....	15
3.4 Conducted Band Edges and Spurious Emission Measurement .....	18
3.5 Radiated Band Edges and Spurious Emission Measurement .....	22
3.6 AC Conducted Emission Measurement.....	26
3.7 Antenna Requirements .....	28
<b>4 List of Measuring Equipment .....</b>	<b>29</b>
<b>5 Uncertainty of Evaluation.....</b>	<b>31</b>
<b>Appendix A. Conducted Test Results</b>	
<b>Appendix B. AC Conducted Emission Test Result</b>	
<b>Appendix C. Radiated Spurious Emission</b>	
<b>Appendix D. Radiated Spurious Emission Plots</b>	
<b>Appendix E. Duty Cycle Plots</b>	
<b>Appendix F. Setup Photographs</b>	



## Summary of Test Result

Report Clause	Ref Std. Clause	Test Items	Result (PASS/FAIL)	Remark
3.1	15.247(a)(2)	6dB Bandwidth	Pass	-
3.1	2.1049	99% Occupied Bandwidth	Reporting only	-
3.2	15.247(b)(3)	Output Power	Pass	-
3.3	15.247(e)	Power Spectral Density	Pass	-
3.4	15.247(d)	Conducted Band Edges and Spurious Emission	Pass	-
3.5	15.247(d)	Radiated Band Edges and Spurious Emission	Pass	0.26 dB under the limit at 2483.520 MHz
3.6	15.207	AC Conducted Emission	Pass	9.27 dB under the limit at 0.369 MHz
3.7	15.203 & 15.247(b)	Antenna Requirement	Pass	-

**Declaration of Conformity:**

The test results with all measurement uncertainty excluded are presented in accordance with the regulation limits or requirements declared by manufacturers.

**Comments and Explanations:**

The product specifications of the EUT presented in the report are declared by the manufacturer who shall take full responsibility for the authenticity.



# 1 General Description

## 1.1 Product Feature of Equipment Under Test

The EUT is an indoor AP with radios including Bluetooth - LE, Wi-Fi 2.4GHz 802.11b/g/n/ac/ax, Wi-Fi 5GHz 802.11a/n/ac/ax, Wi-Fi 6GHz 802.11a/n/ac/ax, 802.15.4 (Zigbee), equipped with integrated antennas configured below:

Antenna Configuration	
<b>Antenna Type</b>	<p><b>WLAN 2.4GHz</b>            &lt;Ant. A&gt;: Omni Antenna            &lt;Ant. B&gt;: Omni Antenna            &lt;Ant. C&gt;: Omni Antenna            &lt;Ant. D&gt;: Omni Antenna</p> <p><b>WLAN 5GHz</b>  <b>Radio 1 and Radio 2:</b>            &lt;Ant. A&gt;: Omni Antenna            &lt;Ant. B&gt;: Omni Antenna            &lt;Ant. C&gt;: Omni Antenna            &lt;Ant. D&gt;: Omni Antenna</p> <p><b>Radio 3:</b>            &lt;Ant. E&gt;: Omni Antenna            &lt;Ant. F&gt;: Omni Antenna            &lt;Ant. G&gt;: Omni Antenna            &lt;Ant. H&gt;: Omni Antenna</p> <p><b>WLAN 6GHz</b>            &lt;Ant. E&gt;: Omni Antenna            &lt;Ant. F&gt;: Omni Antenna            &lt;Ant. G&gt;: Omni Antenna            &lt;Ant. H&gt;: Omni Antenna</p> <p><b>Bluetooth-LE:</b> &lt;Ant. 1&gt;Omni Antenna  <b>Zigbee:</b> &lt;Ant. 1&gt;Omni Antenna</p>

Antenna information		
2400 MHz ~ 2483.5 MHz	Peak Gain (dBi)	3

**Remark:** The above EUT's information is declared by manufacturer. Please refer to Comments and Explanations in report summary.

## 1.2 Modification of EUT

No modifications made to the EUT during the testing.



### 1.3 Testing Location

Test Site	Sporton International (USA) Inc.
Test Site Location	1175 Montague Expressway, Milpitas, CA 95035 TEL : 408 9043300
Test Site No.	<b>Sporton Site No.</b>
	CO01-CA, 03CH02-CA, TH01-CA

**Note:** The test site complies with ANSI C63.4 2014 requirement.

### 1.4 Applicable Standards

According to the specifications declared by the manufacturer, the EUT must comply with the requirements of the following standards:

- ♦ FCC Part 15 Subpart C §15.247
- ♦ FCC KDB Publication No. 558074 D01 DTS Meas. Guidance v05r02
- ♦ FCC KDB 414788 D01 Radiated Test Site v01r01
- ♦ ANSI C63.10-2013

**Remark:**

1. All the test items were validated and recorded in accordance with the standards without any modification during the testing.



## 2 Test Configuration of Equipment Under Test

### 2.1 Carrier Frequency Channel

Frequency Band	Channel	Freq. (MHz)	Channel	Freq. (MHz)
2400-2483.5 MHz	0	2402	21	2444
	1	2404	22	2446
	2	2406	23	2448
	3	2408	24	2450
	4	2410	25	2452
	5	2412	26	2454
	6	2414	27	2456
	7	2416	28	2458
	8	2418	29	2460
	9	2420	30	2462
	10	2422	31	2464
	11	2424	32	2466
	12	2426	33	2468
	13	2428	34	2470
	14	2430	35	2472
	15	2432	36	2474
	16	2434	37	2476
	17	2436	38	2478
	18	2438	39	2480
	19	2440	-	-
20	2442	-	-	



## 2.2 Test Mode

- a. The EUT has been associated with peripherals and configuration operated in a manner tended to maximize its emission characteristics in a typical application. Frequency range investigated: conduction emission (150 kHz to 30 MHz), radiation emission (9 kHz to the 10th harmonic of the highest fundamental frequency or to 40 GHz, whichever is lower). For radiated measurement, the measured emission level of the EUT was maximized by rotating the EUT on a turntable, adjusting the orientation of the EUT and EUT antenna in three orthogonal axis (X: flat, Y: portrait, Z: landscape), and adjusting the measurement antenna orientation, following C63.10 exploratory test procedures and find Y plane as worst plane.
- b. AC power line Conducted Emission was tested under maximum output power.

The following summary table is showing all test modes to demonstrate in compliance with the standard.

Summary table of Test Cases	
Test Item	Data Rate / Modulation
<b>Conducted Test Cases</b>	<b>Bluetooth – LE / GFSK</b>
	Mode 1: Bluetooth Tx CH00_2402 MHz_1Mbps
	Mode 2: Bluetooth Tx CH19_2440 MHz_1Mbps
	Mode 3: Bluetooth Tx CH38_2478 MHz_1Mbps
	Mode 4: Bluetooth Tx CH39_2480 MHz_1Mbps
<b>Radiated Test Cases</b>	Mode 1: Bluetooth Tx CH00_2402 MHz_1Mbps
	Mode 2: Bluetooth Tx CH19_2440 MHz_1Mbps
	Mode 3: Bluetooth Tx CH38_2478 MHz_1Mbps
	Mode 4: Bluetooth Tx CH39_2480 MHz_1Mbps
<b>AC Conducted Emission</b>	Mode 1: WLAN (2.4GHz) Link + Bluetooth – LE Idle + Zigbee Tx + AC Adapter + LAN 1 Link + WLAN (5GHz) (Radio 1) Link + WLAN (6GHz) Link + USB Flash drive (Load) + LAN 2 Link
	Mode 2: WLAN (2.4GHz) Link + Bluetooth – LE Idle + Zigbee Tx + AC Adapter + LAN 1 Link + WLAN (5GHz) (Radio 3) Link + WLAN (5GHz) (Radio 1) Link + USB Flash drive (Load) + LAN 2 Link
	Mode 3: WLAN (2.4GHz) Link + Bluetooth – LE Tx + Zigbee Idle + AC Adapter + LAN 1 Link + WLAN (5GHz) (Radio 1) Link + WLAN (6GHz) Link + USB Flash drive (Load) + LAN 2 Link
<b>Remark:</b> The worst case of Conducted Emission is mode 1; only the test data of it was reported.	



## 2.3 Connection Diagram of Test System

### <AC Conducted Emission Mode>

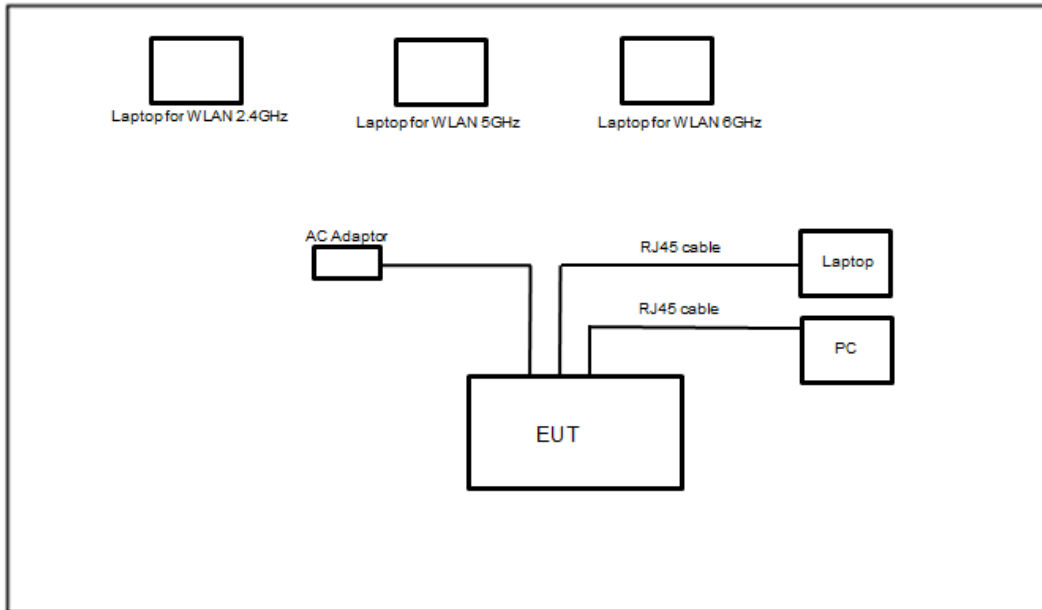

### <Radiated Emission Mode>

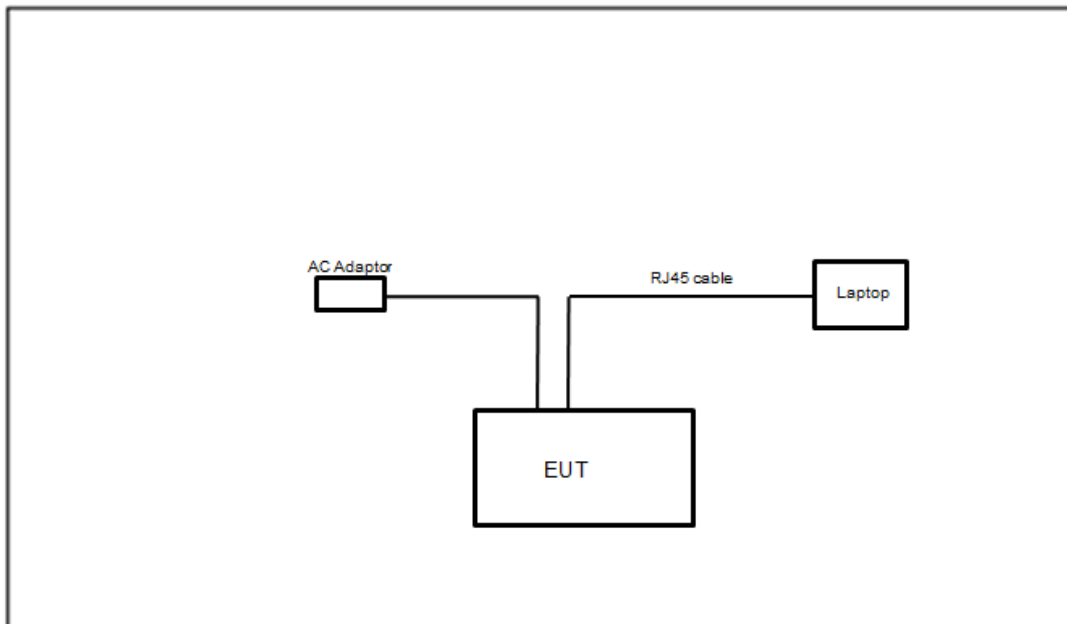



### 2.4 Support Unit used in test configuration and system

Item	Equipment	Brand Name	Model Name	FCC ID	Data Cable	Power Cord
1.	Notebook	ACER	Altos PS548-G1	FCC DoC	N/A	AC I/P : Unshielded, 1.2m DC O/P : Shielded, 1.8m
2.	Notebook	LENOVO	80RU	FCC DoC	N/A	AC I/P : Unshielded, 1.2m DC O/P : Shielded, 1.8m
3.	Notebook	MSI	MS-17F3	FCC DoC	N/A	AC I/P : Unshielded, 1.2m DC O/P : Shielded, 1.8m
4.	PC	Fractal	FD-C-DEF7A-01 (NETINTX550TR Intel X550T2BLK)	FCC DoC	N/A	AC I/P : Unshielded, 1.2m DC O/P : Shielded, 1.8m
5.	Notebook	Acer	Altos PS548-G1	FCC DoC	N/A	AC I/P: Unshielded, 1.2 m DC O/P: Shielded, 1.8 m
6.	USB Flash drive	SanDisk	N/A	N/A	N/A	N/A
7.	AC Adapter	Ruckus	740-64277-001	NA	NA	AC I/P: Unshielded, 1.2m

### 2.5 EUT Operation Test Setup

The RF test items, utility “PuTTY Release 0.75” was installed in Notebook which was programmed in order to make the EUT get into the engineering modes to provide channel selection, power level, data rate and the application type and for continuous transmitting signals.

### 2.6 Measurement Results Explanation Example

For all conducted test items:

The offset level is set in the spectrum analyzer to compensate the RF cable loss and attenuator factor between EUT conducted output port and spectrum analyzer. With the offset compensation, the spectrum analyzer reading level is exactly the EUT RF output level.

Example :

The spectrum analyzer offset is derived from RF cable loss and attenuator factor.

*Offset = RF cable loss + attenuator factor.*

Following shows an offset computation example with cable loss 4.2 dB and 10 dB attenuator.

$$\begin{aligned}
 \text{Offset(dB)} &= \text{RF cable loss(dB)} + \text{attenuator factor(dB)}. \\
 &= 4.2 + 10 = 14.2 \text{ (dB)}
 \end{aligned}$$

### 3 Test Result

#### 3.1 6dB and 99% Bandwidth Measurement

##### 3.1.1 Limit of 6dB and 99% Bandwidth

The minimum 6 dB bandwidth shall be at least 500 kHz.

##### 3.1.2 Measuring Instruments

Please refer to the measuring equipment list in this test report.

##### 3.1.3 Test Procedures

1. The testing follows the ANSI C63.10 Section 6.9.3 (OBW) and 11.8.1 (6dB BW).
2. The RF output of EUT is connected to the spectrum analyzer by RF cable and attenuator. The path loss is compensated to the results for each measurement.
3. Set the maximum power setting and enable the EUT to transmit continuously.
4. Make the measurement with the spectrum analyzer's resolution bandwidth (RBW) = 100 kHz. Set the Video bandwidth (VBW) = 300 kHz. In order to make an accurate measurement. The 6dB bandwidth must be greater than 500 kHz.
5. For 99% Bandwidth Measurement, the spectrum analyzer's resolution bandwidth (RBW) is set 1-5% of the emission bandwidth and set the Video bandwidth (VBW)  $\geq 3 * RBW$ .
6. Measure and record the results in the test report.

##### 3.1.4 Test Setup





### 3.1.5 Test Result of 6dB Bandwidth

Please refer to Appendix A.

<1Mbps>

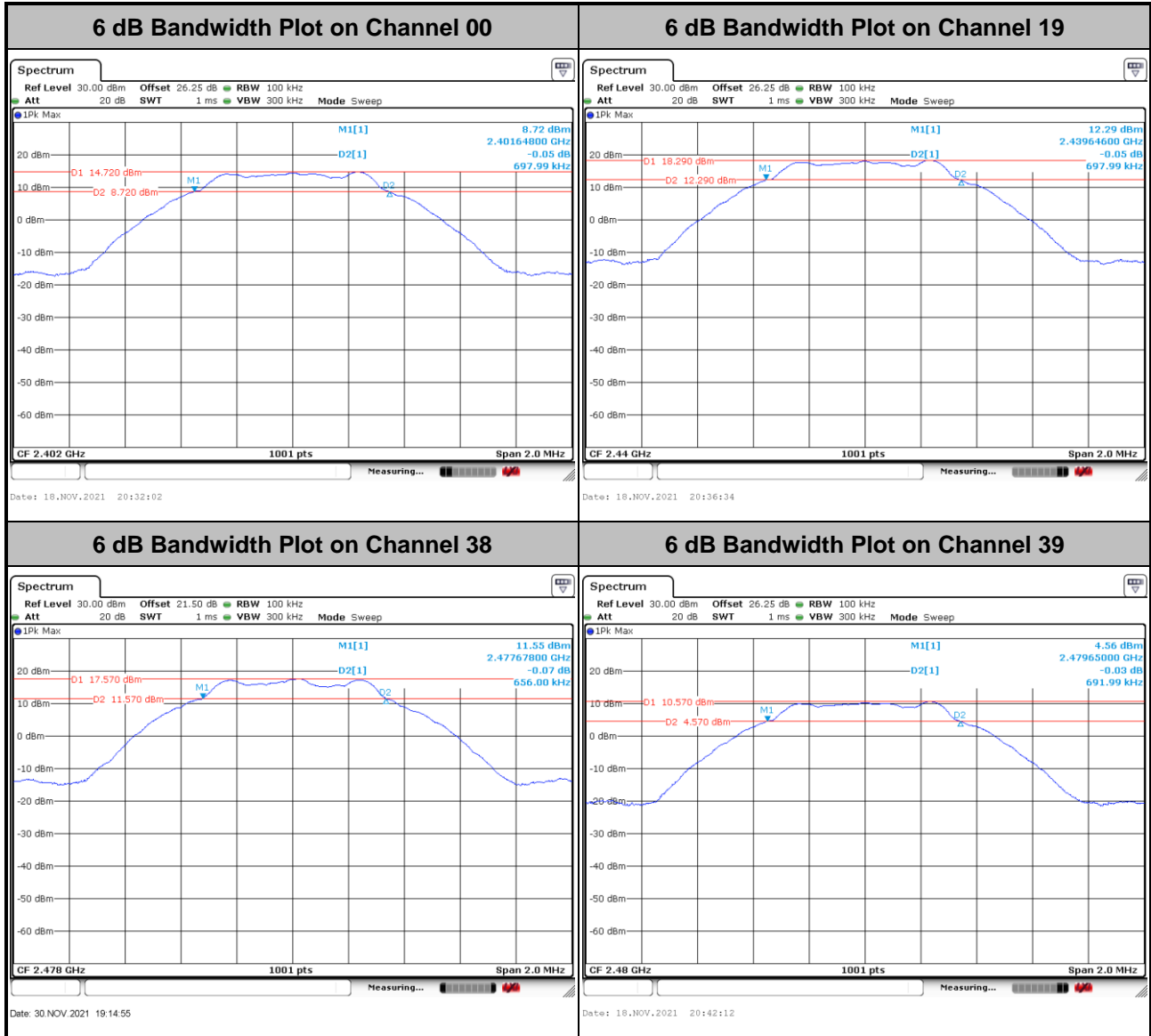



### 3.1.6 Test Result of 99% Occupied Bandwidth

Please refer to Appendix A.

<1Mbps>

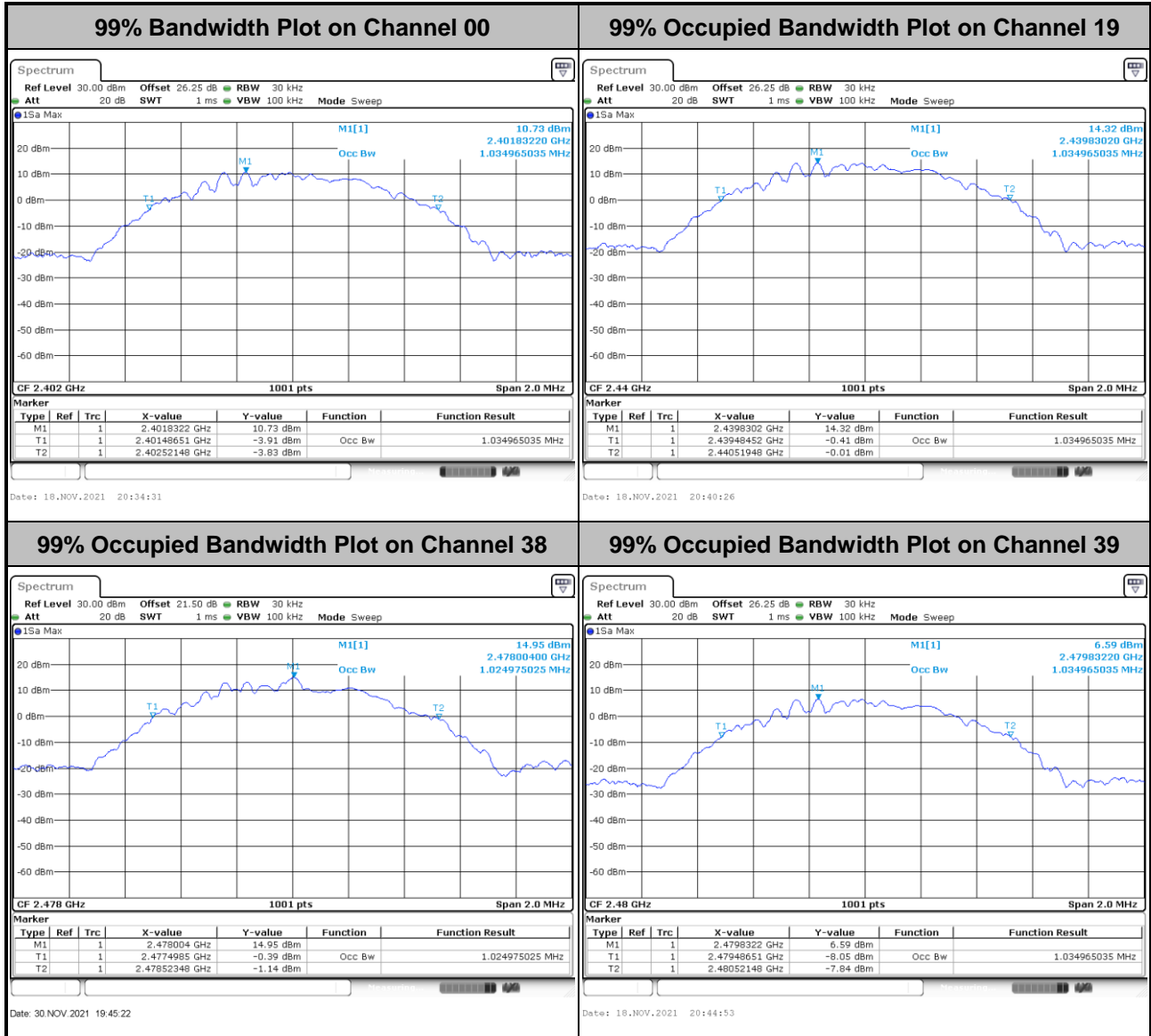

Note: The occupied channel bandwidth is maintained within the band of operation for all of the modulations.

## 3.2 Output Power Measurement

### 3.2.1 Limit of Output Power

For systems using digital modulation in the 2400-2483.5 MHz, the limit for output power is 30 dBm. If transmitting antenna of directional gain greater than 6 dBi is used, the peak output power from the intentional radiator shall be reduced below the above stated value by the amount in dB that the directional gain of the antenna exceeds 6 dBi. In case of point-to-point operation, the limit has to be reduced by 1 dB for every 3 dB that the directional gain of the antenna exceeds 6 dBi.

### 3.2.2 Measuring Instruments

Please refer to the measuring equipment list in this test report.

### 3.2.3 Test Procedures

1. For Average Power, the testing follows ANSI C63.10 Section 11.9.2.3.2 Method AVGPM-G
2. The RF output of EUT is connected to the power meter by RF cable and attenuator.
3. The path loss is compensated to the results for each measurement.
4. Set the maximum power setting and enable the EUT to transmit continuously.
5. Measure the conducted output power and record the results in the test report.

### 3.2.4 Test Setup

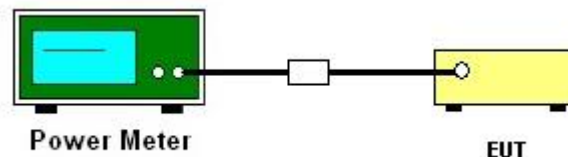

### 3.2.5 Test Result of Average Output Power

Please refer to Appendix A.

### 3.3 Power Spectral Density Measurement

#### 3.3.1 Limit of Power Spectral Density

The peak power spectral density shall not be greater than 8 dBm in any 3 kHz band at any time interval of continuous transmission.

#### 3.3.2 Measuring Instruments

Please refer to the measuring equipment list in this test report.

#### 3.3.3 Test Procedures

1. The testing follows the ANSI C63.10 Section 11.10.2 Method PKPSD.
2. The RF output of EUT is connected to the spectrum analyzer by RF cable and attenuator. The path loss is compensated to the results for each measurement.
3. Set the maximum power setting and enable the EUT to transmit continuously.
4. Make the measurement with the spectrum analyzer's resolution bandwidth (RBW) = 3 kHz. Video bandwidth (VBW) = 10 kHz. In order to make an accurate measurement, set the span to 1.5 times DTS Channel Bandwidth. (6 dB BW)
5. Detector = peak, Sweep time = auto couple, Trace mode = max hold, Allow trace to fully stabilize. Use the peak marker function to determine the maximum power level.
6. Measure and record the results in the test report.
7. The Measured power density (dBm)/ 100 kHz is a reference level and is used as 20 dBc down limit line for Conducted Band Edges and Conducted Spurious Emission.

#### 3.3.4 Test Setup



#### 3.3.5 Test Result of Power Spectral Density

Please refer to Appendix A.



### 3.3.6 Test Result of Power Spectral Density Plots (100kHz)

<1Mbps>

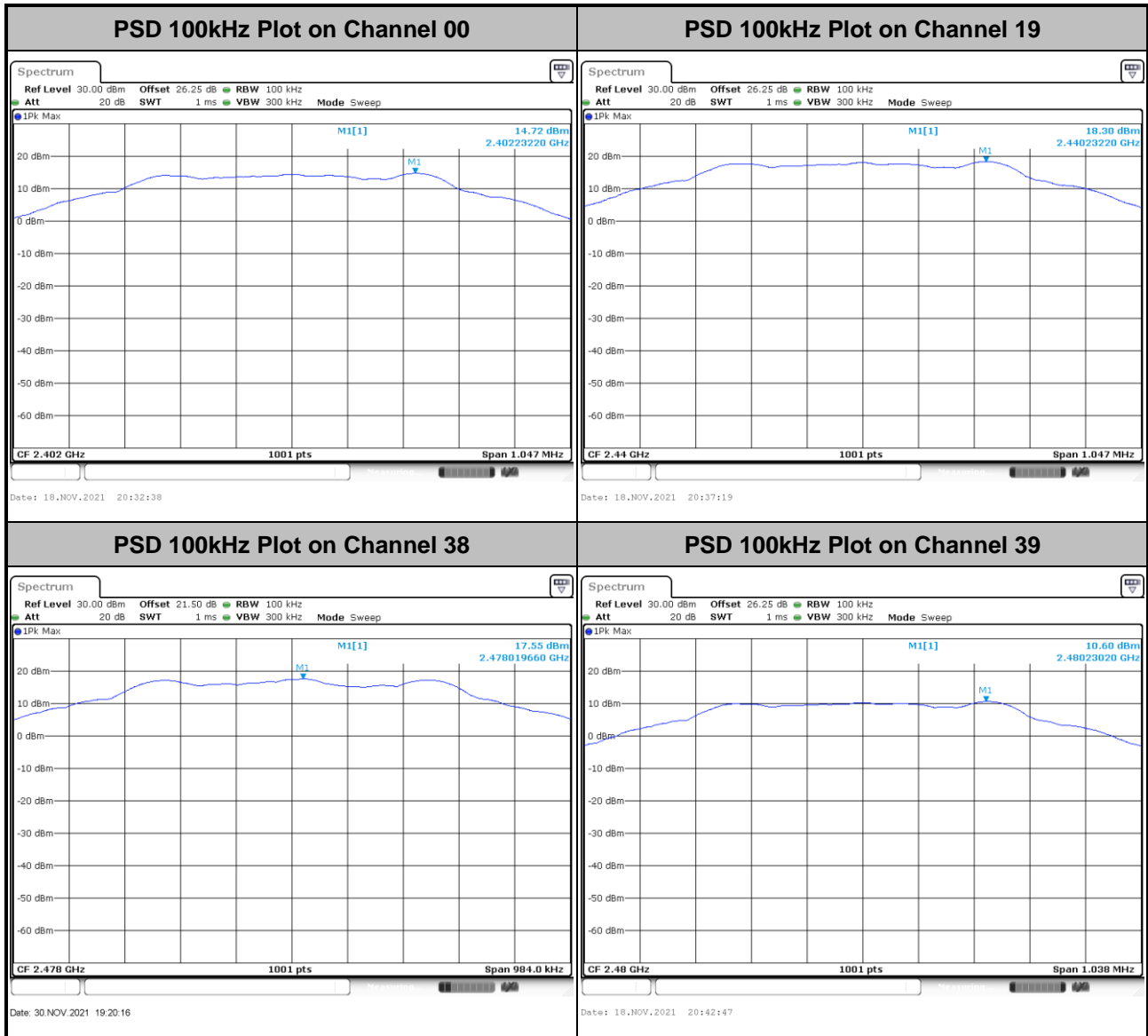





### 3.3.7 Test Result of Power Spectral Density Plots (3kHz)

<1Mbps>

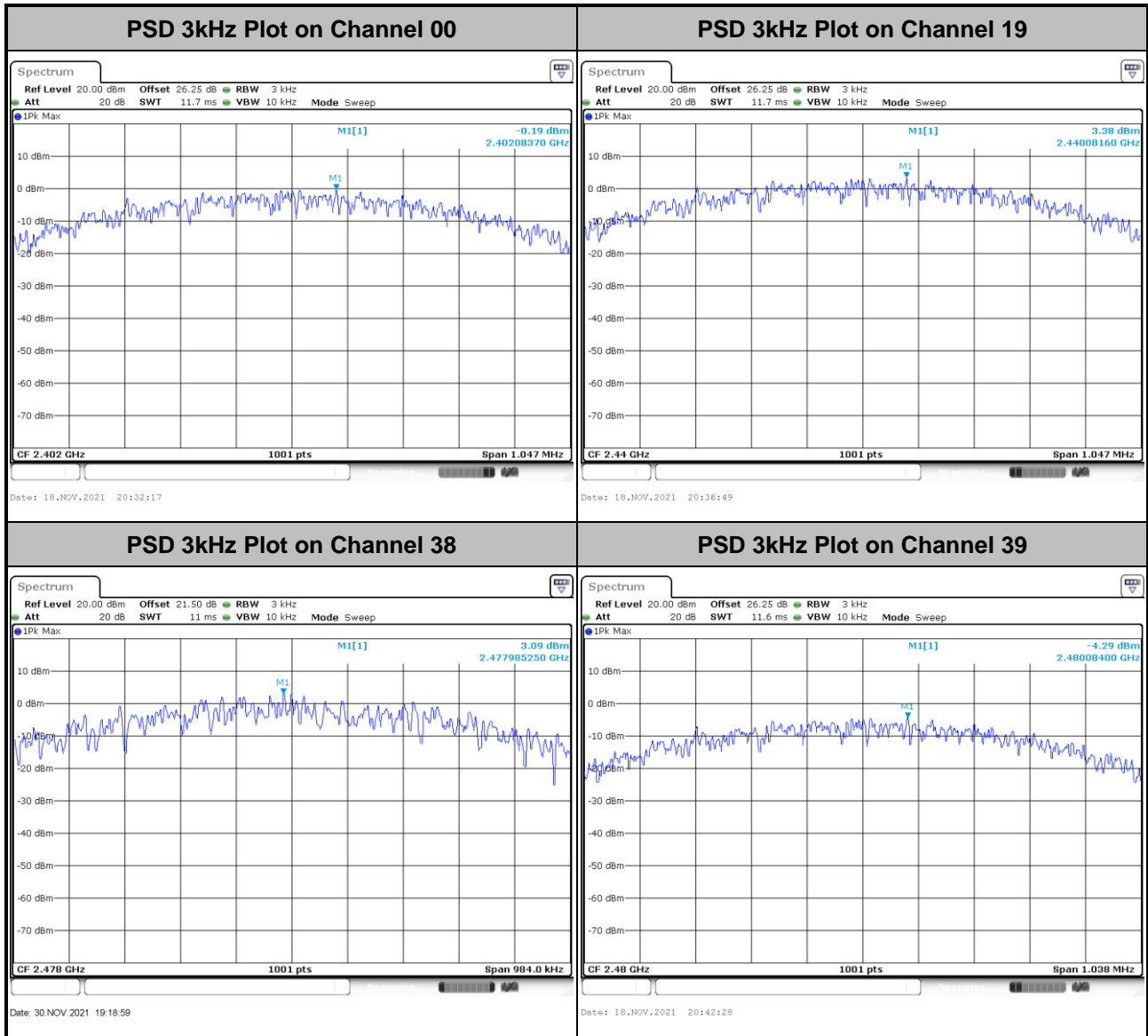

## 3.4 Conducted Band Edges and Spurious Emission Measurement

### 3.4.1 Limit of Conducted Band Edges and Spurious Emission

All harmonics/spurious must be at least 20 dB down from the highest emission level within the authorized band.

### 3.4.2 Measuring Instruments

Please refer to the measuring equipment list in this test report.

### 3.4.3 Test Procedure

1. The testing follows the ANSI C63.10 Section 11.11.3 Emission level measurement.
2. The RF output of EUT is connected to the spectrum analyzer by RF cable and attenuator. The path loss is compensated to the results for each measurement.
3. Set the maximum power setting and enable the EUT to transmit continuously.
4. Set RBW = 100 kHz, VBW = 300 kHz, Peak Detector. Unwanted Emissions measured in any 100 kHz bandwidth outside of the authorized frequency band shall be attenuated by at least 20 dB relative to the maximum in-band peak PSD level in 100 kHz when maximum peak conducted output power procedure is used. If the transmitter complies with the conducted power limits based on the use of RMS averaging over a time interval, the attenuation required under this paragraph shall be 30 dB instead of 20 dB.
5. Measure and record the results in the test report.
6. The RF fundamental frequency should be excluded against the limit line in the operating frequency band.

### 3.4.4 Test Setup





### 3.4.5 Test Result of Conducted Band Edges Plots

<1Mbps>

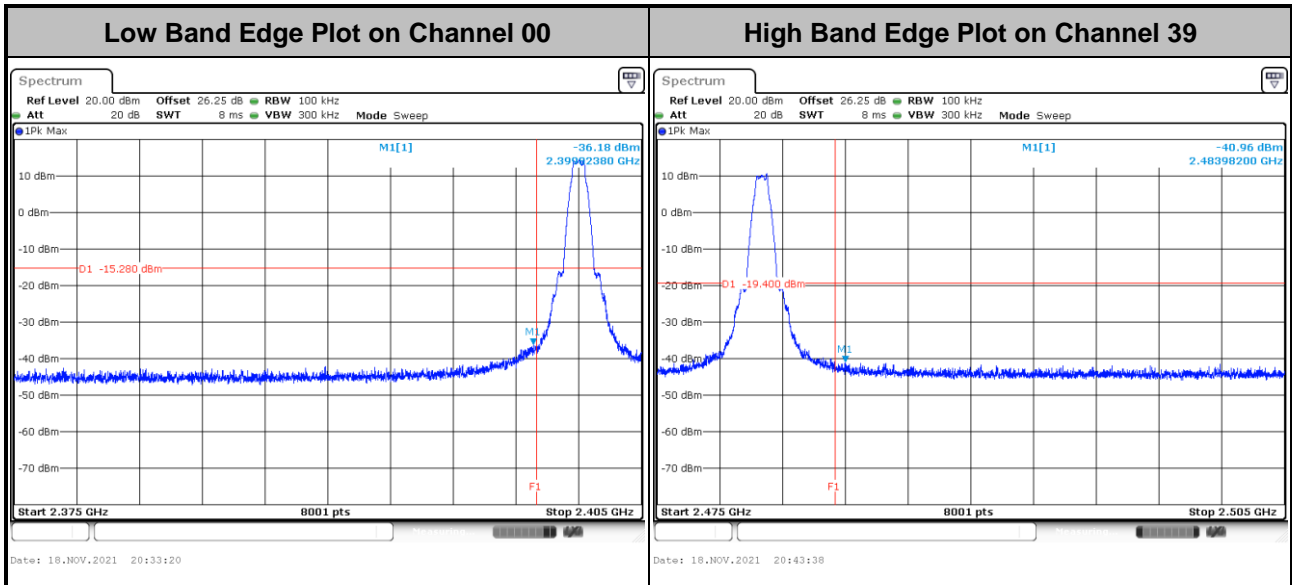



### 3.4.6 Test Result of Conducted Spurious Emission Plots

<1Mbps>

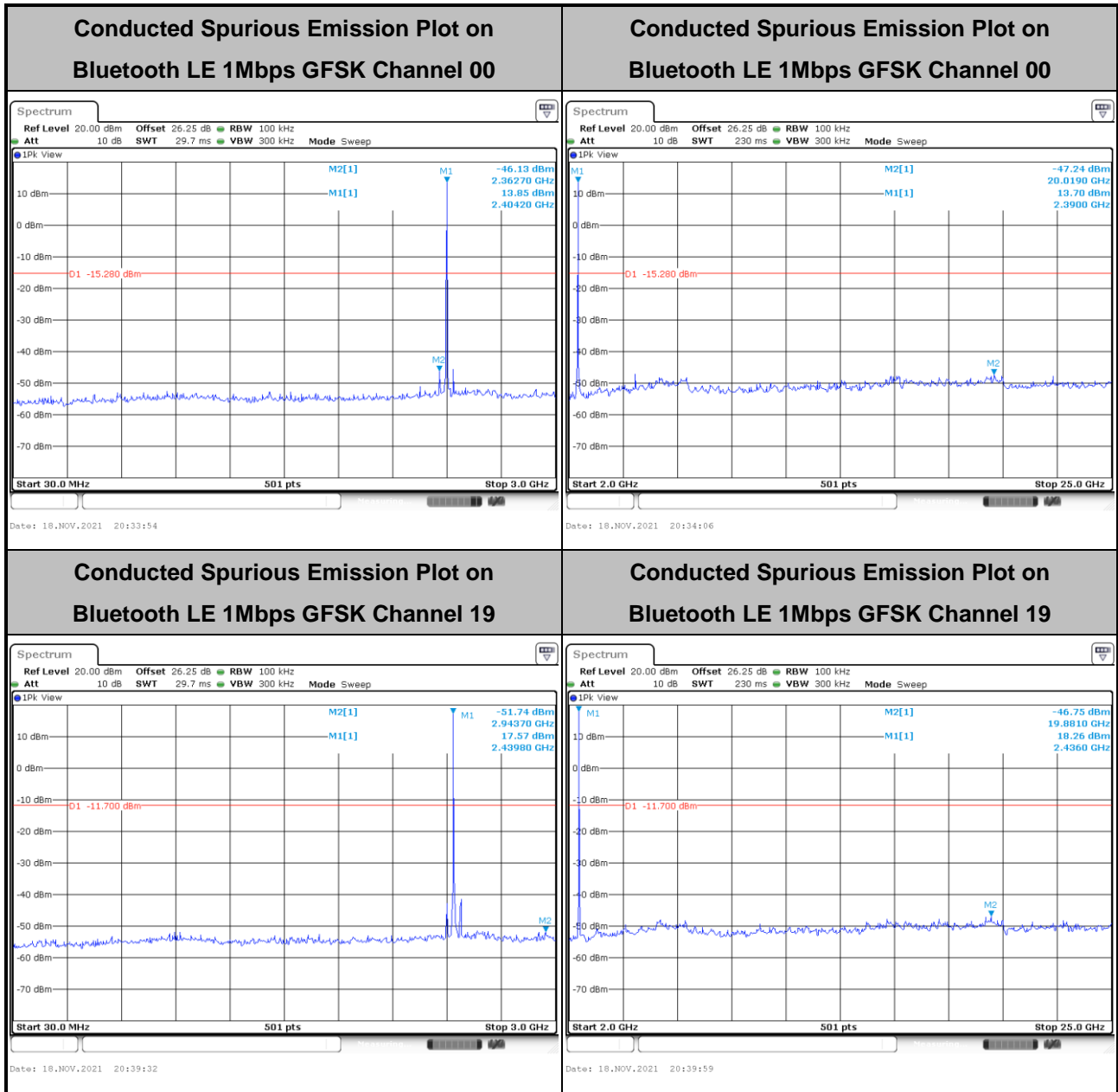



Conducted Spurious Emission Plot on Bluetooth LE 1Mbps GFSK Channel 38

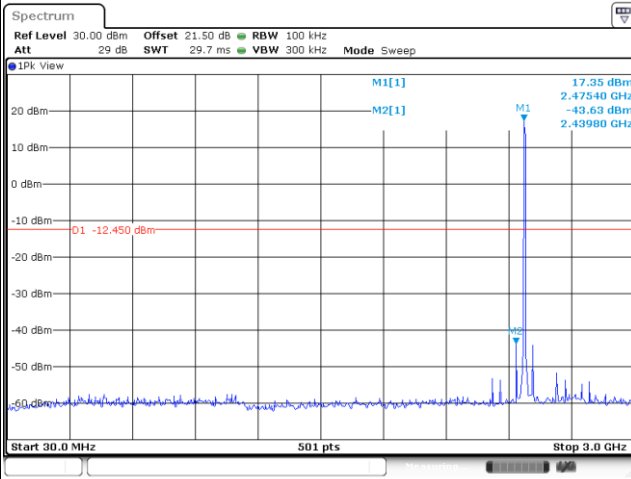

Date: 30.NOV.2021 19:42:32

Conducted Spurious Emission Plot on Bluetooth LE 1Mbps GFSK Channel 38

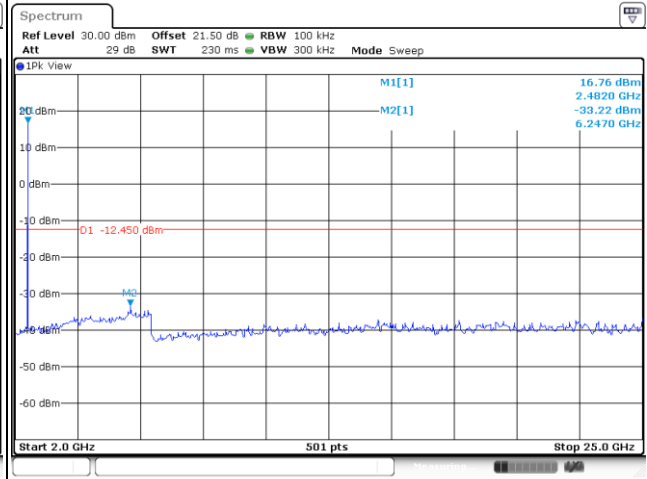

Date: 30.NOV.2021 19:43:13

Conducted Spurious Emission Plot on Bluetooth LE 1Mbps GFSK Channel 39

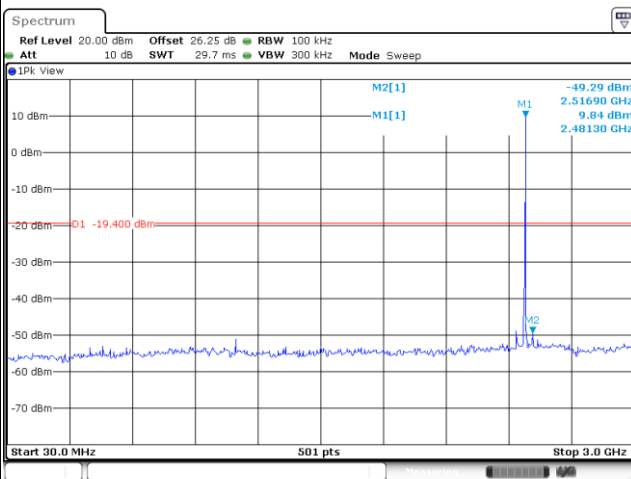

Date: 18.NOV.2021 20:44:11

Conducted Spurious Emission Plot on Bluetooth LE 1Mbps GFSK Channel 39

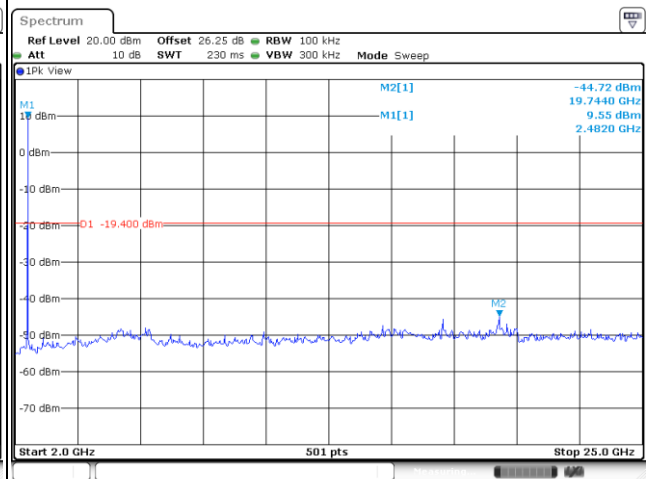

Date: 18.NOV.2021 20:44:28



### 3.5 Radiated Band Edges and Spurious Emission Measurement

#### 3.5.1 Limit of Radiated Band Edges and Spurious Emission

In any 100 kHz bandwidth outside the intentional radiator frequency band, all harmonics/spurious must be at least 20 dB below the highest emission level within the authorized band. If the output power of this device is measured by spectrum analyzer, the attenuation under this paragraph shall be 30 dB instead of 20 dB. In addition, radiated emissions which fall in the restricted bands must also comply with the limits as below.

Frequency (MHz)	Field Strength (microvolts/meter)	Measurement Distance (meters)
0.009 – 0.490	2400/F(kHz)	300
0.490 – 1.705	24000/F(kHz)	30
1.705 – 30.0	30	30
30 – 88	100	3
88 – 216	150	3
216 - 960	200	3
Above 960	500	3

#### 3.5.2 Measuring Instruments

Please refer to the measuring equipment list in this test report.



### 3.5.3 Test Procedures

1. The testing follows the ANSI C63.10 Section 11.12.1 Radiated emission measurements.
2. The EUT is arranged to its worst case and then tune the antenna tower (from 1 m to 4 m) and turntable (from 0 degree to 360 degrees) to find the maximum reading. A pre-amp and a high pass filter are used for the test in order to get better signal level.
3. The EUT is placed on a turntable with 0.8 meter for frequency below 1 GHz and 1.5 meter for frequency above 1 GHz respectively above ground.
4. The EUT is set 3 meters away from the receiving antenna, which is mounted on the top of a variable height antenna tower.
5. Corrected Reading: Antenna Factor + Cable Loss + Read Level - Preamp Factor = Level
6. Radiated testing below 1 GHz is performed by adjusting the antenna tower from 1 m to 4 m and by rotating the turn table from 0 degree to 360 degrees to find the peak maximum hold reading. When there is no suspected emission found and the emission level is with at least 6 dB margin against QP limit line, the position is marked as “-“.
7. Radiated testing above 1 GHz is performed by adjusting the antenna tower from 1 m to 4 m and by rotating the turn table from 0 degree to 360 degrees to find the peak maximum hold reading for scanning all frequencies. When there is no suspected emission found and the harmonic emission level is with at least 6 dB margin against average limit line, the position is marked as “-“.
8. Use the following spectrum analyzer settings:
  - (1) Span shall wide enough to fully capture the emission being measured;
  - (2) Set RBW = 100 kHz for  $f < 1$  GHz; VBW  $\geq$  RBW; Sweep = auto; Detector function = peak; Trace = max hold;
  - (3) Set RBW = 1 MHz, VBW = 3 MHz for  $f \geq 1$  GHz for peak measurement.  
For average measurement:
    - VBW = 10 Hz, when duty cycle is no less than 98 percent.
    - VBW  $\geq 1/T$ , when duty cycle is less than 98 percent where T is the minimum transmission duration over which the transmitter is on and is transmitting at its maximum power control level for the tested mode of operation.

### 3.5.4 Test Setup

For radiated test below 30MHz

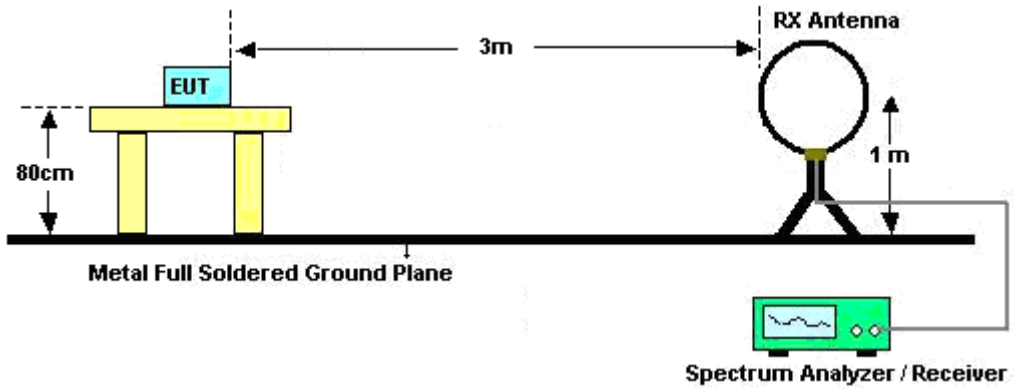

For radiated test from 30MHz to 1GHz

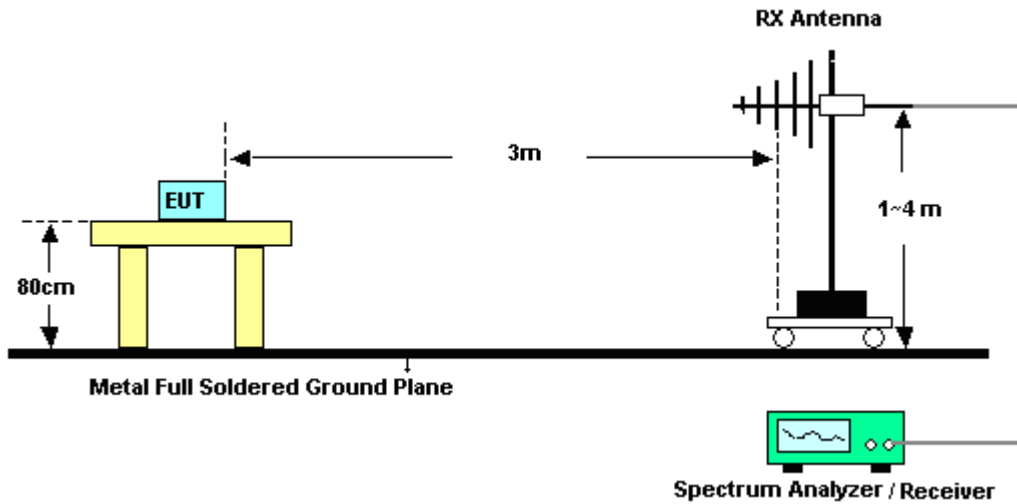

For radiated test from 1GHz to 18GHz

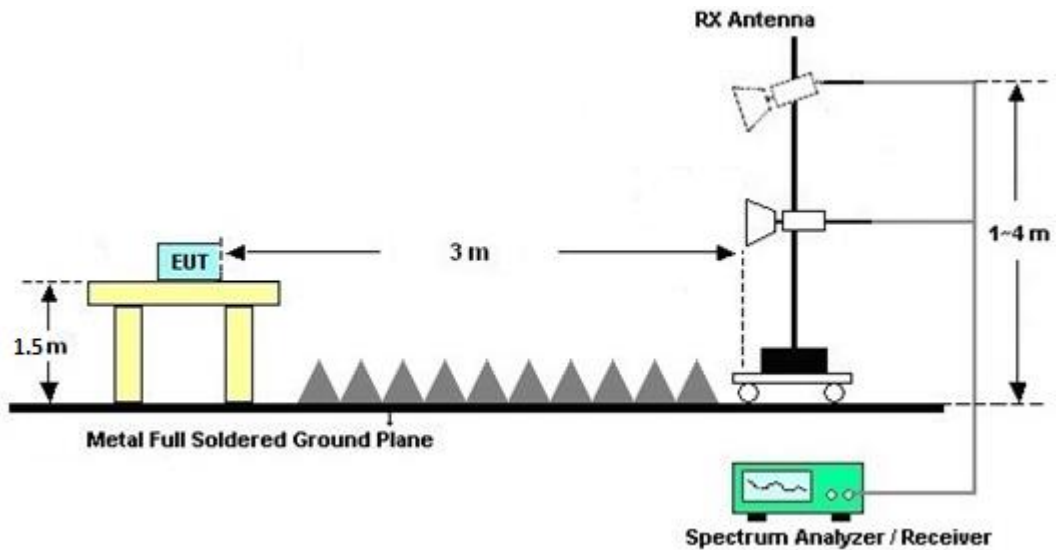



For radiated test above 18GHz

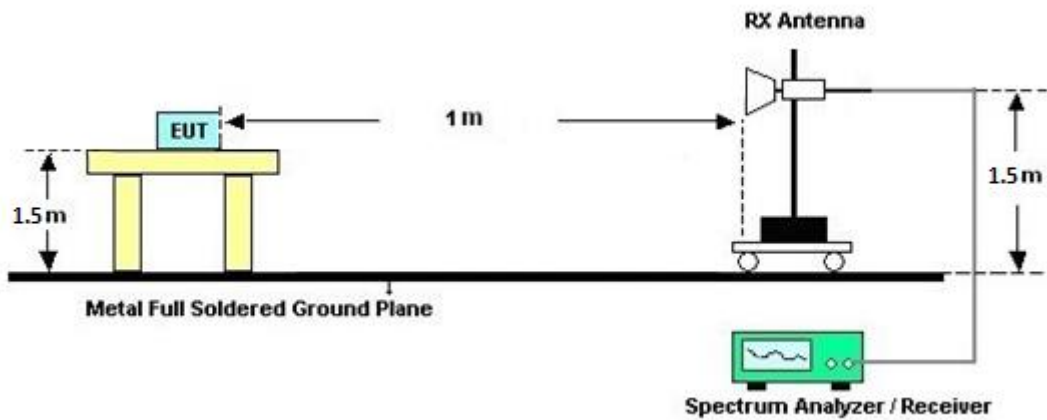

### 3.5.5 Test Results of Radiated Spurious Emissions (9 kHz ~ 30 MHz)

The low frequency, which starts from 9 kHz to 30 MHz, is pre-scanned and the result which is 20 dB lower than the limit line is not reported.

There is adequate comparison measurement of both open-field test site and alternative test site - semi-Anechoic chamber according to 414788 D01 Radiated Test Site v01r01, and the result comes out very similar.

### 3.5.6 Test Result of Radiated Spurious at Band Edges

Please refer to Appendix C and D.

### 3.5.7 Duty Cycle

Please refer to Appendix E.

### 3.5.8 Test Result of Radiated Spurious Emission (30 MHz ~ 10th Harmonic)

Please refer to Appendix C and D.

## 3.6 AC Conducted Emission Measurement

### 3.6.1 Limit of AC Conducted Emission

For equipment that is designed to be connected to the public utility (AC) power line, the radio frequency voltage that is conducted back onto the AC power line on any frequency or frequencies within the band 150 kHz to 30 MHz shall not exceed the limits in the following table.

Frequency of emission (MHz)	Conducted limit (dB $\mu$ V)	
	Quasi-peak	Average
0.15-0.5	66 to 56*	56 to 46*
0.5-5	56	46
5-30	60	50

\*Decreases with the logarithm of the frequency.

### 3.6.2 Measuring Instruments

Please refer to the measuring equipment list in this test report.

### 3.6.3 Test Procedures

1. The EUT is placed 0.4 meter away from the conducting wall of the shielding room, and is kept at least 80 centimeters from any other grounded conducting surface.
2. Connect EUT to the power mains through a line impedance stabilization network (LISN).
3. All the support units are connecting to the other LISN.
4. The LISN provides 50 ohm coupling impedance for the measuring instrument.
5. The FCC states that a 50 ohm, 50 microhenry LISN shall be used.
6. Both Line and Neutral shall be tested in order to find out the maximum conducted emission.
7. The frequency range from 150 kHz to 30 MHz is scanned.
8. Set the test-receiver system to Peak Detect Function and specified bandwidth (IF Bandwidth = 9 kHz) with Maximum Hold Mode. Then measurement is also conducted by Average Detector and Quasi-Peak Detector Function respectively.

### 3.6.4 Test Setup

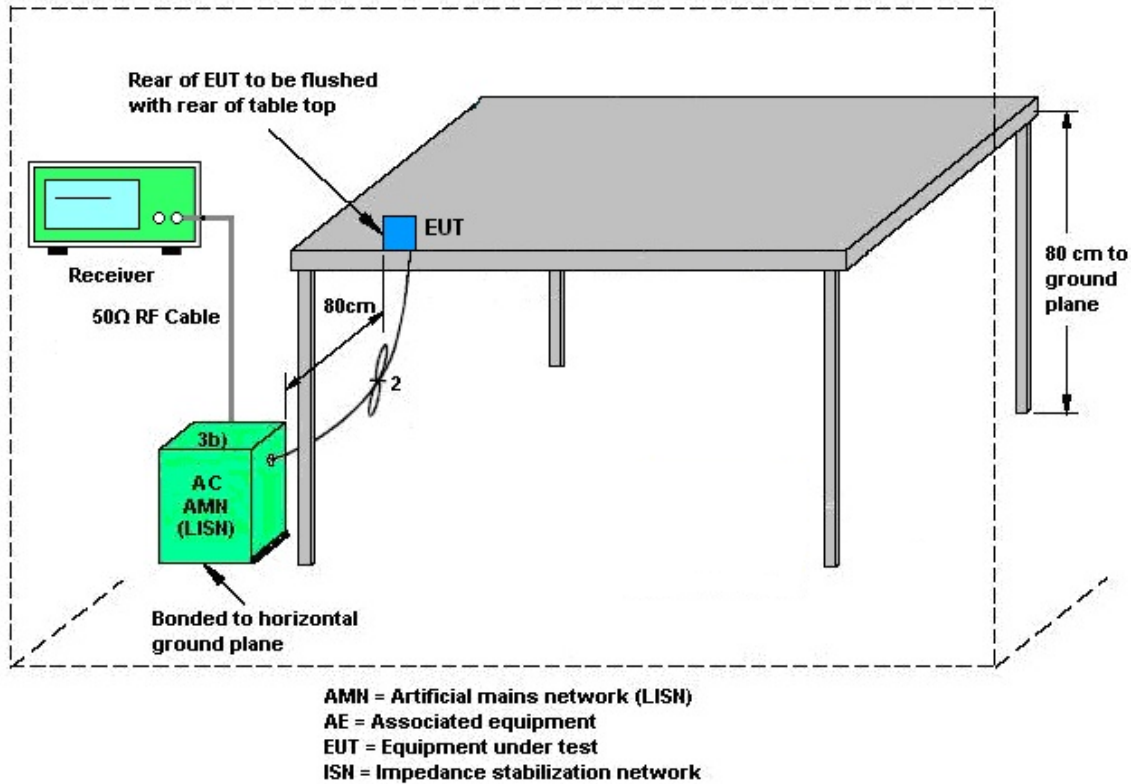

### 3.6.5 Test Result of AC Conducted Emission

Please refer to Appendix B.



## **3.7 Antenna Requirements**

### **3.7.1 Standard Applicable**

If directional gain of transmitting antennas is greater than 6 dBi, the power shall be reduced by the same level in dB comparing to gain minus 6 dBi. The use of a permanently attached antenna or of an antenna that uses a unique coupling to the intentional radiator shall be considered sufficient to comply with the rule.

### **3.7.2 Antenna Anti-Replacement Construction**

An embedded-in antenna design is used.

### **3.7.3 Antenna Gain**

The antenna peak gain of EUT is less than 6 dBi. Therefore, it is not necessary to reduce maximum peak output power limit.



## 4 List of Measuring Equipment

Instrument	Brand Name	Model No.	Serial No.	Characteristics	Calibration Date	Test Date	Due Date	Remark
Loop Antenna	R&S	HFH2-Z2E	100840	9kHz~30MHz	Jun. 21, 2021	Aug. 15, 2021~ Nov. 29, 2021	Jun. 20, 2022	Radiation (03CH02-CA)
Bilog Antenna	TESEQ	6111D	50392	30MHz~1GHz	Aug. 10, 2021	Aug. 15, 2021~ Nov. 29, 2021	Aug. 09, 2022	Radiation (03CH02-CA)
Horn Antenna	SCHWARZBE CK	BBHA 9120D	02113	1GHz~18GHz	Jul. 08, 2021	Aug. 15, 2021~ Nov. 29, 2021	Jul. 07, 2022	Radiation (03CH02-CA)
Horn Antenna	SCHWARZBE CK	BBHA 9120D	01895	1GHz~18GHz	Aug. 25, 2021	Aug. 26, 2021~ Nov. 29, 2021	Aug. 24, 2022	Radiation (03CH02-CA)
Horn Antenna	SCHWARZBE CK	BBHA 9170D	00842	18GHz~40GHz	Jul. 20, 2021	Aug. 15, 2021~ Nov. 29, 2021	Jul. 19, 2022	Radiation (03CH02-CA)
Amplifier	SONOMA	310N	372240	N/A	Aug. 09, 2021	Aug. 15, 2021~ Nov. 29, 2021	Aug. 08, 2022	Radiation (03CH02-CA)
Preamplifier	Keysight	83017A	MY53270323	1GHz~26.5GHz	Jul. 27, 2021	Aug. 15, 2021~ Nov. 29, 2021	Jul. 26, 2022	Radiation (03CH02-CA)
Preamplifier	E-instrument	ERA-100M-18 G-56-01-A70	EC1900251	1GHz~18GHz	Mar. 30, 2021	Aug. 15, 2021~ Nov. 29, 2021	Mar. 29, 2022	Radiation (03CH02-CA)
Preamplifier	Jet-Power	JPA0118-55-30 3	17100018000 55004	1GHz~18GHz	Jul. 21, 2021	Aug. 15, 2021~ Nov. 29, 2021	Jul. 20, 2022	Radiation (03CH02-CA)
Preamplifier	EMEC	EMC18G40G	60725	18GHz~40GHz	Jul. 21, 2021	Aug. 15, 2021~ Nov. 29, 2021	Jul. 20, 2022	Radiation (03CH02-CA)
Spectrum Analyzer	Keysight	N9010A	MY54200485	10Hz~44GHz	Mar. 05, 2021	Aug. 15, 2021~ Nov. 29, 2021	Mar. 04, 2022	Radiation (03CH02-CA)
Spectrum Analyzer	Keysight	N9010A	MY57420221	10Hz~44GHz	Sep. 22, 2021	Sep. 23, 2021~ Nov. 29, 2021	Sep. 21, 2022	Radiation (03CH02-CA)
Filter	Wainwright	WHKX12-2700 -3000-18000-6 OST	SN10	3G High pass	Jul. 23, 2021	Aug. 15, 2021~ Nov. 29, 2021	Jul. 22, 2022	Radiation (03CH02-CA)
Filter	Wainwright	WLK12-1200-1 272-11000-40 SS	SN1	1.2G Low Pass	Jul. 23, 2021	Aug. 15, 2021~ Nov. 29, 2021	Jul. 22, 2022	Radiation (03CH02-CA)
Hygrometer	TESEO	608-H1	45142602	N/A	Aug. 04, 2021	Aug. 15, 2021~ Nov. 29, 2021	Aug. 03, 2022	Radiation (03CH02-CA)
Controller	ChainTek	3000-1	N/A	Control Turn table & Ant Mast	N/A	Aug. 15, 2021~ Nov. 29, 2021	N/A	Radiation (03CH02-CA)
Antenna Mast	ChainTek	MBS-520-1	N/A	1m~4m	N/A	Aug. 15, 2021~ Nov. 29, 2021	N/A	Radiation (03CH02-CA)
Turn Table	ChainTek	T-200-S-1	N/A	0~360 Degree	N/A	Aug. 15, 2021~ Nov. 29, 2021	N/A	Radiation (03CH02-CA)
Software	Audix	E3	N/A	N/A	N/A	Aug. 15, 2021~ Nov. 29, 2021	N/A	Radiation (03CH02-CA)



Instrument	Brand Name	Model No.	Serial No.	Characteristics	Calibration Date	Test Date	Due Date	Remark
Hygrometer	Testo	608-H1	45141354	N/A	Jul. 30, 2021	Oct. 01, 2021~ Nov. 30, 2021	Jul. 29, 2022	Conducted (TH01-CA)
Power Sensor	DARE!!	RPR3006W	RPR6W-1901 024	10MHz-6GHz	Jul. 13, 2021	Oct. 01, 2021~ Nov. 30, 2021	Jul. 12, 2022	Conducted (TH01-CA)
Power Sensor	EM Electronics	RPR3006W#0 10	RPR6W-2101 003	10MHz-8GHz	Apr. 15, 2021	Nov. 30, 2021	Apr. 14, 2022	Conducted (TH01-CA)
Switch	EM Electronics	EMSW18	SW1070902	N/A	Aug. 03, 2021	Oct. 01, 2021~ Nov. 30, 2021	Aug. 02, 2022	Conducted (TH01-CA)
Switch Box& RF Cable	EM Electronics	EMSW26	1090304	N/A	Dec. 30, 2020	Nov. 30, 2021	Dec. 29, 2021	Conducted (TH01-CA)
Spectrum Analyzer	Rohde & Schwarz	FSV40	101545	10Hz-40GHz	Jun. 01, 2021	Oct. 01, 2021~ Nov. 30, 2021	May 31, 2022	Conducted (TH01-CA)
Spectrum Analyzer	Rohde & Schwarz	FSV40	101089	10Hz-40GHz	Jun. 02, 2021	Nov. 30, 2021	Jun. 01, 2022	Conducted (TH01-CA)
LISN	TESEQ	NNB51	47407	N/A	Jul. 21, 2021	Dec. 17, 2021	Jul. 20, 2022	Conduction (CO01-CA)
EMI Test Receiver	R&S	ESR7	102177	9KHz~7GHz	Jun. 02, 2021	Dec. 17, 2021	Jun. 01, 2022	Conduction (CO01-CA)
Pulse limiter with 10dB attenuation	R&S	VTSD 9561-F N	9561-F- N00412	N/A	Jul. 07, 2021	Dec. 17, 2021	Jul. 06, 2022	Conduction (CO01-CA)
Test Software	R&S	EMC32 V10.30.0	N/A	N/A	N/A	Dec. 17, 2021	N/A	Conduction (CO01-CA)



## 5 Uncertainty of Evaluation

### Uncertainty of Conducted Emission Measurement (150 kHz ~ 30 MHz)

Measuring Uncertainty for a Level of Confidence of 95% ( $U = 2Uc(y)$ )	2.0 dB
---	--------

### Uncertainty of Radiated Emission Measurement (30 MHz ~ 1000 MHz)

Measuring Uncertainty for a Level of Confidence of 95% ( $U = 2Uc(y)$ )	4.7 dB
---	--------

### Uncertainty of Radiated Emission Measurement (1000 MHz ~ 18000 MHz)

Measuring Uncertainty for a Level of Confidence of 95% ( $U = 2Uc(y)$ )	6.2 dB
---	--------

### Uncertainty of Radiated Emission Measurement (18000 MHz ~ 40000 MHz)

Measuring Uncertainty for a Level of Confidence of 95% ( $U = 2Uc(y)$ )	6.5 dB
---	--------

**Appendix A. Test Result of Conducted Test Items**

Test Engineer:	Steve Chen, Liliana Gonzalez	Temperature:	17.1~22.5	°C
Test Date:	2021/10/1~2021/11/30	Relative Humidity:	32.40~54.80	%

**TEST RESULTS DATA**  
**6dB and 99% Occupied Bandwidth**

Mod.	Data Rate	N <sub>TX</sub>	CH.	Freq. (MHz)	99% Occupied BW (MHz)	6dB BW (MHz)	6dB BW Limit (MHz)	Pass/Fail
BLE	1Mbps	1	0	2402	1.035	0.698	0.50	Pass
BLE	1Mbps	1	19	2440	1.035	0.698	0.50	Pass
BLE	1Mbps	1	38	2478	1.025	0.656	0.50	Pass
BLE	1Mbps	1	39	2480	1.035	0.692	0.50	Pass

**TEST RESULTS DATA**  
**Average Power Table**

Mod.	Data Rate	N <sub>TX</sub>	CH.	Freq. (MHz)	Average Conducted Power (dBm)	Conducted Power Limit (dBm)	DG (dBi)	EIRP Power (dBm)	EIRP Power Limit (dBm)	Pass /Fail
BLE	1Mbps	1	0	2402	15.71	30.00	3.00	18.71	36.00	Pass
BLE	1Mbps	1	19	2440	18.61	30.00	3.00	21.61	36.00	Pass
BLE	1Mbps	1	38	2478	11.21	30.00	3.00	14.21	36.00	Pass
BLE	1Mbps	1	39	2480	11.21	30.00	3.00	14.21	36.00	Pass

**TEST RESULTS DATA**  
**Peak Power Density**

Mod.	Data Rate	N <sub>TX</sub>	CH.	Freq. (MHz)	Peak PSD (dBm /100kHz)	Peak PSD (dBm /3kHz)	DG (dBi)	Peak PSD Limit (dBm /3kHz)	Pass/Fail
BLE	1Mbps	1	0	2402	14.72	-0.19	3.00	8.00	Pass
BLE	1Mbps	1	19	2440	18.30	3.38	3.00	8.00	Pass
BLE	1Mbps	1	38	2478	17.55	3.09	3.00	8.00	Pass
BLE	1Mbps	1	39	2480	10.60	-4.29	3.00	8.00	Pass

Note: PSD (dBm/ 100kHz) is a reference level used for Conducted Band Edges and Conducted Spurious Emission 30dBc limit.





## Appendix B. AC Conducted Emission Test Results

Test Engineer :	Paul Lin	Temperature :	18~21°C
		Relative Humidity :	42~45%

# EUT Information

Test Site Location : CO01-CA  
 Power: 120Vac/60Hz  
 Mode: 1  
 Type: Line

Full Spectrum

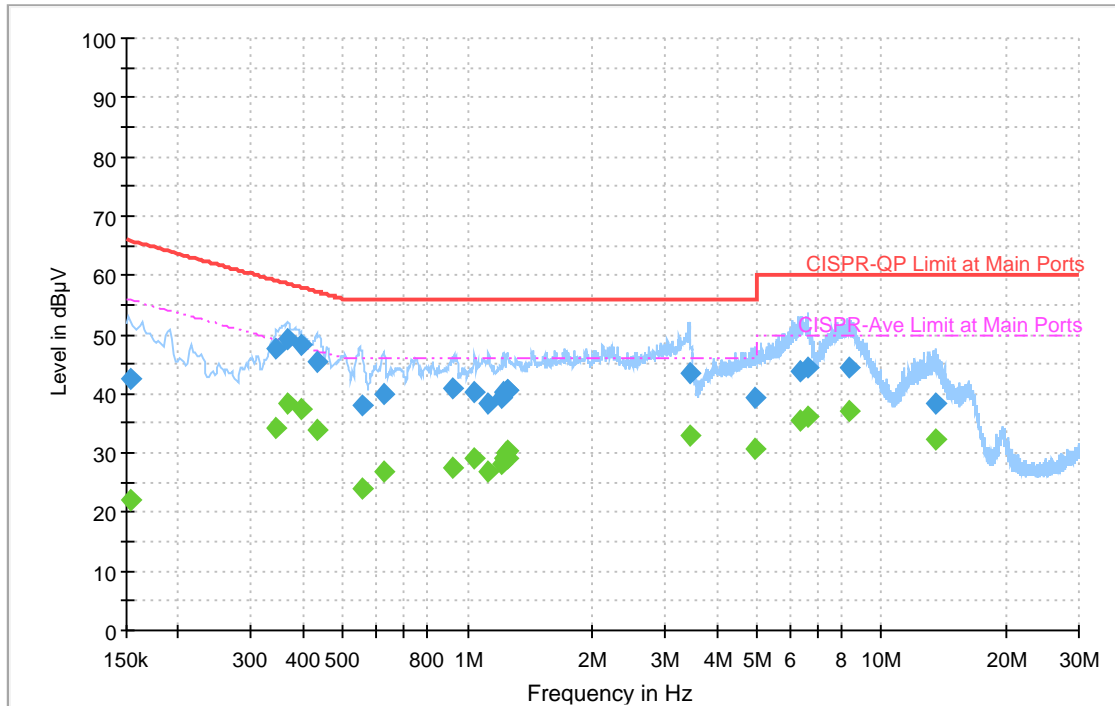

## Final Result

Frequency (MHz)	QuasiPeak (dBµV)	CAverage (dBµV)	Limit (dBµV)	Margin (dB)	Line	Filter	Corr. (dB)
0.152842	---	22.07	55.84	33.77	L1	OFF	20.3
0.152842	42.47	---	65.84	23.37	L1	OFF	20.3
0.344679	---	34.08	49.09	15.01	L1	OFF	20.3
0.344679	47.68	---	59.09	11.41	L1	OFF	20.3
0.368988	---	38.28	48.52	10.24	L1	OFF	20.3
0.368988	49.25	---	58.52	9.27	L1	OFF	20.3
0.395673	---	37.35	47.94	10.59	L1	OFF	20.3
0.395673	48.33	---	57.94	9.61	L1	OFF	20.3
0.431682	---	33.88	47.22	13.34	L1	OFF	20.3
0.431682	45.30	---	57.22	11.92	L1	OFF	20.3
0.554001	---	24.08	46.00	21.92	L1	OFF	20.3
0.554001	37.99	---	56.00	18.01	L1	OFF	20.3
0.624975	---	26.87	46.00	19.13	L1	OFF	20.3
0.624975	39.81	---	56.00	16.19	L1	OFF	20.3
0.921750	---	27.42	46.00	18.58	L1	OFF	20.3
0.921750	40.99	---	56.00	15.01	L1	OFF	20.3
1.037688	---	29.05	46.00	16.95	L1	OFF	20.3
1.037688	40.23	---	56.00	15.77	L1	OFF	20.3
1.120443	---	26.86	46.00	19.14	L1	OFF	20.3
1.120443	38.19	---	56.00	17.81	L1	OFF	20.3
1.212459	---	28.21	46.00	17.79	L1	OFF	20.3

Frequency (MHz)	QuasiPeak (dBµV)	CAverage (dBµV)	Limit (dBµV)	Margin (dB)	Line	Filter	Corr. (dB)
1.212459	39.44	---	56.00	16.56	L1	OFF	20.3
1.226589	---	28.92	46.00	17.08	L1	OFF	20.3
1.226589	40.12	---	56.00	15.88	L1	OFF	20.3
1.236498	---	29.92	46.00	16.08	L1	OFF	20.3
1.236498	40.32	---	56.00	15.68	L1	OFF	20.3
1.244814	---	30.43	46.00	15.57	L1	OFF	20.3
1.244814	40.65	---	56.00	15.35	L1	OFF	20.3
1.244904	---	29.20	46.00	16.80	L1	OFF	20.3
1.244904	40.50	---	56.00	15.50	L1	OFF	20.3
3.431787	---	32.95	46.00	13.05	L1	OFF	20.4
3.431787	43.40	---	56.00	12.60	L1	OFF	20.4
4.930359	---	30.75	46.00	15.25	L1	OFF	20.4
4.930359	39.17	---	56.00	16.83	L1	OFF	20.4
6.328041	---	35.54	50.00	14.46	L1	OFF	20.4
6.328041	43.91	---	60.00	16.09	L1	OFF	20.4
6.612828	---	36.14	50.00	13.86	L1	OFF	20.4
6.612828	44.35	---	60.00	15.65	L1	OFF	20.4
8.328966	---	36.93	50.00	13.07	L1	OFF	20.5
8.328966	44.33	---	60.00	15.67	L1	OFF	20.5
13.504650	---	32.27	50.00	17.73	L1	OFF	20.5
13.504650	38.47	---	60.00	21.53	L1	OFF	20.5

# EUT Information

Test Site Location : CO01-CA  
 Power: 120Vac/60Hz  
 Mode: 1  
 Type: Neutral

Full Spectrum

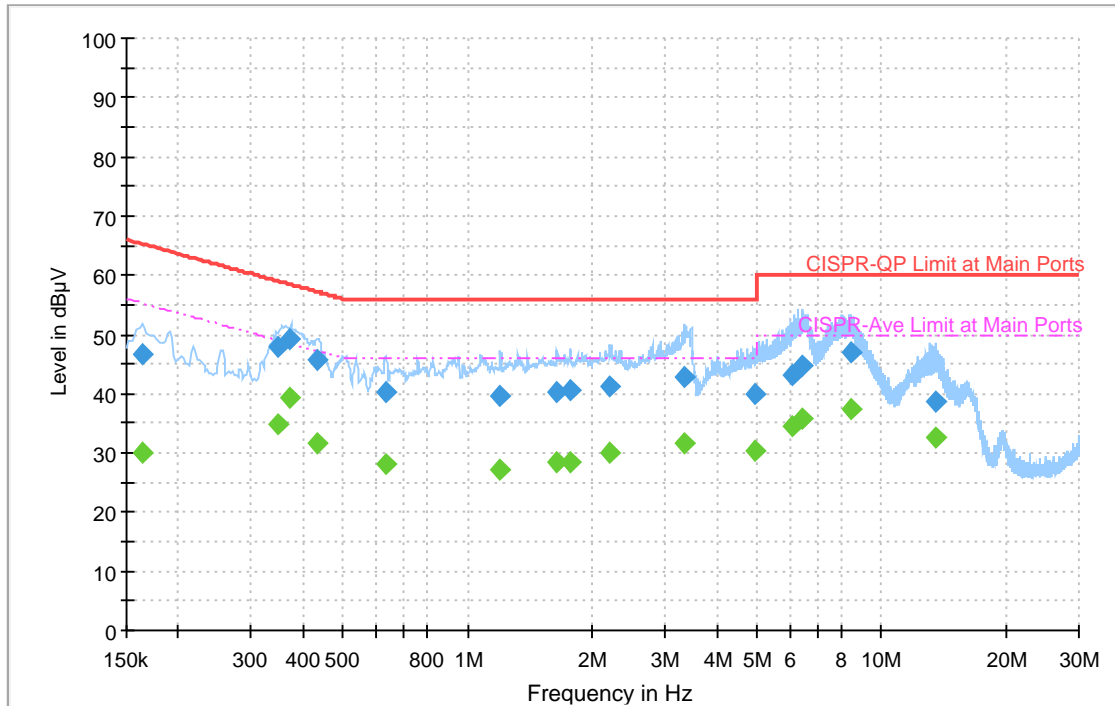

## Final Result

Frequency (MHz)	QuasiPeak (dBµV)	CAverage (dBµV)	Limit (dBµV)	Margin (dB)	Line	Filter	Corr. (dB)
0.164013	---	30.02	55.26	25.24	N	OFF	20.2
0.164013	46.57	---	65.26	18.69	N	OFF	20.2
0.346686	---	34.68	49.04	14.36	N	OFF	20.3
0.346686	47.93	---	59.04	11.11	N	OFF	20.3
0.371220	---	39.19	48.47	9.28	N	OFF	20.3
0.371220	49.18	---	58.47	9.29	N	OFF	20.3
0.431466	---	31.61	47.22	15.61	N	OFF	20.3
0.431466	45.58	---	57.22	11.64	N	OFF	20.3
0.634965	---	28.24	46.00	17.76	N	OFF	20.3
0.634965	40.28	---	56.00	15.72	N	OFF	20.3
1.201767	---	27.19	46.00	18.81	N	OFF	20.3
1.201767	39.64	---	56.00	16.36	N	OFF	20.3
1.643937	---	28.28	46.00	17.72	N	OFF	20.3
1.643937	40.41	---	56.00	15.59	N	OFF	20.3
1.769316	---	28.56	46.00	17.44	N	OFF	20.3
1.769316	40.70	---	56.00	15.30	N	OFF	20.3
2.210307	---	29.92	46.00	16.08	N	OFF	20.3
2.210307	41.21	---	56.00	14.79	N	OFF	20.3
3.341571	---	31.60	46.00	14.40	N	OFF	20.3
3.341571	42.83	---	56.00	13.17	N	OFF	20.3
4.944102	---	30.33	46.00	15.67	N	OFF	20.4

---

Frequency (MHz)	QuasiPeak (dBμV)	CAverage (dBμV)	Limit (dBμV)	Margin (dB)	Line	Filter	Corr. (dB)
4.944102	39.82	---	56.00	16.18	N	OFF	20.4
6.084978	---	34.41	50.00	15.59	N	OFF	20.4
6.084978	43.29	---	60.00	16.71	N	OFF	20.4
6.428850	---	35.93	50.00	14.07	N	OFF	20.4
6.428850	44.78	---	60.00	15.22	N	OFF	20.4
8.447487	---	37.29	50.00	12.71	N	OFF	20.4
8.447487	46.85	---	60.00	13.15	N	OFF	20.4
13.513740	---	32.58	50.00	17.42	N	OFF	20.5
13.513740	38.75	---	60.00	21.25	N	OFF	20.5

---



### Appendix C. Radiated Spurious Emission

Test Engineer :	Michael Bui and Daniel Lee	Temperature :	20~24°C
		Relative Humidity :	42~48%

2.4GHz 2400~2483.5MHz

BLE (Band Edge @ 3m)

BLE	Note	Frequency	Level	Over	Limit	Read	Antenna	Path	Preamp	Ant	Table	Peak	Pol.	
		( MHz )	( dBμV/m )	( dB )	Limit	Level	Factor	Loss	Factor	Pos	Pos	Avg.		
					Line	( dBμV )	( dB/m )	( dB )	( dB )	( cm )	( deg )	( P/A )	( H/V )	
BLE CH 00 2402MHz		2363.76	59.21	-14.79	74	45.14	27.86	17.51	31.3	106	57	P	H	
		2363.55	52.85	-1.15	54	38.78	27.86	17.51	31.3	106	57	A	H	
	*	2402	115.77	-	-	101.85	27.62	17.57	31.27	106	57	P	H	
	*	2402	115.24	-	-	101.32	27.62	17.57	31.27	106	57	A	H	
			2363.445	57.3	-16.7	74	43.08	28.01	17.51	31.3	179	28	P	V
			2363.655	48.58	-5.42	54	34.36	28.01	17.51	31.3	179	28	A	V
	*		2402	108.56	-	-	94.28	27.98	17.57	31.27	179	28	P	V
	*		2402	108.04	-	-	93.76	27.98	17.57	31.27	179	28	A	V
BLE CH 19 2440MHz		2358.64	56.78	-17.22	74	42.69	27.89	17.5	31.3	172	54	P	H	
		2350.64	44.95	-9.05	54	30.82	27.95	17.48	31.3	172	54	A	H	
	*	2440	119.25	-	-	105.36	27.5	17.65	31.26	172	54	P	H	
	*	2440	118.71	-	-	104.82	27.5	17.65	31.26	172	54	A	H	
			2491.84	56.55	-17.45	74	42.54	27.48	17.76	31.23	172	54	P	H
			2500	45.11	-8.89	54	31.08	27.48	17.78	31.23	172	54	A	H
			2376.4	56.22	-17.78	74	41.91	28.07	17.53	31.29	169	30	P	V
			2380.24	45.04	-8.96	54	30.7	28.09	17.54	31.29	169	30	A	V
	*		2440	114.42	-	-	100.33	27.7	17.65	31.26	169	30	P	V
	*		2440	113.88	-	-	99.79	27.7	17.65	31.26	169	30	A	V
			2487.92	56.09	-17.91	74	42.05	27.52	17.76	31.24	169	30	P	V
			2495.84	44.9	-9.1	54	30.85	27.51	17.77	31.23	169	30	A	V



<b>BLE CH 38 2478MHz</b>	*	2478	115.3	-	-	101.17	27.63	17.74	31.24	154	304	P	H
	*	2478	115.07	-	-	100.94	27.63	17.74	31.24	154	304	A	H
		2483.6	62.77	-11.23	74	48.64	27.62	17.75	31.24	154	304	P	H
		2483.52	52.71	-1.29	54	38.58	27.62	17.75	31.24	154	304	A	H
	*	2478	109.99	-	-	95.97	27.52	17.74	31.24	207	42	P	V
	*	2478	109.76	-	-	95.74	27.52	17.74	31.24	207	42	A	V
		2483.72	58.47	-15.53	74	44.45	27.51	17.75	31.24	207	42	P	V
		2483.52	48.79	-5.21	54	34.77	27.51	17.75	31.24	207	42	A	V
<b>BLE CH 39 2480MHz</b>	*	2480	112.36	-	-	98.38	27.48	17.74	31.24	217	53	P	H
	*	2480	111.85	-	-	97.87	27.48	17.74	31.24	217	53	A	H
		2484.12	63.74	-10.26	74	49.75	27.48	17.75	31.24	217	53	P	H
		2483.52	53.74	-0.26	54	39.75	27.48	17.75	31.24	217	53	A	H
	*	2480	107.23	-	-	93.2	27.53	17.74	31.24	192	26	P	V
	*	2480	106.71	-	-	92.68	27.53	17.74	31.24	192	26	A	V
		2483.76	60.07	-13.93	74	46.04	27.52	17.75	31.24	192	26	P	V
		2483.52	49.74	-4.26	54	35.71	27.52	17.75	31.24	192	26	A	V
<b>Remark</b>	1. No other spurious found.												
	2. All results are PASS against Peak and Average limit line.												



2.4GHz 2400~2483.5MHz  
BLE (Harmonic @ 3m)

BLE	Note	Frequency ( MHz )	Level ( dBµV/m )	Over Limit ( dB )	Limit Line ( dBµV/m )	Read Level ( dBµV )	Antenna Factor ( dB/m )	Path Loss ( dB )	Preamp Factor ( dB )	Ant Pos ( cm )	Table Pos ( deg )	Peak Avg. ( P/A )	Pol. ( H/V )	
BLE CH 00 2402MHz		4804	47.98	-26.02	74	61.22	31.43	11.48	56.15	-	-	P	H	
		11460	51.36	-22.64	74	53.01	40.15	17.41	59.21	-	-	P	H	
		11460	40.97	-13.03	54	42.62	40.15	17.41	59.21	-	-	A	H	
		13965	53.37	-20.63	74	54.59	40.73	19.55	61.5	-	-	P	H	
		13965	41.32	-12.68	54	42.54	40.73	19.55	61.5	-	-	A	H	
		18000	60.84	-13.16	74	45.6	48.43	22.97	56.16	-	-	P	H	
		18000	50.64	-3.36	54	35.4	48.43	22.97	56.16	-	-	A	H	
			4804	47.13	-26.87	74	60.39	31.41	11.48	56.15	-	-	P	V
			11445	52.16	-21.84	74	53.75	40.2	17.4	59.19	-	-	P	V
		11445	41.36	-12.64	54	42.95	40.2	17.4	59.19	-	-	A	V	
		14925	53.24	-20.76	74	53.11	40.97	20.19	61.03	-	-	P	V	
		14925	42.79	-11.21	54	42.66	40.97	20.19	61.03	-	-	A	V	
		18000	60.51	-13.49	74	45.69	48.01	22.97	56.16	-	-	P	V	
		18000	50.19	-3.81	54	35.37	48.01	22.97	56.16	-	-	A	V	





BLE	Note	Frequency ( MHz )	Level ( dBµV/m )	Over Limit ( dB )	Limit Line ( dBµV/m )	Read Level ( dBµV )	Antenna Factor ( dB/m )	Path Loss ( dB )	Preamp Factor ( dB )	Ant Pos ( cm )	Table Pos ( deg )	Peak Avg. ( P/A )	Pol. ( H/V )	
BLE CH 19 2440MHz		4880	47.83	-26.17	74	60.96	31.44	11.62	56.19	-	-	P	H	
		7320	47.86	-26.14	74	54.02	36.41	13.82	56.39	-	-	P	H	
		11460	53.06	-20.94	74	54.71	40.15	17.41	59.21	-	-	P	H	
		11460	40.88	-13.12	54	42.53	40.15	17.41	59.21	-	-	A	H	
		14760	53.88	-20.12	74	53.32	41.6	20.09	61.13	-	-	P	H	
		14760	42.86	-11.14	54	42.3	41.6	20.09	61.13	-	-	A	H	
		17985	60.3	-13.7	74	45.5	48.05	22.95	56.2	-	-	P	H	
		17985	50.65	-3.35	54	35.85	48.05	22.95	56.2	-	-	A	H	
			4880	46.58	-27.42	74	59.62	31.53	11.62	56.19	-	-	P	V
			7320	47.78	-26.22	74	54	36.35	13.82	56.39	-	-	P	V
			11400	52.78	-21.22	74	54.57	40.07	17.36	59.22	-	-	P	V
			11400	41.32	-12.68	54	43.11	40.07	17.36	59.22	-	-	A	V
			14895	53.78	-20.22	74	53.6	41.08	20.17	61.07	-	-	P	V
			14895	43.06	-10.94	54	42.88	41.08	20.17	61.07	-	-	A	V
		17985	60.61	-13.39	74	46.2	47.66	22.95	56.2	-	-	P	V	
		17985	50.06	-3.94	54	35.65	47.66	22.95	56.2	-	-	A	V	





BLE	Note	Frequency ( MHz )	Level ( dBμV/m )	Over Limit ( dB )	Limit Line ( dBμV/m )	Read Level ( dBμV )	Antenna Factor ( dB/m )	Path Loss ( dB )	Preamp Factor ( dB )	Ant Pos ( cm )	Table Pos ( deg )	Peak Avg. ( P/A )	Pol. ( H/V )	
BLE CH 39 2480MHz		4960	52.26	-21.74	74	65.5	31.54	11.46	56.24	111	297	P	H	
		4960	48.41	-5.59	54	61.65	31.54	11.46	56.24	111	297	A	H	
		7440	46.01	-27.99	74	51.74	36.59	13.9	56.22	-	-	P	H	
		11445	52.54	-21.46	74	54.18	40.15	17.4	59.19	-	-	P	H	
		11445	41.1	-12.9	54	42.74	40.15	17.4	59.19	-	-	A	H	
		14670	52.98	-21.02	74	52.5	41.7	20.02	61.24	-	-	P	H	
		14670	43.37	-10.63	54	42.89	41.7	20.02	61.24	-	-	A	H	
		17985	60.54	-13.46	74	45.74	48.05	22.95	56.2	-	-	P	H	
		17985	50.13	-3.87	54	35.33	48.05	22.95	56.2	-	-	A	H	
			4960	52.82	-21.18	74	66.13	31.47	11.46	56.24	321	345	P	V
			4960	49.28	-4.72	54	62.59	31.47	11.46	56.24	321	345	A	V
			7440	46.32	-27.68	74	52.22	36.42	13.9	56.22	-	-	P	V
			11520	51.6	-22.4	74	53.2	40.22	17.46	59.28	-	-	P	V
			11520	40.5	-13.5	54	42.1	40.22	17.46	59.28	-	-	A	V
			14685	54.06	-19.94	74	53.59	41.65	20.03	61.21	-	-	P	V
			14685	42.69	-11.31	54	42.22	41.65	20.03	61.21	-	-	A	V
			18000	60.52	-13.48	74	45.7	48.01	22.97	56.16	-	-	P	V
		18000	50.71	-3.29	54	35.89	48.01	22.97	56.16	-	-	A	V	
<b>Remark</b>	<ol style="list-style-type: none"> <li>No other spurious found.</li> <li>All results are PASS against Peak and Average limit line.</li> <li>The emission position marked as "-" means no suspected emission found and emission level has at least 6dB margin against limit or noise floor only.</li> <li>The emission level close to 18GHz is checked that the average emission level is noise floor only.</li> </ol>													



Emission above 18GHz

2.4GHz BLE (SHF)

BLE	Note	Frequency	Level	Over	Limit	Read	Antenna	Path	Preamp	Ant	Table	Peak	Pol.	
		( MHz )	( dBμV/m )	( dB )	( dBμV/m )	( dBμV )	( dB/m )	( dB )	( dB )	( cm )	( deg )	( P/A )	( H/V )	
2.4GHz BLE SHF		23576	44.57	-29.43	74	41.77	38.74	15.49	51.43	-	-	P	H	
		25990	46.11	-27.89	74	41.25	39.06	17.57	51.77	-	-	P	H	
			23567.5	43.8	-30.2	74	41	38.75	15.49	51.44	-	-	P	V
			25446	44.76	-29.24	74	40.09	39.11	17.13	51.57	-	-	P	V
	<b>Remark</b>	<ol style="list-style-type: none"> <li>No other spurious found.</li> <li>All results are PASS against limit line.</li> <li>The emission position marked as “-” means no suspected emission found and emission level has at least 6dB margin against limit or noise floor only.</li> </ol>												



Emission below 1GHz

2.4GHz BLE (LF)

BLE	Note	Frequency	Level	Over	Limit	Read	Antenna	Path	Preamp	Ant	Table	Peak	Pol.	
		( MHz )	( dBμV/m )	( dB )	( dBμV/m )	( dBμV )	( dB/m )	( dB )	( dB )	( cm )	( deg )	( P/A )	( H/V )	
2.4GHz BLE LF		62.01	31.71	-8.29	40	51.06	11.7	1.38	32.43	-	-	P	H	
		323.91	32.61	-13.39	46	42.61	19.48	2.97	32.45	-	-	P	H	
		427.7	32.25	-13.75	46	38.53	22.65	3.58	32.51	-	-	P	H	
		749.74	36	-10	46	35.73	27.99	4.66	32.38	-	-	P	H	
		874.87	38.36	-7.64	46	36.1	29.1	4.94	31.78	135	205	Q	H	
		874.87	42.06	-3.94	46	39.8	29.1	4.94	31.78	135	205	P	H	
		920.46	39.1	-6.9	46	35.95	29.51	5.09	31.45	-	-	P	H	
			33.88	33.91	-6.09	40	42.31	23.06	0.98	32.44	-	-	P	V
			62.98	33.4	-6.6	40	52.64	11.8	1.39	32.43	-	-	P	V
			422.85	37.67	-8.33	46	44.04	22.56	3.58	32.51	-	-	P	V
			754.59	32.6	-13.4	46	32.31	28	4.66	32.37	-	-	P	V
			874.87	38.16	-7.84	46	35.9	29.1	4.94	31.78	-	-	P	V
			935.98	35.9	-10.1	46	31.98	30.06	5.18	31.32	-	-	P	V
Remark	1. No other spurious found. 2. All results are PASS against limit line. 3. The emission position marked as "-" means no suspected emission found and emission level has at least 6dB margin against limit or noise floor only.													



**Note symbol**

*	<b>Fundamental Frequency</b> which can be ignored. However, the level of any unweeded emissions shall not exceed the level of the fundamental frequency.
!	Test result is <b>over limit</b> line.
P/A	<b>Peak</b> or <b>Average</b>
H/V	<b>Horizontal</b> or <b>Vertical</b>



A calculation example for radiated spurious emission is shown as below:

BLE	Note	Frequency	Level	Over	Limit	Read	enna	Path	Preamp		Table	Peak	Pol.
		( MHz )	( dBμV/m )	( dB )	Line	Level	Factor	Loss	Factor	Pos	Pos	Avg.	
					( dBμV/m )	( dBμV )	( dB/m )	( dB )	( dB )	( cm )	( deg )	( P/A )	( H/V )
BLE		2390	55.45	-18.55	74	54.51	32.22	4.58	35.86	103	308	P	H
CH 00		2390	43.54	-10.46	54	42.6	32.22	4.58	35.86	103	308	A	H
2402MHz													

1. Path Loss(dB) = Cable loss(dB) + Filter loss(dB) + Attenuator loss(dB)
2. Level(dBμV/m) =  
enna Factor(dB/m) + Path Loss(dB) + Read Level(dBμV) - Preamp Factor(dB)
3. Over Limit(dB) = Level(dBμV/m) – Limit Line(dBμV/m)

**For Peak Limit @ 2390MHz:**

1. Level(dBμV/m)  
= enna Factor(dB/m) + Path Loss(dB) + Read Level(dBμV) - Preamp Factor(dB)  
= 32.22(dB/m) + 4.58(dB) + 54.51(dBμV) – 35.86 (dB)  
= 55.45 (dBμV/m)
2. Over Limit(dB)  
= Level(dBμV/m) – Limit Line(dBμV/m)  
= 55.45(dBμV/m) – 74(dBμV/m)  
= -18.55(dB)

**For Average Limit @ 2390MHz:**

1. Level(dBμV/m)  
= enna Factor(dB/m) + Path Loss(dB) + Read Level(dBμV) - Preamp Factor(dB)  
= 32.22(dB/m) + 4.58(dB) + 42.6(dBμV) – 35.86 (dB)  
= 43.54 (dBμV/m)
2. Over Limit(dB)  
= Level(dBμV/m) – Limit Line(dBμV/m)  
= 43.54(dBμV/m) – 54(dBμV/m)  
= -10.46(dB)

**Both peak and average measured complies with the limit line, so test result is “PASS”.**



## Appendix D. Radiated Spurious Emission Plots

Test Engineer :	Michael Bui and Daniel Lee	Temperature :	20~24°C
		Relative Humidity :	42~48%

**Note symbol**

-L	Low channel location
-R	High channel location



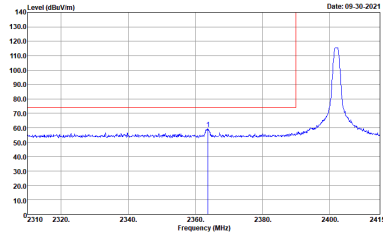
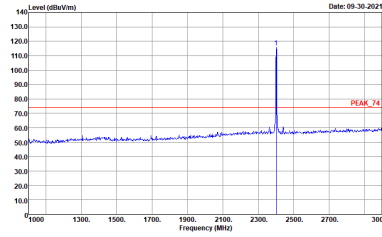
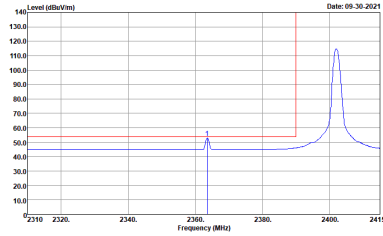
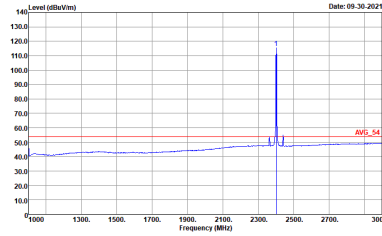

2.4GHz 2400~2483.5MHz  
BLE (Band Edge @ 3m)

BLE	2.4GHz 2400~2483.5MHz Band Edge @ 3m	
BLE CH00 2402MHz		
Horizontal		Fundamental
Peak	 <p>Site : 03CH02-CA Condition : PEAK_BE_74 3m HORN 91200-HF_02113 HORIZONTAL : RBW:1000.000KHz VBW:3000.000KHz SWT:Auto</p>	 <p>Site : 03CH02-CA Condition : PEAK_74 3m HORN 91200-HF_02113 HORIZONTAL : RBW:1000.000KHz VBW:3000.000KHz SWT:Auto</p>
Avg.	 <p>Site : 03CH02-CA Condition : AVG_BE_54 3m HORN 91200-HF_02113 HORIZONTAL : RBW:1000.000KHz VBW:0.010KHz SWT:Auto</p>	 <p>Site : 03CH02-CA Condition : AVG_54 3m HORN 91200-HF_02113 HORIZONTAL : RBW:1000.000KHz VBW:0.010KHz SWT:Auto</p>

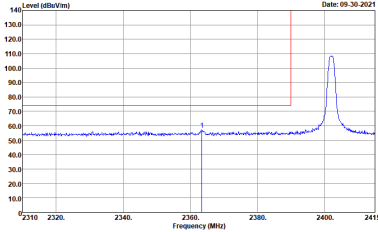
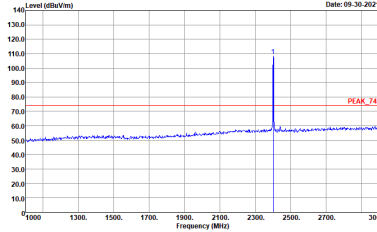
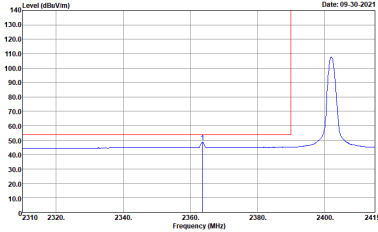
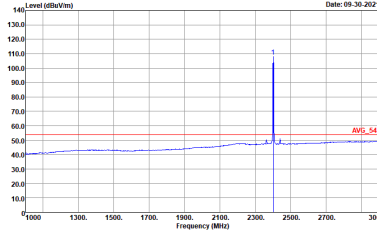

BLE	2.4GHz 2400~2483.5MHz Band Edge @ 3m	
BLE CH00 2402MHz		
	Vertical	Fundamental
Peak	 <p>Date: 09-30-2021</p> <p>Site : 03CH02-CA Condition : PEAK_BE_74 3m HORN 91200-HF_02113 VERTICAL : RBW:1000.000KHz VBW:3000.000KHz SWT:Auto</p>	 <p>Date: 09-30-2021</p> <p>Site : 03CH02-CA Condition : PEAK_74 3m HORN 91200-HF_02113 VERTICAL : RBW:1000.000KHz VBW:3000.000KHz SWT:Auto</p>
Avg	 <p>Date: 09-30-2021</p> <p>Site : 03CH02-CA Condition : AV6_BE_54 3m HORN 91200-HF_02113 VERTICAL : RBW:1000.000KHz VBW:0.010KHz SWT:Auto</p>	 <p>Date: 09-30-2021</p> <p>Site : 03CH02-CA Condition : AV6_54 3m HORN 91200-HF_02113 VERTICAL : RBW:1000.000KHz VBW:0.010KHz SWT:Auto</p>

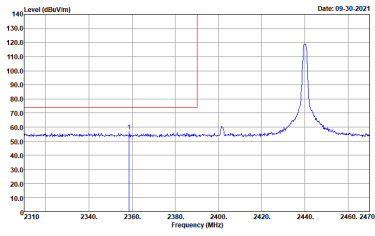
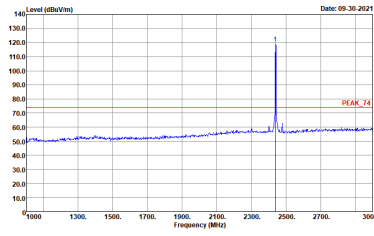
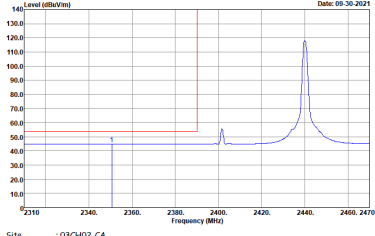
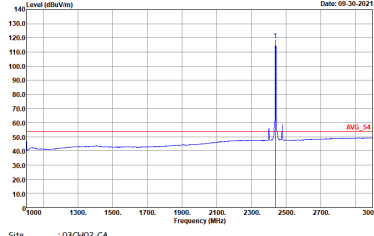

BLE	2.4GHz 2400~2483.5MHz Band Edge @ 3m	
	BLE CH19 2440MHz - L	
	Horizontal	Fundamental
Peak	 <p>Date: 09-30-2021</p> <p>Site : 03CH02-CA Condition : PEAK_BE_74 3m HORN 91200-HF_02113 HORIZONTAL : RBW:1000.000KHz VBW:3000.000KHz SWT:Auto</p>	 <p>Date: 09-30-2021</p> <p>Site : 03CH02-CA Condition : PEAK_74 3m HORN 91200-HF_02113 HORIZONTAL : RBW:1000.000KHz VBW:3000.000KHz SWT:Auto</p>
Avg.	 <p>Date: 09-30-2021</p> <p>Site : 03CH02-CA Condition : AVG_BE_54 3m HORN 91200-HF_02113 HORIZONTAL : RBW:1000.000KHz VBW:0.010KHz SWT:Auto</p>	 <p>Date: 09-30-2021</p> <p>Site : 03CH02-CA Condition : AVG_54 3m HORN 91200-HF_02113 HORIZONTAL : RBW:1000.000KHz VBW:0.010KHz SWT:Auto</p>

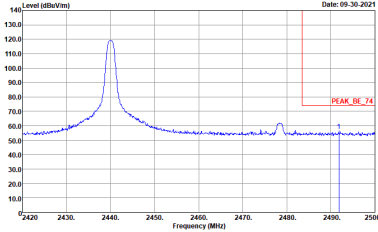
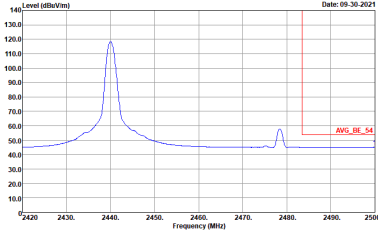

BLE	2.4GHz 2400~2483.5MHz Band Edge @ 3m	
BLE CH19 2440MHz - R		
	Horizontal	Fundamental
Peak	 <p>Site : 03CH02-CA Condition : PEAK_BE_74 3m HORN 91200-HF_02113 HORIZONTAL : RBW:1000.000KHz VBW:3000.000KHz SWF:Auto</p>	Left blank
Avg.	 <p>Site : 03CH02-CA Condition : AVG_BE_54 3m HORN 91200-HF_02113 HORIZONTAL : RBW:1000.000KHz VBW:0.010KHz SWF:Auto</p>	Left blank

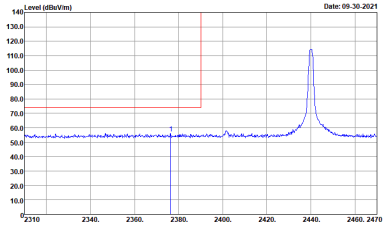
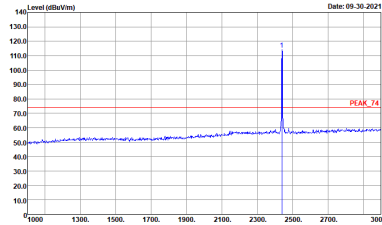
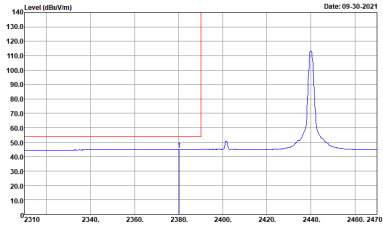
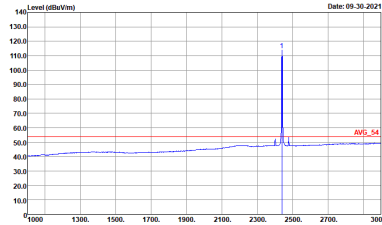

BLE	2.4GHz 2400~2483.5MHz Band Edge @ 3m	
BLE CH19 2440MHz - L		
	Vertical	Fundamental
Peak	 <p>Date: 09-30-2021</p> <p>Site : 03CH02-CA Condition : PEAK_BE_74 3m HORN 91200-HF_02113 VERTICAL : RBW:1000.000KHz VBW:3000.000KHz SWT:Auto</p>	 <p>Date: 09-30-2021</p> <p>Site : 03CH02-CA Condition : PEAK_74 3m HORN 91200-HF_02113 VERTICAL : RBW:1000.000KHz VBW:3000.000KHz SWT:Auto</p>
Avg.	 <p>Date: 09-30-2021</p> <p>Site : 03CH02-CA Condition : AV6_BE_54 3m HORN 91200-HF_02113 VERTICAL : RBW:1000.000KHz VBW:0.010KHz SWT:Auto</p>	 <p>Date: 09-30-2021</p> <p>Site : 03CH02-CA Condition : AV6_54 3m HORN 91200-HF_02113 VERTICAL : RBW:1000.000KHz VBW:0.010KHz SWT:Auto</p>



BLE	2.4GHz 2400~2483.5MHz Band Edge @ 3m	
	BLE CH19 2440MHz - R	
	Vertical	Fundamental
Peak	<p>Site : 03CH02-CA Condition : PEAK_BE_74 3m HORN 91200-HF_02113 VERTICAL : RBW:1000.000KHz VBW:3000.000KHz SWF:Auto</p>	Left blank
Avg.	<p>Site : 03CH02-CA Condition : AVG_BE_54 3m HORN 91200-HF_02113 VERTICAL : RBW:1000.000KHz VBW:0.010KHz SWF:Auto</p>	Left blank

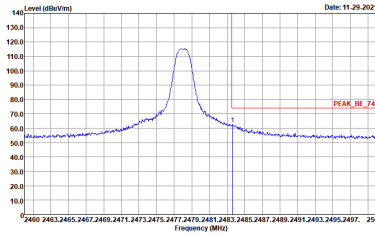
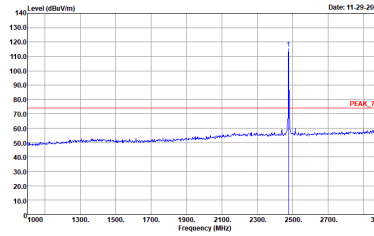
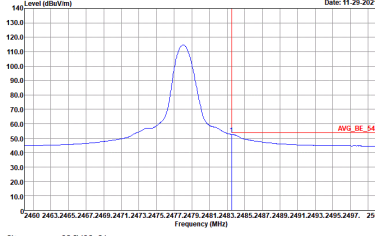
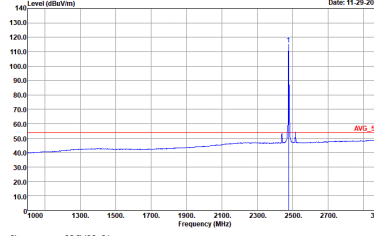

BLE	2.4GHz 2400~2483.5MHz Band Edge @ 3m	
BLE CH38 2478MHz		
	Horizontal	Fundamental
Peak	 <p>Level (dBm/1m) vs Frequency (MHz) plot showing a peak at 2478 MHz. The peak level is approximately 115 dBm/1m. A red horizontal line indicates the peak level, labeled 'PEAK_BE_74'.</p> <p>Site : 03CH02-CA            Condition : PEAK_BE_74 3m HORN-HF_01895_2021 HORIZONTAL            : RBW:1000.000KHz VBW:3000.000KHz SWT:Auto</p>	 <p>Level (dBm/1m) vs Frequency (MHz) plot showing a sharp peak at 2478 MHz. The peak level is approximately 115 dBm/1m. A red horizontal line indicates the peak level, labeled 'PEAK_74'.</p> <p>Site : 03CH02-CA            Condition : PEAK_74 3m HORN-HF_01895_2021 HORIZONTAL            : RBW:1000.000KHz VBW:3000.000KHz SWT:Auto</p>
Avg.	 <p>Level (dBm/1m) vs Frequency (MHz) plot showing the average spectrum. A red horizontal line indicates the average level, labeled 'AVG_BE_54'.</p> <p>Site : 03CH02-CA            Condition : AVG_BE_54 3m HORN-HF_01895_2021 HORIZONTAL            : RBW:1000.000KHz VBW:0.010KHz SWT:Auto</p>	 <p>Level (dBm/1m) vs Frequency (MHz) plot showing the average spectrum. A red horizontal line indicates the average level, labeled 'AVG_54'.</p> <p>Site : 03CH02-CA            Condition : AVG_54 3m HORN-HF_01895_2021 HORIZONTAL            : RBW:1000.000KHz VBW:0.010KHz SWT:Auto</p>

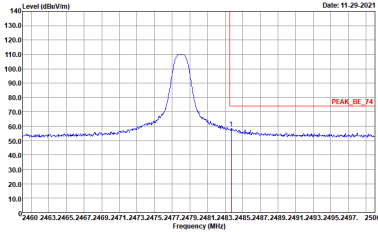
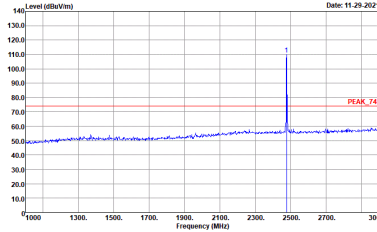
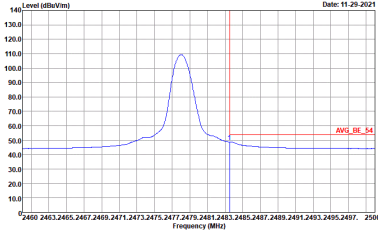
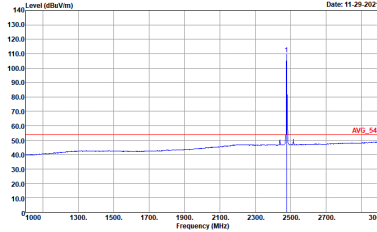

BLE	2.4GHz 2400~2483.5MHz Band Edge @ 3m	
BLE CH38 2478MHz		
	Vertical	Fundamental
Peak	 <p>Date: 11-29-2021</p> <p>Site : 03CH02-CA Condition : PEAK_BE_74 3m HORN-HF_01899_2021 VERTICAL : RBW:1000.000KHz VBW:3000.000KHz SWT:Auto</p>	 <p>Date: 11-29-2021</p> <p>Site : 03CH02-CA Condition : PEAK_74 3m HORN-HF_01899_2021 VERTICAL : RBW:1000.000KHz VBW:3000.000KHz SWT:Auto</p>
Avg.	 <p>Date: 11-29-2021</p> <p>Site : 03CH02-CA Condition : AVG_BE_54 3m HORN-HF_01899_2021 VERTICAL : RBW:1000.000KHz VBW:0.010KHz SWT:Auto</p>	 <p>Date: 11-29-2021</p> <p>Site : 03CH02-CA Condition : AVG_54 3m HORN-HF_01899_2021 VERTICAL : RBW:1000.000KHz VBW:0.010KHz SWT:Auto</p>



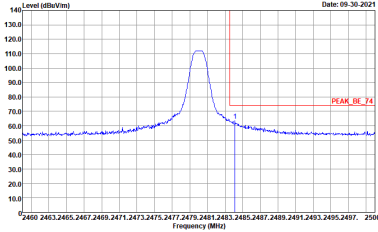
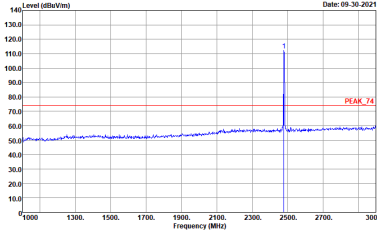
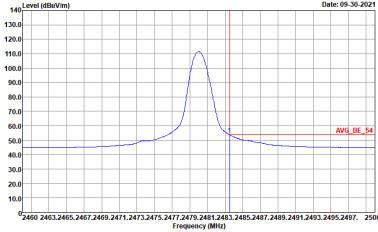
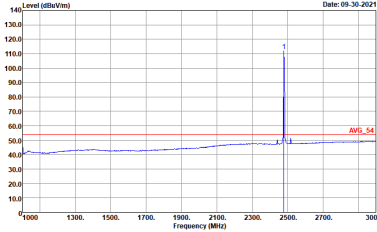

BLE	2.4GHz 2400~2483.5MHz Band Edge @ 3m	
BLE CH39 2480MHz		
	Horizontal	Fundamental
Peak	 <p>Site : 03CH02-CA Condition : PEAK_BE_74 3m HORN 91200-HF_02113 HORIZONTAL : RBW:1000.000KHz VBW:3000.000KHz SWT:Auto</p>	 <p>Site : 03CH02-CA Condition : PEAK_74 3m HORN 91200-HF_02113 HORIZONTAL : RBW:1000.000KHz VBW:3000.000KHz SWT:Auto</p>
Avg.	 <p>Site : 03CH02-CA Condition : AV6_BE_54 3m HORN 91200-HF_02113 HORIZONTAL : RBW:1000.000KHz VBW:0.010KHz SWT:Auto</p>	 <p>Site : 03CH02-CA Condition : AV6_54 3m HORN 91200-HF_02113 HORIZONTAL : RBW:1000.000KHz VBW:0.010KHz SWT:Auto</p>

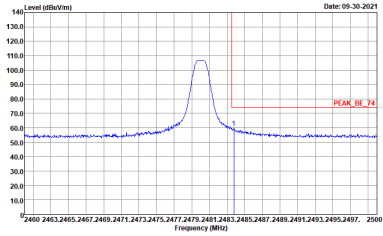
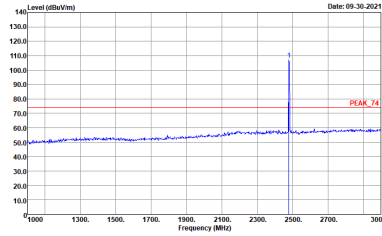
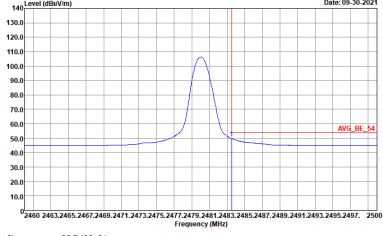
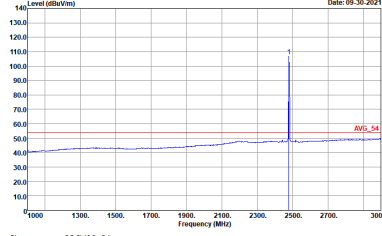

BLE	2.4GHz 2400~2483.5MHz Band Edge @ 3m	
BLE CH39 2480MHz		
	Vertical	Fundamental
Peak	 <p>Date: 09-30-2021</p> <p>Site : 03CH02-CA Condition : PEAK_BE_74 3m HORN 91200-HF_02113 VERTICAL : RBW:1000.000KHz VBW:3000.000KHz SWT:Auto</p>	 <p>Date: 09-30-2021</p> <p>Site : 03CH02-CA Condition : PEAK_74 3m HORN 91200-HF_02113 VERTICAL : RBW:1000.000KHz VBW:3000.000KHz SWT:Auto</p>
Avg.	 <p>Date: 09-30-2021</p> <p>Site : 03CH02-CA Condition : AVG_BE_54 3m HORN 91200-HF_02113 VERTICAL : RBW:1000.000KHz VBW:0.010KHz SWT:Auto</p>	 <p>Date: 09-30-2021</p> <p>Site : 03CH02-CA Condition : AVG_54 3m HORN 91200-HF_02113 VERTICAL : RBW:1000.000KHz VBW:0.010KHz SWT:Auto</p>



2.4GHz 2400~2483.5MHz

BLE (Harmonic @ 3m)

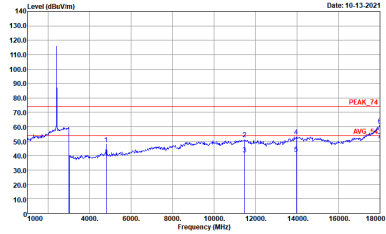
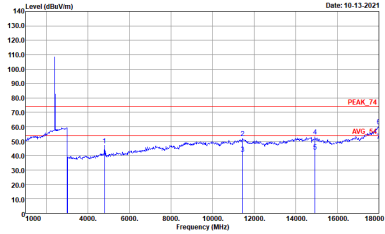
BLE	2.4GHz 2400~2483.5MHz Harmonic @ 3m	
BLE CH00 2402MHz		
	Horizontal	Vertical
Peak	 <p data-bbox="427 819 702 862">Site : 03CH02-CA Condition : PEAK_74 3m HORN 91200-HF_02113 HORIZONTAL Detector : Peak</p>	 <p data-bbox="903 819 1177 862">Site : 03CH02-CA Condition : PEAK_74 3m HORN 91200-HF_02113 VERTICAL Detector : Peak</p>



BLE	2.4GHz 2400~2483.5MHz Harmonic @ 3m	
	BLE CH19 2440MHz	
	Horizontal	Vertical
Peak	<p>Site : 03CH02-CA Condition : PEAK_74 3m HORN 91200-HF_02113 HORIZONTAL Detector : Peak</p>	<p>Site : 03CH02-CA Condition : PEAK_74 3m HORN 91200-HF_02113 VERTICAL Detector : Peak</p>



BLE	2.4GHz 2400~2483.5MHz Harmonic @ 3m	
	BLE CH38 2478MHz	
	Horizontal	Vertical
Peak	<p>Site : 03CH02-CA Condition : PEAK_74 3m HORN-HF_01895_2021 HORIZONTAL Detector : Peak</p>	<p>Site : 03CH02-CA Condition : PEAK_74 3m HORN-HF_01895_2021 VERTICAL Detector : Peak</p>



BLE	2.4GHz 2400~2483.5MHz Harmonic @ 3m	
	BLE CH39 2480MHz	
	Horizontal	Vertical
Peak	<p>Site : 03CH02-CA Condition : PEAK_74 3m HORN 91200-HF_02113 HORIZONTAL Detector : Peak</p>	<p>Site : 03CH02-CA Condition : PEAK_74 3m HORN 91200-HF_02113 VERTICAL Detector : Peak</p>

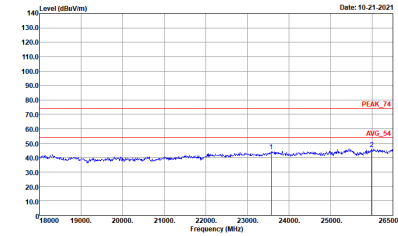
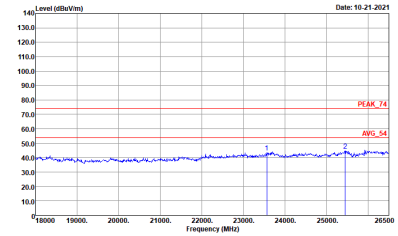

Emission above 18GHz  
2.4GHz BLE (SHF @ 1m)

BLE	2.4GHz 2400~2483.5MHz	
	BLE CH39 SHF	
	Horizontal	Vertical
Peak	 <p>Site : 03CH02-CA Condition : PEAK_74 1m HORN 9170-SHF_00842 HORIZONTAL Detector : Peak</p>	 <p>Site : 03CH02-CA Condition : PEAK_74 1m HORN 9170-SHF_00842 VERTICAL Detector : Peak</p>

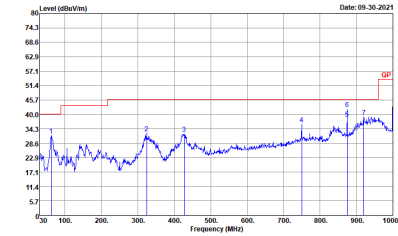
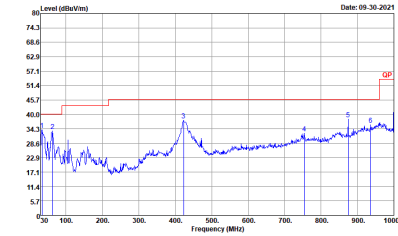

Emission below 1GHz  
2.4GHz BLE (LF @ 3m)

BLE	2.4GHz 2400~2483.5MHz	
	BLE CH39 LF	
	Horizontal	Vertical
<b>Peak</b>	 <p>Site : 03CH02-CA Condition : QP 3m 50392_2021 HORIZONTAL Detector : Peak</p>	 <p>Site : 03CH02-CA Condition : QP 3m 50392_2021 VERTICAL Detector : Peak</p>





### Appendix E. Duty Cycle Plots

Band	Duty Cycle(%)	T(us)	1/T(kHz)	VBW Setting
Bluetooth -LE	100.00	-	-	10Hz

