





FCC PART 15.407
**DYNAMIC FREQUENCY SELECTION
 TEST AND MEASUREMENT REPORT**

For

Ruckus Wireless, Inc.

350 West Java Drive,
 Sunnyvale, CA 94089, USA

FCC ID: S9GR300

Report Type: Class II Permissive Change	Equipment Type: 802.11 a/b/g/n Wireless Access Point
Prepared By: Jin Yang Test Engineer	
Report Number: R1603116-DFS	
Report Date: 2016-04-07	
Reviewed By: Bo Li RF Lead	
Bay Area Compliance Laboratories Corporation (BACL) 1274 Anvilwood Avenue, Sunnyvale, CA 94089, USA Tel: (408) 732-9162 Fax: (408) 732-9164	

Note: This test report is prepared for the customer shown above and for the device described herein. It may not be duplicated or used in part without prior written consent from Bay Area Compliance Laboratories Corp. This report **must not** be used by the customer to claim product certification, approval, or endorsement by A2LA* or any agency of the Federal Government.

* This report may contain data that are not covered by the A2LA accreditation and are marked with an asterisk "*" (b)(7)

TABLE OF CONTENTS

1	GENERAL DESCRIPTION.....	4
1.1	PRODUCT DESCRIPTION FOR EQUIPMENT UNDER TEST (EUT).....	4
1.2	MECHANICAL DESCRIPTION OF EUT	4
1.3	OBJECTIVE.....	4
1.4	RELATED SUBMITTAL(S)/GRANT(S)	4
1.5	TEST METHODOLOGY	4
1.6	TEST FACILITY	5
2	EUT TEST CONFIGURATION.....	7
2.1	JUSTIFICATION.....	7
2.2	EUT EXERCISE SOFTWARE.....	7
2.3	EQUIPMENT MODIFICATIONS.....	7
2.4	LOCAL SUPPORT EQUIPMENT	7
2.5	EUT INTERNAL CONFIGURATION DETAILS.....	7
2.6	INTERFACE PORTS AND CABLES	7
3	SUMMARY OF TEST RESULTS.....	8
4	APPLICABLE STANDARDS	9
4.1	DFS REQUIREMENT	9
4.2	DFS MEASUREMENT SYSTEM	12
4.3	SYSTEM BLOCK DIAGRAM.....	12
4.4	CONDUCTED METHOD.....	13
4.5	RADIATED METHOD	14
4.6	TEST PROCEDURE	14
5	TEST RESULTS.....	15
5.1	DESCRIPTION OF EUT.....	15
5.2	TEST EQUIPMENT LIST AND DETAILS	15
5.3	RADAR WAVEFORM CALIBRATION	16
5.4	TEST ENVIRONMENTAL CONDITIONS.....	16
6	RADAR DETECTION PERFORMANCE CHECK.....	33
6.1	RADAR DETECTION PERFORMANCE CHECK.....	33
7	APPENDIX A – TEST SETUP PHOTOGRAPHS.....	176
7.1	DFS TEST SETUP VIEW	176
8	APPENDIX B – EUT PHOTOGRAPHS.....	177
8.1	EUT – TOP VIEW	177
8.2	EUT – FRONT VIEW	177
8.3	EUT – LEFT SIDE VIEW	178
8.4	EUT – RIGHT SIDE VIEW.....	178
8.5	EUT – REAR SIDE VIEW	179
8.6	EUT – BOTTOM SIDE VIEW	179
8.7	EUT – OPEN CASE.....	180
8.8	EUT – MOTHERBOARD TOP VIEW.....	180
8.9	EUT – MOTHERBOARD BOTTOM VIEW	181
8.10	EUT – AC/DC ADAPTOR	181
8.11	EUT – POE & ADAPTER.....	182

DOCUMENT REVISION HISTORY

Revision Number	Report Number	Description of Revision	Date of Revision
0	R1603116-DFS	Initial	2016-04-07

1 General Description

1.1 Product Description for Equipment under Test (EUT)

This test and measurement report was prepared on behalf of *Ruckus Wireless, Inc.*, and their product model: *ZoneFlex R300*, FCC ID: *S9GR300* or the “EUT” as referred to in this report. The EUT is a 2x2 MIMO 802.11 a/b/g/n Wireless Access Point.

1.2 Mechanical Description of EUT

The EUT measures approximately 13 cm (L) x 13 cm (W) x 2.8 cm (H) and weighs 198 g.

The test data gathered are from typical production sample, serial number: 461302004678 provided by the manufacturer

1.3 Objective

This report is prepared on behalf of *Ruckus Wireless, Inc.* in accordance with FCC CFR47 §15.407 (h), and KDB: 905462 D02 UNII DFS Compliance Procedures New Rules v01r02

The objective is to determine compliance with FCC rules for DFS Detection Threshold, Channel Availability Check Time, Uniform Spreading U-NII Detection Bandwidth, Channel Closing Transmission Time, and Channel Move time in Master Mode.

1.4 Related Submittal(s)/Grant(s)

FCC ID: S9GR300

1.5 Test Methodology

FCC CFR 47 Part2, Part15.407 (h)

KDB: 905462 D02 UNII DFS Compliance Procedures New Rules v01r02

COMPLIANCE MEASUREMENT PROCEDURES FOR UNLICENSED-NATIONAL INFORMATION INFRASTRUCTURE DEVICES OPERATING IN THE 5250-5350 MHz AND 5470-5725 MHz BANDS INCORPORATING DYNAMIC FREQUENCY SELECTION

1.6 Test Facility

Bay Area Compliance Laboratories Corp. (BACL) is:

1- An independent Commercial Test Laboratory accredited to **ISO 17025: 2005** by **A2LA**, in the fields of: Electromagnetic Compatibility & Telecommunications covering Emissions, Immunity, Radio, RF Exposure, Safety and Telecom. This includes NEBS (Network Equipment Building System), Wireless RF, Telecommunications Terminal Equipment (TTE); Network Equipment; Information Technology Equipment (ITE); Medical Electrical Equipment; Industrial, Commercial, and Medical Test Equipment; Professional Audio and Video Equipment; Electronic (Digital) Products; Industrial and Scientific Instruments; Cabled Distribution Systems and Energy Efficiency Lighting.

2- An ENERGY STAR Recognized Laboratory, for the LM80 Testing, a wide variety of Luminaires and Computers.

3- A NIST Designated Phase-I and Phase-II CAB including: ACMA (Australian Communication and Media Authority), BSMI (Bureau of Standards, Metrology and Inspection of Taiwan), IDA (Infocomm Development Authority of Singapore), IC (Industry Canada), Korea (Ministry of Communications Radio Research Laboratory), NCC (Formerly DGT; Directorate General of Telecommunication of Chinese Taipei) OFTA (Office of the Telecommunications Authority of Hong Kong), Vietnam, VCCI - Voluntary Control Council for Interference of Japan and a designated EU CAB (Conformity Assessment Body) (Notified Body) for the EMC and R&TTE Directives.

4 - A Product Certification Body accredited to **ISO Guide 65: 1996** by **A2LA** to certify:

1- Unlicensed, Licensed radio frequency devices and Telephone Terminal Equipment for the FCC. Scope A1, A2, A3, A4, B1, B2, B3, B4 & C.

2. Radio Standards Specifications (RSS) in the Category I Equipment Standards List and All Broadcasting Technical Standards (BETS) in Category I Equipment Standards List for Industry Canada.

3. Radio Communication Equipment for Singapore.

4. Radio Equipment Specifications, GMDSS Marine Radio Equipment Specifications, and Fixed Network Equipment Specifications for Hong Kong.

5. Japan MIC Telecommunication Business Law (A1, A2) and Radio Law (B1, B2 and B3).

6. Audio/Video, Battery Charging Systems, Computers, Displays, Enterprise Servers, Imaging Equipment, Set-Top Boxes, Telephony, Televisions, Ceiling Fans, CFLs (including GU24s), Decorative Light Strings, Integral LED Lamps, Luminaires, Residential Ventilating Fans.

The test site used by BACL Corp. to collect radiated and conducted emissions measurement data is located at its facility in Sunnyvale, California, USA.

The test site at BACL Corp. has been fully described in reports submitted to the Federal Communication Commission (FCC) and Voluntary Control Council for Interference (VCCI). The details of these reports have been found to be in compliance with the requirements of Section 2.948 of the FCC Rules on February 11 and December 10, 1997, and Article 8 of the VCCI regulations on December 25, 1997. The test site also complies with the test methods and procedures set forth in CISPR 22:2008 §10.4 for measurements below 1 GHz and §10.6 for measurements above 1 GHz, as well as ANSI C63.4-2014, ANSI C63.10-2013, TIA/EIA-603 & CISPR 24: 2010.

The Federal Communications Commission and Voluntary Control Council for Interference have the reports on file and they are listed under FCC registration number: 90464 and VCCI Registration No.: A-0027. The test site has been approved by the FCC and VCCI for public use and is listed in the FCC Public Access Link (PAL) database.

Additionally, BACL Corp. is an American Association for Laboratory Accreditation (A2LA) accredited laboratory (Lab Code 3297-02). The current scope of accreditations can be found at

<http://www.a2la.org/scopepdf/3297-02.pdf?CFID=1132286&CFTOKEN=e42a3240dac3f6ba-6DE17DCB-1851-9E57-477422F667031258&jsessionid=8430d44f1f47cf2996124343c704b367816b>

2 EUT Test Configuration

2.1 Justification

The EUT was configured for testing according to FCC Part 15.407(H), and KDB: 905462 D02 UNII DFS Compliance Procedures New Rules v01r02

2.2 EUT Exercise Software

The test utility used version was 9.6.0 was provided by Ruckus Wireless Inc., and it comply with the standard requirements being tested against.

2.3 Equipment Modifications

N/A

2.4 Local Support Equipment

Manufacturer	Description	Model	Serial Number
Dell	Laptop	Latitude E5420	CHZCMQ1

2.5 EUT Internal Configuration Details

Manufacturer	Description	Model	Serial Number
Ruckus	Motherboard	ASM 120-11255 REV A	-
Ruckus	Antenna	ASM 120-11258 REV 6	-
Ruckus	Antenna	ASM 120-11259 REV 2	-

2.6 Interface Ports and Cables

Cable Description	Length (m)	To	From
RJ 45 Cable	<1.0	Laptop	EUT

3 Summary of Test Results

The following result table represents the list of measurements required under the CFR47 §47 Part15.407 (h), and KDB: 905462 D02 UNII DFS Compliance Procedures New Rules v01r02. This report is to update from KDB: 905462 D02 UNII DFS Compliance Procedures Old rules v01 to KDB: 905462 D02 UNII DFS Compliance Procedures New Rules v01r02

Items	Description of Test	Results
Detection Bandwidth	UNII Detection Bandwidth	Compliant ¹
Performance Requirements Check	Initial Channel Availability Check Time (CAC)	Compliant ¹
	Radar Burst at the Beginning of the CAC	Compliant ¹
	Radar Burst at the End of the CAC	Compliant ¹
In-Service Monitoring	Channel Move Time	Compliant ¹
	Channel Closing Transmission Time	Compliant ¹
	Non-Occupancy Period	Compliant ¹
Radar Detection	Statistical Performance Check	Compliant

Note¹: Please refer to previous CIIPC DFS application granted on 07/31/2014, report number: R1305151-DFS.

4 Applicable Standards

4.1 DFS Requirement

FCC CFR47 §15.407 (h), and KDB: 905462 D02 UNII DFS Compliance Procedures New Rules v01r02

Table 1: Applicability of DFS requirements prior to use of a channel

Requirement	Operational Mode		
	Master	Client (Without radar detection)	Client (With radar detection)
Non-Occupancy Period	Yes	Not Required	Yes
DFS Detection Threshold	Yes	Not Required	Yes
Channel Availability Check Time	Yes	Not Required	Not Required
U-NII Detection Bandwidth	Yes	Not Required	Yes

Table 2: Applicability of DFS requirements during normal operation

Requirement	Operational Mode	
	Master Device or Client with Radar Detection	Client Without Radar Detection
DFS Detection Threshold	Yes	Not Required
Channel Closing Transmission Time	Yes	Yes
Channel Move Time	Yes	Yes
U-NII Detection Bandwidth	Yes	Not Required

Additional requirements for devices with multiple bandwidth modes	Master Device or Client with Radar Detection	Client Without Radar Detection
U-NII Detection Bandwidth and Statistical Performance Check	All BW modes must be tested	Not required
Channel Move Time and Channel Closing Transmission Time	Test using widest BW mode available	Test using the widest BW mode available for the link
All other tests	Any single BW mode	Not required
Note: Frequencies selected for statistical performance check (Section 7.8.4) should include several frequencies within the radar detection bandwidth and frequencies near the edge of the radar detection bandwidth. For 802.11 devices it is suggested to select frequencies in each of the bonded 20 MHz channels and the channel center frequency.		

Table 3: Interference Threshold values, Master or Client incorporating In-Service Monitoring

Maximum Transmit Power	Value (See Notes 1, 2 and 3)
EIRP \geq 200 milliwatt	-64 dBm
EIRP $<$ 200 milliwatt and power spectral density $<$ 10dBm/MHz	-62 dBm
EIRP $<$ 200 milliwatt that do not meet the power spectral density requirement	-64 dBm

Note 1: This is the level at the input of the receiver assuming a 0 dBi receive antenna.
Note 2: Throughout these test procedures an additional 1 dB has been added to the amplitude of the test transmission waveforms to account for variations in measurement equipment. This will ensure that the test signal is at or above the detection threshold level to trigger a DFS response.
Note3: EIRP is based on the highest antenna gain. For MIMO devices refer to KDB Publication 662911D01.

Table 4: DFS Response Requirement Values

Parameter	Value
Non-occupancy period	Minimum 30 minutes
Channel Availability Check Time	60 seconds
Channel Move Time	10 seconds See Note 1.
Channel Closing Transmission Time	200 milliseconds + an aggregate of 60 milliseconds over remaining 10 second period. See Notes 1 and 2.
U-NII Detection Bandwidth	Minimum 100% of the UNII 99% transmission power bandwidth. See Note 3.

Note 1: *Channel Move Time and the Channel Closing Transmission Time should be performed with Radar Type 0. The measurement timing begins at the end of the Radar Type 0 burst.*
Note 2: The Channel Closing Transmission Time is comprised of 200 milliseconds starting at the beginning of the Channel Move Time plus any additional intermittent control signals required to facilitate a Channel move (an aggregate of 60 milliseconds) during the remainder of the 10 second period. The aggregate duration of control signals will not count quiet periods in between transmissions.
Note 3: During the *U-NII Detection Bandwidth* detection test, radar type 0 is used and for each frequency step the minimum percentage of detection is 90 percent. Measurements are performed with no data traffic.

Table 5: Short Pulse Radar Test Waveforms

Radar Type	Pulse Width (Microseconds)	PRI (Microseconds)	Pulses	Minimum Percentage of Successful Detection	Minimum Number of Trials
0	1	1428	18	See Note 1	See Note 1
1	1	Test A: 15 unique PRI values randomly selected from the list of 23 PRI values in Table 5a	$\text{Roundup}\left(\frac{1}{360}\right)$	60%	30
		Test B: 15 unique PRI values randomly selected within the range of 518-3066 μsec, with a minimum increment of 1 μsec, excluding PRI values selected in Test A	$\left(\frac{19 \cdot 10^6}{\text{PRI}_{\mu\text{sec}}}\right)$		
2	1-5	150-230	23-29	60%	30
3	6-10	200-500	16-18	60%	30
4	11-20	200-500	12-16	60%	30
Aggregate (Radar Types 1-4)				80%	120
Note 1: Short Pulse Radar Type 0 should be used for the detection bandwidth test, channel move time, and channel closing time tests.					

Table 6: Long Pulse Radar Test Signal

Radar Type	Bursts	Chirp Width (MHz)	PRI (usec)	Number of Pulses per Burst	Number of Bursts	Minimum Percentage of Successful Detection	Minimum Number of Trials
5	50-100	5-20	1000-2000	1-3	8-20	80%	30

The parameters for this waveform are randomly chosen. Thirty unique waveforms are required for the Long Pulse Radar Type waveforms. If more than 30 waveforms are used for the Long Pulse Radar Type waveforms, then each additional waveform must also be unique and not repeated from the previous waveforms.

Table 7: Frequency Hopping Radar Test Signal

Radar Type	Pulse Width (usec)	PRI (usec)	Pulses per Hop	Hopping Rate (kHz)	Hopping Sequence Length (msec)	Minimum Percentage of Successful Detection	Minimum Number of Trials
6	1	333	9	0.333	300	70%	30

4.2 DFS Measurement System

BACL DFS measurement system consists of two subsystems: (1) The radar signal generating subsystem and (2) the traffic monitoring subsystem.

4.3 System Block Diagram

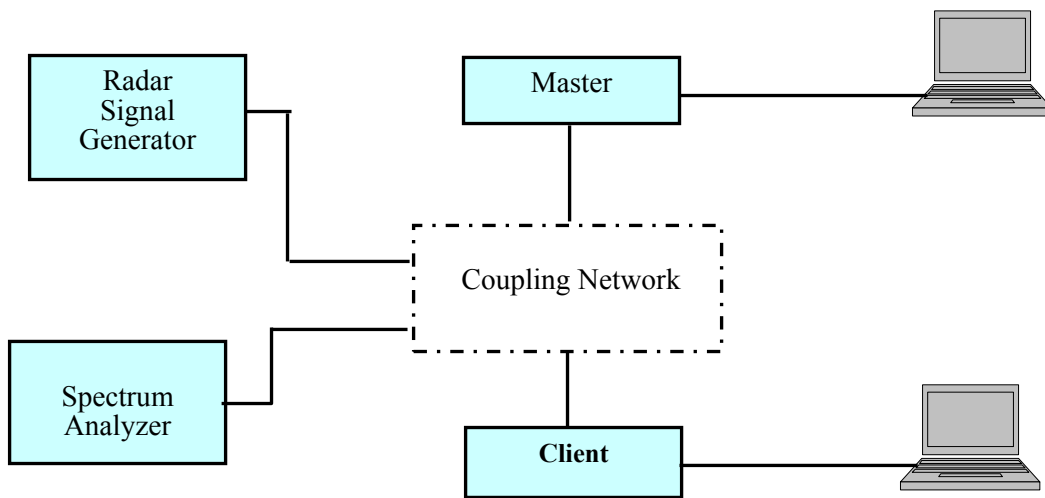

4.4 Conducted Method

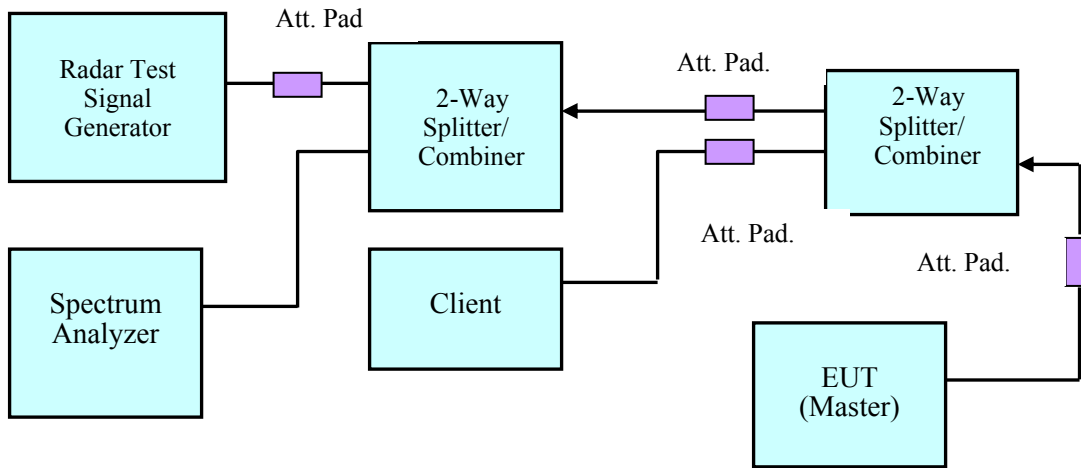

Setup for Master with injection at the Master

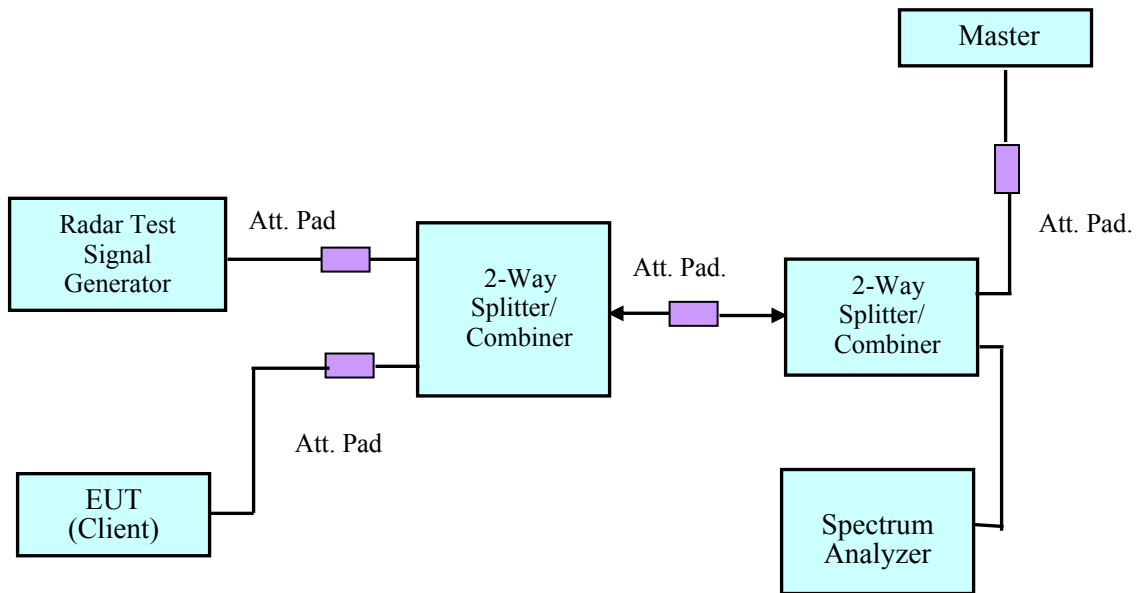

Setup for Client with injection at the Master

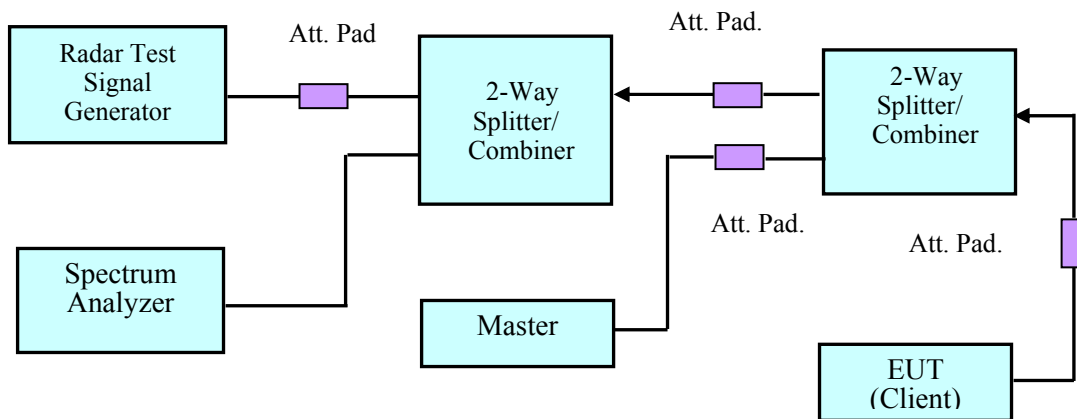

Setup for Client with injection at the Client

4.5 Radiated Method

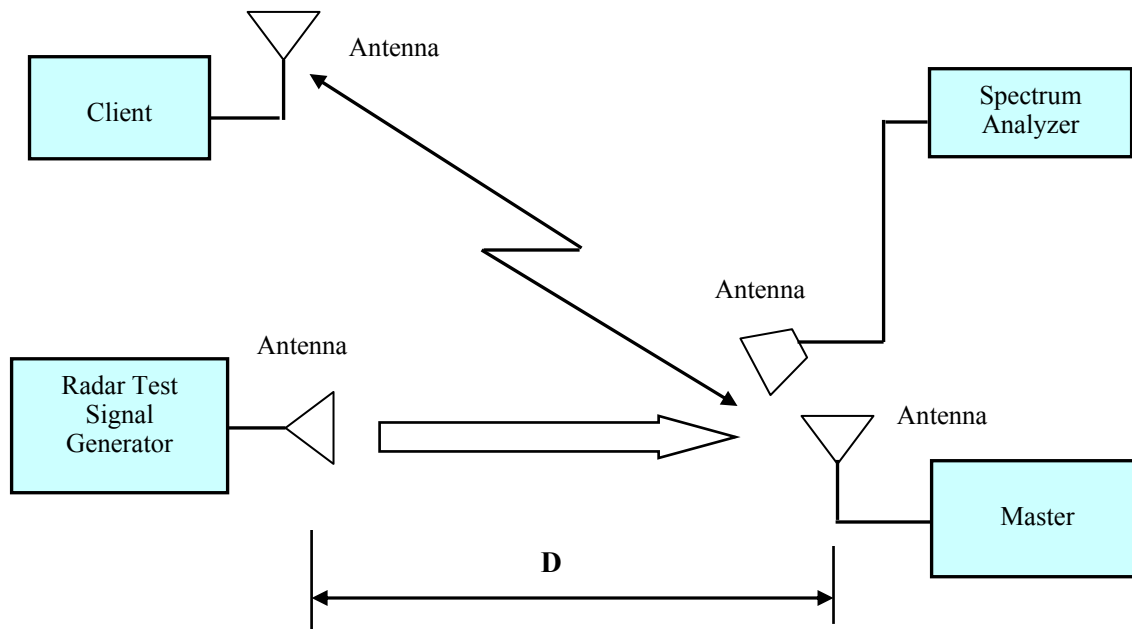

4.6 Test Procedure

A spectrum analyzer is used as a monitor that verifies the EUT’s status, which includes the Channel Closing Transmission Time and the Channel Move Time. The Spectrum analyzer is used to monitor the equipment under test (EUT) does not transmit on the same channel during the Non-Occupied Period after the radar detection. It is also used to monitor EUT transmissions during the Channel Availability Check Time.

5 Test Results

5.1 Description of EUT

The EUT operates in 5230-5350 MHz and 5470-5725 MHz range in Master Mode.

The rated output power of EUT is >23 dBm (EIRP), Therefore the required interference threshold level is -64 dBm, the required radiated threshold at antenna port is -64dBm.

WLAN traffic is generated by streaming the video file TestFile.mpg, this file is used by IP and Frame based systems for loading the test channel during the In-service compliance testing of the U-NII device. The file is streamed from the Access Point to the Client in full motion video mode using the media player with the V2.61 Codec package.

5.2 Test Equipment List and Details

Manufacturer	Equipment Description	Model	S/N	Calibration Date	Calibration Interval
National Instruments	NI PXI-1042 8-Slot chassis	PXI-1042	V08X01EE1	N/A	N/A
National Instruments	Arbitrary Waveform Generator	PXI-5421	N/A	N/A	N/A
National Instruments	RF Upconverter	PXI-5610	N/A	N/A	N/A
ASCOR	Upconverter	AS-7206	N/A	N/A	N/A
Agilent	Spectrum Analyzer	E4440A	MY44303352	2015-06-22	1 year
A.R.A.	Antenna Horn	DRG-118/A	1132	2015-09-21	2 years
EMCO	Antenna Horn	3115	9511-4627	2016-01-28	2 years
Mini-Circuits	Splitter/Combiner	2FSC-2-10G	0349	N/A	N/A
Narda	Splitter/Combiner	4326B-2	03514	N/A	N/A
Midwest	Attenuator	290-30	N/A	N/A	N/A
Mini-Circuits	Attenuator	BW-S30W2	N/A	N/A	N/A

Statement of Traceability: *BACL Corp. attests that all calibrations have been performed according to A2LA requirements, traceable to the NIST.*

5.3 Radar Waveform Calibration

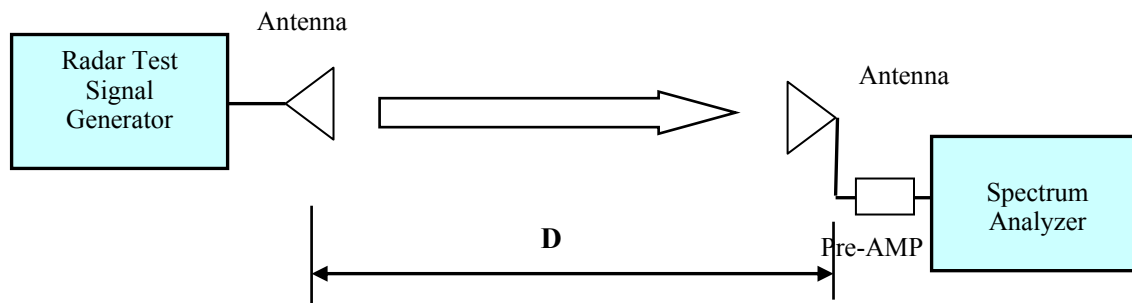

Radiated Calibration Setup Block Diagram

5.4 Test Environmental Conditions

Temperature:	24° C
Relative Humidity:	47 %
ATM Pressure:	102.1 kPa

The testing performed by Jin Yang on 2016-03-09 at DFS testing site

Plots of Radar Waveforms

5270 MHz

Radar Type 0

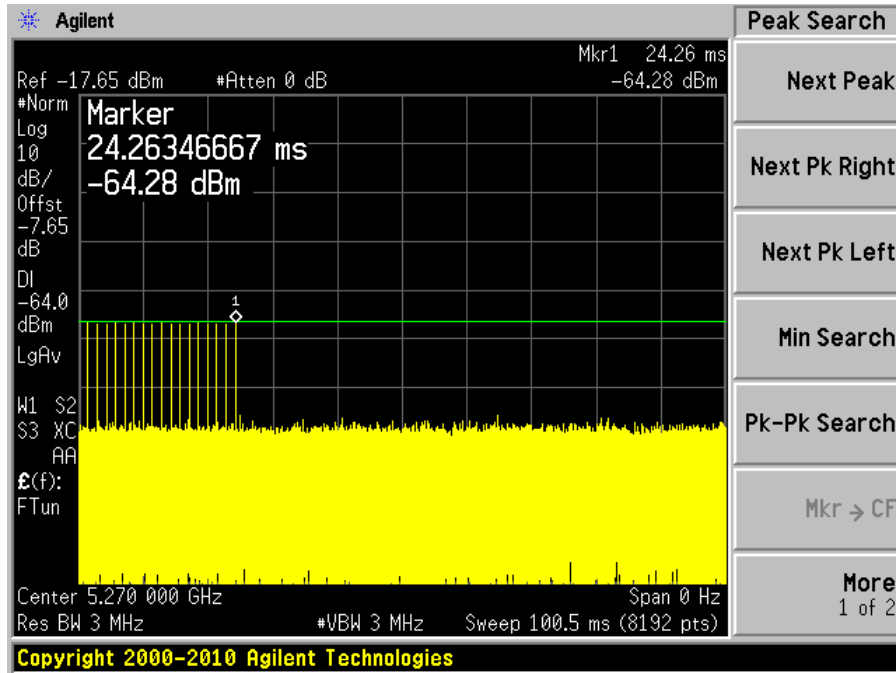

Radar Type 1A

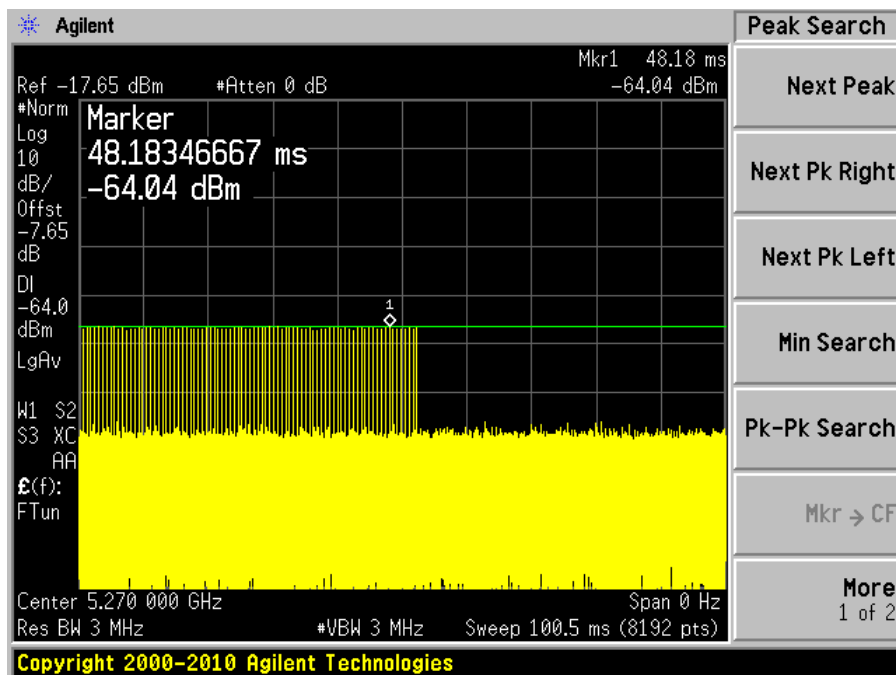

Radar Type 1B

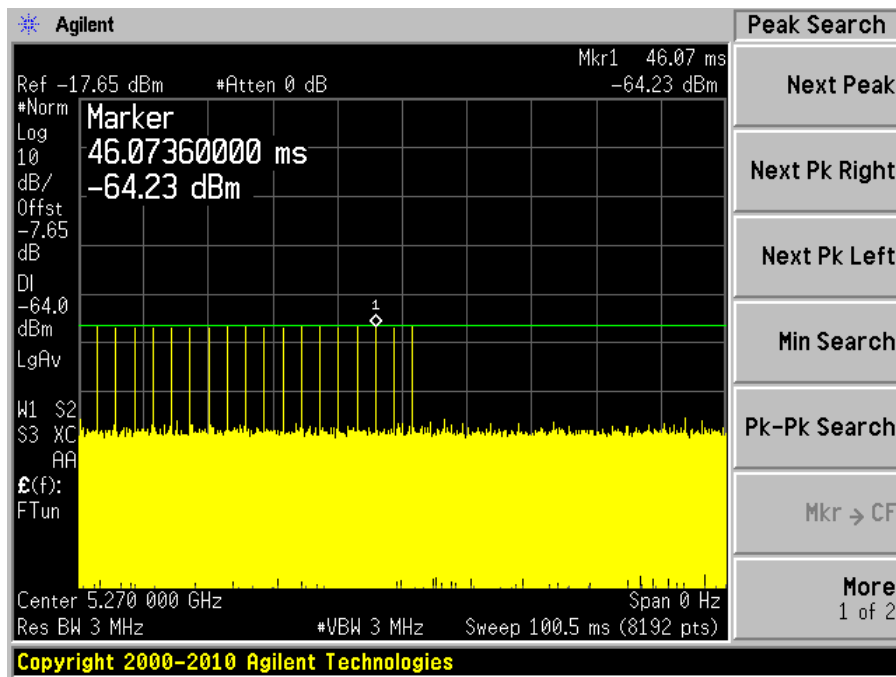

Radar Type 2

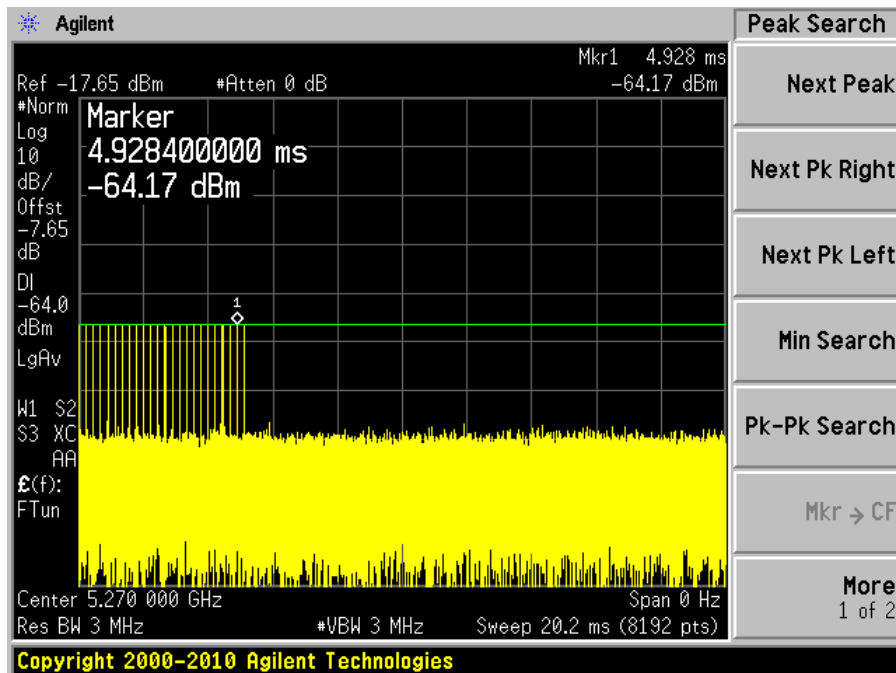

Radar Type 3

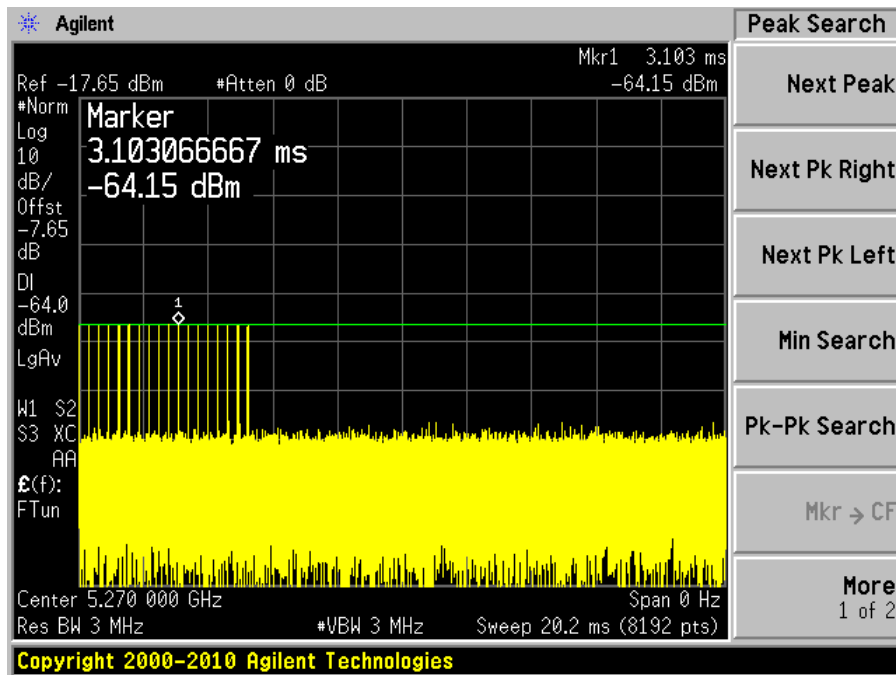

Radar Type 4

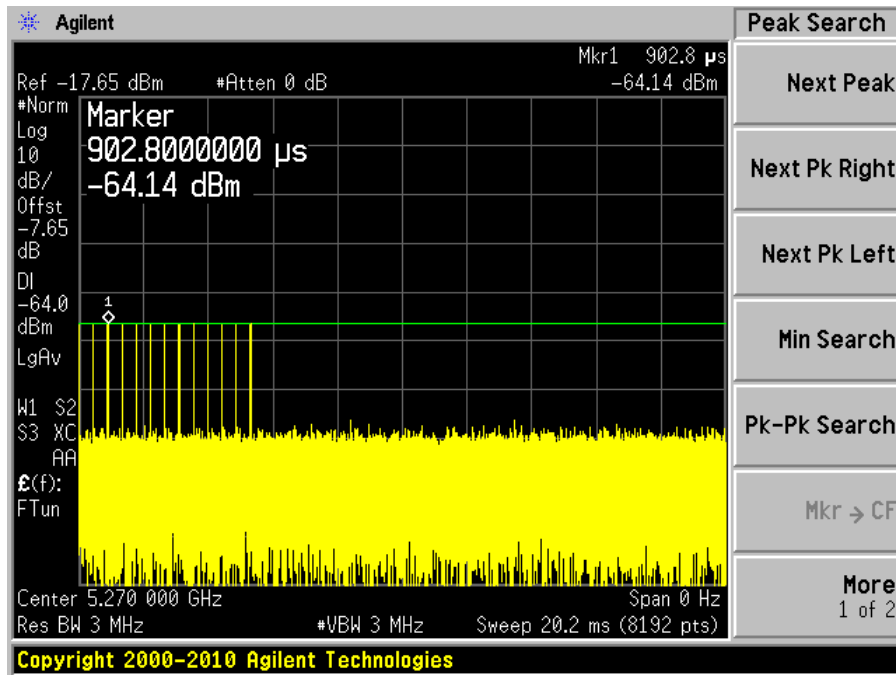

Radar Type 5

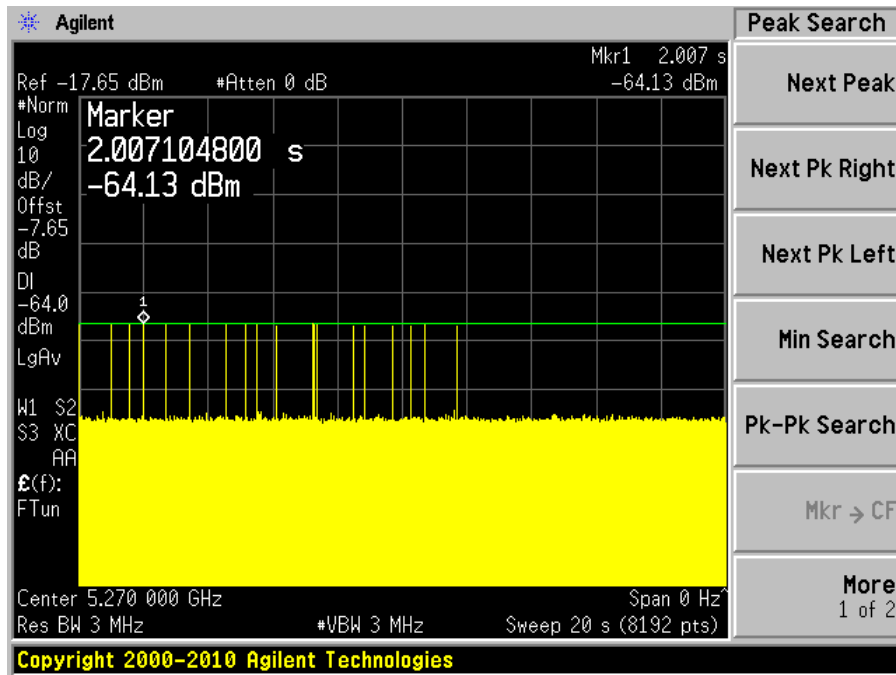

Radar Type 6

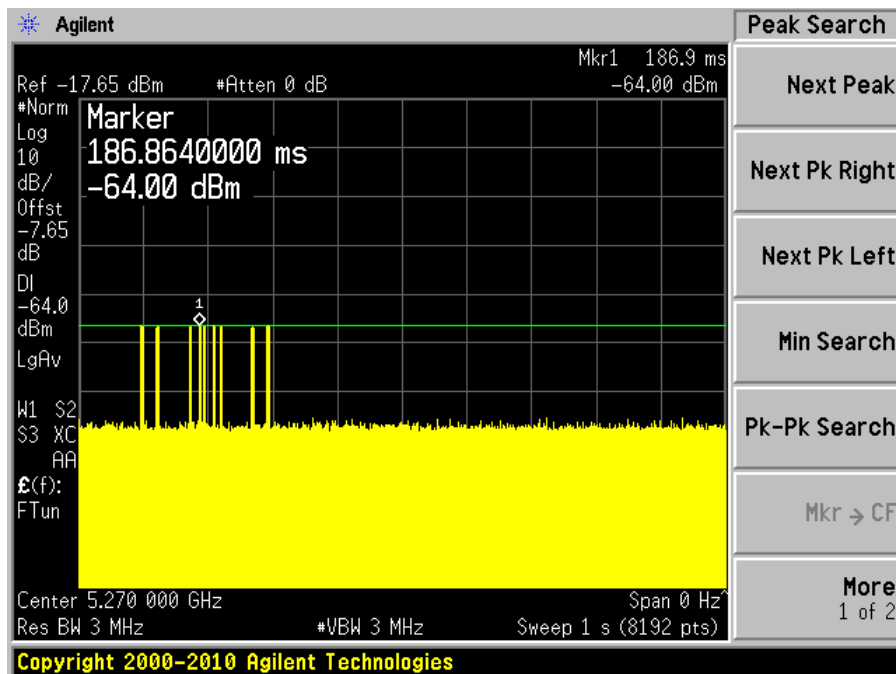

5280 MHz

Radar Type 0

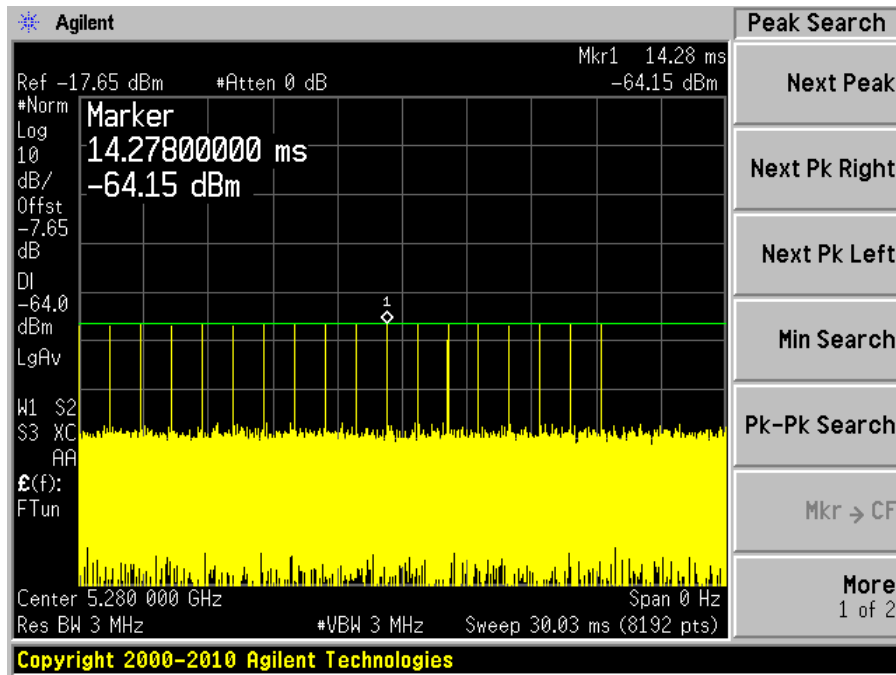

Radar Type 1A

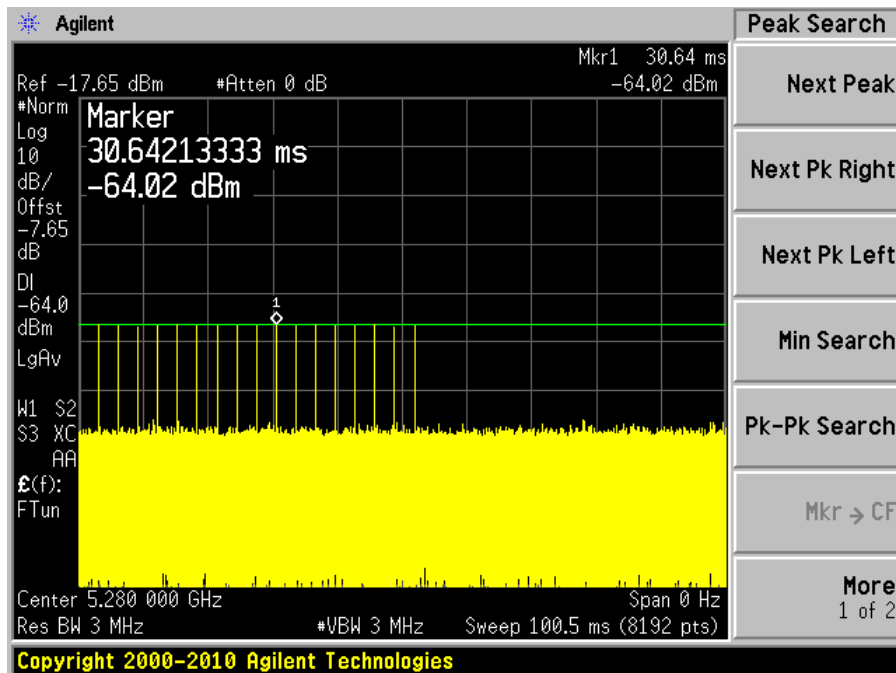

Radar Type 1B

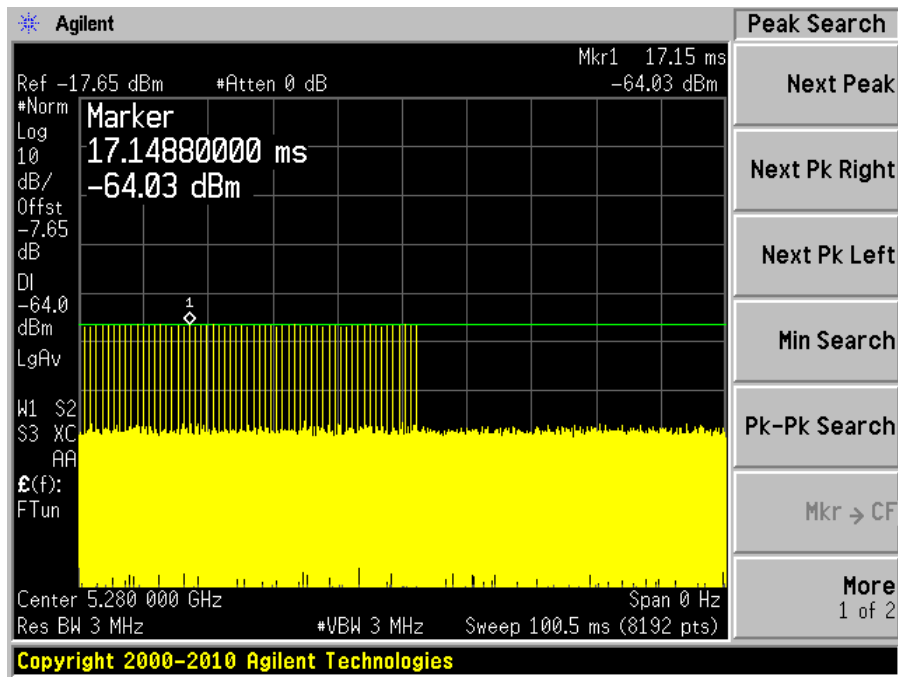

Radar Type 2

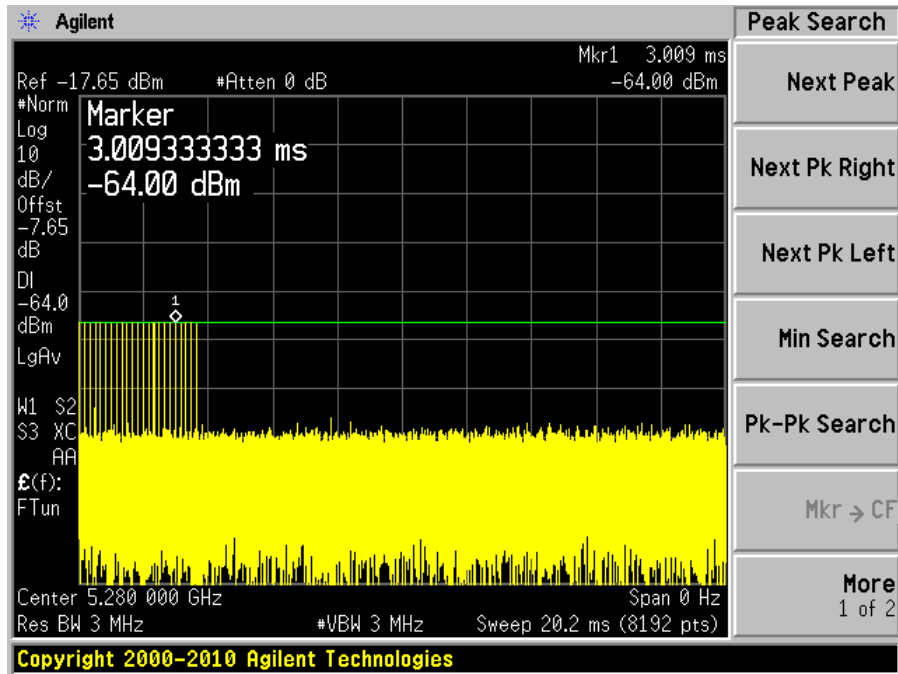

Radar Type 3

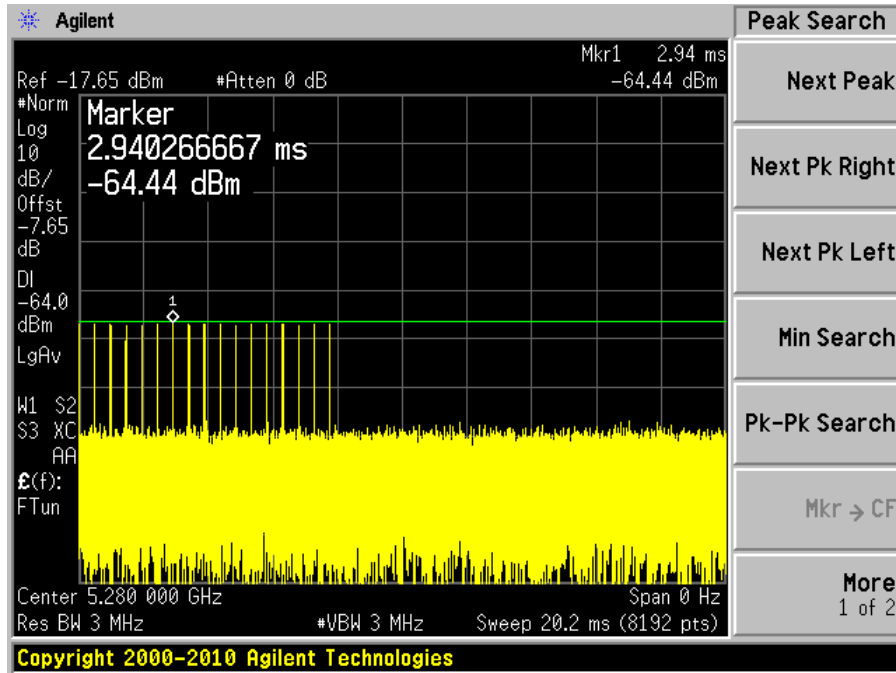

Radar Type 4

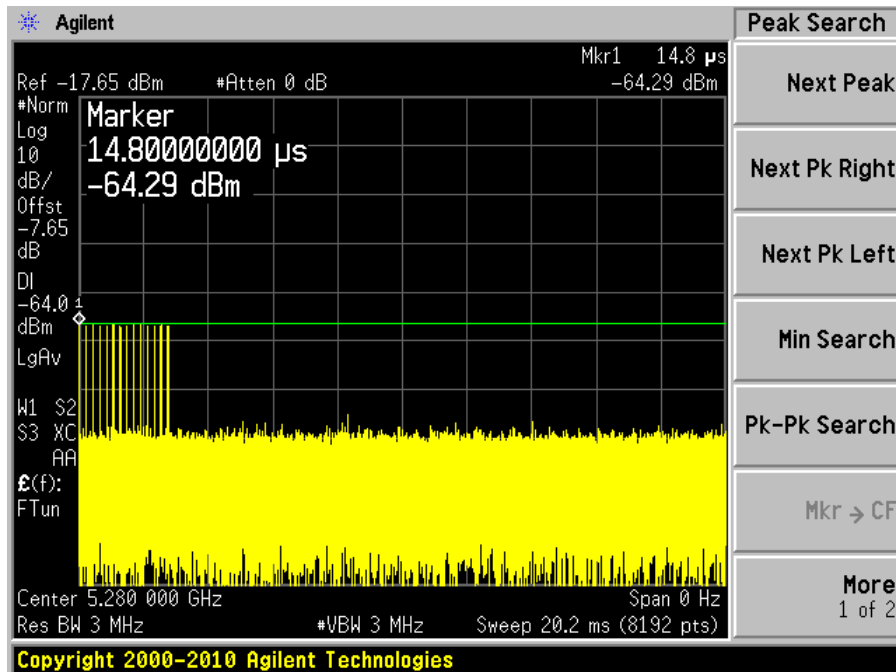

Radar Type 5

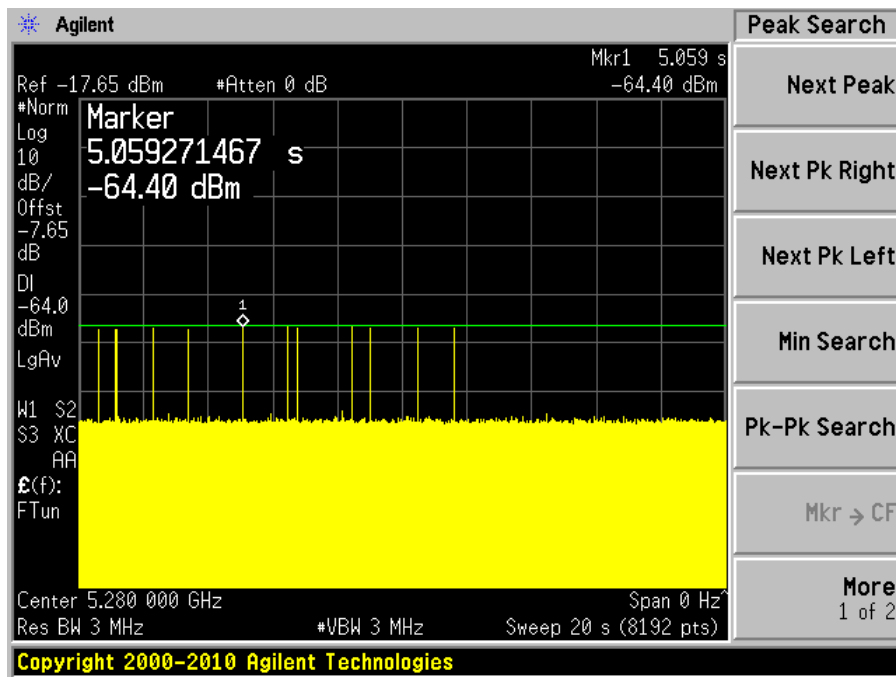

Radar Type 6

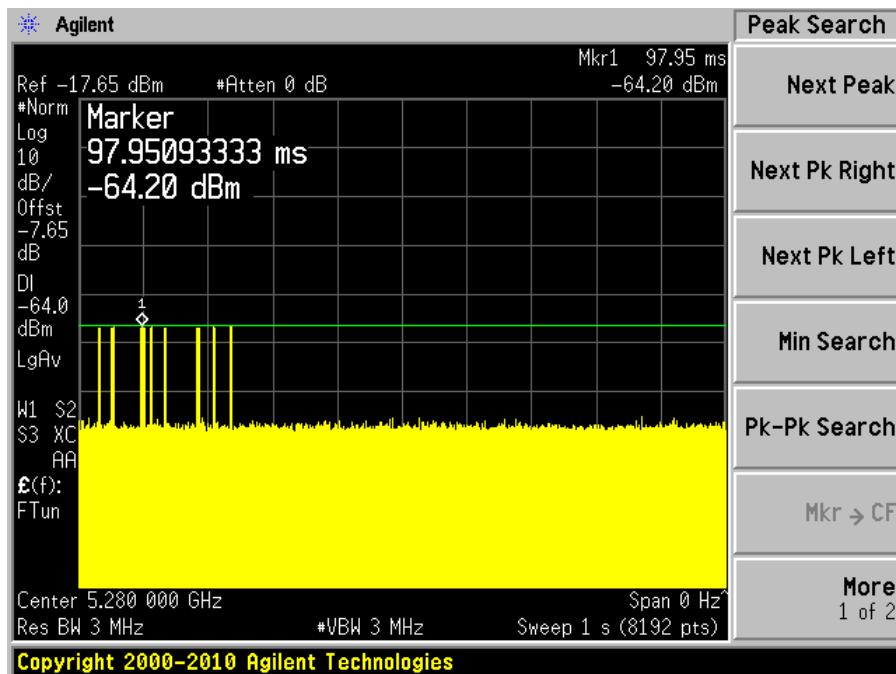

5550 MHz

Radar Type 0

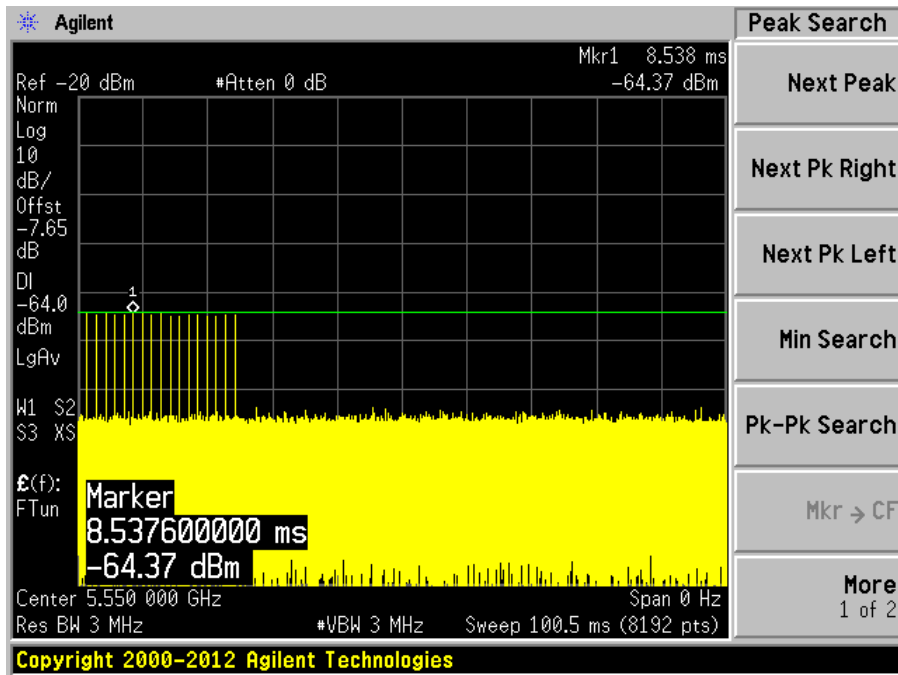

Radar Type 1A

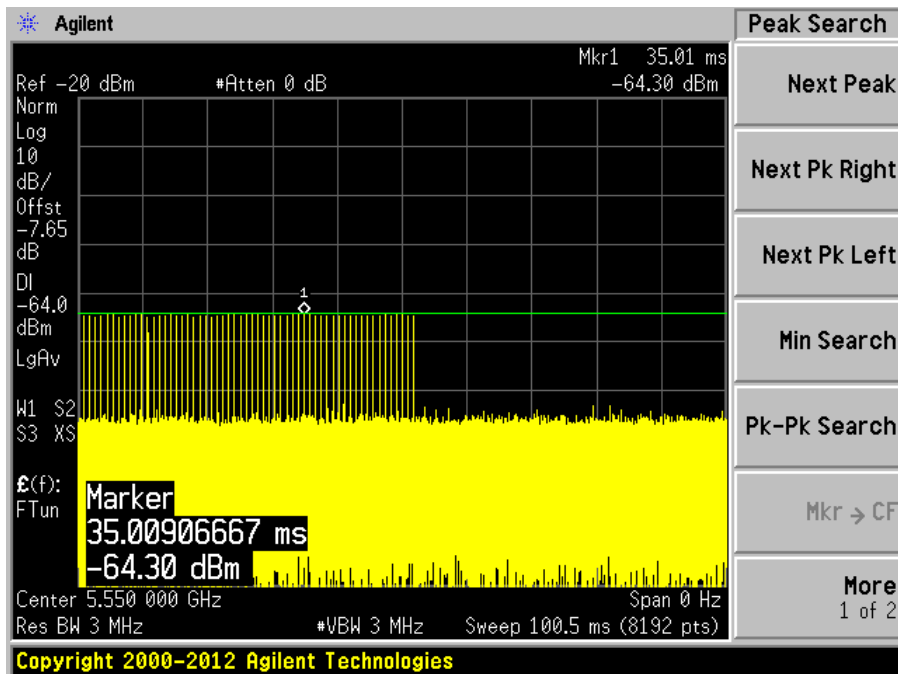

Radar Type 1B

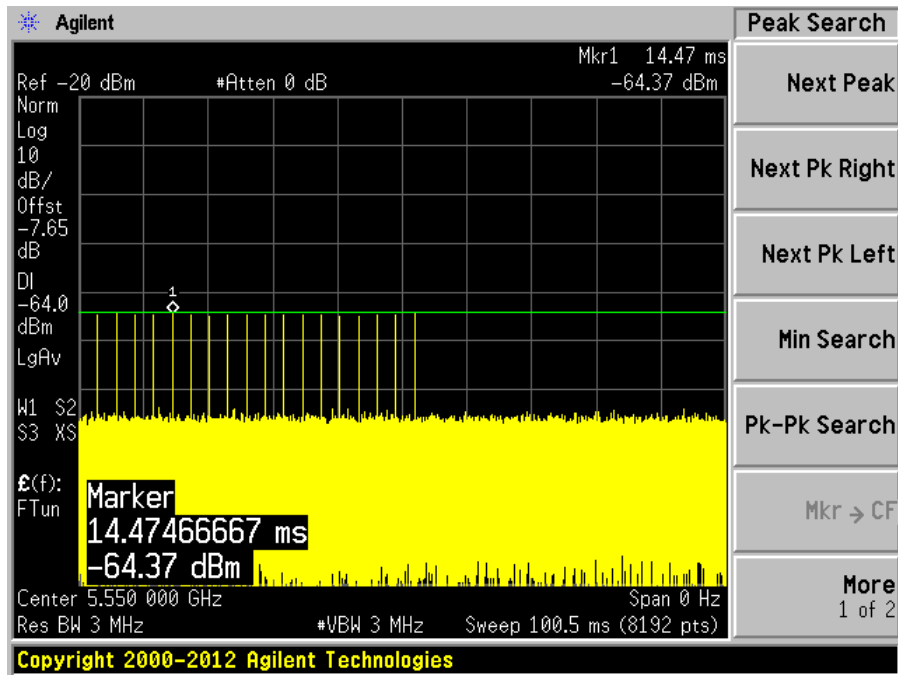

Radar Type 2

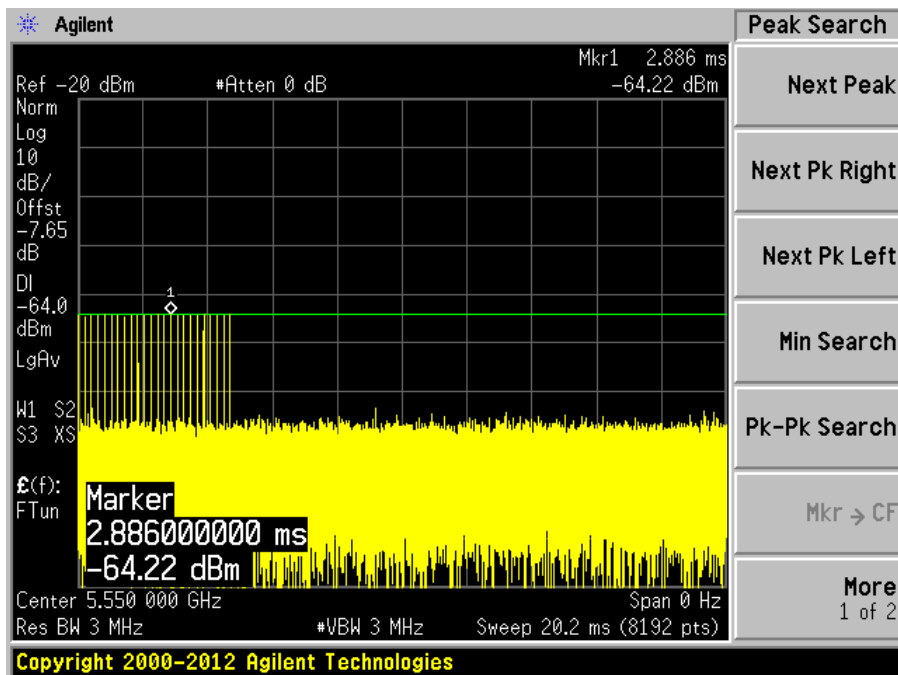

Radar Type 3

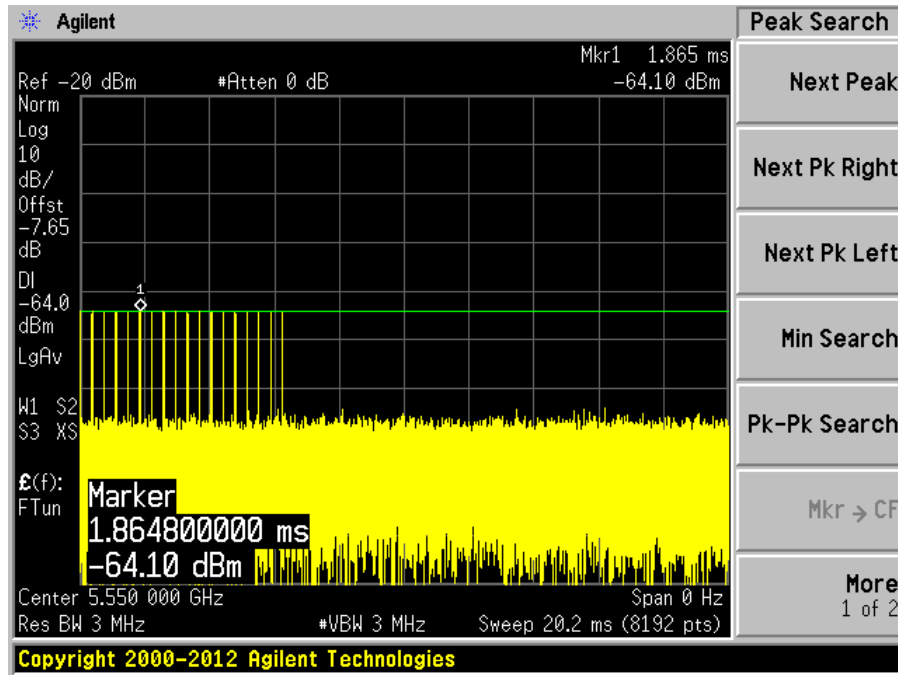

Radar Type 4

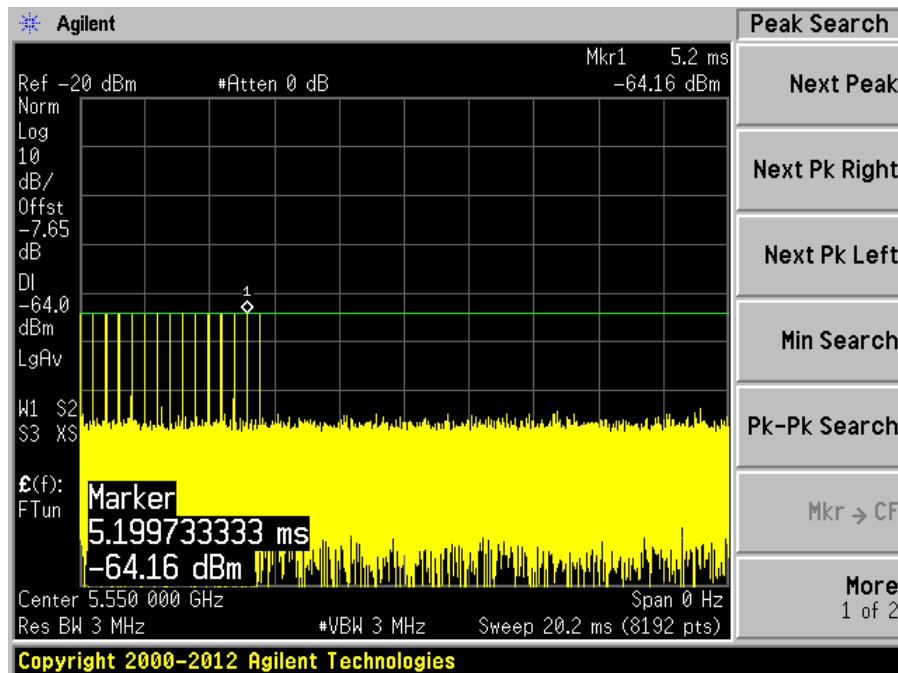

Radar Type 5

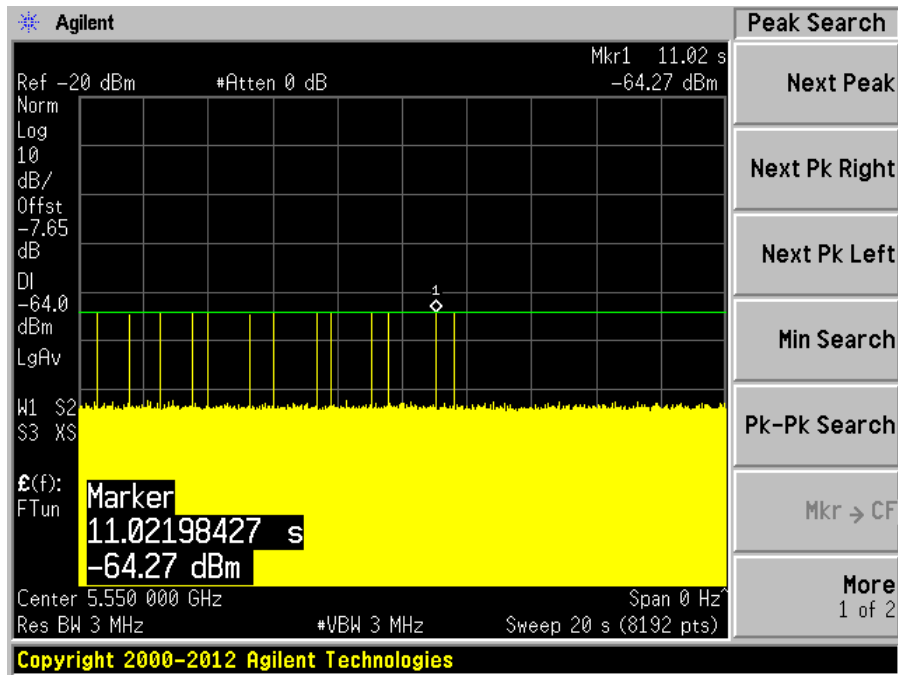

Radar Type 6

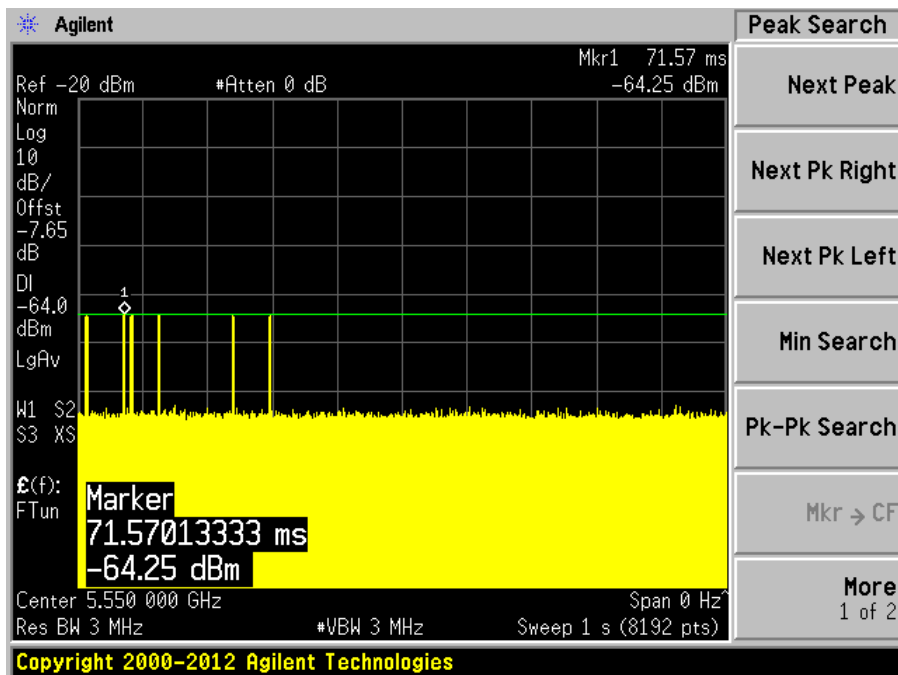

5580 MHz

Radar Type 0

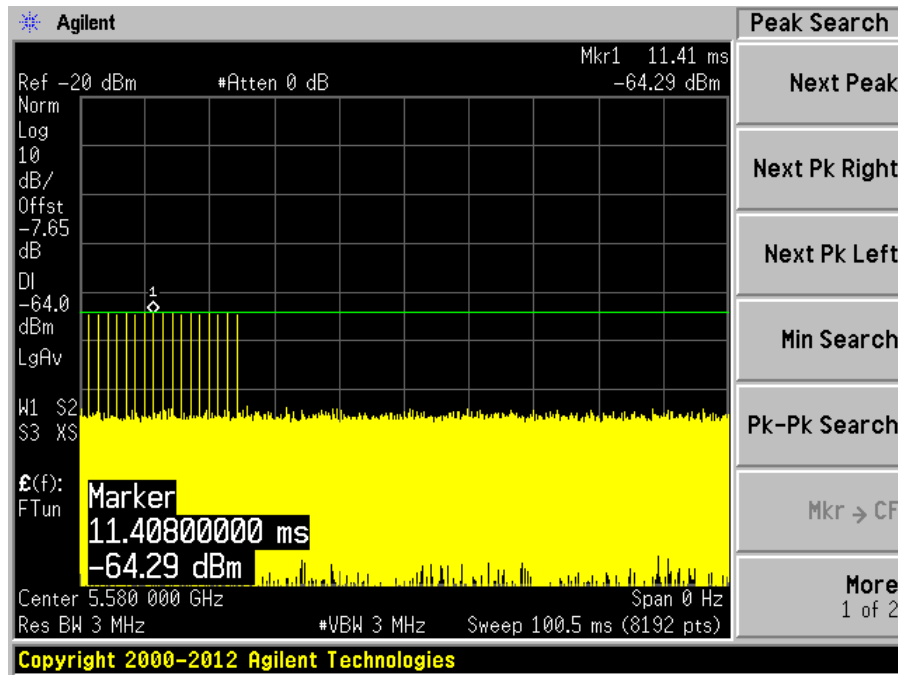

Radar Type 1A

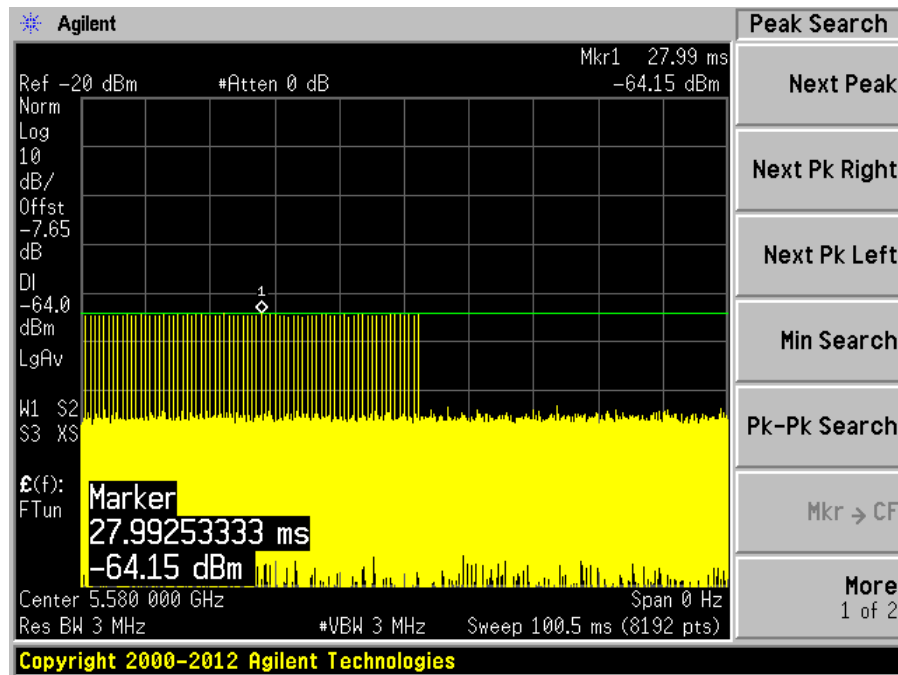

Radar Type 1B

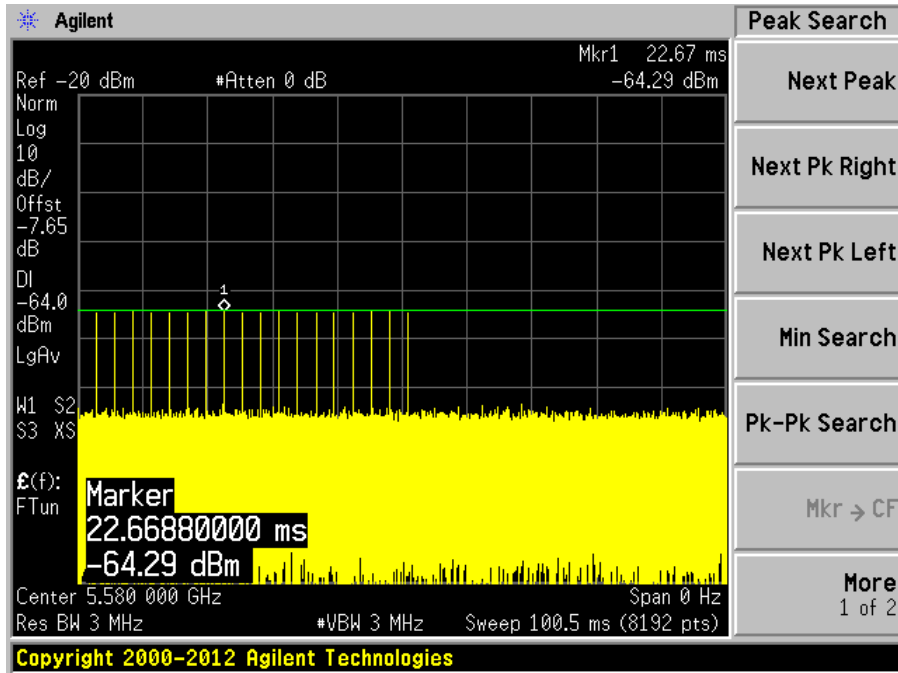

Radar Type 2

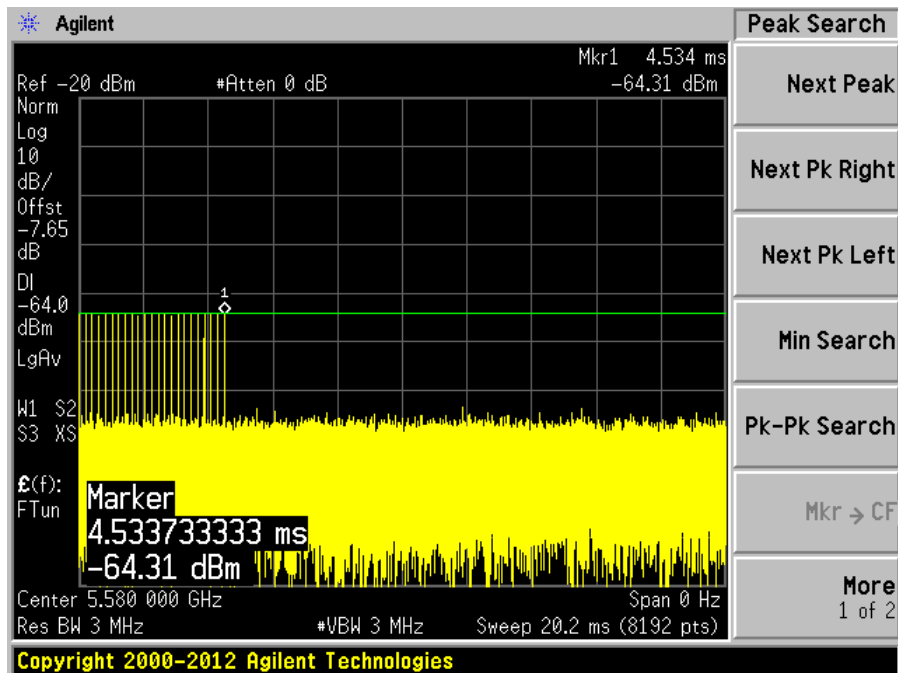

Radar Type 3

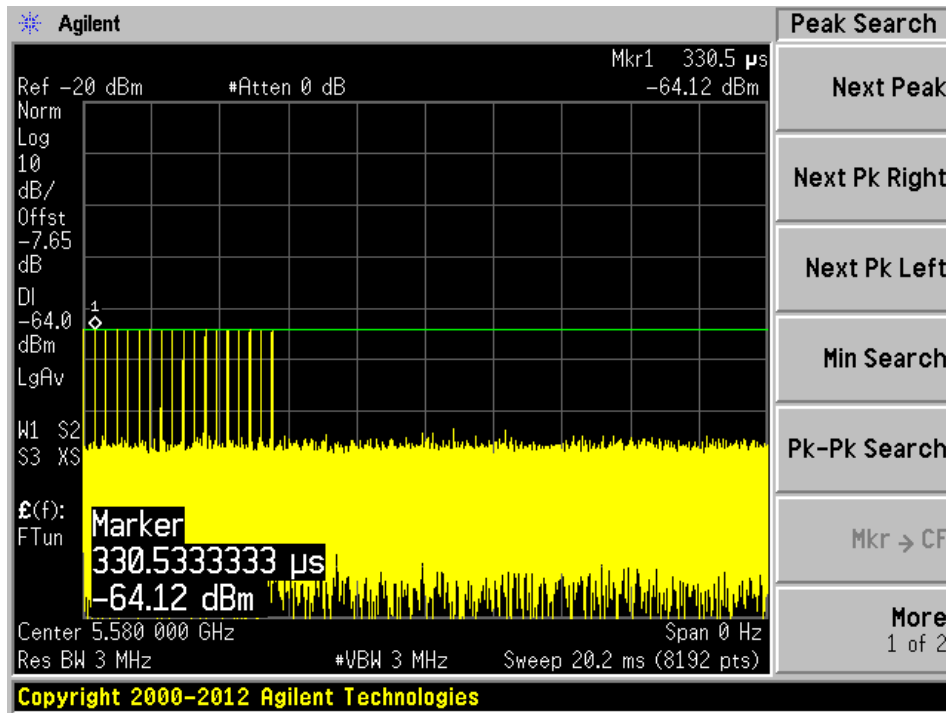

Radar Type 4

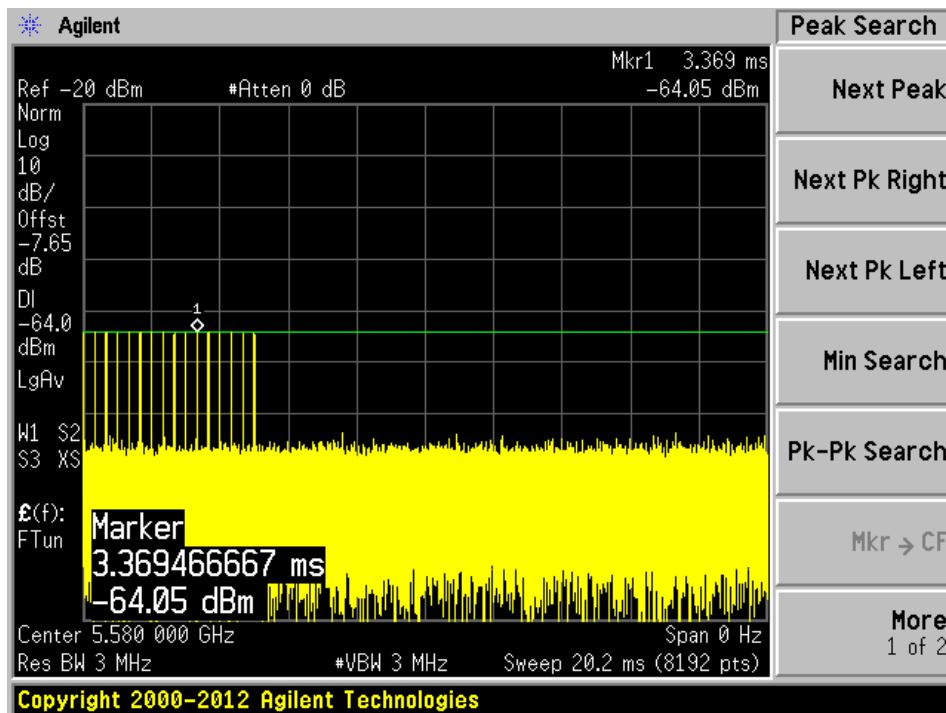

Radar Type 5

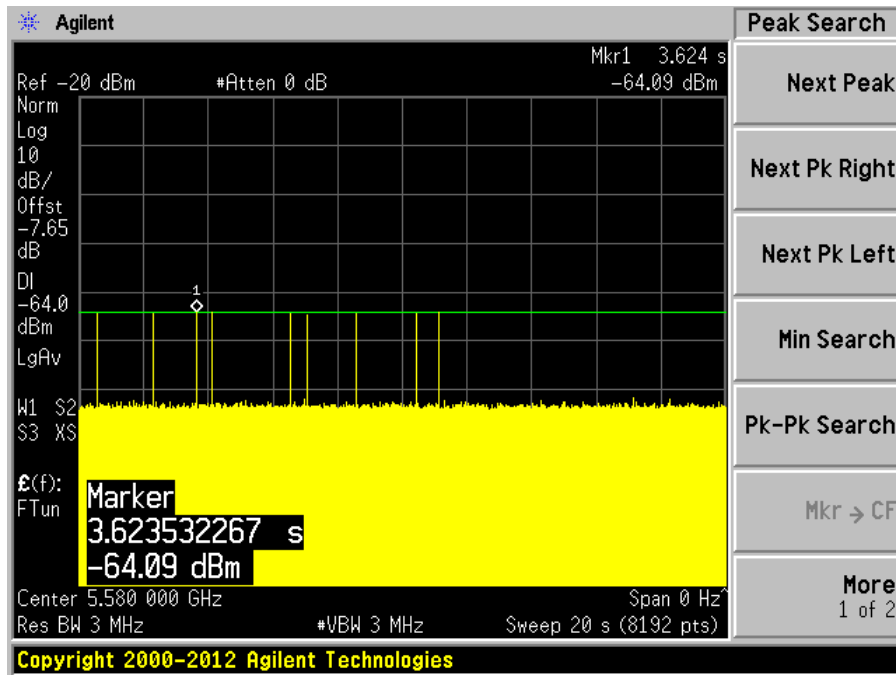

Radar Type 6

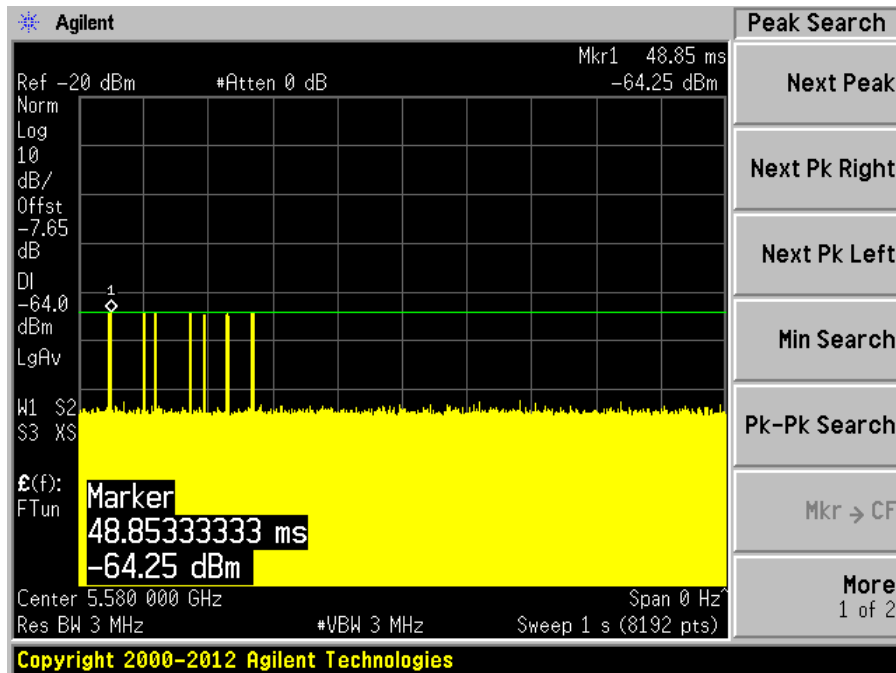

6 Radar Detection Performance Check

6.1 Radar Detection Performance Check

Procedure:

Stream MPEG file from master to slave

Generate radar waveform

Record whether or not the waveform was detected

At least 30 trials are applied for each radar type

For radar types with randomized parameters, each trial uses a unique waveform

Perform with each of the radar types 1-6

Confirm that the detection rate for each radar type meets the minimum requirement

Type 1A&1B, 2, 3, 4: 60% each

Type 5: 80%

Type 6: 70%

Confirm that the mean of the rates for radar types 1 through 4 meets the requirement of 80%

$$\text{Detection Ratio} = \frac{\text{Total Waveform Detections}}{\text{Total Waveform Trials}} \times 100$$

Test Results:

5280 MHz, 20 MHz Bandwidth

Radar Signal Type	Waveform/Trial Number	Detection (%)	Limit (%)	Pass/Fail
Type 1A/1B	30	100 %	60%	Pass
Type 2	30	100 %	60%	Pass
Type 3	30	100 %	60%	Pass
Type 4	30	100 %	60%	Pass
Aggregate (Type1 to 4)	120	100 %	80%	Pass
Type 5	30	100 %	80%	Pass
Type 6	30	100 %	70%	Pass

Please refer to the following statistical tables:

5280 MHz, 20 MHz Bandwidth

Table-1 Radar Type 1A/1B Statistical Performance

Trial #	Fc (MHz)	Pulse/Burst	Pulse Width (μS)	PRI (μs)	Detection (1:yes; 0:no)
1	5280	86	1	618	1
2	5280	78	1	678	1
3	5280	92	1	578	1
4	5280	72	1	738	1
5	5280	81	1	658	1
6	5280	63	1	838	1
7	5280	89	1	598	1
8	5280	58	1	918	1
9	5280	83	1	638	1
10	5280	99	1	538	1
11	5280	65	1	818	1
12	5280	18	1	3066	1
13	5280	95	1	558	1
14	5280	68	1	778	1
15	5280	76	1	698	1
16	5280	25	1	2171	1
17	5280	27	1	1983	1
18	5280	23	1	2397	1
19	5280	19	1	2797	1
20	5280	43	1	1247	1
21	5280	20	1	2701	1
22	5280	25	1	2128	1
23	5280	51	1	1044	1
24	5280	20	1	2766	1
25	5280	19	1	2817	1
26	5280	60	1	880	1
27	5280	24	1	2266	1
28	5280	29	1	1864	1
29	5280	29	1	1882	1
30	5280	66	1	806	1
Detection Percentage: 100 % (>60%)					

Table-2 Radar Type 2 Statistical Performance

Trial #	Fc (MHz)	Pulse/Burst	Pulse Width (μS)	PRI (μs)	Detection (1:yes; 0:no)
1	5280	24	3.7	180	1
2	5280	25	3	168	1
3	5280	28	2.4	164	1
4	5280	29	4	169	1
5	5280	27	5	184	1
6	5280	23	1.3	223	1
7	5280	23	1.8	181	1
8	5280	26	3.7	186	1
9	5280	24	4.9	170	1
10	5280	26	4.2	217	1
11	5280	25	1.8	198	1
12	5280	27	4.7	190	1
13	5280	26	2.1	226	1
14	5280	27	4.7	222	1
15	5280	28	3.5	223	1
16	5280	25	2.6	227	1
17	5280	28	4.7	155	1
18	5280	23	2.9	158	1
19	5280	29	4.3	211	1
20	5280	23	1.8	167	1
21	5280	29	3.6	155	1
22	5280	26	3.7	230	1
23	5280	25	2.4	219	1
24	5280	29	2	218	1
25	5280	25	3.3	200	1
26	5280	23	2	164	1
27	5280	27	4.1	187	1
28	5280	24	3.4	202	1
29	5280	24	4.5	188	1
30	5280	26	2.7	159	1
Detection Percentage: 100 % (>60%)					

Table-3 Radar Type 3 Statistical Performance

Trial #	Fc (MHz)	Pulse/Burst	Pulse Width (μS)	PRI (μs)	Detection (1:yes; 0:no)
1	5280	18	7.5	449	1
2	5280	16	9.2	261	1
3	5280	16	9.9	234	1
4	5280	17	8.6	253	1
5	5280	17	6.2	242	1
6	5280	17	9.2	363	1
7	5280	17	8	487	1
8	5280	17	9.8	486	1
9	5280	17	9.1	392	1
10	5280	16	9.7	472	1
11	5280	18	6	218	1
12	5280	16	7.2	334	1
13	5280	18	8.7	436	1
14	5280	17	6.8	280	1
15	5280	16	6.2	434	1
16	5280	17	9.7	330	1
17	5280	18	9.7	486	1
18	5280	18	7.9	367	1
19	5280	17	9.8	275	1
20	5280	18	8.1	250	1
21	5280	16	6.4	289	1
22	5280	18	8.3	345	1
23	5280	17	9.7	281	1
24	5280	16	8.9	310	1
25	5280	17	7.4	319	1
26	5280	17	10	401	1
27	5280	16	6.8	412	1
28	5280	18	8.1	463	1
29	5280	18	7.3	464	1
30	5280	17	8.8	232	1
Detection Percentage: 100 % (>60%)					

Table-4 Radar Type 4 Statistical Performance

Trial #	Fc (MHz)	Pulse/Burst	Pulse Width (μS)	PRI (μs)	Detection (1:yes; 0:no)
1	5280	15	18.9	361	1
2	5280	13	19.3	340	1
3	5280	12	16.3	457	1
4	5280	15	17.4	348	1
5	5280	15	18.2	453	1
6	5280	16	15.2	462	1
7	5280	16	14.1	331	1
8	5280	13	17	298	1
9	5280	14	13.2	419	1
10	5280	12	17.9	213	1
11	5280	15	14.8	333	1
12	5280	16	14.7	291	1
13	5280	12	11.7	427	1
14	5280	15	13.9	257	1
15	5280	13	14.3	360	1
16	5280	13	19.9	251	1
17	5280	16	14.1	469	1
18	5280	13	16.8	396	1
19	5280	14	18.4	330	1
20	5280	16	12.6	274	1
21	5280	13	13	433	1
22	5280	13	18	480	1
23	5280	12	18.4	421	1
24	5280	16	18.1	254	1
25	5280	15	17.9	463	1
26	5280	16	19.1	471	1
27	5280	15	16.6	496	1
28	5280	14	17.2	252	1
29	5280	14	16.3	404	1
30	5280	13	11.1	367	1
Detection Percentage: 100 % (>60%)					

Table-5 Radar Type 5 Statistical Performance

Bin5 Statistics 1

CF=5284 MHz

Trial #	Pulse	Chirp (MHz)	Pulse Width (µS)	Pulse 1-2 spacing (µS)	Pulse 2-3 spacing (µS)	Pulse Start(S)	Detection (1:yes; 0:no)
0	3	8	77.7	1492	1008	0.247388	1
1	1	9	81.6			0.867339	
2	2	14	59.4	1061		1.911327	
3	3	8	74.2	1965	1603	2.329776	
4	2	15	74.9	1762		3.069173	
5	2	10	54.6	1156		3.400608	
6	2	10	98.6	1893		4.387563	
7	2	6	79.8	1563		4.760194	
8	1	7	91.5			5.51239	
9	3	8	96.2	1595	1225	6.625083	
10	2	8	59.9	1857		7.095058	
11	1	20	89.9			7.353856	
12	2	12	51.6	1919		8.177675	
13	2	13	81.8	1432		8.732324	
14	3	6	58	1733	1086	9.971494	
15	1	16	94.2			10.39501	
16	3	10	95.7	1042	1986	10.75528	
17	2	12	56.1	1157		11.76539	

Bin5 Statistics 2

CF=5279 MHz

Trial #	Pulse	Chirp (MHz)	Pulse Width (µS)	Pulse 1-2 spacing (µS)	Pulse 2-3 spacing (µS)	Pulse Start(S)	Detection (1:yes; 0:no)
0	1	13	79.6			0.332996	1
1	2	14	92.1	1805		1.722235	
2	1	20	72.5			2.432978	
3	2	10	94.9	1243		3.088885	
4	2	16	55.1	1400		3.873049	
5	3	11	62.8	1458	1787	4.949171	
6	3	13	81	1406	1396	6.046567	
7	3	7	58.9	1634	1420	6.834819	
8	3	7	96.3	1629	1135	7.469973	
9	3	7	89.1	1619	1635	8.697142	
10	3	16	72.7	1439	1800	9.77757	
11	2	14	68.1	1150		10.738	
12	3	18	52	1090	1668	11.19532	

Bin5 Statistics 3

CF=5286 MHz

Trial #	Pulse	Chirp (MHz)	Pulse Width (µS)	Pulse 1-2 spacing (µS)	Pulse 2-3 spacing (µS)	Pulse Start(S)	Detection (1:yes; 0:no)
0	1	11	57.2			0.097058	1
1	2	11	81.6	1566		1.261274	
2	2	18	80.8	1085		3.243511	
3	3	10	92.4	1332	1089	4.122554	
4	1	16	81.9			4.530559	
5	2	7	84.7	1564		5.973967	
6	3	17	67.5	1915	1560	6.787774	
7	2	7	97.9	1604		7.653679	
8	1	11	61.9			9.519989	
9	2	19	98.6	1801		10.62526	
10	2	20	69.2	1359		11.97025	

Bin5 Statistics 4

CF=5283 MHz

Trial #	Pulse	Chirp (MHz)	Pulse Width (µS)	Pulse 1-2 spacing (µS)	Pulse 2-3 spacing (µS)	Pulse Start(S)	Detection (1:yes; 0:no)
0	2	13	86.4	1890		0.334275	1
1	2	19	90.1	1171		0.946242	
2	2	6	84.4	1556		1.638741	
3	2	16	73.2	1042		2.008383	
4	3	20	80.2	1724	1286	2.803683	
5	3	10	97.3	1705	1320	3.106737	
6	3	6	84.6	1587	1164	3.833429	
7	1	19	78.1			4.341084	
8	3	9	82.3	1175	1767	4.840481	
9	1	18	95.5			5.48952	
10	2	19	65	1820		6.236723	
11	3	7	87.5	1909	1119	6.601217	
12	2	8	85.7	1576		7.59792	
13	2	13	78.9	1662		8.102154	
14	2	16	63.2	1877		8.569817	
15	2	12	95.1	1942		9.054213	
16	1	13	98.2			9.85969	
17	1	10	82.6			10.22441	
18	1	9	76.1			10.97741	
19	3	8	82.8	1420	1376	11.44741	

Bin5 Statistics 5

CF=5279 MHz

Trial #	Pulse	Chirp (MHz)	Pulse Width (µS)	Pulse 1-2 spacing (uS)	Pulse 2-3 spacing (uS)	Pulse Start(S)	Detection (1:yes; 0:no)
0	1	5	53.5			0.497344	1
1	2	9	80.8	1092		1.634078	
2	2	11	62.6	1044		2.096543	
3	2	6	93.4	1467		2.863872	
4	1	5	78.7			3.844603	
5	3	8	79	1083	1738	5.112328	
6	2	7	62.9	1574		5.558768	
7	2	14	98.9	1296		6.258687	
8	2	15	87.2	1171		7.020164	
9	1	9	95.5			8.059692	
10	1	19	72			9.069944	
11	3	17	73	1419	1403	9.994151	
12	1	10	60.2			10.88658	
13	2	5	83.2	1911		11.18475	

Bin5 Statistics 6

CF=5277 MHz

Trial #	Pulse	Chirp (MHz)	Pulse Width (µS)	Pulse 1-2 spacing (uS)	Pulse 2-3 spacing (uS)	Pulse Start(S)	Detection (1:yes; 0:no)
0	1	14	57.9			0.418054	1
1	3	13	62.2	1836	1998	1.624832	
2	1	11	68.2			2.734316	
3	1	18	57.2			3.326126	
4	1	16	88.9			4.593493	
5	2	20	86	1738		4.839303	
6	3	8	50.7	1984	1031	5.861735	
7	2	17	57.9	1279		7.279043	
8	3	19	79.8	1076	1381	7.781799	
9	2	17	68	1745		8.409662	
10	3	9	85.7	1876	1380	9.699458	
11	3	11	55.8	1384	1116	10.81793	
12	2	19	93	1345		11.15937	

Bin5 Statistics 7

CF=5272 MHz

Trial #	Pulse	Chirp (MHz)	Pulse Width (µS)	Pulse 1-2 spacing (uS)	Pulse 2-3 spacing (uS)	Pulse Start(S)	Detection (1:yes; 0:no)
0	1	9	76.5			0.153449	1
1	2	15	81.8	1625		1.605711	
2	2	5	74.4	1819		1.870218	
3	2	12	80.8	1296		3.028359	
4	3	11	82.9	1487	1416	4.273293	
5	3	10	84.6	1995	1567	5.39722	
6	3	16	71.7	1612	1006	6.025312	
7	2	11	61.1	1190		6.818805	
8	3	10	61.9	1097	1395	7.845843	
9	2	15	60.8	1827		8.851147	
10	2	15	60.3	1864		9.973736	
11	2	12	96.5	1150		10.48995	
12	1	6	86.1			11.62755	

Bin5 Statistics 8

CF=5276 MHz

Trial #	Pulse	Chirp (MHz)	Pulse Width (µS)	Pulse 1-2 spacing (uS)	Pulse 2-3 spacing (uS)	Pulse Start(S)	Detection (1:yes; 0:no)
0	2	19	68.3	1481		0.176562	1
1	1	12	93.1			1.532148	
2	2	14	63.8	1277		2.516441	
3	3	13	75.7	1365	1017	3.41287	
4	2	12	59.1	1280		3.733158	
5	2	11	92.8	1472		4.332808	
6	1	13	70			5.679979	
7	1	11	67.3			6.705665	
8	2	9	90.8	1068		6.883974	
9	3	7	87.6	1521	1294	7.970358	
10	2	20	65.1	1600		8.635788	
11	3	13	61.5	1015	1508	9.552787	
12	1	19	66			10.45371	
13	3	15	85	1211	1998	11.729	

Bin5 Statistics 9

CF=5278 MHz

Trial #	Pulse	Chirp (MHz)	Pulse Width (µS)	Pulse 1-2 spacing (uS)	Pulse 2-3 spacing (uS)	Pulse Start(S)	Detection (1:yes; 0:no)
0	1	13	91.4			0.274084	1
1	2	14	56.8	1969		1.970757	
2	1	15	68.9			2.016014	
3	2	8	67.9	1481		3.801645	
4	2	13	59.4	1879		4.147548	
5	2	15	92.7	1415		5.117642	
6	1	6	50.9			6.671871	
7	2	19	93.1	1553		7.755969	
8	2	11	83.2	1301		8.526824	
9	3	9	75.2	1312	1397	9.969258	
10	3	10	50.4	1044	1753	10.06978	
11	3	8	80.3	1154	1128	11.19731	

Bin5 Statistics 10

CF=5279 MHz

Trial #	Pulse	Chirp (MHz)	Pulse Width (µS)	Pulse 1-2 spacing (uS)	Pulse 2-3 spacing (uS)	Pulse Start(S)	Detection (1:yes; 0:no)
0	2	13	87.2	1663		0.224267	1
1	1	5	90.8			0.634971	
2	2	18	83	1604		1.885275	
3	1	9	60			1.996541	
4	2	7	62.9	1487		2.908343	
5	1	17	58.5			3.3392	
6	2	16	81.6	1209		4.025468	
7	1	7	66.2			4.805537	
8	2	16	51.3	1820		5.639654	
9	3	5	59.5	1195	1600	5.901415	
10	1	18	53.8			6.47058	
11	2	15	77.3	1691		7.401953	
12	1	17	77.2			8.083266	
13	1	9	76.8			8.667636	
14	2	8	50.2	1956		9.235877	
15	3	5	80.7	1249	1495	9.795425	
16	2	8	82.8	1432		10.31297	
17	2	9	61.4	1233		11.16046	
18	2	19	93.9	1167		11.48948	

Bin5 Statistics 11

CF=5284 MHz

Trial #	Pulse	Chirp (MHz)	Pulse Width (µS)	Pulse 1-2 spacing (uS)	Pulse 2-3 spacing (uS)	Pulse Start(S)	Detection (1:yes; 0:no)
0	2	13	61.2	1969		0.042165	1
1	2	13	59.5	1117		1.157195	
2	3	12	86.4	1630	1901	2.209224	
3	1	8	59.9			2.923862	
4	2	12	87.4	1729		3.967573	
5	3	16	71.2	1480	1617	4.992294	
6	3	14	99.5	1263	1803	5.984489	
7	1	8	66.7			6.500055	
8	3	5	84.2	1155	1641	7.685646	
9	1	15	91.9			8.276096	
10	2	14	53.1	1602		9.285702	
11	2	17	79.5	1300		9.65921	
12	2	8	99.2	1468		11.07392	
13	2	15	64.4	1552		11.84224	

Bin5 Statistics 12

CF=5275 MHz

Trial #	Pulse	Chirp (MHz)	Pulse Width (µS)	Pulse 1-2 spacing (uS)	Pulse 2-3 spacing (uS)	Pulse Start(S)	Detection (1:yes; 0:no)
0	1	5	98.8			0.084778	1
1	2	5	98.5	1929		1.484414	
2	1	16	52.7			2.017523	
3	2	8	59.5	1317		2.813418	
4	3	7	65.9	1225	1612	3.40396	
5	2	11	85.8	1472		4.25452	
6	3	18	90.9	1995	1674	5.486619	
7	1	9	88.2			5.69717	
8	2	7	77.4	1370		7.03784	
9	2	14	77.9	1624		7.68237	
10	1	11	57.9			8.568857	
11	2	14	50.4	1346		9.29148	
12	2	9	97.8	1865		9.715155	
13	2	12	60.1	1111		10.55127	
14	3	8	53.6	1722	1432	11.78079	

Bin5 Statistics 13

CF=5279 MHz

Trial #	Pulse	Chirp (MHz)	Pulse Width (µS)	Pulse 1-2 spacing (uS)	Pulse 2-3 spacing (uS)	Pulse Start(S)	Detection (1:yes; 0:no)
0	2	8	99.6	1668		0.451434	1
1	2	7	92.9	1406		0.975294	
2	2	13	92.9	1576		1.388311	
3	2	17	69.9	1227		2.329793	
4	2	11	87.2	1720		2.53787	
5	2	16	86.8	1020		3.17148	
6	2	15	53.5	1864		4.356046	
7	2	11	86.5	1779		4.686326	
8	3	6	62.2	1881	1700	5.150778	
9	2	5	94.5	1119		6.011141	
10	3	16	94.1	1742	1137	6.623033	
11	2	5	74.3	1095		6.980296	
12	2	5	77.5	1906		7.805852	
13	2	19	54.9	1071		8.39463	
14	2	17	96.7	1608		9.089421	
15	2	19	62.9	1491		9.535753	
16	2	7	59.2	1797		10.46167	
17	2	14	72.3	1337		11.04787	
18	2	16	62.8	1479		11.8335	

Bin5 Statistics 14

CF=5286 MHz

Trial #	Pulse	Chirp (MHz)	Pulse Width (µS)	Pulse 1-2 spacing (uS)	Pulse 2-3 spacing (uS)	Pulse Start(S)	Detection (1:yes; 0:no)
0	1	17	81.6			0.811087	1
1	2	10	51.4	1719		1.313779	
2	3	14	68.1	1945	1322	2.711477	
3	2	15	97.7	1348		3.846593	
4	3	9	67.5	1309	1411	4.648593	
5	1	7	67.4			5.209691	
6	1	9	53.4			6.002191	
7	2	12	69.2	1217		7.436755	
8	2	8	63.6	1026		8.918778	
9	2	11	97.9	1026		9.819326	
10	3	6	50.5	1141	1407	10.99005	
11	3	11	68.4	1903	1175	11.22364	

Bin5 Statistics 15

CF=5276 MHz

Trial #	Pulse	Chirp (MHz)	Pulse Width (µS)	Pulse 1-2 spacing (µS)	Pulse 2-3 spacing (µS)	Pulse Start(S)	Detection (1:yes; 0:no)
0	1	20	85.3			0.308887	1
1	2	13	88.2	1912		2.127935	
2	2	13	66.3	1994		2.962191	
3	3	6	60.3	1443	1732	4.531364	
4	3	12	95.3	1674	1364	6.449244	
5	3	9	91.8	1371	1340	6.787815	
6	3	16	96.1	1686	1570	8.488346	
7	3	19	76.2	1515	1695	9.695718	
8	3	13	84	1764	1277	11.89271	

Bin5 Statistics 16

CF=5274 MHz

Trial #	Pulse	Chirp (MHz)	Pulse Width (µS)	Pulse 1-2 spacing (µS)	Pulse 2-3 spacing (µS)	Pulse Start(S)	Detection (1:yes; 0:no)
0	2	14	75	1472		0.094863	1
1	1	19	54.3			1.107028	
2	3	14	51	1081	1270	1.787169	
3	2	20	82.9	1745		2.564806	
4	1	9	56.9			3.224497	
5	2	19	86.3	1909		4.25217	
6	1	12	55.9			5.080647	
7	3	20	92	1126	1134	5.576734	
8	3	11	98.4	1936	1666	6.093586	
9	1	8	73			7.091853	
10	2	11	63.8	1255		7.507506	
11	2	13	95.7	1143		8.523219	
12	1	8	60			9.540031	
13	1	5	75.2			9.758929	
14	3	8	63.2	1475	1629	10.61218	
15	3	7	96.8	1280	1468	11.61374	

Bin5 Statistics 17

CF=5279 MHz

Trial #	Pulse	Chirp (MHz)	Pulse Width (µS)	Pulse 1-2 spacing (uS)	Pulse 2-3 spacing (uS)	Pulse Start(S)	Detection (1:yes; 0:no)
0	2	13	79.9	1779		0.509921	1
1	3	19	50.4	1657	1369	1.520148	
2	1	6	51.7			2.376837	
3	3	12	69.7	1713	1843	3.047779	
4	2	6	86.9	1251		3.799241	
5	1	12	68.2			4.407214	
6	2	9	99.9	1370		5.448587	
7	1	19	76			5.684251	
8	2	8	57.1	1569		6.433702	
9	2	7	53.8	1648		7.858573	
10	1	10	84.4			8.173768	
11	3	6	56.6	1340	1303	9.18774	
12	2	16	70.8	1690		9.70063	
13	2	13	56.2	1352		10.64797	
14	3	12	55.2	1392	1083	11.42036	

Bin5 Statistics 18

CF=5274 MHz

Trial #	Pulse	Chirp (MHz)	Pulse Width (µS)	Pulse 1-2 spacing (uS)	Pulse 2-3 spacing (uS)	Pulse Start(S)	Detection (1:yes; 0:no)
0	2	8	69.1	1779		0.128203	1
1	2	14	89.7	1909		1.653889	
2	2	5	98.7	1626		2.911821	
3	1	17	61.5			3.881385	
4	2	19	88.1	1014		5.09631	
5	2	20	87.8	1511		6.043177	
6	3	17	69.4	1304	1707	7.034243	
7	2	18	89.6	1584		8.510919	
8	2	19	59.6	1766		9.288821	
9	2	14	63.5	1896		10.15153	
10	2	17	86.4	1411		11.38949	

Bin5 Statistics 19

CF=5279 MHz

Trial #	Pulse	Chirp (MHz)	Pulse Width (µS)	Pulse 1-2 spacing (uS)	Pulse 2-3 spacing (uS)	Pulse Start(S)	Detection (1:yes; 0:no)
0	3	18	96.5	1501	1559	0.964364	1
1	3	11	61.6	1268	1974	1.276178	
2	2	18	57	1685		2.824813	
3	1	18	81.1			4.296214	
4	3	18	95.7	1900	1591	5.186271	
5	1	6	64.9			5.589312	
6	1	15	58.4			6.925416	
7	2	16	81.6	1518		7.958192	
8	1	16	83.2			9.3686	
9	2	15	59.3	1409		10.56748	
10	3	20	94.9	1296	1065	10.94954	

Bin5 Statistics 20

CF=5272 MHz

Trial #	Pulse	Chirp (MHz)	Pulse Width (µS)	Pulse 1-2 spacing (uS)	Pulse 2-3 spacing (uS)	Pulse Start(S)	Detection (1:yes; 0:no)
0	1	17	76.2			0.294247	1
1	1	8	60.6			2.391816	
2	1	14	87			3.03664	
3	1	18	95			4.020829	
4	1	15	83.2			5.530792	
5	3	5	55.4	1292	1212	6.868604	
6	3	16	67	1978	1383	8.752943	
7	3	15	85.5	1320	1729	10.43312	
8	2	15	86.9	1397		10.769541	

Bin5 Statistics 21

CF=5286 MHz

Trial #	Pulse	Chirp (MHz)	Pulse Width (µS)	Pulse 1-2 spacing (uS)	Pulse 2-3 spacing (uS)	Pulse Start(S)	Detection (1:yes; 0:no)
0	3	5	81.2	1097	1875	0.139859	1
1	2	18	79.6	1962		0.945473	
2	3	15	92.6	1827	1448	2.437675	
3	3	16	89.2	1678	1285	2.966722	
4	2	13	56.6	1604		4.495269	
5	2	8	94.4	1714		5.13665	
6	3	16	61.8	1610	1297	5.971738	
7	1	14	95.9			7.15302	
8	1	6	98.8			7.767934	
9	2	6	80.4	1352		8.408735	
10	3	5	68.4	1242	1041	9.576299	
11	3	14	70.6	1073	1758	11.043824	
12	2	9	81.5	1609		11.620244	

Bin5 Statistics 22

CF=5277 MHz

Trial #	Pulse	Chirp (MHz)	Pulse Width (µS)	Pulse 1-2 spacing (uS)	Pulse 2-3 spacing (uS)	Pulse Start(S)	Detection (1:yes; 0:no)
0	2	18	95.1	1233		0.186429	1
1	2	11	52.7	1217		1.169992	
2	2	10	53.7	1635		2.7159	
3	3	19	66.8	1033	1443	2.813106	
4	3	20	89.8	1929	1816	4.398456	
5	3	12	69	1084	1468	5.22173	
6	1	10	53.3			6.079127	
7	2	9	67	1825		7.137645	
8	2	5	68.1	1209		8.262811	
9	2	7	83.2	1811		8.391585	
10	1	7	86.9			9.622392	
11	2	15	51.8	1482		10.187068	
12	3	10	61.3	1956	1780	11.548865	

Bin5 Statistics 23

CF=5273 MHz

Trial #	Pulse	Chirp (MHz)	Pulse Width (µS)	Pulse 1-2 spacing (uS)	Pulse 2-3 spacing (uS)	Pulse Start(S)	Detection (1:yes; 0:no)
0	1	18	86.8			0.784655	1
1	2	5	78.4	1369		0.984544	
2	2	8	83.6	1488		1.985113	
3	2	10	60.6	1205		2.822092	
4	3	12	54.8	1899	1755	3.948351	
5	3	18	56.4	1764	1461	5.116139	
6	3	9	58.3	1208	1001	5.237703	
7	2	8	91.3	1535		6.45459	
8	2	6	72.2	1779		7.617823	
9	3	8	56.1	1169	1647	8.128513	
10	2	16	55.3	1642		9.173411	
11	1	15	60			10.208263	
12	2	8	52	1239		11.137664	
13	3	12	71.9	1291	1341	11.687246	

Bin5 Statistics 24

CF=5270 MHz

Trial #	Pulse	Chirp (MHz)	Pulse Width (µS)	Pulse 1-2 spacing (uS)	Pulse 2-3 spacing (uS)	Pulse Start(S)	Detection (1:yes; 0:no)
0	2	19	61.3	1824		0.536359	1
1	2	7	75.7	1310		1.129864	
2	3	9	96	1628	1046	1.762893	
3	2	15	90.5	1691		2.680636	
4	1	9	65.4			3.13576	
5	2	11	80	1956		4.17263	
6	3	10	83	1787	1094	4.563254	
7	3	9	64.6	1959	1382	5.049553	
8	2	9	92.6	1718		5.749165	
9	3	7	74.5	1322	1164	6.562345	
10	3	19	91.3	1148	1294	7.44748	
11	2	5	69.1	1825		8.161157	
12	2	10	65.4	1508		8.754005	
13	3	9	54.4	1855	1572	9.8594	
14	2	12	58.3	1569		10.558896	
15	2	8	77.4	1773		10.605011	
16	3	10	53.2	1446	1795	11.966028	

Bin5 Statistics 25

CF=5281 MHz

Trial #	Pulse	Chirp (MHz)	Pulse Width (µS)	Pulse 1-2 spacing (uS)	Pulse 2-3 spacing (uS)	Pulse Start(S)	Detection (1:yes; 0:no)
0	1	9	58.4			0.698552	1
1	2	18	97.7	1312		0.863129	
2	2	11	80.8	1786		1.824643	
3	2	19	74.2	1235		2.257931	
4	2	6	84.5	1332		3.59279	
5	3	8	51.2	1160	1751	4.287601	
6	2	12	65.1	1669		5.098204	
7	2	16	50.8	1845		5.482315	
8	3	9	85.3	1622	1469	6.08813	
9	2	9	91.7	1258		7.382227	
10	2	6	51.5	1512		8.152603	
11	2	6	75.1	1379		8.444929	
12	2	18	90.4	1663		9.15653	
13	3	15	52.4	1725	1866	10.337232	
14	2	16	71.5	1123		10.813752	
15	3	11	70.9	1540	1188	11.877549	

Bin5 Statistics 26

CF=5280 MHz

Trial #	Pulse	Chirp (MHz)	Pulse Width (µS)	Pulse 1-2 spacing (uS)	Pulse 2-3 spacing (uS)	Pulse Start(S)	Detection (1:yes; 0:no)
0	2	19	79.4	1956		0.488229	1
1	2	11	67	1031		1.43542	
2	3	10	81	1879	1608	2.093106	
3	3	10	89.4	1240	1822	2.485355	
4	1	17	78.6			3.303567	
5	3	18	80.5	1933	1999	3.782364	
6	1	9	50.1			4.975479	
7	2	13	83.6	1320		5.439264	
8	1	12	59.8			6.020143	
9	3	14	77.7	1817	1026	6.867421	
10	2	12	98.7	1246		7.932297	
11	1	13	61.2			8.497912	
12	3	13	51.1	1752	1069	9.088397	
13	2	17	77.2	1361		10.318099	
14	1	9	66.6			10.568117	
15	2	13	58.3	1203		11.682569	

Bin5 Statistics 27

CF=5281 MHz

Trial #	Pulse	Chirp (MHz)	Pulse Width (µS)	Pulse 1-2 spacing (uS)	Pulse 2-3 spacing (uS)	Pulse Start(S)	Detection (1:yes; 0:no)
0	1	16	68.9			0.102116	1
1	2	6	51.3	1751		1.705111	
2	1	20	78.6			2.116321	
3	3	10	87.3	1884	1163	2.8615	
4	2	18	91.9	1998		4.004876	
5	2	7	91.8	1039		4.442526	
6	2	15	59.4	1997		5.169786	
7	2	8	56.4	1277		6.33528	
8	1	14	90.2			7.521281	
9	2	15	78.6	1089		7.985829	
10	3	13	57.1	1699	1489	9.404869	
11	1	11	91			9.907426	
12	2	8	51.4	1850		10.977853	
13	3	16	98.5	1147	1019	11.992406	

Bin5 Statistics 28

CF=5273 MHz

Trial #	Pulse	Chirp (MHz)	Pulse Width (µS)	Pulse 1-2 spacing (uS)	Pulse 2-3 spacing (uS)	Pulse Start(S)	Detection (1:yes; 0:no)
0	2	6	79.4	1155		0.473355	1
1	2	17	59.6	1581		1.417046	
2	1	14	70.9			1.839635	
3	2	20	54.2	1898		2.936061	
4	2	9	68.1	1837		3.602045	
5	2	16	57.7	1957		4.444319	
6	2	15	68.6	1405		5.577304	
7	3	19	72.7	1038	1162	6.253134	
8	2	10	72.1	1546		6.566007	
9	2	15	52.2	1152		7.788043	
10	2	9	77.9	1017		8.742896	
11	2	18	94.1	1508		9.364378	
12	3	19	79.1	1598	1725	9.863992	
13	1	19	65.5			10.914519	
14	3	20	87.7	1305	1571	11.908953	

Bin5 Statistics 29

CF=5272 MHz

Trial #	Pulse	Chirp (MHz)	Pulse Width (µS)	Pulse 1-2 spacing (uS)	Pulse 2-3 spacing (uS)	Pulse Start(S)	Detection (1:yes; 0:no)
0	2	18	59.5	1290		0.614736	1
1	1	17	71.4			1.096681	
2	2	17	70.3	1346		1.513747	
3	2	15	68.3	1234		2.558742	
4	2	12	91.9	1074		2.918977	
5	2	17	64.4	1881		4.15055	
6	2	16	66.5	1826		4.923554	
7	3	18	92.3	1270	1991	5.006342	
8	3	14	60.5	1658	1067	5.952385	
9	3	15	69.5	1968	1046	7.003447	
10	3	9	84.5	1383	1525	7.32273	
11	1	19	80.6			8.379378	
12	2	20	82.1	1757		8.835624	
13	2	6	91.7	1775		9.796422	
14	3	9	68.2	1988	1723	10.120584	
15	2	16	54.3	1888		10.870293	
16	2	8	88.1	1502		11.535916	

Bin5 Statistics 30

CF=5274 MHz

Trial #	Pulse	Chirp (MHz)	Pulse Width (µS)	Pulse 1-2 spacing (uS)	Pulse 2-3 spacing (uS)	Pulse Start(S)	Detection (1:yes; 0:no)
0	2	13	64.3	1969		0.763714	1
1	3	19	75.2	1681	1714	1.849869	
2	2	12	58	1179		2.002695	
3	1	9	91.2			3.824127	
4	3	10	85.9	1042	1119	4.034183	
5	2	18	91.9	1993		5.73603	
6	2	11	81.1	1615		6.89325	
7	2	17	82.9	1587		7.183474	
8	3	16	83.2	1627	1074	8.615409	
9	3	7	65.1	1447	1517	9.472615	
10	1	18	91.4			10.641878	
11	1	19	78.2			11.552219	

Table-6 Radar Type 6 Statistical Performance

Trial #	Fc (MHz)	Pulse /Burst	Pulse Width (µS)	PRI (µs)	Detection (1:yes; 0:no)	Hopping Sequence
1	5280	9	1	333	1	5336.0, 5666.0, 5579.0, 5361.0, 5416.0, 5527.0, 5603.0, 5404.0, 5329.0, 5487.0, 5576.0, 5321.0, 5270.0, 5679.0, 5384.0, 5483.0, 5362.0, 5316.0, 5499.0, 5427.0, 5426.0, 5585.0, 5643.0, 5515.0, 5434.0, 5683.0, 5720.0, 5546.0, 5473.0, 5502.0, 5331.0, 5570.0, 5584.0, 5354.0, 5624.0, 5271.0, 5430.0, 5597.0, 5639.0, 5364.0, 5604.0, 5256.0, 5492.0, 5470.0, 5488.0, 5588.0, 5394.0, 5587.0, 5649.0, 5715.0, 5521.0, 5569.0, 5326.0, 5257.0, 5449.0, 5370.0, 5413.0, 5555.0, 5490.0, 5383.0, 5607.0, 5461.0, 5714.0, 5366.0, 5582.0, 5250.0, 5374.0, 5565.0, 5609.0, 5399.0, 5664.0, 5425.0, 5552.0, 5339.0, 5699.0, 5698.0, 5694.0, 5633.0, 5517.0, 5692.0, 5423.0, 5373.0, 5357.0, 5424.0, 5511.0, 5553.0, 5281.0, 5267.0, 5457.0, 5265.0, 5610.0, 5593.0, 5458.0, 5541.0, 5345.0, 5496.0, 5409.0, 5574.0, 5543.0, 5663.0 (number of hits: 3)
2	5280	9	1	333	1	5593.0, 5448.0, 5635.0, 5351.0, 5384.0, 5380.0, 5326.0, 5528.0, 5282.0, 5606.0, 5269.0, 5582.0, 5497.0, 5510.0, 5575.0, 5600.0, 5614.0, 5413.0, 5309.0, 5640.0, 5291.0, 5423.0, 5297.0, 5715.0, 5688.0, 5339.0, 5270.0, 5392.0, 5290.0, 5267.0, 5634.0, 5433.0, 5256.0, 5388.0, 5664.0, 5277.0, 5347.0, 5514.0, 5316.0, 5569.0, 5287.0, 5286.0, 5385.0, 5334.0, 5509.0, 5357.0, 5562.0, 5419.0, 5257.0, 5603.0, 5275.0, 5311.0, 5481.0, 5336.0, 5670.0, 5630.0, 5707.0, 5623.0, 5685.0, 5573.0, 5453.0, 5459.0, 5482.0, 5432.0, 5605.0, 5461.0, 5444.0, 5407.0, 5479.0, 5447.0, 5535.0, 5255.0, 5487.0, 5507.0, 5547.0, 5406.0, 5586.0, 5550.0, 5321.0, 5363.0, 5312.0, 5597.0, 5608.0, 5401.0, 5445.0, 5681.0, 5678.0, 5284.0, 5452.0, 5412.0, 5590.0, 5653.0, 5556.0, 5434.0, 5345.0, 5332.0, 5650.0, 5402.0, 5252.0, 5716.0 (number of hits: 7)
3	5280	9	1	333	1	5400.0, 5540.0, 5508.0, 5476.0, 5539.0, 5483.0, 5678.0, 5477.0, 5480.0, 5665.0, 5635.0, 5514.0, 5680.0, 5439.0, 5269.0, 5642.0, 5537.0, 5434.0, 5363.0, 5420.0, 5512.0, 5517.0, 5528.0, 5710.0, 5500.0, 5455.0, 5585.0, 5382.0, 5707.0, 5581.0, 5462.0, 5621.0, 5340.0, 5504.0, 5450.0, 5386.0, 5468.0, 5529.0, 5520.0, 5453.0, 5560.0, 5345.0, 5640.0, 5417.0, 5426.0, 5554.0, 5352.0, 5446.0, 5597.0, 5359.0, 5323.0, 5708.0, 5590.0, 5682.0, 5406.0,

						5572.0, 5557.0, 5334.0, 5519.0, 5474.0, 5688.0, 5553.0, 5672.0, 5630.0, 5505.0, 5264.0, 5661.0, 5357.0, 5341.0, 5622.0, 5629.0, 5566.0, 5414.0, 5254.0, 5681.0, 5615.0, 5333.0, 5267.0, 5558.0, 5526.0, 5470.0, 5305.0, 5675.0, 5601.0, 5458.0, 5605.0, 5582.0, 5252.0, 5273.0, 5713.0, 5632.0, 5694.0, 5641.0, 5647.0, 5501.0, 5471.0, 5443.0, 5294.0, 5649.0, 5289.0 (number of hits: 2)
4	5280	9	1	333	1	5254.0, 5599.0, 5643.0, 5694.0, 5299.0, 5641.0, 5421.0, 5313.0, 5268.0, 5451.0, 5350.0, 5673.0, 5369.0, 5576.0, 5345.0, 5475.0, 5398.0, 5712.0, 5284.0, 5710.0, 5457.0, 5276.0, 5353.0, 5280.0, 5362.0, 5329.0, 5494.0, 5523.0, 5472.0, 5460.0, 5660.0, 5509.0, 5560.0, 5493.0, 5610.0, 5410.0, 5585.0, 5256.0, 5649.0, 5305.0, 5356.0, 5355.0, 5282.0, 5606.0, 5647.0, 5252.0, 5319.0, 5564.0, 5458.0, 5374.0, 5654.0, 5433.0, 5666.0, 5474.0, 5615.0, 5370.0, 5661.0, 5491.0, 5269.0, 5414.0, 5489.0, 5366.0, 5498.0, 5708.0, 5696.0, 5528.0, 5445.0, 5595.0, 5505.0, 5429.0, 5455.0, 5513.0, 5483.0, 5657.0, 5391.0, 5477.0, 5518.0, 5704.0, 5537.0, 5559.0, 5488.0, 5405.0, 5334.0, 5485.0, 5492.0, 5714.0, 5609.0, 5396.0, 5341.0, 5275.0, 5659.0, 5514.0, 5301.0, 5349.0, 5600.0, 5625.0, 5685.0, 5295.0, 5278.0, 5265.0 (number of hits: 6)
5	5280	9	1	333	1	5559.0, 5393.0, 5665.0, 5483.0, 5616.0, 5313.0, 5274.0, 5332.0, 5514.0, 5479.0, 5666.0, 5629.0, 5579.0, 5580.0, 5663.0, 5255.0, 5535.0, 5623.0, 5454.0, 5598.0, 5423.0, 5281.0, 5530.0, 5596.0, 5432.0, 5682.0, 5365.0, 5482.0, 5303.0, 5272.0, 5576.0, 5372.0, 5257.0, 5259.0, 5493.0, 5628.0, 5671.0, 5567.0, 5305.0, 5342.0, 5262.0, 5502.0, 5427.0, 5549.0, 5711.0, 5414.0, 5508.0, 5651.0, 5667.0, 5668.0, 5703.0, 5656.0, 5521.0, 5397.0, 5390.0, 5420.0, 5282.0, 5515.0, 5361.0, 5391.0, 5450.0, 5481.0, 5718.0, 5458.0, 5615.0, 5325.0, 5605.0, 5360.0, 5291.0, 5424.0, 5364.0, 5473.0, 5684.0, 5316.0, 5554.0, 5462.0, 5486.0, 5312.0, 5690.0, 5288.0, 5680.0, 5557.0, 5395.0, 5606.0, 5374.0, 5722.0, 5692.0, 5366.0, 5565.0, 5594.0, 5719.0, 5669.0, 5385.0, 5356.0, 5478.0, 5633.0, 5553.0, 5343.0, 5256.0, 5449.0 (number of hits: 5)
6	5280	9	1	333	1	5462.0, 5270.0, 5444.0, 5398.0, 5453.0, 5602.0, 5545.0, 5354.0, 5331.0, 5609.0, 5408.0, 5723.0, 5281.0, 5575.0, 5414.0, 5275.0, 5259.0, 5559.0, 5536.0, 5334.0, 5546.0, 5256.0, 5360.0, 5439.0, 5395.0, 5418.0, 5297.0, 5500.0, 5513.0, 5314.0, 5322.0, 5392.0, 5461.0, 5448.0, 5307.0,

						5549.0, 5579.0, 5493.0, 5712.0, 5404.0, 5709.0, 5421.0, 5527.0, 5680.0, 5292.0, 5496.0, 5286.0, 5491.0, 5690.0, 5484.0, 5713.0, 5374.0, 5595.0, 5278.0, 5656.0, 5529.0, 5285.0, 5368.0, 5522.0, 5313.0, 5617.0, 5510.0, 5618.0, 5535.0, 5467.0, 5647.0, 5511.0, 5363.0, 5588.0, 5655.0, 5570.0, 5330.0, 5499.0, 5604.0, 5357.0, 5329.0, 5678.0, 5272.0, 5555.0, 5438.0, 5523.0, 5318.0, 5376.0, 5490.0, 5280.0, 5652.0, 5315.0, 5422.0, 5640.0, 5451.0, 5407.0, 5682.0, 5526.0, 5556.0, 5670.0, 5646.0, 5269.0, 5625.0, 5708.0, 5495.0 (number of hits: 8)
7	5280	9	1	333	1	5435.0, 5630.0, 5490.0, 5656.0, 5414.0, 5602.0, 5693.0, 5520.0, 5716.0, 5619.0, 5648.0, 5421.0, 5340.0, 5635.0, 5488.0, 5646.0, 5314.0, 5347.0, 5709.0, 5573.0, 5710.0, 5373.0, 5481.0, 5336.0, 5291.0, 5348.0, 5456.0, 5550.0, 5307.0, 5471.0, 5439.0, 5624.0, 5614.0, 5600.0, 5663.0, 5565.0, 5677.0, 5397.0, 5620.0, 5455.0, 5412.0, 5446.0, 5305.0, 5558.0, 5352.0, 5346.0, 5284.0, 5686.0, 5567.0, 5634.0, 5654.0, 5525.0, 5703.0, 5504.0, 5408.0, 5502.0, 5518.0, 5655.0, 5382.0, 5318.0, 5683.0, 5575.0, 5477.0, 5329.0, 5269.0, 5257.0, 5519.0, 5714.0, 5527.0, 5626.0, 5531.0, 5615.0, 5339.0, 5563.0, 5270.0, 5383.0, 5625.0, 5530.0, 5484.0, 5640.0, 5415.0, 5545.0, 5611.0, 5542.0, 5259.0, 5717.0, 5444.0, 5544.0, 5688.0, 5293.0, 5489.0, 5277.0, 5267.0, 5426.0, 5441.0, 5707.0, 5698.0, 5463.0, 5402.0, 5680.0 (number of hits: 3)
8	5280	9	1	333	1	5347.0, 5422.0, 5680.0, 5629.0, 5374.0, 5390.0, 5457.0, 5478.0, 5271.0, 5597.0, 5636.0, 5693.0, 5315.0, 5351.0, 5593.0, 5324.0, 5615.0, 5460.0, 5370.0, 5624.0, 5447.0, 5637.0, 5542.0, 5562.0, 5531.0, 5401.0, 5290.0, 5467.0, 5449.0, 5428.0, 5464.0, 5653.0, 5621.0, 5479.0, 5533.0, 5513.0, 5398.0, 5718.0, 5623.0, 5388.0, 5396.0, 5402.0, 5572.0, 5452.0, 5723.0, 5431.0, 5708.0, 5590.0, 5278.0, 5681.0, 5522.0, 5466.0, 5506.0, 5443.0, 5435.0, 5610.0, 5356.0, 5354.0, 5455.0, 5264.0, 5602.0, 5406.0, 5357.0, 5557.0, 5563.0, 5281.0, 5578.0, 5698.0, 5706.0, 5717.0, 5333.0, 5709.0, 5612.0, 5254.0, 5430.0, 5382.0, 5456.0, 5487.0, 5505.0, 5417.0, 5294.0, 5689.0, 5724.0, 5582.0, 5540.0, 5635.0, 5654.0, 5581.0, 5408.0, 5595.0, 5564.0, 5411.0, 5546.0, 5274.0, 5258.0, 5703.0, 5627.0, 5416.0, 5385.0, 5580.0 (number of hits: 4)
9	5280	9	1	333	1	5420.0, 5353.0, 5333.0, 5665.0, 5399.0, 5521.0, 5302.0, 5640.0, 5644.0, 5374.0, 5324.0, 5507.0, 5310.0, 5599.0, 5704.0,

						5495.0, 5380.0, 5717.0, 5281.0, 5398.0, 5571.0, 5688.0, 5447.0, 5413.0, 5578.0, 5389.0, 5407.0, 5478.0, 5440.0, 5546.0, 5693.0, 5651.0, 5461.0, 5297.0, 5626.0, 5716.0, 5663.0, 5683.0, 5621.0, 5416.0, 5500.0, 5619.0, 5545.0, 5277.0, 5672.0, 5342.0, 5258.0, 5430.0, 5515.0, 5260.0, 5658.0, 5696.0, 5635.0, 5268.0, 5372.0, 5674.0, 5394.0, 5477.0, 5306.0, 5657.0, 5330.0, 5567.0, 5646.0, 5549.0, 5589.0, 5291.0, 5695.0, 5432.0, 5562.0, 5327.0, 5603.0, 5375.0, 5298.0, 5620.0, 5605.0, 5355.0, 5471.0, 5263.0, 5331.0, 5376.0, 5269.0, 5335.0, 5405.0, 5280.0, 5393.0, 5715.0, 5558.0, 5493.0, 5600.0, 5323.0, 5624.0, 5563.0, 5483.0, 5284.0, 5264.0, 5724.0, 5616.0, 5368.0, 5668.0, 5489.0 (number of hits: 4)
10	5280	9	1	333	1	5651.0, 5447.0, 5341.0, 5425.0, 5254.0, 5587.0, 5668.0, 5286.0, 5455.0, 5640.0, 5253.0, 5275.0, 5670.0, 5533.0, 5424.0, 5363.0, 5388.0, 5401.0, 5722.0, 5457.0, 5274.0, 5502.0, 5399.0, 5413.0, 5370.0, 5564.0, 5322.0, 5483.0, 5517.0, 5317.0, 5558.0, 5319.0, 5565.0, 5342.0, 5648.0, 5596.0, 5631.0, 5599.0, 5535.0, 5525.0, 5299.0, 5278.0, 5292.0, 5584.0, 5603.0, 5532.0, 5563.0, 5430.0, 5315.0, 5693.0, 5569.0, 5639.0, 5609.0, 5694.0, 5309.0, 5617.0, 5305.0, 5422.0, 5662.0, 5531.0, 5357.0, 5716.0, 5500.0, 5658.0, 5373.0, 5312.0, 5644.0, 5284.0, 5291.0, 5555.0, 5697.0, 5267.0, 5515.0, 5580.0, 5450.0, 5547.0, 5679.0, 5460.0, 5529.0, 5485.0, 5431.0, 5546.0, 5429.0, 5491.0, 5289.0, 5691.0, 5365.0, 5297.0, 5588.0, 5298.0, 5350.0, 5423.0, 5589.0, 5545.0, 5338.0, 5647.0, 5395.0, 5251.0, 5400.0, 5303.0 (number of hits: 6)
11	5280	9	1	333	1	5323.0, 5564.0, 5666.0, 5653.0, 5443.0, 5265.0, 5539.0, 5507.0, 5470.0, 5414.0, 5370.0, 5322.0, 5331.0, 5522.0, 5617.0, 5375.0, 5384.0, 5519.0, 5424.0, 5606.0, 5273.0, 5383.0, 5333.0, 5646.0, 5395.0, 5269.0, 5288.0, 5547.0, 5389.0, 5341.0, 5680.0, 5518.0, 5418.0, 5626.0, 5301.0, 5464.0, 5394.0, 5456.0, 5326.0, 5388.0, 5536.0, 5633.0, 5599.0, 5325.0, 5575.0, 5421.0, 5272.0, 5672.0, 5293.0, 5689.0, 5386.0, 5310.0, 5452.0, 5483.0, 5621.0, 5285.0, 5429.0, 5378.0, 5422.0, 5661.0, 5695.0, 5445.0, 5454.0, 5371.0, 5409.0, 5315.0, 5687.0, 5540.0, 5596.0, 5438.0, 5603.0, 5397.0, 5250.0, 5415.0, 5568.0, 5559.0, 5427.0, 5721.0, 5641.0, 5458.0, 5254.0, 5541.0, 5432.0, 5473.0, 5697.0, 5670.0, 5274.0, 5291.0, 5567.0, 5690.0, 5332.0, 5590.0, 5650.0, 5499.0, 5497.0, 5376.0, 5538.0, 5262.0, 5347.0, 5485.0

						(number of hits: 5)
12	5280	9	1	333	1	5356.0, 5571.0, 5448.0, 5391.0, 5498.0, 5318.0, 5325.0, 5496.0, 5261.0, 5278.0, 5267.0, 5274.0, 5663.0, 5440.0, 5566.0, 5276.0, 5569.0, 5629.0, 5570.0, 5314.0, 5470.0, 5290.0, 5312.0, 5657.0, 5605.0, 5563.0, 5593.0, 5631.0, 5251.0, 5699.0, 5287.0, 5550.0, 5382.0, 5283.0, 5671.0, 5293.0, 5257.0, 5289.0, 5449.0, 5316.0, 5576.0, 5653.0, 5621.0, 5321.0, 5275.0, 5549.0, 5472.0, 5586.0, 5660.0, 5459.0, 5708.0, 5638.0, 5410.0, 5501.0, 5351.0, 5273.0, 5686.0, 5620.0, 5509.0, 5482.0, 5588.0, 5294.0, 5487.0, 5435.0, 5291.0, 5597.0, 5394.0, 5306.0, 5451.0, 5441.0, 5264.0, 5342.0, 5541.0, 5673.0, 5309.0, 5365.0, 5322.0, 5360.0, 5536.0, 5404.0, 5297.0, 5578.0, 5296.0, 5400.0, 5685.0, 5614.0, 5645.0, 5539.0, 5609.0, 5420.0, 5467.0, 5317.0, 5548.0, 5260.0, 5511.0, 5475.0, 5445.0, 5378.0, 5516.0, 5700.0
						(number of hits: 8)
13	5280	9	1	333	1	5482.0, 5291.0, 5568.0, 5285.0, 5266.0, 5481.0, 5506.0, 5324.0, 5622.0, 5670.0, 5343.0, 5692.0, 5627.0, 5269.0, 5264.0, 5265.0, 5340.0, 5615.0, 5581.0, 5344.0, 5639.0, 5518.0, 5541.0, 5545.0, 5394.0, 5658.0, 5385.0, 5349.0, 5563.0, 5685.0, 5444.0, 5271.0, 5275.0, 5666.0, 5652.0, 5616.0, 5368.0, 5317.0, 5711.0, 5270.0, 5716.0, 5500.0, 5519.0, 5256.0, 5449.0, 5600.0, 5504.0, 5372.0, 5626.0, 5412.0, 5284.0, 5642.0, 5389.0, 5705.0, 5352.0, 5532.0, 5533.0, 5643.0, 5559.0, 5440.0, 5553.0, 5419.0, 5505.0, 5638.0, 5493.0, 5299.0, 5460.0, 5598.0, 5591.0, 5602.0, 5599.0, 5722.0, 5437.0, 5668.0, 5718.0, 5503.0, 5474.0, 5470.0, 5278.0, 5405.0, 5453.0, 5445.0, 5468.0, 5556.0, 5300.0, 5429.0, 5459.0, 5710.0, 5649.0, 5636.0, 5311.0, 5677.0, 5564.0, 5574.0, 5609.0, 5634.0, 5329.0, 5516.0, 5486.0, 5332.0
						(number of hits: 6)
14	5280	9	1	333	1	5316.0, 5446.0, 5445.0, 5665.0, 5579.0, 5322.0, 5610.0, 5352.0, 5601.0, 5295.0, 5300.0, 5356.0, 5532.0, 5407.0, 5436.0, 5427.0, 5269.0, 5522.0, 5674.0, 5304.0, 5391.0, 5719.0, 5709.0, 5550.0, 5405.0, 5478.0, 5370.0, 5604.0, 5681.0, 5277.0, 5609.0, 5470.0, 5627.0, 5651.0, 5700.0, 5393.0, 5526.0, 5375.0, 5541.0, 5699.0, 5420.0, 5721.0, 5490.0, 5272.0, 5542.0, 5663.0, 5669.0, 5354.0, 5638.0, 5501.0, 5506.0, 5588.0, 5502.0, 5461.0, 5509.0, 5613.0, 5640.0, 5516.0, 5413.0, 5511.0, 5561.0, 5492.0, 5430.0, 5270.0, 5348.0, 5546.0, 5424.0, 5643.0, 5252.0, 5449.0, 5481.0, 5544.0, 5381.0, 5310.0, 5376.0, 5382.0, 5317.0, 5482.0, 5435.0, 5529.0

						5524.0, 5264.0, 5623.0, 5462.0, 5633.0, 5327.0, 5279.0, 5268.0, 5510.0, 5569.0, 5433.0, 5412.0, 5590.0, 5459.0, 5504.0, 5563.0, 5559.0, 5584.0, 5323.0, 5513.0 (number of hits: 4)
15	5280	9	1	333	1	5715.0, 5624.0, 5560.0, 5335.0, 5416.0, 5705.0, 5466.0, 5340.0, 5712.0, 5284.0, 5305.0, 5588.0, 5339.0, 5542.0, 5383.0, 5275.0, 5647.0, 5272.0, 5487.0, 5640.0, 5371.0, 5527.0, 5482.0, 5607.0, 5252.0, 5707.0, 5299.0, 5554.0, 5408.0, 5312.0, 5358.0, 5397.0, 5307.0, 5291.0, 5316.0, 5522.0, 5402.0, 5467.0, 5347.0, 5641.0, 5492.0, 5575.0, 5277.0, 5528.0, 5678.0, 5585.0, 5529.0, 5454.0, 5568.0, 5395.0, 5254.0, 5438.0, 5352.0, 5437.0, 5475.0, 5331.0, 5581.0, 5490.0, 5396.0, 5514.0, 5578.0, 5509.0, 5489.0, 5615.0, 5436.0, 5674.0, 5603.0, 5429.0, 5259.0, 5276.0, 5623.0, 5557.0, 5648.0, 5333.0, 5576.0, 5356.0, 5612.0, 5632.0, 5643.0, 5392.0, 5424.0, 5413.0, 5287.0, 5302.0, 5374.0, 5314.0, 5634.0, 5706.0, 5590.0, 5400.0, 5579.0, 5363.0, 5411.0, 5564.0, 5362.0, 5619.0, 5676.0, 5668.0, 5326.0, 5425.0 (number of hits: 6)
16	5280	9	1	333	1	5256.0, 5401.0, 5596.0, 5397.0, 5341.0, 5549.0, 5419.0, 5440.0, 5403.0, 5605.0, 5297.0, 5389.0, 5287.0, 5707.0, 5653.0, 5333.0, 5554.0, 5552.0, 5439.0, 5359.0, 5342.0, 5566.0, 5648.0, 5665.0, 5659.0, 5446.0, 5689.0, 5259.0, 5350.0, 5499.0, 5586.0, 5263.0, 5582.0, 5533.0, 5292.0, 5277.0, 5656.0, 5345.0, 5450.0, 5295.0, 5644.0, 5317.0, 5428.0, 5283.0, 5546.0, 5620.0, 5551.0, 5398.0, 5503.0, 5532.0, 5337.0, 5412.0, 5487.0, 5600.0, 5548.0, 5395.0, 5671.0, 5706.0, 5633.0, 5387.0, 5308.0, 5519.0, 5629.0, 5626.0, 5306.0, 5522.0, 5647.0, 5469.0, 5415.0, 5687.0, 5309.0, 5335.0, 5673.0, 5691.0, 5354.0, 5537.0, 5616.0, 5353.0, 5462.0, 5722.0, 5508.0, 5296.0, 5680.0, 5466.0, 5662.0, 5438.0, 5260.0, 5343.0, 5581.0, 5667.0, 5611.0, 5506.0, 5269.0, 5307.0, 5619.0, 5304.0, 5386.0, 5524.0, 5429.0, 5539.0 (number of hits: 3)
17	5280	9	1	333	1	5623.0, 5424.0, 5641.0, 5275.0, 5584.0, 5294.0, 5367.0, 5428.0, 5399.0, 5341.0, 5278.0, 5356.0, 5333.0, 5704.0, 5456.0, 5716.0, 5258.0, 5552.0, 5650.0, 5343.0, 5631.0, 5463.0, 5684.0, 5430.0, 5288.0, 5252.0, 5551.0, 5512.0, 5472.0, 5369.0, 5390.0, 5490.0, 5461.0, 5352.0, 5262.0, 5393.0, 5605.0, 5285.0, 5469.0, 5665.0, 5359.0, 5549.0, 5603.0, 5523.0, 5364.0, 5560.0, 5307.0, 5521.0, 5282.0, 5542.0, 5335.0, 5299.0, 5440.0, 5473.0, 5513.0, 5519.0, 5397.0, 5531.0, 5578.0, 5545.0

						5700.0, 5371.0, 5632.0, 5558.0, 5320.0, 5618.0, 5538.0, 5555.0, 5331.0, 5431.0, 5562.0, 5496.0, 5455.0, 5345.0, 5405.0, 5480.0, 5622.0, 5638.0, 5668.0, 5503.0, 5468.0, 5708.0, 5693.0, 5656.0, 5635.0, 5522.0, 5629.0, 5561.0, 5414.0, 5264.0, 5583.0, 5274.0, 5387.0, 5502.0, 5381.0, 5392.0, 5539.0, 5416.0, 5450.0, 5377.0 (number of hits: 6)
18	5280	9	1	333	1	5359.0, 5344.0, 5619.0, 5275.0, 5437.0, 5645.0, 5294.0, 5376.0, 5594.0, 5704.0, 5525.0, 5633.0, 5435.0, 5406.0, 5686.0, 5639.0, 5355.0, 5484.0, 5331.0, 5715.0, 5522.0, 5368.0, 5700.0, 5632.0, 5400.0, 5288.0, 5379.0, 5258.0, 5582.0, 5527.0, 5600.0, 5316.0, 5466.0, 5701.0, 5714.0, 5346.0, 5471.0, 5723.0, 5666.0, 5398.0, 5653.0, 5693.0, 5482.0, 5470.0, 5442.0, 5494.0, 5279.0, 5350.0, 5370.0, 5596.0, 5410.0, 5387.0, 5395.0, 5401.0, 5642.0, 5451.0, 5486.0, 5389.0, 5623.0, 5534.0, 5575.0, 5637.0, 5360.0, 5659.0, 5555.0, 5383.0, 5418.0, 5610.0, 5546.0, 5586.0, 5694.0, 5373.0, 5429.0, 5485.0, 5345.0, 5578.0, 5718.0, 5366.0, 5556.0, 5558.0, 5311.0, 5377.0, 5467.0, 5447.0, 5339.0, 5644.0, 5712.0, 5271.0, 5536.0, 5702.0, 5635.0, 5703.0, 5643.0, 5514.0, 5524.0, 5663.0, 5337.0, 5573.0, 5293.0, 5343.0 (number of hits: 4)
19	5280	9	1	333	1	5529.0, 5472.0, 5255.0, 5330.0, 5630.0, 5396.0, 5583.0, 5252.0, 5406.0, 5520.0, 5482.0, 5341.0, 5649.0, 5545.0, 5581.0, 5622.0, 5384.0, 5425.0, 5499.0, 5587.0, 5459.0, 5334.0, 5426.0, 5424.0, 5378.0, 5432.0, 5644.0, 5638.0, 5380.0, 5577.0, 5274.0, 5641.0, 5345.0, 5281.0, 5526.0, 5722.0, 5382.0, 5302.0, 5304.0, 5468.0, 5706.0, 5528.0, 5654.0, 5549.0, 5539.0, 5601.0, 5365.0, 5279.0, 5264.0, 5360.0, 5452.0, 5407.0, 5671.0, 5667.0, 5664.0, 5607.0, 5340.0, 5409.0, 5481.0, 5343.0, 5495.0, 5294.0, 5619.0, 5692.0, 5508.0, 5690.0, 5698.0, 5443.0, 5490.0, 5408.0, 5436.0, 5537.0, 5410.0, 5266.0, 5361.0, 5322.0, 5560.0, 5542.0, 5633.0, 5546.0, 5489.0, 5458.0, 5301.0, 5677.0, 5387.0, 5530.0, 5696.0, 5522.0, 5659.0, 5323.0, 5411.0, 5655.0, 5502.0, 5418.0, 5527.0, 5353.0, 5433.0, 5571.0, 5682.0, 5466.0 (number of hits: 3)
20	5280	9	1	333	1	5315.0, 5267.0, 5637.0, 5506.0, 5272.0, 5440.0, 5287.0, 5273.0, 5387.0, 5259.0, 5452.0, 5711.0, 5677.0, 5716.0, 5593.0, 5288.0, 5424.0, 5517.0, 5417.0, 5647.0, 5513.0, 5521.0, 5461.0, 5503.0, 5685.0, 5398.0, 5492.0, 5494.0, 5321.0, 5313.0, 5508.0, 5687.0, 5411.0, 5281.0, 5686.0, 5286.0, 5356.0, 5708.0, 5251.0, 5418.0,

						5601.0, 5473.0, 5533.0, 5698.0, 5580.0, 5400.0, 5485.0, 5621.0, 5431.0, 5477.0, 5436.0, 5434.0, 5680.0, 5707.0, 5295.0, 5316.0, 5648.0, 5543.0, 5326.0, 5401.0, 5670.0, 5311.0, 5627.0, 5717.0, 5722.0, 5534.0, 5554.0, 5260.0, 5542.0, 5266.0, 5706.0, 5487.0, 5345.0, 5441.0, 5346.0, 5619.0, 5573.0, 5618.0, 5660.0, 5681.0, 5629.0, 5359.0, 5552.0, 5399.0, 5710.0, 5291.0, 5405.0, 5578.0, 5256.0, 5451.0, 5535.0, 5306.0, 5363.0, 5501.0, 5636.0, 5695.0, 5589.0, 5414.0, 5664.0, 5379.0 (number of hits: 6)
21	5280	9	1	333	1	5679.0, 5295.0, 5304.0, 5403.0, 5520.0, 5538.0, 5514.0, 5598.0, 5713.0, 5553.0, 5530.0, 5407.0, 5678.0, 5668.0, 5612.0, 5641.0, 5332.0, 5294.0, 5346.0, 5314.0, 5378.0, 5327.0, 5501.0, 5714.0, 5452.0, 5363.0, 5408.0, 5275.0, 5302.0, 5640.0, 5355.0, 5537.0, 5510.0, 5469.0, 5471.0, 5371.0, 5384.0, 5266.0, 5497.0, 5502.0, 5565.0, 5467.0, 5416.0, 5628.0, 5532.0, 5297.0, 5315.0, 5272.0, 5620.0, 5525.0, 5513.0, 5291.0, 5519.0, 5709.0, 5610.0, 5601.0, 5694.0, 5473.0, 5645.0, 5658.0, 5536.0, 5466.0, 5633.0, 5281.0, 5627.0, 5574.0, 5311.0, 5542.0, 5677.0, 5405.0, 5602.0, 5426.0, 5650.0, 5613.0, 5455.0, 5402.0, 5571.0, 5518.0, 5531.0, 5712.0, 5517.0, 5395.0, 5286.0, 5329.0, 5437.0, 5555.0, 5349.0, 5451.0, 5360.0, 5333.0, 5607.0, 5654.0, 5562.0, 5656.0, 5676.0, 5655.0, 5462.0, 5643.0, 5675.0, 5374.0 (number of hits: 4)
22	5280	9	1	333	1	5655.0, 5631.0, 5509.0, 5265.0, 5442.0, 5488.0, 5635.0, 5481.0, 5393.0, 5639.0, 5697.0, 5516.0, 5341.0, 5487.0, 5666.0, 5285.0, 5678.0, 5450.0, 5521.0, 5282.0, 5717.0, 5711.0, 5645.0, 5499.0, 5292.0, 5301.0, 5668.0, 5599.0, 5456.0, 5309.0, 5275.0, 5709.0, 5304.0, 5694.0, 5362.0, 5302.0, 5659.0, 5256.0, 5557.0, 5477.0, 5303.0, 5634.0, 5409.0, 5338.0, 5611.0, 5254.0, 5644.0, 5585.0, 5656.0, 5427.0, 5647.0, 5274.0, 5383.0, 5339.0, 5463.0, 5483.0, 5710.0, 5648.0, 5573.0, 5432.0, 5561.0, 5340.0, 5560.0, 5684.0, 5601.0, 5451.0, 5252.0, 5720.0, 5598.0, 5323.0, 5613.0, 5255.0, 5673.0, 5359.0, 5623.0, 5475.0, 5646.0, 5266.0, 5380.0, 5554.0, 5295.0, 5589.0, 5512.0, 5313.0, 5445.0, 5503.0, 5271.0, 5548.0, 5480.0, 5565.0, 5658.0, 5519.0, 5547.0, 5467.0, 5386.0, 5568.0, 5385.0, 5544.0, 5570.0, 5498.0 (number of hits: 5)
23	5280	9	1	333	1	5422.0, 5496.0, 5489.0, 5596.0, 5527.0, 5471.0, 5415.0, 5367.0, 5262.0, 5312.0, 5700.0, 5299.0, 5587.0, 5338.0, 5576.0, 5558.0, 5697.0, 5347.0, 5522.0, 5391.0,

						5673.0, 5408.0, 5702.0, 5477.0, 5281.0, 5313.0, 5439.0, 5679.0, 5401.0, 5485.0, 5300.0, 5393.0, 5315.0, 5592.0, 5578.0, 5542.0, 5609.0, 5624.0, 5564.0, 5264.0, 5407.0, 5458.0, 5717.0, 5551.0, 5482.0, 5483.0, 5503.0, 5642.0, 5326.0, 5404.0, 5716.0, 5319.0, 5581.0, 5294.0, 5417.0, 5591.0, 5302.0, 5263.0, 5405.0, 5583.0, 5399.0, 5635.0, 5699.0, 5469.0, 5438.0, 5549.0, 5693.0, 5461.0, 5701.0, 5298.0, 5671.0, 5349.0, 5366.0, 5442.0, 5619.0, 5412.0, 5683.0, 5468.0, 5682.0, 5316.0, 5460.0, 5505.0, 5371.0, 5667.0, 5324.0, 5633.0, 5320.0, 5448.0, 5261.0, 5598.0, 5711.0, 5260.0, 5334.0, 5358.0, 5502.0, 5651.0, 5423.0, 5541.0, 5368.0, 5363.0 (number of hits: 1)
24	5280	9	1	333	1	5682.0, 5398.0, 5355.0, 5292.0, 5591.0, 5356.0, 5498.0, 5281.0, 5454.0, 5600.0, 5299.0, 5310.0, 5587.0, 5557.0, 5618.0, 5347.0, 5376.0, 5460.0, 5432.0, 5508.0, 5273.0, 5332.0, 5370.0, 5672.0, 5634.0, 5291.0, 5335.0, 5353.0, 5532.0, 5488.0, 5536.0, 5595.0, 5724.0, 5424.0, 5528.0, 5262.0, 5601.0, 5311.0, 5703.0, 5569.0, 5597.0, 5540.0, 5294.0, 5513.0, 5686.0, 5384.0, 5441.0, 5629.0, 5646.0, 5257.0, 5481.0, 5514.0, 5613.0, 5582.0, 5400.0, 5449.0, 5684.0, 5580.0, 5526.0, 5406.0, 5252.0, 5722.0, 5521.0, 5625.0, 5324.0, 5368.0, 5445.0, 5345.0, 5479.0, 5652.0, 5524.0, 5586.0, 5687.0, 5627.0, 5695.0, 5408.0, 5715.0, 5265.0, 5438.0, 5719.0, 5560.0, 5579.0, 5653.0, 5431.0, 5552.0, 5259.0, 5457.0, 5386.0, 5484.0, 5371.0, 5679.0, 5442.0, 5387.0, 5494.0, 5277.0, 5660.0, 5709.0, 5410.0, 5619.0, 5288.0 (number of hits: 4)
25	5280	9	1	333	1	5606.0, 5625.0, 5693.0, 5671.0, 5660.0, 5359.0, 5568.0, 5407.0, 5563.0, 5297.0, 5300.0, 5387.0, 5277.0, 5623.0, 5578.0, 5688.0, 5569.0, 5392.0, 5344.0, 5437.0, 5653.0, 5576.0, 5582.0, 5603.0, 5353.0, 5613.0, 5636.0, 5329.0, 5337.0, 5652.0, 5412.0, 5380.0, 5638.0, 5596.0, 5476.0, 5370.0, 5334.0, 5722.0, 5488.0, 5428.0, 5381.0, 5376.0, 5331.0, 5265.0, 5592.0, 5553.0, 5443.0, 5581.0, 5705.0, 5579.0, 5302.0, 5719.0, 5697.0, 5699.0, 5633.0, 5587.0, 5631.0, 5434.0, 5605.0, 5496.0, 5486.0, 5460.0, 5634.0, 5342.0, 5655.0, 5317.0, 5431.0, 5441.0, 5352.0, 5530.0, 5275.0, 5692.0, 5368.0, 5461.0, 5449.0, 5546.0, 5649.0, 5258.0, 5492.0, 5313.0, 5385.0, 5657.0, 5540.0, 5533.0, 5411.0, 5346.0, 5672.0, 5504.0, 5644.0, 5378.0, 5471.0, 5494.0, 5290.0, 5501.0, 5322.0, 5478.0, 5595.0, 5529.0, 5715.0, 5481.0 (number of hits: 2)

26	5280	9	1	333	1	5265.0, 5406.0, 5639.0, 5575.0, 5448.0, 5485.0, 5474.0, 5674.0, 5464.0, 5525.0, 5361.0, 5709.0, 5490.0, 5567.0, 5447.0, 5270.0, 5302.0, 5473.0, 5540.0, 5580.0, 5434.0, 5427.0, 5416.0, 5393.0, 5566.0, 5394.0, 5374.0, 5572.0, 5396.0, 5703.0, 5577.0, 5642.0, 5596.0, 5254.0, 5538.0, 5397.0, 5717.0, 5533.0, 5263.0, 5690.0, 5543.0, 5290.0, 5279.0, 5252.0, 5546.0, 5445.0, 5309.0, 5553.0, 5253.0, 5517.0, 5532.0, 5515.0, 5364.0, 5381.0, 5488.0, 5492.0, 5649.0, 5607.0, 5613.0, 5321.0, 5335.0, 5668.0, 5376.0, 5643.0, 5676.0, 5718.0, 5380.0, 5562.0, 5438.0, 5348.0, 5666.0, 5294.0, 5444.0, 5300.0, 5689.0, 5531.0, 5287.0, 5526.0, 5645.0, 5635.0, 5612.0, 5722.0, 5541.0, 5521.0, 5479.0, 5599.0, 5527.0, 5401.0, 5657.0, 5537.0, 5455.0, 5379.0, 5499.0, 5422.0, 5368.0, 5552.0, 5605.0, 5269.0, 5465.0, 5301.0 (number of hits: 3)
27	5280	9	1	333	1	5315.0, 5638.0, 5718.0, 5392.0, 5712.0, 5561.0, 5447.0, 5310.0, 5420.0, 5486.0, 5320.0, 5465.0, 5710.0, 5407.0, 5326.0, 5526.0, 5376.0, 5323.0, 5378.0, 5435.0, 5468.0, 5485.0, 5418.0, 5610.0, 5273.0, 5306.0, 5332.0, 5271.0, 5587.0, 5570.0, 5484.0, 5715.0, 5644.0, 5469.0, 5654.0, 5556.0, 5341.0, 5312.0, 5400.0, 5428.0, 5464.0, 5514.0, 5562.0, 5560.0, 5289.0, 5701.0, 5665.0, 5651.0, 5387.0, 5581.0, 5575.0, 5308.0, 5588.0, 5519.0, 5416.0, 5272.0, 5275.0, 5339.0, 5396.0, 5502.0, 5700.0, 5599.0, 5629.0, 5690.0, 5375.0, 5504.0, 5702.0, 5516.0, 5442.0, 5479.0, 5348.0, 5564.0, 5399.0, 5261.0, 5294.0, 5675.0, 5696.0, 5414.0, 5448.0, 5439.0, 5676.0, 5401.0, 5333.0, 5336.0, 5318.0, 5558.0, 5548.0, 5511.0, 5361.0, 5299.0, 5344.0, 5397.0, 5441.0, 5542.0, 5460.0, 5303.0, 5330.0, 5365.0, 5571.0, 5513.0 (number of hits: 5)
28	5280	9	1	333	1	5386.0, 5492.0, 5358.0, 5418.0, 5417.0, 5448.0, 5509.0, 5722.0, 5583.0, 5319.0, 5592.0, 5598.0, 5443.0, 5544.0, 5332.0, 5718.0, 5419.0, 5699.0, 5640.0, 5394.0, 5627.0, 5430.0, 5439.0, 5570.0, 5288.0, 5596.0, 5396.0, 5572.0, 5615.0, 5650.0, 5335.0, 5624.0, 5674.0, 5360.0, 5302.0, 5328.0, 5709.0, 5375.0, 5634.0, 5664.0, 5303.0, 5412.0, 5387.0, 5398.0, 5257.0, 5504.0, 5471.0, 5666.0, 5665.0, 5533.0, 5612.0, 5534.0, 5567.0, 5260.0, 5339.0, 5381.0, 5649.0, 5463.0, 5369.0, 5312.0, 5378.0, 5337.0, 5679.0, 5264.0, 5392.0, 5678.0, 5587.0, 5680.0, 5714.0, 5488.0, 5508.0, 5613.0, 5479.0, 5655.0, 5704.0, 5588.0, 5524.0, 5416.0, 5446.0, 5464.0, 5354.0, 5350.0, 5555.0, 5543.0, 5586.0,

						5702.0, 5661.0, 5278.0, 5441.0, 5602.0, 5252.0, 5675.0, 5539.0, 5336.0, 5663.0, 5442.0, 5527.0, 5708.0, 5287.0, 5541.0 (number of hits: 3)
29	5280	9	1	333	1	5346.0, 5352.0, 5445.0, 5341.0, 5407.0, 5685.0, 5541.0, 5371.0, 5311.0, 5320.0, 5622.0, 5587.0, 5268.0, 5647.0, 5605.0, 5611.0, 5342.0, 5380.0, 5361.0, 5474.0, 5470.0, 5650.0, 5704.0, 5553.0, 5711.0, 5683.0, 5389.0, 5350.0, 5509.0, 5434.0, 5507.0, 5255.0, 5643.0, 5354.0, 5419.0, 5634.0, 5451.0, 5456.0, 5376.0, 5481.0, 5420.0, 5276.0, 5718.0, 5613.0, 5493.0, 5291.0, 5382.0, 5604.0, 5396.0, 5438.0, 5322.0, 5439.0, 5307.0, 5653.0, 5490.0, 5466.0, 5693.0, 5325.0, 5288.0, 5498.0, 5513.0, 5572.0, 5403.0, 5444.0, 5408.0, 5560.0, 5596.0, 5616.0, 5378.0, 5273.0, 5422.0, 5607.0, 5290.0, 5646.0, 5684.0, 5406.0, 5286.0, 5600.0, 5296.0, 5335.0, 5581.0, 5347.0, 5537.0, 5614.0, 5536.0, 5665.0, 5700.0, 5660.0, 5426.0, 5440.0, 5253.0, 5717.0, 5277.0, 5423.0, 5583.0, 5499.0, 5676.0, 5496.0, 5260.0, 5532.0 (number of hits: 5)
30	5280	9	1	333	1	5434.0, 5488.0, 5304.0, 5429.0, 5398.0, 5583.0, 5306.0, 5339.0, 5640.0, 5376.0, 5555.0, 5636.0, 5337.0, 5399.0, 5444.0, 5256.0, 5291.0, 5361.0, 5423.0, 5275.0, 5441.0, 5581.0, 5672.0, 5350.0, 5698.0, 5485.0, 5413.0, 5585.0, 5603.0, 5419.0, 5562.0, 5700.0, 5634.0, 5593.0, 5394.0, 5659.0, 5286.0, 5518.0, 5595.0, 5651.0, 5470.0, 5683.0, 5475.0, 5261.0, 5579.0, 5578.0, 5532.0, 5494.0, 5587.0, 5693.0, 5402.0, 5644.0, 5645.0, 5450.0, 5710.0, 5497.0, 5285.0, 5491.0, 5391.0, 5535.0, 5262.0, 5704.0, 5499.0, 5382.0, 5307.0, 5512.0, 5473.0, 5637.0, 5472.0, 5709.0, 5282.0, 5471.0, 5616.0, 5308.0, 5416.0, 5724.0, 5516.0, 5370.0, 5368.0, 5620.0, 5317.0, 5252.0, 5479.0, 5396.0, 5531.0, 5321.0, 5541.0, 5527.0, 5426.0, 5624.0, 5500.0, 5723.0, 5658.0, 5559.0, 5449.0, 5607.0, 5311.0, 5486.0, 5397.0, 5665.0 (number of hits: 4)

5580 MHz, 20 MHz Bandwidth

Radar Signal Type	Waveform/Trial Number	Detection (%)	Limit (%)	Pass/Fail
Type 1A/1B	30	100 %	60%	Pass
Type 2	30	100 %	60%	Pass
Type 3	30	100 %	60%	Pass
Type 4	30	100 %	60%	Pass
Aggregate (Type1 to 4)	120	100 %	80%	Pass
Type 5	30	100 %	80%	Pass
Type 6	30	100 %	70%	Pass

Please refer to the following statistical tables:

Table-1 Radar Type 1A/1B Statistical Performance

Trial #	Fc (MHz)	Pulse/Burst	Pulse Width (μS)	PRI (μs)	Detection (1:yes; 0:no)
1	5580	62	1	858	1
2	5580	86	1	618	1
3	5580	59	1	898	1
4	5580	58	1	918	1
5	5580	68	1	778	1
6	5580	81	1	658	1
7	5580	57	1	938	1
8	5580	70	1	758	1
9	5580	89	1	598	1
10	5580	95	1	558	1
11	5580	67	1	798	1
12	5580	78	1	678	1
13	5580	76	1	698	1
14	5580	83	1	638	1
15	5580	63	1	838	1
16	5580	22	1	2413	1
17	5580	23	1	2331	1
18	5580	50	1	1066	1
19	5580	26	1	2035	1
20	5580	46	1	1171	1
21	5580	31	1	1710	1
22	5580	72	1	743	1
23	5580	23	1	2326	1
24	5580	25	1	2128	1
25	5580	30	1	1812	1
26	5580	32	1	1671	1
27	5580	42	1	1257	1
28	5580	22	1	2441	1
29	5580	22	1	2416	1
30	5580	76	1	695	1
Detection Percentage: 100 % (>60%)					

Table-2 Radar Type 2 Statistical Performance

Trial #	Fc (MHz)	Pulse/Burst	Pulse Width (μS)	PRI (μs)	Detection (1:yes; 0:no)
1	5580	26	1	203	1
2	5580	27	2.8	154	1
3	5580	23	3.8	159	1
4	5580	27	2.5	151	1
5	5580	27	4.4	171	1
6	5580	29	1.8	202	1
7	5580	28	4.1	154	1
8	5580	28	4.3	200	1
9	5580	23	3.6	163	1
10	5580	27	4.6	211	1
11	5580	26	4.5	159	1
12	5580	28	3.8	223	1
13	5580	26	3.2	169	1
14	5580	23	3.3	221	1
15	5580	28	2.3	162	1
16	5580	27	4.4	212	1
17	5580	26	3.7	191	1
18	5580	28	1.4	150	1
19	5580	28	1.3	210	1
20	5580	25	2.8	159	1
21	5580	28	2.5	175	1
22	5580	27	2.2	150	1
23	5580	28	1.9	192	1
24	5580	27	2.9	175	1
25	5580	23	1.9	190	1
26	5580	23	4.5	216	1
27	5580	24	2.5	155	1
28	5580	25	1.5	226	1
29	5580	28	3.8	192	1
30	5580	26	1	168	1
Detection Percentage: 100 % (>60%)					

Table-3 Radar Type 3 Statistical Performance

Trial #	Fc (MHz)	Pulse/Burst	Pulse Width (μS)	PRI (μs)	Detection (1:yes; 0:no)
1	5580	17	9	469	1
2	5580	18	8.4	342	1
3	5580	17	7.1	381	1
4	5580	16	7.8	357	1
5	5580	18	9.4	373	1
6	5580	18	9.6	215	1
7	5580	18	8.5	498	1
8	5580	16	9.7	383	1
9	5580	18	9.9	458	1
10	5580	16	6.1	304	1
11	5580	18	10	391	1
12	5580	18	8.2	460	1
13	5580	17	9.2	487	1
14	5580	17	6.9	246	1
15	5580	18	6.9	492	1
16	5580	16	10	451	1
17	5580	17	7	411	1
18	5580	18	7.4	380	1
19	5580	17	7.5	228	1
20	5580	18	7.7	378	1
21	5580	17	6.1	416	1
22	5580	17	6.1	328	1
23	5580	18	9.1	428	1
24	5580	17	6	412	1
25	5580	16	6.5	387	1
26	5580	17	7.9	440	1
27	5580	17	9.1	374	1
28	5580	17	6.5	454	1
29	5580	16	6.6	335	1
30	5580	17	9.7	306	1
Detection Percentage: 100 % (>60%)					

Table-4 Radar Type 4 Statistical Performance

Trial #	Fc (MHz)	Pulse/Burst	Pulse Width (µS)	PRI (µs)	Detection (1:yes; 0:no)
1	5580	13	17.3	447	1
2	5580	13	12.4	228	1
3	5580	16	12.8	349	1
4	5580	14	15.4	364	1
5	5580	14	15.4	457	1
6	5580	12	16.7	484	1
7	5580	13	14.3	268	1
8	5580	13	13.2	209	1
9	5580	13	15.3	485	1
10	5580	12	16.3	491	1
11	5580	15	15.5	398	1
12	5580	14	11.7	219	1
13	5580	13	13.4	478	1
14	5580	16	13.4	297	1
15	5580	12	16.1	203	1
16	5580	14	11.1	381	1
17	5580	15	13.9	489	1
18	5580	16	11.7	261	1
19	5580	12	12.7	326	1
20	5580	12	18.3	228	1
21	5580	13	14.9	488	1
22	5580	12	17.3	393	1
23	5580	14	12.9	295	1
24	5580	12	19.8	202	1
25	5580	12	11	260	1
26	5580	14	16.5	384	1
27	5580	13	12.3	493	1
28	5580	13	16.1	207	1
29	5580	15	18.9	386	1
30	5580	14	15.3	305	1
Detection Percentage: 100 % (>60%)					

Table-5 Radar Type 5 Statistical Performance

Bin5 Statistics 1

CF=5573MHz

Trial #	Pulse	Chirp (MHz)	Pulse Width (μS)	Pulse 1-2 spacing (uS)	Pulse 2-3 spacing (uS)	Pulse Start(S)	Detection (1:yes; 0:no)
0	3	6	79.9	1651	1185	0.527891	1
1	1	13	80.5			1.21225	
2	2	11	68.9	1754		1.793349	
3	3	17	79.5	1242	1058	2.495955	
4	2	7	93	1354		2.663612	
5	2	9	63.1	1659		3.640071	
6	1	19	55.5			4.315569	
7	1	15	64			4.786924	
8	2	12	72.2	1624		5.211053	
9	3	6	77.8	1121	1198	6.193209	
10	1	5	59.1			6.935419	
11	2	13	64.5	1516		7.194355	
12	2	9	89.1	1812		7.901724	
13	2	12	81.8	1453		8.34278	
14	3	8	65.9	1447	1323	9.422494	
15	1	11	79			9.929338	
16	2	9	71.5	1489		10.323262	
17	2	6	66.9	1307		11.299295	
18	2	14	85.3	1335		11.750911	

Bin5 Statistics 2

CF=5578MHz

Trial #	Pulse	Chirp (MHz)	Pulse Width (μS)	Pulse 1-2 spacing (uS)	Pulse 2-3 spacing (uS)	Pulse Start(S)	Detection (1:yes; 0:no)
0	3	10	84.7	1057	1700	0.071334	1
1	1	17	96.7			1.166817	
2	2	9	77.2	1486		1.755981	
3	1	6	63.7			1.95473	
4	2	9	79.9	1199		3.030776	
5	2	9	57.7	1514		3.434038	
6	1	8	82.5			4.191189	
7	2	7	88	1786		4.724044	
8	2	11	66.2	1944		5.29716	
9	2	11	56.4	1840		5.918655	
10	1	9	57.9			6.381752	
11	1	12	93			7.006284	
12	1	11	97.5			7.664105	
13	1	8	59			8.427334	
14	2	16	59.8	1295		9.058129	
15	1	18	91.1			9.553487	
16	2	12	76.5	1983		10.432391	
17	1	9	82.4			11.222601	
18	1	11	81.9			11.49042	

Bin5 Statistics 3

CF=5574MHz

Trial #	Pulse	Chirp (MHz)	Pulse Width (μS)	Pulse 1-2 spacing (uS)	Pulse 2-3 spacing (uS)	Pulse Start(S)	Detection (1:yes; 0:no)
0	1	11	97.4			0.515036	1
1	3	6	70.4	1019	1504	1.193645	
2	1	14	85.9			1.512364	
3	2	8	52.6	1301		2.248725	
4	2	10	91.7	1287		2.49914	
5	2	16	57.5	1332		3.20195	
6	2	11	51.2	1941		3.655537	
7	1	9	96.5			4.723318	
8	2	12	84.5	1768		5.146245	
9	2	19	72.8	1951		5.550348	
10	2	14	51.6	1899		6.162397	
11	2	15	90.8	1264		7.093937	
12	2	12	62.6	1318		7.665316	
13	2	17	89.6	1031		7.865339	
14	2	14	53.8	1105		8.584309	
15	1	18	67.2			9.408285	
16	3	10	97.7	1340	1823	10.185373	
17	1	16	72.2			10.661501	
18	1	12	80.3			11.185792	
19	3	12	61.9	1065	1510	11.829581	

Bin5 Statistics 4

CF=5584MHz

Trial #	Pulse	Chirp (MHz)	Pulse Width (μS)	Pulse 1-2 spacing (uS)	Pulse 2-3 spacing (uS)	Pulse Start(S)	Detection (1:yes; 0:no)
0	1	8	54.7			0.186402	1
1	2	18	76.6	1997		1.243807	
2	2	7	66.2	1407		2.331871	
3	1	19	87.4			4.209633	
4	2	5	51.5	1954		4.800901	
5	2	9	53.4	1486		5.895227	
6	3	15	98.7	1820	1029	7.19904	
7	1	11	99.9			7.747421	
8	1	12	74			9.293396	
9	3	14	87.1	1292	1093	10.770018	
10	3	15	68.7	1215	1795	11.95605	

Bin5 Statistics 5

CF=5571MHz

Trial #	Pulse	Chirp (MHz)	Pulse Width (μS)	Pulse 1-2 spacing (uS)	Pulse 2-3 spacing (uS)	Pulse Start(S)	Detection (1:yes; 0:no)
0	1	13	91.1			0.05775	1
1	2	14	57.9	1074		1.410215	
2	2	6	82.6	1187		1.62286	
3	2	10	92.3	1350		2.83585	
4	3	18	50.4	1201	1602	3.590523	
5	2	17	64.2	1109		4.676727	
6	2	7	96.4	1067		4.836692	
7	1	7	75.5			5.769575	
8	2	13	88.8	1468		7.00071	
9	2	7	59	1340		7.285902	
10	3	9	62.7	1099	1122	8.327881	
11	2	12	56.2	1797		9.324343	
12	2	9	58.7	1368		9.794126	
13	1	14	92.9			10.520874	
14	3	17	81.8	1884	1216	11.44273	

Bin5 Statistics 6

CF=5585MHz

Trial #	Pulse	Chirp (MHz)	Pulse Width (μS)	Pulse 1-2 spacing (uS)	Pulse 2-3 spacing (uS)	Pulse Start(S)	Detection (1:yes; 0:no)
0	2	13	82.1	1563		0.089248	1
1	1	15	50.6			1.2015	
2	1	8	97.8			1.704648	
3	3	8	96.2	1782	1150	2.625875	
4	1	9	68.6			3.054862	
5	1	18	53			4.128203	
6	1	14	76.2			4.746111	
7	2	13	86.6	1635		5.283528	
8	2	17	86	1447		6.508622	
9	2	19	59.4	1406		7.325555	
10	2	9	68.8	1081		7.819234	
11	2	8	89	1862		8.482234	
12	1	19	74.3			9.47185	
13	2	16	90.6	1987		10.464824	
14	2	10	68.5	1818		10.930866	
15	3	8	51.3	1365	1952	11.505689	

Bin5 Statistics 7

CF=5573MHz

Trial #	Pulse	Chirp (MHz)	Pulse Width (µS)	Pulse 1-2 spacing (µS)	Pulse 2-3 spacing (µS)	Pulse Start(S)	Detection (1:yes; 0:no)
0	2	16	58	1386		0.573722	1
1	2	6	89.6	1460		0.74552	
2	3	17	66.4	1433	1977	1.556648	
3	3	20	72.2	1777	1689	2.340871	
4	3	18	70.3	1881	1792	3.233928	
5	2	19	81.6	1129		3.611301	
6	3	10	56.9	1980	1096	4.061939	
7	1	6	98.5			5.177217	
8	2	13	64.2	1855		5.904845	
9	1	15	88			6.503539	
10	2	11	89.4	1361		6.742224	
11	2	13	54	1370		7.743685	
12	2	19	71.3	1987		8.109254	
13	2	15	92.1	1769		9.277245	
14	2	16	87.2	1338		9.385804	
15	2	11	74.6	1238		10.055911	
16	1	13	77.4			10.9136	
17	1	18	62.7			11.570745	

Bin5 Statistics 8

CF=5583MHz

Trial #	Pulse	Chirp (MHz)	Pulse Width (µS)	Pulse 1-2 spacing (uS)	Pulse 2-3 spacing (uS)	Pulse Start(S)	Detection (1:yes; 0:no)
0	3	14	69.3	1231	1325	0.639519	1
1	2	10	78.1	1339		0.814565	
2	1	9	54.7			2.3606	
3	2	12	59	1120		2.546392	
4	2	10	61.5	1577		3.338832	
5	2	13	71.3	1222		4.281168	
6	1	19	93.7			5.594919	
7	3	13	61.7	1390	1113	5.675448	
8	2	20	73.3	1728		6.972549	
9	2	11	83.5	1110		7.508482	
10	3	9	76.2	1899	1562	8.236758	
11	3	8	94.1	1134	1650	8.93735	
12	2	18	92.9	1523		9.665343	
13	1	5	60.3			10.788891	
14	2	8	99.1	1594		11.892932	

Bin5 Statistics 9

CF=5582MHz

Trial #	Pulse	Chirp (MHz)	Pulse Width (µS)	Pulse 1-2 spacing (uS)	Pulse 2-3 spacing (uS)	Pulse Start(S)	Detection (1:yes; 0:no)
0	3	10	89.8	1095	1295	0.338826	1
1	3	8	78.3	1145	1235	1.747328	
2	2	17	90.3	1335		3.014479	
3	2	11	76.9	1928		4.024322	
4	2	12	83.2	1012		4.95025	
5	2	6	78.6	1889		6.138583	
6	3	16	80.8	1628	1060	7.62094	
7	3	18	98.7	1827	1605	8.303227	
8	2	18	82.5	1537		8.875264	
9	1	10	65.3			10.428699	
10	2	19	99.8	1114		11.651344	

Bin5 Statistics 10

CF=5582MHz

Trial #	Pulse	Chirp (MHz)	Pulse Width (μS)	Pulse 1-2 spacing (uS)	Pulse 2-3 spacing (uS)	Pulse Start(S)	Detection (1:yes; 0:no)
0	3	19	80.4	1521	1455	0.115099	1
1	2	13	71.8	1006		1.694354	
2	3	7	71.7	1684	1103	1.785938	
3	3	19	66.6	1730	1812	3.33509	
4	1	13	94.8			3.546142	
5	3	7	64.4	1039	1339	4.457583	
6	3	14	78.5	1704	1781	5.937521	
7	2	13	83.8	1409		6.650855	
8	2	6	93.6	1822		7.55225	
9	1	13	75.4			8.498136	
10	2	16	83	1778		9.040348	
11	2	13	84.1	1065		10.126226	
12	2	8	67.6	1838		10.575771	
13	1	19	94.4			11.835862	

Bin5 Statistics 11

CF=5571MHz

Trial #	Pulse	Chirp (MHz)	Pulse Width (µS)	Pulse 1-2 spacing (uS)	Pulse 2-3 spacing (uS)	Pulse Start(S)	Detection (1:yes; 0:no)
0	1	11	69.4			0.358566	1
1	3	10	57.1	1082	1954	1.189109	
2	1	10	53.7			1.530068	
3	2	9	77.6	1885		2.043461	
4	1	9	56.4			2.611182	
5	3	11	99.9	1131	1842	3.564643	
6	3	7	99.8	1821	1765	4.246688	
7	2	8	90	1374		4.436617	
8	3	12	73.9	1422	1863	5.538733	
9	3	17	67.1	1356	1267	5.73899	
10	1	5	57.1			6.683152	
11	2	5	62.2	1503		7.300651	
12	3	13	89	1945	1805	8.092758	
13	2	13	82.8	1467		8.409712	
14	2	17	77.8	1904		9.302559	
15	2	9	70.3	1652		9.893883	
16	2	8	66.9	1964		10.228178	
17	3	18	85.4	1094	1331	10.829198	
18	3	11	65	1300	1237	11.787919	

Bin5 Statistics 12

CF=5581MHz

Trial #	Pulse	Chirp (MHz)	Pulse Width (µS)	Pulse 1-2 spacing (uS)	Pulse 2-3 spacing (uS)	Pulse Start(S)	Detection (1:yes; 0:no)
0	2	15	60.4	1181		0.753926	1
1	2	11	70.3	1240		1.787981	
2	2	11	65.9	1972		2.577089	
3	2	18	60.8	1172		4.138187	
4	3	15	74.3	1456	1422	4.72812	
5	1	19	58.3			5.954615	
6	1	9	98.2			7.391538	
7	2	8	54.8	1092		7.991206	
8	3	15	58.6	1516	1834	9.478124	
9	1	18	83.9			10.70112	
10	2	17	52.9	1258		11.082248	

Bin5 Statistics 13

CF=5581MHz

Trial #	Pulse	Chirp (MHz)	Pulse Width (μS)	Pulse 1-2 spacing (uS)	Pulse 2-3 spacing (uS)	Pulse Start(S)	Detection (1:yes; 0:no)
0	2	14	81.5	1210		0.185989	1
1	1	16	92.3			0.985588	
2	1	5	98.5			2.01716	
3	2	7	82.4	1586		2.695778	
4	1	9	79.7			3.404388	
5	1	11	93.4			4.200241	
6	2	8	63.2	1675		4.760285	
7	2	17	64.5	1866		5.030796	
8	2	10	82.8	1583		5.70366	
9	2	7	56	1695		7.035987	
10	3	16	96.2	1980	1861	7.221205	
11	2	9	64.9	1516		8.050403	
12	1	20	94.7			8.483499	
13	3	6	63.9	1770	1100	9.429867	
14	1	8	84.4			9.897755	
15	3	13	98.2	1409	1541	10.883653	
16	1	15	60.3			11.479724	

Bin5 Statistics 14

CF=5572MHz

Trial #	Pulse	Chirp (MHz)	Pulse Width (µS)	Pulse 1-2 spacing (uS)	Pulse 2-3 spacing (uS)	Pulse Start(S)	Detection (1:yes; 0:no)
0	3	12	58	1142	1670	0.109987	1
1	3	13	90.5	1172	1349	0.670954	
2	2	14	99.1	1203		1.470349	
3	2	10	71.9	1686		2.41306	
4	3	20	72.1	1348	1876	2.560865	
5	3	8	58.4	1884	1635	3.239117	
6	2	6	70.9	1446		4.127708	
7	2	7	80.2	1568		5.041148	
8	2	20	52	1999		5.245948	
9	1	18	59			6.247782	
10	2	7	71.9	1880		6.893389	
11	1	18	88.2			7.0149	
12	3	16	96.9	1032	1766	7.993893	
13	1	17	96.1			8.696394	
14	3	7	54	1486	1248	9.083494	
15	3	16	56.4	1304	1698	9.755893	
16	1	9	73.8			10.130179	
17	3	18	55.9	1676	1614	10.772295	
18	1	8	62.7			11.863001	

Bin5 Statistics 15

CF=5575MHz

Trial #	Pulse	Chirp (MHz)	Pulse Width (μS)	Pulse 1-2 spacing (uS)	Pulse 2-3 spacing (uS)	Pulse Start(S)	Detection (1:yes; 0:no)
0	2	6	62.2	1138		0.649532	1
1	2	15	83.7	1165		1.126387	
2	2	6	95.9	1139		2.120316	
3	1	13	84.2			3.005389	
4	2	16	82.5	1556		3.401082	
5	2	11	50.8	1898		4.430344	
6	2	9	67.5	1216		5.110109	
7	2	9	81.7	1129		5.907917	
8	1	6	94.7			6.812491	
9	2	13	63	1279		7.38218	
10	1	13	76.9			8.348991	
11	2	18	72.4	1917		8.886757	
12	2	6	88.3	1296		10.320548	
13	1	9	68.6			11.047397	
14	2	11	52.7	1715		11.393804	

Bin5 Statistics 16

CF=5582MHz

Trial #	Pulse	Chirp (MHz)	Pulse Width (µS)	Pulse 1-2 spacing (uS)	Pulse 2-3 spacing (uS)	Pulse Start(S)	Detection (1:yes; 0:no)
0	2	8	73.3	1108		0.596735	1
1	2	7	67.1	1692		1.01715	
2	2	12	50.4	1606		1.720193	
3	3	11	54.6	1044	1855	2.688229	
4	3	20	95.7	1223	1659	3.21401	
5	2	15	83.6	1289		3.556515	
6	3	13	84.1	1142	1799	4.78258	
7	2	11	53.5	1564		5.334855	
8	1	14	68.3			6.289986	
9	2	8	95.8	1655		6.665103	
10	2	7	85.3	1561		7.304619	
11	2	18	78.3	1351		8.315535	
12	2	7	87.7	1490		8.926986	
13	2	17	68.1	1650		9.684034	
14	2	17	67.2	1976		9.947829	
15	2	16	87.2	1879		11.065159	
16	2	17	62.3	1133		11.581994	

Bin5 Statistics 17

CF=5573MHz

Trial #	Pulse	Chirp (MHz)	Pulse Width (µS)	Pulse 1-2 spacing (uS)	Pulse 2-3 spacing (uS)	Pulse Start(S)	Detection (1:yes; 0:no)
0	2	6	64.4	1408		1.132745	1
1	1	12	83.4			2.624413	
2	2	8	56.2	1212		2.808619	
3	3	13	86.9	1649	1133	4.717214	
4	3	14	73.7	1240	1991	6.623354	
5	2	13	59.9	1806		7.37057	
6	3	17	70.6	1069	1257	9.140812	
7	3	6	97.7	1550	1419	9.70042	
8	2	17	63.7	1129		11.063302	

Bin5 Statistics 18

CF=5581MHz

Trial #	Pulse	Chirp (MHz)	Pulse Width (µS)	Pulse 1-2 spacing (uS)	Pulse 2-3 spacing (uS)	Pulse Start(S)	Detection (1:yes; 0:no)
0	3	13	89.4	1611	1016	0.117694	1
1	2	13	63.6	1515		1.020982	
2	3	10	95.9	1116	1078	2.371408	
3	2	13	52.2	1433		2.605706	
4	2	17	70.5	1633		4.018032	
5	2	10	87.1	1033		4.684318	
6	2	19	61.7	1530		5.213663	
7	2	8	57.8	1513		6.658848	
8	2	10	93.7	1726		7.47321	
9	3	11	97.9	1489	1902	7.838758	
10	2	8	50.9	1006		8.996928	
11	1	19	80.6			10.233316	
12	2	16	88.4	1552		10.946227	
13	2	20	68.3	1782		11.871834	

Bin5 Statistics 19

CF=5585MHz

Trial #	Pulse	Chirp (MHz)	Pulse Width (µS)	Pulse 1-2 spacing (uS)	Pulse 2-3 spacing (uS)	Pulse Start(S)	Detection (1:yes; 0:no)
0	3	11	77.7	1499	1567	0.938398	1
1	2	16	79.6	1905		2.208825	
2	2	11	71	1729		3.384649	
3	2	9	86.9	1631		4.726072	
4	2	14	67.1	1660		5.912773	
5	2	8	75.7	1183		6.989014	
6	3	7	72.5	1231	1580	7.272284	
7	2	14	97	1471		9.139571	
8	2	16	55.1	1798		10.023012	
9	3	20	77.6	1371	1744	11.72236	

Bin5 Statistics 20

CF=5580MHz

Trial #	Pulse	Chirp (MHz)	Pulse Width (µS)	Pulse 1-2 spacing (uS)	Pulse 2-3 spacing (uS)	Pulse Start(S)	Detection (1:yes; 0:no)
0	3	20	89.2	1932	1262	0.977032	1
1	2	5	61.4	1627		1.171632	
2	2	20	90.5	1172		2.828378	
3	2	11	82.5	1764		3.888113	
4	1	18	98.6			4.360099	
5	3	18	57.4	1547	1203	5.627778	
6	2	17	50.1	1421		6.528457	
7	3	7	91.3	1348	1556	7.30319	
8	1	9	86.3			8.252309	
9	2	18	84.4	1363		9.756213	
10	1	19	61.1			10.4994	
11	2	13	84.6	1282		11.120376	

Bin5 Statistics 21

CF=5578MHz

Trial #	Pulse	Chirp (MHz)	Pulse Width (µS)	Pulse 1-2 spacing (uS)	Pulse 2-3 spacing (uS)	Pulse Start(S)	Detection (1:yes; 0:no)
0	1	11	77.2			0.466948	1
1	2	10	77.8	1831		1.764928	
2	3	14	92.8	1874	1757	2.220157	
3	2	20	88.8	1464		3.914292	
4	3	14	92.1	1098	1680	4.482766	
5	2	19	60.9	1442		6.307654	
6	1	18	51.8			6.742592	
7	2	18	51.2	1406		8.312815	
8	2	18	83.5	1672		9.331287	
9	2	14	93.3	1863		10.21304	
10	2	13	73.5	1963		11.070565	

Bin5 Statistics 22

CF=5585MHz

Trial #	Pulse	Chirp (MHz)	Pulse Width (µS)	Pulse 1-2 spacing (uS)	Pulse 2-3 spacing (uS)	Pulse Start(S)	Detection (1:yes; 0:no)
0	2	8	62.9	1949		0.772418	1
1	2	13	90.3	1974		2.626604	
2	1	9	57.2			3.416198	
3	3	9	62.7	1767	1666	4.963141	
4	1	19	86.3			5.953918	
5	2	12	70.7	1056		6.688623	
6	2	11	53	1627		8.367372	
7	2	9	93.3	1319		10.003765	
8	1	11	91.9			11.450308	

Bin5 Statistics 23

CF=5574MHz

Trial #	Pulse	Chirp (MHz)	Pulse Width (µS)	Pulse 1-2 spacing (uS)	Pulse 2-3 spacing (uS)	Pulse Start(S)	Detection (1:yes; 0:no)
0	1	11	56.4			0.151158	1
1	2	14	80.4	1611		0.986551	
2	1	8	93.5			1.654728	
3	3	7	50.8	1931	1784	2.139252	
4	1	8	56			2.751734	
5	1	7	78.5			3.328194	
6	2	16	73.4	1797		4.252307	
7	2	16	86.7	1601		4.893925	
8	1	12	68.5			5.445273	
9	2	16	97.7	1647		6.055939	
10	3	18	80.5	1614	1554	6.467885	
11	1	13	54.5			7.284818	
12	3	8	84.5	1353	1363	7.930777	
13	2	19	64.8	1994		8.33094	
14	2	14	93.3	1359		9.051275	
15	2	18	58.7	1248		9.951513	
16	2	13	78.4	1258		10.302178	
17	3	20	71.6	1899	1768	11.009588	
18	2	6	93.8	1125		11.642796	

Bin5 Statistics 24

CF=5579MHz

Trial #	Pulse	Chirp (MHz)	Pulse Width (µS)	Pulse 1-2 spacing (uS)	Pulse 2-3 spacing (uS)	Pulse Start(S)	Detection (1:yes; 0:no)
0	2	10	65.9	1965		1.150657	1
1	2	10	79.6	1725		2.012484	
2	2	13	73.4	1810		3.109089	
3	2	6	66	1981		4.108555	
4	1	6	82.3			5.966315	
5	2	12	92.2	1440		7.329976	
6	2	20	97.6	1155		8.279016	
7	3	18	66.3	1259	1679	9.912545	
8	2	12	55	1091		10.890486	

Bin5 Statistics 25

CF=5574MHz

Trial #	Pulse	Chirp (MHz)	Pulse Width (µS)	Pulse 1-2 spacing (uS)	Pulse 2-3 spacing (uS)	Pulse Start(S)	Detection (1:yes; 0:no)
0	2	8	59.4	1785		0.490559	1
1	2	19	77.3	1142		2.060259	
2	2	7	50.4	1838		2.338426	
3	2	19	79.7	1820		4.239182	
4	2	14	60.9	1635		5.281525	
5	2	14	62.7	1066		5.743927	
6	3	20	75.8	1615	1113	7.532608	
7	3	20	90.2	1942	1716	8.237699	
8	3	20	82.9	1991	1495	9.13935	
9	2	8	93.7	1039		10.846655	
10	1	18	91.2			11.016736	

Bin5 Statistics 26

CF=5579MHz

Trial #	Pulse	Chirp (MHz)	Pulse Width (µS)	Pulse 1-2 spacing (uS)	Pulse 2-3 spacing (uS)	Pulse Start(S)	Detection (1:yes; 0:no)
0	1	8	68.5			0.677466	1
1	2	11	64.6	1153		1.227852	
2	3	14	86.4	1455	1480	2.05056	
3	2	8	92.3	1057		2.425016	
4	2	6	95.4	1514		3.034248	
5	1	18	81.2			3.713487	
6	2	14	81	1884		4.746834	
7	2	7	94.3	1383		5.225707	
8	3	11	77.7	1062	1926	5.927054	
9	2	8	52.9	1038		6.921331	
10	2	5	57.4	1093		7.472553	
11	3	19	70	1953	1758	7.869514	
12	1	13	57.9			8.724951	
13	1	9	72.3			9.209005	
14	2	16	68.8	1946		10.300143	
15	2	5	55.4	1844		11.196617	
16	2	13	83.2	1298		11.321658	

Bin5 Statistics 27

CF=5586MHz

Trial #	Pulse	Chirp (MHz)	Pulse Width (µS)	Pulse 1-2 spacing (uS)	Pulse 2-3 spacing (uS)	Pulse Start(S)	Detection (1:yes; 0:no)
0	2	17	73.4	1990		0.194101	1
1	2	7	99.7	1977		1.140683	
2	1	10	78.7			1.966978	
3	1	20	86			2.198874	
4	2	9	73.8	1760		3.236859	
5	2	8	69	1752		3.606369	
6	3	18	97.9	1943	1591	4.590179	
7	2	17	94.5	1219		5.42471	
8	2	7	98	1195		5.940186	
9	3	18	81.8	1992	1978	6.958188	
10	3	15	84.7	1403	1145	7.25817	
11	3	9	72.5	1123	1978	8.071538	
12	1	6	98.1			8.971061	
13	2	11	53.5	1144		9.236443	
14	1	12	68.1			10.443678	
15	2	8	74.7	1302		11.176035	
16	1	15	93.8			11.969297	

Bin5 Statistics 28

CF=5571MHz

Trial #	Pulse	Chirp (MHz)	Pulse Width (µS)	Pulse 1-2 spacing (uS)	Pulse 2-3 spacing (uS)	Pulse Start(S)	Detection (1:yes; 0:no)
0	3	12	56.7	1797	1289	0.064004	1
1	1	8	79.3			1.337775	
2	3	18	75.6	1828	1430	1.784387	
3	3	17	71	1510	1590	2.555773	
4	2	6	84.4	1201		3.456994	
5	2	6	57.4	1096		3.97597	
6	2	6	58.3	1246		4.865367	
7	2	15	75.9	1590		5.303507	
8	1	15	73			5.929016	
9	2	11	66.4	1851		6.858923	
10	2	7	92.5	1002		7.573343	
11	1	11	98.6			8.411065	
12	1	6	97.6			8.861545	
13	2	17	81.4	1457		9.572011	
14	2	10	67.4	1801		10.011227	
15	2	18	57.4	1829		11.108436	
16	3	10	59.2	1461	1286	11.387281	

Bin5 Statistics 29

CF=5584MHz

Trial #	Pulse	Chirp (MHz)	Pulse Width (µS)	Pulse 1-2 spacing (uS)	Pulse 2-3 spacing (uS)	Pulse Start(S)	Detection (1:yes; 0:no)
0	3	7	93.8	1110	1189	0.044392	1
1	1	5	89.5			1.894954	
2	1	10	60.3			2.518463	
3	2	7	89.6	1195		3.569282	
4	1	19	61.4			4.983267	
5	1	16	89.8			5.019594	
6	2	15	84.6	1494		6.18165	
7	3	7	85.4	1544	1523	7.760536	
8	2	8	98.5	1407		8.861115	
9	1	17	75.8			9.02683	
10	1	19	58.6			10.008447	
11	2	17	50.2	1976		11.63712	

Bin5 Statistics 30

CF=5571MHz

Trial #	Pulse	Chirp (MHz)	Pulse Width (μS)	Pulse 1-2 spacing (uS)	Pulse 2-3 spacing (uS)	Pulse Start(S)	Detection (1:yes; 0:no)
0	2	7	93.6	1812		0.148992	1
1	1	8	73.1			1.643877	
2	3	18	52.7	1532	1072	2.232787	
3	1	6	58.5			3.655775	
4	2	8	76.6	1528		4.299564	
5	2	17	67.2	1615		5.838748	
6	1	11	99.8			6.023005	
7	2	17	98.8	1039		7.587713	
8	1	20	85			8.143703	
9	3	14	98.9	1071	1983	9.023733	
10	2	7	68.9	1777		10.832893	
11	1	9	55.3			11.064049	

Table-6 Radar Type 6 Statistical Performance

Trial #	Fc (MHz)	Pulse /Burst	Pulse Width (µS)	PRI (µs)	Detection (1:yes; 0:no)	Hopping Sequence
1	5580	9	1	333	1	5581.0, 5469.0, 5374.0, 5431.0, 5466.0, 5261.0, 5453.0, 5381.0, 5334.0, 5573.0, 5302.0, 5569.0, 5504.0, 5558.0, 5534.0, 5459.0, 5474.0, 5548.0, 5346.0, 5289.0, 5563.0, 5630.0, 5286.0, 5672.0, 5580.0, 5716.0, 5422.0, 5267.0, 5281.0, 5658.0, 5410.0, 5586.0, 5484.0, 5307.0, 5528.0, 5321.0, 5707.0, 5711.0, 5700.0, 5517.0, 5602.0, 5696.0, 5373.0, 5295.0, 5694.0, 5616.0, 5430.0, 5445.0, 5285.0, 5615.0, 5675.0, 5336.0, 5502.0, 5710.0, 5367.0, 5634.0, 5473.0, 5604.0, 5657.0, 5564.0, 5623.0, 5536.0, 5432.0, 5543.0, 5595.0, 5479.0, 5665.0, 5259.0, 5691.0, 5306.0, 5668.0, 5525.0, 5714.0, 5308.0, 5462.0, 5454.0, 5547.0, 5438.0, 5636.0, 5488.0, 5254.0, 5551.0, 5644.0, 5303.0, 5293.0, 5274.0, 5449.0, 5496.0, 5429.0, 5481.0, 5291.0, 5369.0, 5384.0, 5598.0, 5546.0, 5389.0, 5649.0, 5545.0, 5436.0, 5358.0 (number of hits: 4)
2	5580	9	1	333	1	5717.0, 5444.0, 5645.0, 5437.0, 5255.0, 5389.0, 5622.0, 5250.0, 5639.0, 5399.0, 5517.0, 5324.0, 5346.0, 5527.0, 5378.0, 5257.0, 5515.0, 5383.0, 5664.0, 5696.0, 5289.0, 5549.0, 5589.0, 5600.0, 5468.0, 5266.0, 5699.0, 5668.0, 5418.0, 5427.0, 5277.0, 5413.0, 5463.0, 5580.0, 5630.0, 5671.0, 5292.0, 5574.0, 5660.0, 5373.0, 5432.0, 5594.0, 5283.0, 5372.0, 5350.0, 5643.0, 5458.0, 5328.0, 5364.0, 5305.0, 5704.0, 5521.0, 5625.0, 5366.0, 5592.0, 5316.0, 5261.0, 5252.0, 5490.0, 5685.0, 5462.0, 5533.0, 5721.0, 5540.0, 5480.0, 5295.0, 5420.0, 5258.0, 5306.0, 5280.0, 5267.0, 5276.0, 5313.0, 5345.0, 5488.0, 5607.0, 5576.0, 5665.0, 5434.0, 5311.0, 5542.0, 5268.0, 5317.0, 5544.0, 5474.0, 5553.0, 5335.0, 5652.0, 5716.0, 5724.0, 5459.0, 5471.0, 5377.0, 5543.0, 5719.0, 5669.0, 5269.0, 5661.0, 5466.0, 5496.0 (number of hits: 4)
3	5580	9	1	333	1	5420.0, 5644.0, 5414.0, 5707.0, 5545.0, 5281.0, 5254.0, 5549.0, 5318.0, 5267.0, 5364.0, 5271.0, 5671.0, 5622.0, 5448.0, 5361.0, 5470.0, 5398.0, 5632.0, 5302.0, 5544.0, 5382.0, 5670.0, 5664.0, 5411.0, 5555.0, 5546.0, 5612.0, 5516.0, 5504.0, 5408.0, 5328.0, 5533.0, 5610.0, 5342.0, 5315.0, 5569.0, 5331.0, 5409.0, 5462.0, 5339.0, 5358.0, 5378.0, 5635.0, 5710.0, 5465.0, 5521.0, 5280.0, 5565.0, 5412.0, 5489.0, 5349.0, 5529.0, 5386.0, 5642.0

						5316.0, 5505.0, 5359.0, 5559.0, 5686.0, 5385.0, 5485.0, 5534.0, 5520.0, 5587.0, 5323.0, 5447.0, 5619.0, 5276.0, 5498.0, 5440.0, 5372.0, 5679.0, 5648.0, 5292.0, 5682.0, 5335.0, 5399.0, 5614.0, 5363.0, 5638.0, 5476.0, 5596.0, 5337.0, 5603.0, 5460.0, 5441.0, 5543.0, 5471.0, 5500.0, 5330.0, 5366.0, 5525.0, 5567.0, 5715.0, 5347.0, 5551.0, 5706.0, 5321.0, 5345.0 (number of hits: 1)
4	5580	9	1	333	1	5614.0, 5566.0, 5309.0, 5535.0, 5548.0, 5434.0, 5359.0, 5410.0, 5710.0, 5368.0, 5260.0, 5367.0, 5443.0, 5495.0, 5530.0, 5651.0, 5676.0, 5298.0, 5385.0, 5382.0, 5310.0, 5484.0, 5523.0, 5609.0, 5687.0, 5373.0, 5518.0, 5538.0, 5522.0, 5289.0, 5295.0, 5695.0, 5355.0, 5288.0, 5485.0, 5554.0, 5537.0, 5292.0, 5360.0, 5481.0, 5577.0, 5479.0, 5580.0, 5470.0, 5673.0, 5372.0, 5348.0, 5383.0, 5516.0, 5492.0, 5643.0, 5491.0, 5319.0, 5324.0, 5323.0, 5432.0, 5420.0, 5403.0, 5717.0, 5425.0, 5545.0, 5275.0, 5672.0, 5648.0, 5478.0, 5317.0, 5312.0, 5637.0, 5338.0, 5541.0, 5679.0, 5406.0, 5561.0, 5389.0, 5393.0, 5430.0, 5532.0, 5457.0, 5413.0, 5375.0, 5575.0, 5475.0, 5681.0, 5536.0, 5308.0, 5677.0, 5380.0, 5579.0, 5468.0, 5307.0, 5396.0, 5488.0, 5571.0, 5511.0, 5693.0, 5390.0, 5366.0, 5639.0, 5706.0, 5405.0 (number of hits: 5)
5	5580	9	1	333	1	5420.0, 5356.0, 5693.0, 5720.0, 5333.0, 5431.0, 5283.0, 5313.0, 5685.0, 5577.0, 5499.0, 5435.0, 5506.0, 5643.0, 5564.0, 5650.0, 5389.0, 5323.0, 5450.0, 5528.0, 5714.0, 5590.0, 5257.0, 5478.0, 5623.0, 5640.0, 5681.0, 5322.0, 5291.0, 5686.0, 5596.0, 5635.0, 5609.0, 5474.0, 5699.0, 5296.0, 5706.0, 5401.0, 5532.0, 5520.0, 5631.0, 5672.0, 5695.0, 5639.0, 5480.0, 5439.0, 5561.0, 5306.0, 5468.0, 5423.0, 5511.0, 5519.0, 5398.0, 5482.0, 5391.0, 5280.0, 5301.0, 5307.0, 5683.0, 5600.0, 5620.0, 5626.0, 5556.0, 5348.0, 5514.0, 5496.0, 5304.0, 5380.0, 5383.0, 5345.0, 5404.0, 5530.0, 5444.0, 5483.0, 5694.0, 5563.0, 5579.0, 5690.0, 5572.0, 5399.0, 5292.0, 5326.0, 5329.0, 5254.0, 5305.0, 5555.0, 5256.0, 5642.0, 5619.0, 5328.0, 5523.0, 5594.0, 5359.0, 5288.0, 5353.0, 5469.0, 5456.0, 5505.0, 5387.0, 5708.0 (number of hits: 3)
6	5580	9	1	333	1	5340.0, 5453.0, 5324.0, 5364.0, 5515.0, 5629.0, 5608.0, 5292.0, 5426.0, 5376.0, 5672.0, 5582.0, 5394.0, 5391.0, 5346.0, 5485.0, 5396.0, 5436.0, 5510.0, 5451.0, 5586.0, 5549.0, 5465.0, 5645.0, 5651.0, 5563.0, 5467.0, 5656.0, 5591.0, 5719.0, 5518.0, 5272.0, 5420.0, 5350.0, 5472.0,

						5329.0, 5280.0, 5259.0, 5274.0, 5265.0, 5341.0, 5668.0, 5382.0, 5294.0, 5455.0, 5587.0, 5393.0, 5395.0, 5562.0, 5525.0, 5308.0, 5299.0, 5679.0, 5284.0, 5488.0, 5362.0, 5469.0, 5268.0, 5417.0, 5538.0, 5696.0, 5686.0, 5282.0, 5418.0, 5430.0, 5289.0, 5529.0, 5636.0, 5705.0, 5309.0, 5511.0, 5493.0, 5251.0, 5655.0, 5628.0, 5624.0, 5422.0, 5520.0, 5258.0, 5647.0, 5452.0, 5291.0, 5347.0, 5498.0, 5669.0, 5690.0, 5619.0, 5609.0, 5508.0, 5380.0, 5676.0, 5323.0, 5363.0, 5254.0, 5448.0, 5499.0, 5723.0, 5344.0, 5484.0, 5667.0 (number of hits: 3)
7	5580	9	1	333	1	5668.0, 5655.0, 5527.0, 5295.0, 5647.0, 5413.0, 5568.0, 5544.0, 5313.0, 5323.0, 5617.0, 5329.0, 5433.0, 5499.0, 5360.0, 5649.0, 5354.0, 5723.0, 5275.0, 5352.0, 5255.0, 5400.0, 5269.0, 5372.0, 5702.0, 5555.0, 5603.0, 5626.0, 5457.0, 5316.0, 5578.0, 5451.0, 5432.0, 5594.0, 5378.0, 5650.0, 5521.0, 5458.0, 5574.0, 5469.0, 5510.0, 5676.0, 5642.0, 5695.0, 5570.0, 5418.0, 5659.0, 5252.0, 5607.0, 5482.0, 5321.0, 5504.0, 5348.0, 5687.0, 5259.0, 5296.0, 5562.0, 5297.0, 5613.0, 5489.0, 5681.0, 5722.0, 5620.0, 5556.0, 5410.0, 5443.0, 5285.0, 5502.0, 5420.0, 5490.0, 5340.0, 5496.0, 5387.0, 5713.0, 5610.0, 5384.0, 5592.0, 5717.0, 5428.0, 5455.0, 5596.0, 5484.0, 5324.0, 5376.0, 5550.0, 5359.0, 5618.0, 5665.0, 5505.0, 5358.0, 5459.0, 5601.0, 5652.0, 5710.0, 5684.0, 5439.0, 5262.0, 5494.0, 5581.0, 5520.0 (number of hits: 4)
8	5580	9	1	333	1	5508.0, 5531.0, 5272.0, 5530.0, 5500.0, 5522.0, 5667.0, 5612.0, 5623.0, 5517.0, 5552.0, 5583.0, 5509.0, 5658.0, 5533.0, 5632.0, 5718.0, 5280.0, 5549.0, 5669.0, 5685.0, 5677.0, 5475.0, 5597.0, 5543.0, 5674.0, 5379.0, 5410.0, 5654.0, 5391.0, 5297.0, 5691.0, 5659.0, 5281.0, 5474.0, 5446.0, 5666.0, 5414.0, 5295.0, 5631.0, 5588.0, 5622.0, 5536.0, 5638.0, 5347.0, 5545.0, 5332.0, 5354.0, 5311.0, 5680.0, 5381.0, 5617.0, 5616.0, 5518.0, 5520.0, 5324.0, 5515.0, 5578.0, 5425.0, 5403.0, 5519.0, 5296.0, 5585.0, 5590.0, 5265.0, 5610.0, 5580.0, 5570.0, 5683.0, 5695.0, 5625.0, 5498.0, 5609.0, 5562.0, 5477.0, 5331.0, 5383.0, 5250.0, 5353.0, 5553.0, 5507.0, 5334.0, 5510.0, 5316.0, 5370.0, 5650.0, 5478.0, 5360.0, 5511.0, 5723.0, 5606.0, 5355.0, 5431.0, 5694.0, 5720.0, 5413.0, 5322.0, 5582.0, 5542.0, 5473.0 (number of hits: 7)
9	5580	9	1	333	1	5572.0, 5279.0, 5530.0, 5446.0, 5399.0, 5373.0, 5342.0, 5641.0, 5459.0, 5298.0, 5636.0, 5493.0, 5439.0, 5571.0, 5600.0,

						5587.0, 5378.0, 5542.0, 5648.0, 5627.0, 5619.0, 5408.0, 5550.0, 5388.0, 5393.0, 5565.0, 5512.0, 5624.0, 5617.0, 5460.0, 5621.0, 5524.0, 5501.0, 5326.0, 5555.0, 5444.0, 5695.0, 5640.0, 5266.0, 5397.0, 5271.0, 5481.0, 5401.0, 5638.0, 5352.0, 5488.0, 5284.0, 5472.0, 5382.0, 5295.0, 5609.0, 5606.0, 5716.0, 5536.0, 5297.0, 5656.0, 5396.0, 5573.0, 5337.0, 5451.0, 5289.0, 5532.0, 5351.0, 5318.0, 5511.0, 5553.0, 5348.0, 5394.0, 5670.0, 5586.0, 5527.0, 5311.0, 5503.0, 5592.0, 5361.0, 5514.0, 5577.0, 5611.0, 5251.0, 5478.0, 5334.0, 5635.0, 5666.0, 5306.0, 5405.0, 5593.0, 5338.0, 5541.0, 5676.0, 5675.0, 5584.0, 5669.0, 5454.0, 5719.0, 5523.0, 5479.0, 5549.0, 5707.0, 5521.0, 5605.0 (number of hits: 7)
10	5580	9	1	333	1	5393.0, 5539.0, 5656.0, 5413.0, 5260.0, 5476.0, 5412.0, 5324.0, 5591.0, 5464.0, 5293.0, 5518.0, 5505.0, 5377.0, 5290.0, 5551.0, 5675.0, 5574.0, 5535.0, 5258.0, 5312.0, 5358.0, 5637.0, 5399.0, 5338.0, 5543.0, 5432.0, 5317.0, 5264.0, 5691.0, 5570.0, 5668.0, 5560.0, 5411.0, 5478.0, 5660.0, 5620.0, 5503.0, 5494.0, 5365.0, 5647.0, 5559.0, 5322.0, 5569.0, 5389.0, 5302.0, 5701.0, 5482.0, 5395.0, 5275.0, 5576.0, 5345.0, 5436.0, 5315.0, 5427.0, 5295.0, 5700.0, 5547.0, 5367.0, 5404.0, 5285.0, 5298.0, 5673.0, 5378.0, 5394.0, 5429.0, 5553.0, 5707.0, 5687.0, 5654.0, 5607.0, 5679.0, 5470.0, 5676.0, 5373.0, 5623.0, 5272.0, 5528.0, 5308.0, 5421.0, 5327.0, 5286.0, 5488.0, 5397.0, 5522.0, 5332.0, 5635.0, 5598.0, 5469.0, 5329.0, 5348.0, 5634.0, 5496.0, 5529.0, 5454.0, 5621.0, 5356.0, 5447.0, 5350.0, 5368.0 (number of hits: 3)
11	5580	9	1	333	1	5511.0, 5426.0, 5492.0, 5461.0, 5307.0, 5250.0, 5357.0, 5358.0, 5462.0, 5367.0, 5300.0, 5602.0, 5299.0, 5491.0, 5289.0, 5449.0, 5338.0, 5559.0, 5537.0, 5356.0, 5459.0, 5609.0, 5535.0, 5637.0, 5266.0, 5298.0, 5685.0, 5614.0, 5306.0, 5498.0, 5341.0, 5599.0, 5479.0, 5361.0, 5663.0, 5661.0, 5540.0, 5582.0, 5617.0, 5455.0, 5398.0, 5677.0, 5693.0, 5407.0, 5390.0, 5321.0, 5646.0, 5634.0, 5653.0, 5347.0, 5422.0, 5613.0, 5539.0, 5451.0, 5463.0, 5419.0, 5505.0, 5369.0, 5411.0, 5596.0, 5696.0, 5571.0, 5372.0, 5331.0, 5478.0, 5452.0, 5578.0, 5263.0, 5656.0, 5381.0, 5651.0, 5489.0, 5330.0, 5297.0, 5373.0, 5522.0, 5536.0, 5718.0, 5620.0, 5261.0, 5409.0, 5639.0, 5404.0, 5547.0, 5359.0, 5527.0, 5464.0, 5399.0, 5555.0, 5441.0, 5335.0, 5305.0, 5509.0, 5630.0, 5633.0, 5601.0, 5378.0, 5624.0, 5598.0, 5532.0

						(number of hits: 3)
12	5580	9	1	333	1	5525.0, 5361.0, 5315.0, 5632.0, 5310.0, 5508.0, 5626.0, 5444.0, 5305.0, 5704.0, 5670.0, 5296.0, 5550.0, 5294.0, 5476.0, 5461.0, 5574.0, 5307.0, 5681.0, 5527.0, 5331.0, 5280.0, 5548.0, 5463.0, 5533.0, 5700.0, 5409.0, 5317.0, 5545.0, 5329.0, 5351.0, 5321.0, 5360.0, 5447.0, 5256.0, 5251.0, 5441.0, 5612.0, 5648.0, 5486.0, 5534.0, 5680.0, 5523.0, 5478.0, 5343.0, 5615.0, 5649.0, 5450.0, 5438.0, 5309.0, 5326.0, 5607.0, 5347.0, 5260.0, 5702.0, 5629.0, 5692.0, 5684.0, 5402.0, 5506.0, 5371.0, 5539.0, 5719.0, 5372.0, 5456.0, 5344.0, 5458.0, 5393.0, 5602.0, 5301.0, 5559.0, 5383.0, 5637.0, 5422.0, 5437.0, 5269.0, 5600.0, 5566.0, 5382.0, 5313.0, 5298.0, 5530.0, 5268.0, 5262.0, 5300.0, 5639.0, 5370.0, 5439.0, 5595.0, 5457.0, 5657.0, 5581.0, 5515.0, 5389.0, 5597.0, 5273.0, 5400.0, 5553.0, 5404.0, 5630.0
						(number of hits: 2)
13	5580	9	1	333	1	5331.0, 5672.0, 5697.0, 5405.0, 5595.0, 5646.0, 5357.0, 5665.0, 5626.0, 5361.0, 5449.0, 5706.0, 5278.0, 5330.0, 5656.0, 5612.0, 5280.0, 5400.0, 5563.0, 5332.0, 5291.0, 5552.0, 5474.0, 5376.0, 5329.0, 5528.0, 5308.0, 5558.0, 5723.0, 5491.0, 5366.0, 5282.0, 5305.0, 5425.0, 5254.0, 5409.0, 5322.0, 5306.0, 5599.0, 5651.0, 5346.0, 5292.0, 5598.0, 5335.0, 5295.0, 5383.0, 5431.0, 5466.0, 5492.0, 5572.0, 5527.0, 5610.0, 5701.0, 5540.0, 5703.0, 5341.0, 5281.0, 5387.0, 5468.0, 5462.0, 5717.0, 5505.0, 5410.0, 5354.0, 5355.0, 5496.0, 5334.0, 5676.0, 5667.0, 5679.0, 5506.0, 5525.0, 5674.0, 5607.0, 5267.0, 5318.0, 5257.0, 5363.0, 5666.0, 5298.0, 5394.0, 5399.0, 5259.0, 5707.0, 5301.0, 5590.0, 5653.0, 5531.0, 5351.0, 5702.0, 5413.0, 5632.0, 5314.0, 5547.0, 5714.0, 5279.0, 5309.0, 5293.0, 5422.0, 5286.0
						(number of hits: 1)
14	5580	9	1	333	1	5549.0, 5514.0, 5630.0, 5340.0, 5254.0, 5523.0, 5345.0, 5580.0, 5430.0, 5617.0, 5378.0, 5638.0, 5541.0, 5531.0, 5274.0, 5328.0, 5259.0, 5389.0, 5544.0, 5510.0, 5357.0, 5505.0, 5696.0, 5365.0, 5420.0, 5263.0, 5543.0, 5307.0, 5625.0, 5404.0, 5287.0, 5251.0, 5679.0, 5555.0, 5409.0, 5296.0, 5456.0, 5689.0, 5407.0, 5662.0, 5250.0, 5336.0, 5301.0, 5305.0, 5476.0, 5537.0, 5598.0, 5269.0, 5495.0, 5294.0, 5324.0, 5694.0, 5677.0, 5623.0, 5276.0, 5685.0, 5562.0, 5318.0, 5501.0, 5384.0, 5423.0, 5699.0, 5432.0, 5486.0, 5635.0, 5602.0, 5688.0, 5468.0, 5586.0, 5474.0, 5355.0, 5701.0, 5304.0, 5720.0, 5660.0, 5299.0, 5654.0, 5682.0, 5716.0, 5657.0,

						5504.0, 5672.0, 5359.0, 5611.0, 5609.0, 5644.0, 5533.0, 5444.0, 5286.0, 5563.0, 5322.0, 5560.0, 5527.0, 5450.0, 5640.0, 5380.0, 5371.0, 5588.0, 5678.0, 5268.0 (number of hits: 3)
15	5580	9	1	333	1	5686.0, 5618.0, 5663.0, 5382.0, 5714.0, 5371.0, 5648.0, 5665.0, 5310.0, 5664.0, 5565.0, 5550.0, 5396.0, 5257.0, 5318.0, 5394.0, 5587.0, 5535.0, 5404.0, 5645.0, 5413.0, 5344.0, 5703.0, 5642.0, 5400.0, 5673.0, 5507.0, 5508.0, 5659.0, 5360.0, 5338.0, 5352.0, 5472.0, 5437.0, 5655.0, 5512.0, 5374.0, 5431.0, 5567.0, 5316.0, 5601.0, 5487.0, 5345.0, 5585.0, 5284.0, 5293.0, 5695.0, 5701.0, 5720.0, 5322.0, 5552.0, 5442.0, 5536.0, 5432.0, 5274.0, 5253.0, 5630.0, 5634.0, 5604.0, 5447.0, 5287.0, 5260.0, 5393.0, 5631.0, 5658.0, 5303.0, 5633.0, 5424.0, 5521.0, 5456.0, 5339.0, 5301.0, 5596.0, 5692.0, 5498.0, 5358.0, 5651.0, 5513.0, 5600.0, 5492.0, 5598.0, 5304.0, 5343.0, 5454.0, 5426.0, 5713.0, 5624.0, 5362.0, 5480.0, 5493.0, 5251.0, 5370.0, 5557.0, 5576.0, 5578.0, 5544.0, 5317.0, 5307.0, 5518.0, 5268.0 (number of hits: 4)
16	5580	9	1	333	1	5491.0, 5631.0, 5373.0, 5468.0, 5545.0, 5618.0, 5505.0, 5548.0, 5306.0, 5309.0, 5398.0, 5403.0, 5320.0, 5562.0, 5673.0, 5561.0, 5424.0, 5395.0, 5596.0, 5600.0, 5442.0, 5302.0, 5383.0, 5360.0, 5486.0, 5682.0, 5684.0, 5269.0, 5653.0, 5599.0, 5493.0, 5322.0, 5565.0, 5488.0, 5550.0, 5402.0, 5589.0, 5554.0, 5584.0, 5530.0, 5662.0, 5706.0, 5679.0, 5635.0, 5497.0, 5453.0, 5376.0, 5372.0, 5678.0, 5534.0, 5639.0, 5420.0, 5310.0, 5637.0, 5410.0, 5710.0, 5377.0, 5655.0, 5683.0, 5490.0, 5436.0, 5546.0, 5348.0, 5428.0, 5290.0, 5522.0, 5466.0, 5654.0, 5384.0, 5271.0, 5610.0, 5629.0, 5256.0, 5718.0, 5289.0, 5492.0, 5339.0, 5612.0, 5264.0, 5714.0, 5496.0, 5364.0, 5435.0, 5261.0, 5343.0, 5399.0, 5342.0, 5516.0, 5721.0, 5313.0, 5393.0, 5312.0, 5500.0, 5250.0, 5574.0, 5441.0, 5712.0, 5509.0, 5630.0, 5551.0 (number of hits: 3)
17	5580	9	1	333	1	5612.0, 5262.0, 5426.0, 5519.0, 5301.0, 5462.0, 5501.0, 5379.0, 5713.0, 5256.0, 5605.0, 5517.0, 5299.0, 5425.0, 5518.0, 5500.0, 5333.0, 5323.0, 5480.0, 5694.0, 5414.0, 5320.0, 5508.0, 5598.0, 5721.0, 5681.0, 5490.0, 5280.0, 5417.0, 5643.0, 5396.0, 5602.0, 5572.0, 5369.0, 5534.0, 5421.0, 5495.0, 5449.0, 5631.0, 5476.0, 5315.0, 5695.0, 5492.0, 5424.0, 5685.0, 5441.0, 5272.0, 5689.0, 5532.0, 5621.0, 5680.0, 5297.0, 5440.0, 5268.0, 5541.0, 5690.0, 5304.0, 5463.0, 5628.0, 5710.0,

						5288.0, 5520.0, 5482.0, 5410.0, 5698.0, 5642.0, 5525.0, 5340.0, 5398.0, 5472.0, 5584.0, 5334.0, 5279.0, 5377.0, 5434.0, 5352.0, 5599.0, 5412.0, 5470.0, 5450.0, 5560.0, 5445.0, 5635.0, 5683.0, 5419.0, 5374.0, 5624.0, 5342.0, 5376.0, 5544.0, 5582.0, 5700.0, 5273.0, 5614.0, 5295.0, 5257.0, 5684.0, 5625.0, 5523.0, 5290.0 (number of hits: 3)
18	5580	9	1	333	1	5587.0, 5654.0, 5268.0, 5612.0, 5390.0, 5494.0, 5284.0, 5632.0, 5684.0, 5397.0, 5401.0, 5620.0, 5673.0, 5325.0, 5266.0, 5652.0, 5393.0, 5554.0, 5253.0, 5371.0, 5433.0, 5442.0, 5443.0, 5598.0, 5663.0, 5279.0, 5345.0, 5380.0, 5560.0, 5574.0, 5252.0, 5538.0, 5430.0, 5415.0, 5657.0, 5547.0, 5564.0, 5342.0, 5622.0, 5476.0, 5424.0, 5576.0, 5296.0, 5510.0, 5546.0, 5590.0, 5660.0, 5328.0, 5565.0, 5351.0, 5309.0, 5275.0, 5462.0, 5367.0, 5508.0, 5354.0, 5278.0, 5338.0, 5563.0, 5718.0, 5690.0, 5653.0, 5349.0, 5550.0, 5499.0, 5655.0, 5648.0, 5461.0, 5712.0, 5315.0, 5525.0, 5694.0, 5519.0, 5675.0, 5323.0, 5300.0, 5395.0, 5661.0, 5575.0, 5514.0, 5352.0, 5569.0, 5265.0, 5324.0, 5344.0, 5330.0, 5366.0, 5561.0, 5313.0, 5406.0, 5687.0, 5700.0, 5466.0, 5503.0, 5456.0, 5436.0, 5492.0, 5595.0, 5267.0, 5428.0 (number of hits: 4)
19	5580	9	1	333	1	5449.0, 5512.0, 5365.0, 5428.0, 5570.0, 5463.0, 5715.0, 5546.0, 5699.0, 5510.0, 5460.0, 5539.0, 5295.0, 5718.0, 5607.0, 5704.0, 5414.0, 5652.0, 5333.0, 5582.0, 5253.0, 5712.0, 5364.0, 5487.0, 5540.0, 5266.0, 5599.0, 5710.0, 5700.0, 5576.0, 5723.0, 5268.0, 5296.0, 5706.0, 5645.0, 5627.0, 5348.0, 5590.0, 5367.0, 5413.0, 5366.0, 5257.0, 5528.0, 5292.0, 5447.0, 5629.0, 5267.0, 5385.0, 5571.0, 5270.0, 5341.0, 5301.0, 5325.0, 5375.0, 5258.0, 5637.0, 5331.0, 5644.0, 5256.0, 5302.0, 5611.0, 5382.0, 5585.0, 5497.0, 5634.0, 5569.0, 5564.0, 5444.0, 5656.0, 5594.0, 5621.0, 5523.0, 5705.0, 5580.0, 5549.0, 5683.0, 5318.0, 5496.0, 5563.0, 5678.0, 5416.0, 5427.0, 5299.0, 5319.0, 5461.0, 5474.0, 5518.0, 5421.0, 5491.0, 5529.0, 5493.0, 5309.0, 5522.0, 5322.0, 5675.0, 5638.0, 5547.0, 5280.0, 5720.0, 5568.0 (number of hits: 6)
20	5580	9	1	333	1	5313.0, 5598.0, 5432.0, 5562.0, 5591.0, 5688.0, 5568.0, 5346.0, 5670.0, 5355.0, 5550.0, 5483.0, 5504.0, 5257.0, 5620.0, 5547.0, 5318.0, 5271.0, 5578.0, 5512.0, 5682.0, 5514.0, 5488.0, 5487.0, 5641.0, 5386.0, 5705.0, 5537.0, 5392.0, 5697.0, 5336.0, 5660.0, 5717.0, 5613.0, 5307.0, 5273.0, 5356.0, 5679.0, 5541.0, 5289.0

						5379.0, 5369.0, 5580.0, 5454.0, 5522.0, 5391.0, 5669.0, 5685.0, 5497.0, 5305.0, 5383.0, 5402.0, 5650.0, 5381.0, 5385.0, 5268.0, 5689.0, 5530.0, 5292.0, 5457.0, 5319.0, 5709.0, 5695.0, 5535.0, 5515.0, 5625.0, 5325.0, 5676.0, 5447.0, 5335.0, 5301.0, 5663.0, 5544.0, 5516.0, 5474.0, 5372.0, 5274.0, 5496.0, 5672.0, 5382.0, 5337.0, 5371.0, 5441.0, 5536.0, 5349.0, 5299.0, 5470.0, 5587.0, 5506.0, 5352.0, 5584.0, 5482.0, 5706.0, 5278.0, 5715.0, 5546.0, 5347.0, 5523.0, 5481.0, 5302.0 (number of hits: 4)
21	5580	9	1	333	1	5444.0, 5277.0, 5660.0, 5327.0, 5590.0, 5488.0, 5272.0, 5476.0, 5520.0, 5529.0, 5462.0, 5672.0, 5273.0, 5409.0, 5253.0, 5254.0, 5722.0, 5411.0, 5707.0, 5326.0, 5516.0, 5442.0, 5565.0, 5348.0, 5666.0, 5367.0, 5586.0, 5643.0, 5645.0, 5661.0, 5284.0, 5678.0, 5381.0, 5415.0, 5477.0, 5394.0, 5259.0, 5624.0, 5585.0, 5440.0, 5713.0, 5450.0, 5301.0, 5618.0, 5637.0, 5401.0, 5383.0, 5353.0, 5252.0, 5474.0, 5510.0, 5432.0, 5355.0, 5589.0, 5342.0, 5436.0, 5553.0, 5721.0, 5438.0, 5563.0, 5632.0, 5396.0, 5583.0, 5292.0, 5692.0, 5699.0, 5269.0, 5453.0, 5447.0, 5382.0, 5420.0, 5251.0, 5343.0, 5714.0, 5369.0, 5634.0, 5431.0, 5500.0, 5468.0, 5386.0, 5612.0, 5566.0, 5317.0, 5492.0, 5596.0, 5545.0, 5685.0, 5614.0, 5295.0, 5324.0, 5534.0, 5403.0, 5299.0, 5616.0, 5644.0, 5555.0, 5584.0, 5625.0, 5419.0, 5579.0 (number of hits: 6)
22	5580	9	1	333	1	5464.0, 5459.0, 5577.0, 5385.0, 5531.0, 5376.0, 5720.0, 5272.0, 5670.0, 5635.0, 5522.0, 5596.0, 5496.0, 5687.0, 5700.0, 5623.0, 5390.0, 5578.0, 5291.0, 5511.0, 5555.0, 5519.0, 5426.0, 5476.0, 5588.0, 5460.0, 5488.0, 5633.0, 5397.0, 5640.0, 5362.0, 5442.0, 5468.0, 5708.0, 5652.0, 5432.0, 5317.0, 5319.0, 5260.0, 5518.0, 5690.0, 5366.0, 5424.0, 5341.0, 5485.0, 5569.0, 5699.0, 5645.0, 5419.0, 5311.0, 5481.0, 5685.0, 5322.0, 5417.0, 5620.0, 5433.0, 5713.0, 5512.0, 5675.0, 5265.0, 5572.0, 5354.0, 5658.0, 5364.0, 5313.0, 5494.0, 5653.0, 5318.0, 5252.0, 5719.0, 5288.0, 5386.0, 5332.0, 5271.0, 5473.0, 5630.0, 5723.0, 5505.0, 5681.0, 5474.0, 5394.0, 5674.0, 5257.0, 5273.0, 5650.0, 5402.0, 5592.0, 5326.0, 5358.0, 5458.0, 5395.0, 5526.0, 5637.0, 5701.0, 5293.0, 5406.0, 5634.0, 5603.0, 5477.0, 5264.0 (number of hits: 4)
23	5580	9	1	333	1	5718.0, 5396.0, 5662.0, 5381.0, 5549.0, 5366.0, 5638.0, 5311.0, 5322.0, 5338.0, 5414.0, 5293.0, 5415.0, 5672.0, 5312.0, 5346.0, 5645.0, 5617.0, 5434.0, 5656.0,

						5615.0, 5441.0, 5321.0, 5527.0, 5526.0, 5709.0, 5298.0, 5592.0, 5596.0, 5305.0, 5510.0, 5257.0, 5501.0, 5410.0, 5608.0, 5563.0, 5570.0, 5326.0, 5492.0, 5590.0, 5358.0, 5670.0, 5485.0, 5557.0, 5250.0, 5671.0, 5337.0, 5555.0, 5284.0, 5682.0, 5418.0, 5473.0, 5641.0, 5377.0, 5327.0, 5532.0, 5266.0, 5605.0, 5614.0, 5513.0, 5694.0, 5448.0, 5465.0, 5368.0, 5533.0, 5474.0, 5469.0, 5720.0, 5272.0, 5602.0, 5629.0, 5456.0, 5495.0, 5716.0, 5580.0, 5458.0, 5442.0, 5594.0, 5708.0, 5675.0, 5435.0, 5384.0, 5620.0, 5577.0, 5644.0, 5606.0, 5508.0, 5571.0, 5450.0, 5599.0, 5290.0, 5313.0, 5433.0, 5288.0, 5536.0, 5263.0, 5697.0, 5447.0, 5623.0, 5306.0 (number of hits: 4)
24	5580	9	1	333	1	5647.0, 5675.0, 5325.0, 5501.0, 5370.0, 5516.0, 5536.0, 5523.0, 5557.0, 5659.0, 5477.0, 5574.0, 5292.0, 5567.0, 5467.0, 5508.0, 5389.0, 5495.0, 5420.0, 5447.0, 5713.0, 5460.0, 5345.0, 5514.0, 5487.0, 5352.0, 5272.0, 5473.0, 5264.0, 5400.0, 5458.0, 5539.0, 5337.0, 5432.0, 5341.0, 5468.0, 5717.0, 5716.0, 5442.0, 5274.0, 5423.0, 5470.0, 5301.0, 5591.0, 5466.0, 5300.0, 5464.0, 5279.0, 5677.0, 5524.0, 5689.0, 5637.0, 5684.0, 5645.0, 5357.0, 5724.0, 5533.0, 5336.0, 5392.0, 5482.0, 5657.0, 5376.0, 5568.0, 5687.0, 5381.0, 5484.0, 5273.0, 5396.0, 5356.0, 5711.0, 5609.0, 5276.0, 5606.0, 5321.0, 5335.0, 5453.0, 5312.0, 5316.0, 5347.0, 5315.0, 5509.0, 5296.0, 5363.0, 5483.0, 5696.0, 5431.0, 5540.0, 5648.0, 5413.0, 5407.0, 5600.0, 5563.0, 5324.0, 5669.0, 5401.0, 5258.0, 5358.0, 5402.0, 5562.0, 5654.0 (number of hits: 1)
25	5580	9	1	333	1	5645.0, 5314.0, 5635.0, 5506.0, 5657.0, 5325.0, 5455.0, 5258.0, 5419.0, 5324.0, 5615.0, 5509.0, 5504.0, 5439.0, 5662.0, 5531.0, 5407.0, 5342.0, 5713.0, 5318.0, 5551.0, 5536.0, 5665.0, 5489.0, 5515.0, 5520.0, 5563.0, 5306.0, 5609.0, 5331.0, 5273.0, 5383.0, 5402.0, 5351.0, 5676.0, 5335.0, 5694.0, 5530.0, 5699.0, 5431.0, 5544.0, 5364.0, 5376.0, 5490.0, 5626.0, 5457.0, 5708.0, 5275.0, 5328.0, 5272.0, 5717.0, 5498.0, 5466.0, 5300.0, 5566.0, 5313.0, 5260.0, 5487.0, 5374.0, 5264.0, 5570.0, 5405.0, 5582.0, 5337.0, 5371.0, 5410.0, 5720.0, 5540.0, 5603.0, 5415.0, 5505.0, 5501.0, 5294.0, 5723.0, 5416.0, 5685.0, 5350.0, 5521.0, 5259.0, 5655.0, 5707.0, 5421.0, 5571.0, 5270.0, 5309.0, 5516.0, 5569.0, 5456.0, 5647.0, 5424.0, 5449.0, 5672.0, 5577.0, 5266.0, 5472.0, 5279.0, 5656.0, 5408.0, 5479.0, 5712.0 (number of hits: 4)

26	5580	9	1	333	1	<p>5343.0, 5424.0, 5591.0, 5672.0, 5716.0, 5605.0, 5357.0, 5599.0, 5718.0, 5336.0, 5421.0, 5490.0, 5309.0, 5310.0, 5535.0, 5719.0, 5289.0, 5394.0, 5276.0, 5432.0, 5575.0, 5520.0, 5691.0, 5317.0, 5573.0, 5497.0, 5467.0, 5254.0, 5582.0, 5547.0, 5379.0, 5409.0, 5556.0, 5431.0, 5681.0, 5596.0, 5401.0, 5551.0, 5319.0, 5562.0, 5473.0, 5650.0, 5365.0, 5449.0, 5279.0, 5262.0, 5500.0, 5363.0, 5390.0, 5456.0, 5388.0, 5427.0, 5608.0, 5349.0, 5480.0, 5507.0, 5377.0, 5542.0, 5376.0, 5511.0, 5278.0, 5324.0, 5444.0, 5610.0, 5526.0, 5699.0, 5277.0, 5470.0, 5510.0, 5318.0, 5397.0, 5380.0, 5453.0, 5559.0, 5274.0, 5270.0, 5496.0, 5624.0, 5369.0, 5398.0, 5505.0, 5447.0, 5440.0, 5673.0, 5578.0, 5378.0, 5641.0, 5400.0, 5293.0, 5325.0, 5273.0, 5588.0, 5469.0, 5341.0, 5407.0, 5359.0, 5375.0, 5271.0, 5366.0, 5414.0 (number of hits: 5)</p>
27	5580	9	1	333	1	<p>5260.0, 5723.0, 5332.0, 5576.0, 5511.0, 5456.0, 5345.0, 5549.0, 5667.0, 5675.0, 5550.0, 5436.0, 5676.0, 5256.0, 5615.0, 5381.0, 5698.0, 5418.0, 5581.0, 5383.0, 5323.0, 5495.0, 5433.0, 5416.0, 5499.0, 5435.0, 5358.0, 5404.0, 5695.0, 5413.0, 5314.0, 5270.0, 5432.0, 5254.0, 5632.0, 5428.0, 5666.0, 5351.0, 5353.0, 5548.0, 5664.0, 5369.0, 5684.0, 5601.0, 5707.0, 5510.0, 5255.0, 5392.0, 5498.0, 5544.0, 5514.0, 5424.0, 5677.0, 5367.0, 5386.0, 5253.0, 5365.0, 5626.0, 5609.0, 5719.0, 5494.0, 5543.0, 5309.0, 5356.0, 5641.0, 5406.0, 5330.0, 5540.0, 5596.0, 5636.0, 5447.0, 5491.0, 5450.0, 5608.0, 5427.0, 5628.0, 5370.0, 5530.0, 5559.0, 5277.0, 5380.0, 5577.0, 5442.0, 5269.0, 5496.0, 5691.0, 5518.0, 5571.0, 5541.0, 5374.0, 5605.0, 5469.0, 5366.0, 5280.0, 5656.0, 5455.0, 5272.0, 5266.0, 5551.0, 5678.0 (number of hits: 4)</p>
28	5580	9	1	333	1	<p>5709.0, 5556.0, 5259.0, 5606.0, 5405.0, 5596.0, 5298.0, 5361.0, 5308.0, 5419.0, 5318.0, 5326.0, 5515.0, 5408.0, 5659.0, 5692.0, 5648.0, 5456.0, 5683.0, 5522.0, 5582.0, 5576.0, 5407.0, 5639.0, 5542.0, 5616.0, 5504.0, 5327.0, 5674.0, 5468.0, 5382.0, 5354.0, 5533.0, 5537.0, 5336.0, 5601.0, 5667.0, 5403.0, 5554.0, 5366.0, 5322.0, 5492.0, 5676.0, 5443.0, 5486.0, 5267.0, 5292.0, 5305.0, 5645.0, 5317.0, 5460.0, 5457.0, 5474.0, 5350.0, 5640.0, 5482.0, 5463.0, 5626.0, 5527.0, 5311.0, 5699.0, 5383.0, 5586.0, 5304.0, 5643.0, 5687.0, 5406.0, 5399.0, 5380.0, 5723.0, 5431.0, 5391.0, 5634.0, 5427.0, 5284.0, 5367.0, 5593.0, 5452.0, 5445.0, 5632.0, 5475.0, 5339.0, 5685.0, 5426.0, 5619.0</p>

						5447.0, 5544.0, 5569.0, 5580.0, 5430.0, 5434.0, 5610.0, 5688.0, 5473.0, 5512.0, 5428.0, 5677.0, 5625.0, 5566.0, 5530.0 (number of hits: 4)
29	5580	9	1	333	1	5303.0, 5412.0, 5355.0, 5500.0, 5455.0, 5454.0, 5716.0, 5384.0, 5305.0, 5691.0, 5294.0, 5684.0, 5542.0, 5327.0, 5520.0, 5637.0, 5693.0, 5590.0, 5451.0, 5679.0, 5347.0, 5501.0, 5558.0, 5666.0, 5364.0, 5278.0, 5722.0, 5440.0, 5295.0, 5575.0, 5321.0, 5535.0, 5714.0, 5413.0, 5453.0, 5397.0, 5264.0, 5642.0, 5701.0, 5581.0, 5579.0, 5540.0, 5297.0, 5263.0, 5399.0, 5427.0, 5450.0, 5477.0, 5507.0, 5480.0, 5298.0, 5417.0, 5600.0, 5408.0, 5464.0, 5605.0, 5369.0, 5690.0, 5349.0, 5415.0, 5422.0, 5475.0, 5699.0, 5340.0, 5339.0, 5511.0, 5481.0, 5320.0, 5683.0, 5720.0, 5598.0, 5312.0, 5442.0, 5643.0, 5681.0, 5567.0, 5711.0, 5577.0, 5628.0, 5547.0, 5289.0, 5675.0, 5578.0, 5640.0, 5513.0, 5478.0, 5288.0, 5306.0, 5325.0, 5671.0, 5719.0, 5560.0, 5367.0, 5317.0, 5437.0, 5252.0, 5448.0, 5489.0, 5313.0, 5488.0 (number of hits: 5)
30	5580	9	1	333	1	5276.0, 5561.0, 5617.0, 5373.0, 5701.0, 5455.0, 5304.0, 5342.0, 5454.0, 5693.0, 5635.0, 5405.0, 5528.0, 5442.0, 5565.0, 5281.0, 5347.0, 5327.0, 5452.0, 5514.0, 5349.0, 5664.0, 5332.0, 5325.0, 5461.0, 5717.0, 5329.0, 5624.0, 5682.0, 5578.0, 5679.0, 5524.0, 5412.0, 5317.0, 5394.0, 5255.0, 5711.0, 5541.0, 5368.0, 5391.0, 5290.0, 5668.0, 5285.0, 5520.0, 5529.0, 5680.0, 5686.0, 5465.0, 5402.0, 5511.0, 5569.0, 5498.0, 5300.0, 5584.0, 5345.0, 5260.0, 5367.0, 5318.0, 5599.0, 5562.0, 5632.0, 5656.0, 5422.0, 5265.0, 5311.0, 5710.0, 5446.0, 5418.0, 5718.0, 5559.0, 5652.0, 5294.0, 5404.0, 5692.0, 5288.0, 5398.0, 5526.0, 5685.0, 5535.0, 5564.0, 5314.0, 5619.0, 5497.0, 5612.0, 5521.0, 5573.0, 5346.0, 5517.0, 5417.0, 5669.0, 5286.0, 5474.0, 5724.0, 5448.0, 5580.0, 5277.0, 5257.0, 5648.0, 5674.0, 5321.0 (number of hits: 4)

5270 MHz, 40 MHz Bandwidth

Radar Signal Type	Waveform/Trial Number	Detection (%)	Limit (%)	Pass/Fail
Type 1A/1B	30	100 %	60%	Pass
Type 2	30	100 %	60%	Pass
Type 3	30	100 %	60%	Pass
Type 4	30	100 %	60%	Pass
Aggregate (Type1 to 4)	120	100 %	80%	Pass
Type 5	30	100 %	80%	Pass
Type 6	30	100 %	70%	Pass

Please refer to the following statistical tables:

Table-1 Radar Type 1A/1B Statistical Performance

Trial #	Fc (MHz)	Pulse/Burst	Pulse Width (μS)	PRI (μs)	Detection (1:yes; 0:no)
1	5270	78	1	678	1
2	5270	59	1	898	1
3	5270	63	1	838	1
4	5270	92	1	578	1
5	5270	68	1	778	1
6	5270	86	1	618	1
7	5270	74	1	718	1
8	5270	57	1	938	1
9	5270	81	1	658	1
10	5270	61	1	878	1
11	5270	99	1	538	1
12	5270	76	1	698	1
13	5270	67	1	798	1
14	5270	65	1	818	1
15	5270	83	1	638	1
16	5270	22	1	2461	1
17	5270	20	1	2644	1
18	5270	22	1	2503	1
19	5270	20	1	2704	1
20	5270	98	1	544	1
21	5270	25	1	2128	1
22	5270	27	1	1971	1
23	5270	21	1	2532	1
24	5270	84	1	630	1
25	5270	27	1	1959	1
26	5270	29	1	1836	1
27	5270	22	1	2444	1
28	5270	41	1	1295	1
29	5270	18	1	2934	1
30	5270	63	1	839	1
Detection Percentage: 100 % (>60%)					

Table-2 Radar Type 2 Statistical Performance

Trial #	Fc (MHz)	Pulse/Burst	Pulse Width (μS)	PRI (μs)	Detection (1:yes; 0:no)
1	5270	29	2.7	194	1
2	5270	23	2.1	187	1
3	5270	27	1.4	180	1
4	5270	23	2.3	158	1
5	5270	23	4	228	1
6	5270	29	3.4	217	1
7	5270	24	1.4	162	1
8	5270	27	4.3	163	1
9	5270	27	2	224	1
10	5270	25	3.2	184	1
11	5270	25	1.2	162	1
12	5270	27	4.3	222	1
13	5270	27	2.2	229	1
14	5270	26	1.1	223	1
15	5270	29	3	218	1
16	5270	27	4.1	166	1
17	5270	26	3.3	186	1
18	5270	28	4.9	229	1
19	5270	23	2.8	206	1
20	5270	24	4.7	155	1
21	5270	28	3.2	207	1
22	5270	23	3.7	202	1
23	5270	24	1.9	180	1
24	5270	27	2.4	195	1
25	5270	27	3.8	174	1
26	5270	24	1.7	179	1
27	5270	23	3.3	180	1
28	5270	28	3.1	206	1
29	5270	25	2.6	189	1
30	5270	27	3.2	160	1
Detection Percentage: 100 % (>60%)					

Table-3 Radar Type 3 Statistical Performance

Trial #	Fc (MHz)	Pulse/Burst	Pulse Width (μS)	PRI (μs)	Detection (1:yes; 0:no)
1	5270	18	7.3	437	1
2	5270	16	6.6	491	1
3	5270	18	6.4	402	1
4	5270	16	9.1	284	1
5	5270	16	7.7	455	1
6	5270	16	9.9	419	1
7	5270	16	8.6	250	1
8	5270	17	10	500	1
9	5270	16	7.7	392	1
10	5270	17	9.4	495	1
11	5270	18	6.5	456	1
12	5270	17	9.1	417	1
13	5270	16	6.3	480	1
14	5270	18	8.4	343	1
15	5270	18	9.9	318	1
16	5270	17	7.3	470	1
17	5270	16	7.2	394	1
18	5270	17	6	372	1
19	5270	16	10	425	1
20	5270	18	7.3	455	1
21	5270	16	8.1	360	1
22	5270	16	6.8	329	1
23	5270	18	9.2	216	1
24	5270	17	7.4	399	1
25	5270	16	6.9	473	1
26	5270	16	9.4	312	1
27	5270	17	7.8	452	1
28	5270	17	8.6	260	1
29	5270	16	8.2	397	1
30	5270	17	7.5	374	1
Detection Percentage: 100 % (>60%)					

Table-4 Radar Type 4 Statistical Performance

Trial #	Fc (MHz)	Pulse/Burst	Pulse Width (μS)	PRI (μs)	Detection (1:yes; 0:no)
1	5270	16	12.3	433	1
2	5270	12	12.2	278	1
3	5270	15	11.2	242	1
4	5270	13	13.3	245	1
5	5270	16	14.9	358	1
6	5270	14	12.1	428	1
7	5270	15	18	469	1
8	5270	13	17.8	451	1
9	5270	14	17.4	463	1
10	5270	13	15.8	227	1
11	5270	14	17.6	499	1
12	5270	16	15.7	214	1
13	5270	13	15.5	262	1
14	5270	13	13.4	277	1
15	5270	13	16.8	209	1
16	5270	13	18.3	207	1
17	5270	16	11.5	272	1
18	5270	15	14.6	283	1
19	5270	14	18.3	317	1
20	5270	13	12	253	1
21	5270	13	17	316	1
22	5270	12	15.1	260	1
23	5270	14	15.4	246	1
24	5270	15	11.4	382	1
25	5270	13	13.6	318	1
26	5270	13	16.8	216	1
27	5270	14	11.3	401	1
28	5270	13	11.3	487	1
29	5270	16	16.5	479	1
30	5270	16	16.4	334	1
Detection Percentage: 100 % (>60%)					

Table-5 Radar Type 5 Statistical Performance

Bin5 Statistics 1

CF=5252MHz

Trial #	Pulse	Chirp (MHz)	Pulse Width (µS)	Pulse 1-2 spacing (uS)	Pulse 2-3 spacing (uS)	Pulse Start(S)	Detection (1:yes; 0:no)
0	2	9	72.1	1698		0.136792	1
1	1	7	98.5			2.231126	
2	1	11	97.3			3.819917	
3	1	10	75.5			5.01388	
4	3	6	92.4	1896	1518	5.514342	
5	3	15	67.9	1420	1557	6.790741	
6	3	17	57.7	1721	1620	9.302128	
7	1	10	55.4			9.534253	
8	2	18	59.1	1862		11.5075	

Bin5 Statistics 2

CF=5252MHz

Trial #	Pulse	Chirp (MHz)	Pulse Width (µS)	Pulse 1-2 spacing (uS)	Pulse 2-3 spacing (uS)	Pulse Start(S)	Detection (1:yes; 0:no)
0	1	14	64.8			0.413218	1
1	3	14	77.2	1531	1687	1.161803	
2	2	19	97.3	1713		1.907809	
3	1	17	59.9			2.26638	
4	1	9	54.8			2.779327	
5	2	18	68.6	1260		3.663998	
6	2	17	91.4	1984		4.054932	
7	2	8	72.4	1287		4.788594	
8	2	19	70.7	1459		5.616858	
9	3	5	97.6	1771	1167	6.467194	
10	1	9	94.2			7.053842	
11	2	11	76.9	1772		7.40184	
12	3	14	72.5	1020	1691	8.2653	
13	3	19	77.3	1743	1220	9.076311	
14	2	16	53.7	1658		9.871518	
15	3	6	68.3	1196	1806	10.411878	
16	2	16	69.7	1022		11.077538	
17	2	7	73.7	1877		11.984047	

Bin5 Statistics 3

CF=5282MHz

Trial #	Pulse	Chirp (MHz)	Pulse Width (µS)	Pulse 1-2 spacing (µS)	Pulse 2-3 spacing (µS)	Pulse Start(S)	Detection (1:yes; 0:no)
0	3	6	85.4	1780	1323	0.2783	1
1	2	15	85.5	1715		0.788591	
2	2	12	61.5	1919		1.876973	
3	2	12	66.6	1623		2.328937	
4	1	17	55.9			2.891464	
5	1	19	57.5			3.339053	
6	2	12	60	1308		3.870889	
7	2	11	89.9	1192		4.442961	
8	3	18	54.1	1447	1599	5.388802	
9	2	14	53.8	1198		6.263083	
10	2	17	75.1	1737		6.611493	
11	2	15	69.3	1014		7.092403	
12	3	6	66.8	1597	1673	7.924216	
13	1	7	50.1			8.48962	
14	2	16	88.9	1631		9.103795	
15	1	14	74.1			9.848136	
16	3	8	75.4	1120	1282	10.429327	
17	1	15	79.4			11.23054	
18	2	18	62.5	1808		11.639703	

Bin5 Statistics 4

CF=5252MHz

Trial #	Pulse	Chirp (MHz)	Pulse Width (μS)	Pulse 1-2 spacing (uS)	Pulse 2-3 spacing (uS)	Pulse Start(S)	Detection (1:yes; 0:no)
0	3	10	68.6	1778	1904	0.558624	1
1	2	19	94.7	1902		0.797049	
2	2	12	63.4	1511		1.298533	
3	3	14	53.8	1253	1643	1.940772	
4	2	9	71.8	1846		2.941447	
5	3	11	75.8	1993	1710	3.611012	
6	2	12	72.7	1849		4.23037	
7	3	11	96.7	1070	1255	4.890253	
8	3	15	60.9	1546	1314	5.456112	
9	1	10	88.7			6.221993	
10	2	18	76.7	1966		6.859275	
11	2	6	82.9	1523		7.509739	
12	2	16	66	1743		7.8571	
13	3	16	52.7	1332	1669	8.71849	
14	1	18	70.5			9.218029	
15	2	5	97.5	1226		9.545511	
16	2	13	52.9	1946		10.172205	
17	2	16	95.8	1439		11.081561	
18	2	5	77.5	1788		11.555337	

Bin5 Statistics 5

CF=5259MHz

Trial #	Pulse	Chirp (MHz)	Pulse Width (µS)	Pulse 1-2 spacing (uS)	Pulse 2-3 spacing (uS)	Pulse Start(S)	Detection (1:yes; 0:no)
0	3	10	82.5	1390	1668	0.70005	1
1	2	19	60.2	1558		1.171395	
2	3	11	90.8	1131	1332	1.918836	
3	1	6	67.3			2.789841	
4	1	18	83			3.480892	
5	2	5	67.1	1824		4.294175	
6	2	7	86.1	1229		5.376512	
7	2	10	79.7	1489		5.982733	
8	3	9	83.6	1274	1029	6.883795	
9	3	8	65.2	1956	1612	7.245089	
10	1	19	66.9			8.068397	
11	1	11	85.7			9.496716	
12	3	11	87.1	1179	1015	10.158474	
13	2	8	69.7	1475		11.014295	
14	2	10	88.6	1759		11.306504	

Bin5 Statistics 6

CF=5272MHz

Trial #	Pulse	Chirp (MHz)	Pulse Width (µS)	Pulse 1-2 spacing (µS)	Pulse 2-3 spacing (µS)	Pulse Start(S)	Detection (1:yes; 0:no)
0	1	16	63.5			0.706701	1
1	2	13	84.6	1469		0.931185	
2	2	14	72.8	1253		1.513074	
3	3	12	89.4	1036	1079	2.828895	
4	3	20	59.9	1450	1304	3.209318	
5	2	11	72.5	1897		3.807279	
6	2	8	54.1	1704		5.129467	
7	3	20	61.3	1025	1643	5.589476	
8	1	14	57.7			6.213335	
9	3	19	73.7	1300	1088	7.259532	
10	2	12	86.4	1245		7.956571	
11	3	6	66	1743	1679	8.724408	
12	3	16	70.2	1471	1456	9.73346	
13	2	15	70.6	1070		9.944819	
14	3	14	66.7	1018	1250	11.11625	
15	2	16	99	1601		11.809905	

Bin5 Statistics 7

CF=5259MHz

Trial #	Pulse	Chirp (MHz)	Pulse Width (µS)	Pulse 1-2 spacing (µS)	Pulse 2-3 spacing (µS)	Pulse Start(S)	Detection (1:yes; 0:no)
0	2	14	95.1	1117		0.384961	1
1	2	16	78.8	1790		0.905409	
2	3	11	81.6	1295	1701	1.863297	
3	2	16	66.9	1239		2.980028	
4	1	12	50.1			3.817334	
5	3	11	93.8	1344	1523	4.704693	
6	2	13	76.1	1490		4.841615	
7	1	17	89.4			6.225768	
8	3	6	97	1604	1180	6.767806	
9	1	16	83.6			7.868205	
10	1	9	87.3			8.758637	
11	2	12	87.7	1543		9.450912	
12	1	12	99.4			9.79937	
13	2	8	83.8	1044		11.023497	
14	1	16	68.3			11.95563	

Bin5 Statistics 8

CF=5268MHz

Trial #	Pulse	Chirp (MHz)	Pulse Width (µS)	Pulse 1-2 spacing (uS)	Pulse 2-3 spacing (uS)	Pulse Start(S)	Detection (1:yes; 0:no)
0	2	16	58.5	1409		0.084869	1
1	3	10	89.2	1326	1521	0.872642	
2	2	14	61.3	1642		1.417843	
3	2	19	64.9	1074		2.158066	
4	3	16	68.1	1497	1062	3.421647	
5	2	20	93.3	1782		3.701849	
6	2	17	67.4	1081		4.559193	
7	3	18	75.1	1836	1124	5.349517	
8	2	8	81.5	1886		6.331692	
9	3	12	64.3	1256	1703	6.355106	
10	3	19	55.8	1523	1254	7.699744	
11	1	10	98.6			8.01	
12	2	10	54.9	1504		9.116707	
13	2	13	65.4	1480		9.731819	
14	2	8	62	1596		10.086021	
15	1	8	94.2			11.073538	
16	2	13	52.3	1596		11.936104	

Bin5 Statistics 9

CF=5265MHz

Trial #	Pulse	Chirp (MHz)	Pulse Width (µS)	Pulse 1-2 spacing (uS)	Pulse 2-3 spacing (uS)	Pulse Start(S)	Detection (1:yes; 0:no)
0	2	17	62.5	1990		0.163457	1
1	1	17	60.2			0.801666	
2	2	7	78.8	1586		2.383057	
3	2	12	73.9	1800		2.714807	
4	2	8	70.1	1728		3.37386	
5	2	15	99.1	1444		4.098575	
6	2	18	86	1962		5.235797	
7	1	6	51.8			5.705128	
8	2	14	54.5	1829		6.78642	
9	2	17	63.6	1720		7.207753	
10	2	14	54.5	1689		8.210433	
11	3	8	50.1	1877	1070	9.516411	
12	2	6	56	1709		9.74471	
13	3	16	82.8	1936	1014	11.072627	
14	2	18	87.4	1600		11.510938	

Bin5 Statistics 10

CF=5263MHz

Trial #	Pulse	Chirp (MHz)	Pulse Width (µS)	Pulse 1-2 spacing (uS)	Pulse 2-3 spacing (uS)	Pulse Start(S)	Detection (1:yes; 0:no)
0	2	19	89.5	1964		0.170722	1
1	2	6	50.9	1752		1.171556	
2	1	13	67			1.890755	
3	2	19	56.2	1530		2.450865	
4	2	15	95.6	1012		3.003853	
5	3	14	77.3	1809	1303	3.592267	
6	1	10	69.6			4.236117	
7	2	17	76	1372		5.490467	
8	1	18	97.4			6.337817	
9	2	18	98.5	1176		6.476965	
10	2	15	77.6	1191		7.701923	
11	2	7	69.5	1964		7.925465	
12	3	15	88.2	1483	1976	8.570757	
13	2	11	82.6	1586		9.440455	
14	2	9	58.8	1975		10.012958	
15	1	5	60.4			10.94859	
16	2	7	52	1201		11.706644	

Bin5 Statistics 11

CF=5272MHz

Trial #	Pulse	Chirp (MHz)	Pulse Width (µS)	Pulse 1-2 spacing (uS)	Pulse 2-3 spacing (uS)	Pulse Start(S)	Detection (1:yes; 0:no)
0	3	20	61.5	1154	1907	0.285427	1
1	2	12	73.4	1999		1.831981	
2	2	18	62.7	1530		2.931057	
3	3	12	99.4	1706	1308	4.96828	
4	1	7	66.1			5.722362	
5	3	14	92.2	1030	1784	6.909712	
6	2	17	86.1	1861		8.034456	
7	2	10	63.3	1555		9.368414	
8	1	7	77.7			11.739668	

Bin5 Statistics 12

CF=5269MHz

Trial #	Pulse	Chirp (MHz)	Pulse Width (μS)	Pulse 1-2 spacing (uS)	Pulse 2-3 spacing (uS)	Pulse Start(S)	Detection (1:yes; 0:no)
0	1	17	86.7			0.656354	1
1	3	15	77.5	1791	1481	0.774927	
2	1	10	85.1			1.582475	
3	1	13	65.2			2.911639	
4	2	7	94.2	1465		3.018673	
5	2	18	58.3	1376		4.035195	
6	3	11	90.6	1102	1288	5.09865	
7	2	17	92.2	1194		5.690081	
8	2	10	76.9	1331		6.243108	
9	3	10	52	1956	1747	7.309532	
10	2	18	62.7	1068		8.097743	
11	3	17	92.7	1555	1397	8.932539	
12	1	13	97.8			9.719376	
13	1	20	91.7			9.905068	
14	2	11	57.6	1023		11.004312	
15	2	8	77.2	1317		11.342917	

Bin5 Statistics 13

CF=5265MHz

Trial #	Pulse	Chirp (MHz)	Pulse Width (µS)	Pulse 1-2 spacing (uS)	Pulse 2-3 spacing (uS)	Pulse Start(S)	Detection (1:yes; 0:no)
0	1	17	54.8			0.486346	1
1	1	16	54.4			1.116513	
2	2	19	55.3	1713		1.237619	
3	2	8	62.9	1624		2.261656	
4	3	7	56.1	1837	1744	2.930898	
5	2	13	94.5	1306		3.343528	
6	3	10	66.1	1083	1118	4.071074	
7	1	14	56.4			4.506311	
8	2	5	59.4	1552		5.119857	
9	2	18	76.2	1482		5.694151	
10	2	11	79.5	1661		6.571049	
11	2	17	72.5	1652		6.88186	
12	1	10	97.6			7.287824	
13	3	8	89.2	1947	1123	8.159372	
14	1	12	91.7			8.939507	
15	3	18	61.1	1455	1981	9.401872	
16	2	18	62.1	1016		9.982371	
17	1	8	84			10.224338	
18	3	5	58.8	1161	1501	10.977428	
19	3	19	56.7	1268	1822	11.714276	

Bin5 Statistics 14

CF=5262MHz

Trial #	Pulse	Chirp (MHz)	Pulse Width (µS)	Pulse 1-2 spacing (µS)	Pulse 2-3 spacing (µS)	Pulse Start(S)	Detection (1:yes; 0:no)
0	3	9	51.6	1074	1098	0.308122	1
1	2	14	51.5	1780		1.081241	
2	2	11	79.4	1459		1.870517	
3	3	17	82.6	1805	1561	2.441209	
4	2	9	93.8	1278		3.12709	
5	2	7	93.8	1585		3.569344	
6	1	7	79.1			4.154179	
7	1	19	75.6			5.030966	
8	3	7	78.8	1613	1217	5.282234	
9	2	17	85.6	1577		5.829494	
10	2	16	61.8	1491		6.388694	
11	1	8	95.1			7.247548	
12	3	20	97.3	1810	1244	7.926577	
13	2	14	89.5	1853		8.661843	
14	2	9	82.5	1949		9.331186	
15	3	19	80.9	1535	1413	9.859276	
16	3	16	51.2	1006	1090	10.542761	
17	2	20	77.6	1805		10.843163	
18	3	7	99.2	1016	1451	11.611715	

Bin5 Statistics 15

CF=5277MHz

Trial #	Pulse	Chirp (MHz)	Pulse Width (µS)	Pulse 1-2 spacing (uS)	Pulse 2-3 spacing (uS)	Pulse Start(S)	Detection (1:yes; 0:no)
0	1	7	73.5			0.587631	1
1	2	9	54.6	1952		1.042874	
2	2	7	52	1941		1.575492	
3	3	14	98	1152	1337	2.38963	
4	1	17	72.5			3.128794	
5	1	6	61.3			3.778553	
6	2	9	53.7	1470		4.507069	
7	2	6	96.9	1911		4.968789	
8	3	9	64.8	1510	1760	5.722085	
9	3	8	60.8	1258	1477	6.344308	
10	3	9	89.2	1686	1781	6.887391	
11	1	7	79.3			7.557964	
12	2	15	53.5	1462		8.031675	
13	1	15	78.2			8.715267	
14	2	10	72.2	1637		9.467282	
15	1	19	54.7			10.01808	
16	2	7	53.2	1849		11.24368	
17	2	13	55.8	1193		11.738547	

Bin5 Statistics 16

CF=5267MHz

Trial #	Pulse	Chirp (MHz)	Pulse Width (µS)	Pulse 1-2 spacing (uS)	Pulse 2-3 spacing (uS)	Pulse Start(S)	Detection (1:yes; 0:no)
0	3	12	74.1	1083	1793	0.889158	1
1	1	6	81.9			1.158685	
2	2	16	60.8	1644		1.886109	
3	1	8	91.2			3.140386	
4	2	19	60.3	1024		3.826472	
5	3	13	85.9	1266	1057	4.835987	
6	2	10	84.7	1474		5.568113	
7	1	10	82.1			7.205182	
8	2	17	70.3	1152		7.669703	
9	3	10	63.3	1323	1087	8.569418	
10	2	19	69.3	1892		9.629279	
11	3	19	64.2	1898	1086	10.412631	
12	3	13	70.6	1866	1481	11.471979	

Bin5 Statistics 17

CF=5277MHz

Trial #	Pulse	Chirp (MHz)	Pulse Width (µS)	Pulse 1-2 spacing (uS)	Pulse 2-3 spacing (uS)	Pulse Start(S)	Detection (1:yes; 0:no)
0	3	12	60.7	1367	1502	0.051547	1
1	3	5	72.2	1199	1160	0.80837	
2	1	11	58.8			1.606142	
3	2	13	75.5	1826		2.960878	
4	1	20	97.6			3.433112	
5	2	14	89.6	1683		3.90678	
6	1	9	69.7			5.139476	
7	2	19	58.2	1643		5.706276	
8	2	6	61.3	1652		6.30015	
9	3	10	54.9	1670	1162	7.050222	
10	3	10	60.1	1298	1007	8.211138	
11	3	18	90.7	1785	1434	8.432286	
12	3	7	86.7	2000	1939	9.508947	
13	3	9	82	1416	1627	10.268095	
14	1	6	62.5			11.072861	
15	3	18	95.1	1110	1020	11.779092	

Bin5 Statistics 18

CF=5262MHz

Trial #	Pulse	Chirp (MHz)	Pulse Width (µS)	Pulse 1-2 spacing (µS)	Pulse 2-3 spacing (µS)	Pulse Start(S)	Detection (1:yes; 0:no)
0	1	13	96.4			0.621549	1
1	2	16	61.7	1696		0.752543	
2	2	20	70.5	1191		1.355094	
3	2	15	82.2	1523		2.240764	
4	2	13	55.4	1812		2.82442	
5	1	9	76.5			3.43024	
6	2	9	95.6	1217		3.987459	
7	3	16	50.1	1056	1543	4.504779	
8	2	7	62	1851		5.431927	
9	1	8	82.6			5.900883	
10	2	8	70.5	1321		6.353474	
11	3	17	64.4	1165	1379	7.352075	
12	1	5	89.4			8.050873	
13	2	12	60.1	1106		8.291695	
14	2	19	62.7	1999		9.121798	
15	2	9	80.6	1014		9.580342	
16	2	19	59.3	1911		10.277199	
17	2	20	82.6	1267		11.345422	
18	2	9	66.4	1078		11.603727	

Bin5 Statistics 19

CF=5282MHz

Trial #	Pulse	Chirp (MHz)	Pulse Width (µS)	Pulse 1-2 spacing (µS)	Pulse 2-3 spacing (µS)	Pulse Start(S)	Detection (1:yes; 0:no)
0	3	16	89.9	1579	1503	0.628654	1
1	1	18	50.2			1.288144	
2	3	17	58.6	1697	1076	2.802663	
3	2	19	86.1	1848		4.072263	
4	3	16	71.5	1584	1859	5.483095	
5	1	7	91.4			6.38243	
6	2	16	63.2	1297		7.879148	
7	3	15	87.7	1032	1772	9.271876	
8	2	20	50.1	1951		9.732332	
9	3	5	69.2	1132	1587	11.871156	

Bin5 Statistics 20

CF=5262MHz

Trial #	Pulse	Chirp (MHz)	Pulse Width (µS)	Pulse 1-2 spacing (uS)	Pulse 2-3 spacing (uS)	Pulse Start(S)	Detection (1:yes; 0:no)
0	3	7	94.5	1043	1812	0.592086	1
1	1	7	80.3			0.875246	
2	2	12	88.4	1943		1.702537	
3	2	15	70.1	1084		2.644937	
4	2	17	99.3	1248		3.631212	
5	2	11	87.9	1643		4.320455	
6	1	7	74.5			5.042993	
7	2	6	90.9	1039		5.807654	
8	3	15	92.6	1444	1356	6.685625	
9	2	20	83.7	1252		7.74611	
10	2	18	71.8	1954		8.327292	
11	2	20	91	1457		8.976486	
12	1	20	64.2			10.021801	
13	1	14	88.9			10.476684	
14	2	8	92.8	1552		11.664164	

Bin5 Statistics 21

CF=5267MHz

Trial #	Pulse	Chirp (MHz)	Pulse Width (µS)	Pulse 1-2 spacing (uS)	Pulse 2-3 spacing (uS)	Pulse Start(S)	Detection (1:yes; 0:no)
0	2	6	74.9	1193		0.23251	1
1	3	13	70.2	1573	1848	1.517943	
2	2	8	85.8	1909		1.723523	
3	3	19	75.2	1859	1638	2.678566	
4	3	7	90.1	1894	1921	3.959805	
5	1	16	66.7			4.651162	
6	2	14	79.5	1228		5.46954	
7	2	10	58.1	1286		6.73735	
8	2	18	89.4	1719		7.225352	
9	3	17	54.4	1186	1396	8.447244	
10	2	17	58	1116		9.114281	
11	3	7	81.1	1094	1185	9.703594	
12	2	8	84.2	1124		10.710334	
13	1	10	70.6			11.411316	

Bin5 Statistics 22

CF=5262MHz

Trial #	Pulse	Chirp (MHz)	Pulse Width (µS)	Pulse 1-2 spacing (uS)	Pulse 2-3 spacing (uS)	Pulse Start(S)	Detection (1:yes; 0:no)
0	3	19	88.6	1144	1708	0.369872	1
1	2	16	96.1	1998		1.225425	
2	3	6	57.5	1901	1021	2.229084	
3	1	6	74.4			2.674274	
4	1	20	61.8			3.900322	
5	2	6	82.5	1295		4.448394	
6	1	8	77.9			4.837164	
7	3	9	95	1218	1029	6.110411	
8	2	19	51.4	1839		7.107798	
9	2	7	66.5	1003		7.382643	
10	3	10	60.8	1630	1167	8.699349	
11	2	6	73.1	1373		9.130969	
12	3	16	92.5	1521	1846	10.373714	
13	2	19	98.6	1050		10.576132	
14	1	9	52.8			11.748094	

Bin5 Statistics 23

CF=5280MHz

Trial #	Pulse	Chirp (MHz)	Pulse Width (µS)	Pulse 1-2 spacing (uS)	Pulse 2-3 spacing (uS)	Pulse Start(S)	Detection (1:yes; 0:no)
0	3	5	52.9	1317	1864	0.143609	1
1	3	19	57.6	1506	1365	1.164287	
2	1	8	78.7			1.432056	
3	3	12	100	1583	1341	2.303935	
4	2	17	91.7	1094		2.882605	
5	1	10	53.7			3.123034	
6	2	14	74.3	1334		3.623847	
7	3	5	95.7	1026	1301	4.609458	
8	2	7	72.9	1056		5.292398	
9	2	7	67	1440		5.641295	
10	1	15	51			6.113981	
11	3	6	65.3	1942	1586	6.848609	
12	3	14	68.2	1489	1184	7.411245	
13	1	13	90.6			8.390101	
14	3	17	65.4	1293	1625	8.839607	
15	1	10	84.7			9.590205	
16	2	12	64.9	1941		10.118276	
17	2	10	78.3	1703		10.448113	
18	1	16	62.2			10.853532	
19	3	8	67.5	1710	1285	11.658305	

Bin5 Statistics 24

CF=5252MHz

Trial #	Pulse	Chirp (MHz)	Pulse Width (μS)	Pulse 1-2 spacing (uS)	Pulse 2-3 spacing (uS)	Pulse Start(S)	Detection (1:yes; 0:no)
0	1	11	90.4			0.26615	1
1	2	10	84.8	1486		1.169277	
2	3	9	80.5	1083	1551	1.888246	
3	2	5	98.8	1938		2.935341	
4	2	11	61.2	1977		3.089979	
5	3	12	61.4	1511	1629	3.770117	
6	3	20	93.3	1562	1311	5.094584	
7	2	14	59.8	1741		5.479835	
8	2	15	97.3	1726		6.079943	
9	3	16	57.6	1831	1641	7.014422	
10	2	14	93.1	1463		8.012904	
11	2	11	72.1	1252		8.263041	
12	1	15	70.1			9.628605	
13	1	19	76.1			9.757543	
14	2	19	97.6	1418		10.639319	
15	2	8	93	1483		11.587487	

Bin5 Statistics 25

CF=5268MHz

Trial #	Pulse	Chirp (MHz)	Pulse Width (µS)	Pulse 1-2 spacing (uS)	Pulse 2-3 spacing (uS)	Pulse Start(S)	Detection (1:yes; 0:no)
0	1	15	91.1			0.56359	1
1	1	9	97.2			0.997746	
2	1	14	93.7			2.230727	
3	3	7	85.5	1001	1724	2.621135	
4	2	16	70.1	1949		3.036167	
5	2	8	54.4	1771		3.95037	
6	3	10	87.6	1093	1848	5.125191	
7	2	10	99.3	1910		5.497074	
8	2	18	52.3	1406		6.204937	
9	2	15	73.5	1818		7.37908	
10	3	15	72.1	1279	1630	7.680212	
11	2	11	93.2	1562		8.512829	
12	2	15	92.7	1851		9.741538	
13	2	18	81.8	1986		9.854071	
14	1	15	74.3			10.960077	
15	1	9	57			11.569502	

Bin5 Statistics 26

CF=5260MHz

Trial #	Pulse	Chirp (MHz)	Pulse Width (µS)	Pulse 1-2 spacing (uS)	Pulse 2-3 spacing (uS)	Pulse Start(S)	Detection (1:yes; 0:no)
0	2	14	92.6	1751		0.303238	1
1	2	17	50.4	1082		1.777283	
2	2	17	88.2	1418		2.878309	
3	2	15	95	1454		3.725425	
4	2	8	86.4	1952		4.274036	
5	2	16	58	1283		5.494606	
6	2	9	88.3	1863		6.113988	
7	1	11	58.2			7.462236	
8	2	6	60.3	1890		8.447668	
9	2	7	86.6	1563		9.378226	
10	2	13	58.7	1913		10.39954	
11	2	5	72.4	1995		11.962426	

Bin5 Statistics 27

CF=5261MHz

Trial #	Pulse	Chirp (MHz)	Pulse Width (µS)	Pulse 1-2 spacing (uS)	Pulse 2-3 spacing (uS)	Pulse Start(S)	Detection (1:yes; 0:no)
0	3	9	69.3	1340	1999	0.016098	1
1	1	6	54.6			1.274568	
2	2	13	63.1	1210		1.757359	
3	2	13	97.7	1847		2.244134	
4	1	7	57.4			2.922677	
5	2	11	56.7	1549		3.656009	
6	3	7	59.5	1014	1471	4.843553	
7	2	14	64.2	1845		4.999037	
8	2	14	90.2	1614		6.110428	
9	2	10	78.2	1315		6.409631	
10	3	13	82.1	1444	1052	7.710198	
11	3	12	96.4	1612	1144	8.410591	
12	1	8	88.1			8.488818	
13	2	12	81.3	1422		9.617833	
14	2	19	69.1	1702		10.173551	
15	1	15	76			11.142483	
16	2	7	84.5	1106		11.443095	

Bin5 Statistics 28

CF=5262MHz

Trial #	Pulse	Chirp (MHz)	Pulse Width (µS)	Pulse 1-2 spacing (uS)	Pulse 2-3 spacing (uS)	Pulse Start(S)	Detection (1:yes; 0:no)
0	2	11	69.6	1152		0.360687	1
1	1	13	74			1.21577	
2	2	9	93	1584		2.02649	
3	2	20	97.1	1023		2.380699	
4	2	17	82.1	1584		3.472161	
5	2	12	78.3	1930		3.798162	
6	1	6	75.1			4.633953	
7	2	16	77.9	1669		5.026046	
8	2	11	77.7	1188		5.980825	
9	1	11	77.3			6.49675	
10	2	6	86.2	1153		7.73781	
11	2	17	81.7	1516		8.446041	
12	2	17	78.4	1828		8.930998	
13	3	6	89	1047	1447	9.283491	
14	2	19	78.1	1881		10.377987	
15	1	17	66.9			10.710187	
16	1	6	55.8			11.531879	

Bin5 Statistics 29

CF=5257MHz

Trial #	Pulse	Chirp (MHz)	Pulse Width (µS)	Pulse 1-2 spacing (uS)	Pulse 2-3 spacing (uS)	Pulse Start(S)	Detection (1:yes; 0:no)
0	2	6	91.3	1714		0.715757	1
1	2	11	52.2	1852		1.56007	
2	3	17	98.3	1649	1021	3.091798	
3	1	9	92.6			3.924185	
4	1	19	78.3			4.558172	
5	1	5	50			6.208349	
6	1	17	65.9			7.259292	
7	2	12	66.3	1188		7.74422	
8	3	11	92	1453	1007	9.647057	
9	1	12	57.3			10.30274	
10	2	19	97.2	1001		11.030222	

Bin5 Statistics 30

CF=5260MHz

Trial #	Pulse	Chirp (MHz)	Pulse Width (µS)	Pulse 1-2 spacing (µS)	Pulse 2-3 spacing (µS)	Pulse Start(S)	Detection (1:yes; 0:no)
0	2	18	51.8	1096		0.257308	1
1	1	10	75.3			1.204194	
2	2	9	76.2	1705		1.413316	
3	1	12	99.1			2.38608	
4	1	17	93.6			3.275489	
5	2	20	75.3	1427		3.647121	
6	2	8	71.9	1096		4.504842	
7	3	5	91	1036	1164	4.825025	
8	2	10	58.2	1002		5.458256	
9	2	12	68.1	1568		6.117165	
10	3	15	77.3	1923	1282	6.675976	
11	2	12	74.2	1527		7.616889	
12	2	19	75.9	1507		8.304395	
13	1	13	99.6			9.145586	
14	3	8	98.9	1495	1120	9.817413	
15	2	12	80.3	1953		10.529644	
16	1	8	63.5			11.079914	
17	3	18	72.4	1498	1177	11.596046	

Table-6 Radar Type 6 Statistical Performance

Trial #	Fc (MHz)	Pulse /Burst	Pulse Width (µS)	PRI (µs)	Detection (1:yes; 0:no)	Hopping Sequence
1	5270	9	1	333	1	5344.0, 5397.0, 5398.0, 5462.0, 5531.0, 5508.0, 5667.0, 5529.0, 5313.0, 5584.0, 5536.0, 5616.0, 5337.0, 5419.0, 5579.0, 5519.0, 5449.0, 5310.0, 5649.0, 5386.0, 5566.0, 5681.0, 5702.0, 5511.0, 5522.0, 5674.0, 5411.0, 5391.0, 5400.0, 5465.0, 5624.0, 5659.0, 5609.0, 5710.0, 5534.0, 5296.0, 5539.0, 5350.0, 5298.0, 5295.0, 5393.0, 5282.0, 5656.0, 5336.0, 5596.0, 5582.0, 5494.0, 5638.0, 5332.0, 5645.0, 5252.0, 5712.0, 5507.0, 5470.0, 5490.0, 5717.0, 5489.0, 5451.0, 5424.0, 5293.0, 5615.0, 5403.0, 5602.0, 5401.0, 5704.0, 5590.0, 5402.0, 5583.0, 5472.0, 5454.0, 5524.0, 5506.0, 5355.0, 5482.0, 5396.0, 5357.0, 5581.0, 5325.0, 5586.0, 5305.0, 5346.0, 5598.0, 5661.0, 5591.0, 5600.0, 5456.0, 5444.0, 5319.0, 5714.0, 5491.0, 5567.0, 5644.0, 5433.0, 5430.0, 5525.0, 5653.0, 5469.0, 5480.0, 5632.0, 5303.0 (number of hits: 2)
2	5270	9	1	333	1	5258.0, 5268.0, 5687.0, 5688.0, 5709.0, 5402.0, 5543.0, 5318.0, 5307.0, 5615.0, 5323.0, 5679.0, 5720.0, 5721.0, 5544.0, 5573.0, 5271.0, 5532.0, 5564.0, 5419.0, 5640.0, 5644.0, 5482.0, 5586.0, 5530.0, 5693.0, 5522.0, 5462.0, 5274.0, 5598.0, 5523.0, 5350.0, 5634.0, 5535.0, 5485.0, 5383.0, 5401.0, 5497.0, 5551.0, 5680.0, 5393.0, 5304.0, 5524.0, 5572.0, 5412.0, 5596.0, 5723.0, 5451.0, 5492.0, 5571.0, 5339.0, 5711.0, 5603.0, 5563.0, 5642.0, 5453.0, 5691.0, 5503.0, 5252.0, 5367.0, 5514.0, 5305.0, 5431.0, 5372.0, 5713.0, 5508.0, 5312.0, 5341.0, 5273.0, 5560.0, 5469.0, 5483.0, 5295.0, 5702.0, 5427.0, 5461.0, 5338.0, 5389.0, 5474.0, 5351.0, 5705.0, 5512.0, 5426.0, 5379.0, 5471.0, 5324.0, 5308.0, 5668.0, 5515.0, 5557.0, 5602.0, 5404.0, 5531.0, 5622.0, 5396.0, 5361.0, 5382.0, 5381.0, 5597.0, 5585.0 (number of hits: 6)
3	5270	9	1	333	1	5503.0, 5302.0, 5441.0, 5259.0, 5542.0, 5708.0, 5400.0, 5700.0, 5437.0, 5346.0, 5337.0, 5677.0, 5340.0, 5256.0, 5516.0, 5587.0, 5311.0, 5600.0, 5425.0, 5653.0, 5455.0, 5692.0, 5452.0, 5355.0, 5617.0, 5694.0, 5413.0, 5395.0, 5686.0, 5329.0, 5616.0, 5415.0, 5382.0, 5339.0, 5630.0, 5636.0, 5569.0, 5360.0, 5294.0, 5490.0, 5277.0, 5276.0, 5411.0, 5698.0, 5404.0, 5430.0, 5659.0, 5478.0, 5582.0, 5405.0, 5649.0, 5559.0, 5366.0, 5419.0, 5426.0, 5624.0, 5412.0, 5292.0, 5538.0, 5264.0,

						5449.0, 5563.0, 5451.0, 5481.0, 5458.0, 5285.0, 5253.0, 5306.0, 5647.0, 5579.0, 5648.0, 5685.0, 5512.0, 5328.0, 5514.0, 5628.0, 5655.0, 5500.0, 5520.0, 5385.0, 5568.0, 5718.0, 5551.0, 5410.0, 5595.0, 5252.0, 5269.0, 5432.0, 5377.0, 5613.0, 5521.0, 5345.0, 5501.0, 5652.0, 5301.0, 5367.0, 5605.0, 5633.0, 5436.0, 5634.0 (number of hits: 9)
4	5270	9	1	333	1	5704.0, 5393.0, 5579.0, 5633.0, 5492.0, 5646.0, 5630.0, 5285.0, 5341.0, 5410.0, 5627.0, 5582.0, 5302.0, 5406.0, 5255.0, 5412.0, 5452.0, 5588.0, 5715.0, 5421.0, 5372.0, 5570.0, 5515.0, 5427.0, 5550.0, 5621.0, 5615.0, 5485.0, 5597.0, 5439.0, 5457.0, 5688.0, 5474.0, 5494.0, 5361.0, 5719.0, 5461.0, 5599.0, 5388.0, 5682.0, 5306.0, 5270.0, 5529.0, 5258.0, 5663.0, 5354.0, 5598.0, 5407.0, 5265.0, 5444.0, 5600.0, 5592.0, 5394.0, 5617.0, 5434.0, 5483.0, 5670.0, 5626.0, 5374.0, 5319.0, 5375.0, 5585.0, 5673.0, 5336.0, 5544.0, 5355.0, 5416.0, 5631.0, 5591.0, 5607.0, 5716.0, 5273.0, 5493.0, 5577.0, 5380.0, 5286.0, 5251.0, 5703.0, 5405.0, 5383.0, 5654.0, 5713.0, 5561.0, 5399.0, 5259.0, 5611.0, 5658.0, 5707.0, 5700.0, 5446.0, 5386.0, 5648.0, 5396.0, 5534.0, 5263.0, 5542.0, 5440.0, 5676.0, 5569.0, 5563.0 (number of hits: 10)
5	5270	9	1	333	1	5257.0, 5460.0, 5493.0, 5399.0, 5389.0, 5474.0, 5273.0, 5376.0, 5600.0, 5365.0, 5457.0, 5302.0, 5684.0, 5588.0, 5391.0, 5482.0, 5701.0, 5252.0, 5388.0, 5362.0, 5402.0, 5251.0, 5363.0, 5573.0, 5548.0, 5498.0, 5571.0, 5449.0, 5677.0, 5517.0, 5711.0, 5623.0, 5599.0, 5513.0, 5619.0, 5491.0, 5337.0, 5401.0, 5276.0, 5585.0, 5440.0, 5698.0, 5542.0, 5355.0, 5603.0, 5317.0, 5278.0, 5360.0, 5667.0, 5669.0, 5455.0, 5520.0, 5549.0, 5309.0, 5657.0, 5461.0, 5543.0, 5499.0, 5488.0, 5521.0, 5315.0, 5258.0, 5375.0, 5262.0, 5381.0, 5327.0, 5703.0, 5328.0, 5633.0, 5398.0, 5719.0, 5509.0, 5597.0, 5436.0, 5598.0, 5563.0, 5675.0, 5354.0, 5550.0, 5348.0, 5267.0, 5514.0, 5545.0, 5265.0, 5285.0, 5575.0, 5562.0, 5428.0, 5290.0, 5403.0, 5344.0, 5453.0, 5546.0, 5590.0, 5329.0, 5353.0, 5325.0, 5681.0, 5393.0, 5316.0 (number of hits: 11)
6	5270	9	1	333	1	5502.0, 5633.0, 5344.0, 5711.0, 5373.0, 5714.0, 5333.0, 5393.0, 5401.0, 5721.0, 5512.0, 5647.0, 5531.0, 5267.0, 5489.0, 5552.0, 5580.0, 5597.0, 5363.0, 5326.0, 5415.0, 5336.0, 5670.0, 5677.0, 5648.0, 5652.0, 5283.0, 5369.0, 5483.0, 5508.0, 5343.0, 5565.0, 5386.0, 5705.0, 5693.0, 5651.0, 5270.0, 5321.0, 5606.0, 5573.0,

						5281.0, 5686.0, 5529.0, 5364.0, 5492.0, 5487.0, 5419.0, 5537.0, 5557.0, 5478.0, 5399.0, 5673.0, 5324.0, 5609.0, 5427.0, 5697.0, 5301.0, 5467.0, 5643.0, 5382.0, 5253.0, 5626.0, 5448.0, 5460.0, 5519.0, 5262.0, 5603.0, 5712.0, 5426.0, 5550.0, 5302.0, 5378.0, 5280.0, 5383.0, 5536.0, 5611.0, 5700.0, 5713.0, 5680.0, 5720.0, 5549.0, 5353.0, 5451.0, 5583.0, 5347.0, 5654.0, 5367.0, 5315.0, 5699.0, 5586.0, 5286.0, 5625.0, 5435.0, 5692.0, 5441.0, 5323.0, 5663.0, 5665.0, 5526.0, 5561.0 (number of hits: 8)
7	5270	9	1	333	1	5679.0, 5636.0, 5416.0, 5403.0, 5409.0, 5535.0, 5400.0, 5402.0, 5500.0, 5695.0, 5523.0, 5648.0, 5320.0, 5681.0, 5703.0, 5414.0, 5688.0, 5262.0, 5381.0, 5304.0, 5558.0, 5475.0, 5611.0, 5457.0, 5529.0, 5360.0, 5705.0, 5565.0, 5598.0, 5654.0, 5401.0, 5570.0, 5588.0, 5625.0, 5521.0, 5609.0, 5487.0, 5405.0, 5435.0, 5257.0, 5511.0, 5584.0, 5545.0, 5701.0, 5312.0, 5637.0, 5537.0, 5436.0, 5530.0, 5501.0, 5498.0, 5473.0, 5429.0, 5492.0, 5315.0, 5687.0, 5481.0, 5480.0, 5574.0, 5579.0, 5702.0, 5390.0, 5673.0, 5313.0, 5425.0, 5447.0, 5297.0, 5690.0, 5586.0, 5697.0, 5489.0, 5513.0, 5254.0, 5507.0, 5421.0, 5721.0, 5708.0, 5440.0, 5655.0, 5293.0, 5548.0, 5319.0, 5711.0, 5283.0, 5506.0, 5624.0, 5439.0, 5271.0, 5342.0, 5366.0, 5364.0, 5651.0, 5706.0, 5367.0, 5383.0, 5362.0, 5665.0, 5539.0, 5441.0, 5645.0 (number of hits: 5)
8	5270	9	1	333	1	5311.0, 5282.0, 5394.0, 5461.0, 5309.0, 5550.0, 5402.0, 5403.0, 5560.0, 5474.0, 5471.0, 5289.0, 5649.0, 5570.0, 5400.0, 5673.0, 5342.0, 5710.0, 5679.0, 5527.0, 5437.0, 5714.0, 5270.0, 5470.0, 5250.0, 5439.0, 5392.0, 5356.0, 5545.0, 5417.0, 5338.0, 5580.0, 5458.0, 5292.0, 5603.0, 5278.0, 5343.0, 5296.0, 5277.0, 5711.0, 5472.0, 5307.0, 5533.0, 5418.0, 5273.0, 5511.0, 5523.0, 5634.0, 5589.0, 5328.0, 5262.0, 5652.0, 5619.0, 5433.0, 5434.0, 5510.0, 5303.0, 5707.0, 5540.0, 5361.0, 5304.0, 5697.0, 5659.0, 5576.0, 5401.0, 5612.0, 5700.0, 5367.0, 5454.0, 5357.0, 5579.0, 5473.0, 5276.0, 5382.0, 5672.0, 5337.0, 5556.0, 5479.0, 5310.0, 5512.0, 5359.0, 5543.0, 5429.0, 5670.0, 5348.0, 5363.0, 5555.0, 5541.0, 5658.0, 5281.0, 5681.0, 5406.0, 5252.0, 5607.0, 5463.0, 5647.0, 5272.0, 5601.0, 5564.0, 5583.0 (number of hits: 12)
9	5270	9	1	333	1	5465.0, 5329.0, 5392.0, 5574.0, 5558.0, 5539.0, 5665.0, 5347.0, 5331.0, 5279.0, 5326.0, 5361.0, 5591.0, 5677.0, 5422.0, 5585.0, 5724.0, 5296.0, 5550.0, 5681.0,

						5611.0, 5484.0, 5659.0, 5537.0, 5417.0, 5380.0, 5661.0, 5349.0, 5403.0, 5255.0, 5502.0, 5540.0, 5350.0, 5288.0, 5529.0, 5442.0, 5389.0, 5325.0, 5469.0, 5306.0, 5437.0, 5616.0, 5322.0, 5355.0, 5432.0, 5610.0, 5541.0, 5491.0, 5621.0, 5651.0, 5544.0, 5515.0, 5421.0, 5679.0, 5277.0, 5481.0, 5407.0, 5506.0, 5352.0, 5572.0, 5471.0, 5274.0, 5459.0, 5617.0, 5321.0, 5508.0, 5700.0, 5672.0, 5435.0, 5500.0, 5595.0, 5637.0, 5504.0, 5694.0, 5511.0, 5412.0, 5443.0, 5589.0, 5263.0, 5292.0, 5483.0, 5445.0, 5645.0, 5299.0, 5341.0, 5275.0, 5308.0, 5627.0, 5386.0, 5717.0, 5633.0, 5612.0, 5454.0, 5343.0, 5410.0, 5498.0, 5266.0, 5441.0, 5582.0, 5548.0 (number of hits: 8)
10	5270	9	1	333	1	5304.0, 5281.0, 5325.0, 5379.0, 5462.0, 5376.0, 5453.0, 5709.0, 5685.0, 5350.0, 5695.0, 5451.0, 5629.0, 5463.0, 5481.0, 5380.0, 5563.0, 5268.0, 5472.0, 5264.0, 5621.0, 5540.0, 5652.0, 5483.0, 5267.0, 5658.0, 5314.0, 5401.0, 5650.0, 5306.0, 5565.0, 5618.0, 5567.0, 5329.0, 5479.0, 5688.0, 5528.0, 5395.0, 5425.0, 5449.0, 5430.0, 5627.0, 5489.0, 5282.0, 5561.0, 5712.0, 5548.0, 5665.0, 5681.0, 5295.0, 5655.0, 5581.0, 5507.0, 5276.0, 5374.0, 5716.0, 5310.0, 5327.0, 5292.0, 5414.0, 5603.0, 5630.0, 5470.0, 5587.0, 5501.0, 5461.0, 5595.0, 5297.0, 5266.0, 5616.0, 5280.0, 5277.0, 5403.0, 5559.0, 5707.0, 5592.0, 5251.0, 5253.0, 5356.0, 5444.0, 5605.0, 5435.0, 5575.0, 5475.0, 5397.0, 5290.0, 5468.0, 5448.0, 5394.0, 5464.0, 5358.0, 5557.0, 5717.0, 5612.0, 5399.0, 5691.0, 5288.0, 5355.0, 5702.0, 5317.0 (number of hits: 12)
11	5270	9	1	333	1	5398.0, 5656.0, 5254.0, 5639.0, 5271.0, 5420.0, 5443.0, 5480.0, 5720.0, 5719.0, 5433.0, 5294.0, 5323.0, 5581.0, 5297.0, 5448.0, 5705.0, 5505.0, 5334.0, 5400.0, 5470.0, 5283.0, 5388.0, 5658.0, 5578.0, 5676.0, 5569.0, 5252.0, 5716.0, 5590.0, 5682.0, 5360.0, 5552.0, 5555.0, 5272.0, 5528.0, 5371.0, 5472.0, 5318.0, 5674.0, 5446.0, 5307.0, 5721.0, 5540.0, 5369.0, 5426.0, 5501.0, 5439.0, 5515.0, 5494.0, 5645.0, 5326.0, 5314.0, 5508.0, 5399.0, 5385.0, 5427.0, 5600.0, 5265.0, 5545.0, 5635.0, 5534.0, 5611.0, 5643.0, 5257.0, 5541.0, 5642.0, 5497.0, 5337.0, 5293.0, 5623.0, 5678.0, 5377.0, 5411.0, 5527.0, 5339.0, 5436.0, 5662.0, 5594.0, 5490.0, 5264.0, 5251.0, 5402.0, 5289.0, 5367.0, 5631.0, 5288.0, 5321.0, 5463.0, 5626.0, 5263.0, 5507.0, 5574.0, 5269.0, 5395.0, 5354.0, 5663.0, 5262.0, 5273.0, 5454.0 (number of hits: 15)

12	5270	9	1	333	1	<p>5477.0, 5263.0, 5344.0, 5465.0, 5539.0, 5475.0, 5366.0, 5290.0, 5330.0, 5493.0, 5671.0, 5683.0, 5601.0, 5349.0, 5634.0, 5716.0, 5554.0, 5270.0, 5258.0, 5707.0, 5603.0, 5706.0, 5449.0, 5491.0, 5666.0, 5677.0, 5639.0, 5533.0, 5580.0, 5443.0, 5450.0, 5721.0, 5661.0, 5416.0, 5378.0, 5522.0, 5382.0, 5339.0, 5351.0, 5318.0, 5281.0, 5502.0, 5535.0, 5470.0, 5350.0, 5372.0, 5530.0, 5602.0, 5395.0, 5630.0, 5597.0, 5558.0, 5600.0, 5286.0, 5315.0, 5471.0, 5578.0, 5323.0, 5575.0, 5387.0, 5524.0, 5396.0, 5658.0, 5476.0, 5432.0, 5643.0, 5368.0, 5386.0, 5684.0, 5337.0, 5590.0, 5302.0, 5717.0, 5565.0, 5365.0, 5367.0, 5274.0, 5406.0, 5654.0, 5511.0, 5664.0, 5361.0, 5392.0, 5547.0, 5295.0, 5422.0, 5611.0, 5347.0, 5621.0, 5615.0, 5679.0, 5271.0, 5289.0, 5685.0, 5501.0, 5407.0, 5576.0, 5426.0, 5618.0, 5297.0 (number of hits: 8)</p>
13	5270	9	1	333	1	<p>5569.0, 5588.0, 5433.0, 5318.0, 5360.0, 5598.0, 5638.0, 5587.0, 5278.0, 5672.0, 5451.0, 5378.0, 5590.0, 5586.0, 5581.0, 5354.0, 5394.0, 5462.0, 5391.0, 5342.0, 5392.0, 5610.0, 5325.0, 5560.0, 5567.0, 5573.0, 5628.0, 5674.0, 5660.0, 5341.0, 5654.0, 5503.0, 5529.0, 5437.0, 5346.0, 5605.0, 5377.0, 5698.0, 5688.0, 5314.0, 5632.0, 5597.0, 5319.0, 5333.0, 5361.0, 5254.0, 5591.0, 5381.0, 5405.0, 5496.0, 5631.0, 5336.0, 5389.0, 5441.0, 5499.0, 5272.0, 5382.0, 5706.0, 5255.0, 5293.0, 5670.0, 5683.0, 5373.0, 5584.0, 5463.0, 5649.0, 5484.0, 5271.0, 5436.0, 5379.0, 5397.0, 5545.0, 5284.0, 5421.0, 5444.0, 5509.0, 5658.0, 5666.0, 5539.0, 5288.0, 5323.0, 5442.0, 5616.0, 5533.0, 5603.0, 5334.0, 5268.0, 5458.0, 5494.0, 5363.0, 5659.0, 5510.0, 5559.0, 5417.0, 5579.0, 5554.0, 5425.0, 5264.0, 5574.0, 5329.0 (number of hits: 9)</p>
14	5270	9	1	333	1	<p>5353.0, 5370.0, 5356.0, 5715.0, 5406.0, 5499.0, 5714.0, 5615.0, 5349.0, 5269.0, 5319.0, 5434.0, 5311.0, 5385.0, 5474.0, 5424.0, 5276.0, 5566.0, 5389.0, 5592.0, 5463.0, 5626.0, 5518.0, 5288.0, 5524.0, 5361.0, 5450.0, 5554.0, 5320.0, 5280.0, 5422.0, 5661.0, 5417.0, 5493.0, 5535.0, 5544.0, 5700.0, 5657.0, 5294.0, 5549.0, 5347.0, 5362.0, 5509.0, 5388.0, 5642.0, 5261.0, 5632.0, 5620.0, 5318.0, 5274.0, 5298.0, 5563.0, 5339.0, 5291.0, 5637.0, 5624.0, 5510.0, 5690.0, 5367.0, 5281.0, 5567.0, 5621.0, 5285.0, 5409.0, 5397.0, 5627.0, 5584.0, 5682.0, 5449.0, 5696.0, 5286.0, 5531.0, 5445.0, 5268.0, 5664.0, 5350.0, 5458.0, 5533.0, 5492.0, 5597.0, 5464.0, 5555.0, 5378.0, 5641.0, 5571.0</p>

						5525.0, 5468.0, 5472.0, 5670.0, 5270.0, 5334.0, 5289.0, 5689.0, 5703.0, 5433.0, 5645.0, 5695.0, 5606.0, 5508.0, 5267.0 (number of hits: 13)
15	5270	9	1	333	1	5338.0, 5406.0, 5475.0, 5686.0, 5712.0, 5627.0, 5614.0, 5651.0, 5646.0, 5368.0, 5440.0, 5381.0, 5715.0, 5318.0, 5662.0, 5558.0, 5609.0, 5599.0, 5397.0, 5261.0, 5376.0, 5251.0, 5635.0, 5474.0, 5290.0, 5365.0, 5709.0, 5708.0, 5334.0, 5383.0, 5324.0, 5565.0, 5496.0, 5404.0, 5659.0, 5601.0, 5624.0, 5503.0, 5550.0, 5322.0, 5618.0, 5433.0, 5655.0, 5592.0, 5680.0, 5705.0, 5260.0, 5562.0, 5431.0, 5678.0, 5676.0, 5577.0, 5681.0, 5446.0, 5484.0, 5464.0, 5459.0, 5391.0, 5398.0, 5328.0, 5399.0, 5665.0, 5288.0, 5539.0, 5385.0, 5702.0, 5485.0, 5532.0, 5587.0, 5653.0, 5645.0, 5315.0, 5568.0, 5567.0, 5518.0, 5571.0, 5600.0, 5450.0, 5268.0, 5321.0, 5591.0, 5590.0, 5585.0, 5386.0, 5617.0, 5437.0, 5313.0, 5405.0, 5254.0, 5460.0, 5354.0, 5442.0, 5250.0, 5280.0, 5430.0, 5538.0, 5479.0, 5516.0, 5452.0, 5402.0 (number of hits: 8)
16	5270	9	1	333	1	5415.0, 5273.0, 5436.0, 5305.0, 5345.0, 5515.0, 5456.0, 5452.0, 5346.0, 5534.0, 5558.0, 5683.0, 5307.0, 5404.0, 5640.0, 5623.0, 5364.0, 5260.0, 5411.0, 5530.0, 5543.0, 5437.0, 5594.0, 5724.0, 5717.0, 5403.0, 5525.0, 5298.0, 5280.0, 5701.0, 5370.0, 5523.0, 5577.0, 5368.0, 5312.0, 5644.0, 5718.0, 5539.0, 5656.0, 5513.0, 5292.0, 5529.0, 5499.0, 5484.0, 5253.0, 5335.0, 5257.0, 5680.0, 5279.0, 5361.0, 5301.0, 5578.0, 5557.0, 5479.0, 5413.0, 5642.0, 5494.0, 5606.0, 5299.0, 5672.0, 5643.0, 5496.0, 5585.0, 5540.0, 5504.0, 5476.0, 5519.0, 5333.0, 5674.0, 5269.0, 5689.0, 5382.0, 5570.0, 5617.0, 5355.0, 5291.0, 5372.0, 5641.0, 5564.0, 5584.0, 5464.0, 5296.0, 5688.0, 5488.0, 5511.0, 5682.0, 5448.0, 5635.0, 5297.0, 5677.0, 5315.0, 5444.0, 5620.0, 5626.0, 5396.0, 5384.0, 5393.0, 5381.0, 5263.0, 5310.0 (number of hits: 8)
17	5270	9	1	333	1	5686.0, 5632.0, 5477.0, 5665.0, 5374.0, 5380.0, 5487.0, 5625.0, 5619.0, 5664.0, 5326.0, 5282.0, 5276.0, 5337.0, 5683.0, 5349.0, 5327.0, 5379.0, 5582.0, 5483.0, 5292.0, 5264.0, 5289.0, 5484.0, 5433.0, 5277.0, 5270.0, 5350.0, 5311.0, 5694.0, 5259.0, 5537.0, 5400.0, 5437.0, 5651.0, 5586.0, 5375.0, 5468.0, 5462.0, 5540.0, 5279.0, 5368.0, 5298.0, 5358.0, 5673.0, 5423.0, 5448.0, 5677.0, 5590.0, 5397.0, 5481.0, 5528.0, 5432.0, 5640.0, 5410.0, 5268.0, 5365.0, 5357.0, 5597.0, 5312.0, 5523.0, 5638.0, 5543.0, 5370.0, 5362.0,

						5660.0, 5413.0, 5558.0, 5347.0, 5431.0, 5302.0, 5622.0, 5584.0, 5295.0, 5610.0, 5588.0, 5538.0, 5530.0, 5583.0, 5353.0, 5402.0, 5388.0, 5346.0, 5507.0, 5609.0, 5674.0, 5426.0, 5383.0, 5309.0, 5267.0, 5594.0, 5485.0, 5273.0, 5576.0, 5283.0, 5614.0, 5254.0, 5641.0, 5517.0, 5600.0 (number of hits: 13)
18	5270	9	1	333	1	5687.0, 5312.0, 5716.0, 5583.0, 5388.0, 5607.0, 5617.0, 5446.0, 5660.0, 5657.0, 5522.0, 5370.0, 5474.0, 5447.0, 5671.0, 5285.0, 5442.0, 5434.0, 5393.0, 5531.0, 5629.0, 5324.0, 5516.0, 5335.0, 5513.0, 5639.0, 5387.0, 5691.0, 5499.0, 5276.0, 5719.0, 5724.0, 5405.0, 5706.0, 5647.0, 5582.0, 5541.0, 5571.0, 5669.0, 5323.0, 5696.0, 5564.0, 5641.0, 5554.0, 5332.0, 5337.0, 5302.0, 5271.0, 5321.0, 5683.0, 5450.0, 5601.0, 5701.0, 5402.0, 5675.0, 5545.0, 5655.0, 5385.0, 5680.0, 5277.0, 5400.0, 5342.0, 5407.0, 5380.0, 5394.0, 5299.0, 5452.0, 5661.0, 5396.0, 5576.0, 5320.0, 5537.0, 5591.0, 5581.0, 5521.0, 5460.0, 5628.0, 5681.0, 5510.0, 5613.0, 5580.0, 5508.0, 5642.0, 5682.0, 5713.0, 5631.0, 5317.0, 5618.0, 5692.0, 5426.0, 5653.0, 5676.0, 5664.0, 5283.0, 5720.0, 5549.0, 5383.0, 5379.0, 5484.0, 5722.0 (number of hits: 5)
19	5270	9	1	333	1	5671.0, 5618.0, 5723.0, 5497.0, 5585.0, 5298.0, 5592.0, 5711.0, 5531.0, 5550.0, 5551.0, 5306.0, 5426.0, 5546.0, 5384.0, 5270.0, 5623.0, 5482.0, 5519.0, 5416.0, 5331.0, 5293.0, 5516.0, 5670.0, 5323.0, 5523.0, 5308.0, 5649.0, 5464.0, 5485.0, 5402.0, 5471.0, 5593.0, 5373.0, 5525.0, 5566.0, 5554.0, 5336.0, 5440.0, 5673.0, 5363.0, 5661.0, 5577.0, 5534.0, 5486.0, 5362.0, 5277.0, 5484.0, 5596.0, 5692.0, 5507.0, 5630.0, 5707.0, 5501.0, 5536.0, 5710.0, 5500.0, 5267.0, 5398.0, 5724.0, 5435.0, 5608.0, 5289.0, 5527.0, 5511.0, 5541.0, 5299.0, 5495.0, 5370.0, 5328.0, 5688.0, 5549.0, 5396.0, 5607.0, 5327.0, 5481.0, 5260.0, 5457.0, 5262.0, 5612.0, 5258.0, 5403.0, 5601.0, 5520.0, 5359.0, 5600.0, 5698.0, 5700.0, 5319.0, 5595.0, 5647.0, 5345.0, 5694.0, 5411.0, 5410.0, 5615.0, 5456.0, 5286.0, 5680.0, 5341.0 (number of hits: 8)
20	5270	9	1	333	1	5431.0, 5505.0, 5672.0, 5447.0, 5638.0, 5539.0, 5689.0, 5709.0, 5610.0, 5462.0, 5363.0, 5692.0, 5410.0, 5388.0, 5664.0, 5552.0, 5307.0, 5657.0, 5700.0, 5278.0, 5378.0, 5251.0, 5385.0, 5609.0, 5595.0, 5266.0, 5333.0, 5662.0, 5655.0, 5427.0, 5599.0, 5508.0, 5616.0, 5644.0, 5620.0, 5425.0, 5711.0, 5534.0, 5507.0, 5317.0, 5724.0, 5613.0, 5514.0, 5547.0, 5371.0,

						5660.0, 5533.0, 5563.0, 5632.0, 5619.0, 5678.0, 5435.0, 5420.0, 5375.0, 5519.0, 5643.0, 5484.0, 5650.0, 5524.0, 5589.0, 5604.0, 5562.0, 5415.0, 5569.0, 5403.0, 5481.0, 5451.0, 5448.0, 5684.0, 5640.0, 5319.0, 5471.0, 5267.0, 5582.0, 5274.0, 5704.0, 5628.0, 5474.0, 5270.0, 5417.0, 5677.0, 5688.0, 5659.0, 5699.0, 5706.0, 5422.0, 5281.0, 5503.0, 5389.0, 5473.0, 5330.0, 5591.0, 5624.0, 5269.0, 5707.0, 5652.0, 5694.0, 5548.0, 5482.0, 5290.0 (number of hits: 8)
21	5270	9	1	333	1	5705.0, 5605.0, 5582.0, 5334.0, 5278.0, 5612.0, 5390.0, 5432.0, 5571.0, 5314.0, 5597.0, 5505.0, 5547.0, 5426.0, 5707.0, 5354.0, 5631.0, 5467.0, 5363.0, 5578.0, 5621.0, 5671.0, 5512.0, 5538.0, 5476.0, 5256.0, 5454.0, 5466.0, 5529.0, 5266.0, 5297.0, 5567.0, 5647.0, 5501.0, 5688.0, 5344.0, 5460.0, 5393.0, 5588.0, 5570.0, 5546.0, 5598.0, 5488.0, 5615.0, 5498.0, 5489.0, 5338.0, 5434.0, 5660.0, 5365.0, 5579.0, 5591.0, 5638.0, 5254.0, 5470.0, 5522.0, 5345.0, 5387.0, 5280.0, 5403.0, 5382.0, 5527.0, 5268.0, 5275.0, 5568.0, 5282.0, 5717.0, 5703.0, 5331.0, 5601.0, 5417.0, 5650.0, 5402.0, 5623.0, 5430.0, 5383.0, 5394.0, 5670.0, 5415.0, 5524.0, 5718.0, 5702.0, 5652.0, 5380.0, 5267.0, 5445.0, 5676.0, 5694.0, 5436.0, 5649.0, 5364.0, 5681.0, 5482.0, 5662.0, 5265.0, 5438.0, 5551.0, 5289.0, 5674.0, 5327.0 (number of hits: 11)
22	5270	9	1	333	1	5541.0, 5681.0, 5694.0, 5403.0, 5602.0, 5435.0, 5434.0, 5616.0, 5574.0, 5392.0, 5677.0, 5458.0, 5571.0, 5512.0, 5590.0, 5424.0, 5595.0, 5546.0, 5327.0, 5699.0, 5374.0, 5444.0, 5302.0, 5297.0, 5562.0, 5505.0, 5474.0, 5294.0, 5273.0, 5274.0, 5529.0, 5628.0, 5720.0, 5408.0, 5494.0, 5450.0, 5717.0, 5585.0, 5685.0, 5269.0, 5261.0, 5502.0, 5416.0, 5465.0, 5414.0, 5289.0, 5286.0, 5631.0, 5511.0, 5298.0, 5438.0, 5538.0, 5515.0, 5385.0, 5666.0, 5389.0, 5564.0, 5617.0, 5466.0, 5509.0, 5561.0, 5320.0, 5644.0, 5334.0, 5555.0, 5639.0, 5510.0, 5328.0, 5410.0, 5285.0, 5337.0, 5322.0, 5309.0, 5300.0, 5661.0, 5702.0, 5613.0, 5439.0, 5525.0, 5267.0, 5476.0, 5664.0, 5378.0, 5572.0, 5671.0, 5405.0, 5672.0, 5712.0, 5624.0, 5409.0, 5312.0, 5257.0, 5422.0, 5440.0, 5503.0, 5463.0, 5703.0, 5506.0, 5610.0, 5276.0 (number of hits: 10)
23	5270	9	1	333	1	5435.0, 5423.0, 5672.0, 5526.0, 5337.0, 5324.0, 5262.0, 5459.0, 5608.0, 5270.0, 5554.0, 5697.0, 5412.0, 5489.0, 5468.0, 5572.0, 5633.0, 5444.0, 5493.0, 5431.0, 5338.0, 5511.0, 5256.0, 5643.0, 5566.0,

						5401.0, 5579.0, 5611.0, 5508.0, 5630.0, 5372.0, 5283.0, 5478.0, 5375.0, 5492.0, 5419.0, 5364.0, 5696.0, 5271.0, 5467.0, 5379.0, 5580.0, 5567.0, 5306.0, 5439.0, 5466.0, 5413.0, 5297.0, 5442.0, 5593.0, 5632.0, 5267.0, 5545.0, 5521.0, 5497.0, 5294.0, 5664.0, 5512.0, 5685.0, 5454.0, 5474.0, 5570.0, 5616.0, 5691.0, 5513.0, 5400.0, 5473.0, 5465.0, 5628.0, 5547.0, 5530.0, 5609.0, 5418.0, 5288.0, 5703.0, 5449.0, 5583.0, 5515.0, 5302.0, 5482.0, 5615.0, 5282.0, 5527.0, 5441.0, 5334.0, 5709.0, 5280.0, 5715.0, 5596.0, 5417.0, 5562.0, 5712.0, 5693.0, 5421.0, 5415.0, 5414.0, 5425.0, 5377.0, 5640.0, 5507.0 (number of hits: 9)
24	5270	9	1	333	1	5371.0, 5710.0, 5705.0, 5355.0, 5315.0, 5625.0, 5515.0, 5589.0, 5347.0, 5346.0, 5715.0, 5604.0, 5386.0, 5649.0, 5612.0, 5472.0, 5358.0, 5454.0, 5490.0, 5354.0, 5331.0, 5573.0, 5345.0, 5437.0, 5291.0, 5712.0, 5608.0, 5640.0, 5523.0, 5285.0, 5259.0, 5266.0, 5252.0, 5626.0, 5408.0, 5551.0, 5435.0, 5463.0, 5564.0, 5464.0, 5670.0, 5611.0, 5562.0, 5273.0, 5594.0, 5711.0, 5425.0, 5672.0, 5598.0, 5653.0, 5567.0, 5356.0, 5410.0, 5373.0, 5327.0, 5309.0, 5512.0, 5510.0, 5387.0, 5593.0, 5527.0, 5671.0, 5390.0, 5714.0, 5474.0, 5456.0, 5287.0, 5665.0, 5446.0, 5645.0, 5706.0, 5384.0, 5278.0, 5481.0, 5469.0, 5416.0, 5621.0, 5404.0, 5678.0, 5545.0, 5623.0, 5307.0, 5682.0, 5572.0, 5529.0, 5303.0, 5535.0, 5703.0, 5378.0, 5409.0, 5440.0, 5615.0, 5701.0, 5352.0, 5458.0, 5575.0, 5362.0, 5388.0, 5351.0, 5556.0 (number of hits: 7)
25	5270	9	1	333	1	5611.0, 5670.0, 5387.0, 5385.0, 5277.0, 5493.0, 5315.0, 5382.0, 5583.0, 5612.0, 5666.0, 5283.0, 5427.0, 5270.0, 5450.0, 5603.0, 5638.0, 5470.0, 5594.0, 5544.0, 5318.0, 5600.0, 5620.0, 5618.0, 5677.0, 5260.0, 5345.0, 5584.0, 5703.0, 5404.0, 5464.0, 5543.0, 5645.0, 5711.0, 5403.0, 5628.0, 5384.0, 5303.0, 5327.0, 5716.0, 5261.0, 5469.0, 5370.0, 5651.0, 5325.0, 5698.0, 5656.0, 5672.0, 5305.0, 5591.0, 5444.0, 5562.0, 5289.0, 5596.0, 5536.0, 5290.0, 5448.0, 5494.0, 5321.0, 5424.0, 5426.0, 5477.0, 5291.0, 5344.0, 5712.0, 5710.0, 5480.0, 5486.0, 5602.0, 5721.0, 5266.0, 5515.0, 5316.0, 5573.0, 5714.0, 5446.0, 5275.0, 5407.0, 5722.0, 5664.0, 5601.0, 5399.0, 5585.0, 5637.0, 5613.0, 5478.0, 5462.0, 5354.0, 5520.0, 5377.0, 5542.0, 5320.0, 5312.0, 5356.0, 5349.0, 5718.0, 5660.0, 5554.0, 5659.0, 5549.0 (number of hits: 8)
26	5270	9	1	333	1	5479.0, 5631.0, 5550.0, 5707.0, 5290.0,

						5721.0, 5444.0, 5548.0, 5419.0, 5563.0, 5350.0, 5416.0, 5278.0, 5572.0, 5358.0, 5319.0, 5514.0, 5543.0, 5361.0, 5507.0, 5628.0, 5362.0, 5447.0, 5661.0, 5614.0, 5571.0, 5669.0, 5414.0, 5427.0, 5352.0, 5501.0, 5379.0, 5521.0, 5393.0, 5545.0, 5574.0, 5522.0, 5595.0, 5492.0, 5688.0, 5259.0, 5380.0, 5667.0, 5678.0, 5262.0, 5580.0, 5252.0, 5434.0, 5409.0, 5456.0, 5368.0, 5500.0, 5491.0, 5321.0, 5703.0, 5370.0, 5371.0, 5342.0, 5275.0, 5613.0, 5324.0, 5625.0, 5651.0, 5692.0, 5299.0, 5422.0, 5552.0, 5340.0, 5682.0, 5473.0, 5677.0, 5518.0, 5634.0, 5485.0, 5659.0, 5315.0, 5702.0, 5622.0, 5666.0, 5597.0, 5633.0, 5357.0, 5576.0, 5649.0, 5648.0, 5632.0, 5513.0, 5608.0, 5604.0, 5658.0, 5359.0, 5309.0, 5337.0, 5304.0, 5420.0, 5439.0, 5258.0, 5314.0, 5394.0, 5537.0 (number of hits: 6)
27	5270	9	1	333	1	5388.0, 5673.0, 5296.0, 5322.0, 5265.0, 5292.0, 5263.0, 5622.0, 5437.0, 5320.0, 5347.0, 5330.0, 5670.0, 5443.0, 5545.0, 5385.0, 5285.0, 5488.0, 5342.0, 5662.0, 5363.0, 5535.0, 5631.0, 5381.0, 5635.0, 5663.0, 5696.0, 5645.0, 5719.0, 5459.0, 5720.0, 5548.0, 5377.0, 5441.0, 5637.0, 5616.0, 5477.0, 5355.0, 5697.0, 5394.0, 5417.0, 5349.0, 5520.0, 5560.0, 5298.0, 5669.0, 5703.0, 5448.0, 5668.0, 5301.0, 5273.0, 5529.0, 5356.0, 5283.0, 5639.0, 5573.0, 5551.0, 5533.0, 5270.0, 5549.0, 5411.0, 5510.0, 5618.0, 5558.0, 5499.0, 5694.0, 5708.0, 5404.0, 5369.0, 5536.0, 5255.0, 5308.0, 5370.0, 5528.0, 5276.0, 5599.0, 5723.0, 5581.0, 5648.0, 5476.0, 5471.0, 5586.0, 5557.0, 5641.0, 5515.0, 5339.0, 5624.0, 5646.0, 5430.0, 5610.0, 5500.0, 5315.0, 5583.0, 5561.0, 5613.0, 5367.0, 5497.0, 5413.0, 5564.0, 5425.0 (number of hits: 8)
28	5270	9	1	333	1	5567.0, 5289.0, 5386.0, 5301.0, 5690.0, 5444.0, 5533.0, 5499.0, 5619.0, 5360.0, 5481.0, 5719.0, 5708.0, 5472.0, 5581.0, 5359.0, 5653.0, 5651.0, 5299.0, 5605.0, 5659.0, 5436.0, 5300.0, 5348.0, 5487.0, 5479.0, 5617.0, 5270.0, 5697.0, 5398.0, 5410.0, 5445.0, 5649.0, 5266.0, 5466.0, 5441.0, 5370.0, 5473.0, 5374.0, 5501.0, 5576.0, 5407.0, 5720.0, 5532.0, 5467.0, 5500.0, 5463.0, 5327.0, 5313.0, 5275.0, 5601.0, 5346.0, 5379.0, 5536.0, 5419.0, 5545.0, 5353.0, 5614.0, 5365.0, 5560.0, 5516.0, 5518.0, 5666.0, 5261.0, 5538.0, 5351.0, 5411.0, 5604.0, 5388.0, 5589.0, 5676.0, 5663.0, 5355.0, 5428.0, 5408.0, 5336.0, 5434.0, 5378.0, 5274.0, 5383.0, 5339.0, 5465.0, 5644.0, 5577.0, 5345.0, 5492.0, 5699.0, 5373.0, 5324.0, 5526.0

						5315.0, 5294.0, 5484.0, 5507.0, 5319.0, 5375.0, 5688.0, 5557.0, 5262.0, 5668.0 (number of hits: 7)
29	5270	9	1	333	1	5343.0, 5328.0, 5278.0, 5372.0, 5453.0, 5351.0, 5430.0, 5565.0, 5530.0, 5639.0, 5665.0, 5266.0, 5385.0, 5700.0, 5531.0, 5444.0, 5395.0, 5518.0, 5699.0, 5519.0, 5377.0, 5368.0, 5417.0, 5575.0, 5318.0, 5431.0, 5437.0, 5555.0, 5662.0, 5503.0, 5566.0, 5681.0, 5308.0, 5289.0, 5584.0, 5352.0, 5695.0, 5415.0, 5466.0, 5705.0, 5326.0, 5371.0, 5433.0, 5329.0, 5540.0, 5552.0, 5283.0, 5319.0, 5459.0, 5499.0, 5260.0, 5605.0, 5564.0, 5480.0, 5549.0, 5717.0, 5520.0, 5590.0, 5713.0, 5273.0, 5270.0, 5614.0, 5464.0, 5375.0, 5554.0, 5424.0, 5583.0, 5461.0, 5455.0, 5611.0, 5711.0, 5608.0, 5456.0, 5688.0, 5439.0, 5429.0, 5690.0, 5570.0, 5435.0, 5250.0, 5365.0, 5635.0, 5458.0, 5587.0, 5621.0, 5546.0, 5607.0, 5423.0, 5335.0, 5588.0, 5487.0, 5447.0, 5655.0, 5630.0, 5703.0, 5535.0, 5300.0, 5678.0, 5398.0, 5297.0 (number of hits: 8)
30	5270	9	1	333	1	5713.0, 5595.0, 5679.0, 5475.0, 5571.0, 5287.0, 5715.0, 5445.0, 5607.0, 5531.0, 5643.0, 5548.0, 5551.0, 5270.0, 5481.0, 5408.0, 5273.0, 5615.0, 5416.0, 5419.0, 5395.0, 5616.0, 5655.0, 5491.0, 5347.0, 5506.0, 5714.0, 5670.0, 5336.0, 5343.0, 5390.0, 5657.0, 5570.0, 5439.0, 5396.0, 5418.0, 5681.0, 5446.0, 5644.0, 5482.0, 5597.0, 5574.0, 5293.0, 5623.0, 5635.0, 5541.0, 5447.0, 5484.0, 5424.0, 5257.0, 5546.0, 5594.0, 5376.0, 5537.0, 5411.0, 5649.0, 5585.0, 5427.0, 5284.0, 5540.0, 5399.0, 5690.0, 5267.0, 5253.0, 5640.0, 5368.0, 5707.0, 5458.0, 5403.0, 5387.0, 5723.0, 5665.0, 5530.0, 5367.0, 5685.0, 5314.0, 5361.0, 5717.0, 5260.0, 5671.0, 5527.0, 5444.0, 5688.0, 5288.0, 5263.0, 5410.0, 5648.0, 5425.0, 5360.0, 5307.0, 5357.0, 5600.0, 5389.0, 5580.0, 5310.0, 5348.0, 5497.0, 5391.0, 5281.0, 5420.0 (number of hits: 11)

5550 MHz, 40 MHz Bandwidth

Radar Signal Type	Waveform/Trial Number	Detection (%)	Limit (%)	Pass/Fail
Type 1A/1B	30	100 %	60%	Pass
Type 2	30	100 %	60%	Pass
Type 3	30	100 %	60%	Pass
Type 4	30	100 %	60%	Pass
Aggregate (Type1 to 4)	120	100 %	80%	Pass
Type 5	30	100 %	80%	Pass
Type 6	30	100 %	70%	Pass

Please refer to the following statistical tables:

Table-1 Radar Type 1A/1B Statistical Performance

Trial #	Fc (MHz)	Pulse/Burst	Pulse Width (μS)	PRI (μs)	Detection (1:yes; 0:no)
1	5550	72	1	738	1
2	5550	74	1	718	1
3	5550	65	1	818	1
4	5550	95	1	558	1
5	5550	102	1	518	1
6	5550	57	1	938	1
7	5550	67	1	798	1
8	5550	68	1	778	1
9	5550	78	1	678	1
10	5550	83	1	638	1
11	5550	58	1	918	1
12	5550	62	1	858	1
13	5550	61	1	878	1
14	5550	76	1	698	1
15	5550	86	1	618	1
16	5550	21	1	2536	1
17	5550	36	1	1487	1
18	5550	21	1	2534	1
19	5550	36	1	1470	1
20	5550	18	1	2994	1
21	5550	58	1	910	1
22	5550	46	1	1159	1
23	5550	35	1	1544	1
24	5550	24	1	2288	1
25	5550	19	1	2863	1
26	5550	24	1	2235	1
27	5550	18	1	3049	1
28	5550	30	1	1802	1
29	5550	28	1	1917	1
30	5550	24	1	2271	1
Detection Percentage: 100 % (>60%)					

Table-2 Radar Type 2 Statistical Performance

Trial #	Fc (MHz)	Pulse/Burst	Pulse Width (μS)	PRI (μs)	Detection (1:yes; 0:no)
1	5550	25	3.7	197	1
2	5550	27	2.7	185	1
3	5550	23	3.8	164	1
4	5550	27	4.6	224	1
5	5550	28	2.7	173	1
6	5550	24	3.1	199	1
7	5550	27	4.1	160	1
8	5550	29	1.8	213	1
9	5550	23	2.3	179	1
10	5550	29	1.1	154	1
11	5550	29	1.3	153	1
12	5550	24	2.8	223	1
13	5550	27	1.5	174	1
14	5550	23	2.1	170	1
15	5550	27	3.2	189	1
16	5550	27	4.3	160	1
17	5550	28	4.7	210	1
18	5550	27	2.5	229	1
19	5550	23	3.8	204	1
20	5550	25	3.8	182	1
21	5550	26	2.1	222	1
22	5550	28	2.2	159	1
23	5550	25	1.7	210	1
24	5550	27	1.6	207	1
25	5550	25	2	192	1
26	5550	24	1.7	155	1
27	5550	27	2.9	204	1
28	5550	24	3.6	179	1
29	5550	25	1.8	183	1
30	5550	29	4.6	230	1
Detection Percentage: 100 % (>60%)					

Table-3 Radar Type 3 Statistical Performance

Trial #	Fc (MHz)	Pulse/Burst	Pulse Width (μS)	PRI (μs)	Detection (1:yes; 0:no)
1	5550	18	7.1	382	1
2	5550	16	6.2	433	1
3	5550	16	7.2	389	1
4	5550	16	7.2	420	1
5	5550	18	9.4	423	1
6	5550	18	7.4	239	1
7	5550	18	7.9	222	1
8	5550	17	8.2	401	1
9	5550	16	6.9	392	1
10	5550	16	6.4	440	1
11	5550	16	8.4	338	1
12	5550	18	7.4	249	1
13	5550	17	8.4	364	1
14	5550	18	6.6	243	1
15	5550	17	6.5	287	1
16	5550	16	6.8	294	1
17	5550	16	8.9	459	1
18	5550	18	9.2	246	1
19	5550	16	7.9	288	1
20	5550	17	8.1	325	1
21	5550	17	8.7	235	1
22	5550	16	7.4	374	1
23	5550	17	7.3	463	1
24	5550	17	6.9	212	1
25	5550	16	9.1	317	1
26	5550	16	6.6	344	1
27	5550	17	7.9	380	1
28	5550	18	8.1	425	1
29	5550	16	6.3	264	1
30	5550	16	8.4	242	1
Detection Percentage: 100 % (>60%)					

Table-4 Radar Type 4 Statistical Performance

Trial #	Fc (MHz)	Pulse/Burst	Pulse Width (µS)	PRI (µs)	Detection (1:yes; 0:no)
1	5550	14	19.5	471	1
2	5550	15	19.4	280	1
3	5550	14	13.4	482	1
4	5550	16	16.6	304	1
5	5550	13	19.4	223	1
6	5550	15	12.9	267	1
7	5550	13	15.1	482	1
8	5550	13	12.5	387	1
9	5550	14	12.2	379	1
10	5550	14	19.8	275	1
11	5550	15	14.3	450	1
12	5550	16	11.5	362	1
13	5550	15	19.2	443	1
14	5550	15	16.1	472	1
15	5550	15	19.2	325	1
16	5550	16	19.8	309	1
17	5550	12	17.8	348	1
18	5550	14	12.9	471	1
19	5550	15	11.3	365	1
20	5550	15	11.5	415	1
21	5550	14	14.7	463	1
22	5550	15	13	416	1
23	5550	16	19.6	466	1
24	5550	16	18.6	489	1
25	5550	14	15.4	434	1
26	5550	14	18.1	320	1
27	5550	13	13.6	451	1
28	5550	13	15.3	480	1
29	5550	13	19	205	1
30	5550	12	14.5	224	1
Detection Percentage: 100 % (>60%)					

Table-5 Radar Type 5 Statistical Performance

Bin5 Statistics 1

CF=5549MHz

Trial #	Pulse	Chirp (MHz)	Pulse Width (µS)	Pulse 1-2 spacing (µS)	Pulse 2-3 spacing (µS)	Pulse Start(S)	Detection (1:yes; 0:no)
0	2	8	76.5	1090		0.633035	1
1	1	10	69.6			1.413765	
2	2	11	81.4	1773		1.67737	
3	2	15	77.8	1669		2.44792	
4	2	14	75.6	1332		3.237919	
5	3	13	57.5	1642	1860	4.185574	
6	2	17	53.8	1630		5.18368	
7	2	6	52.9	1117		5.68653	
8	2	15	59.4	1506		6.45955	
9	1	11	76.2			6.925132	
10	2	9	75.1	1316		7.824848	
11	2	13	77.3	1326		8.944273	
12	3	14	70.3	1407	1052	9.07454	
13	2	6	76.8	1289		10.387638	
14	2	8	63.4	1891		10.871857	
15	3	16	55.1	1704	1743	11.738438	

Bin5 Statistics 2

CF=5556MHz

Trial #	Pulse	Chirp (MHz)	Pulse Width (µS)	Pulse 1-2 spacing (uS)	Pulse 2-3 spacing (uS)	Pulse Start(S)	Detection (1:yes; 0:no)
0	2	11	64.1	1512		0.133995	1
1	2	8	61.8	1423		1.183172	
2	1	9	96.5			2.123408	
3	3	16	77.7	1778	1134	3.529175	
4	2	8	54.6	1890		4.414148	
5	2	16	88.5	1928		5.051527	
6	3	12	56.4	1598	1322	6.165476	
7	2	18	56.8	1992		6.627208	
8	1	7	75.7			8.10147	
9	3	12	88.7	1896	1696	9.144669	
10	2	7	87.2	1116		9.799785	
11	1	14	79.3			10.665352	
12	3	13	64.6	1705	1252	11.291705	

Bin5 Statistics 3

CF=5534MHz

Trial #	Pulse	Chirp (MHz)	Pulse Width (µS)	Pulse 1-2 spacing (uS)	Pulse 2-3 spacing (uS)	Pulse Start(S)	Detection (1:yes; 0:no)
0	3	8	60.3	1264	1851	0.530962	1
1	2	10	98.6	1663		1.383919	
2	2	15	66.9	1664		1.626414	
3	2	19	50.6	1857		3.160198	
4	2	9	71.4	1783		3.311752	
5	2	18	65.4	1724		4.340802	
6	1	14	65.7			5.165007	
7	2	10	51.9	1126		5.832288	
8	1	13	58			6.742021	
9	3	8	51.8	1518	1165	7.85368	
10	2	13	55.8	1949		8.322937	
11	2	8	91.9	1962		9.529768	
12	2	12	62	1541		9.849571	
13	3	12	71	1287	1987	10.563895	
14	2	5	93.4	1764		11.60674	

Bin5 Statistics 4

CF=5540MHz

Trial #	Pulse	Chirp (MHz)	Pulse Width (µS)	Pulse 1-2 spacing (µS)	Pulse 2-3 spacing (µS)	Pulse Start(S)	Detection (1:yes; 0:no)
0	3	20	63	1034	1936	0.874926	1
1	1	5	88.1			1.374904	
2	2	18	62.9	1845		3.750146	
3	3	14	63.8	1193	1969	4.386328	
4	2	13	93	1063		6.194963	
5	3	19	67.7	1588	1426	7.784192	
6	2	17	61.6	1634		8.729912	
7	2	9	55.4	1303		9.784211	
8	2	11	50.6	1274		11.276871	

Bin5 Statistics 5

CF=5555MHz

Trial #	Pulse	Chirp (MHz)	Pulse Width (µS)	Pulse 1-2 spacing (µS)	Pulse 2-3 spacing (µS)	Pulse Start(S)	Detection (1:yes; 0:no)
0	3	12	71.4	1989	1112	0.023717	1
1	3	15	67.4	1069	1715	0.883237	
2	3	7	80	1756	1881	1.79039	
3	1	14	81.6			2.183124	
4	2	14	84	1450		2.939822	
5	2	20	52.7	1368		3.767155	
6	2	11	64.9	1866		4.121744	
7	3	10	98.2	1006	1993	4.894419	
8	2	9	61.6	1787		5.773408	
9	3	17	90.3	1543	1981	6.408635	
10	2	14	54.3	1297		7.251001	
11	2	8	74.4	1947		7.710663	
12	3	6	70	1276	1137	8.594144	
13	2	6	50.5	1033		8.97959	
14	3	16	57.9	1374	1320	9.548114	
15	2	15	56.2	1741		10.176245	
16	1	9	85.1			10.732369	
17	2	14	79.7	1327		11.388604	

Bin5 Statistics 6

CF=5542MHz

Trial #	Pulse	Chirp (MHz)	Pulse Width (µS)	Pulse 1-2 spacing (uS)	Pulse 2-3 spacing (uS)	Pulse Start(S)	Detection (1:yes; 0:no)
0	2	14	88.9	1749		0.256188	1
1	2	19	73.3	1609		1.627126	
2	2	18	70.7	1039		2.202684	
3	1	14	51			3.152002	
4	3	10	57.3	1791	1040	4.549445	
5	2	15	90.5	1548		5.320046	
6	2	5	62.1	1436		6.356411	
7	1	15	61.3			7.021336	
8	3	8	68.7	1069	1279	8.194123	
9	2	15	75	1638		8.71612	
10	3	16	75.5	1730	1235	9.434654	
11	2	15	95.1	1506		10.746918	
12	3	19	88.9	1081	1389	11.649149	

Bin5 Statistics 7

CF=5554MHz

Trial #	Pulse	Chirp (MHz)	Pulse Width (µS)	Pulse 1-2 spacing (µS)	Pulse 2-3 spacing (µS)	Pulse Start(S)	Detection (1:yes; 0:no)
0	3	13	85.2	1691	1355	0.223878	1
1	2	10	84.7	1850		0.803908	
2	2	9	86.2	1296		1.673194	
3	3	8	95.3	1193	1207	2.20015	
4	1	16	93.5			2.85511	
5	2	11	55	1833		3.543857	
6	3	9	92.2	1195	1503	4.142525	
7	1	12	57.7			5.26865	
8	2	12	58.5	1888		5.854104	
9	3	15	91.7	1988	1680	6.02122	
10	3	10	96.6	1726	1154	6.832608	
11	2	17	89.1	1968		7.859443	
12	2	8	51.1	1580		8.594213	
13	2	17	58	1237		8.831844	
14	3	18	56.9	1081	1514	9.498142	
15	3	11	94.4	1398	1342	10.207013	
16	2	16	70	1756		11.064863	
17	2	9	85.4	1569		11.433347	

Bin5 Statistics 8

CF=5547MHz

Trial #	Pulse	Chirp (MHz)	Pulse Width (µS)	Pulse 1-2 spacing (uS)	Pulse 2-3 spacing (uS)	Pulse Start(S)	Detection (1:yes; 0:no)
0	2	17	85.7	1053		0.131504	1
1	2	18	69.1	1376		1.175606	
2	2	5	81.3	1978		1.643453	
3	3	18	59.7	1114	1662	3.018051	
4	2	15	60.4	1297		3.298088	
5	2	6	62.2	1186		4.458143	
6	1	15	73.3			5.369144	
7	2	11	57.7	1476		6.368911	
8	3	11	66.5	1415	1435	7.04501	
9	1	13	50.8			7.839157	
10	1	16	93.3			8.321568	
11	2	11	54.4	1549		8.804385	
12	1	7	79.4			10.071927	
13	2	15	80.6	1654		10.569676	
14	3	16	58.9	1759	1708	11.304602	

Bin5 Statistics 9

CF=5539MHz

Trial #	Pulse	Chirp (MHz)	Pulse Width (µS)	Pulse 1-2 spacing (uS)	Pulse 2-3 spacing (uS)	Pulse Start(S)	Detection (1:yes; 0:no)
0	2	19	80.3	1429		0.545178	1
1	1	6	67.1			0.843729	
2	2	5	98.8	1035		1.917992	
3	2	19	83	1198		2.308859	
4	2	11	96	1249		2.948935	
5	2	11	61.4	1424		3.686168	
6	2	12	74.7	1450		4.532585	
7	2	10	79.5	1565		4.773367	
8	3	13	84.9	1341	1235	5.558417	
9	3	19	64.4	1658	1758	6.491697	
10	3	11	64.1	1272	1910	6.674484	
11	2	15	57.3	1199		7.417994	
12	2	8	88.1	1193		8.255436	
13	1	13	59.1			9.013269	
14	2	10	95.5	1948		9.607089	
15	2	8	86	1023		10.43855	
16	2	6	71.3	1294		10.897028	
17	1	7	98.7			11.802671	

Bin5 Statistics 10

CF=5532MHz

Trial #	Pulse	Chirp (MHz)	Pulse Width (µS)	Pulse 1-2 spacing (uS)	Pulse 2-3 spacing (uS)	Pulse Start(S)	Detection (1:yes; 0:no)
0	2	7	75.1	1275		0.510185	1
1	2	10	70	1705		1.928641	
2	1	6	73.2			3.071603	
3	3	15	84.7	1298	1744	4.632455	
4	2	18	92.7	1699		5.697634	
5	1	6	56.2			6.952961	
6	3	7	62.6	1261	1329	8.298893	
7	2	19	90.3	1013		9.411507	
8	2	20	83.7	1648		11.215346	

Bin5 Statistics 11

CF=5541MHz

Trial #	Pulse	Chirp (MHz)	Pulse Width (µS)	Pulse 1-2 spacing (uS)	Pulse 2-3 spacing (uS)	Pulse Start(S)	Detection (1:yes; 0:no)
0	2	6	84.2	1135		0.396885	1
1	2	16	96.6	1054		1.722208	
2	3	15	62.5	1342	1249	2.71027	
3	3	16	72.8	1706	1098	3.167076	
4	2	9	86.1	1341		3.881032	
5	1	15	66.6			4.780995	
6	3	13	77	1736	1378	5.923836	
7	2	11	86.6	1816		6.855885	
8	2	17	98.2	1929		7.39513	
9	2	14	79.9	1693		8.916597	
10	2	15	86.6	1330		9.359588	
11	2	6	67	1711		10.987388	
12	1	8	82.3			11.937905	

Bin5 Statistics 12

CF=5557MHz

Trial #	Pulse	Chirp (MHz)	Pulse Width (µS)	Pulse 1-2 spacing (uS)	Pulse 2-3 spacing (uS)	Pulse Start(S)	Detection (1:yes; 0:no)
0	3	10	76.1	1768	1642	0.527787	1
1	2	5	82.9	1887		1.240889	
2	1	16	84.3			2.279132	
3	2	17	58.2	1470		3.342501	
4	1	17	85.8			3.937765	
5	2	14	66	1890		5.374346	
6	1	8	69.7			6.00393	
7	2	12	62	1831		7.161205	
8	2	8	62.2	1059		7.548595	
9	3	20	96.8	1584	1832	8.916271	
10	2	14	57.2	1472		9.446757	
11	1	18	77.6			10.386467	
12	1	14	87.2			11.300208	

Bin5 Statistics 13

CF=5548MHz

Trial #	Pulse	Chirp (MHz)	Pulse Width (µS)	Pulse 1-2 spacing (uS)	Pulse 2-3 spacing (uS)	Pulse Start(S)	Detection (1:yes; 0:no)
0	2	5	74.1	1370		0.386272	1
1	3	7	87.9	1781	1928	1.412422	
2	1	7	71.1			2.549689	
3	1	17	55.1			3.099695	
4	2	15	67.6	1943		3.873155	
5	1	18	98			4.941977	
6	2	11	93.3	1103		5.231935	
7	2	20	85.1	1963		6.046897	
8	3	17	98	1215	1630	7.270941	
9	2	11	84.4	1633		7.876447	
10	2	8	86.3	1983		9.062835	
11	2	12	93.9	1341		9.880588	
12	2	14	97.3	1877		10.989299	
13	2	9	98.9	1669		11.637849	

Bin5 Statistics 14

CF=5542MHz

Trial #	Pulse	Chirp (MHz)	Pulse Width (µS)	Pulse 1-2 spacing (uS)	Pulse 2-3 spacing (uS)	Pulse Start(S)	Detection (1:yes; 0:no)
0	2	13	53.6	1207		0.669785	1
1	2	12	90.5	1737		1.694828	
2	2	12	81	1358		3.097318	
3	2	19	88.7	1259		4.150226	
4	1	9	66.3			4.587174	
5	2	6	86.9	1209		6.079184	
6	3	16	51.7	1007	1564	6.879708	
7	2	11	69.8	1845		7.859295	
8	3	13	51.1	1920	1491	9.069775	
9	3	11	68.3	1891	1634	10.468883	
10	3	9	53.1	1184	1717	11.68257	

Bin5 Statistics 15

CF=5544MHz

Trial #	Pulse	Chirp (MHz)	Pulse Width (µS)	Pulse 1-2 spacing (uS)	Pulse 2-3 spacing (uS)	Pulse Start(S)	Detection (1:yes; 0:no)
0	2	17	80.3	1005		0.152061	1
1	2	20	59.6	1494		0.94787	
2	1	15	97.9			2.259275	
3	2	7	91.8	1435		2.926722	
4	2	12	57.3	1989		3.766664	
5	2	13	74.5	1577		4.578903	
6	2	9	53.5	1918		5.942659	
7	3	11	75.7	1021	1704	6.149109	
8	2	18	81.5	1275		7.60066	
9	2	14	84.2	1712		8.342915	
10	3	20	54.4	1903	1413	9.027919	
11	2	6	92	1588		9.71685	
12	1	9	70			10.455695	
13	1	5	83.3			11.201644	

Bin5 Statistics 16

CF=5537MHz

Trial #	Pulse	Chirp (MHz)	Pulse Width (µS)	Pulse 1-2 spacing (uS)	Pulse 2-3 spacing (uS)	Pulse Start(S)	Detection (1:yes; 0:no)
0	3	8	82.8	1362	1603	0.384382	1
1	2	6	75.8	1716		1.183969	
2	3	9	92.2	1978	1789	2.283273	
3	2	16	79.6	1979		3.367894	
4	1	11	82.8			4.555355	
5	2	9	85.8	1830		5.336529	
6	3	8	55.7	1725	1560	6.425818	
7	1	12	78.9			6.735372	
8	2	18	89.3	1281		8.166598	
9	2	5	62.7	1579		9.165968	
10	2	14	98.2	1497		10.096968	
11	2	6	52.4	1524		10.765202	
12	2	11	71.4	1556		11.751105	

Bin5 Statistics 17

CF=5552MHz

Trial #	Pulse	Chirp (MHz)	Pulse Width (µS)	Pulse 1-2 spacing (uS)	Pulse 2-3 spacing (uS)	Pulse Start(S)	Detection (1:yes; 0:no)
0	2	11	68.4	1651		0.619038	1
1	3	13	54.9	1293	1164	0.835558	
2	2	18	88	1418		1.996126	
3	1	9	94.8			2.648801	
4	1	18	80.1			2.990918	
5	2	17	84.5	1002		4.147834	
6	2	7	70.1	1035		4.479495	
7	2	14	52.7	1842		5.293174	
8	3	13	68.8	1552	1756	5.69911	
9	2	19	98.3	1067		6.563854	
10	2	10	67.3	1990		7.15532	
11	3	17	67.4	1630	1533	8.35914	
12	2	15	90.2	1188		8.967905	
13	3	18	61	1168	1195	9.3429	
14	2	14	66	1269		9.937619	
15	3	6	81.9	1649	1836	11.042219	
16	1	6	89.3			11.993201	

Bin5 Statistics 18

CF=5547MHz

Trial #	Pulse	Chirp (MHz)	Pulse Width (µS)	Pulse 1-2 spacing (uS)	Pulse 2-3 spacing (uS)	Pulse Start(S)	Detection (1:yes; 0:no)
0	2	8	71.3	1269		0.299453	1
1	3	9	78.7	1478	1852	1.218137	
2	2	16	92.1	1551		2.288708	
3	1	5	81.7			3.174157	
4	1	8	73.3			4.218916	
5	1	14	91.1			4.776779	
6	3	17	80.3	1542	1889	5.408856	
7	1	16	50.1			6.467566	
8	2	10	94	1160		7.208968	
9	2	9	88.6	1094		7.774361	
10	2	16	92.1	1555		8.930724	
11	1	8	55.8			10.051379	
12	3	5	67.2	1585	1610	10.367019	
13	2	16	72.4	1581		11.726029	

Bin5 Statistics 19

CF=5542MHz

Trial #	Pulse	Chirp (MHz)	Pulse Width (µS)	Pulse 1-2 spacing (uS)	Pulse 2-3 spacing (uS)	Pulse Start(S)	Detection (1:yes; 0:no)
0	1	17	82.6			0.221936	1
1	3	12	83.3	1597	1634	0.74957	
2	3	11	93.7	1797	1777	1.593758	
3	1	11	51			2.556401	
4	1	9	53.3			3.370373	
5	2	8	66.2	1018		4.001121	
6	1	20	64.7			4.807242	
7	2	13	68.1	1926		5.29127	
8	1	15	70.9			6.109663	
9	1	19	64.8			6.979385	
10	1	7	74.4			7.412276	
11	2	13	86.6	1101		7.806402	
12	1	19	77.1			8.858053	
13	2	16	69.1	1219		9.659025	
14	1	15	70.6			10.308758	
15	2	6	93	1598		10.952867	
16	1	7	57.8			11.427796	

Bin5 Statistics 20

CF=5557MHz

Trial #	Pulse	Chirp (MHz)	Pulse Width (µS)	Pulse 1-2 spacing (uS)	Pulse 2-3 spacing (uS)	Pulse Start(S)	Detection (1:yes; 0:no)
0	2	12	97.4	1281		0.915849	1
1	1	20	80.3			1.18937	
2	1	6	97.8			1.993944	
3	1	7	61.5			3.39088	
4	3	6	95.7	1843	1209	3.752795	
5	1	18	66.4			4.65461	
6	1	16	64.6			5.779918	
7	1	16	50.8			7.070396	
8	3	19	66.3	1586	1712	7.597216	
9	2	15	91.3	1442		8.989864	
10	3	18	97.8	1388	1397	9.631341	
11	3	12	61.7	1868	1808	10.461006	
12	2	14	58.1	1667		11.709587	

Bin5 Statistics 21

CF=5547MHz

Trial #	Pulse	Chirp (MHz)	Pulse Width (µS)	Pulse 1-2 spacing (uS)	Pulse 2-3 spacing (uS)	Pulse Start(S)	Detection (1:yes; 0:no)
0	3	20	57.9	1554	1071	0.214788	1
1	1	13	79.9			1.150268	
2	2	8	64.1	1218		2.32583	
3	2	9	68	1171		2.813023	
4	3	8	54.1	1165	1982	3.584702	
5	2	13	64.8	1494		4.409845	
6	3	14	66.6	1825	1720	5.432436	
7	2	16	73.5	1021		6.175991	
8	3	12	97.2	1498	1913	7.15236	
9	3	18	51.1	1225	1910	7.322203	
10	3	10	64	1499	1778	8.21907	
11	2	19	73.4	1841		8.846616	
12	1	14	56.3			10.379865	
13	2	14	97.4	1960		11.025693	
14	3	19	73.4	1670	1718	11.232606	

Bin5 Statistics 22

CF=5533MHz

Trial #	Pulse	Chirp (MHz)	Pulse Width (µS)	Pulse 1-2 spacing (uS)	Pulse 2-3 spacing (uS)	Pulse Start(S)	Detection (1:yes; 0:no)
0	1	10	86.9			0.372305	1
1	1	14	84.2			1.401388	
2	2	15	90.3	1070		3.650835	
3	3	5	62.1	1142	1895	4.196913	
4	1	17	61.9			6.245322	
5	2	13	90.6	1940		6.912914	
6	2	9	67.2	1430		8.181739	
7	2	12	85.4	1523		9.910585	
8	3	9	70.8	1909	1322	10.970354	

Bin5 Statistics 23

CF=5538MHz

Trial #	Pulse	Chirp (MHz)	Pulse Width (µS)	Pulse 1-2 spacing (uS)	Pulse 2-3 spacing (uS)	Pulse Start(S)	Detection (1:yes; 0:no)
0	2	12	66.9	1811		0.111807	1
1	2	11	68.2	1101		1.239324	
2	1	10	93.4			1.954508	
3	2	10	66.6	1637		2.485349	
4	1	12	55.3			2.689709	
5	1	14	65.5			3.978927	
6	2	6	62.4	1986		4.618948	
7	2	6	61.6	1748		4.862124	
8	2	10	69.4	1171		5.892006	
9	3	7	79.7	1689	1070	6.255187	
10	2	9	87.8	1217		6.93463	
11	2	7	66.3	1674		7.392189	
12	3	10	93.5	1128	1184	8.360993	
13	3	16	85.6	1851	1625	8.844549	
14	2	14	64.7	1306		9.974632	
15	2	13	97.8	1081		10.14149	
16	1	8	87.9			10.819704	
17	2	13	79.7	1838		11.343252	

Bin5 Statistics 24

CF=5539MHz

Trial #	Pulse	Chirp (MHz)	Pulse Width (µS)	Pulse 1-2 spacing (uS)	Pulse 2-3 spacing (uS)	Pulse Start(S)	Detection (1:yes; 0:no)
0	2	9	81	1542		0.315683	1
1	3	8	70.6	1390	1766	1.384475	
2	2	16	56.4	1047		2.869475	
3	2	16	89.3	1208		3.688517	
4	2	15	79.6	1136		4.835975	
5	1	6	97.9			5.813274	
6	3	15	64.2	1035	1392	6.668411	
7	3	12	98.4	1715	1146	7.920597	
8	2	13	75.9	1960		8.258358	
9	3	14	80.4	1829	1924	9.746226	
10	3	8	91.1	1171	1432	10.305703	
11	2	13	67.7	1077		11.352167	

Bin5 Statistics 25

CF=5544MHz

Trial #	Pulse	Chirp (MHz)	Pulse Width (µS)	Pulse 1-2 spacing (uS)	Pulse 2-3 spacing (uS)	Pulse Start(S)	Detection (1:yes; 0:no)
0	3	13	89.4	1518	1627	0.050817	1
1	2	13	54.1	1418		1.013417	
2	1	12	85.8			1.613699	
3	1	9	64.5			2.103949	
4	2	12	63.9	1356		2.776679	
5	2	11	68.6	1264		3.563045	
6	3	11	69.8	1243	1901	3.835909	
7	1	18	77			4.291401	
8	2	14	90.4	1363		5.334165	
9	3	17	81.2	1534	1754	5.500533	
10	3	6	91.6	1388	1746	6.548243	
11	1	19	87.4			6.706641	
12	1	14	80			7.528062	
13	1	10	67.4			8.032282	
14	1	8	83.1			8.870647	
15	2	7	93.4	1999		9.339507	
16	2	19	92.8	1840		9.703443	
17	2	5	98.2	1012		10.385552	
18	2	12	73.6	1496		10.888097	
19	2	6	68.7	1055		11.459815	

Bin5 Statistics 26

CF=5537MHz

Trial #	Pulse	Chirp (MHz)	Pulse Width (µS)	Pulse 1-2 spacing (uS)	Pulse 2-3 spacing (uS)	Pulse Start(S)	Detection (1:yes; 0:no)
0	2	8	83.4	1986		0.901049	1
1	3	18	52.3	1806	1001	1.565993	
2	1	8	97.8			2.705762	
3	2	10	53.6	1102		4.514459	
4	1	14	55.5			6.354467	
5	2	12	52.6	1220		7.929073	
6	3	19	91.5	1879	1992	9.008209	
7	1	18	53.4			10.489063	
8	2	14	58.9	1647		11.63623	

Bin5 Statistics 27

CF=5542MHz

Trial #	Pulse	Chirp (MHz)	Pulse Width (µS)	Pulse 1-2 spacing (uS)	Pulse 2-3 spacing (uS)	Pulse Start(S)	Detection (1:yes; 0:no)
0	2	8	98.8	1722		0.448374	1
1	2	11	53.8	1912		1.197806	
2	1	19	89.8			1.747768	
3	1	8	97.9			2.370885	
4	1	5	65.8			3.595356	
5	2	19	78.6	1715		4.331436	
6	3	9	86.4	1891	1712	4.691498	
7	3	15	54.4	1993	1296	5.959339	
8	3	15	75.2	1925	1753	6.452805	
9	2	6	51	1955		7.418532	
10	1	7	90.8			8.089291	
11	2	11	74	1016		8.701822	
12	2	18	92.3	1409		9.099816	
13	1	19	89.3			9.965652	
14	1	6	55.2			10.846218	
15	3	9	80.6	1335	1287	11.493027	

Bin5 Statistics 28

CF=5557MHz

Trial #	Pulse	Chirp (MHz)	Pulse Width (µS)	Pulse 1-2 spacing (uS)	Pulse 2-3 spacing (uS)	Pulse Start(S)	Detection (1:yes; 0:no)
0	2	5	62.1	1865		0.778574	1
1	2	18	61.4	1028		2.48288	
2	1	16	55.1			3.47601	
3	2	9	79.5	1115		4.999739	
4	2	19	66.9	1529		7.206038	
5	1	15	97.3			8.124757	
6	2	12	50.6	1837		10.293939	
7	3	18	94	1111	1616	11.741805	

Bin5 Statistics 29

CF=5542MHz

Trial #	Pulse	Chirp (MHz)	Pulse Width (µS)	Pulse 1-2 spacing (uS)	Pulse 2-3 spacing (uS)	Pulse Start(S)	Detection (1:yes; 0:no)
0	1	18	61.2			0.631132	1
1	2	10	82.5	1216		1.129071	
2	1	7	50.6			2.206708	
3	3	19	57.2	1525	1643	4.179551	
4	1	17	66.6			4.918325	
5	3	18	95.9	1604	1702	5.998028	
6	2	12	72.8	1100		7.383497	
7	1	17	87.4			8.666048	
8	1	19	69.6			8.750266	
9	1	8	62.5			10.081805	
10	2	6	99.6	1168		11.976208	

Bin5 Statistics 30

CF=5545MHz

Trial #	Pulse	Chirp (MHz)	Pulse Width (µS)	Pulse 1-2 spacing (uS)	Pulse 2-3 spacing (uS)	Pulse Start(S)	Detection (1:yes; 0:no)
0	2	7	81.7	1328		1.072145	1
1	2	12	68.6	1485		1.644052	
2	3	6	64.4	1121	1292	2.422452	
3	2	17	58.7	1344		4.718344	
4	3	15	65.5	1739	1581	5.450266	
5	1	7	90.9			6.74372	
6	2	7	72.8	1278		7.256487	
7	2	8	85.8	1993		8.796005	
8	3	13	89.2	1382	1376	10.336886	
9	3	7	80.9	1034	1845	11.426388	

Table-6 Radar Type 6 Statistical Performance

Trial #	Fc (MHz)	Pulse /Burst	Pulse Width (µS)	PRI (µs)	Detection (1:yes; 0:no)	Hopping Sequence
1	5550	9	1	333	1	5419.0, 5386.0, 5519.0, 5288.0, 5441.0, 5449.0, 5643.0, 5277.0, 5472.0, 5471.0, 5255.0, 5724.0, 5523.0, 5638.0, 5680.0, 5621.0, 5713.0, 5532.0, 5535.0, 5595.0, 5717.0, 5410.0, 5600.0, 5709.0, 5251.0, 5682.0, 5565.0, 5335.0, 5707.0, 5696.0, 5478.0, 5594.0, 5517.0, 5306.0, 5322.0, 5644.0, 5658.0, 5461.0, 5391.0, 5412.0, 5613.0, 5342.0, 5317.0, 5480.0, 5339.0, 5296.0, 5690.0, 5678.0, 5451.0, 5542.0, 5530.0, 5581.0, 5501.0, 5537.0, 5367.0, 5402.0, 5259.0, 5681.0, 5604.0, 5516.0, 5385.0, 5404.0, 5313.0, 5634.0, 5344.0, 5504.0, 5358.0, 5642.0, 5509.0, 5439.0, 5515.0, 5563.0, 5365.0, 5549.0, 5647.0, 5370.0, 5586.0, 5691.0, 5398.0, 5662.0, 5434.0, 5270.0, 5340.0, 5499.0, 5422.0, 5640.0, 5545.0, 5331.0, 5573.0, 5436.0, 5654.0, 5293.0, 5505.0, 5649.0, 5528.0, 5677.0, 5261.0, 5633.0, 5323.0, 5303.0 (number of hits: 9)
2	5550	9	1	333	1	5365.0, 5676.0, 5503.0, 5680.0, 5372.0, 5621.0, 5346.0, 5493.0, 5328.0, 5683.0, 5314.0, 5452.0, 5378.0, 5659.0, 5623.0, 5428.0, 5425.0, 5691.0, 5414.0, 5432.0, 5598.0, 5545.0, 5376.0, 5488.0, 5569.0, 5475.0, 5675.0, 5409.0, 5383.0, 5334.0, 5347.0, 5447.0, 5382.0, 5288.0, 5631.0, 5708.0, 5698.0, 5590.0, 5485.0, 5333.0, 5342.0, 5341.0, 5699.0, 5674.0, 5303.0, 5331.0, 5681.0, 5502.0, 5667.0, 5407.0, 5478.0, 5652.0, 5440.0, 5653.0, 5352.0, 5419.0, 5578.0, 5711.0, 5438.0, 5339.0, 5258.0, 5263.0, 5392.0, 5673.0, 5323.0, 5471.0, 5513.0, 5695.0, 5301.0, 5591.0, 5701.0, 5624.0, 5355.0, 5469.0, 5534.0, 5384.0, 5291.0, 5357.0, 5533.0, 5404.0, 5526.0, 5497.0, 5286.0, 5379.0, 5692.0, 5688.0, 5508.0, 5658.0, 5402.0, 5359.0, 5283.0, 5723.0, 5259.0, 5281.0, 5521.0, 5468.0, 5510.0, 5536.0, 5518.0, 5568.0 (number of hits: 6)
3	5550	9	1	333	1	5523.0, 5398.0, 5521.0, 5314.0, 5526.0, 5400.0, 5706.0, 5485.0, 5365.0, 5570.0, 5554.0, 5275.0, 5597.0, 5252.0, 5469.0, 5527.0, 5697.0, 5357.0, 5642.0, 5406.0, 5274.0, 5315.0, 5295.0, 5619.0, 5555.0, 5672.0, 5401.0, 5640.0, 5253.0, 5699.0, 5514.0, 5505.0, 5635.0, 5535.0, 5538.0, 5717.0, 5316.0, 5524.0, 5688.0, 5537.0, 5563.0, 5455.0, 5271.0, 5666.0, 5502.0, 5663.0, 5336.0, 5312.0, 5711.0, 5506.0, 5622.0, 5481.0, 5556.0, 5634.0, 5449.0

						5585.0, 5341.0, 5504.0, 5718.0, 5600.0, 5693.0, 5339.0, 5670.0, 5408.0, 5317.0, 5639.0, 5569.0, 5460.0, 5453.0, 5611.0, 5638.0, 5608.0, 5403.0, 5626.0, 5636.0, 5301.0, 5435.0, 5389.0, 5367.0, 5612.0, 5493.0, 5284.0, 5351.0, 5651.0, 5384.0, 5721.0, 5698.0, 5472.0, 5423.0, 5605.0, 5534.0, 5450.0, 5421.0, 5581.0, 5474.0, 5662.0, 5687.0, 5350.0, 5715.0, 5705.0 (number of hits: 9)
4	5550	9	1	333	1	5344.0, 5313.0, 5472.0, 5535.0, 5389.0, 5615.0, 5467.0, 5374.0, 5631.0, 5661.0, 5250.0, 5346.0, 5604.0, 5273.0, 5579.0, 5544.0, 5312.0, 5681.0, 5398.0, 5633.0, 5614.0, 5716.0, 5308.0, 5275.0, 5622.0, 5464.0, 5425.0, 5262.0, 5445.0, 5490.0, 5382.0, 5297.0, 5359.0, 5675.0, 5637.0, 5713.0, 5459.0, 5542.0, 5424.0, 5302.0, 5439.0, 5485.0, 5699.0, 5625.0, 5618.0, 5621.0, 5435.0, 5612.0, 5325.0, 5502.0, 5385.0, 5264.0, 5606.0, 5627.0, 5444.0, 5384.0, 5719.0, 5551.0, 5478.0, 5646.0, 5390.0, 5278.0, 5517.0, 5452.0, 5318.0, 5511.0, 5266.0, 5430.0, 5566.0, 5293.0, 5475.0, 5482.0, 5721.0, 5423.0, 5330.0, 5666.0, 5505.0, 5462.0, 5399.0, 5575.0, 5641.0, 5334.0, 5679.0, 5315.0, 5650.0, 5307.0, 5366.0, 5609.0, 5649.0, 5378.0, 5450.0, 5518.0, 5703.0, 5508.0, 5401.0, 5277.0, 5663.0, 5321.0, 5662.0, 5648.0 (number of hits: 5)
5	5550	9	1	333	1	5449.0, 5561.0, 5508.0, 5673.0, 5607.0, 5618.0, 5376.0, 5435.0, 5549.0, 5537.0, 5556.0, 5594.0, 5704.0, 5584.0, 5630.0, 5576.0, 5401.0, 5600.0, 5328.0, 5311.0, 5332.0, 5402.0, 5448.0, 5539.0, 5483.0, 5490.0, 5457.0, 5281.0, 5680.0, 5597.0, 5373.0, 5444.0, 5588.0, 5293.0, 5395.0, 5509.0, 5439.0, 5548.0, 5547.0, 5510.0, 5591.0, 5358.0, 5534.0, 5253.0, 5709.0, 5481.0, 5624.0, 5524.0, 5521.0, 5370.0, 5615.0, 5517.0, 5258.0, 5442.0, 5410.0, 5420.0, 5382.0, 5513.0, 5595.0, 5284.0, 5283.0, 5453.0, 5503.0, 5261.0, 5475.0, 5452.0, 5628.0, 5710.0, 5468.0, 5394.0, 5656.0, 5650.0, 5262.0, 5601.0, 5380.0, 5674.0, 5308.0, 5669.0, 5708.0, 5280.0, 5525.0, 5527.0, 5344.0, 5251.0, 5705.0, 5698.0, 5587.0, 5502.0, 5497.0, 5703.0, 5592.0, 5695.0, 5264.0, 5662.0, 5707.0, 5715.0, 5480.0, 5268.0, 5345.0, 5542.0 (number of hits: 9)
6	5550	9	1	333	1	5629.0, 5669.0, 5437.0, 5411.0, 5299.0, 5496.0, 5497.0, 5572.0, 5626.0, 5488.0, 5263.0, 5466.0, 5378.0, 5519.0, 5388.0, 5369.0, 5708.0, 5264.0, 5280.0, 5649.0, 5643.0, 5627.0, 5469.0, 5531.0, 5697.0, 5605.0, 5398.0, 5354.0, 5502.0, 5602.0, 5371.0, 5640.0, 5628.0, 5607.0, 5589.0

						5362.0, 5252.0, 5560.0, 5620.0, 5505.0, 5632.0, 5422.0, 5723.0, 5342.0, 5564.0, 5260.0, 5373.0, 5701.0, 5638.0, 5527.0, 5558.0, 5556.0, 5557.0, 5268.0, 5569.0, 5703.0, 5402.0, 5630.0, 5335.0, 5526.0, 5695.0, 5512.0, 5380.0, 5563.0, 5554.0, 5546.0, 5250.0, 5587.0, 5510.0, 5445.0, 5483.0, 5427.0, 5257.0, 5511.0, 5528.0, 5419.0, 5282.0, 5624.0, 5600.0, 5596.0, 5682.0, 5347.0, 5462.0, 5321.0, 5692.0, 5400.0, 5608.0, 5301.0, 5591.0, 5532.0, 5583.0, 5376.0, 5683.0, 5429.0, 5278.0, 5391.0, 5273.0, 5507.0, 5652.0, 5387.0 (number of hits: 11)
7	5550	9	1	333	1	5555.0, 5457.0, 5657.0, 5330.0, 5690.0, 5552.0, 5430.0, 5369.0, 5617.0, 5567.0, 5660.0, 5542.0, 5514.0, 5349.0, 5574.0, 5252.0, 5589.0, 5315.0, 5409.0, 5380.0, 5253.0, 5509.0, 5511.0, 5528.0, 5614.0, 5712.0, 5297.0, 5272.0, 5562.0, 5708.0, 5326.0, 5356.0, 5498.0, 5658.0, 5518.0, 5335.0, 5630.0, 5654.0, 5473.0, 5400.0, 5299.0, 5580.0, 5526.0, 5684.0, 5440.0, 5571.0, 5279.0, 5444.0, 5549.0, 5717.0, 5431.0, 5510.0, 5301.0, 5341.0, 5686.0, 5426.0, 5334.0, 5656.0, 5475.0, 5680.0, 5609.0, 5667.0, 5663.0, 5704.0, 5324.0, 5359.0, 5703.0, 5311.0, 5560.0, 5691.0, 5336.0, 5550.0, 5465.0, 5317.0, 5419.0, 5566.0, 5647.0, 5273.0, 5323.0, 5312.0, 5568.0, 5575.0, 5497.0, 5342.0, 5636.0, 5501.0, 5437.0, 5275.0, 5709.0, 5477.0, 5607.0, 5692.0, 5668.0, 5682.0, 5447.0, 5570.0, 5285.0, 5619.0, 5357.0, 5395.0 (number of hits: 10)
8	5550	9	1	333	1	5327.0, 5655.0, 5581.0, 5353.0, 5625.0, 5559.0, 5698.0, 5666.0, 5519.0, 5542.0, 5573.0, 5492.0, 5273.0, 5470.0, 5374.0, 5494.0, 5555.0, 5724.0, 5425.0, 5621.0, 5675.0, 5531.0, 5417.0, 5297.0, 5599.0, 5473.0, 5359.0, 5388.0, 5424.0, 5299.0, 5522.0, 5504.0, 5622.0, 5597.0, 5371.0, 5679.0, 5432.0, 5534.0, 5459.0, 5439.0, 5414.0, 5598.0, 5510.0, 5337.0, 5476.0, 5349.0, 5678.0, 5312.0, 5463.0, 5539.0, 5321.0, 5664.0, 5298.0, 5290.0, 5335.0, 5350.0, 5411.0, 5644.0, 5373.0, 5577.0, 5691.0, 5479.0, 5701.0, 5266.0, 5400.0, 5268.0, 5280.0, 5704.0, 5256.0, 5377.0, 5536.0, 5450.0, 5594.0, 5548.0, 5283.0, 5376.0, 5469.0, 5496.0, 5620.0, 5717.0, 5580.0, 5379.0, 5454.0, 5262.0, 5396.0, 5503.0, 5302.0, 5390.0, 5292.0, 5585.0, 5394.0, 5441.0, 5672.0, 5612.0, 5687.0, 5705.0, 5634.0, 5596.0, 5466.0, 5397.0 (number of hits: 8)
9	5550	9	1	333	1	5609.0, 5435.0, 5577.0, 5431.0, 5479.0, 5601.0, 5353.0, 5382.0, 5439.0, 5548.0, 5365.0, 5561.0, 5484.0, 5253.0, 5288.0,

						5589.0, 5685.0, 5324.0, 5494.0, 5659.0, 5636.0, 5352.0, 5573.0, 5667.0, 5267.0, 5511.0, 5719.0, 5257.0, 5595.0, 5280.0, 5339.0, 5710.0, 5427.0, 5302.0, 5307.0, 5508.0, 5250.0, 5679.0, 5416.0, 5617.0, 5646.0, 5424.0, 5642.0, 5522.0, 5342.0, 5647.0, 5557.0, 5471.0, 5466.0, 5527.0, 5611.0, 5281.0, 5509.0, 5331.0, 5320.0, 5338.0, 5702.0, 5415.0, 5343.0, 5467.0, 5721.0, 5604.0, 5581.0, 5639.0, 5482.0, 5632.0, 5705.0, 5681.0, 5285.0, 5623.0, 5640.0, 5450.0, 5255.0, 5452.0, 5311.0, 5525.0, 5544.0, 5272.0, 5425.0, 5720.0, 5622.0, 5512.0, 5637.0, 5478.0, 5371.0, 5495.0, 5633.0, 5251.0, 5290.0, 5714.0, 5686.0, 5319.0, 5675.0, 5644.0, 5610.0, 5428.0, 5263.0, 5372.0, 5472.0, 5700.0 (number of hits: 4)
10	5550	9	1	333	1	5604.0, 5519.0, 5566.0, 5424.0, 5371.0, 5384.0, 5471.0, 5650.0, 5499.0, 5525.0, 5338.0, 5345.0, 5450.0, 5404.0, 5480.0, 5295.0, 5584.0, 5682.0, 5614.0, 5623.0, 5622.0, 5408.0, 5332.0, 5393.0, 5352.0, 5391.0, 5363.0, 5699.0, 5333.0, 5556.0, 5592.0, 5257.0, 5545.0, 5505.0, 5539.0, 5456.0, 5673.0, 5382.0, 5562.0, 5462.0, 5587.0, 5703.0, 5447.0, 5277.0, 5364.0, 5615.0, 5664.0, 5274.0, 5608.0, 5441.0, 5526.0, 5649.0, 5632.0, 5685.0, 5708.0, 5501.0, 5568.0, 5713.0, 5528.0, 5717.0, 5394.0, 5677.0, 5639.0, 5469.0, 5548.0, 5638.0, 5467.0, 5552.0, 5714.0, 5339.0, 5310.0, 5466.0, 5340.0, 5302.0, 5487.0, 5488.0, 5252.0, 5602.0, 5421.0, 5588.0, 5558.0, 5313.0, 5493.0, 5293.0, 5470.0, 5702.0, 5585.0, 5617.0, 5256.0, 5620.0, 5322.0, 5426.0, 5479.0, 5567.0, 5710.0, 5498.0, 5659.0, 5417.0, 5508.0, 5688.0 (number of hits: 10)
11	5550	9	1	333	1	5671.0, 5291.0, 5572.0, 5679.0, 5380.0, 5450.0, 5565.0, 5609.0, 5351.0, 5431.0, 5359.0, 5470.0, 5297.0, 5355.0, 5511.0, 5659.0, 5545.0, 5579.0, 5360.0, 5666.0, 5658.0, 5655.0, 5547.0, 5275.0, 5294.0, 5706.0, 5339.0, 5438.0, 5411.0, 5700.0, 5512.0, 5693.0, 5321.0, 5267.0, 5649.0, 5386.0, 5371.0, 5505.0, 5556.0, 5390.0, 5561.0, 5441.0, 5306.0, 5704.0, 5711.0, 5637.0, 5540.0, 5674.0, 5316.0, 5286.0, 5528.0, 5277.0, 5610.0, 5381.0, 5673.0, 5349.0, 5709.0, 5278.0, 5426.0, 5676.0, 5668.0, 5489.0, 5657.0, 5324.0, 5702.0, 5485.0, 5358.0, 5475.0, 5325.0, 5413.0, 5631.0, 5656.0, 5479.0, 5273.0, 5620.0, 5682.0, 5429.0, 5694.0, 5480.0, 5632.0, 5654.0, 5313.0, 5377.0, 5520.0, 5254.0, 5293.0, 5714.0, 5566.0, 5492.0, 5290.0, 5506.0, 5593.0, 5367.0, 5476.0, 5680.0, 5333.0, 5681.0, 5635.0, 5574.0, 5598.0

						(number of hits: 7)
12	5550	9	1	333	1	5535.0, 5261.0, 5604.0, 5561.0, 5399.0, 5398.0, 5467.0, 5669.0, 5663.0, 5579.0, 5703.0, 5253.0, 5661.0, 5313.0, 5607.0, 5709.0, 5681.0, 5573.0, 5323.0, 5367.0, 5471.0, 5688.0, 5497.0, 5632.0, 5359.0, 5666.0, 5560.0, 5409.0, 5474.0, 5527.0, 5268.0, 5618.0, 5513.0, 5380.0, 5396.0, 5608.0, 5462.0, 5472.0, 5500.0, 5280.0, 5262.0, 5360.0, 5250.0, 5700.0, 5551.0, 5589.0, 5716.0, 5601.0, 5304.0, 5386.0, 5267.0, 5644.0, 5552.0, 5691.0, 5665.0, 5334.0, 5259.0, 5678.0, 5263.0, 5569.0, 5291.0, 5378.0, 5300.0, 5532.0, 5705.0, 5388.0, 5284.0, 5482.0, 5690.0, 5555.0, 5662.0, 5414.0, 5460.0, 5711.0, 5319.0, 5572.0, 5435.0, 5333.0, 5283.0, 5617.0, 5449.0, 5477.0, 5301.0, 5658.0, 5287.0, 5631.0, 5483.0, 5606.0, 5515.0, 5659.0, 5265.0, 5536.0, 5528.0, 5623.0, 5712.0, 5329.0, 5332.0, 5374.0, 5418.0, 5412.0
						(number of hits: 9)
13	5550	9	1	333	1	5682.0, 5484.0, 5533.0, 5561.0, 5472.0, 5361.0, 5651.0, 5675.0, 5489.0, 5452.0, 5320.0, 5282.0, 5614.0, 5599.0, 5708.0, 5265.0, 5586.0, 5516.0, 5429.0, 5657.0, 5608.0, 5436.0, 5521.0, 5611.0, 5451.0, 5416.0, 5585.0, 5550.0, 5312.0, 5542.0, 5605.0, 5252.0, 5481.0, 5262.0, 5677.0, 5720.0, 5458.0, 5498.0, 5460.0, 5632.0, 5475.0, 5569.0, 5686.0, 5537.0, 5304.0, 5364.0, 5641.0, 5342.0, 5380.0, 5270.0, 5631.0, 5447.0, 5591.0, 5563.0, 5299.0, 5327.0, 5382.0, 5523.0, 5434.0, 5465.0, 5531.0, 5394.0, 5627.0, 5493.0, 5554.0, 5482.0, 5409.0, 5640.0, 5290.0, 5308.0, 5501.0, 5693.0, 5258.0, 5551.0, 5513.0, 5398.0, 5357.0, 5664.0, 5509.0, 5601.0, 5384.0, 5495.0, 5573.0, 5365.0, 5293.0, 5404.0, 5602.0, 5557.0, 5612.0, 5341.0, 5350.0, 5309.0, 5620.0, 5411.0, 5301.0, 5377.0, 5544.0, 5255.0, 5356.0, 5419.0
						(number of hits: 12)
14	5550	9	1	333	1	5265.0, 5329.0, 5471.0, 5601.0, 5623.0, 5609.0, 5330.0, 5503.0, 5312.0, 5646.0, 5458.0, 5266.0, 5322.0, 5324.0, 5547.0, 5693.0, 5408.0, 5619.0, 5395.0, 5665.0, 5491.0, 5375.0, 5599.0, 5357.0, 5387.0, 5367.0, 5309.0, 5472.0, 5698.0, 5581.0, 5639.0, 5630.0, 5505.0, 5522.0, 5469.0, 5464.0, 5702.0, 5697.0, 5414.0, 5320.0, 5383.0, 5670.0, 5428.0, 5689.0, 5652.0, 5299.0, 5467.0, 5497.0, 5492.0, 5354.0, 5353.0, 5286.0, 5518.0, 5513.0, 5562.0, 5680.0, 5337.0, 5314.0, 5394.0, 5267.0, 5345.0, 5614.0, 5720.0, 5618.0, 5578.0, 5587.0, 5275.0, 5448.0, 5550.0, 5284.0, 5379.0, 5699.0, 5611.0, 5377.0, 5251.0, 5493.0, 5502.0, 5555.0, 5576.0, 5691.0,

						5430.0, 5327.0, 5686.0, 5434.0, 5475.0, 5612.0, 5278.0, 5508.0, 5403.0, 5468.0, 5509.0, 5598.0, 5560.0, 5412.0, 5649.0, 5554.0, 5669.0, 5648.0, 5638.0, 5339.0 (number of hits: 6)
15	5550	9	1	333	1	5468.0, 5708.0, 5592.0, 5678.0, 5559.0, 5704.0, 5639.0, 5436.0, 5563.0, 5269.0, 5292.0, 5607.0, 5291.0, 5519.0, 5496.0, 5658.0, 5585.0, 5565.0, 5376.0, 5587.0, 5348.0, 5507.0, 5479.0, 5680.0, 5623.0, 5553.0, 5386.0, 5441.0, 5625.0, 5457.0, 5303.0, 5560.0, 5294.0, 5461.0, 5566.0, 5688.0, 5583.0, 5374.0, 5549.0, 5668.0, 5388.0, 5342.0, 5311.0, 5579.0, 5696.0, 5412.0, 5310.0, 5503.0, 5603.0, 5369.0, 5312.0, 5260.0, 5706.0, 5451.0, 5691.0, 5272.0, 5501.0, 5320.0, 5437.0, 5327.0, 5531.0, 5428.0, 5548.0, 5724.0, 5506.0, 5589.0, 5486.0, 5591.0, 5655.0, 5633.0, 5315.0, 5381.0, 5427.0, 5662.0, 5505.0, 5707.0, 5480.0, 5557.0, 5482.0, 5284.0, 5522.0, 5692.0, 5356.0, 5473.0, 5439.0, 5689.0, 5384.0, 5334.0, 5407.0, 5497.0, 5472.0, 5440.0, 5330.0, 5608.0, 5701.0, 5443.0, 5699.0, 5634.0, 5455.0, 5574.0 (number of hits: 10)
16	5550	9	1	333	1	5313.0, 5317.0, 5511.0, 5653.0, 5624.0, 5684.0, 5292.0, 5708.0, 5364.0, 5579.0, 5332.0, 5416.0, 5678.0, 5413.0, 5451.0, 5671.0, 5621.0, 5279.0, 5644.0, 5689.0, 5394.0, 5271.0, 5429.0, 5373.0, 5263.0, 5315.0, 5427.0, 5592.0, 5532.0, 5362.0, 5610.0, 5557.0, 5681.0, 5506.0, 5488.0, 5565.0, 5638.0, 5294.0, 5715.0, 5419.0, 5616.0, 5367.0, 5656.0, 5330.0, 5496.0, 5342.0, 5418.0, 5475.0, 5716.0, 5566.0, 5548.0, 5554.0, 5405.0, 5352.0, 5685.0, 5461.0, 5672.0, 5436.0, 5571.0, 5410.0, 5534.0, 5379.0, 5298.0, 5609.0, 5687.0, 5605.0, 5369.0, 5273.0, 5365.0, 5524.0, 5713.0, 5371.0, 5398.0, 5606.0, 5406.0, 5564.0, 5702.0, 5622.0, 5409.0, 5709.0, 5323.0, 5357.0, 5309.0, 5346.0, 5569.0, 5311.0, 5696.0, 5329.0, 5443.0, 5670.0, 5601.0, 5380.0, 5509.0, 5476.0, 5600.0, 5675.0, 5588.0, 5356.0, 5470.0, 5389.0 (number of hits: 9)
17	5550	9	1	333	1	5256.0, 5270.0, 5455.0, 5337.0, 5699.0, 5280.0, 5426.0, 5682.0, 5258.0, 5520.0, 5423.0, 5352.0, 5568.0, 5659.0, 5361.0, 5416.0, 5251.0, 5561.0, 5644.0, 5333.0, 5400.0, 5292.0, 5331.0, 5596.0, 5608.0, 5289.0, 5592.0, 5721.0, 5507.0, 5355.0, 5693.0, 5606.0, 5261.0, 5690.0, 5430.0, 5687.0, 5713.0, 5649.0, 5291.0, 5429.0, 5252.0, 5532.0, 5452.0, 5443.0, 5285.0, 5714.0, 5397.0, 5660.0, 5615.0, 5293.0, 5276.0, 5338.0, 5631.0, 5410.0, 5684.0, 5460.0, 5493.0, 5629.0, 5481.0, 5723.0,

						5533.0, 5701.0, 5510.0, 5641.0, 5366.0, 5269.0, 5424.0, 5306.0, 5668.0, 5348.0, 5265.0, 5702.0, 5480.0, 5275.0, 5579.0, 5551.0, 5525.0, 5420.0, 5319.0, 5676.0, 5439.0, 5395.0, 5360.0, 5418.0, 5622.0, 5617.0, 5707.0, 5386.0, 5562.0, 5557.0, 5297.0, 5259.0, 5638.0, 5531.0, 5715.0, 5312.0, 5607.0, 5517.0, 5326.0, 5367.0 (number of hits: 8)
18	5550	9	1	333	1	5407.0, 5477.0, 5697.0, 5672.0, 5626.0, 5432.0, 5357.0, 5702.0, 5525.0, 5421.0, 5391.0, 5490.0, 5699.0, 5670.0, 5719.0, 5535.0, 5319.0, 5611.0, 5322.0, 5636.0, 5579.0, 5584.0, 5317.0, 5327.0, 5320.0, 5655.0, 5597.0, 5365.0, 5656.0, 5377.0, 5447.0, 5531.0, 5424.0, 5433.0, 5564.0, 5346.0, 5373.0, 5384.0, 5487.0, 5316.0, 5439.0, 5503.0, 5389.0, 5555.0, 5474.0, 5434.0, 5484.0, 5431.0, 5342.0, 5619.0, 5546.0, 5693.0, 5351.0, 5426.0, 5265.0, 5411.0, 5441.0, 5281.0, 5585.0, 5286.0, 5684.0, 5277.0, 5528.0, 5451.0, 5308.0, 5293.0, 5306.0, 5608.0, 5506.0, 5414.0, 5350.0, 5667.0, 5675.0, 5410.0, 5696.0, 5610.0, 5559.0, 5624.0, 5324.0, 5445.0, 5491.0, 5628.0, 5572.0, 5464.0, 5332.0, 5652.0, 5708.0, 5390.0, 5344.0, 5518.0, 5658.0, 5283.0, 5443.0, 5647.0, 5478.0, 5425.0, 5577.0, 5285.0, 5568.0, 5260.0 (number of hits: 7)
19	5550	9	1	333	1	5529.0, 5669.0, 5353.0, 5285.0, 5363.0, 5330.0, 5483.0, 5671.0, 5321.0, 5654.0, 5306.0, 5301.0, 5265.0, 5252.0, 5599.0, 5697.0, 5344.0, 5524.0, 5541.0, 5675.0, 5719.0, 5442.0, 5458.0, 5340.0, 5609.0, 5294.0, 5517.0, 5705.0, 5432.0, 5708.0, 5587.0, 5498.0, 5534.0, 5545.0, 5557.0, 5365.0, 5459.0, 5290.0, 5625.0, 5429.0, 5489.0, 5277.0, 5605.0, 5272.0, 5595.0, 5276.0, 5499.0, 5509.0, 5645.0, 5461.0, 5716.0, 5454.0, 5511.0, 5611.0, 5417.0, 5399.0, 5597.0, 5519.0, 5415.0, 5427.0, 5381.0, 5471.0, 5646.0, 5624.0, 5291.0, 5506.0, 5405.0, 5357.0, 5292.0, 5370.0, 5504.0, 5288.0, 5518.0, 5501.0, 5431.0, 5580.0, 5683.0, 5690.0, 5286.0, 5439.0, 5322.0, 5401.0, 5495.0, 5329.0, 5678.0, 5558.0, 5579.0, 5655.0, 5395.0, 5623.0, 5516.0, 5436.0, 5325.0, 5661.0, 5702.0, 5450.0, 5574.0, 5472.0, 5637.0, 5263.0 (number of hits: 5)
20	5550	9	1	333	1	5669.0, 5359.0, 5381.0, 5358.0, 5548.0, 5434.0, 5276.0, 5649.0, 5616.0, 5679.0, 5576.0, 5466.0, 5288.0, 5670.0, 5533.0, 5402.0, 5454.0, 5656.0, 5341.0, 5603.0, 5660.0, 5579.0, 5357.0, 5294.0, 5312.0, 5487.0, 5605.0, 5672.0, 5406.0, 5250.0, 5313.0, 5697.0, 5504.0, 5607.0, 5540.0, 5527.0, 5625.0, 5453.0, 5562.0, 5364.0

						5451.0, 5388.0, 5355.0, 5336.0, 5293.0, 5452.0, 5715.0, 5526.0, 5265.0, 5499.0, 5393.0, 5627.0, 5543.0, 5309.0, 5289.0, 5337.0, 5632.0, 5295.0, 5426.0, 5564.0, 5555.0, 5578.0, 5468.0, 5585.0, 5320.0, 5668.0, 5278.0, 5321.0, 5421.0, 5461.0, 5568.0, 5471.0, 5614.0, 5535.0, 5326.0, 5493.0, 5587.0, 5442.0, 5537.0, 5546.0, 5433.0, 5595.0, 5646.0, 5274.0, 5511.0, 5503.0, 5465.0, 5481.0, 5343.0, 5346.0, 5599.0, 5473.0, 5300.0, 5569.0, 5677.0, 5349.0, 5254.0, 5398.0, 5550.0, 5291.0 (number of hits: 13)
21	5550	9	1	333	1	5331.0, 5340.0, 5559.0, 5309.0, 5292.0, 5665.0, 5263.0, 5567.0, 5290.0, 5636.0, 5305.0, 5287.0, 5468.0, 5699.0, 5693.0, 5497.0, 5644.0, 5551.0, 5414.0, 5565.0, 5301.0, 5436.0, 5616.0, 5383.0, 5323.0, 5618.0, 5479.0, 5339.0, 5545.0, 5709.0, 5543.0, 5356.0, 5631.0, 5472.0, 5537.0, 5614.0, 5533.0, 5318.0, 5596.0, 5515.0, 5541.0, 5403.0, 5297.0, 5352.0, 5660.0, 5442.0, 5492.0, 5254.0, 5544.0, 5332.0, 5370.0, 5346.0, 5720.0, 5553.0, 5307.0, 5717.0, 5525.0, 5429.0, 5411.0, 5692.0, 5514.0, 5337.0, 5392.0, 5501.0, 5516.0, 5426.0, 5274.0, 5486.0, 5535.0, 5428.0, 5640.0, 5722.0, 5673.0, 5463.0, 5494.0, 5512.0, 5368.0, 5550.0, 5375.0, 5560.0, 5509.0, 5294.0, 5708.0, 5445.0, 5534.0, 5546.0, 5437.0, 5649.0, 5374.0, 5493.0, 5621.0, 5447.0, 5277.0, 5583.0, 5261.0, 5251.0, 5469.0, 5464.0, 5523.0, 5666.0 (number of hits: 16)
22	5550	9	1	333	1	5275.0, 5487.0, 5591.0, 5457.0, 5587.0, 5287.0, 5418.0, 5303.0, 5312.0, 5280.0, 5272.0, 5445.0, 5382.0, 5502.0, 5507.0, 5549.0, 5345.0, 5512.0, 5408.0, 5261.0, 5252.0, 5320.0, 5642.0, 5649.0, 5639.0, 5484.0, 5495.0, 5420.0, 5712.0, 5340.0, 5318.0, 5493.0, 5437.0, 5374.0, 5395.0, 5258.0, 5467.0, 5317.0, 5651.0, 5286.0, 5609.0, 5624.0, 5689.0, 5679.0, 5672.0, 5715.0, 5372.0, 5498.0, 5304.0, 5379.0, 5685.0, 5260.0, 5284.0, 5675.0, 5682.0, 5255.0, 5251.0, 5697.0, 5671.0, 5573.0, 5537.0, 5659.0, 5602.0, 5526.0, 5625.0, 5604.0, 5588.0, 5440.0, 5346.0, 5349.0, 5683.0, 5404.0, 5570.0, 5459.0, 5660.0, 5427.0, 5536.0, 5667.0, 5510.0, 5594.0, 5620.0, 5559.0, 5417.0, 5544.0, 5586.0, 5471.0, 5327.0, 5343.0, 5433.0, 5316.0, 5483.0, 5504.0, 5452.0, 5631.0, 5354.0, 5307.0, 5700.0, 5575.0, 5468.0, 5520.0 (number of hits: 5)
23	5550	9	1	333	1	5556.0, 5607.0, 5447.0, 5630.0, 5358.0, 5330.0, 5504.0, 5666.0, 5492.0, 5421.0, 5458.0, 5391.0, 5255.0, 5573.0, 5480.0, 5720.0, 5285.0, 5317.0, 5464.0, 5526.0,

						5380.0, 5653.0, 5565.0, 5267.0, 5382.0, 5456.0, 5472.0, 5335.0, 5401.0, 5603.0, 5602.0, 5425.0, 5595.0, 5507.0, 5593.0, 5510.0, 5554.0, 5345.0, 5301.0, 5388.0, 5322.0, 5399.0, 5550.0, 5490.0, 5502.0, 5669.0, 5274.0, 5445.0, 5384.0, 5580.0, 5416.0, 5606.0, 5418.0, 5698.0, 5253.0, 5509.0, 5264.0, 5570.0, 5531.0, 5408.0, 5440.0, 5484.0, 5548.0, 5679.0, 5407.0, 5423.0, 5370.0, 5592.0, 5489.0, 5303.0, 5673.0, 5515.0, 5304.0, 5474.0, 5706.0, 5361.0, 5386.0, 5657.0, 5451.0, 5494.0, 5429.0, 5612.0, 5400.0, 5482.0, 5275.0, 5343.0, 5294.0, 5374.0, 5631.0, 5261.0, 5641.0, 5263.0, 5677.0, 5536.0, 5422.0, 5600.0, 5308.0, 5604.0, 5321.0, 5721.0 (number of hits: 7)
24	5550	9	1	333	1	5452.0, 5289.0, 5401.0, 5355.0, 5272.0, 5665.0, 5275.0, 5643.0, 5580.0, 5556.0, 5724.0, 5466.0, 5383.0, 5593.0, 5446.0, 5305.0, 5493.0, 5597.0, 5502.0, 5342.0, 5435.0, 5321.0, 5406.0, 5360.0, 5505.0, 5483.0, 5565.0, 5671.0, 5558.0, 5414.0, 5293.0, 5651.0, 5426.0, 5439.0, 5549.0, 5557.0, 5695.0, 5398.0, 5345.0, 5413.0, 5372.0, 5410.0, 5504.0, 5363.0, 5673.0, 5310.0, 5282.0, 5299.0, 5433.0, 5534.0, 5523.0, 5465.0, 5506.0, 5542.0, 5682.0, 5480.0, 5280.0, 5364.0, 5381.0, 5330.0, 5353.0, 5300.0, 5626.0, 5373.0, 5498.0, 5539.0, 5646.0, 5603.0, 5570.0, 5590.0, 5267.0, 5332.0, 5547.0, 5613.0, 5487.0, 5601.0, 5481.0, 5717.0, 5291.0, 5702.0, 5715.0, 5290.0, 5432.0, 5592.0, 5600.0, 5696.0, 5260.0, 5707.0, 5288.0, 5475.0, 5492.0, 5686.0, 5573.0, 5533.0, 5328.0, 5308.0, 5608.0, 5464.0, 5616.0, 5251.0 (number of hits: 10)
25	5550	9	1	333	1	5715.0, 5436.0, 5612.0, 5332.0, 5589.0, 5487.0, 5321.0, 5597.0, 5367.0, 5646.0, 5337.0, 5540.0, 5460.0, 5335.0, 5369.0, 5708.0, 5687.0, 5272.0, 5576.0, 5294.0, 5639.0, 5288.0, 5634.0, 5374.0, 5350.0, 5412.0, 5295.0, 5252.0, 5344.0, 5264.0, 5333.0, 5392.0, 5296.0, 5456.0, 5696.0, 5428.0, 5298.0, 5688.0, 5555.0, 5383.0, 5664.0, 5409.0, 5462.0, 5626.0, 5258.0, 5611.0, 5359.0, 5613.0, 5453.0, 5388.0, 5439.0, 5590.0, 5497.0, 5667.0, 5459.0, 5265.0, 5414.0, 5458.0, 5470.0, 5543.0, 5630.0, 5724.0, 5553.0, 5579.0, 5562.0, 5362.0, 5349.0, 5704.0, 5363.0, 5583.0, 5356.0, 5330.0, 5486.0, 5545.0, 5443.0, 5670.0, 5269.0, 5675.0, 5595.0, 5291.0, 5309.0, 5560.0, 5354.0, 5378.0, 5584.0, 5440.0, 5313.0, 5619.0, 5342.0, 5601.0, 5518.0, 5314.0, 5600.0, 5348.0, 5476.0, 5317.0, 5625.0, 5663.0, 5648.0, 5573.0 (number of hits: 7)

26	5550	9	1	333	1	5546.0, 5583.0, 5665.0, 5537.0, 5445.0, 5556.0, 5482.0, 5666.0, 5405.0, 5288.0, 5465.0, 5421.0, 5387.0, 5603.0, 5542.0, 5605.0, 5521.0, 5399.0, 5309.0, 5504.0, 5443.0, 5638.0, 5423.0, 5415.0, 5460.0, 5706.0, 5397.0, 5324.0, 5670.0, 5498.0, 5701.0, 5614.0, 5325.0, 5315.0, 5439.0, 5438.0, 5630.0, 5390.0, 5680.0, 5493.0, 5470.0, 5684.0, 5576.0, 5259.0, 5664.0, 5622.0, 5516.0, 5296.0, 5644.0, 5690.0, 5341.0, 5699.0, 5418.0, 5280.0, 5306.0, 5368.0, 5359.0, 5700.0, 5523.0, 5346.0, 5695.0, 5329.0, 5654.0, 5568.0, 5662.0, 5427.0, 5271.0, 5535.0, 5650.0, 5703.0, 5355.0, 5677.0, 5403.0, 5393.0, 5702.0, 5560.0, 5334.0, 5698.0, 5582.0, 5299.0, 5466.0, 5597.0, 5623.0, 5667.0, 5723.0, 5429.0, 5437.0, 5281.0, 5592.0, 5539.0, 5566.0, 5298.0, 5402.0, 5570.0, 5365.0, 5268.0, 5604.0, 5409.0, 5704.0, 5584.0 (number of hits: 9)
27	5550	9	1	333	1	5570.0, 5309.0, 5546.0, 5549.0, 5451.0, 5427.0, 5503.0, 5252.0, 5332.0, 5420.0, 5631.0, 5721.0, 5446.0, 5363.0, 5527.0, 5311.0, 5516.0, 5586.0, 5296.0, 5627.0, 5385.0, 5636.0, 5697.0, 5620.0, 5686.0, 5253.0, 5496.0, 5564.0, 5556.0, 5520.0, 5355.0, 5602.0, 5377.0, 5389.0, 5621.0, 5576.0, 5353.0, 5449.0, 5392.0, 5600.0, 5317.0, 5434.0, 5404.0, 5269.0, 5259.0, 5668.0, 5650.0, 5683.0, 5529.0, 5393.0, 5656.0, 5431.0, 5515.0, 5429.0, 5359.0, 5316.0, 5365.0, 5682.0, 5667.0, 5265.0, 5500.0, 5642.0, 5461.0, 5608.0, 5607.0, 5611.0, 5507.0, 5618.0, 5437.0, 5378.0, 5397.0, 5654.0, 5705.0, 5354.0, 5475.0, 5422.0, 5343.0, 5264.0, 5448.0, 5267.0, 5718.0, 5320.0, 5272.0, 5565.0, 5402.0, 5580.0, 5543.0, 5701.0, 5469.0, 5260.0, 5262.0, 5470.0, 5314.0, 5291.0, 5441.0, 5639.0, 5579.0, 5689.0, 5372.0, 5531.0 (number of hits: 7)
28	5550	9	1	333	1	5527.0, 5506.0, 5656.0, 5698.0, 5355.0, 5271.0, 5453.0, 5695.0, 5302.0, 5294.0, 5571.0, 5715.0, 5282.0, 5338.0, 5605.0, 5332.0, 5276.0, 5259.0, 5296.0, 5444.0, 5446.0, 5657.0, 5455.0, 5322.0, 5553.0, 5648.0, 5260.0, 5473.0, 5330.0, 5720.0, 5534.0, 5669.0, 5548.0, 5416.0, 5519.0, 5320.0, 5691.0, 5485.0, 5452.0, 5575.0, 5604.0, 5578.0, 5629.0, 5579.0, 5420.0, 5531.0, 5269.0, 5283.0, 5425.0, 5414.0, 5458.0, 5520.0, 5498.0, 5647.0, 5307.0, 5690.0, 5704.0, 5356.0, 5419.0, 5639.0, 5586.0, 5429.0, 5576.0, 5638.0, 5408.0, 5257.0, 5472.0, 5293.0, 5385.0, 5672.0, 5370.0, 5275.0, 5724.0, 5646.0, 5677.0, 5410.0, 5712.0, 5621.0, 5351.0, 5601.0, 5268.0, 5284.0, 5365.0, 5595.0, 5536.0,

						5666.0, 5684.0, 5352.0, 5679.0, 5342.0, 5542.0, 5654.0, 5550.0, 5299.0, 5721.0, 5383.0, 5532.0, 5564.0, 5474.0, 5501.0 (number of hits: 9)
29	5550	9	1	333	1	5457.0, 5476.0, 5497.0, 5654.0, 5550.0, 5614.0, 5324.0, 5583.0, 5358.0, 5711.0, 5597.0, 5370.0, 5418.0, 5716.0, 5258.0, 5546.0, 5537.0, 5724.0, 5376.0, 5322.0, 5698.0, 5304.0, 5535.0, 5469.0, 5613.0, 5657.0, 5659.0, 5713.0, 5311.0, 5326.0, 5460.0, 5475.0, 5530.0, 5708.0, 5401.0, 5662.0, 5355.0, 5620.0, 5430.0, 5422.0, 5368.0, 5676.0, 5632.0, 5622.0, 5594.0, 5512.0, 5571.0, 5648.0, 5579.0, 5631.0, 5305.0, 5669.0, 5574.0, 5621.0, 5660.0, 5591.0, 5636.0, 5277.0, 5411.0, 5644.0, 5294.0, 5590.0, 5531.0, 5388.0, 5350.0, 5451.0, 5286.0, 5704.0, 5506.0, 5356.0, 5490.0, 5504.0, 5299.0, 5313.0, 5338.0, 5359.0, 5450.0, 5642.0, 5273.0, 5444.0, 5320.0, 5394.0, 5612.0, 5680.0, 5585.0, 5560.0, 5605.0, 5292.0, 5634.0, 5561.0, 5252.0, 5655.0, 5584.0, 5625.0, 5653.0, 5371.0, 5565.0, 5276.0, 5663.0, 5717.0 (number of hits: 9)
30	5550	9	1	333	1	5296.0, 5571.0, 5489.0, 5573.0, 5332.0, 5717.0, 5330.0, 5538.0, 5464.0, 5534.0, 5487.0, 5284.0, 5688.0, 5601.0, 5613.0, 5532.0, 5668.0, 5622.0, 5545.0, 5551.0, 5356.0, 5263.0, 5326.0, 5479.0, 5525.0, 5447.0, 5510.0, 5518.0, 5620.0, 5655.0, 5353.0, 5683.0, 5492.0, 5468.0, 5606.0, 5485.0, 5659.0, 5469.0, 5524.0, 5715.0, 5664.0, 5358.0, 5675.0, 5272.0, 5497.0, 5564.0, 5563.0, 5514.0, 5440.0, 5303.0, 5389.0, 5422.0, 5568.0, 5706.0, 5522.0, 5404.0, 5550.0, 5384.0, 5638.0, 5627.0, 5333.0, 5674.0, 5529.0, 5490.0, 5373.0, 5437.0, 5327.0, 5298.0, 5348.0, 5712.0, 5528.0, 5672.0, 5640.0, 5594.0, 5547.0, 5474.0, 5650.0, 5352.0, 5334.0, 5637.0, 5368.0, 5602.0, 5275.0, 5636.0, 5648.0, 5411.0, 5453.0, 5359.0, 5697.0, 5338.0, 5259.0, 5533.0, 5559.0, 5656.0, 5705.0, 5561.0, 5399.0, 5586.0, 5347.0, 5345.0 (number of hits: 13)

7 Appendix A – Test Setup Photographs

7.1 DFS Test Setup View



8 Appendix B – EUT Photographs

8.1 EUT – Top View



8.2 EUT – Front View



8.3 EUT – Left Side View



8.4 EUT – Right Side View

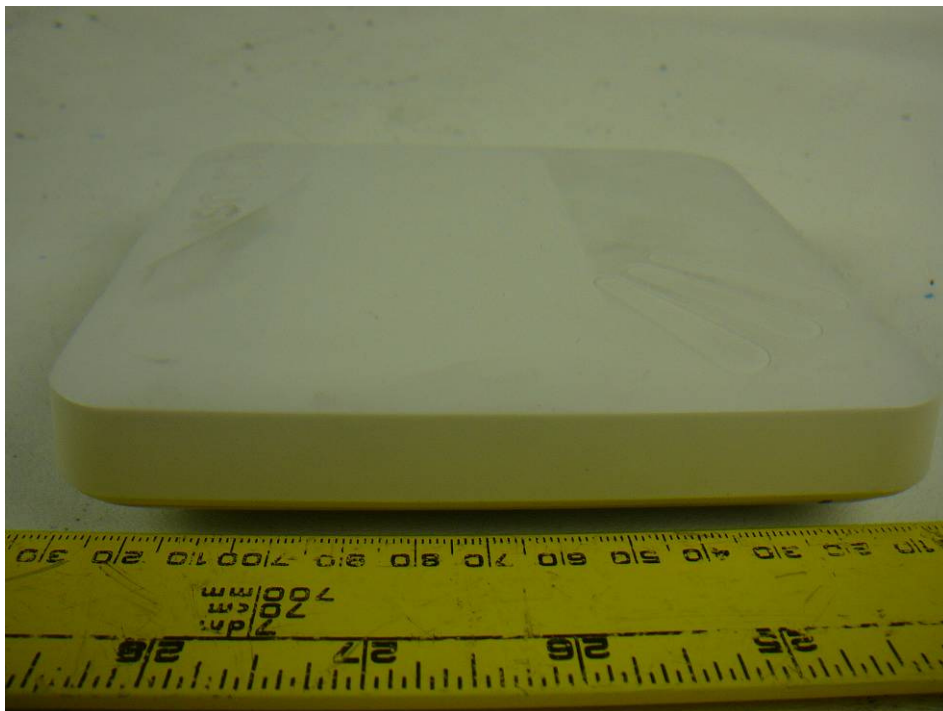

8.5 EUT – Rear Side View

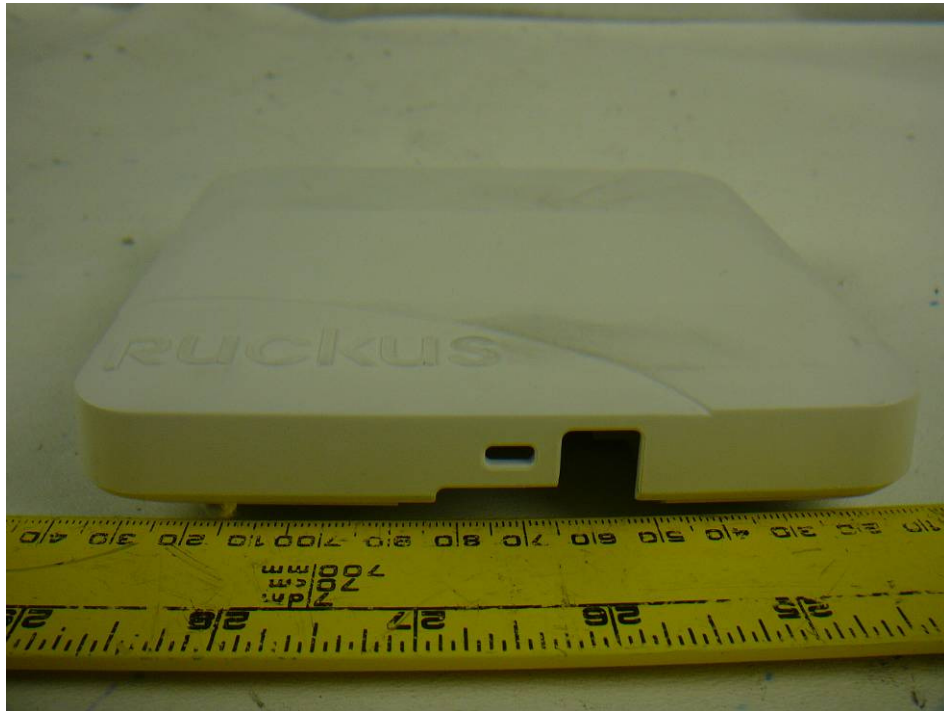

8.6 EUT – Bottom Side View

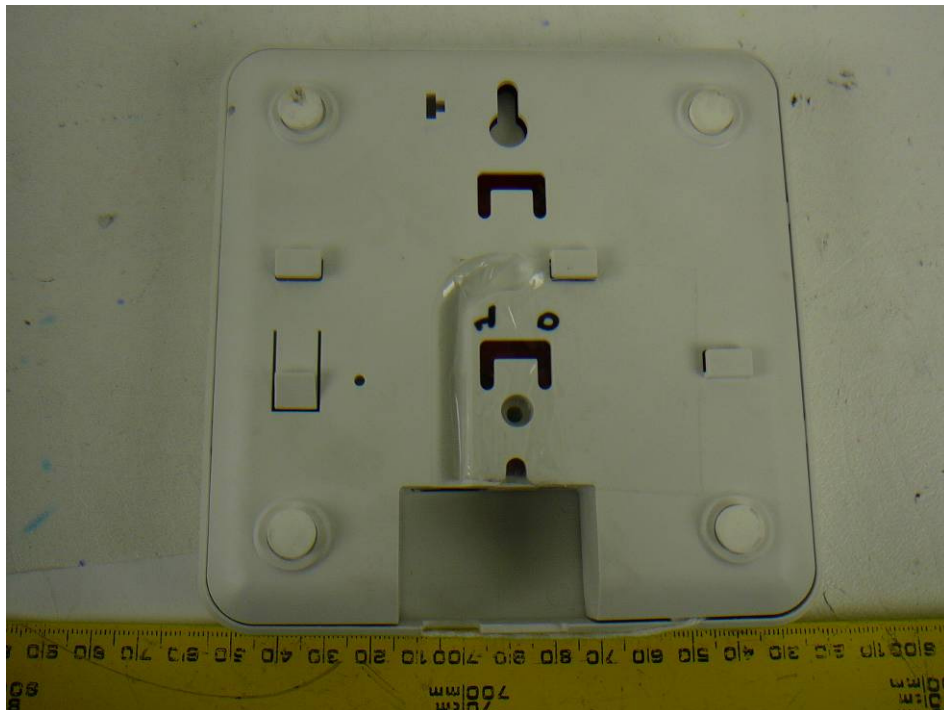

8.7 EUT – Open Case

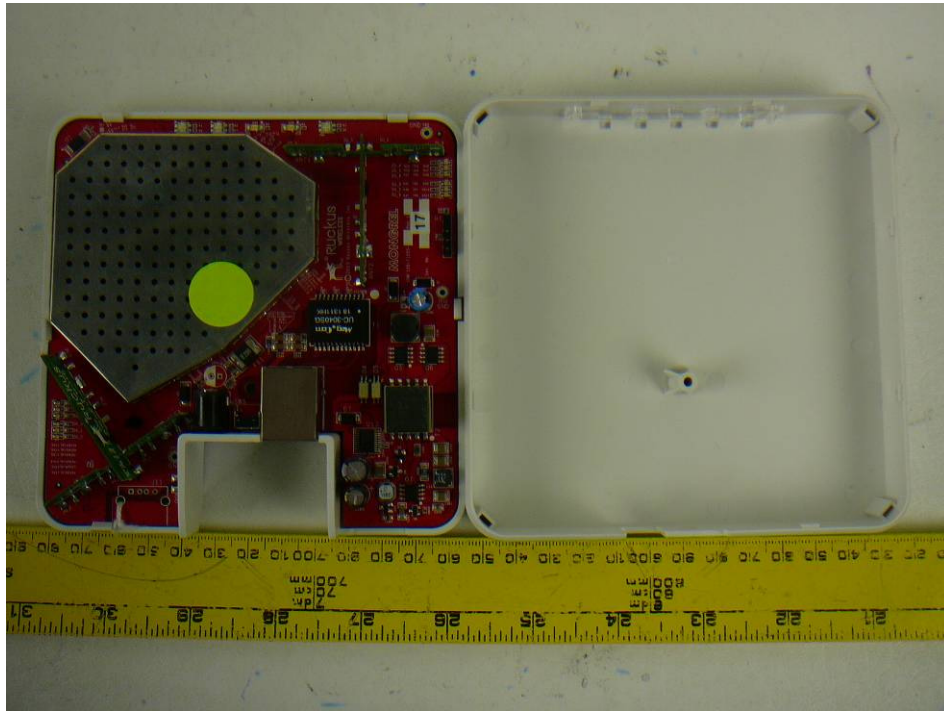

8.8 EUT – Motherboard Top View

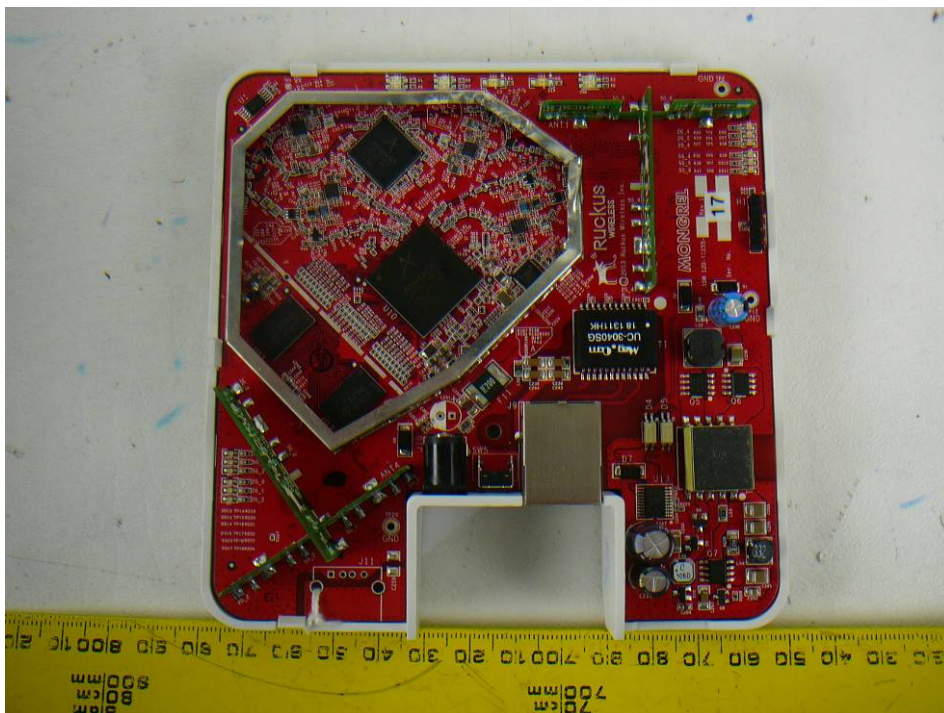

8.9 EUT – Motherboard Bottom View

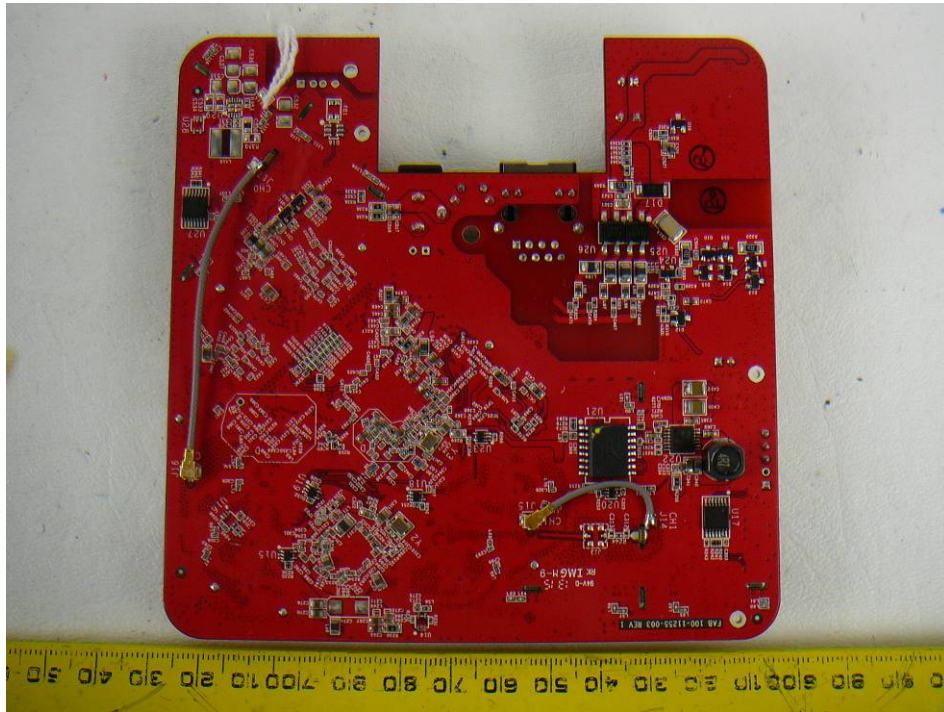

8.10 EUT – AC/DC Adaptor



8.11 EUT – POE & Adapter

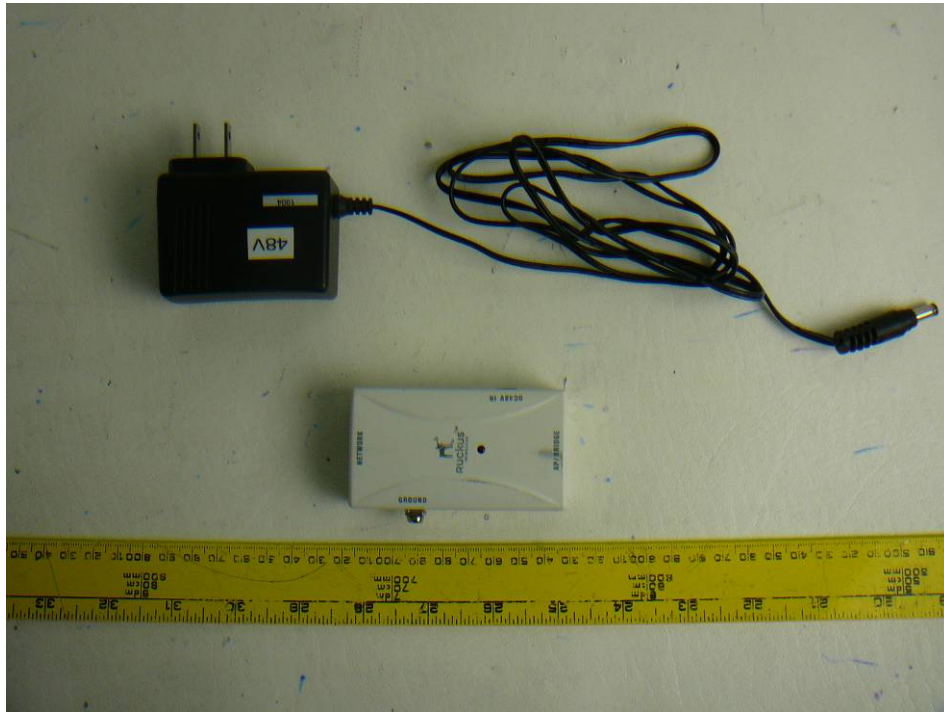

----- END OF REPORT -----