



FCC RADIO TEST REPORT

FCC ID : S9GQ910US00
Equipment : Q910 LTE Access Point
Brand Name : Ruckus
Model Name : Q910-US00
Applicant : Ruckus Wireless, Inc.
350 West Java Drive Sunnyvale California 94089
USA
Manufacturer : Ruckus Wireless, Inc.
350 West Java Drive Sunnyvale California 94089
USA
Standard : 47 CFR FCC Part2, 96

The product was received on May 08, 2018, and testing was started from May 08, 2018 and completed on Jun. 15, 2018. We, SPORTON INTERNATIONAL INC. EMC & Wireless Communications Laboratory, would like to declare that the tested sample has been evaluated in accordance with the procedures given in ANSI / TIA-603-E-2016, ANSI C63.26-2015 and shown compliance with the applicable technical standards.

The report must not be used by the client to claim product certification, approval, or endorsement by TAF or any agency of government.

The test results in this report apply exclusively to the tested model / sample. Without written approval of SPORTON INTERNATIONAL INC. EMC & Wireless Communications Laboratory, the test report shall not be reproduced except in full.

Approved by: Jordan Hsiao

SPORTON INTERNATIONAL INC. EMC & Wireless Communications Laboratory

No. 52, Huaya 1st Rd., Guishan Dist., Taoyuan City, Taiwan (R.O.C.)



Table of Contents

History of this test report.....3

Summary of Test Result.....4

1 General Description5

1.1 Product Feature of Equipment Under Test5

1.2 Product Specification subjective to this standard.....5

1.3 Antenna Information5

1.4 Maximum EIRP Power, Frequency Tolerance, and Emission Designator.....6

1.5 Accessories6

1.6 Support Equipment.....6

1.7 Applicable Standards6

1.8 Testing Location7

2 Test Configuration of Equipment Under Test8

2.1 Test Mode.....8

2.2 Test Setup Diagram9

2.3 Measurement Results Explanation Example10

3 Test Result11

3.1 Conducted Output Power11

3.2 Maximum Effective Isotropic Radiated Power (EIRP).....13

3.3 Maximum Power Spectral Density (PSD)14

3.4 Reception limits15

3.5 Peak-to-Average Power Ratio (PAPR)16

3.6 99% Occupied Bandwidth (OBW) and 26dB Bandwidth.....17

3.7 3.5 GHz Emissions and Interference Limits18

3.8 Field Strength of Spurious Radiation19

3.9 Frequency Stability for Temperature & Voltage21

4 Test Equipment and Calibration Data22

5 Measurement Uncertainty23

Appendix A. Test Result of the Conducted Output Power

Appendix B. Test Result of the Maximum Effective Isotropic Radiated Power (EIRP)

Appendix C. Test Result of the Maximum Power Spectral Density (PSD)

Appendix D. Test Result of the Reception limits

Appendix E. Test Result of the Peak-to-Average Power Ratio (PAPR)

Appendix F. Test Result of the 99% Occupied Bandwidth (OBW) and 26dB Bandwidth

Appendix G. Test Result of the 3.5 GHz Emissions and Interference Limits

Appendix H. Test Result of the Field Strength of Spurious Radiation

Appendix I. Test Result of the Frequency Stability for Temperature & Voltage

Appendix J. Test Photos

Photographs of EUT v01



History of this test report

Report No.	Version	Description	Issued Date
FG850947AB	01	Initial issue of report	Jul. 16, 2018
FG850947AB	02	Add the the Frequency Error into Appendix I	Jul. 20, 2018
FG850947AB	03	Update the information of chapter 1.4	Aug. 30, 2018
FG850947AB	04	Add the test result for 20MHz to Appendix B.	Sep. 03, 2018



Summary of Test Result

Report Clause	Ref Std. Clause	Test Items	Result (PASS/FAIL)	Remark
3.1	2.1046	Conducted Output Power	PASS	-
3.2	96.41(b)	Maximum Effective Isotropic Radiated Power (EIRP)	PASS	-
3.3	96.41(b)	Maximum Power Spectral Density (PSD)	PASS	-
3.4	96.41(f)	Reception limits	PASS	-
3.5	96.41(g)	Peak-to-average power ratio	PASS	-
3.6	2.1049	99% OBW and 26dB Bandwidth	PASS	-
3.7	2.1051 96.41(e)	3.5 GHz Emissions and Interference Limits	PASS	-
3.8	2.1053	Field Strength of Spurious Radiation	PASS	-
3.9	2.1055	Frequency Stability for Temperature & Voltage	PASS	-

Reviewed by: Jordan Hsiao

Report Producer: Sharon Jiang



1 General Description

1.1 Product Feature of Equipment Under Test

Items	Description
Power Type	From PoE
EUT supports Radios application	LTE

1.2 Product Specification subjective to this standard

Items	Description
Base Station Classes	<input type="checkbox"/> Wide area Base Station (Macro Cell) <input checked="" type="checkbox"/> Medium Range Base Stations (Micro Cell) <input type="checkbox"/> Local area Base Station (Picocell) <input type="checkbox"/> Home Base Station (Femtocell)
Category of CBSD	<input type="checkbox"/> Category A <input checked="" type="checkbox"/> Category B
Professional Installation	<input checked="" type="checkbox"/> Yes <input type="checkbox"/> No
RF Test Tool Software of CBSD	Qualcomm SmallCell UUT Demo Client V1.0.306.003
TX Frequency	10MHz: 3555 MHz ~ 3695 MHz 20MHz: 3560 MHz ~ 3690 MHz
RX Frequency	10MHz: 3555 MHz ~ 3695 MHz 20MHz: 3560 MHz ~ 3690 MHz
Maximum Output Power to Antenna	27.09 dBm
Maximum 99% Occupied Bandwidth	17.82 MHz
Type of Modulation	<input checked="" type="checkbox"/> QPSK <input checked="" type="checkbox"/> 16QAM <input checked="" type="checkbox"/> 64QAM <input type="checkbox"/> 256QAM

1.3 Antenna Information

Ant.	Brand	Model Name	Antenna Type	Connector	Gain (dBi)
1	Ruckus	Q910-US00	Internal BeamFlex	I-PEX	3
2	Ruckus	Q910-US00	Internal BeamFlex	I-PEX	3

Note: Both Ant. 1 and Ant. 2 could transmit/receive simultaneously.



1.4 Maximum EIRP Power, Frequency Tolerance, and Emission Designator

FCC Rule	System	Bandwidth	Type of Modulation	Maximum EIRP (dBm/10MHz)	EIRP (W)	Maximum EIRP (dBm/20MHz)	EIRP (W)	Frequency Stability	Emission Designator
Part 96	LTE Band 48	10MHz	QPSK	29.95	0.989	-	-	With in the authorized bands of operation	8M93G7D
			16QAM	29.91	0.979	-	-		8M94W7D
			64QAM	29.95	0.989	-	-		8M92D9W
		20MHz	QPSK	-	-	30.09	1.021		17M8G7D
			16QAM	-	-	29.72	0.938		17M8W7D
			64QAM	-	-	29.72	0.938		17M8D9W

1.5 Accessories

Wall-mounted rack (Long)*1
 Wall-mounted rack (Short)*1

1.6 Support Equipment

Support Equipment				
No.	Equipment	Brand Name	Model Name	FCC ID
1	Notebook	DELL	E4300	N/A
2	PoE	Microsemi	PD-9001GR/AC	N/A
3	Spectrum	Agilent	N9010A	N/A

1.7 Applicable Standards

According to the specifications of the manufacturer, the EUT must comply with the requirements of the following standards:

- 47 CFR FCC Part2, 96
- ANSI / TIA-603-E-2016
- FCC KDB 971168 D01 v03r01
- FCC KDB 940660 D01 v01
- FCC KDB 412172 D01 v01r01
- ANSI C63.26-2015

Remark: All test items were verified and recorded according to the standards and without any deviation during the test.



1.8 Testing Location

Testing Location				
<input checked="" type="checkbox"/>	HWA YA	ADD : No. 52, Huaya 1st Rd., Guishan Dist., Taoyuan City, Taiwan (R.O.C.) TEL : 886-3-327-3456 FAX : 886-3-327-0973		
<input type="checkbox"/>	JHUBEI	ADD : No.8, Lane 724, Bo-ai St., Jhubei City, HsinChu County 302, Taiwan, R.O.C. TEL : 886-3-656-9065 FAX : 886-3-656-9085		
Test Condition	Test Site No.	Test Engineer	Test Environment	Test Date
RF Conducted	TH01-HY	Abner Tsai	24°C / 50%	May 08, 2018~Jun. 15, 2018
Radiated Emission	03CH03-HY	Abner Tsai	22°C / 54%	May 08, 2018~Jun. 15, 2018

Test site Designation No. TW1190 with FCC.

Test site registered number IC 4086B-1 with Industry Canada.



2 Test Configuration of Equipment Under Test

2.1 Test Mode

Test Item	Bandwidth (MHz)	Tested Frequency (MHz)	Mode
Conducted Output Power	10, 20	B,M,T	QPSK,16-QAM,64-QAM
Maximum Effective Isotropic Radiated Power (EIRP)	10, 20	B,M,T	QPSK,16-QAM,64-QAM
Maximum Power Spectral Density (PSD)	10, 20	B,M,T	QPSK,16-QAM,64-QAM
Reception limits	10, 20	B,M,T	-
Peak-to-average power ratio	10, 20	B,M,T	QPSK,16-QAM,64-QAM
99% OBW and 26dB Bandwidth	10, 20	B,M,T	QPSK,16-QAM,64-QAM
3.5 GHz Emissions and Interference Limits	10, 20	B,M,T	QPSK,16-QAM,64-QAM
Field Strength of Spurious Radiation	10, 20	B,M,T	QPSK,16-QAM,64-QAM
Frequency Stability for Temperature & Voltage	10, 20	B, T	QPSK,16-QAM,64-QAM

Note 1:

B: Bottom

M: Middle

T: Top

Note 2: It were performed at its Z-axis and Y-axis the worst-case was found at Y-axis for Field Strength of Spurious Radiation. So the measurement will follow this same test configuration.

2.2 Test Setup Diagram

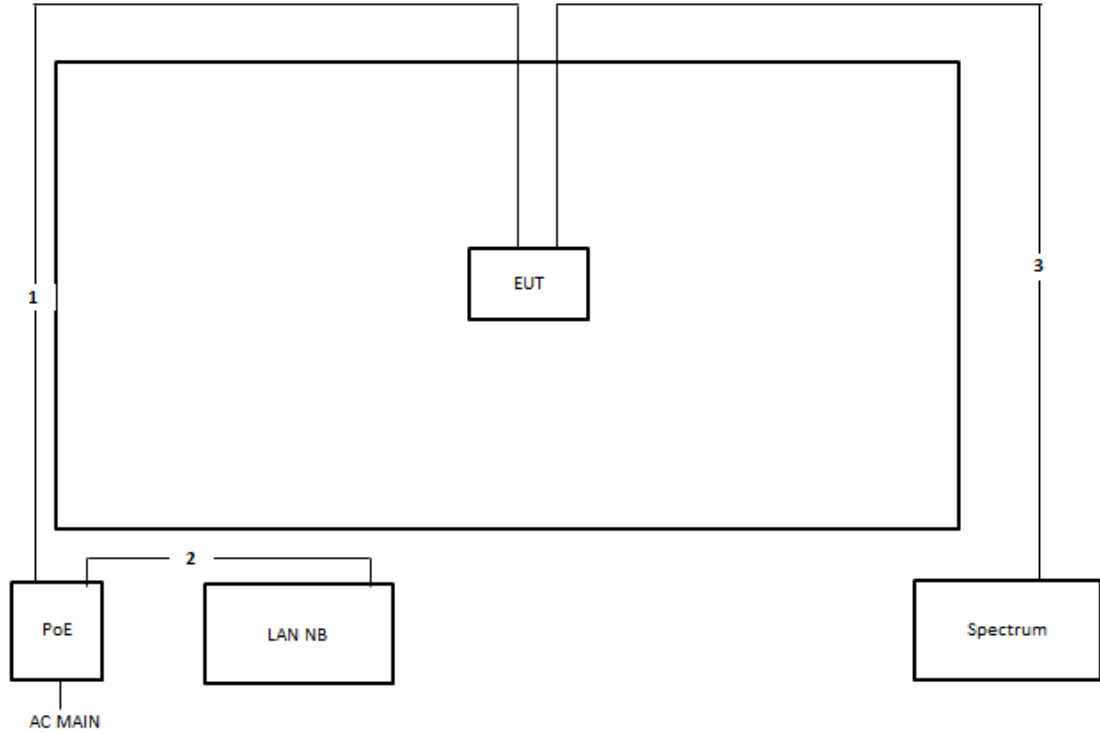

Item	Connection	Shielded	Length
1	RJ-45 cable	No	10m
2	RJ-45 cable	No	1.5m
3	RF cable	No	10m



2.3 Measurement Results Explanation Example

For all conducted test items:

The offset level is set in the spectrum analyzer to compensate the RF cable loss and attenuator factor between RF conducted output port and spectrum analyzer. With the offset compensation, the spectrum analyzer reading level will be exactly the RF output level.

The spectrum analyzer offset is derived from RF cable loss and attenuator factor.

Offset = RF cable loss + attenuator factor.

The following shows an offset computation example with RF cable loss 1 dB and a 20dB attenuator.

Example:

$$\begin{aligned} \text{Offset (dB)} &= \text{RF cable loss (dB)} + \text{attenuator factor (dB)} \\ &= 1 + 20 = 21 \text{ (dB)} \end{aligned}$$

For transmission duty cycle < 98% and setting sweep trigger to free run:

When the EUT cannot be configured to transmit at full-power on a continuous basis (i.e., duty cycle < 98%) and the instrumentation cannot be configured to measure only during active full-power transmissions, then set sweep trigger to free run and add $10 \log (1/\text{duty cycle})$ to the measured power level if the EUT duty cycle is constant (i.e., duty cycle variations are less than or equal to $\pm 2\%$).

Example:

Add $[10 \log (1/0.25)] = 6 \text{ dB}$ if the duty cycle is a constant 25%.



3 Test Result

3.1 Conducted Output Power

3.1.1 Description of the Conducted Output Power measurement

The EUT shall be set at maximum power through commands provided by manufacturer. The measured power in the radio frequency at the transmitter output terminals shall be reported.

3.1.2 Measuring Instruments

The measuring equipment is listed in the section 4 of this test report.

3.1.3 Test Procedures

1. Connect the transmitter output port of EUT to the spectrum analyzer.
2. Set EUT to transmit at maximum output power.
3. Select lowest, middle, and highest channels for each modulation.
4. Measure the maximum power at RF output terminals .

3.1.4 Test Setup

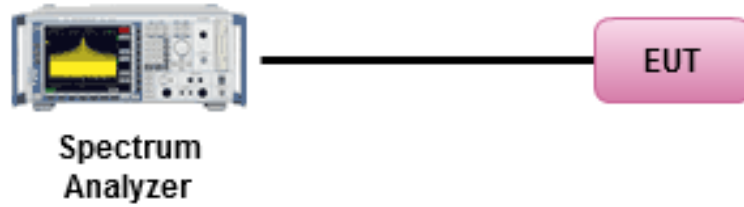

3.1.5 Test Result of Conducted Output Power

Refer as Appendix A

3.2 Maximum Effective Isotropic Radiated Power (EIRP)

3.2.1 Description of the Maximum Effective Isotropic Radiated Power measurement

The EUT shall be set at maximum power through commands provided by manufacturer, and the the EIRP limit shall apply to any 10 MHz portion of the bandwidth. The EIRP of category A CBSD shall be limited to 30dBm/10MHz, and the EIRP of category B CBSD shall be limited to 47dBm/10MHz. According to FCC KDB 940660 D01 v01

Power Approach, the EIRP can be determined from conducted output power.

$EIRP = P_T + G_T - L_C$, where

P_T = transmitter output power in dBm

G_T = gain of the transmitting antenna in dBi

L_C = signal attenuation in the connecting cable between the transmitter and antenna in dB

3.2.2 Measuring Instruments

The measuring equipment is listed in the section 4 of this test report.

3.2.3 Test Procedures

1. The testing follows Section 5.2 of ANSI C63.26-2015.
2. Connect the transmitter output port of EUT to the spectrum analyzer.
3. Set EUT to transmit at maximum output power.
4. Select lowest, middle, and highest channels for each modulation.
5. Measure the maximum power in any 10 MHz portion of the bandwidth at RF output terminals.
6. Determining EIRP by conducted RF output power plus transmitting antenna gain.

3.2.4 Test Setup

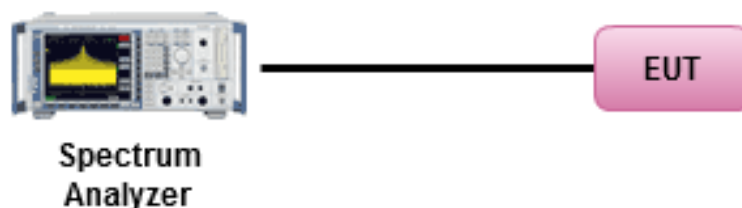

3.2.5 Test Result of Maximum Effective Isotropic Radiated Power

Refer as Appendix B

3.3 Maximum Power Spectral Density (PSD)

3.3.1 Description of the Maximum Power Spectral Density Measurement

The maximum power spectral density measurements, where the intent is to measure the maximum value of the time average of the power spectral density measured during a period of continuous transmission. To perform this measurement, the EUT must be configured to transmit continuously at maximum power. The PSD of category A CBSD shall be limited to 20dBm/MHz, and the EIRP of category B CBSD shall be limited to 37dBm/MHz.

3.3.2 Measuring Instruments

The measuring equipment is listed in the section 4 of this test report.

3.3.3 Test Procedures

1. The testing follows Section 5.2 of ANSI C63.26-2015.
2. Connect the transmitter output port of EUT to the spectrum analyzer.
3. Set EUT to transmit at maximum output power.
4. Select lowest, middle, and highest channels for each modulation.
5. Measure the maximum PSD at RF output terminals .

3.3.4 Test Setup

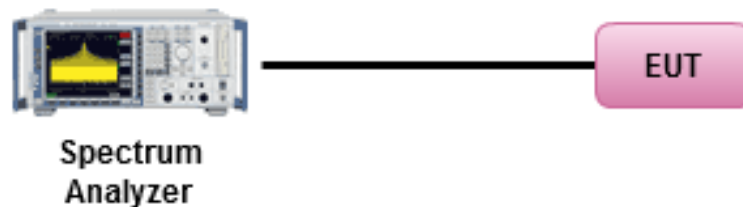

3.3.5 Test Result of Maximum Power spectral density

Refer as Appendix C

3.4 Reception limits

3.4.1 Description of the Reception limits Measurement

Priority Access Licensees must accept adjacent channel and in-band blocking interference (3550 and 3700 MHz) up to a power spectral density level not to exceed -40 dBm at receive antenna ports with greater than 99% probability when integrated over a 10 megahertz reference bandwidth.

3.4.2 Measuring Instruments

The measuring equipment is listed in the section 4 of this test report.

3.4.3 Test Procedures

1. Refer to the figure in 3.4.4 for connecting EUT and signal generator.
2. Generate the wanted signal and adjust the input level to specified (ex. -86.5dBm) power level.
3. Select lowest, middle, and highest channels for each modulation.
4. For adjacent channel interference, Set-up the interfering signals at the adjacent channel frequency and adjust the interfering signal level to -40dBm at receiver antenna ports.
5. For in-band blocking interference, Set-up the interfering signal in the range from 3550MHz to 3700MHz and adjust the interfering signal level to -40dBm at receiver antenna ports.
6. Measure and check the throughput of EUT greater than 99% probability.

3.4.4 Test Setup

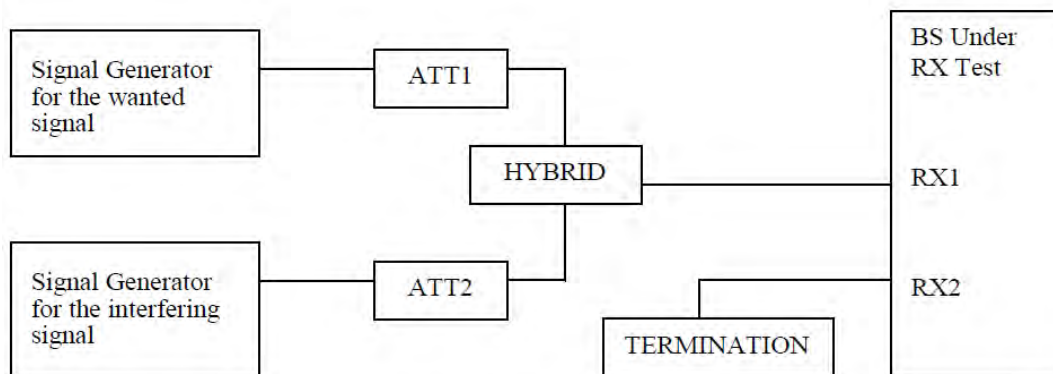

3.4.5 Test Result of Reception limits

Refer as Appendix D

3.5 Peak-to-Average Power Ratio (PAPR)

3.5.1 Description of the Peak-to-Average Power Ratio Measurement

The peak-to-average power ratio of the transmission may not exceed 13 dB.

3.5.2 Measuring Instruments

The measuring equipment is listed in the section 4 of this test report.

3.5.3 Test Procedures

1. The testing follows Section 5.2.6 of ANSI C63.26-2015.
2. Connect the transmitter output port of EUT to the spectrum analyzer.
3. Set EUT to transmit at maximum output power.
4. Select lowest, middle, and highest channels for each modulation.
5. Set the CCDF (Complementary Cumulative Distribution Function) option of the spectrum analyzer. Record the maximum PAPR level associated with a probability of 0.1%.

3.5.4 Test Setup

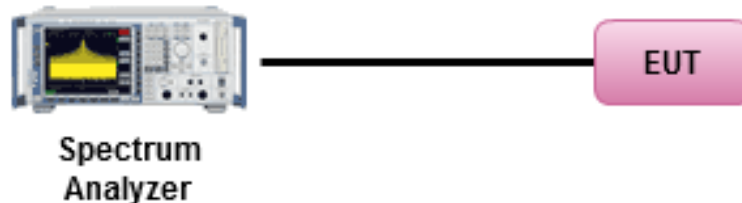

3.5.5 Test Result of Peak-to-Average Ratio

Refer as Appendix E

3.6 99% Occupied Bandwidth (OBW) and 26dB Bandwidth

3.6.1 Description of the 99% Occupied Bandwidth and 26dB Bandwidth Measurement

The 99% occupied bandwidth is the width of a frequency band such that, below the lower and above the upper frequency limits, the mean powers emitted are each equal to a specified percentage 0.5% of the total mean transmitted power.

The emission bandwidth is defined as the width of the signal between two points, located at the 2 sides of the carrier frequency, outside of which all emissions are attenuated at least 26 dB below the transmitter power.

3.6.2 Measuring Instruments

The measuring equipment is listed in the section 4 of this test report.

3.6.3 Test Procedures

1. Connect the transmitter output port of EUT to the spectrum analyzer.
2. Set EUT to transmit at maximum output power.
3. Select lowest, middle, and highest channels for each modulation.
4. The setting of spectrum analyzer follows the FCC KDB 971168 D01 v03r01 Section 4.2 and 4.3.
5. Record the result of 99% occupied bandwidth and the 26dB bandwidth.

3.6.4 Test Setup

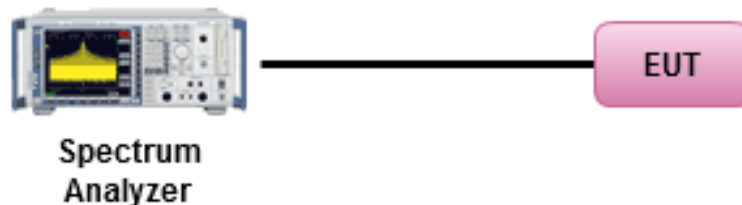

3.6.5 Test Result of Occupied Bandwidth and 26dB Bandwidth

Refer as Appendix F

3.7 3.5 GHz Emissions and Interference Limits

3.7.1 Description of the 3.5 GHz Emissions and Interference Limits Measurement

Confirm that the device satisfies the emission limits specified in Section 96.41(e) for all declared channel sizes, at the lowest and highest edges of the band, and in the middle of the band. The spectrum is scanned from 30 MHz up to a frequency including its 10th harmonic. The limits for emission outside the fundamental are as follows.

- Within 0 MHz to 10 MHz above and below the assigned channel ≤ -13 dBm/MHz
- Greater than 10 MHz above and below the assigned channel ≤ -25 dBm/MHz
- Any emission below 3530 MHz and above 3720 MHz ≤ -40 dBm/MHz

3.7.2 Measuring Instruments

The measuring equipment is listed in the section 4 of this test report.

3.7.3 Test Procedures

1. Connect the transmitter output port of EUT to the spectrum analyzer.
2. Set EUT to transmit at maximum output power.
3. Select lowest, middle, and highest channels for each modulation.
4. The setting of spectrum analyzer follows FCC KDB 940660 D01 v01 Section 6.0.
5. Note that unwanted emissions for CBSDs are relative to the authorized channel

3.7.4 Test Setup

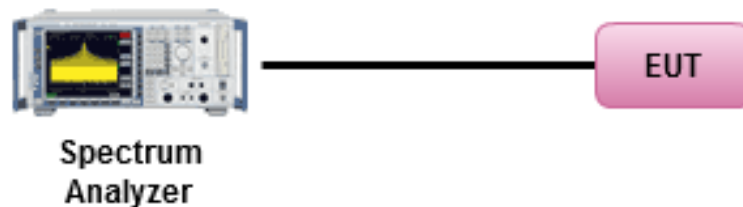

3.7.5 Test Result (Plots) of Conducted Band Edge

Refer as Appendix G



3.8 Field Strength of Spurious Radiation

3.8.1 Description of the Field Strength of Spurious Radiated Measurement

Confirm that the radiated emission satisfies the limits specified in Section 96.41(e) for all declared channel sizes, at the lowest and highest edges of the band, and in the middle of the band. The spectrum is scanned from 30 MHz up to a frequency including its 10th harmonic. The limits for emission outside the fundamental are as follows.

- Within 0 MHz to 10 MHz above and below the assigned channel ≤ -13 dBm/MHz (55.2 dBuV/m at 3m)
- Greater than 10 MHz above and below the assigned channel ≤ -25 dBm/MHz (82.2 dBuV/m at 3m)
- Any emission below 3530 MHz and above 3720 MHz ≤ -40 dBm/MHz (55.2 dBuV/m at 3m)

3.8.2 Measuring Instruments

The measuring equipment is listed in the section 4 of this test report.

3.8.3 Test Procedures

1. The testing follows Section 5.7 of ANSI C63.26-2015.
2. The EUT was placed on a rotatable wooden table 0.8 meters above the ground.
3. The EUT was set 3 meters from the receiving antenna, which was mounted on the antenna tower.
4. The table was rotated 360 degrees to determine the position of the highest spurious emission.
5. The height of the receiving antenna is varied between one meter and four meters to search for the maximum spurious emission for both horizontal and vertical polarizations.
6. Make the measurement with the spectrum analyzer's RBW = 1MHz, VBW = 3MHz, taking record of maximum spurious emission.
7. A horn antenna was substituted in place of the EUT and was driven by a signal generator.
8. Tune the output power of signal generator to the same emission level with EUT maximum spurious emission.
9. Taking the record of output power at antenna port.
10. Repeat step 7 to step 8 for another polarization.
11. The RF fundamental frequency should be excluded against the limit line in the operating frequency band.

3.8.4 Test Setup

For radiated emissions from 30MHz to 1GHz

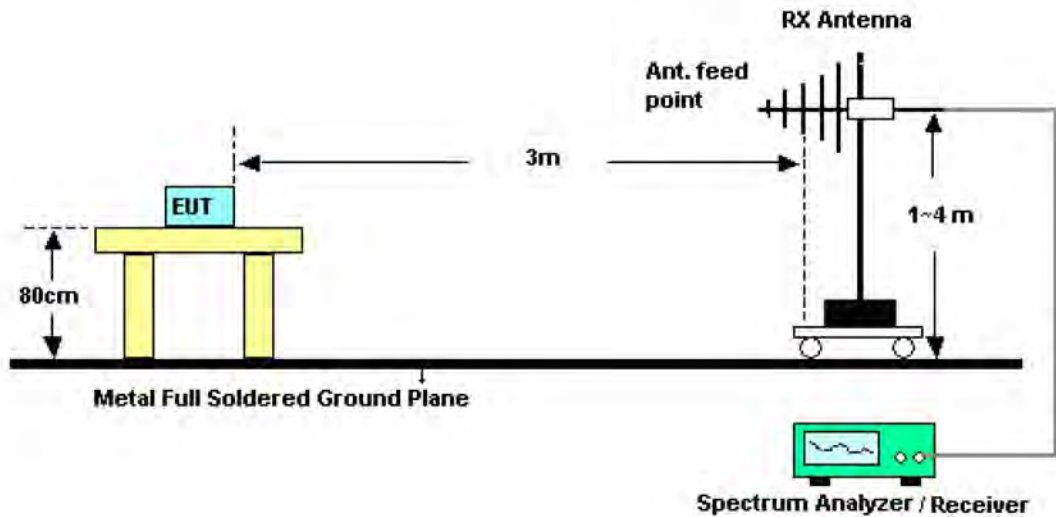

For radiated emissions above 1GHz

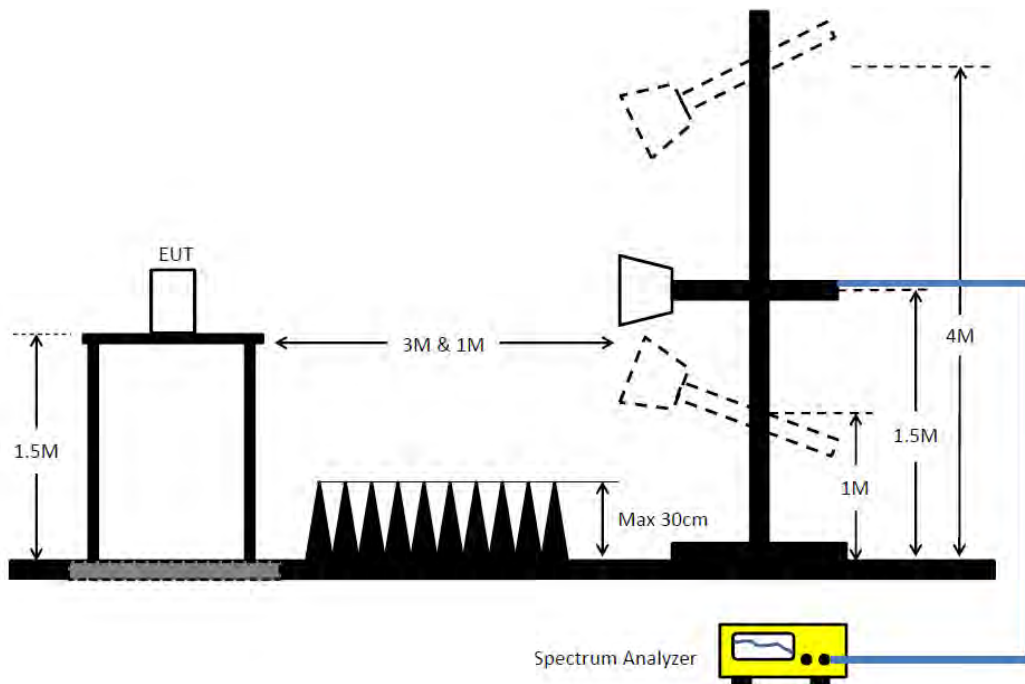

3.8.5 Test Result of Field Strength of Spurious Radiated

Refer as Appendix H

3.9 Frequency Stability for Temperature & Voltage

3.9.1 Description of the Frequency Stability for Temperature & Voltage Measurement

The frequency stability of the transmitter shall be measured while varying the ambient temperatures and supply voltages over the ranges specified in Section 2.1055. And ensure that the fundamental emission stays within the authorized frequency block.

3.9.2 Measuring Instruments

The measuring equipment is listed in the section 4 of this test report.

3.9.3 Test Procedures for Temperature Variation

1. The testing follows FCC KDB 971168 D01 v03r01 Section 9.0
2. The EUT was set up in the thermal chamber and connected to the spectrum analyzer.
3. With power OFF, the temperature was decreased to -40°C and the EUT was stabilized before testing. Power was applied and the maximum change in frequency was recorded within one minute.
4. With power OFF, the temperature was raised in -40°C steps up to 65°C. The EUT was stabilized at each step for at least half an hour. Power was applied and the maximum frequency change was recorded within one minute.
5. Frequency measurements shall be made at intervals of not more than 10° centigrade through the range.

3.9.4 Test Procedures for Voltage Variation

1. The testing follows FCC KDB 971168 D01 v03r01 Section 9.0.
2. The EUT was placed in a temperature chamber at 25±5° C and connected to the spectrum analyzer.
3. The power supply voltage to the EUT was varied from 85 to 115% of the nominal value measured at the input to the EUT.
4. The variation in frequency was measured for the worst case.

3.9.5 Test Setup

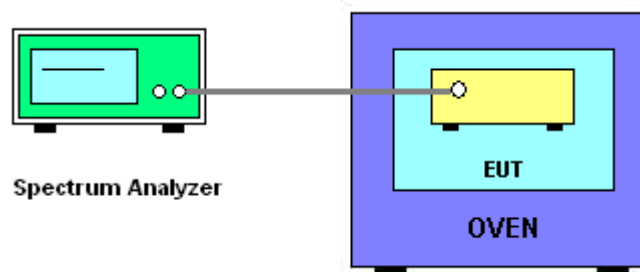

3.9.6 Test Result of Temperature and Voltage Variation

Refer as Appendix I



4 Test Equipment and Calibration Data

Instrument	Manufacturer	Model No.	Serial No.	Characteristics	Calibration Date	Calibration Due Date	Remark
Signal analyzer	Agilent	N9010A	MY52220519	10kHz~44GHz	Mar. 20, 2018	Mar. 19, 2019	Radiation (03CH03-HY)
3m Semi Anechoic Chamber	SIDT FRANKONIA	SAC-3M	03CH03-HY	30MHz ~ 1GHz 3m	Oct. 31, 2017	Oct. 30, 2018	Radiation (03CH03-HY)
3m Semi Anechoic Chamber	SIDT FRANKONIA	SAC-3M	03CH03-HY	1GHz ~ 18GHz 3m	Nov. 01, 2017	Oct. 31, 2018	Radiation (03CH03-HY)
Amplifier	HP	8447D	2944A08033	10kHz ~ 1.3GHz	Apr. 23, 2018	Apr. 19, 2019	Radiation (03CH03-HY)
Microwave System Preamplifier	KEYSIGHT	83017A	MY53270196	1GHz ~ 26.5GHz	Aug. 31, 2017	Aug. 30, 2018	Radiation (03CH03-HY)
Preamplifier	MITEQ	TTA1840-35-H G	1864481	18GHz ~ 40GHz	Aug. 31, 2017	Aug. 30, 2018	Radiation (03CH03-HY)
Broadband Horn Antenna	SCHWARZBE CK	BBHA 9170	BBHA 9170154	18GHz ~ 40GHz	Feb. 06, 2018	Feb. 05, 2019	Radiation (03CH03-HY)
Signal analyzer	Agilent	N9010A	MY52220519	10kHz~44GHz	Mar. 20, 2018	Mar. 19, 2019	Conducted (TH01-HY)
Temp. and Humidity Chamber	Ten Billion	TTH-D3SP	TBN-931011	-30~100 degree	Jun. 02, 2017	Jun. 01, 2018	Conducted (TH01-HY)
Temp. and Humidity Chamber	Ten Billion	TTH-D3SP	TBN-931011	-30~100 degree	Jun. 01, 2018	May 31, 2019	Conducted (TH01-HY)
RF Cable-high	Woken	RG402	High Cable-06	1 GHz ~ 26.5 GHz	Oct. 11, 2017	Oct. 10, 2018	Conducted (TH01-HY)
RF Cable-high	Woken	RG402	High Cable-07	1 GHz ~ 26.5 GHz	Oct. 11, 2017	Oct. 10, 2018	Conducted (TH01-HY)
RF Cable-high	Woken	RG402	High Cable-08	1 GHz ~ 26.5 GHz	Oct. 11, 2017	Oct. 10, 2018	Conducted (TH01-HY)
RF Cable-high	Woken	RG402	High Cable-09	1 GHz ~ 26.5 GHz	Oct. 11, 2017	Oct. 10, 2018	Conducted (TH01-HY)
RF Cable-high	Woken	RG402	High Cable-10	1 GHz ~ 26.5 GHz	Oct. 11, 2017	Oct. 10, 2018	Conducted (TH01-HY)
Power Sensor	Agilent	U2021XA	MY53410001	50MHz~18GHz	Nov. 20, 2017	Nov. 19, 2018	Conducted (TH01-HY)
MW Analog Signal Generator	Keysight	N5183A	MY50142965	100kHz~20GHz	Nov. 24, 2017	Nov. 23, 2018	Conducted (TH01-HY)
Vector Signal Generator	Keysight	N5182B	MY53052408	9kHz~6GHz	Jan. 02, 2018	Jan. 01, 2019	Conducted (TH01-HY)

Note: Calibration Interval of instruments listed above is one year.



5 Measurement Uncertainty

Test Items	Uncertainty	Remark
Radiated Emission (30MHz ~ 1,000MHz)	4.3 dB	Confidence levels of 95%
Radiated Emission (1GHz ~ 18GHz)	3.9 dB	Confidence levels of 95%
Radiated Emission (18GHz ~ 40GHz)	3.5 dB	Confidence levels of 95%
Conducted Emission	1.3 dB	Confidence levels of 95%



Summary

Mode	Power (dBm)	Power (W)
Band 48	-	-
Band 48_LTE_10MHz_(QPSK)_2TX	26.95	0.495
Band 48_LTE_10MHz_(16QAM)_2TX	26.91	0.491
Band 48_LTE_10MHz_(64QAM)_2TX	26.95	0.495
Band 48_LTE_20MHz_(QPSK)_2TX	27.09	0.512
Band 48_LTE_20MHz_(16QAM)_2TX	26.72	0.470
Band 48_LTE_20MHz_(64QAM)_2TX	26.72	0.470

Result

Mode	Result	RB	DG (dBi)	P1 (dBm)	P2 (dBm)	Power (dBm)	Power (W)
Band 48_LTE_10MHz_(QPSK)_2TX	-	-	-	-	-	-	-
3555MHz	Pass	50	3.00	23.38	23.00	26.20	0.417
3625MHz	Pass	50	3.00	23.09	22.66	25.89	0.388
3695MHz	Pass	50	3.00	24.01	23.86	26.95	0.495
Band 48_LTE_10MHz_(16QAM)_2TX	-	-	-	-	-	-	-
3555MHz	Pass	50	3.00	23.04	23.04	26.05	0.403
3625MHz	Pass	50	3.00	23.04	22.62	25.85	0.385
3695MHz	Pass	50	3.00	23.82	23.97	26.91	0.491
Band 48_LTE_10MHz_(64QAM)_2TX	-	-	-	-	-	-	-
3555MHz	Pass	50	3.00	23.37	23.28	26.34	0.431
3625MHz	Pass	50	3.00	23.15	23.16	26.17	0.414
3695MHz	Pass	50	3.00	23.95	23.93	26.95	0.495
Band 48_LTE_20MHz_(QPSK)_2TX	-	-	-	-	-	-	-
3560MHz	Pass	100	3.00	22.76	23.63	26.23	0.420
3625MHz	Pass	100	3.00	23.44	23.22	26.34	0.431
3690MHz	Pass	100	3.00	24.15	24.00	27.09	0.512
Band 48_LTE_20MHz_(16QAM)_2TX	-	-	-	-	-	-	-
3560MHz	Pass	100	3.00	22.93	23.63	26.30	0.427
3625MHz	Pass	100	3.00	23.19	23.25	26.23	0.420
3690MHz	Pass	100	3.00	23.96	23.44	26.72	0.470
Band 48_LTE_20MHz_(64QAM)_2TX	-	-	-	-	-	-	-
3560MHz	Pass	100	3.00	22.99	23.69	26.36	0.433
3625MHz	Pass	100	3.00	22.92	23.02	25.98	0.396
3690MHz	Pass	100	3.00	23.67	23.75	26.72	0.470

DG = Directional Gain; **Port X** = Port X output power

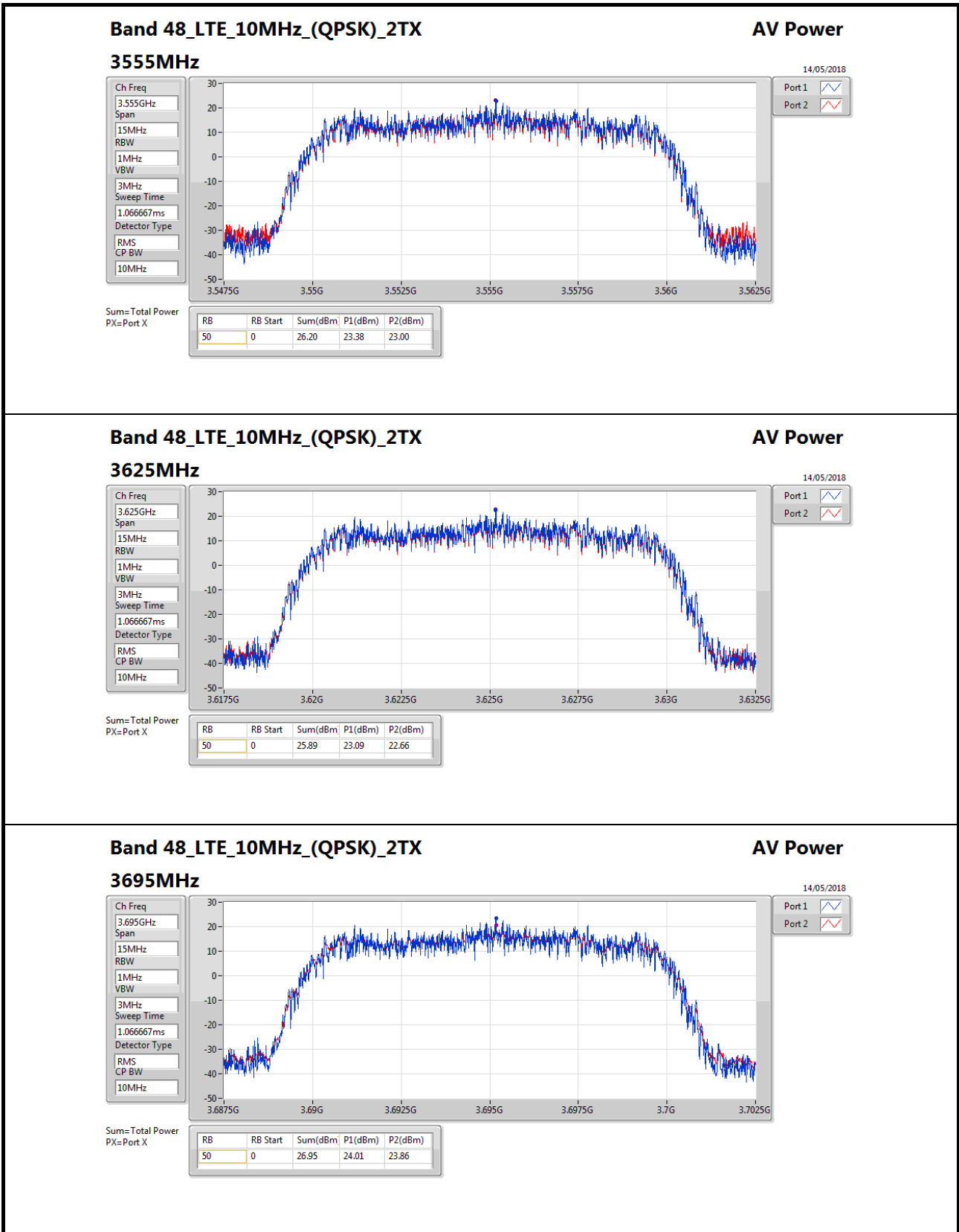

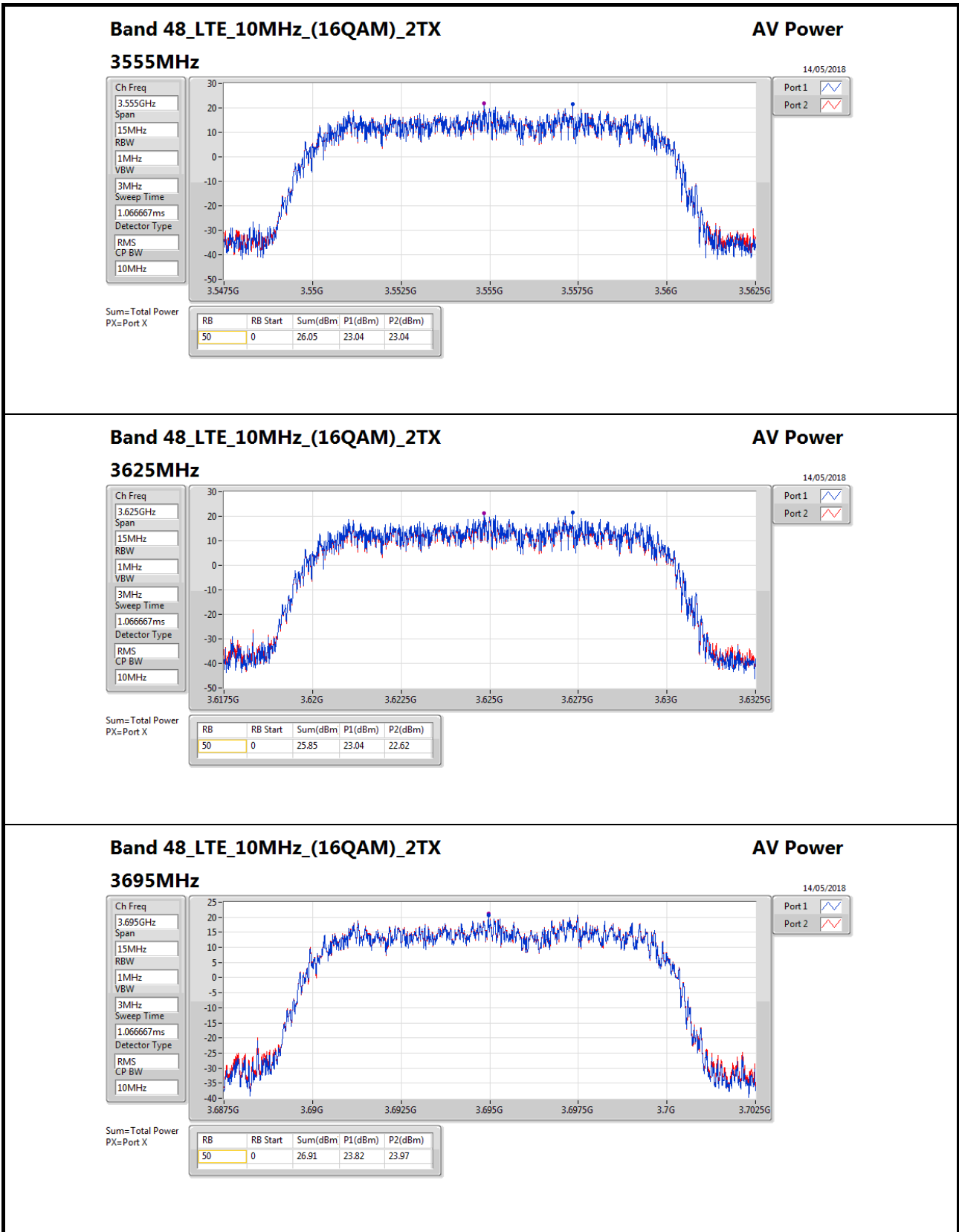

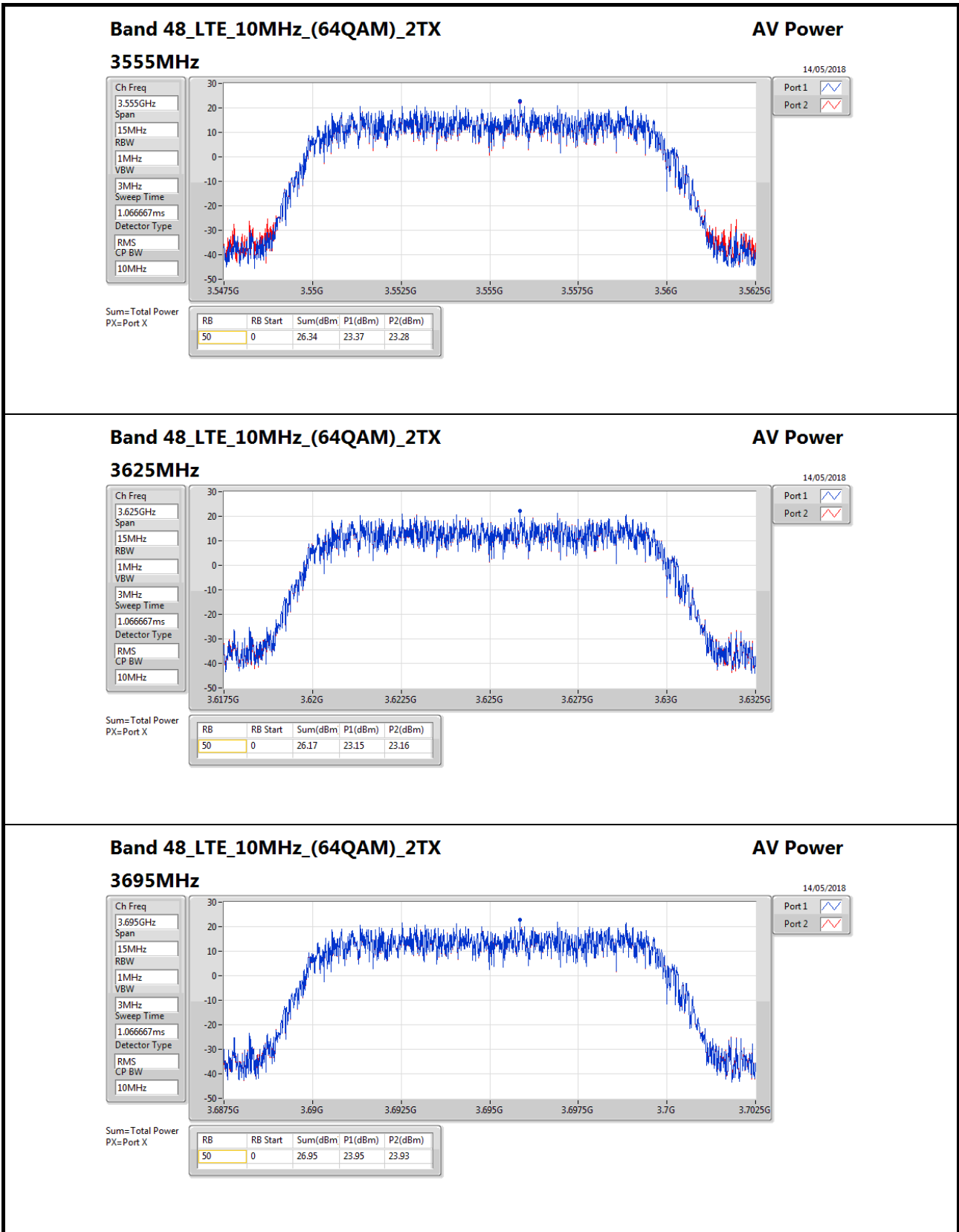

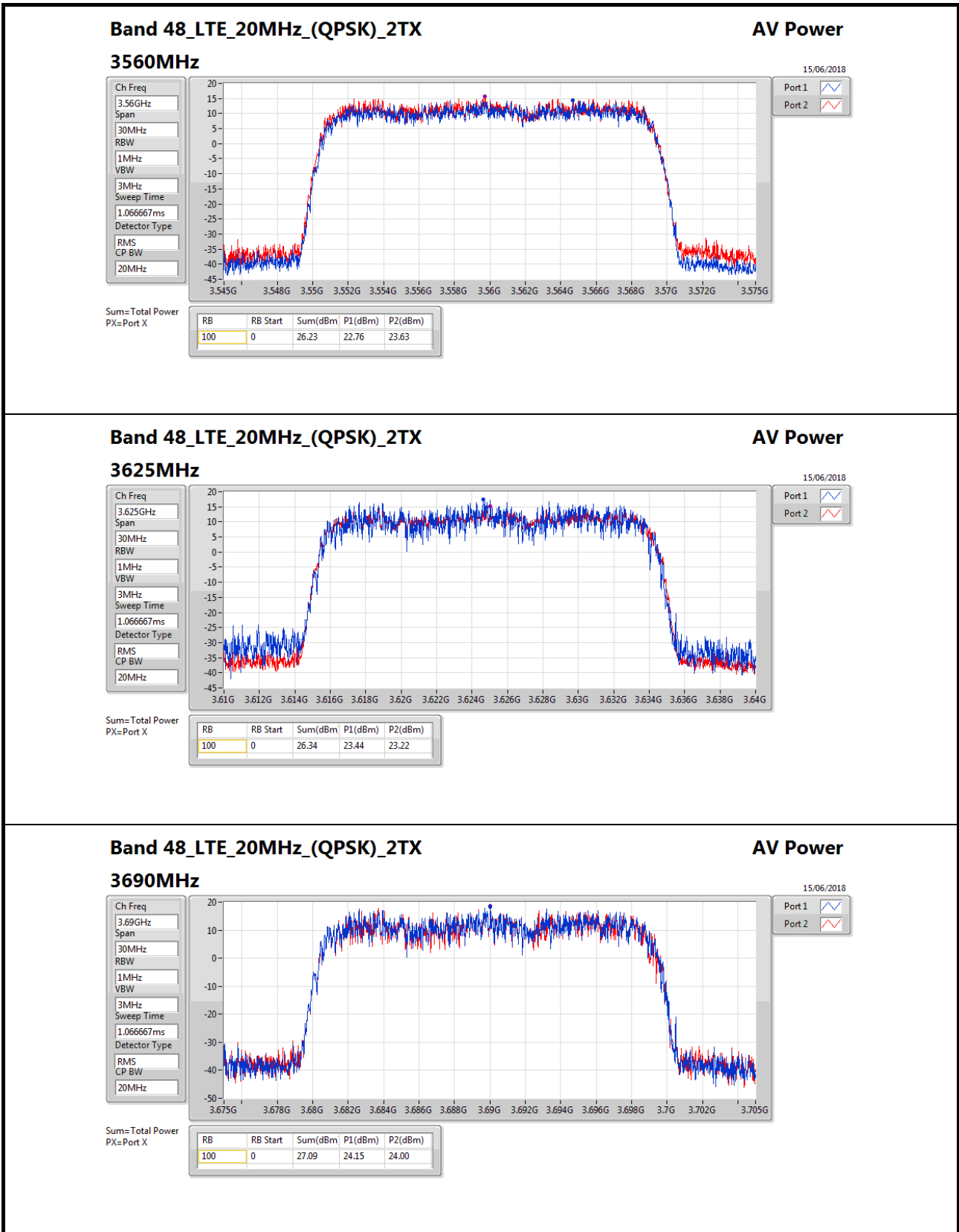

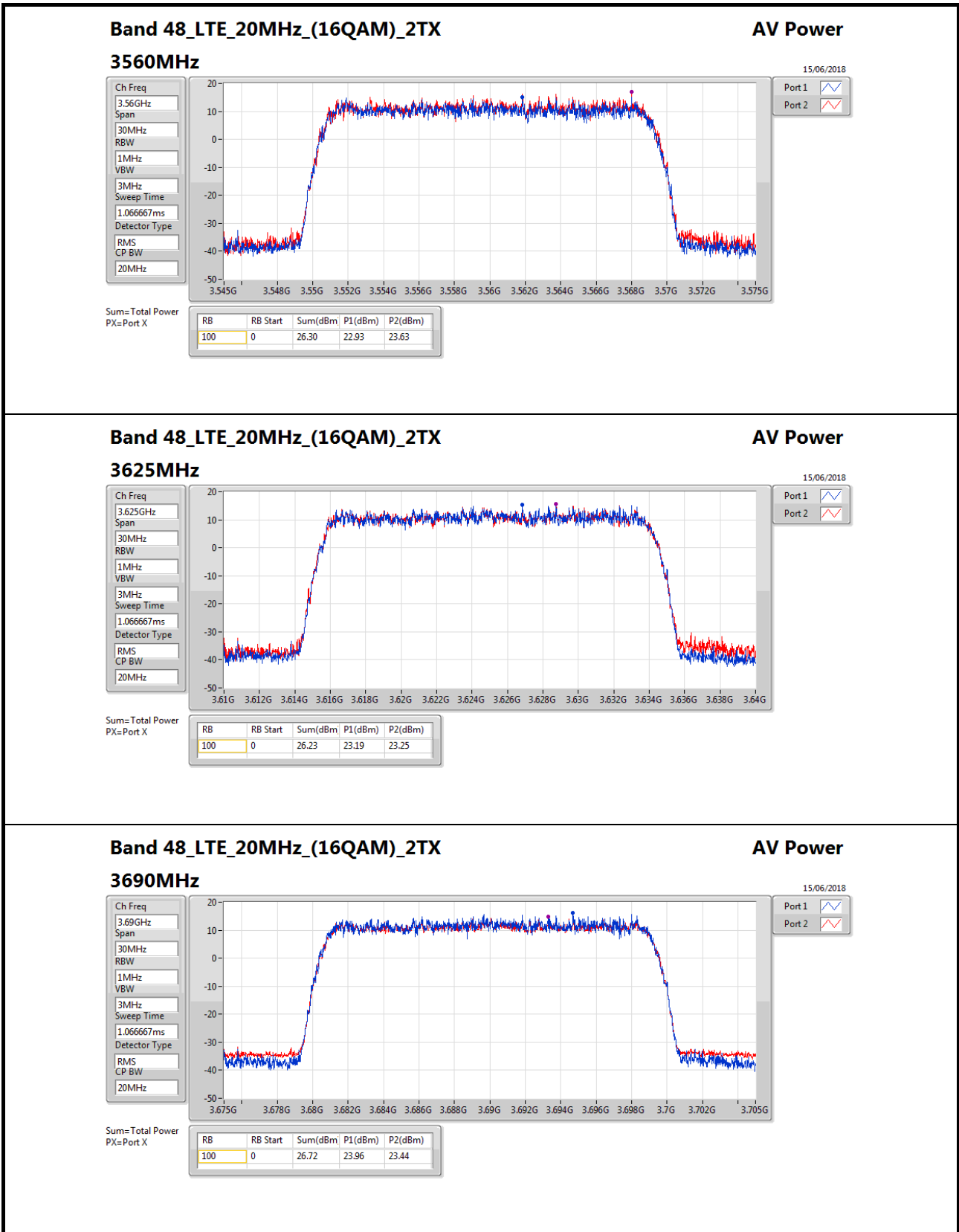

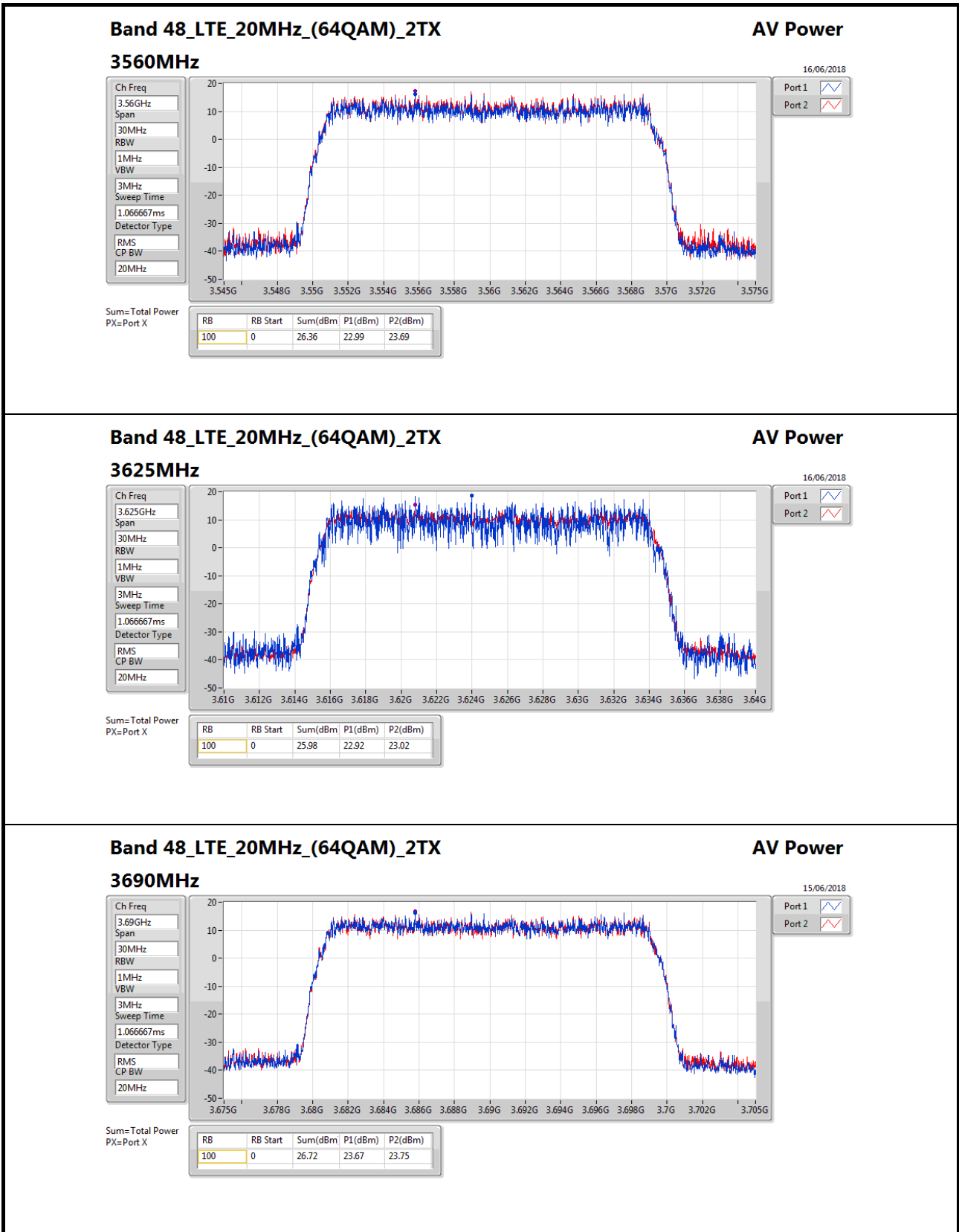



Summary

Mode	Power (dBm/10MHz)	Power (W)	EIRP (dBm/10MHz)	EIRP (W)
Band 48	-	-	-	-
Band 48_LTE_10MHz_(QPSK)_2TX	26.95	0.495	29.95	0.989
Band 48_LTE_10MHz_(16QAM)_2TX	26.91	0.491	29.91	0.979
Band 48_LTE_10MHz_(64QAM)_2TX	26.95	0.495	29.95	0.989
Band 48_LTE_20MHz_(QPSK)_2TX	23.44	0.221	26.44	0.44055
Band 48_LTE_20MHz_(16QAM)_2TX	23.71	0.235	26.71	0.46881
Band 48_LTE_20MHz_(64QAM)_2TX	24.66	0.292	27.66	0.58345

Result

Mode	RB	DG (dBi)	P1 (dBm/10 Mhz)	P2 (dBm/10 Mhz)	Power (dBm/10 Mhz)	Power (W)	EIRP (dBm/10 Mhz)	EIRP (W)	EIRP Lim. (W)	Result
Band 48_LTE_10MHz_(QPSK)_2TX	-	-	-	-	-	-	-	-	-	-
3555MHz	50	3.00	23.38	23.00	26.20	0.417	29.20	0.832	50.11	Pass
3625MHz	50	3.00	23.09	22.66	25.89	0.388	28.89	0.774	50.11	Pass
3695MHz	50	3.00	24.01	23.86	26.95	0.495	29.95	0.989	50.11	Pass
Band 48_LTE_10MHz_(16QAM)_2TX	-	-	-	-	-	-	-	-	-	-
3555MHz	50	3.00	23.04	23.04	26.05	0.403	29.05	0.804	50.11	Pass
3625MHz	50	3.00	23.04	22.62	25.85	0.385	28.85	0.767	50.11	Pass
3695MHz	50	3.00	23.82	23.97	26.91	0.491	29.91	0.979	50.11	Pass
Band 48_LTE_10MHz_(64QAM)_2TX	-	-	-	-	-	-	-	-	-	-
3555MHz	50	3.00	23.37	23.28	26.34	0.431	29.34	0.859	50.11	Pass
3625MHz	50	3.00	23.15	23.16	26.17	0.414	29.17	0.826	50.11	Pass
3695MHz	50	3.00	23.95	23.93	26.95	0.495	29.95	0.989	50.11	Pass
Band 48_LTE_20MHz_(QPSK)_2TX	-	-	-	-	-	-	-	-	-	-
3560MHz	100	3.00	19.45	19.01	22.25	0.168	25.25	0.33497	50.11	Pass
3625MHz	100	3.00	19.67	19.00	22.36	0.172	25.36	0.34356	50.11	Pass
3690MHz	100	3.00	20.71	20.12	23.44	0.221	26.44	0.44055	50.11	Pass
Band 48_LTE_20MHz_(16QAM)_2TX	-	-	-	-	-	-	-	-	-	-
3560MHz	100	3.00	19.63	19.61	22.63	0.183	25.63	0.36559	50.11	Pass
3625MHz	100	3.00	20.05	19.29	22.70	0.186	25.70	0.37154	50.11	Pass
3690MHz	100	3.00	21.08	20.28	23.71	0.235	26.71	0.46881	50.11	Pass
Band 48_LTE_20MHz_(64QAM)_2TX	-	-	-	-	-	-	-	-	-	-
3560MHz	100	3.00	21.62	21.26	24.45	0.279	27.45	0.55590	50.11	Pass
3625MHz	100	3.00	21.27	21.14	24.22	0.264	27.22	0.52723	50.11	Pass
3690MHz	100	3.00	21.45	21.84	24.66	0.292	27.66	0.58345	50.11	Pass

DG = Directional Gain; Port X = Port X output power



Maximum Effective Isotropic Radiated Power Result

Appendix B

Mode	RB	DG (dBi)	P1 (dBm/20 Mhz)	P2 (dBm/20 Mhz)	Power (dBm/20 Mhz)	Power (W)	EIRP (dBm/20 Mhz)	EIRP (W)	EIRP Lim. (W)	Result
Band 48_LTE_20MHz_(QPSK)_2TX	-	-	-	-	-	-	-	-	-	-
3560MHz	100	3.00	22.76	23.63	26.23	0.420	29.23	0.83753	N/A	Pass
3625MHz	100	3.00	23.44	23.22	26.34	0.431	29.34	0.85901	N/A	Pass
3690MHz	100	3.00	24.15	24.00	27.09	0.512	30.09	1.02094	N/A	Pass
Band 48_LTE_20MHz_(16QAM)_2TX	-	-	-	-	-	-	-	-	-	-
3560MHz	100	3.00	22.93	23.63	26.30	0.427	29.30	0.85114	N/A	Pass
3625MHz	100	3.00	23.19	23.25	26.23	0.420	29.23	0.83753	N/A	Pass
3690MHz	100	3.00	23.96	23.44	26.72	0.470	29.72	0.93756	N/A	Pass
Band 48_LTE_20MHz_(64QAM)_2TX	-	-	-	-	-	-	-	-	-	-
3560MHz	100	3.00	22.99	23.69	26.36	0.433	29.36	0.86298	N/A	Pass
3625MHz	100	3.00	22.92	23.02	25.98	0.396	28.98	0.79068	N/A	Pass
3690MHz	100	3.00	23.67	23.75	26.72	0.470	29.72	0.93756	N/A	Pass

Note: The E.I.R.P per 20MHz bandwidth is calculated based on "Conducted output power + DG"
DG = Directional Gain; **Port X** = Port X output power

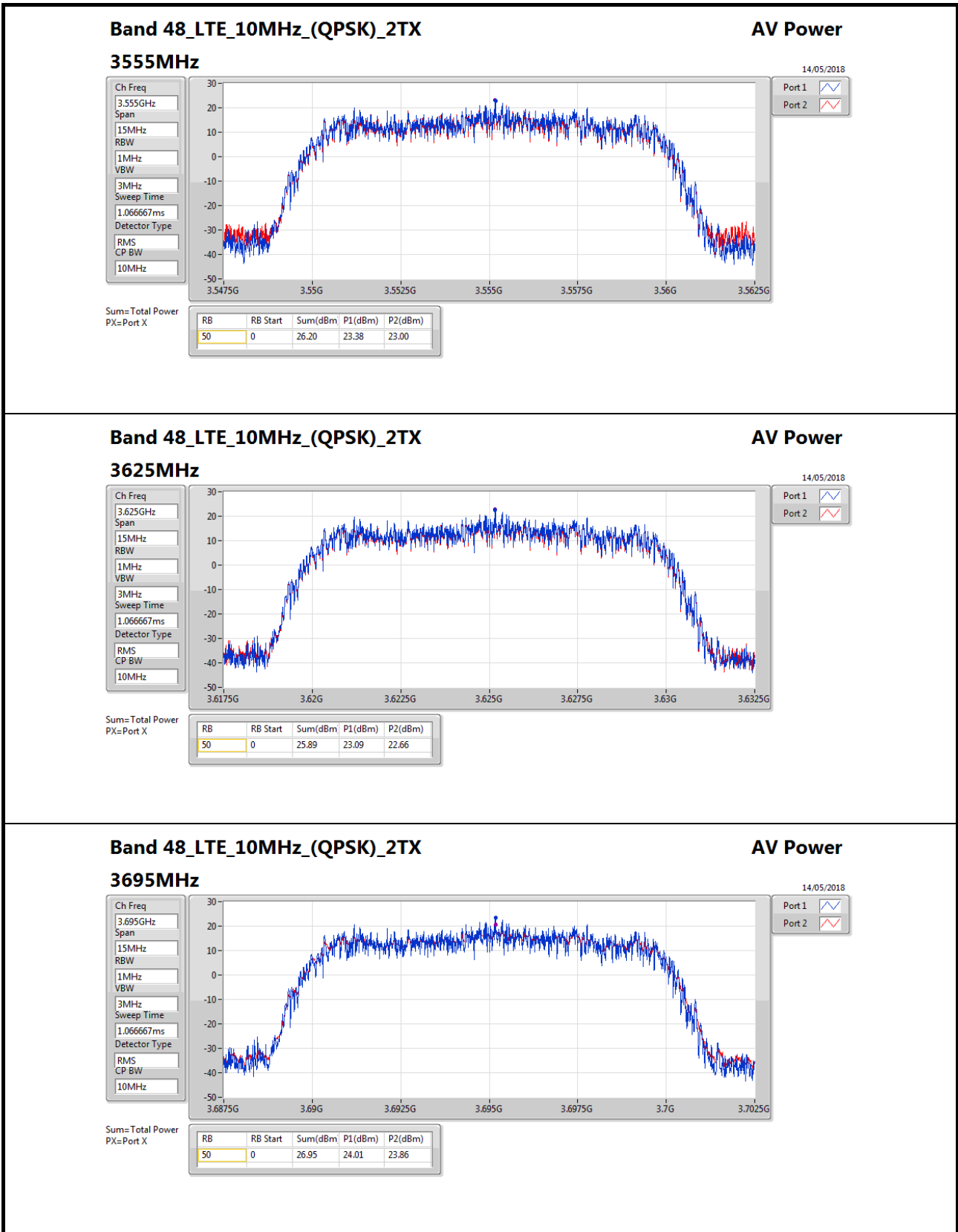

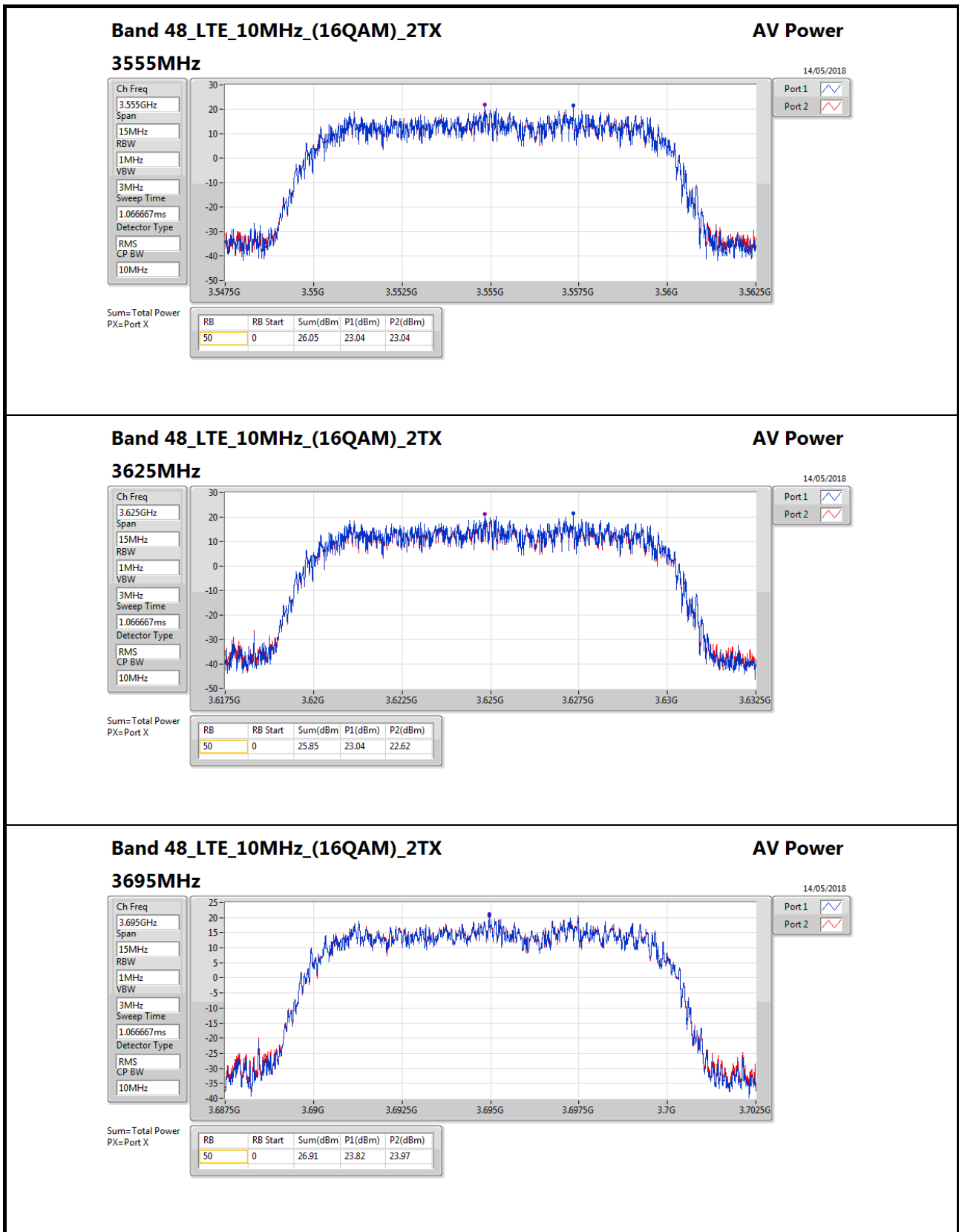

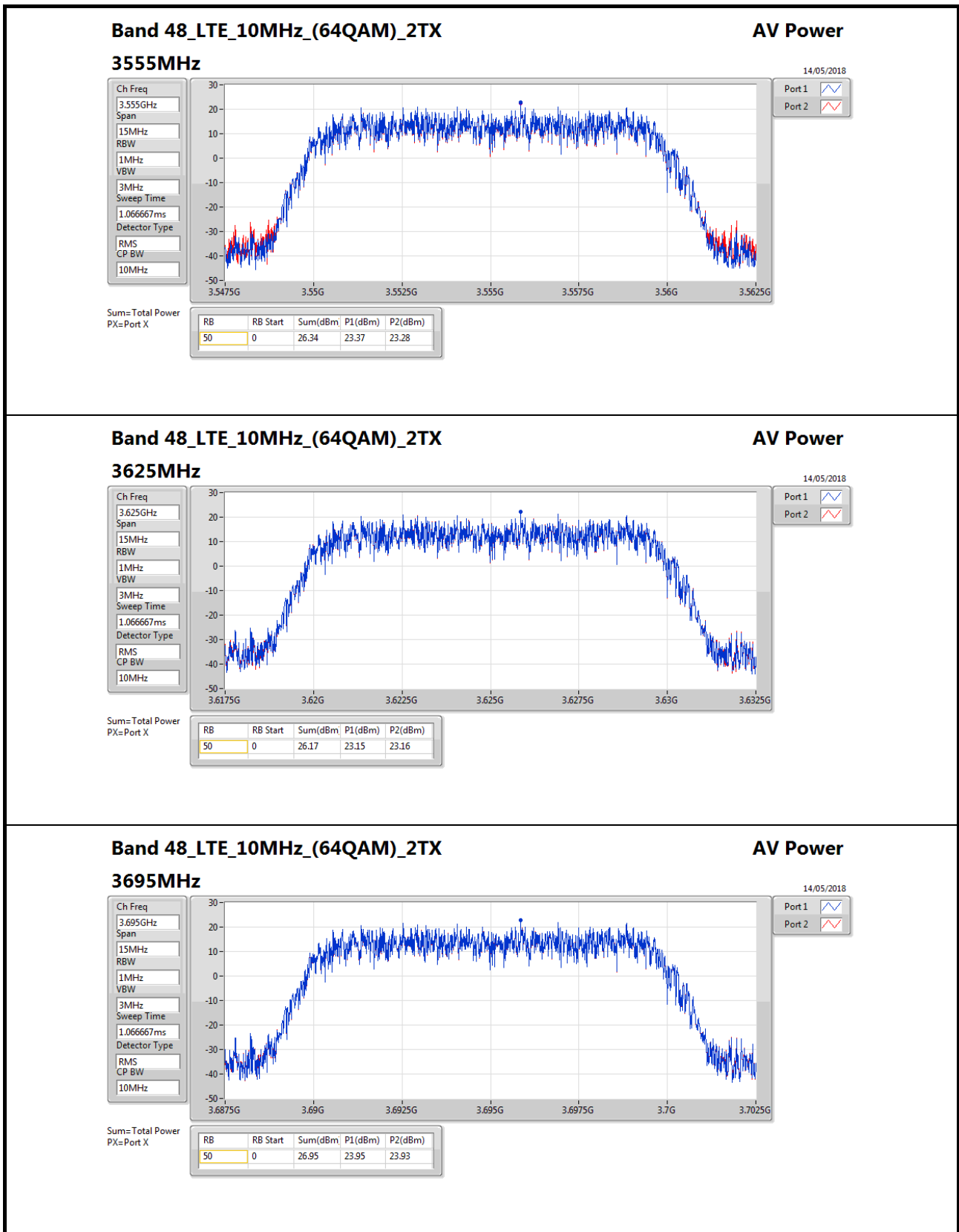

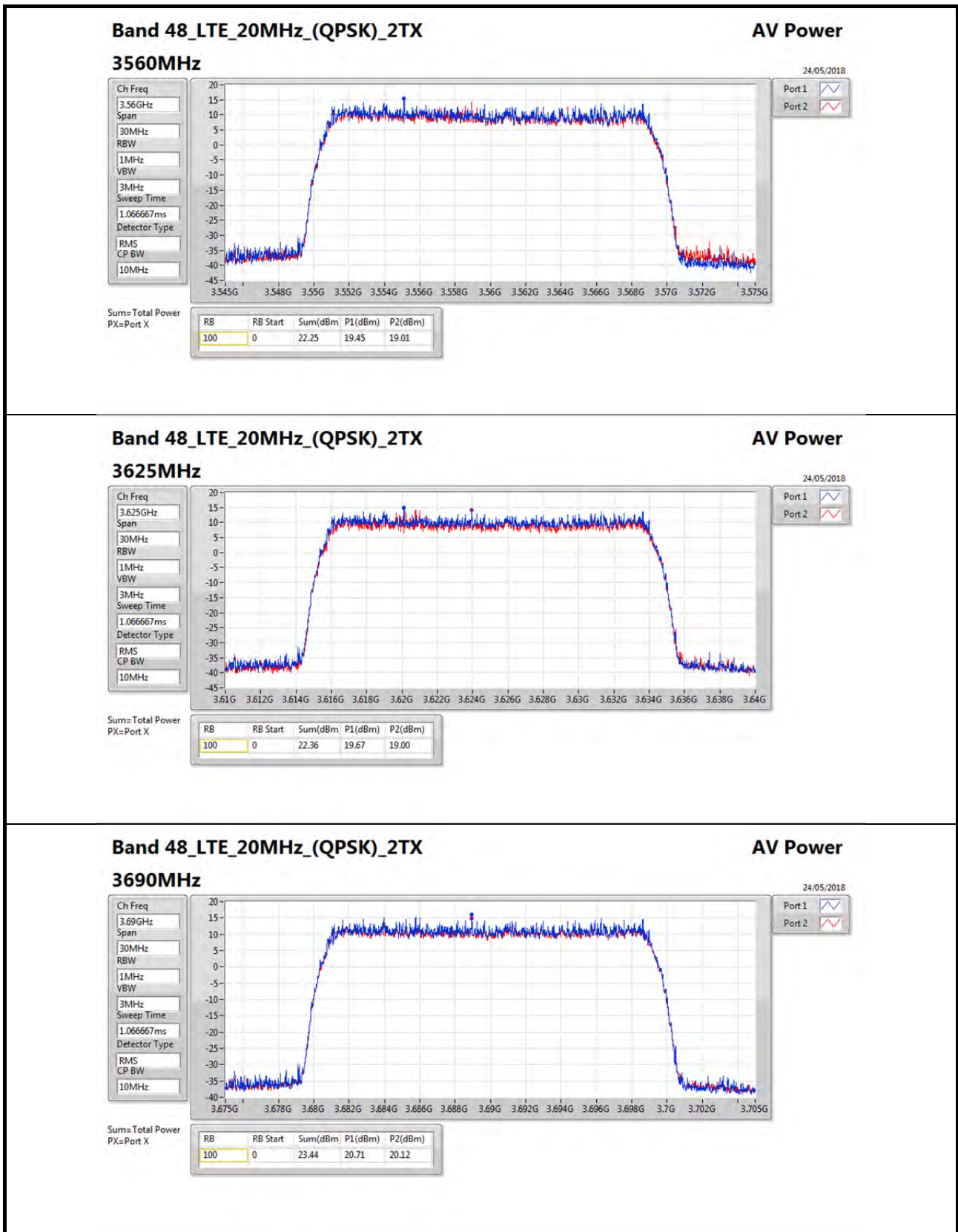

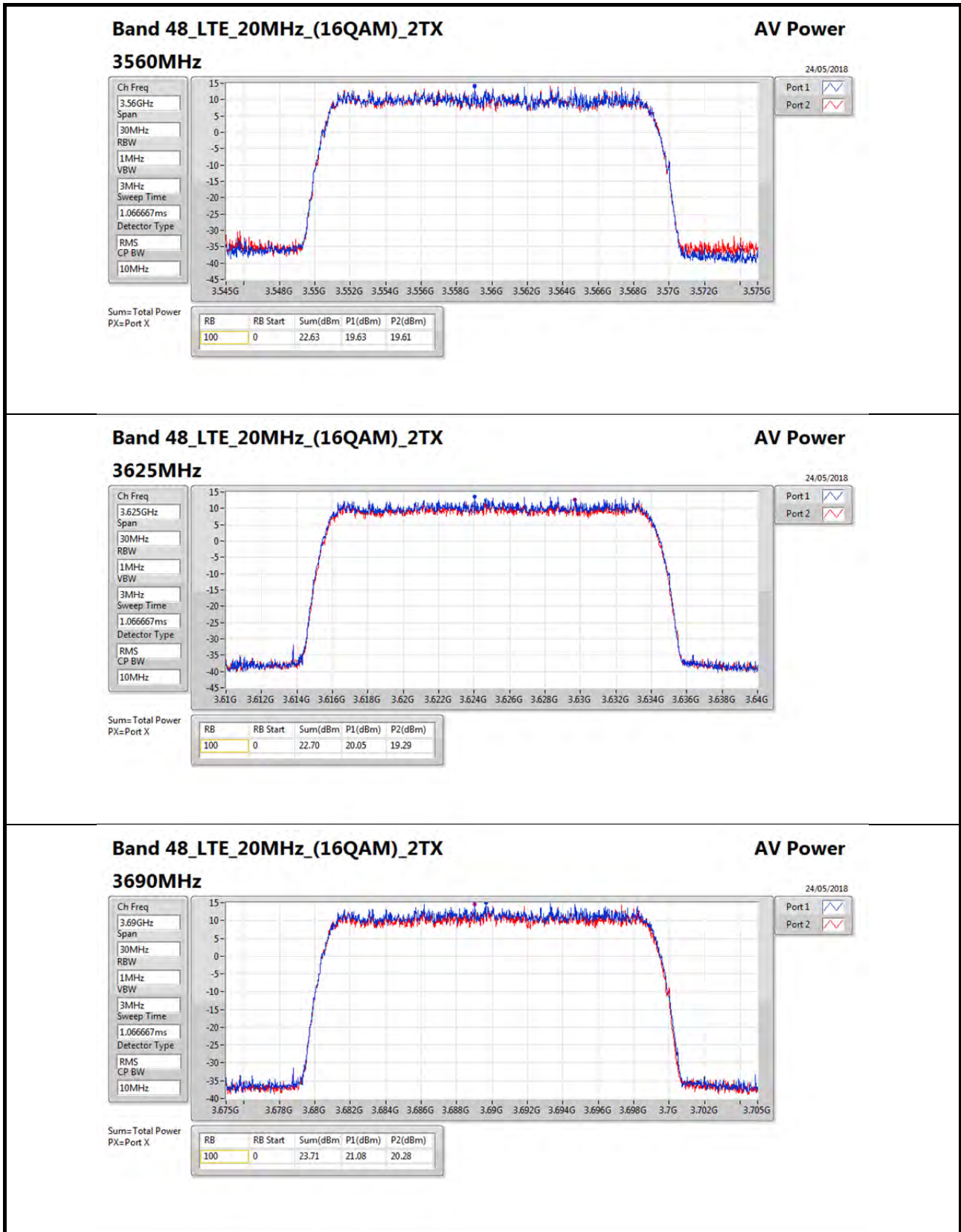

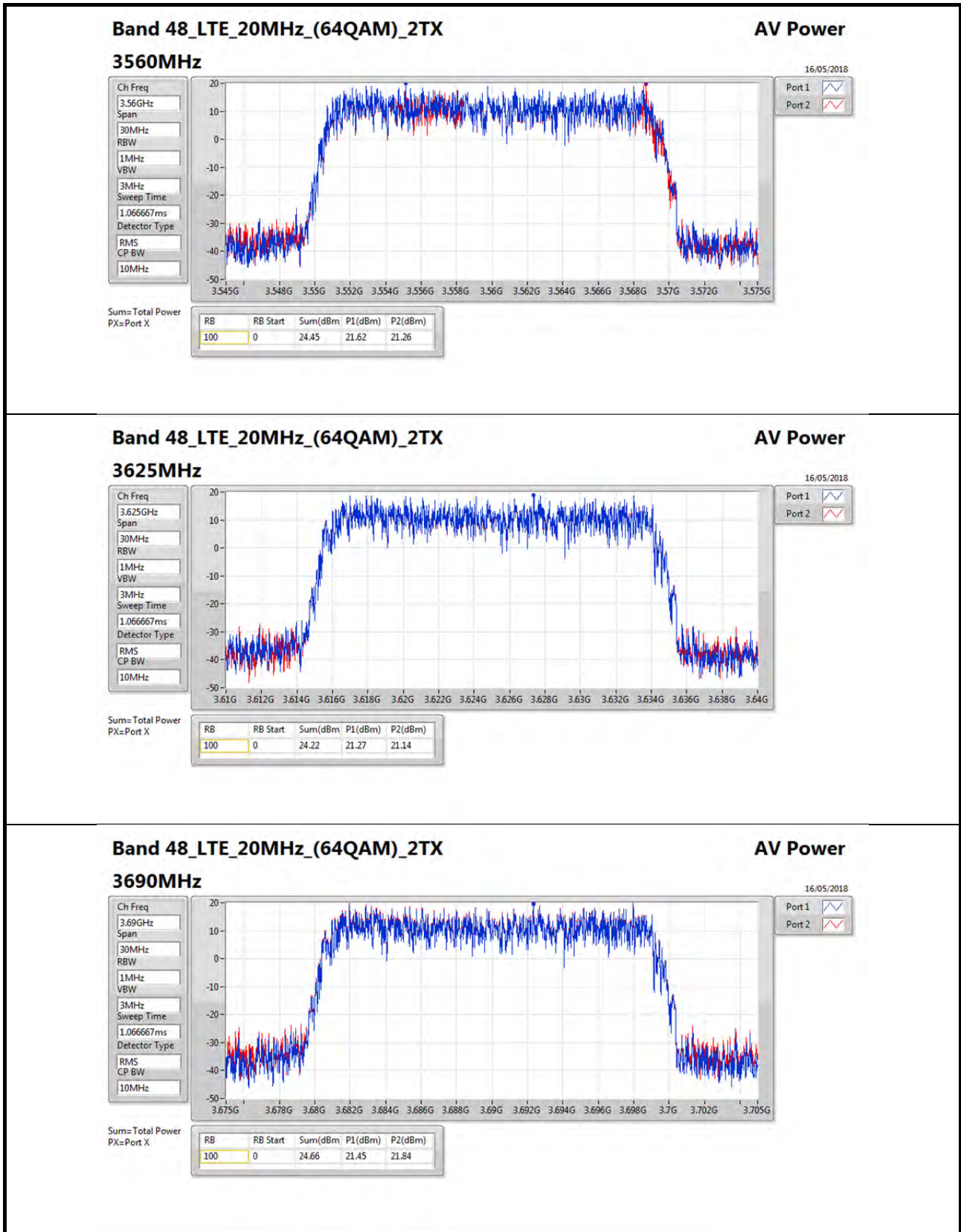



Summary

Mode	PD (dBm/MHz)	PD (mW/MHz)	EIRP PD (dBm/MHz)	EIRP PD (mW/MHz)
Band 48	-	-	-	-
Band 48_LTE_10MHz_(QPSK)_2TX	19.44	87.90	22.44	175.39
Band 48_LTE_10MHz_(16QAM)_2TX	19.73	93.97	22.73	187.50
Band 48_LTE_10MHz_(64QAM)_2TX	19.18	82.79	22.18	165.20
Band 48_LTE_20MHz_(QPSK)_2TX	16.59	45.60	19.59	90.99
Band 48_LTE_20MHz_(16QAM)_2TX	16.85	48.42	19.85	96.61
Band 48_LTE_20MHz_(64QAM)_2TX	16.40	43.65	19.40	87.10

Result

Mode	RB	Gain (dBi)	Port 1 (dBm/MHz)	Port 2 (dBm/MHz)	PD (dBm/MHz)	PD Limit (dBm/MHz)	Result
Band 48_LTE_10MHz_(QPSK)_2TX	-	-	-	-	-	-	-
3555MHz	50	3.00	15.36	15.43	18.41	37.00	Pass
3625MHz	50	3.00	15.52	15.48	18.51	37.00	Pass
3695MHz	50	3.00	16.67	16.18	19.44	37.00	Pass
Band 48_LTE_10MHz_(16QAM)_2TX	-	-	-	-	-	-	-
3555MHz	50	3.00	15.96	15.91	18.95	37.00	Pass
3625MHz	50	3.00	15.87	15.54	18.72	37.00	Pass
3695MHz	50	3.00	16.59	16.84	19.73	37.00	Pass
Band 48_LTE_10MHz_(64QAM)_2TX	-	-	-	-	-	-	-
3555MHz	50	3.00	15.02	15.19	18.12	37.00	Pass
3625MHz	50	3.00	15.09	14.29	17.72	37.00	Pass
3695MHz	50	3.00	16.10	16.24	19.18	37.00	Pass
Band 48_LTE_20MHz_(QPSK)_2TX	-	-	-	-	-	-	-
3560MHz	100	3.00	13.10	13.28	16.20	37.00	Pass
3625MHz	100	3.00	13.09	12.26	15.71	37.00	Pass
3690MHz	100	3.00	13.55	13.60	16.59	37.00	Pass
Band 48_LTE_20MHz_(16QAM)_2TX	-	-	-	-	-	-	-
3560MHz	100	3.00	12.68	12.73	15.72	37.00	Pass
3625MHz	100	3.00	12.75	12.18	15.48	37.00	Pass
3690MHz	100	3.00	14.01	13.67	16.85	37.00	Pass
Band 48_LTE_20MHz_(64QAM)_2TX	-	-	-	-	-	-	-
3560MHz	100	3.00	12.81	12.38	15.61	37.00	Pass
3625MHz	100	3.00	12.89	11.78	15.38	37.00	Pass
3690MHz	100	3.00	13.59	13.19	16.40	37.00	Pass

DG = Directional Gain;

PD = trace bin-by-bin of each transmits port summing can be performed maximum power density; Port X = Port Xpower density;



Band 48_LTE_10MHz_(QPSK)_2TX

PSD

3555MHz

21/05/2018

Ch Freq
3.555GHz
Span
20MHz
RBW
1MHz
VBW
3MHz
Sweep Time
1.066667ms
Detector Type
RMS

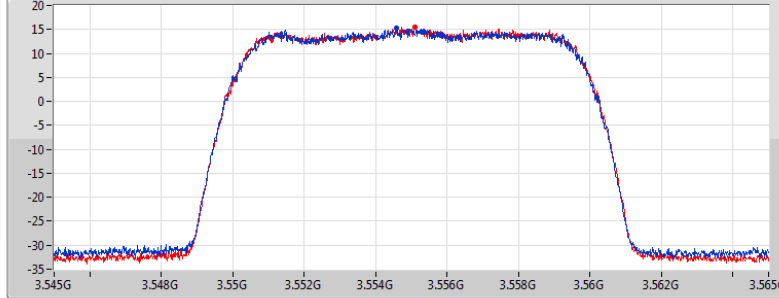

Port 1
Port 2

RB	RB Start	PD	Port 1	Port 2
-	-	(dBm/MHz)	(dBm/MHz)	(dBm/MHz)
50	0	18.41	15.36	15.43

Band 48_LTE_10MHz_(QPSK)_2TX

PSD

3625MHz

21/05/2018

Ch Freq
3.625GHz
Span
20MHz
RBW
1MHz
VBW
3MHz
Sweep Time
1.066667ms
Detector Type
RMS

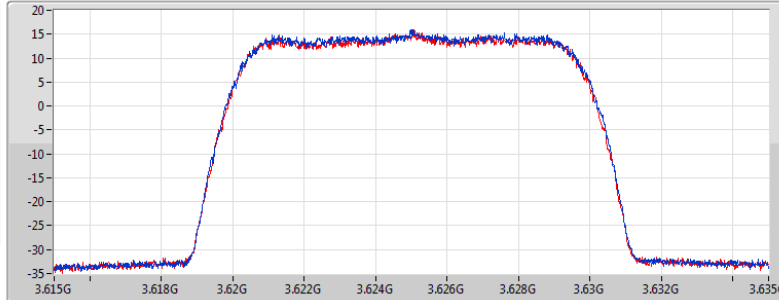

Port 1
Port 2

RB	RB Start	PD	Port 1	Port 2
-	-	(dBm/MHz)	(dBm/MHz)	(dBm/MHz)
50	0	18.51	15.52	15.48

Band 48_LTE_10MHz_(QPSK)_2TX

PSD

3695MHz

21/05/2018

Ch Freq
3.695GHz
Span
20MHz
RBW
1MHz
VBW
3MHz
Sweep Time
1.066667ms
Detector Type
RMS

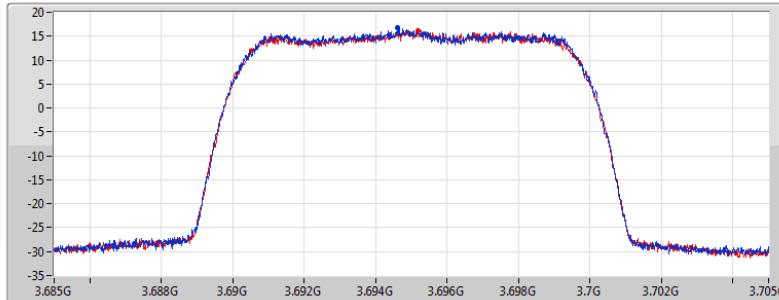

Port 1
Port 2

RB	RB Start	PD	Port 1	Port 2
-	-	(dBm/MHz)	(dBm/MHz)	(dBm/MHz)
50	0	19.44	16.67	16.18

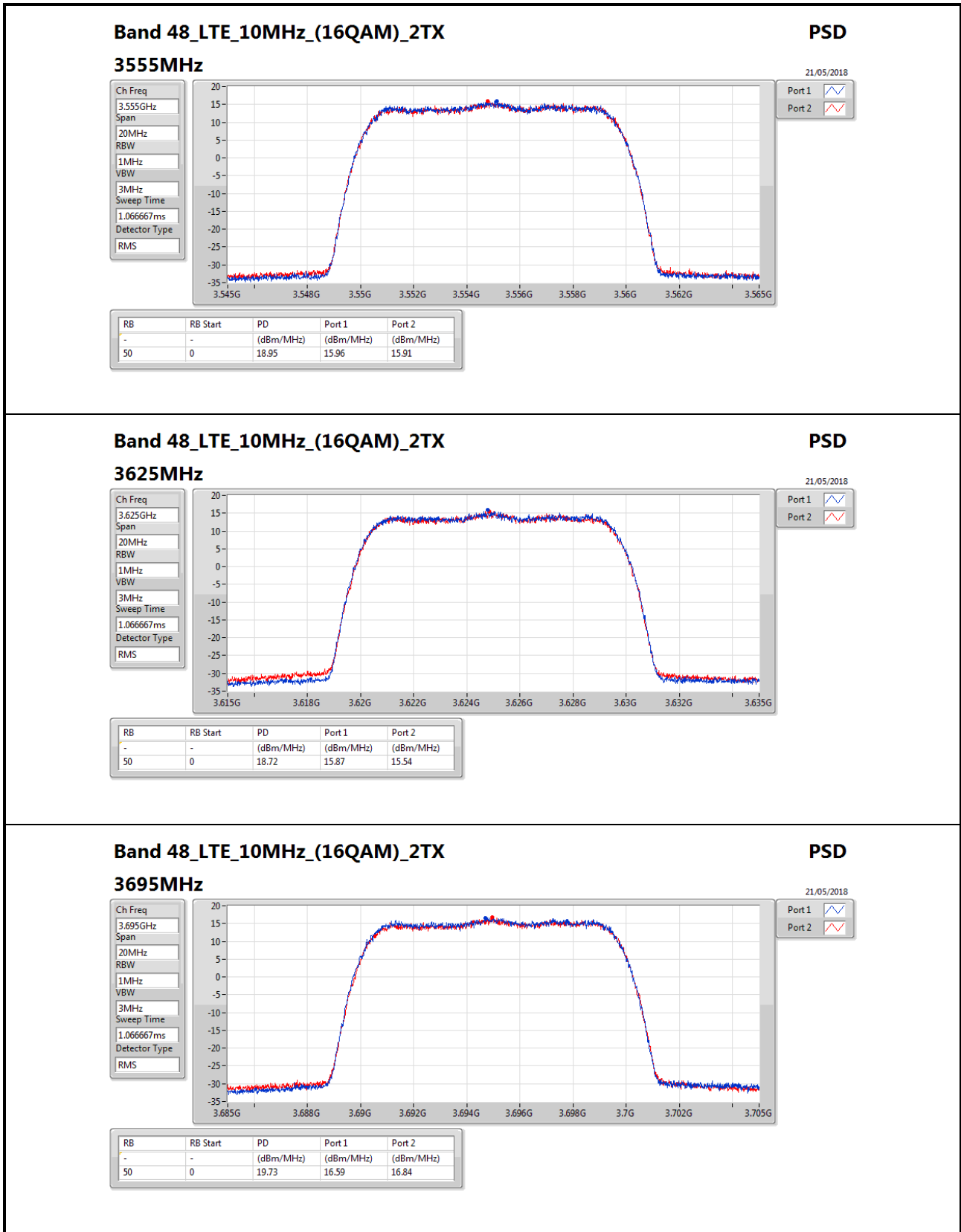

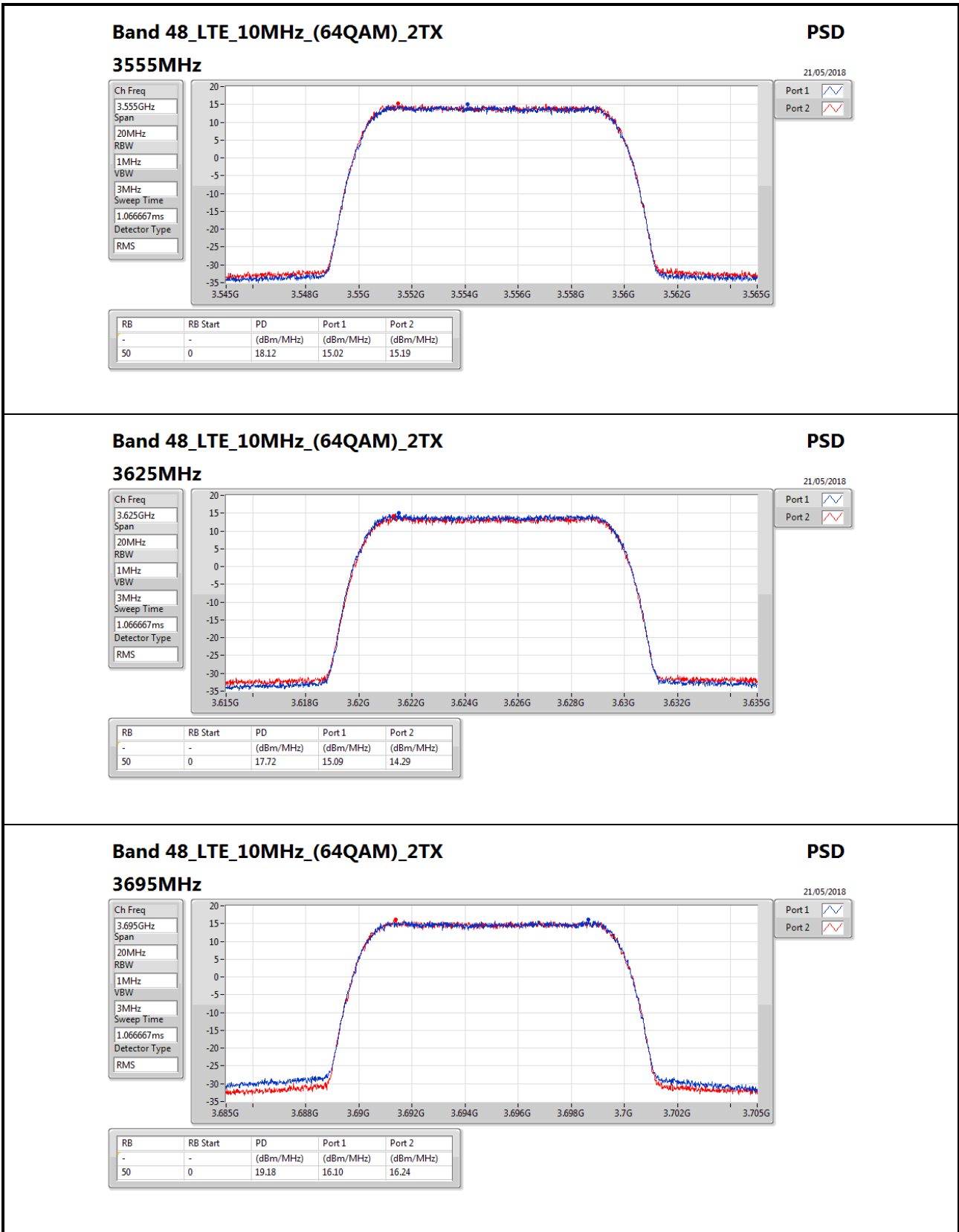



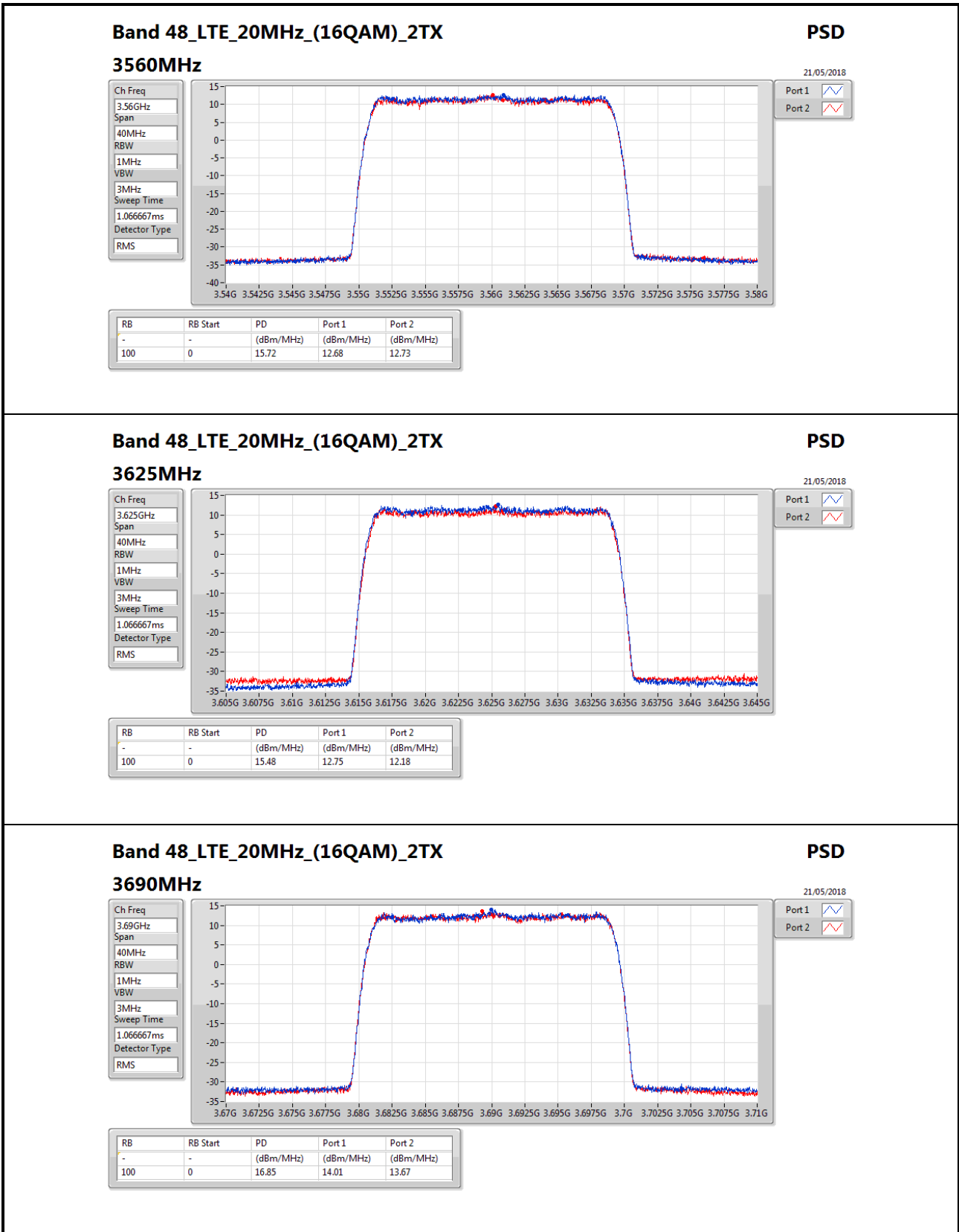

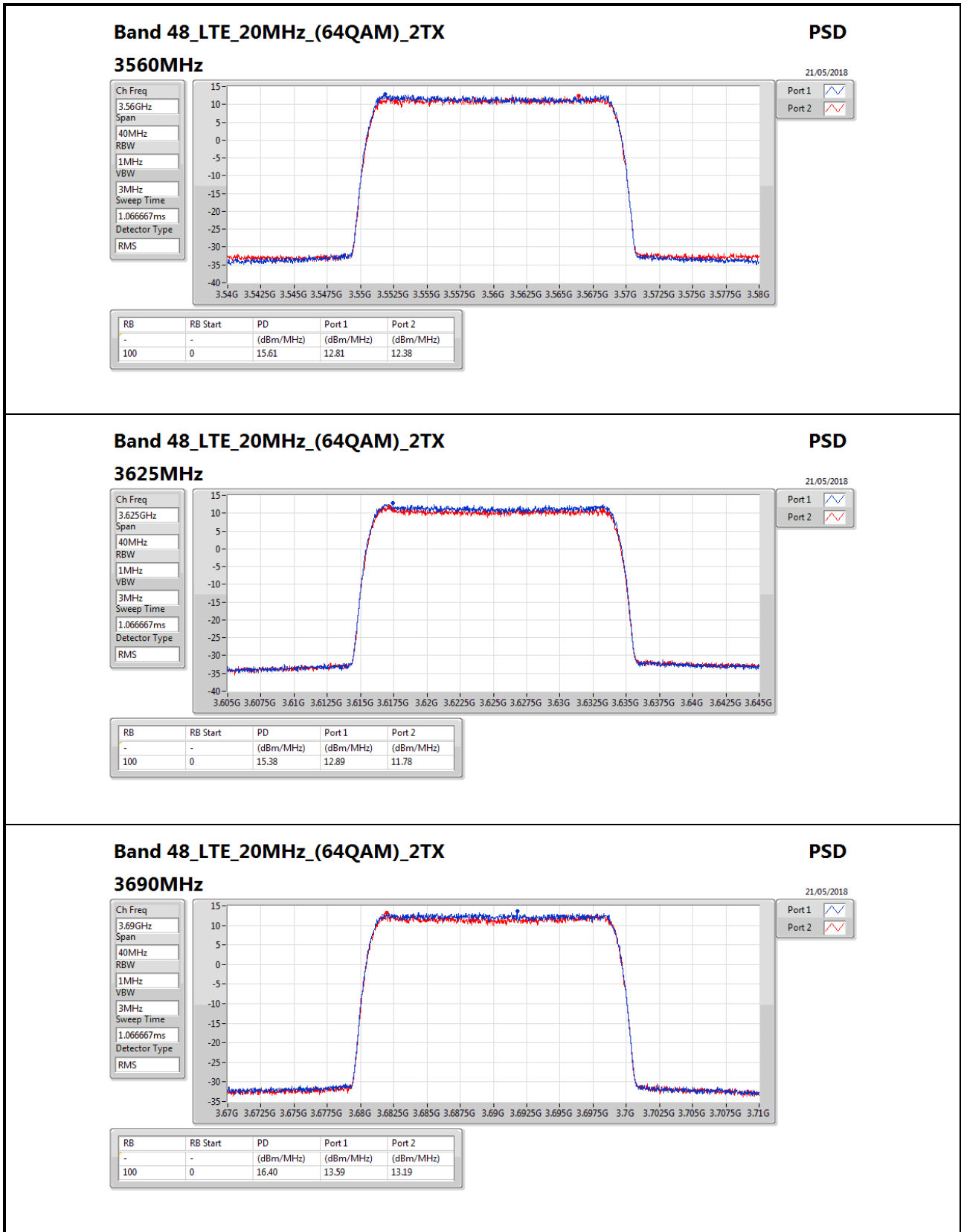

Result

Mode	P1 Wanted signal power level (dBm)	Adjacent Channel Selectivity Throughput (%)	In-band blocking Throughput (%)	P2 Wanted signal power level (dBm)	Adjacent Channel Selectivity Throughput (%)	In-band blocking Throughput (%)	Interference signal power level (dBm/10MHz)	Result
Band 48_LTE_10MHz_2TX	-	-	-	-	-	-	-	-
3555MHz, RB Offset = 0	-86.5	100	100	-86.8	100	100	-40	Pass
3555MHz, RB Offset = 25	-86.5	100	100	-86.8	100	100	-40	Pass
3625MHz, RB Offset = 0	-86.5	100	100	-86.8	100	100	-40	Pass
3625MHz, RB Offset = 25	-86.5	100	100	-86.8	100	100	-40	Pass
3695MHz, RB Offset = 0	-86.5	100	100	-86.8	100	100	-40	Pass
3695MHz, RB Offset = 25	-86.5	100	100	-86.8	100	100	-40	Pass
Band 48_LTE_20MHz_2TX	-86.5							-
3560MHz, RB Offset = 0	-86.5	100	100	-86.8	100	100	-40	Pass
3560MHz, RB Offset = 25	-86.5	100	100	-86.8	100	100	-40	Pass
3560MHz, RB Offset = 50	-86.5	100	100	-86.8	100	100	-40	Pass
3560MHz, RB Offset = 75	-86.5	100	100	-86.8	100	100	-40	Pass
3625MHz, RB Offset = 0	-86.5	100	100	-86.8	100	100	-40	Pass
3625MHz, RB Offset = 25	-86.5	100	100	-86.8	100	100	-40	Pass
3625MHz, RB Offset = 50	-86.5	100	100	-86.8	100	100	-40	Pass
3625MHz, RB Offset = 75	-86.5	100	100	-86.8	100	100	-40	Pass
3690MHz, RB Offset = 0	-86.5	100	100	-86.8	100	100	-40	Pass
3690MHz, RB Offset = 25	-86.5	100	100	-86.8	100	100	-40	Pass
3690MHz, RB Offset = 50	-86.5	100	100	-86.8	100	100	-40	Pass
3690MHz, RB Offset = 75	-86.5	100	100	-86.8	100	100	-40	Pass

Note1 This requirement shall be met for each consecutive application of a single instance of FRC A1-3 mapped to disjoint frequency ranges with a width of 25 resource blocks each.

The parameters of the FRC A1-3 as below:

Allocated resource blocks	25
DFT-OFDM Symbols per subframe	12
Modulation	QPSK
Code rate	1/3
Payload size (bits)	2216
Transport block CRC (bits)	24
Code block CRC size (bits)	0
Number of code blocks - C	1
Coded block size including 12bits trellis termination (bits)	6732
Total number of bits per sub-frame	7200
Total symbols per sub-frame	3600

Note2 The interference signal is 10MHz(50RB) LTE signal.



Summary

Mode	RB Start	Freq (Hz)	Mean (dBm)	Peak (dBm)	Crset (dB)	Margin (dB)	Limit (dB)	0.1%	Port	Result
Band 48	-	-	-	-	-	-	-	-	-	-
Band 48_LTE_10 MHz_(QPSK)_2TX	50	3.625G	24.81	32.40	7.59	-5.66	13.00	7.34	1	Pass
Band 48_LTE_10 MHz_(16QAM)_2TX	50	3.555G	24.89	32.56	7.67	-5.66	13.00	7.34	1	Pass
Band 48_LTE_10 MHz_(64QAM)_2TX	50	3.625G	24.67	32.29	7.62	-5.61	13.00	7.39	1	Pass
Band 48_LTE_20 MHz_(QPSK)_2TX	100	3.625G	24.31	31.70	7.39	-5.83	13.00	7.17	1	Pass
Band 48_LTE_20 MHz_(16QAM)_2TX	100	3.625G	24.09	31.58	7.49	-5.75	13.00	7.25	1	Pass
Band 48_LTE_20 MHz_(64QAM)_2TX	100	3.56G	24.40	31.80	7.40	-5.81	13.00	7.19	1	Pass

Result

Mode	RB Start	Freq (Hz)	Mean (dBm)	Peak (dBm)	Crset (dB)	Margin (dB)	Limit (dB)	0.1%	Port	Result
Band 48_LTE_10 MHz_(QPSK)_2TX	-	-	-	-	-	-	-	-	-	-
3555MHz	50	3.555G	24.89	32.44	7.55	-5.69	13.00	7.31	1	Pass
3625MHz	50	3.625G	24.81	32.40	7.59	-5.66	13.00	7.34	1	Pass
3695MHz	50	3.695G	25.93	33.46	7.53	-5.75	13.00	7.25	1	Pass
Band 48_LTE_10 MHz_(16QAM)_2TX	-	-	-	-	-	-	-	-	-	-
3555MHz	50	3.555G	24.89	32.56	7.67	-5.66	13.00	7.34	1	Pass
3625MHz	50	3.625G	24.84	32.47	7.63	-5.73	13.00	7.27	1	Pass
3695MHz	50	3.695G	25.92	33.45	7.53	-5.73	13.00	7.27	1	Pass
Band 48_LTE_10 MHz_(64QAM)_2TX	-	-	-	-	-	-	-	-	-	-
3555MHz	50	3.555G	24.91	32.47	7.56	-5.74	13.00	7.26	1	Pass
3625MHz	50	3.625G	24.67	32.29	7.62	-5.61	13.00	7.39	1	Pass
3695MHz	50	3.695G	25.32	32.82	7.50	-5.74	13.00	7.26	1	Pass
Band 48_LTE_20 MHz_(QPSK)	-	-	-	-	-	-	-	-	-	-



Peak-to-average power ratio Result

Mode	RB Start	Freq (Hz)	Mean (dBm)	Peak (dBm)	Crset (dB)	Margin (dB)	Limit (dB)	0.1%	Port	Result
)_2TX										
3560MHz	100	3.56G	24.41	31.78	7.37	-5.85	13.00	7.15	1	Pass
3625MHz	100	3.625G	24.31	31.70	7.39	-5.83	13.00	7.17	1	Pass
3690MHz	100	3.69G	24.35	31.63	7.28	-5.91	13.00	7.09	1	Pass
Band 48_LTE_20 MHz_(16QAM)_2TX	-	-	-	-	-	-	-	-	-	-
3560MHz	100	3.56G	24.46	31.89	7.43	-5.84	13.00	7.16	1	Pass
3625MHz	100	3.625G	24.09	31.58	7.49	-5.75	13.00	7.25	1	Pass
3690MHz	100	3.69G	25.31	32.83	7.52	-5.81	13.00	7.19	1	Pass
Band 48_LTE_20 MHz_(64QAM)_2TX	-	-	-	-	-	-	-	-	-	-
3560MHz	100	3.56G	24.40	31.80	7.40	-5.81	13.00	7.19	1	Pass
3625MHz	100	3.625G	24.59	32.04	7.45	-5.86	13.00	7.14	1	Pass
3690MHz	100	3.69G	25.56	32.94	7.38	-5.81	13.00	7.19	1	Pass

Band 48_LTE_10MHz_(QPSK)_2TX

PAR

3555MHz

22/05/2018

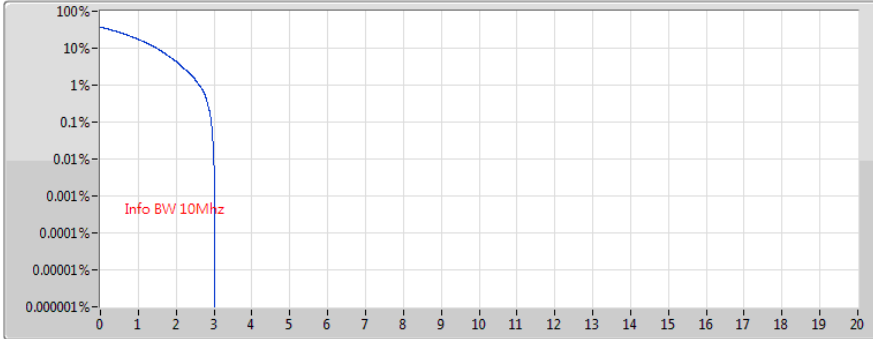

RB	0.1%	Margin(dB)	Limit(dB)	Port
0	7.31	-5.69	13.00	1

Band 48_LTE_10MHz_(QPSK)_2TX

PAR

3625MHz

22/05/2018

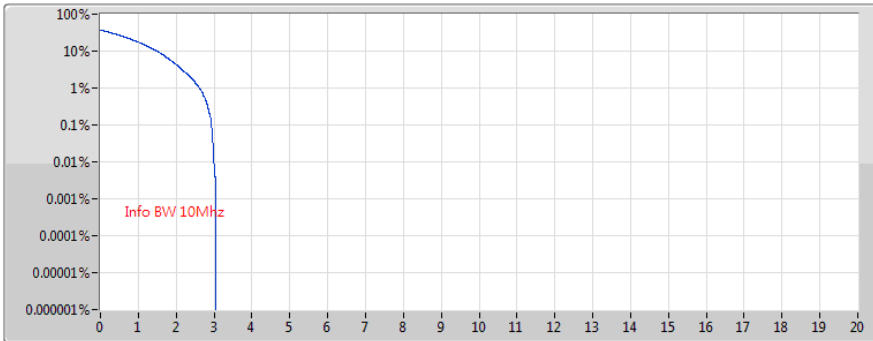

RB	0.1%	Margin(dB)	Limit(dB)	Port
0	7.34	-5.66	13.00	1

Band 48_LTE_10MHz_(QPSK)_2TX

PAR

3695MHz

22/05/2018

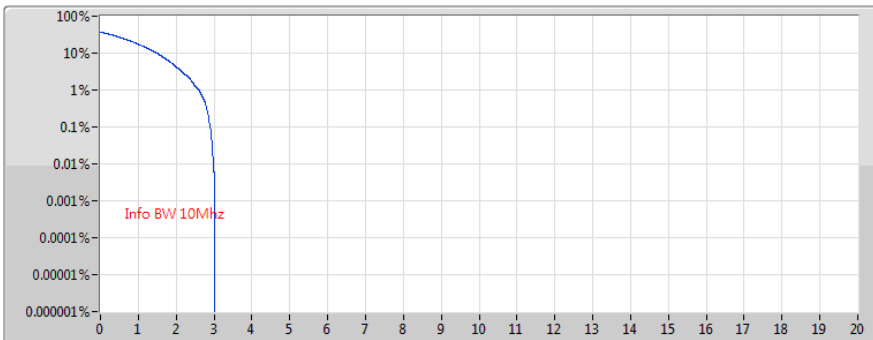

RB	0.1%	Margin(dB)	Limit(dB)	Port
0	7.25	-5.75	13.00	1



Band 48_LTE_10MHz_(16QAM)_2TX

PAR

3555MHz

22/05/2018

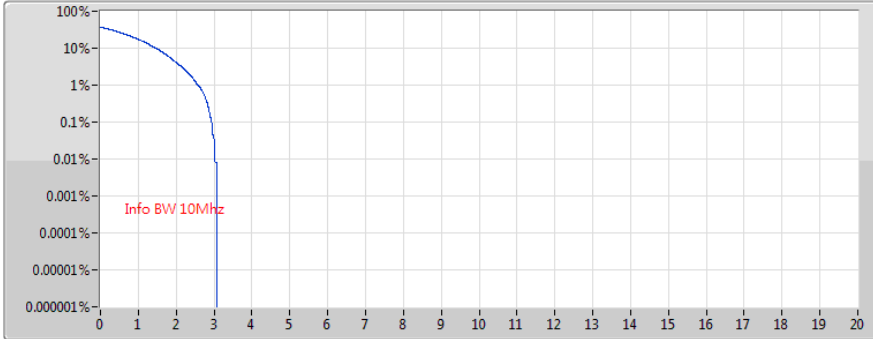

RB	0.1%	Margin(dB)	Limit(dB)	Port
0	7.34	-5.66	13.00	1

Band 48_LTE_10MHz_(16QAM)_2TX

PAR

3625MHz

22/05/2018

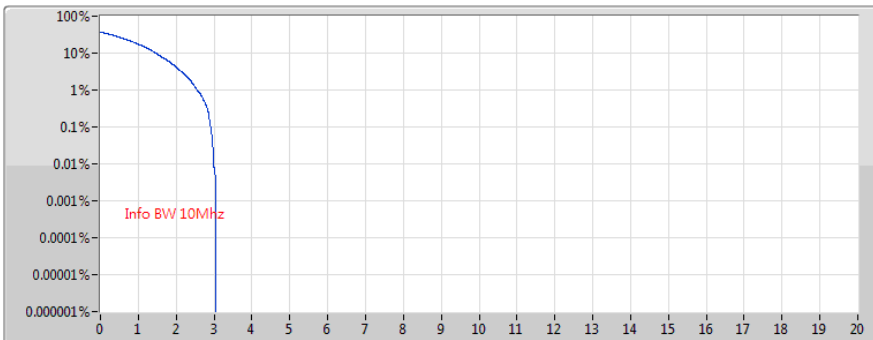

RB	0.1%	Margin(dB)	Limit(dB)	Port
0	7.27	-5.73	13.00	1

Band 48_LTE_10MHz_(16QAM)_2TX

PAR

3695MHz

22/05/2018

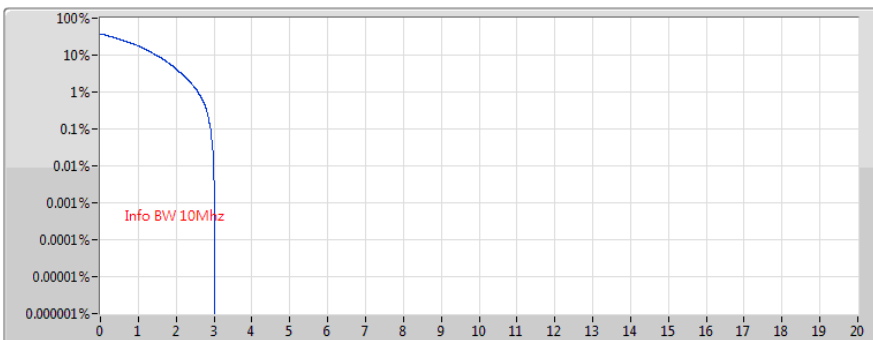

RB	0.1%	Margin(dB)	Limit(dB)	Port
0	7.27	-5.73	13.00	1



Band 48_LTE_10MHz_(64QAM)_2TX

PAR

3555MHz

22/05/2018

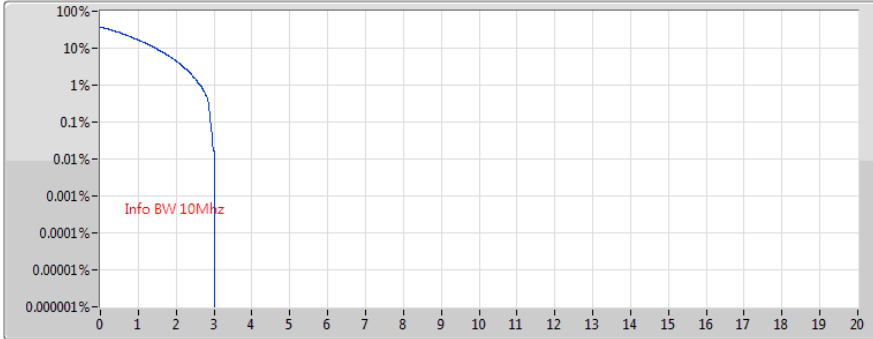

RB	0.1%	Margin(dB)	Limit(dB)	Port
0	7.26	-5.74	13.00	1

Band 48_LTE_10MHz_(64QAM)_2TX

PAR

3625MHz

22/05/2018

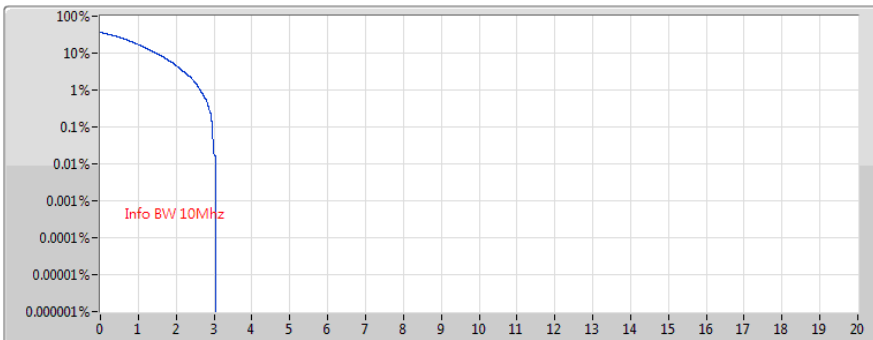

RB	0.1%	Margin(dB)	Limit(dB)	Port
0	7.39	-5.61	13.00	1

Band 48_LTE_10MHz_(64QAM)_2TX

PAR

3695MHz

22/05/2018

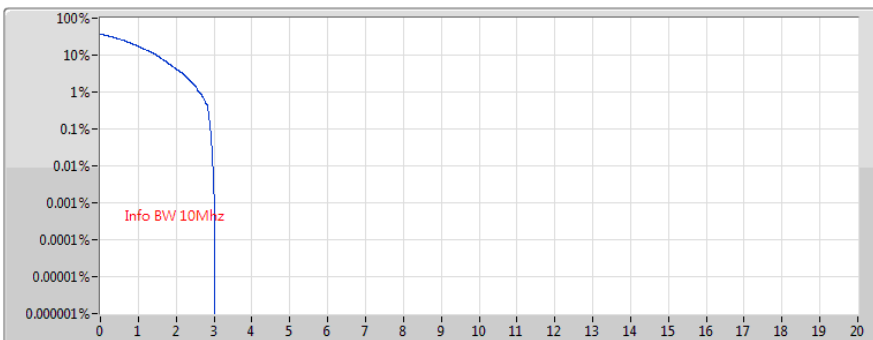

RB	0.1%	Margin(dB)	Limit(dB)	Port
0	7.26	-5.74	13.00	1



Band 48_LTE_20MHz_(QPSK)_2TX

PAR

3560MHz

22/05/2018

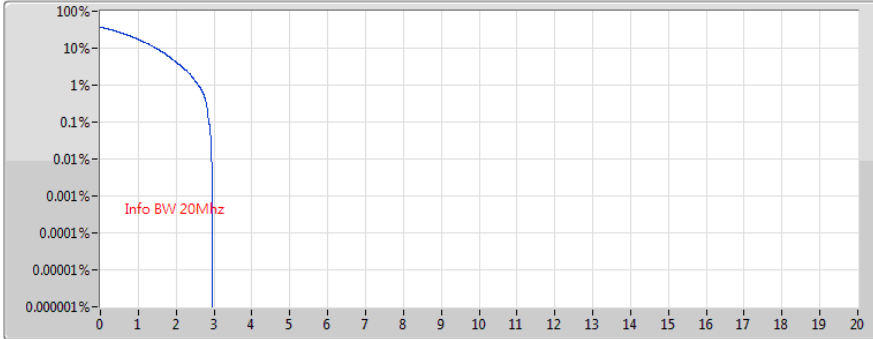

RB	0.1%	Margin(dB)	Limit(dB)	Port
0	7.15	-5.85	13.00	1

Band 48_LTE_20MHz_(QPSK)_2TX

PAR

3625MHz

22/05/2018

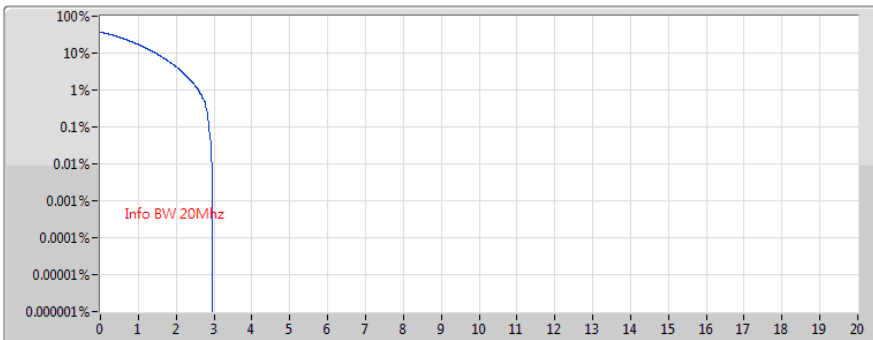

RB	0.1%	Margin(dB)	Limit(dB)	Port
0	7.17	-5.83	13.00	1

Band 48_LTE_20MHz_(QPSK)_2TX

PAR

3690MHz

25/05/2018

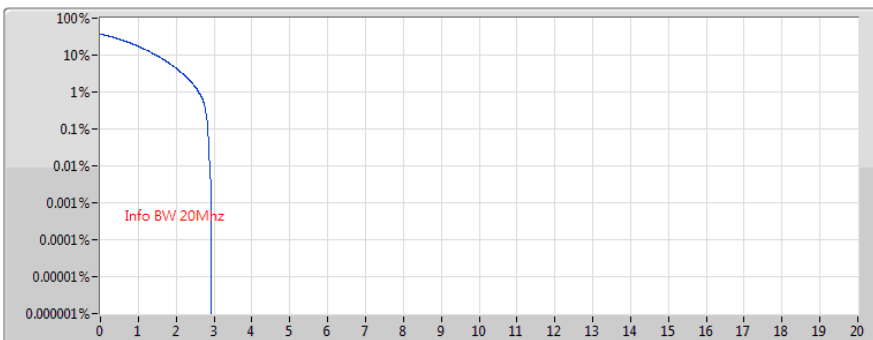

RB	0.1%	Margin(dB)	Limit(dB)	Port
0	7.09	-5.91	13.00	1



Band 48_LTE_20MHz_(16QAM)_2TX

PAR

3560MHz

22/05/2018

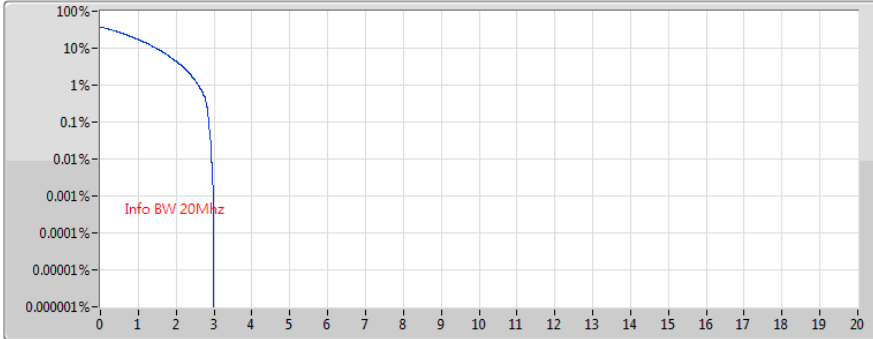

RB	0.1%	Margin(dB)	Limit(dB)	Port
0	7.16	-5.84	13.00	1

Band 48_LTE_20MHz_(16QAM)_2TX

PAR

3625MHz

22/05/2018

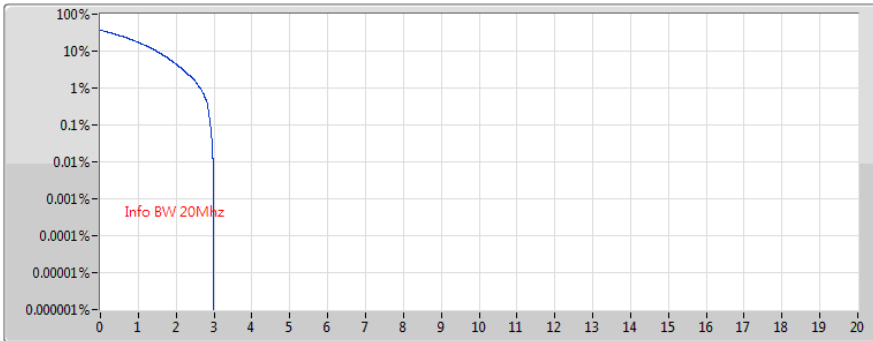

RB	0.1%	Margin(dB)	Limit(dB)	Port
0	7.25	-5.75	13.00	1

Band 48_LTE_20MHz_(16QAM)_2TX

PAR

3690MHz

22/05/2018

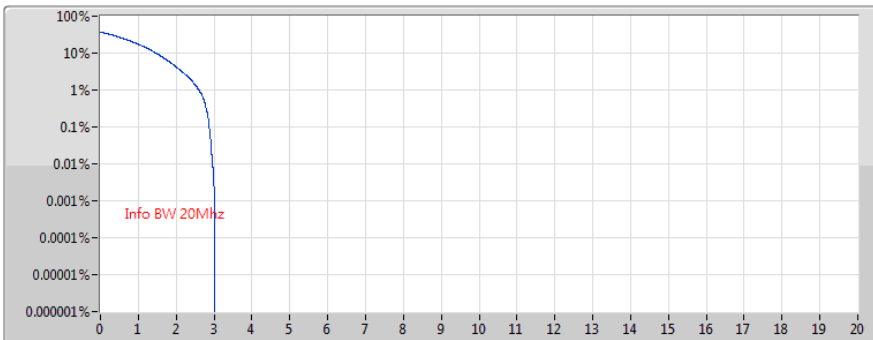

RB	0.1%	Margin(dB)	Limit(dB)	Port
0	7.19	-5.81	13.00	1



Band 48_LTE_20MHz_(64QAM)_2TX

PAR

3560MHz

22/05/2018

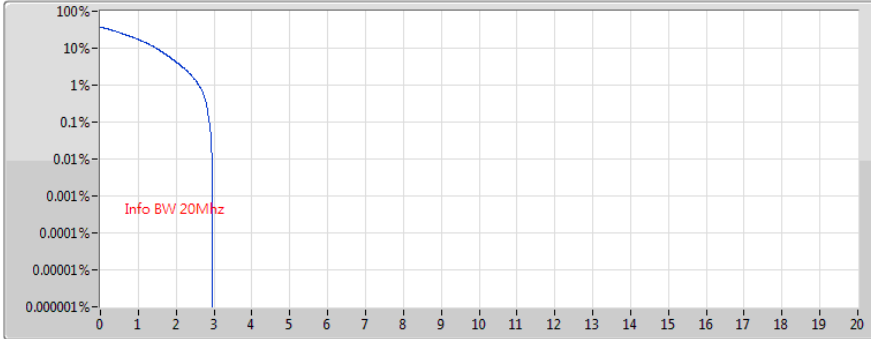

RB	0.1%	Margin(dB)	Limit(dB)	Port
0	7.19	-5.81	13.00	1

Band 48_LTE_20MHz_(64QAM)_2TX

PAR

3625MHz

22/05/2018

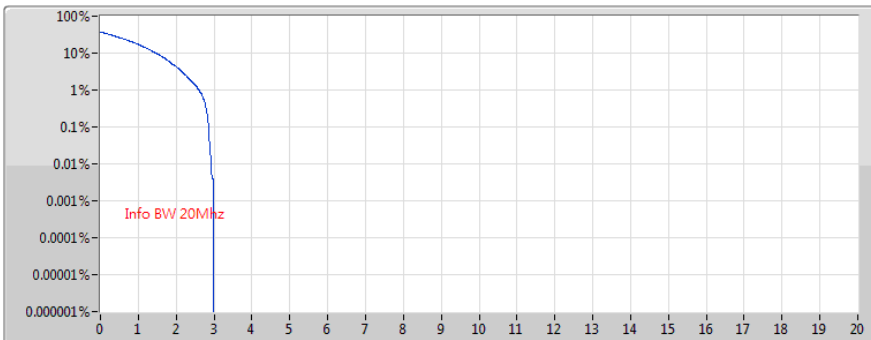

RB	0.1%	Margin(dB)	Limit(dB)	Port
0	7.14	-5.86	13.00	1

Band 48_LTE_20MHz_(64QAM)_2TX

PAR

3690MHz

22/05/2018

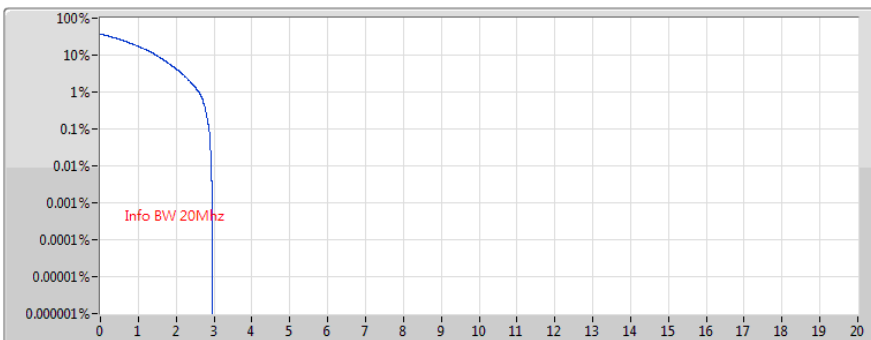

RB	0.1%	Margin(dB)	Limit(dB)	Port
0	7.19	-5.81	13.00	1



Summary

Mode	RB Start	Freq (Hz)	Mean (dBm)	Peak (dBm)	Crset (dB)	Margin (dB)	Limit (dB)	0.1%	Port	Result
Band 48	-	-	-	-	-	-	-	-	-	-
Band 48_LTE_10 MHz_(QPSK)_2TX	50	3.555G	23.04	30.65	7.61	-5.63	13.00	7.37	2	Pass
Band 48_LTE_10 MHz_(16QAM)_2TX	50	3.625G	23.15	30.78	7.63	-5.66	13.00	7.34	2	Pass
Band 48_LTE_10 MHz_(64QAM)_2TX	50	3.625G	22.94	30.63	7.69	-5.62	13.00	7.38	2	Pass
Band 48_LTE_20 MHz_(QPSK)_2TX	100	3.56G	22.79	30.32	7.53	-5.77	13.00	7.23	2	Pass
Band 48_LTE_20 MHz_(16QAM)_2TX	100	3.56G	22.91	30.48	7.57	-5.80	13.00	7.20	2	Pass
Band 48_LTE_20 MHz_(64QAM)_2TX	100	3.56G	22.89	30.50	7.61	-5.80	13.00	7.20	2	Pass

Result

Mode	RB Start	Freq (Hz)	Mean (dBm)	Peak (dBm)	Crset (dB)	Margin (dB)	Limit (dB)	0.1%	Port	Result
Band 48_LTE_10 MHz_(QPSK)_2TX	-	-	-	-	-	-	-	-	-	-
3555MHz	50	3.555G	23.04	30.65	7.61	-5.63	13.00	7.37	2	Pass
3625MHz	50	3.625G	23.07	30.75	7.68	-5.67	13.00	7.33	2	Pass
3695MHz	50	3.695G	24.00	31.66	7.66	-5.68	13.00	7.32	2	Pass
Band 48_LTE_10 MHz_(16QAM)_2TX	-	-	-	-	-	-	-	-	-	-
3555MHz	50	3.555G	23.09	30.68	7.59	-5.70	13.00	7.30	2	Pass
3625MHz	50	3.625G	23.15	30.78	7.63	-5.66	13.00	7.34	2	Pass
3695MHz	50	3.695G	24.01	31.69	7.68	-5.66	13.00	7.34	2	Pass
Band 48_LTE_10 MHz_(64QAM)_2TX	-	-	-	-	-	-	-	-	-	-
3555MHz	50	3.555G	23.14	30.63	7.49	-5.70	13.00	7.30	2	Pass
3625MHz	50	3.625G	22.94	30.63	7.69	-5.62	13.00	7.38	2	Pass
3695MHz	50	3.695G	24.10	31.56	7.46	-5.80	13.00	7.20	2	Pass
Band 48_LTE_20 MHz_(QPSK)	-	-	-	-	-	-	-	-	-	-



Peak-to-average power ratio Result

Mode	RB Start	Freq (Hz)	Mean (dBm)	Peak (dBm)	Crset (dB)	Margin (dB)	Limit (dB)	0.1%	Port	Result
)_2TX										
3560MHz	100	3.56G	22.79	30.32	7.53	-5.77	13.00	7.23	2	Pass
3625MHz	100	3.625G	23.04	30.49	7.45	-5.84	13.00	7.16	2	Pass
3690MHz	100	3.69G	23.84	31.22	7.38	-5.87	13.00	7.13	2	Pass
Band 48_LTE_20 MHz_(16QAM)_2TX	-	-	-	-	-	-	-	-	-	-
3560MHz	100	3.56G	22.91	30.48	7.57	-5.80	13.00	7.20	2	Pass
3625MHz	100	3.625G	23.04	30.48	7.44	-5.85	13.00	7.15	2	Pass
3690MHz	100	3.69G	23.83	31.21	7.38	-5.87	13.00	7.13	2	Pass
Band 48_LTE_20 MHz_(64QAM)_2TX	-	-	-	-	-	-	-	-	-	-
3560MHz	100	3.56G	22.89	30.50	7.61	-5.80	13.00	7.20	2	Pass
3625MHz	100	3.625G	23.04	30.43	7.39	-5.82	13.00	7.18	2	Pass
3690MHz	100	3.69G	23.73	31.10	7.37	-5.84	13.00	7.16	2	Pass



Band 48_LTE_10MHz_(QPSK)_2TX

PAR

3555MHz

24/05/2018

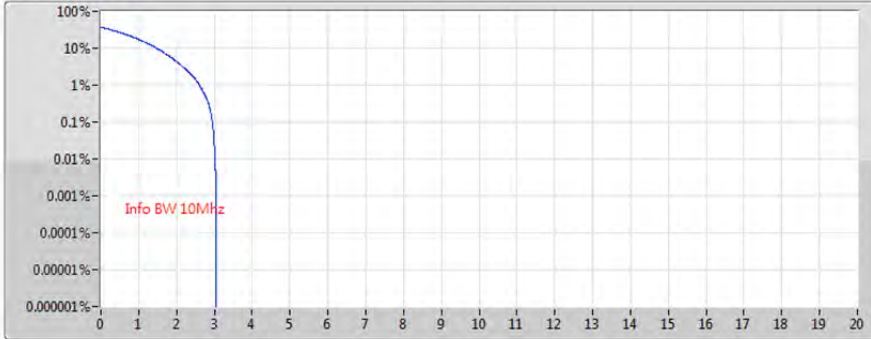

RB	0.1%	Margin(dB)	Limit(dB)	Port
0	7.37	-5.63	13.00	2

Band 48_LTE_10MHz_(QPSK)_2TX

PAR

3625MHz

24/05/2018

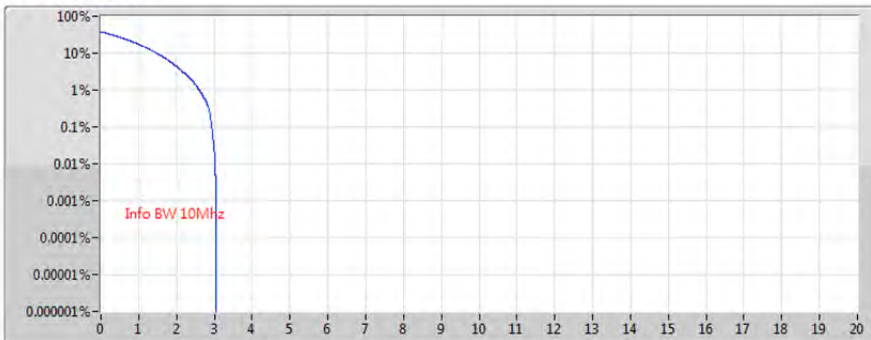

RB	0.1%	Margin(dB)	Limit(dB)	Port
0	7.33	-5.67	13.00	2

Band 48_LTE_10MHz_(QPSK)_2TX

PAR

3695MHz

24/05/2018

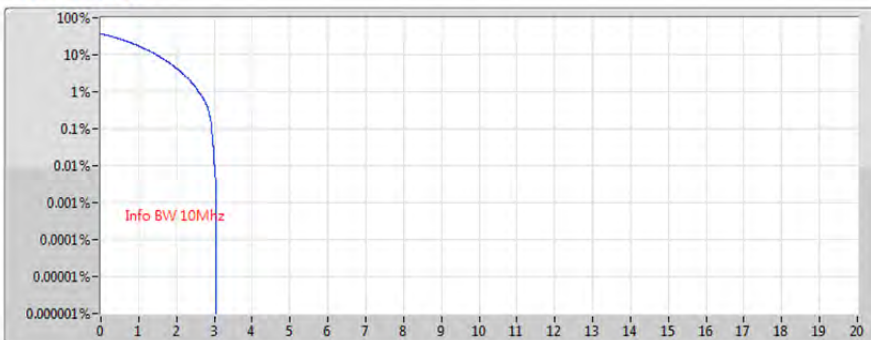

RB	0.1%	Margin(dB)	Limit(dB)	Port
0	7.32	-5.68	13.00	2



Band 48_LTE_10MHz_(16QAM)_2TX

PAR

3555MHz

24/05/2018

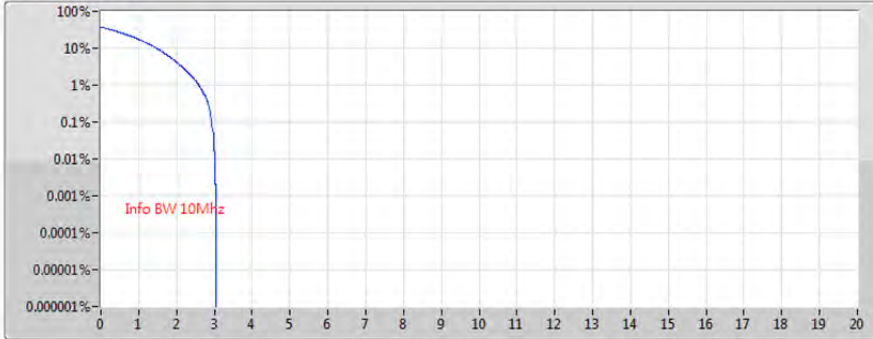

RB	0.1%	Margin(dB)	Limit(dB)	Port
0	7.30	-5.70	13.00	2

Band 48_LTE_10MHz_(16QAM)_2TX

PAR

3625MHz

24/05/2018

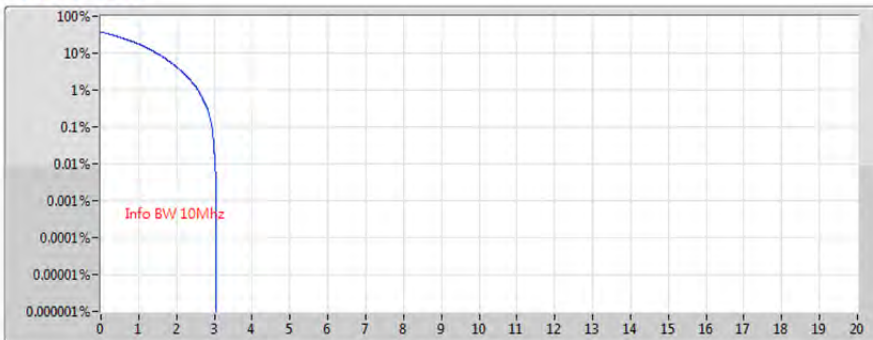

RB	0.1%	Margin(dB)	Limit(dB)	Port
0	7.34	-5.66	13.00	2

Band 48_LTE_10MHz_(16QAM)_2TX

PAR

3695MHz

24/05/2018

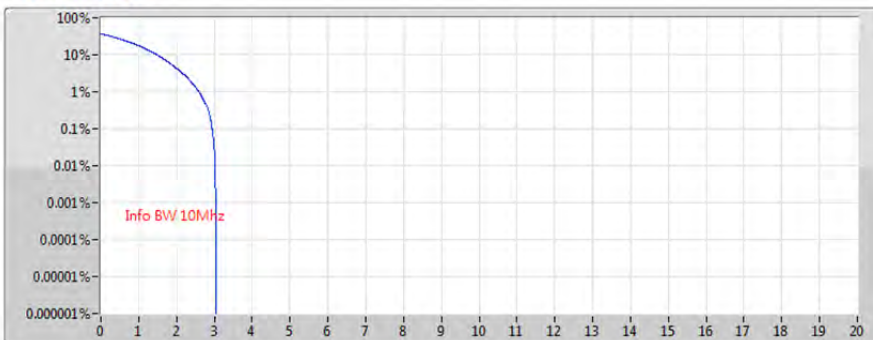

RB	0.1%	Margin(dB)	Limit(dB)	Port
0	7.34	-5.66	13.00	2

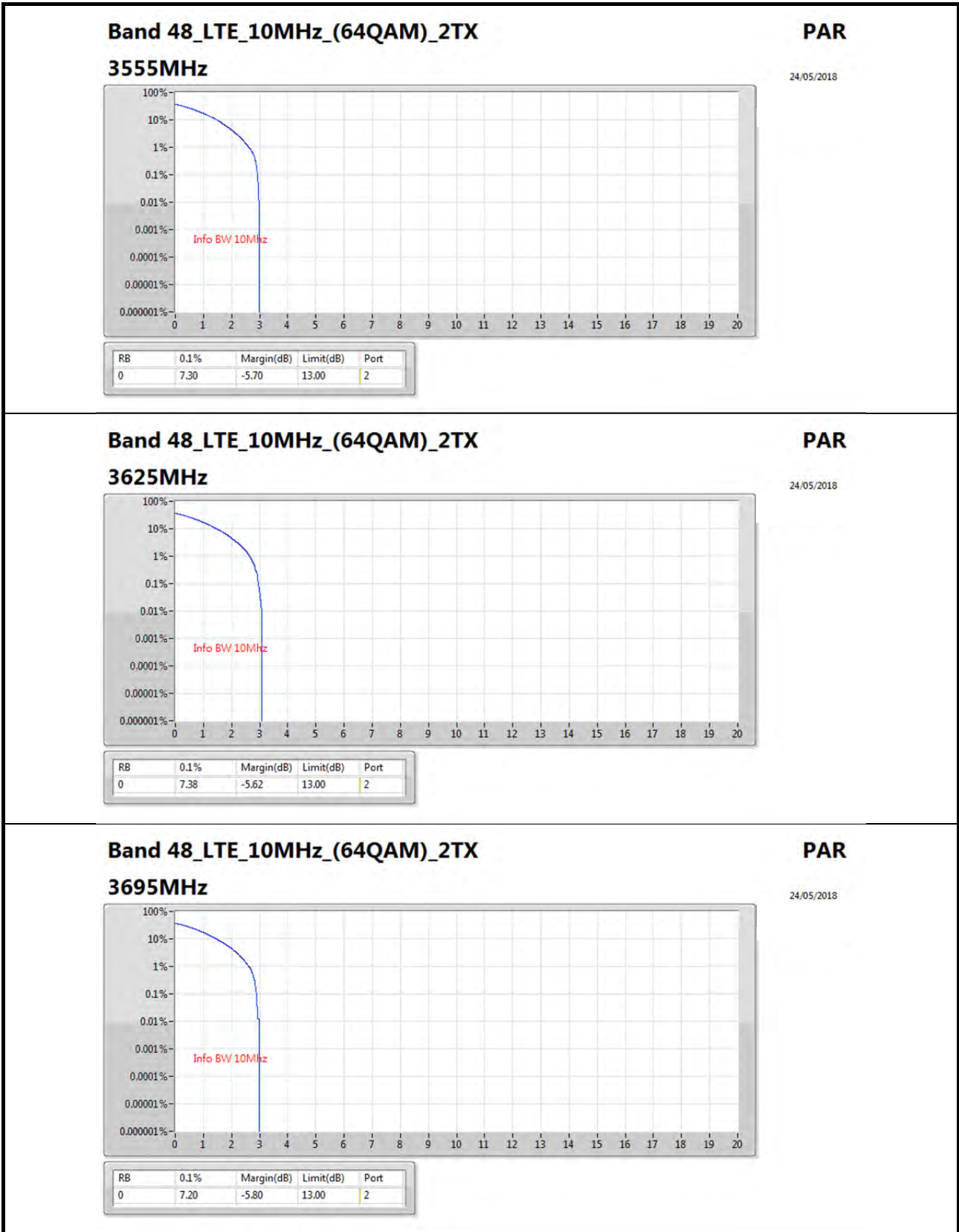

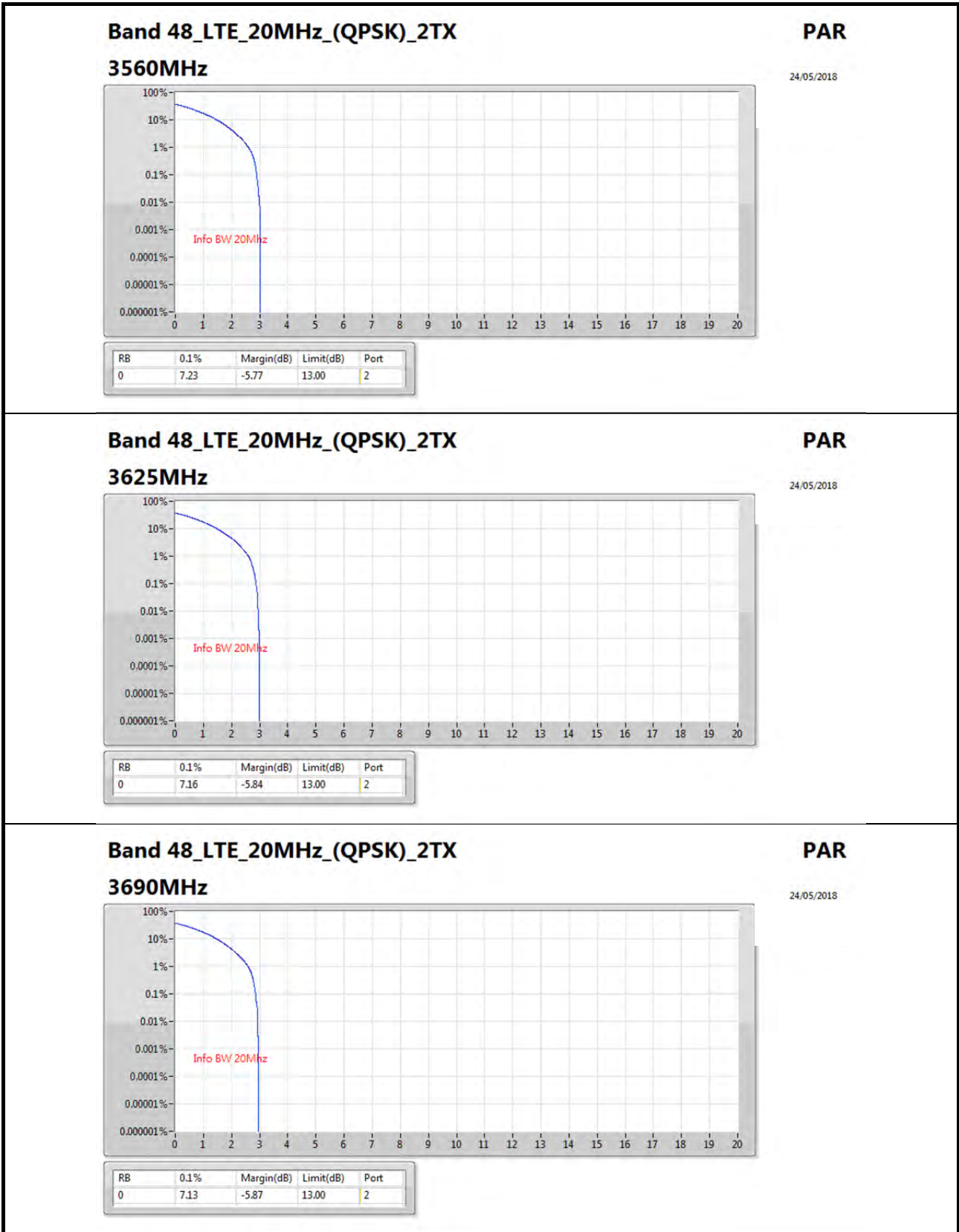

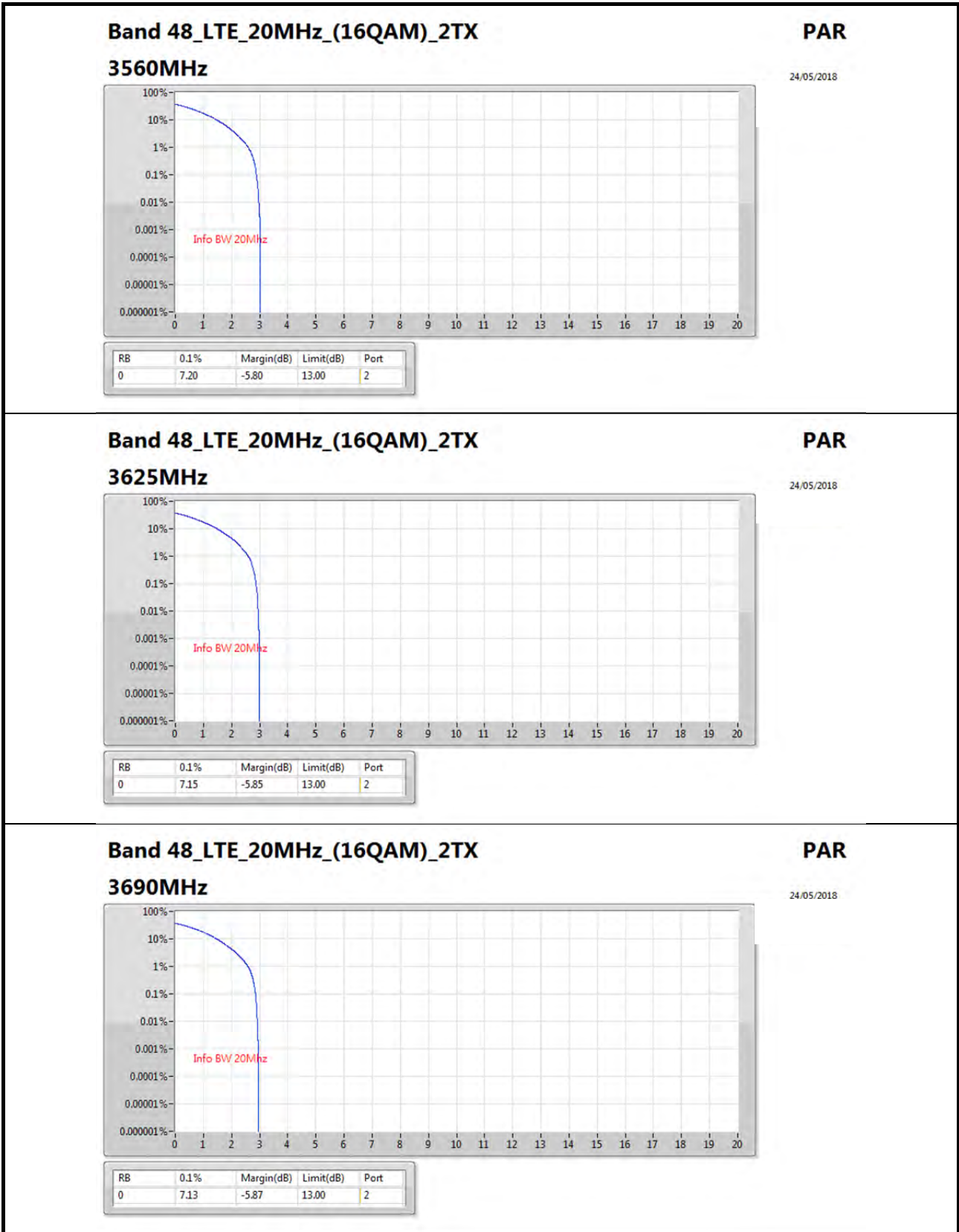

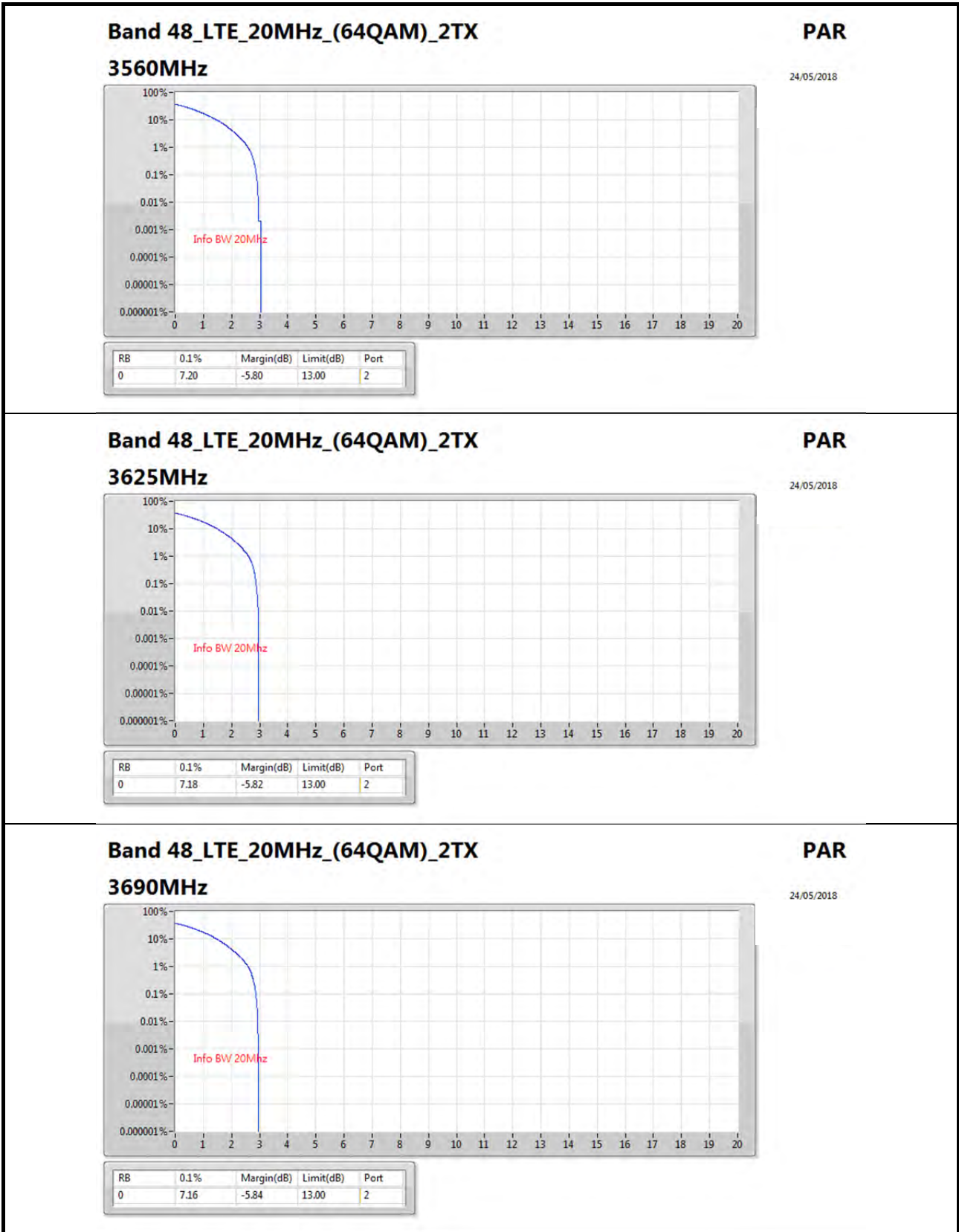



Summary

Mode	Max-N dB (Hz)	Max-OBW (Hz)	ITU-Code	Min-N dB (Hz)	Min-OBW (Hz)
Band 48	-	-	-	-	-
Band 48_LTE_10MHz_(QPSK)_2TX	9.563M	8.925M	8M93G7D	9.513M	8.916M
Band 48_LTE_10MHz_(16QAM)_2TX	9.6M	8.941M	8M94W7D	9.575M	8.929M
Band 48_LTE_10MHz_(64QAM)_2TX	9.563M	8.921M	8M92D9W	9.525M	8.911M
Band 48_LTE_20MHz_(QPSK)_2TX	18.75M	17.813M	17M8G7D	18.7M	17.801M
Band 48_LTE_20MHz_(16QAM)_2TX	18.85M	17.815M	17M8W7D	18.75M	17.785M
Band 48_LTE_20MHz_(64QAM)_2TX	18.8M	17.812M	17M8D9W	18.65M	17.795M

Max-N dB = Maximum 26dB down bandwidth; **Max-OBW** = Maximum 99% occupied bandwidth;
Min-N dB = Minimum 26dB down bandwidth; **Min-OBW** = Minimum 99% occupied bandwidth;

Result

Mode	RB	P1-N dB (Hz)	P1-OBW (Hz)	P2-N dB (Hz)	P2-OBW (Hz)
Band 48_LTE_10MHz_(QPSK)_2TX	-	-	-	-	-
3555MHz	50	9.513M	8.922M	9.513M	8.92M
3625MHz	50	9.513M	8.925M	9.563M	8.916M
3695MHz	50	9.513M	8.925M	9.563M	8.922M
Band 48_LTE_10MHz_(16QAM)_2TX	-	-	-	-	-
3555MHz	50	9.575M	8.929M	9.6M	8.934M
3625MHz	50	9.6M	8.935M	9.575M	8.934M
3695MHz	50	9.6M	8.939M	9.6M	8.941M
Band 48_LTE_10MHz_(64QAM)_2TX	-	-	-	-	-
3555MHz	50	9.538M	8.913M	9.563M	8.921M
3625MHz	50	9.538M	8.918M	9.525M	8.911M
3695MHz	50	9.55M	8.911M	9.55M	8.919M
Band 48_LTE_20MHz_(QPSK)_2TX	-	-	-	-	-
3560MHz	100	18.75M	17.806M	18.7M	17.801M
3625MHz	100	18.7M	17.806M	18.7M	17.813M
3690MHz	100	18.75M	17.805M	18.7M	17.81M
Band 48_LTE_20MHz_(16QAM)_2TX	-	-	-	-	-
3560MHz	100	18.75M	17.807M	18.85M	17.815M
3625MHz	100	18.75M	17.791M	18.75M	17.796M
3690MHz	100	18.75M	17.791M	18.75M	17.785M
Band 48_LTE_20MHz_(64QAM)_2TX	-	-	-	-	-
3560MHz	100	18.725M	17.801M	18.65M	17.803M
3625MHz	100	18.675M	17.803M	18.7M	17.795M
3690MHz	100	18.8M	17.811M	18.8M	17.812M

Port X-N dB = Port X 26dB down bandwidth; **Port X-OBW** = Port X 99% occupied bandwidth;

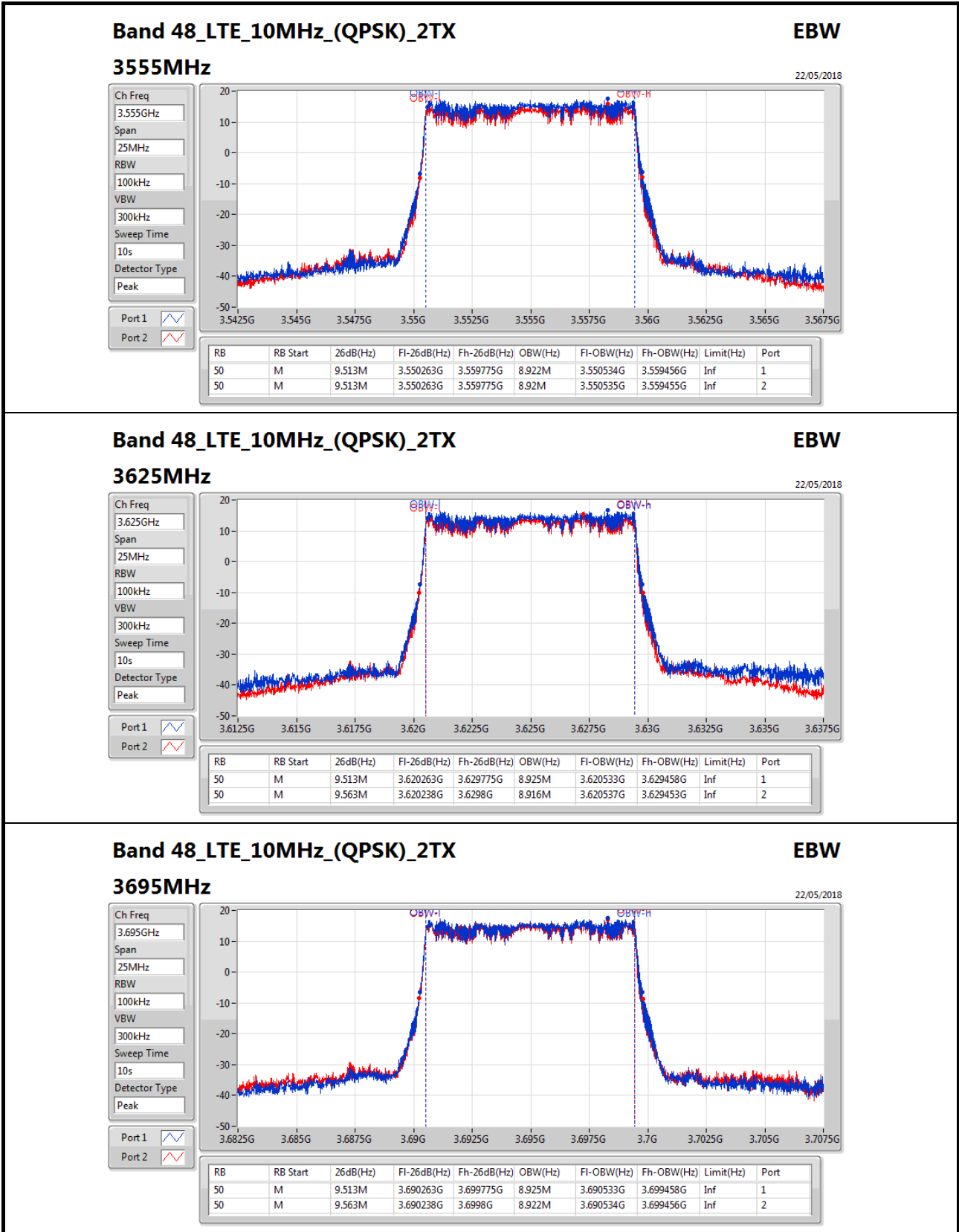

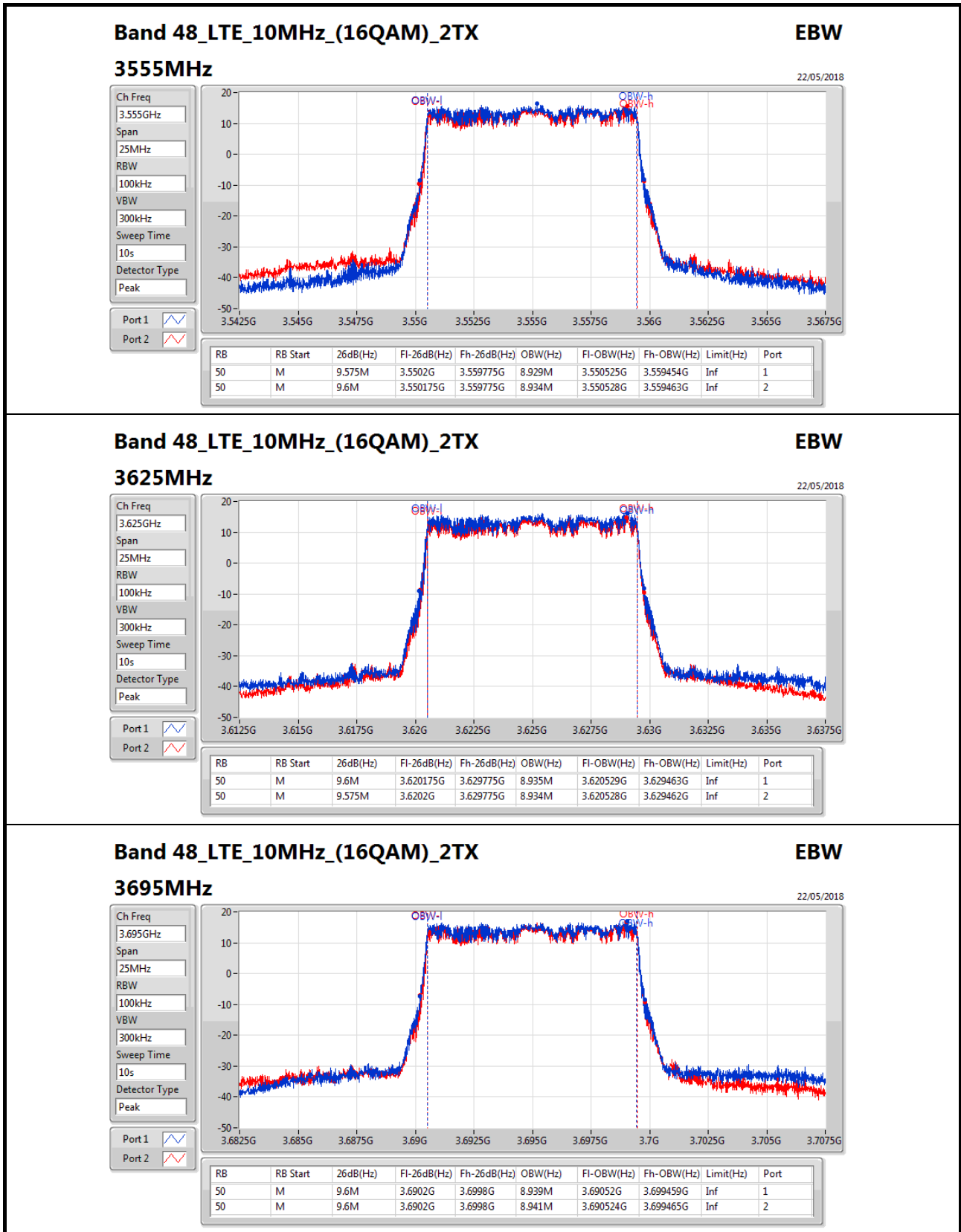

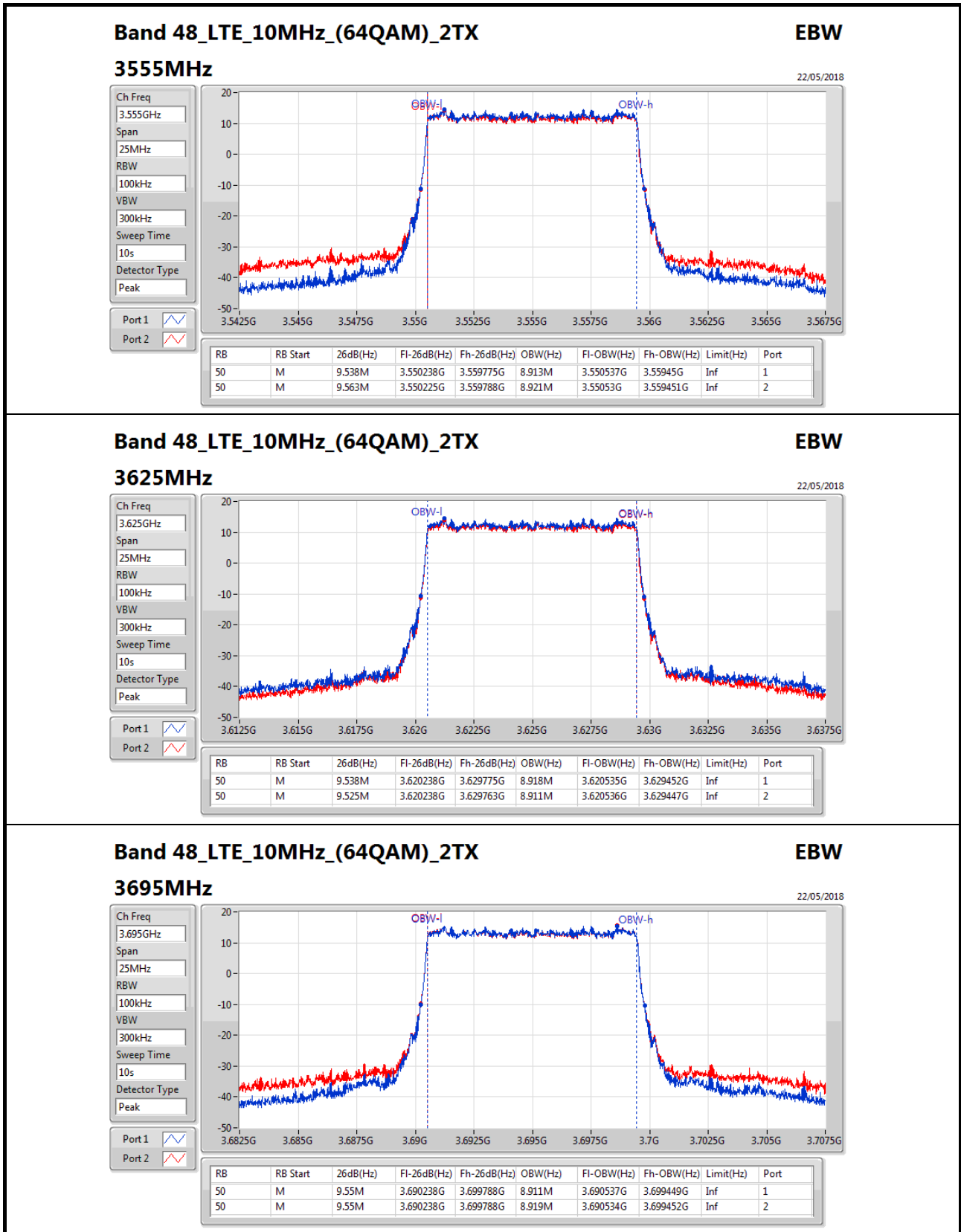

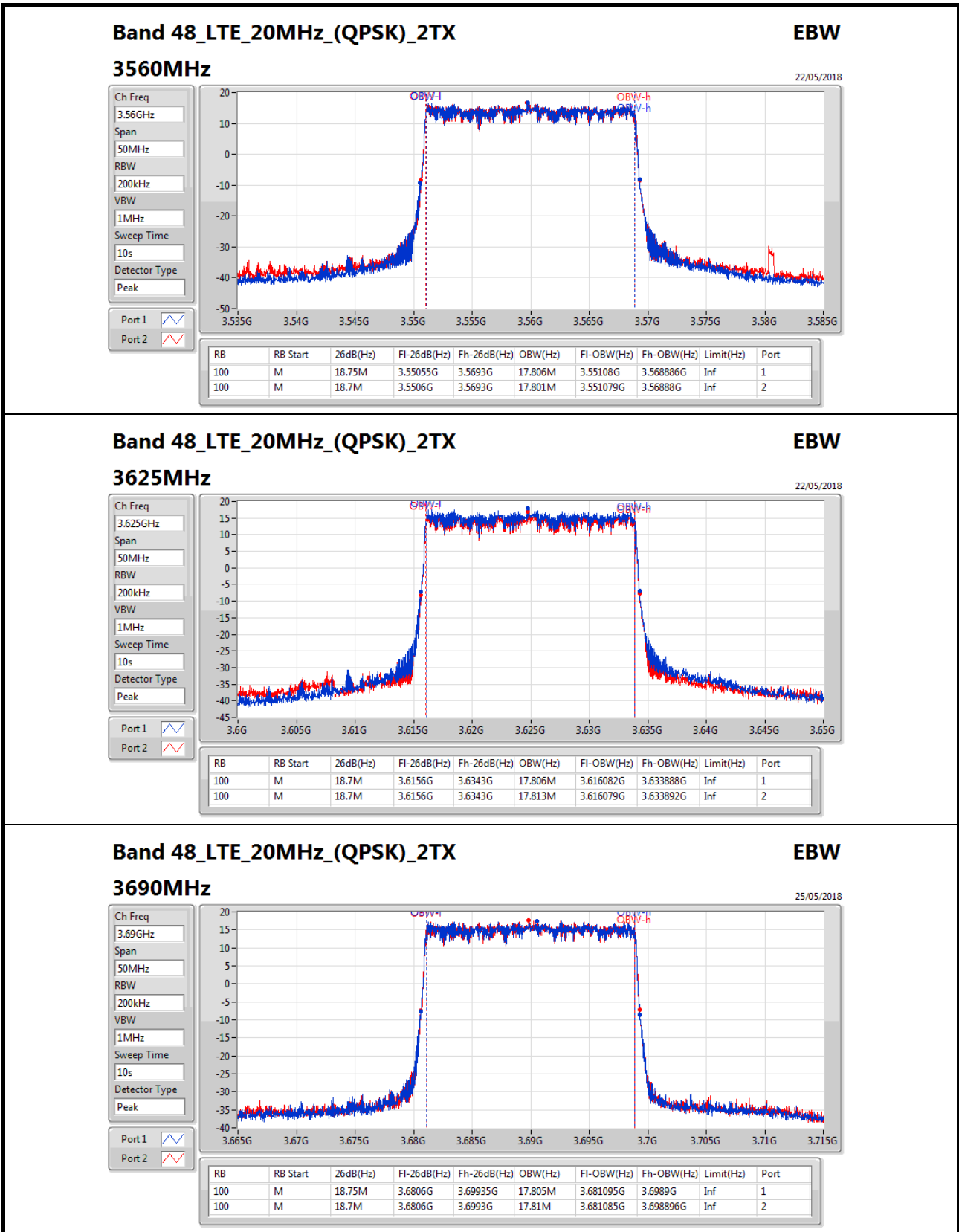

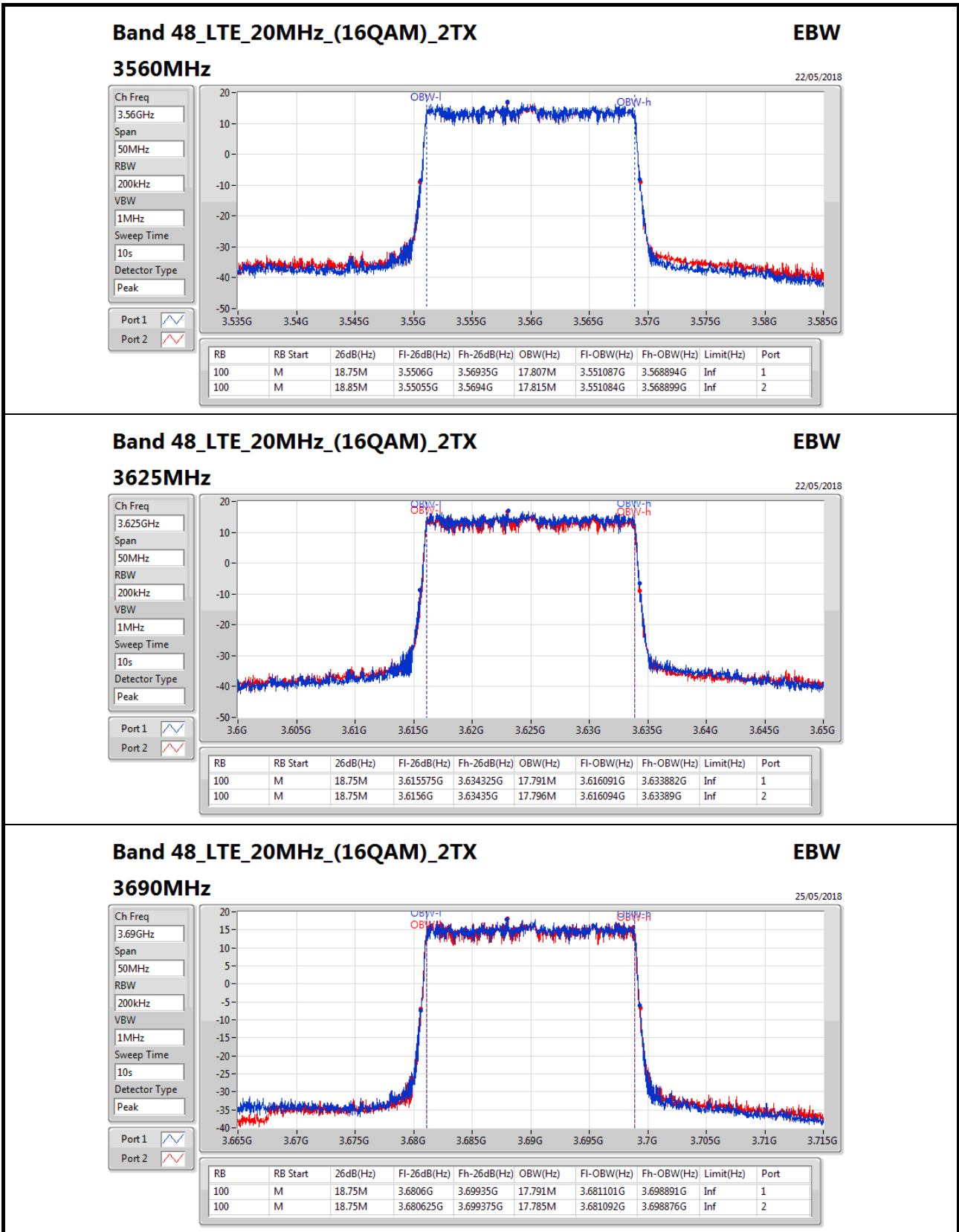

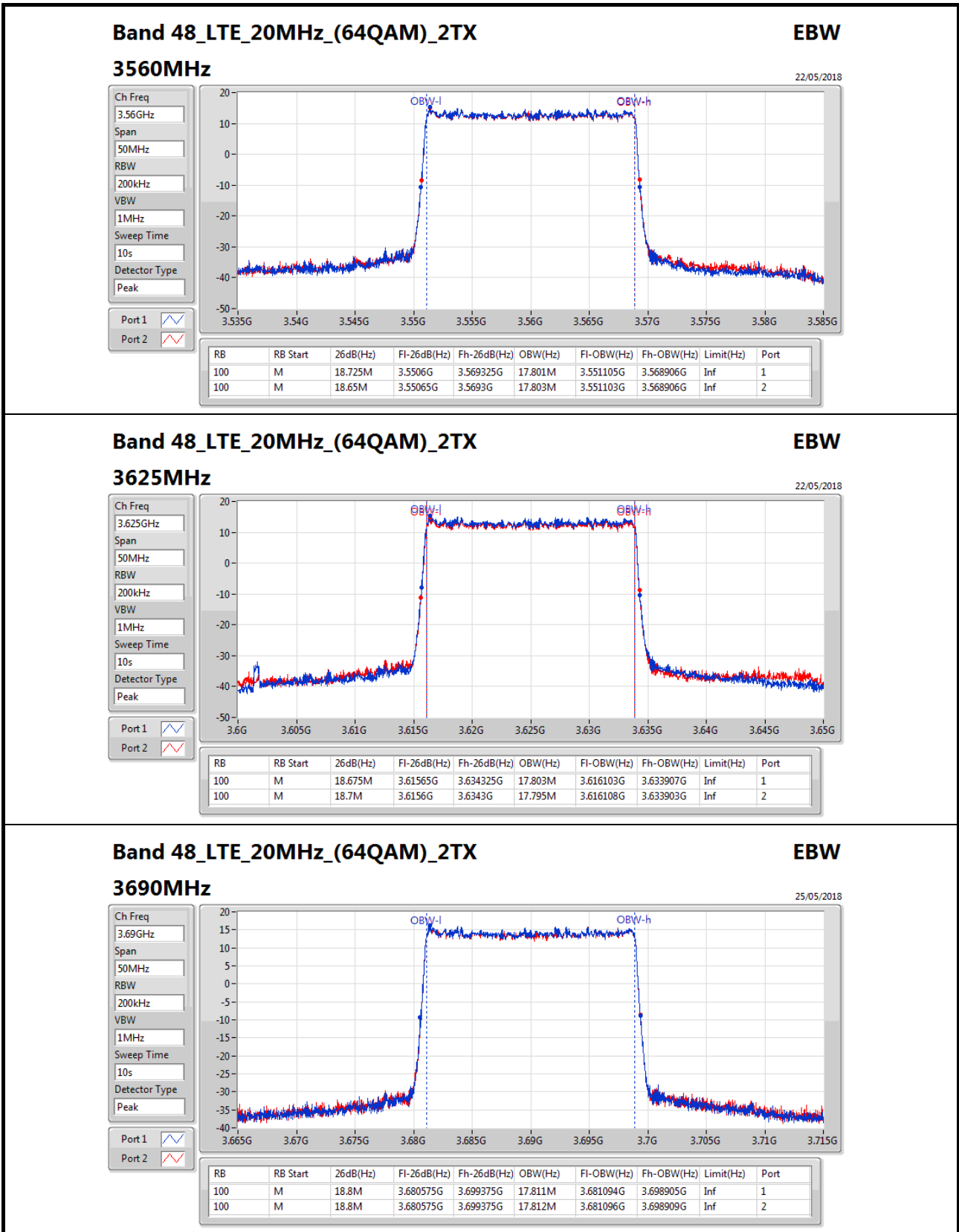



3.5 GHz Emissions and Interference Limits Result

Appendix G

Summary

Mode	RB	F-Start (Hz)	F-Stop (Hz)	RBW (Hz)	Detector	Freq (Hz)	Level (dBm)	Limit (dBm)	Margin (dB)	Loss (dB)	Port	Remark	Result
Band 48_LTE_20MHz_(64QAM)_2TX	-	-	-	-	-	-	-	-	-	-	-	-	-
3690MHz	100	3.72G	4G	1M	RMS	3.722805G	-43.29	-43.00	-0.29	26.59	1	-	Pass

DG = Directional Gain;

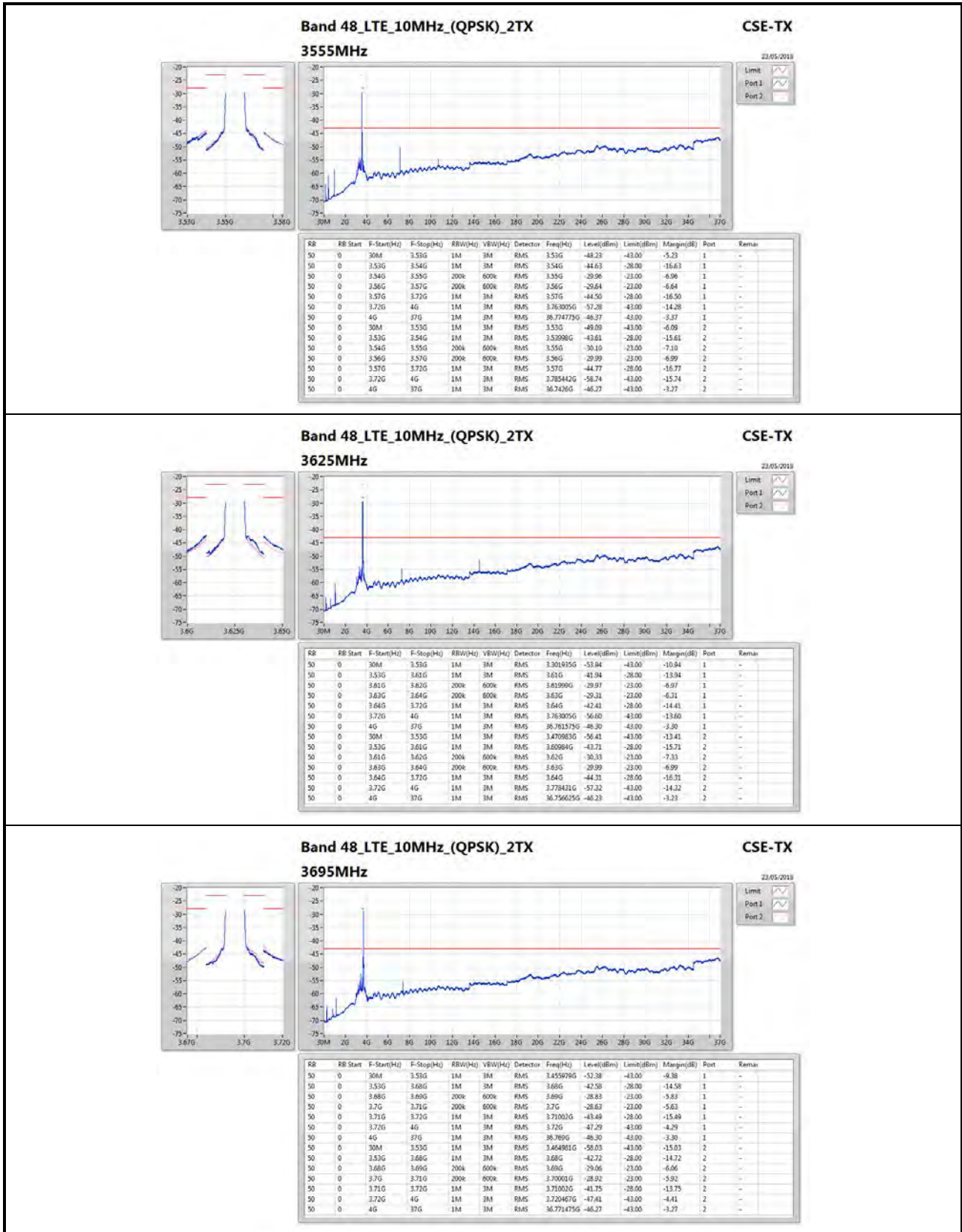

Band 48_LTE_10MHz_(QPSK)_2TX

3695MHz

CSE-TX

23/05/2018

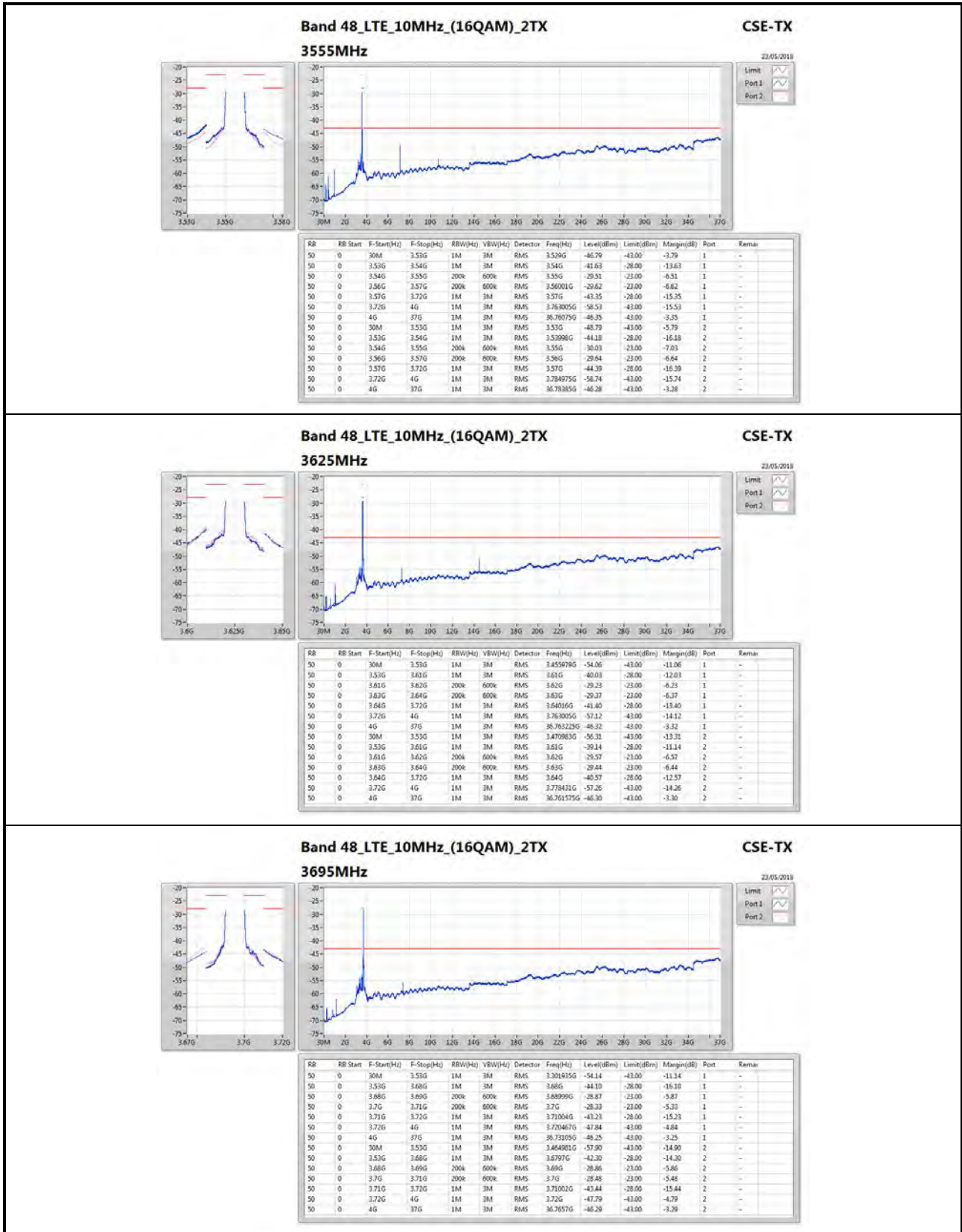

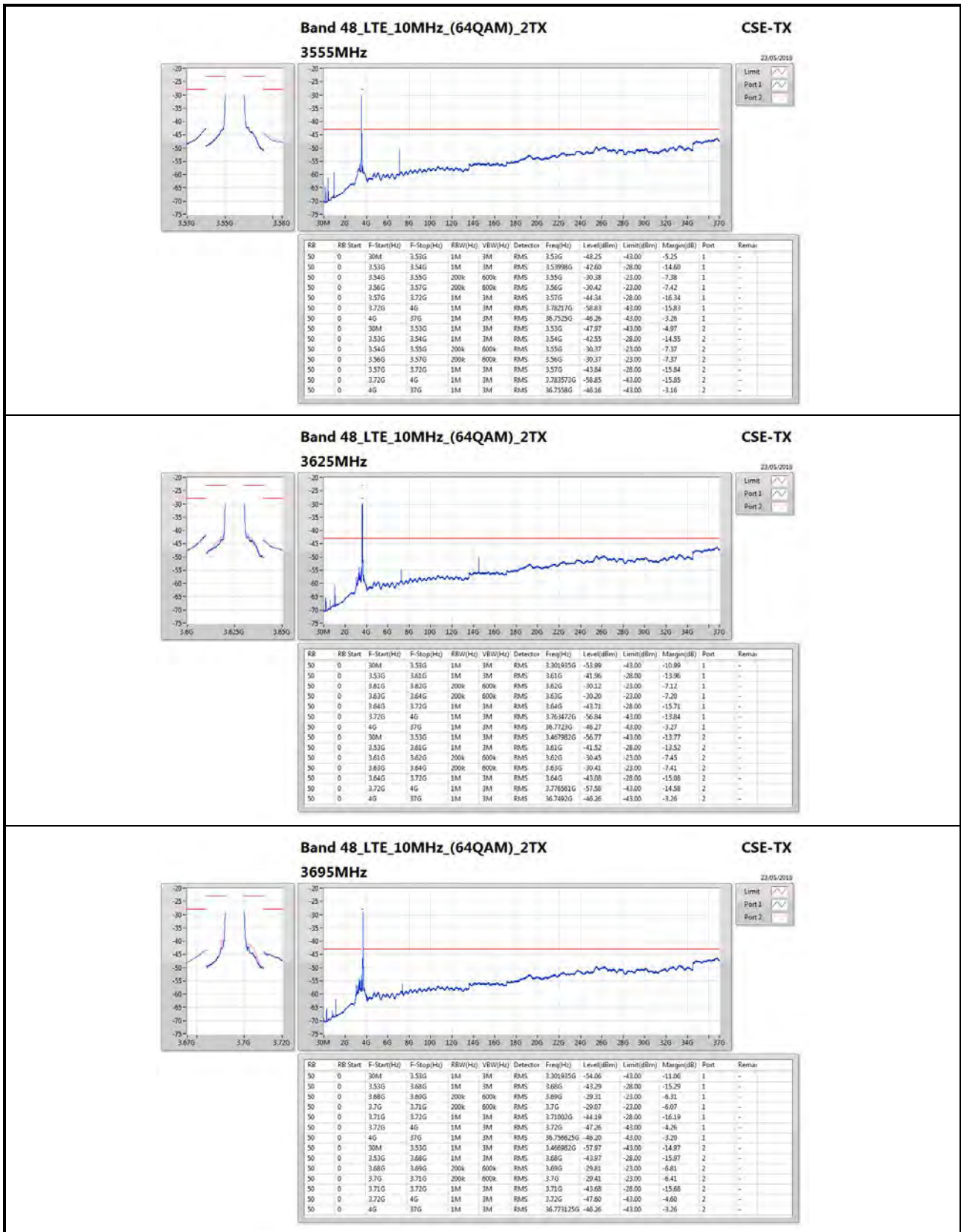

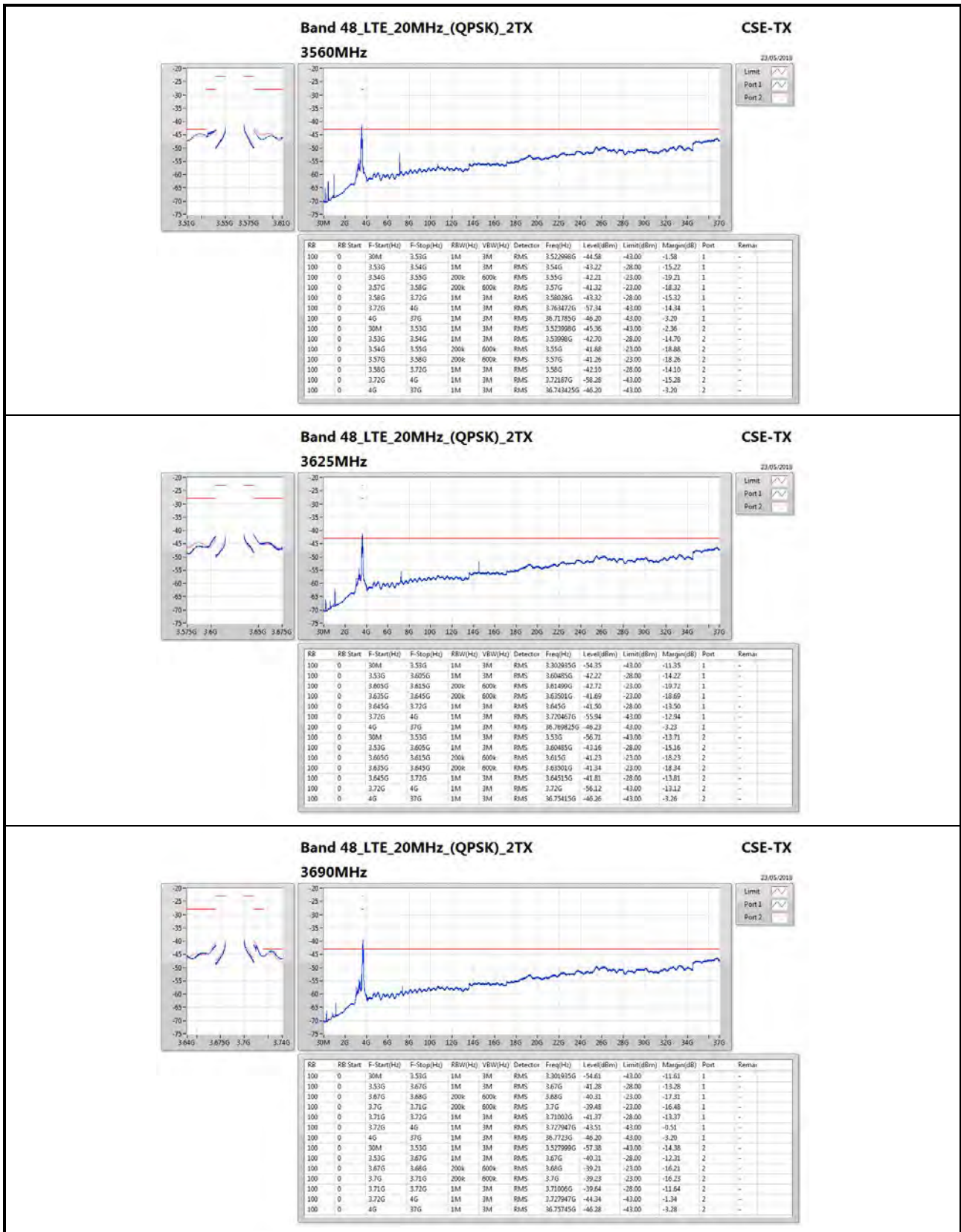

Band 48_LTE_20MHz_(QPSK)_2TX

3690MHz

CSE-TX

23/05/2018

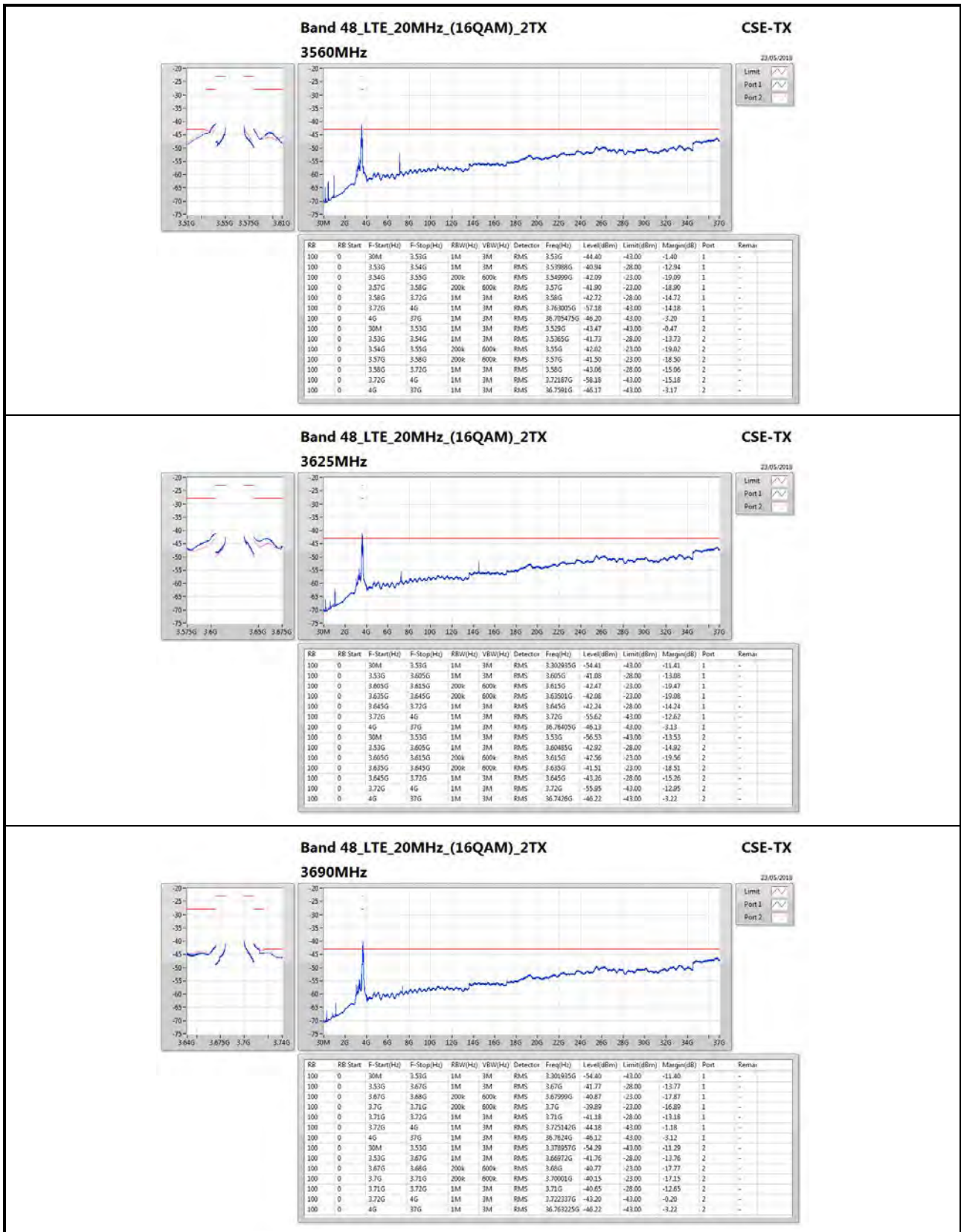

Band 48_LTE_20MHz_(16QAM)_2TX

3690MHz

CSE-TX

23/05/2018

Limit

Port 1

Port 2

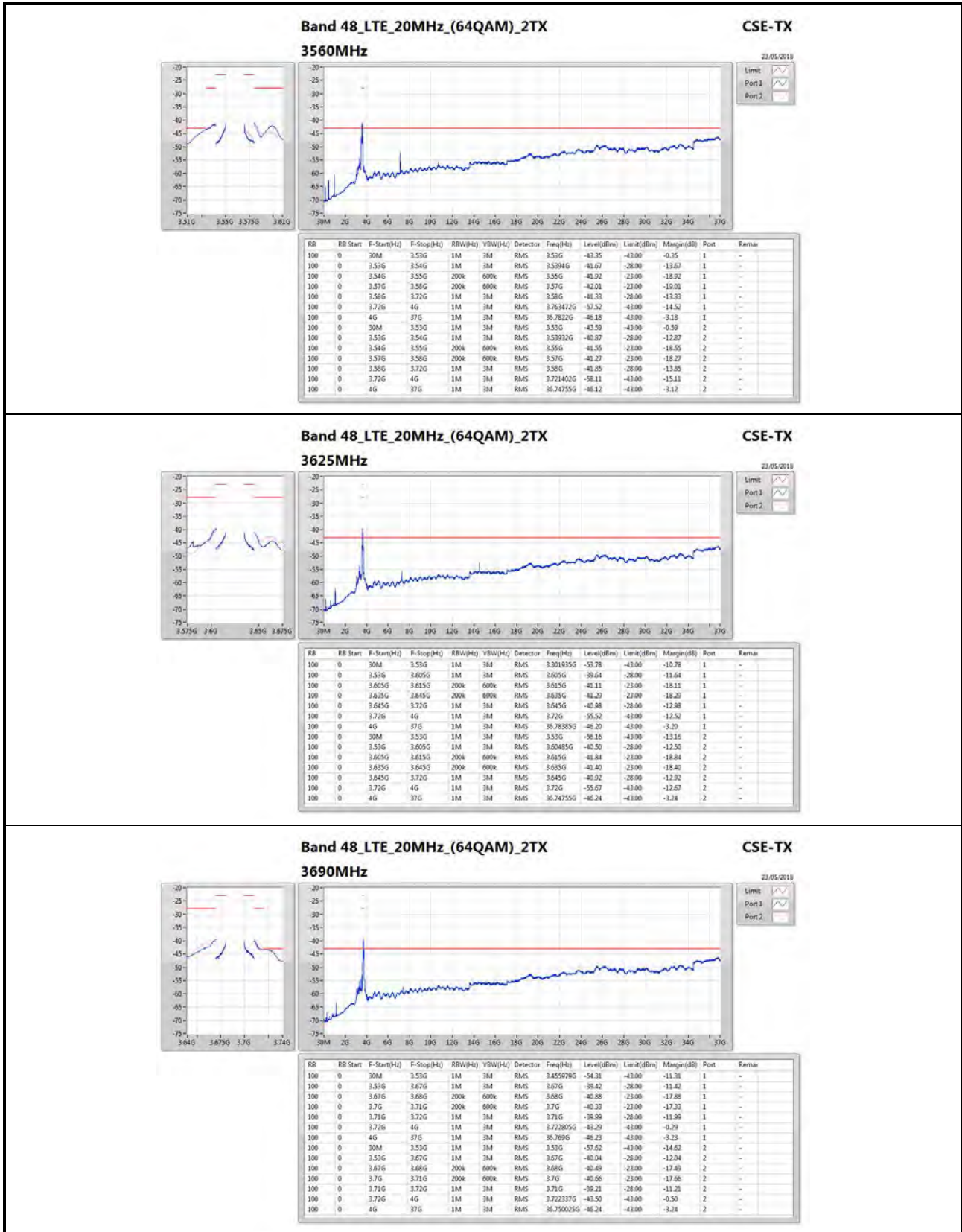

Band 48_LTE_20MHz_(64QAM)_2TX

3690MHz

CSE-TX

23/05/2018



Field Strength of Spurious Radiation (30MHz ~ 1GHz)

Remark: Spurious emissions within 30-1000MHz were found more than 20dB below limit line



Field Strength of Spurious Radiation (Above 1GHz) - Band-edge

Configurations	10MHz / QPSK / 3555 MHz
-----------------------	-------------------------

Horizontal

	Freq	Level	Limit Line	Over Limit	Read Level	CableAntenna Loss	Antenna Factor	Preamp Factor	A/Pos	T/Pos	Remark	Pol/Phase
	MHz	dBuV/m	dBuV/m	dB	dBuV	dB	dB/m	dB	cm	deg		
1	3529.60	51.12	55.20	-4.08	47.74	6.78	30.39	33.79	262	107	Average	HORIZONTAL
2 •	3554.60	111.71			108.20	6.80	30.48	33.77	262	107	Average	HORIZONTAL
3	3570.20	54.36	70.20	-15.84	50.81	6.81	30.51	33.77	262	107	Average	HORIZONTAL

Item 2 is the fundamental frequency.

Vertical

	Freq	Level	Limit Line	Over Limit	Read Level	CableAntenna Loss	Antenna Factor	Preamp Factor	A/Pos	T/Pos	Remark	Pol/Phase
	MHz	dBuV/m	dBuV/m	dB	dBuV	dB	dB/m	dB	cm	deg		
1	3528.60	48.77	55.20	-6.43	45.39	6.78	30.39	33.79	225	128	Average	VERTICAL
2 •	3555.00	100.48			96.97	6.80	30.48	33.77	225	128	Average	VERTICAL
3	3570.30	49.59	70.20	-20.61	46.04	6.81	30.51	33.77	225	128	Average	VERTICAL

Item 2 is the fundamental frequency.



Field Strength of Spurious Radiation Result

Appendix H

Configurations	10MHz / 16QAM / 3555 MHz
-----------------------	--------------------------

Horizontal

	Freq	Level	Limit	Over	Read	CableAntenna	Preamp	A/Pos	T/Pos	Remark	Pol/Phase	
	MHz	dBuV/m	dBuV/m	dB	dBuV	dB	dB/m	dB	cm	deg		
1	3529.80	49.59	55.20	-5.61	46.21	6.78	30.39	33.79	261	97	Average	HORIZONTAL
2 •	3555.00	108.91			105.40	6.80	30.48	33.77	261	97	Average	HORIZONTAL
3	3570.20	52.70	70.20	-17.50	49.15	6.81	30.51	33.77	261	97	Average	HORIZONTAL

Item 2 is the fundamental frequency.

Vertical

	Freq	Level	Limit	Over	Read	CableAntenna	Preamp	A/Pos	T/Pos	Remark	Pol/Phase	
	MHz	dBuV/m	dBuV/m	dB	dBuV	dB	dB/m	dB	cm	deg		
1	3529.00	48.52	55.20	-6.68	45.14	6.78	30.39	33.79	134	143	Average	VERTICAL
2 •	3554.80	101.49			97.98	6.80	30.48	33.77	134	143	Average	VERTICAL
3	3570.20	49.45	70.20	-20.75	45.90	6.81	30.51	33.77	134	143	Average	VERTICAL

Item 2 is the fundamental frequency.



Configurations	10MHz / 64QAM / 3555 MHz
-----------------------	--------------------------

Horizontal

	Freq	Level	Limit Line	Over Limit	Read Level	Cable Loss	Antenna Factor	Preamp Factor	A/Pos	T/Pos	Remark	Pol/Phase
	MHz	dBuV/m	dBuV/m	dB	dBuV	dB	dB/m	dB	cm	deg		
1	3529.40	50.28	55.20	-4.92	46.90	6.78	30.39	33.79	264	110	Average	HORIZONTAL
2 •	3558.80	109.10			105.59	6.80	30.48	33.77	264	110	Average	HORIZONTAL
3	3570.20	52.66	70.20	-17.54	49.11	6.81	30.51	33.77	264	110	Average	HORIZONTAL

Item 2 is the fundamental frequency.

Vertical

	Freq	Level	Limit Line	Over Limit	Read Level	Cable Loss	Antenna Factor	Preamp Factor	A/Pos	T/Pos	Remark	Pol/Phase
	MHz	dBuV/m	dBuV/m	dB	dBuV	dB	dB/m	dB	cm	deg		
1	3529.40	48.46	55.20	-6.74	45.08	6.78	30.39	33.79	130	140	Average	VERTICAL
2 •	3552.80	101.47			97.96	6.80	30.48	33.77	130	140	Average	VERTICAL
3	3570.20	49.23	70.20	-20.97	45.68	6.81	30.51	33.77	130	140	Average	VERTICAL

Item 2 is the fundamental frequency.



Configurations	10MHz / QPSK / 3625 MHz
-----------------------	-------------------------

Horizontal

	Freq	Level	Limit Line	Over Limit	Read Level	Cable Loss	Antenna Factor	Preamp Factor	A/Pos	T/Pos	Remark	Pol/Phase
	MHz	dBuV/m	dBuV/m	dB	dBuV	dB	dB/m	dB	cm	deg		
1	3528.20	48.54	55.20	-6.66	45.16	6.78	30.39	33.79	262	111	Average	HORIZONTAL
2 •	3625.00	109.47			105.64	6.87	30.69	33.73	262	111	Average	HORIZONTAL
3	3640.60	53.40	70.20	-16.80	49.52	6.88	30.72	33.72	262	111	Average	HORIZONTAL

Item 2 is the fundamental frequency.

Vertical

	Freq	Level	Limit Line	Over Limit	Read Level	Cable Loss	Antenna Factor	Preamp Factor	A/Pos	T/Pos	Remark	Pol/Phase
	MHz	dBuV/m	dBuV/m	dB	dBuV	dB	dB/m	dB	cm	deg		
1	3528.60	48.39	55.20	-6.81	45.01	6.78	30.39	33.79	146	313	Average	VERTICAL
2 •	3625.00	96.90			93.07	6.87	30.69	33.73	146	313	Average	VERTICAL
3	3641.40	48.95	70.20	-21.25	45.07	6.88	30.72	33.72	146	313	Average	VERTICAL

Item 2 is the fundamental frequency.



Field Strength of Spurious Radiation Result

Configurations	10MHz / 16QAM / 3625 MHz
-----------------------	--------------------------

Horizontal

	Freq	Level	Limit Line	Over Limit	Read Level	CableAntenna Loss	Antenna Factor	Preamp Factor	A/Pos	T/Pos	Remark	Pol/Phase
	MHz	dBuV/m	dBuV/m	dB	dBuV	dB	dB/m	dB	cm	deg		
1	3528.60	48.31	55.20	-6.89	44.93	6.78	30.39	33.79	267	111	Average	HORIZONTAL
2 •	3625.00	109.17			105.34	6.87	30.69	33.73	267	111	Average	HORIZONTAL
3	3640.40	53.29	70.20	-16.91	49.41	6.88	30.72	33.72	267	111	Average	HORIZONTAL

Item 2 is the fundamental frequency.

Vertical

	Freq	Level	Limit Line	Over Limit	Read Level	CableAntenna Loss	Antenna Factor	Preamp Factor	A/Pos	T/Pos	Remark	Pol/Phase
	MHz	dBuV/m	dBuV/m	dB	dBuV	dB	dB/m	dB	cm	deg		
1	3529.40	48.17	55.20	-7.03	44.79	6.78	30.39	33.79	124	141	Average	VERTICAL
2 •	3625.00	99.35			95.52	6.87	30.69	33.73	124	141	Average	VERTICAL
3	3641.00	49.38	70.20	-20.82	45.50	6.88	30.72	33.72	124	141	Average	VERTICAL

Item 2 is the fundamental frequency.



Field Strength of Spurious Radiation Result

Appendix H

Configurations	10MHz / 64QAM / 3625 MHz
-----------------------	--------------------------

Horizontal

	Freq	Level	Limit	Over	Read	CableAntenna	Preamp	A/Pos	T/Pos	Remark	Pol/Phase	
	MHz	dBuV/m	dBuV/m	dB	dBuV	dB	dB/m	dB	cm	deg		
1	3530.00	48.28	55.20	-6.92	44.90	6.78	30.39	33.79	260	114	Average	HORIZONTAL
2 •	3621.40	108.49			104.70	6.86	30.66	33.73	260	114	Average	HORIZONTAL
3	3640.40	51.73	70.20	-18.47	47.85	6.88	30.72	33.72	260	114	Average	HORIZONTAL

Item 2 is the fundamental frequency.

Vertical

	Freq	Level	Limit	Over	Read	CableAntenna	Preamp	A/Pos	T/Pos	Remark	Pol/Phase	
	MHz	dBuV/m	dBuV/m	dB	dBuV	dB	dB/m	dB	cm	deg		
1	3527.80	48.09	55.20	-7.11	44.71	6.78	30.39	33.79	128	141	Average	VERTICAL
2 •	3628.60	99.92			96.09	6.87	30.69	33.73	128	141	Average	VERTICAL
3	3641.40	49.38	70.20	-20.82	45.50	6.88	30.72	33.72	128	141	Average	VERTICAL

Item 2 is the fundamental frequency.



Configurations	10MHz / QPSK / 3695 MHz
-----------------------	-------------------------

Horizontal

	Freq	Level	Limit Line	Over Limit	Read Level	Cable Loss	Antenna Factor	Preamp Factor	A/Pos	T/Pos	Remark	Pol/Phase
	MHz	dBuV/m	dBuV/m	dB	dBuV	dB	dB/m	dB	cm	deg		
1	3679.80	51.41	70.20	-18.79	47.35	6.92	30.84	33.70	279	107	Average	HORIZONTAL
2 •	3694.80	109.28			105.17	6.93	30.87	33.69	279	107	Average	HORIZONTAL
3	3720.80	49.58	55.20	-5.62	45.34	6.95	30.96	33.67	279	107	Average	HORIZONTAL

Item 2 is the fundamental frequency.

Vertical

	Freq	Level	Limit Line	Over Limit	Read Level	Cable Loss	Antenna Factor	Preamp Factor	A/Pos	T/Pos	Remark	Pol/Phase
	MHz	dBuV/m	dBuV/m	dB	dBuV	dB	dB/m	dB	cm	deg		
1	3679.20	48.81	70.20	-21.39	44.75	6.92	30.84	33.70	136	217	Average	VERTICAL
2 •	3695.00	98.36			94.25	6.93	30.87	33.69	136	217	Average	VERTICAL
3	3720.80	48.58	55.20	-6.62	44.34	6.95	30.96	33.67	136	217	Average	VERTICAL

Item 2 is the fundamental frequency.



Field Strength of Spurious Radiation Result

Appendix H

Configurations	10MHz / 16QAM / 3695 MHz
-----------------------	--------------------------

Horizontal

	Freq	Level	Limit	Over	Read	CableAntenna	Preamp	A/Pos	T/Pos	Remark	Pol/Phase	
	MHz	dBuV/m	dBuV/m	dB	dBuV	dB	dB/m	dB	cm	deg		
1	3679.80	52.42	70.20	-17.78	48.36	6.92	30.84	33.70	270	111	Average	HORIZONTAL
2 •	3695.00	110.62			106.51	6.93	30.87	33.69	270	111	Average	HORIZONTAL
3	3720.20	49.60	55.20	-5.60	45.36	6.95	30.96	33.67	270	111	Average	HORIZONTAL

Item 2 is the fundamental frequency.

Vertical

	Freq	Level	Limit	Over	Read	CableAntenna	Preamp	A/Pos	T/Pos	Remark	Pol/Phase	
	MHz	dBuV/m	dBuV/m	dB	dBuV	dB	dB/m	dB	cm	deg		
1	3679.40	48.71	70.20	-21.49	44.65	6.92	30.84	33.70	123	136	Average	VERTICAL
2 •	3694.80	99.66			95.55	6.93	30.87	33.69	123	136	Average	VERTICAL
3	3723.60	48.51	55.20	-6.69	44.27	6.95	30.96	33.67	123	136	Average	VERTICAL

Item 2 is the fundamental frequency.



Configurations	10MHz / 64QAM / 3695 MHz
-----------------------	--------------------------

Horizontal

	Freq	Level	Limit Line	Over Limit	Read Level	Cable Loss	Antenna Factor	Preamp Factor	A/Pos	T/Pos	Remark	Pol/Phase
	MHz	dBuV/m	dBuV/m	dB	dBuV	dB	dB/m	dB	cm	deg		
1	3679.80	53.25	70.20	-16.95	49.19	6.92	30.84	33.70	249	105	Average	HORIZONTAL
2 •	3698.80	109.10			104.95	6.93	30.90	33.68	249	105	Average	HORIZONTAL
3	3721.00	49.44	55.20	-5.76	45.20	6.95	30.96	33.67	249	105	Average	HORIZONTAL

Item 2 is the fundamental frequency.

Vertical

	Freq	Level	Limit Line	Over Limit	Read Level	Cable Loss	Antenna Factor	Preamp Factor	A/Pos	T/Pos	Remark	Pol/Phase
	MHz	dBuV/m	dBuV/m	dB	dBuV	dB	dB/m	dB	cm	deg		
1	3679.80	49.05	70.20	-21.15	44.99	6.92	30.84	33.70	122	141	Average	VERTICAL
2 •	3698.80	100.49			96.34	6.93	30.90	33.68	122	141	Average	VERTICAL
3	3725.60	48.59	55.20	-6.61	44.35	6.95	30.96	33.67	122	141	Average	VERTICAL

Item 2 is the fundamental frequency.



Field Strength of Spurious Radiation Result

Configurations	20MHz / QPSK / 3560 MHz
-----------------------	-------------------------

Horizontal

	Freq	Level	Limit Line	Over Limit	Read Level	CableAntenna Loss	Antenna Factor	Preamp Factor	A/Pos	T/Pos	Remark	Pol/Phase
	MHz	dBuV/m	dBuV/m	dB	dBuV	dB	dB/m	dB	cm	deg		
1	3525.80	52.88	55.20	-2.32	49.50	6.78	30.39	33.79	267	110	Average	HORIZONTAL
2 •	3560.00	105.88			102.37	6.80	30.48	33.77	267	110	Average	HORIZONTAL
3	3586.60	51.70	70.20	-18.50	48.05	6.83	30.57	33.75	267	110	Average	HORIZONTAL

Item 2 is the fundamental frequency.

Vertical

	Freq	Level	Limit Line	Over Limit	Read Level	CableAntenna Loss	Antenna Factor	Preamp Factor	A/Pos	T/Pos	Remark	Pol/Phase
	MHz	dBuV/m	dBuV/m	dB	dBuV	dB	dB/m	dB	cm	deg		
1	3526.00	48.83	55.20	-6.37	45.45	6.78	30.39	33.79	105	140	Average	VERTICAL
2 •	3560.80	96.74			93.23	6.80	30.48	33.77	105	140	Average	VERTICAL
3	3580.20	49.11	70.20	-21.09	45.51	6.82	30.54	33.76	105	140	Average	VERTICAL

Item 2 is the fundamental frequency.



Field Strength of Spurious Radiation Result

Configurations	20MHz / 16QAM / 3560 MHz
-----------------------	--------------------------

Horizontal

	Freq	Level	Limit	Over	Read	CableAntenna	Preamp	A/Pos	T/Pos	Remark	Pol/Phase	
	MHz	dBuV/m	dBuV/m	dB	dBuV	dB	dB/m	dB	cm	deg		
1	3529.00	51.81	55.20	-3.39	48.43	6.78	30.39	33.79	263	115	Average	HORIZONTAL
2 •	3560.00	106.89			103.38	6.80	30.48	33.77	263	115	Average	HORIZONTAL
3	3580.20	53.26	70.20	-16.94	49.66	6.82	30.54	33.76	263	115	Average	HORIZONTAL

Item 2 is the fundamental frequency.

Vertical

	Freq	Level	Limit	Over	Read	CableAntenna	Preamp	A/Pos	T/Pos	Remark	Pol/Phase	
	MHz	dBuV/m	dBuV/m	dB	dBuV	dB	dB/m	dB	cm	deg		
1	3529.40	48.86	55.20	-6.34	45.48	6.78	30.39	33.79	107	144	Average	VERTICAL
2 •	3560.00	95.50			91.99	6.80	30.48	33.77	107	144	Average	VERTICAL
3	3580.40	49.20	70.20	-21.00	45.60	6.82	30.54	33.76	107	144	Average	VERTICAL

Item 2 is the fundamental frequency.



Field Strength of Spurious Radiation Result

Configurations	20MHz / 64QAM / 3560 MHz
-----------------------	--------------------------

Horizontal

	Freq	Level	Limit	Over	Read	CableAntenna	Preamp	A/Pos	T/Pos	Remark	Pol/Phase	
	MHz	dBuV/m	dBuV/m	dB	dBuV	dB	dB/m	dB	cm	deg		
1	3529.60	54.04	55.20	-1.16	50.66	6.78	30.39	33.79	267	119	Average	HORIZONTAL
2	• 3554.60	106.41			102.90	6.80	30.48	33.77	267	119	Average	HORIZONTAL
3	3580.30	52.34	70.20	-17.86	48.74	6.82	30.54	33.76	267	119	Average	HORIZONTAL

Item 2 is the fundamental frequency.

Vertical

	Freq	Level	Limit	Over	Read	CableAntenna	Preamp	A/Pos	T/Pos	Remark	Pol/Phase	
	MHz	dBuV/m	dBuV/m	dB	dBuV	dB	dB/m	dB	cm	deg		
1	3529.20	49.44	55.20	-5.76	46.06	6.78	30.39	33.79	122	146	Average	VERTICAL
2	• 3568.40	95.60			92.05	6.81	30.51	33.77	122	146	Average	VERTICAL
3	3580.40	50.01	70.20	-20.19	46.41	6.82	30.54	33.76	122	146	Average	VERTICAL

Item 2 is the fundamental frequency.



Configurations	20MHz / QPSK / 3625 MHz
-----------------------	-------------------------

Horizontal

	Freq	Level	Limit Line	Over Limit	Read Level	Cable Loss	Antenna Factor	Preamp Factor	A/Pos	T/Pos	Remark	Pol/Phase
	MHz	dBuV/m	dBuV/m	dB	dBuV	dB	dB/m	dB	cm	deg		
1	3529.40	48.77	55.20	-6.43	45.39	6.78	30.39	33.79	264	108	Average	HORIZONTAL
2 •	3617.80	106.01			102.22	6.86	30.66	33.73	264	108	Average	HORIZONTAL
3	3723.40	48.72	55.20	-6.48	44.48	6.95	30.96	33.67	264	108	Average	HORIZONTAL

Item 2 is the fundamental frequency.

Vertical

	Freq	Level	Limit Line	Over Limit	Read Level	Cable Loss	Antenna Factor	Preamp Factor	A/Pos	T/Pos	Remark	Pol/Phase
	MHz	dBuV/m	dBuV/m	dB	dBuV	dB	dB/m	dB	cm	deg		
1	3527.80	48.45	55.20	-6.75	45.07	6.78	30.39	33.79	129	142	Average	VERTICAL
2 •	3630.20	97.83			94.00	6.87	30.69	33.73	129	142	Average	VERTICAL
3	3723.80	48.60	55.20	-6.60	44.36	6.95	30.96	33.67	129	142	Average	VERTICAL

Item 2 is the fundamental frequency.



Field Strength of Spurious Radiation Result

Configurations	20MHz / 16QAM / 3625 MHz
-----------------------	--------------------------

Horizontal

	Freq	Level	Limit Line	Over Limit	Read Level	CableAntenna Loss	Antenna Factor	Preamp Factor	A/Pos	T/Pos	Remark	Pol/Phase
	MHz	dBuV/m	dBuV/m	dB	dBuV	dB	dB/m	dB	cm	deg		
1	3527.80	48.42	55.20	-6.78	45.04	6.78	30.39	33.79	272	110	Average	HORIZONTAL
2 •	3625.00	106.45			102.62	6.87	30.69	33.73	272	110	Average	HORIZONTAL
3	3724.60	48.49	55.20	-6.71	44.25	6.95	30.96	33.67	272	110	Average	HORIZONTAL

Item 2 is the fundamental frequency.

Vertical

	Freq	Level	Limit Line	Over Limit	Read Level	CableAntenna Loss	Antenna Factor	Preamp Factor	A/Pos	T/Pos	Remark	Pol/Phase
	MHz	dBuV/m	dBuV/m	dB	dBuV	dB	dB/m	dB	cm	deg		
1	3528.60	48.27	55.20	-6.93	44.89	6.78	30.39	33.79	116	140	Average	VERTICAL
2 •	3633.40	96.51			92.68	6.87	30.69	33.73	116	140	Average	VERTICAL
3	3724.20	48.35	55.20	-6.85	44.11	6.95	30.96	33.67	116	140	Average	VERTICAL

Item 2 is the fundamental frequency.



Field Strength of Spurious Radiation Result

Appendix H

Configurations	20MHz / 64QAM / 3625 MHz
-----------------------	--------------------------

Horizontal

	Freq	Level	Limit Line	Over Limit	Read Level	Cable Loss	Antenna Factor	Preamp Factor	A/Pos	T/Pos	Remark	Pol/Phase
	MHz	dBuV/m	dBuV/m	dB	dBuV	dB	dB/m	dB	cm	deg		
1	3528.60	48.42	55.20	-6.78	45.04	6.78	30.39	33.79	268	111	Average	HORIZONTAL
2 •	3633.40	105.91			102.08	6.87	30.69	33.73	268	111	Average	HORIZONTAL
3	3723.40	48.44	55.20	-6.76	44.20	6.95	30.96	33.67	268	111	Average	HORIZONTAL

Item 2 is the fundamental frequency.

Vertical

	Freq	Level	Limit Line	Over Limit	Read Level	Cable Loss	Antenna Factor	Preamp Factor	A/Pos	T/Pos	Remark	Pol/Phase
	MHz	dBuV/m	dBuV/m	dB	dBuV	dB	dB/m	dB	cm	deg		
1	3527.80	48.28	55.20	-6.92	44.90	6.78	30.39	33.79	116	140	Average	VERTICAL
2 •	3633.40	96.58			92.75	6.87	30.69	33.73	116	140	Average	VERTICAL
3	3721.00	48.35	55.20	-6.85	44.11	6.95	30.96	33.67	116	140	Average	VERTICAL

Item 2 is the fundamental frequency.



Field Strength of Spurious Radiation Result

Configurations	20MHz / QPSK / 3690 MHz
-----------------------	-------------------------

Horizontal

	Freq	Level	Limit Line	Over Limit	Read Level	CableAntenna Loss	Antenna Factor	Preamp Factor	A/Pos	T/Pos	Remark	Pol/Phase
	MHz	dBuV/m	dBuV/m	dB	dBuV	dB	dB/m	dB	cm	deg		
1	3669.60	55.89	70.20	-14.31	51.87	6.91	30.81	33.70	266	113	Average	HORIZONTAL
2 •	3682.40	107.04			102.98	6.92	30.84	33.70	266	113	Average	HORIZONTAL
3	3720.80	50.20	55.20	-5.00	45.96	6.95	30.96	33.67	266	113	Average	HORIZONTAL

Item 2 is the fundamental frequency.

Vertical

	Freq	Level	Limit Line	Over Limit	Read Level	CableAntenna Loss	Antenna Factor	Preamp Factor	A/Pos	T/Pos	Remark	Pol/Phase
	MHz	dBuV/m	dBuV/m	dB	dBuV	dB	dB/m	dB	cm	deg		
1	3669.40	49.86	70.20	-20.34	45.84	6.91	30.81	33.70	122	142	Average	VERTICAL
2 •	3695.40	97.02			92.91	6.93	30.87	33.69	122	142	Average	VERTICAL
3	3728.40	48.91	55.20	-6.29	44.67	6.95	30.96	33.67	122	142	Average	VERTICAL

Item 2 is the fundamental frequency.



Field Strength of Spurious Radiation Result

Configurations	20MHz / 16QAM / 3690 MHz
-----------------------	--------------------------

Horizontal

	Freq	Level	Limit	Over	Read	CableAntenna	Preamp	A/Pos	T/Pos	Remark	Pol/Phase	
	MHz	dBuV/m	dBuV/m	dB	dBuV	dB	dB/m	dB	cm	deg		
1	3669.60	54.03	70.20	-16.17	50.01	6.91	30.81	33.70	281	111	Average	HORIZONTAL
2 •	3681.60	105.42	-----	-----	101.36	6.92	30.84	33.70	281	111	Average	HORIZONTAL
3	3720.30	49.64	55.20	-5.56	45.40	6.95	30.96	33.67	281	111	Average	HORIZONTAL

Item 2 is the fundamental frequency.

Vertical

	Freq	Level	Limit	Over	Read	CableAntenna	Preamp	A/Pos	T/Pos	Remark	Pol/Phase	
	MHz	dBuV/m	dBuV/m	dB	dBuV	dB	dB/m	dB	cm	deg		
1	3669.20	50.24	70.20	-19.96	46.22	6.91	30.81	33.70	112	141	Average	VERTICAL
2 •	3698.40	96.22	-----	-----	92.07	6.93	30.90	33.68	112	141	Average	VERTICAL
3	3723.20	48.67	55.20	-6.53	44.43	6.95	30.96	33.67	112	141	Average	VERTICAL

Item 2 is the fundamental frequency.



Field Strength of Spurious Radiation Result

Configurations	20MHz / 64QAM / 3690 MHz
-----------------------	--------------------------

Horizontal

	Freq	Level	Limit	Over	Read	CableAntenna	Preamp	A/Pos	T/Pos	Remark	Pol/Phase	
	MHz	dBuV/m	dBuV/m	dB	dBuV	dB	dB/m	dB	cm	deg		
1	3669.70	53.01	70.20	-17.19	48.99	6.91	30.81	33.70	280	114	Average	HORIZONTAL
2 •	3698.40	105.88			101.73	6.93	30.90	33.68	280	114	Average	HORIZONTAL
3	3720.80	50.29	55.20	-4.91	46.05	6.95	30.96	33.67	280	114	Average	HORIZONTAL

Item 2 is the fundamental frequency.

Vertical

	Freq	Level	Limit	Over	Read	CableAntenna	Preamp	A/Pos	T/Pos	Remark	Pol/Phase	
	MHz	dBuV/m	dBuV/m	dB	dBuV	dB	dB/m	dB	cm	deg		
1	3669.80	49.82	70.20	-20.38	45.80	6.91	30.81	33.70	123	140	Average	VERTICAL
2 •	3698.40	97.72			93.57	6.93	30.90	33.68	123	140	Average	VERTICAL
3	3728.20	48.81	55.20	-6.39	44.57	6.95	30.96	33.67	123	140	Average	VERTICAL

Item 2 is the fundamental frequency.



Field Strength of Spurious Radiation (Above 1GHz) - Harmonic

Configurations	10MHz / QPSK / 3555 MHz
-----------------------	-------------------------

Horizontal

	Freq	Level	Limit Line	Over Limit	Read Level	CableAntenna Loss	Antenna Factor	Preamp Factor	A/Pos	T/Pos	Remark	Pol/Phase
	MHz	dBuV/m	dBuV/m	dB	dBuV	dB	dB/m	dB	cm	deg		
1	7110.25	39.37	55.20	-15.83	27.82	8.18	36.80	33.43	259	121	Average	HORIZONTAL

Vertical

	Freq	Level	Limit Line	Over Limit	Read Level	CableAntenna Loss	Antenna Factor	Preamp Factor	A/Pos	T/Pos	Remark	Pol/Phase
	MHz	dBuV/m	dBuV/m	dB	dBuV	dB	dB/m	dB	cm	deg		
1	7110.07	39.29	55.20	-15.91	27.74	8.18	36.80	33.43	127	156	Average	VERTICAL



Field Strength of Spurious Radiation Result

Configurations	10MHz / 16QAM / 3555 MHz
-----------------------	--------------------------

Horizontal

	Freq	Level	Limit	Over	Read	CableAntenna	Preamp	A/Pos	T/Pos	Remark	Pol/Phase	
	MHz	dBuV/m	dBuV/m	dB	dBuV	Loss	Factor	Factor	cm	deg		
1	7109.68	39.28	55.20	-15.92	27.73	8.18	36.80	33.43	258	112	Average	HORIZONTAL

Vertical

	Freq	Level	Limit	Over	Read	CableAntenna	Preamp	A/Pos	T/Pos	Remark	Pol/Phase	
	MHz	dBuV/m	dBuV/m	dB	dBuV	Loss	Factor	Factor	cm	deg		
1	7110.29	39.23	55.20	-15.97	27.68	8.18	36.80	33.43	127	159	Average	VERTICAL



Configurations	10MHz / 64QAM / 3555 MHz
-----------------------	--------------------------

Horizontal

	Freq	Level	Limit	Over	Read	CableAntenna	Preamp	A/Pos	T/Pos	Remark	Pol/Phase	
	MHz	dBuV/m	dBuV/m	dB	dBuV	Loss	Factor	Factor	cm	deg		
1	7110.18	39.24	55.20	-15.96	27.69	8.18	36.80	33.43	271	130	Average	HORIZONTAL

Vertical

	Freq	Level	Limit	Over	Read	CableAntenna	Preamp	A/Pos	T/Pos	Remark	Pol/Phase	
	MHz	dBuV/m	dBuV/m	dB	dBuV	Loss	Factor	Factor	cm	deg		
1	7110.03	39.32	55.20	-15.88	27.77	8.18	36.80	33.43	118	139	Average	VERTICAL



Configurations	10MHz / QPSK / 3625 MHz
-----------------------	-------------------------

Horizontal

	Freq	Level	Limit	Over	Read	CableAntenna	Preamp	A/Pos	T/Pos	Remark	Pol/Phase	
	MHz	dBuV/m	dBuV/m	dB	dBuV	dB	dB/m	dB	cm	deg		
1	7249.93	39.86	55.20	-15.34	28.14	8.24	37.00	33.52	271	125	Average	HORIZONTAL

Vertical

	Freq	Level	Limit	Over	Read	CableAntenna	Preamp	A/Pos	T/Pos	Remark	Pol/Phase	
	MHz	dBuV/m	dBuV/m	dB	dBuV	dB	dB/m	dB	cm	deg		
1	7249.63	39.93	55.20	-15.27	28.21	8.24	37.00	33.52	128	149	Average	VERTICAL



Field Strength of Spurious Radiation Result

Configurations	10MHz / 16QAM / 3625 MHz
-----------------------	--------------------------

Horizontal

	Freq	Level	Limit Line	Over Limit	Read Level	CableAntenna Loss	Antenna Factor	Preamp Factor	A/Pos	T/Pos	Remark	Pol/Phase
	MHz	dBuV/m	dBuV/m	dB	dBuV	dB	dB/m	dB	cm	deg		
1	7249.73	39.90	55.20	-15.30	28.18	8.24	37.00	33.52	265	124	Average	HORIZONTAL

Vertical

	Freq	Level	Limit Line	Over Limit	Read Level	CableAntenna Loss	Antenna Factor	Preamp Factor	A/Pos	T/Pos	Remark	Pol/Phase
	MHz	dBuV/m	dBuV/m	dB	dBuV	dB	dB/m	dB	cm	deg		
1	7249.79	40.08	55.20	-15.12	28.36	8.24	37.00	33.52	132	159	Average	VERTICAL



Configurations	10MHz / 64QAM / 3625 MHz
-----------------------	--------------------------

Horizontal

	Freq	Level	Limit	Over	Read	CableAntenna	Preamp	A/Pos	T/Pos	Remark	Pol/Phase	
	MHz	dBuV/m	dBuV/m	dB	dBuV	Loss	Factor	Factor	cm	deg		
1	7250.43	39.86	55.20	-15.34	28.14	8.24	37.00	33.52	265	115	Average	HORIZONTAL

Vertical

	Freq	Level	Limit	Over	Read	CableAntenna	Preamp	A/Pos	T/Pos	Remark	Pol/Phase	
	MHz	dBuV/m	dBuV/m	dB	dBuV	Loss	Factor	Factor	cm	deg		
1	7249.52	39.85	55.20	-15.35	28.13	8.24	37.00	33.52	117	152	Average	VERTICAL



Configurations	10MHz / QPSK / 3695 MHz
-----------------------	-------------------------

Horizontal

	Freq	Level	Limit	Over	Read	CableAntenna	Preamp	A/Pos	T/Pos	Remark	Pol/Phase	
	MHz	dBuV/m	dBuV/m	dB	dBuV	dB	dB/m	dB	cm	deg		
1	7389.92	40.18	55.20	-15.02	28.49	8.08	37.23	33.62	269	123	Average	HORIZONTAL

Vertical

	Freq	Level	Limit	Over	Read	CableAntenna	Preamp	A/Pos	T/Pos	Remark	Pol/Phase	
	MHz	dBuV/m	dBuV/m	dB	dBuV	dB	dB/m	dB	cm	deg		
1	7390.30	40.07	55.20	-15.13	28.38	8.08	37.23	33.62	131	158	Average	VERTICAL



Configurations	10MHz / 16QAM / 3695 MHz
-----------------------	--------------------------

Horizontal

	Freq	Level	Limit	Over	Read	CableAntenna	Preamp	A/Pos	T/Pos	Remark	Pol/Phase	
	MHz	dBuV/m	dBuV/m	dB	dBuV	dB	dB/m	dB	cm	deg		
1	7390.33	40.10	55.20	-15.10	28.41	8.08	37.23	33.62	281	132	Average	HORIZONTAL

Vertical

	Freq	Level	Limit	Over	Read	CableAntenna	Preamp	A/Pos	T/Pos	Remark	Pol/Phase	
	MHz	dBuV/m	dBuV/m	dB	dBuV	dB	dB/m	dB	cm	deg		
1	7390.29	40.04	55.20	-15.16	28.35	8.08	37.23	33.62	136	158	Average	VERTICAL



Configurations	10MHz / 64QAM / 3695 MHz
-----------------------	--------------------------

Horizontal

	Freq	Level	Limit	Over	Read	CableAntenna	Preamp	A/Pos	T/Pos	Remark	Pol/Phase	
	MHz	dBuV/m	dBuV/m	dB	dBuV	dB	dB/m	dB	cm	deg		
1	7390.30	39.97	55.20	-15.23	28.28	8.08	37.23	33.62	272	124	Average	HORIZONTAL

Vertical

	Freq	Level	Limit	Over	Read	CableAntenna	Preamp	A/Pos	T/Pos	Remark	Pol/Phase	
	MHz	dBuV/m	dBuV/m	dB	dBuV	dB	dB/m	dB	cm	deg		
1	7390.45	39.96	55.20	-15.24	28.27	8.08	37.23	33.62	126	147	Average	VERTICAL



Configurations	20MHz / QPSK / 3560 MHz
-----------------------	-------------------------

Horizontal

	Freq	Level	Limit	Over	Read	CableAntenna	Preamp	A/Pos	T/Pos	Remark	Pol/Phase	
	MHz	dBuV/m	dBuV/m	dB	dBuV	Loss	Factor	Factor	cm	deg		
1	7120.15	39.38	55.20	-15.82	27.83	8.18	36.80	33.43	259	121	Average	HORIZONTAL

Vertical

	Freq	Level	Limit	Over	Read	CableAntenna	Preamp	A/Pos	T/Pos	Remark	Pol/Phase	
	MHz	dBuV/m	dBuV/m	dB	dBuV	Loss	Factor	Factor	cm	deg		
1	7119.96	39.35	55.20	-15.85	27.80	8.18	36.80	33.43	128	151	Average	VERTICAL



Configurations	20MHz / 16QAM / 3560 MHz
-----------------------	--------------------------

Horizontal

	Freq	Level	Limit	Over	Read	CableAntenna	Preamp	A/Pos	T/Pos	Remark	Pol/Phase	
	MHz	dBuV/m	dBuV/m	dB	dBuV	Loss	Factor	Factor	cm	deg		
1	7120.26	39.17	55.20	-16.03	27.62	8.18	36.80	33.43	267	126	Average	HORIZONTAL

Vertical

	Freq	Level	Limit	Over	Read	CableAntenna	Preamp	A/Pos	T/Pos	Remark	Pol/Phase	
	MHz	dBuV/m	dBuV/m	dB	dBuV	Loss	Factor	Factor	cm	deg		
1	7119.88	39.10	55.20	-16.10	27.55	8.18	36.80	33.43	128	163	Average	VERTICAL



Configurations	20MHz / 64QAM / 3560 MHz
-----------------------	--------------------------

Horizontal

	Freq	Level	Limit	Over	Read	CableAntenna	Preamp	A/Pos	T/Pos	Remark	Pol/Phase	
	MHz	dBuV/m	dBuV/m	dB	dBuV	Loss	Factor	Factor	cm	deg		
1	7120.19	39.22	55.20	-15.98	27.67	8.18	36.80	33.43	262	128	Average	HORIZONTAL

Vertical

	Freq	Level	Limit	Over	Read	CableAntenna	Preamp	A/Pos	T/Pos	Remark	Pol/Phase	
	MHz	dBuV/m	dBuV/m	dB	dBuV	Loss	Factor	Factor	cm	deg		
1	7120.28	39.12	55.20	-16.08	27.57	8.18	36.80	33.43	128	156	Average	VERTICAL



Configurations	20MHz / QPSK / 3625 MHz
-----------------------	-------------------------

Horizontal

	Freq	Level	Limit	Over	Read	CableAntenna	Preamp	A/Pos	T/Pos	Remark	Pol/Phase	
	MHz	dBuV/m	dBuV/m	dB	dBuV	dB	dB/m	dB	cm	deg		
1	7250.41	39.83	55.20	-15.37	28.11	8.24	37.00	33.52	272	126	Average	HORIZONTAL

Vertical

	Freq	Level	Limit	Over	Read	CableAntenna	Preamp	A/Pos	T/Pos	Remark	Pol/Phase	
	MHz	dBuV/m	dBuV/m	dB	dBuV	dB	dB/m	dB	cm	deg		
1	7250.49	39.85	55.20	-15.35	28.13	8.24	37.00	33.52	136	158	Average	VERTICAL



Configurations	20MHz / 16QAM / 3625 MHz
-----------------------	--------------------------

Horizontal

	Freq	Level	Limit	Over	Read	CableAntenna	Preamp	A/Pos	T/Pos	Remark	Pol/Phase	
	MHz	dBuV/m	dBuV/m	dB	dBuV	dB	dB/m	dB	cm	deg		
1	7250.43	40.00	55.20	-15.20	28.28	8.24	37.00	33.52	265	124	Average	HORIZONTAL

Vertical

	Freq	Level	Limit	Over	Read	CableAntenna	Preamp	A/Pos	T/Pos	Remark	Pol/Phase	
	MHz	dBuV/m	dBuV/m	dB	dBuV	dB	dB/m	dB	cm	deg		
1	7250.31	39.96	55.20	-15.24	28.24	8.24	37.00	33.52	124	151	Average	VERTICAL



Configurations	20MHz / 64QAM / 3625 MHz
-----------------------	--------------------------

Horizontal

	Freq	Level	Limit	Over	Read	CableAntenna	Preamp	A/Pos	T/Pos	Remark	Pol/Phase	
	MHz	dBuV/m	dBuV/m	dB	dBuV	Loss	Factor	Factor	cm	deg		
1	7250.30	40.08	55.20	-15.12	28.36	8.24	37.00	33.52	271	120	Average	HORIZONTAL

Vertical

	Freq	Level	Limit	Over	Read	CableAntenna	Preamp	A/Pos	T/Pos	Remark	Pol/Phase	
	MHz	dBuV/m	dBuV/m	dB	dBuV	Loss	Factor	Factor	cm	deg		
1	7250.06	39.85	55.20	-15.35	28.13	8.24	37.00	33.52	131	139	Average	VERTICAL



Field Strength of Spurious Radiation Result

Configurations	20MHz / QPSK / 3690 MHz
-----------------------	-------------------------

Horizontal

	Freq	Level	Limit	Over	Read	CableAntenna	Preamp	A/Pos	T/Pos	Remark	Pol/Phase	
	MHz	dBuV/m	dBuV/m	dB	dBuV	Loss	Factor	Factor	cm	deg		
1	7380.32	40.36	55.20	-14.84	28.67	8.08	37.23	33.62	278	125	Average	HORIZONTAL

Vertical

	Freq	Level	Limit	Over	Read	CableAntenna	Preamp	A/Pos	T/Pos	Remark	Pol/Phase	
	MHz	dBuV/m	dBuV/m	dB	dBuV	Loss	Factor	Factor	cm	deg		
1	7379.77	40.16	55.20	-15.04	28.47	8.08	37.23	33.62	129	157	Average	VERTICAL



Configurations	20MHz / 16QAM / 3690 MHz
-----------------------	--------------------------

Horizontal

	Freq	Level	Limit	Over	Read	CableAntenna	Preamp	A/Pos	T/Pos	Remark	Pol/Phase	
	MHz	dBuV/m	dBuV/m	dB	dBuV	dB	dB/m	dB	cm	deg		
1	7380.45	40.18	55.20	-15.02	28.49	8.08	37.23	33.62	269	122	Average	HORIZONTAL

Vertical

	Freq	Level	Limit	Over	Read	CableAntenna	Preamp	A/Pos	T/Pos	Remark	Pol/Phase	
	MHz	dBuV/m	dBuV/m	dB	dBuV	dB	dB/m	dB	cm	deg		
1	7379.83	40.13	55.20	-15.07	28.44	8.08	37.23	33.62	132	157	Average	VERTICAL



Field Strength of Spurious Radiation Result

Configurations	20MHz / 64QAM / 3690 MHz
-----------------------	--------------------------

Horizontal

	Freq	Level	Limit	Over	Read	CableAntenna	Preamp	A/Pos	T/Pos	Remark	Pol/Phase	
	MHz	dBuV/m	dBuV/m	dB	dBuV	Loss	Factor	dB	cm	deg		
1	7380.37	40.31	55.20	-14.89	28.62	8.08	37.23	33.62	272	129	Average	HORIZONTAL

Vertical

	Freq	Level	Limit	Over	Read	CableAntenna	Preamp	A/Pos	T/Pos	Remark	Pol/Phase	
	MHz	dBuV/m	dBuV/m	dB	dBuV	Loss	Factor	dB	cm	deg		
1	7379.67	40.26	55.20	-14.94	28.57	8.08	37.23	33.62	136	151	Average	VERTICAL



Summary

Mode	Voltage (V)	Temp (°C)	Ch (Hz)	Fl (Hz)	Fh (Hz)	Fl Limit (Hz)	Fh Limit (Hz)	Port	Result
Band 48			-	-	-	-	-	-	-
Band 48_LTE_10MHz_(QPSK)_2T X	110	-30	3.555G	3.550521G	3.559491G	3.55G	3.7G	1	Pass



Result

Mode	Voltage (V)	Temp (°C)	Ch (Hz)	FI (Hz)	Fh (Hz)	FI Limit (Hz)	Fh Limit (Hz)	Port	Result
Band 48_LTE_10MHz_(QPSK)_2TX			-	-	-	-	-	-	-
3555MHz	110	-30	3.555G	3.550521G	3.559491G	3.55G	3.7G	1	Pass
3555MHz	110	-20	3.555G	3.550521G	3.55949G	3.55G	3.7G	1	Pass
3555MHz	110	-10	3.555G	3.55052G	3.559489G	3.55G	3.7G	1	Pass
3555MHz	110	0	3.555G	3.550521G	3.559489G	3.55G	3.7G	1	Pass
3555MHz	110	10	3.555G	3.550523G	3.559501G	3.55G	3.7G	1	Pass
3555MHz	93.5	20	3.555G	3.55051G	3.559495G	3.55G	3.7G	1	Pass
3555MHz	110	20	3.555G	3.550523G	3.559501G	3.55G	3.7G	1	Pass
3555MHz	126.5	20	3.555G	3.55051G	3.559495G	3.55G	3.7G	1	Pass
3555MHz	110	30	3.555G	3.550517G	3.559506G	3.55G	3.7G	1	Pass
3555MHz	110	40	3.555G	3.55052G	3.559491G	3.55G	3.7G	1	Pass
3555MHz	110	50	3.555G	3.55051G	3.559494G	3.55G	3.7G	1	Pass
3695MHz	110	-30	3.695G	3.690517G	3.6995G	3.55G	3.7G	1	Pass
3695MHz	110	-20	3.695G	3.690519G	3.699502G	3.55G	3.7G	1	Pass
3695MHz	110	-10	3.695G	3.690517G	3.699502G	3.55G	3.7G	1	Pass
3695MHz	110	0	3.695G	3.690518G	3.6995G	3.55G	3.7G	1	Pass
3695MHz	110	10	3.695G	3.690511G	3.69949G	3.55G	3.7G	1	Pass
3695MHz	93.5	20	3.695G	3.690517G	3.699502G	3.55G	3.7G	1	Pass
3695MHz	110	20	3.695G	3.690512G	3.69949G	3.55G	3.7G	1	Pass
3695MHz	126.5	20	3.695G	3.690521G	3.699488G	3.55G	3.7G	1	Pass
3695MHz	110	30	3.695G	3.690511G	3.699489G	3.55G	3.7G	1	Pass
3695MHz	110	40	3.695G	3.690523G	3.699494G	3.55G	3.7G	1	Pass
3695MHz	110	50	3.695G	3.690517G	3.699502G	3.55G	3.7G	1	Pass
Band 48_LTE_10MHz_(16QAM)_2TX			-	-	-	-	-	-	-
3555MHz	110	-30	3.555G	3.550499G	3.559485G	3.55G	3.7G	1	Pass
3555MHz	110	-20	3.555G	3.550499G	3.559485G	3.55G	3.7G	1	Pass
3555MHz	110	-10	3.555G	3.550497G	3.559485G	3.55G	3.7G	1	Pass
3555MHz	110	0	3.555G	3.5505G	3.559486G	3.55G	3.7G	1	Pass
3555MHz	110	10	3.555G	3.550497G	3.559492G	3.55G	3.7G	1	Pass
3555MHz	93.5	20	3.555G	3.550495G	3.559491G	3.55G	3.7G	1	Pass
3555MHz	110	20	3.555G	3.55049G	3.559485G	3.55G	3.7G	1	Pass
3555MHz	126.5	20	3.555G	3.550498G	3.559493G	3.55G	3.7G	1	Pass
3555MHz	110	30	3.555G	3.55049G	3.559485G	3.55G	3.7G	1	Pass
3555MHz	110	40	3.555G	3.550495G	3.559491G	3.55G	3.7G	1	Pass
3555MHz	110	50	3.555G	3.550497G	3.559493G	3.55G	3.7G	1	Pass
3695MHz	110	-30	3.695G	3.690499G	3.699484G	3.55G	3.7G	1	Pass
3695MHz	110	-20	3.695G	3.690496G	3.699484G	3.55G	3.7G	1	Pass
3695MHz	110	-10	3.695G	3.690497G	3.699484G	3.55G	3.7G	1	Pass
3695MHz	110	0	3.695G	3.690498G	3.699484G	3.55G	3.7G	1	Pass
3695MHz	110	10	3.695G	3.690497G	3.699489G	3.55G	3.7G	1	Pass
3695MHz	93.5	20	3.695G	3.690497G	3.69949G	3.55G	3.7G	1	Pass
3695MHz	110	20	3.695G	3.690497G	3.699488G	3.55G	3.7G	1	Pass
3695MHz	126.5	20	3.695G	3.690494G	3.699487G	3.55G	3.7G	1	Pass



Frequency Stability Result

Appendix I

Mode	Voltage (V)	Temp (°C)	Ch (Hz)	FI (Hz)	Fh (Hz)	FI Limit (Hz)	Fh Limit (Hz)	Port	Result
3695MHz	110	30	3.695G	3.690497G	3.699489G	3.55G	3.7G	1	Pass
3695MHz	110	40	3.695G	3.690494G	3.699487G	3.55G	3.7G	1	Pass
3695MHz	110	50	3.695G	3.690497G	3.699489G	3.55G	3.7G	1	Pass
Band 48_LTE_10MHz_(64QAM)_2TX			-	-	-	-	-	-	-
3555MHz	110	-30	3.555G	3.550521G	3.559469G	3.55G	3.7G	1	Pass
3555MHz	110	-20	3.555G	3.55052G	3.559479G	3.55G	3.7G	1	Pass
3555MHz	110	-10	3.555G	3.550515G	3.559474G	3.55G	3.7G	1	Pass
3555MHz	110	0	3.555G	3.55052G	3.559469G	3.55G	3.7G	1	Pass
3555MHz	110	10	3.555G	3.55053G	3.559466G	3.55G	3.7G	1	Pass
3555MHz	93.5	20	3.555G	3.550527G	3.559466G	3.55G	3.7G	1	Pass
3555MHz	110	20	3.555G	3.550527G	3.559466G	3.55G	3.7G	1	Pass
3555MHz	126.5	20	3.555G	3.550529G	3.559467G	3.55G	3.7G	1	Pass
3555MHz	110	30	3.555G	3.550527G	3.559466G	3.55G	3.7G	1	Pass
3555MHz	110	40	3.555G	3.550528G	3.559467G	3.55G	3.7G	1	Pass
3555MHz	110	50	3.555G	3.550528G	3.559466G	3.55G	3.7G	1	Pass
3695MHz	110	-30	3.695G	3.690519G	3.699465G	3.55G	3.7G	1	Pass
3695MHz	110	-20	3.695G	3.690519G	3.699466G	3.55G	3.7G	1	Pass
3695MHz	110	-10	3.695G	3.69052G	3.699466G	3.55G	3.7G	1	Pass
3695MHz	110	0	3.695G	3.690519G	3.699465G	3.55G	3.7G	1	Pass
3695MHz	110	10	3.695G	3.690525G	3.699462G	3.55G	3.7G	1	Pass
3695MHz	93.5	20	3.695G	3.690525G	3.699464G	3.55G	3.7G	1	Pass
3695MHz	110	20	3.695G	3.690524G	3.699463G	3.55G	3.7G	1	Pass
3695MHz	126.5	20	3.695G	3.690525G	3.699464G	3.55G	3.7G	1	Pass
3695MHz	110	30	3.695G	3.690524G	3.699464G	3.55G	3.7G	1	Pass
3695MHz	110	40	3.695G	3.690525G	3.699463G	3.55G	3.7G	1	Pass
3695MHz	110	50	3.695G	3.690525G	3.699464G	3.55G	3.7G	1	Pass
Band 48_LTE_20MHz_(QPSK)_2TX			-	-	-	-	-	-	-
3560MHz	110	-30	3.56G	3.551078G	3.568896G	3.55G	3.7G	1	Pass
3560MHz	110	-20	3.56G	3.55108G	3.568899G	3.55G	3.7G	1	Pass
3560MHz	110	-10	3.56G	3.551078G	3.568896G	3.55G	3.7G	1	Pass
3560MHz	110	0	3.56G	3.551081G	3.568895G	3.55G	3.7G	1	Pass
3560MHz	110	10	3.56G	3.551081G	3.568904G	3.55G	3.7G	1	Pass
3560MHz	93.5	20	3.56G	3.551077G	3.5689G	3.55G	3.7G	1	Pass
3560MHz	110	20	3.56G	3.55108G	3.568901G	3.55G	3.7G	1	Pass
3560MHz	126.5	20	3.56G	3.551085G	3.568887G	3.55G	3.7G	1	Pass
3560MHz	110	30	3.56G	3.55108G	3.568898G	3.55G	3.7G	1	Pass
3560MHz	110	40	3.56G	3.551088G	3.568899G	3.55G	3.7G	1	Pass
3560MHz	110	50	3.56G	3.551078G	3.5689G	3.55G	3.7G	1	Pass
3690MHz	110	-30	3.69G	3.681075G	3.698858G	3.55G	3.7G	1	Pass
3690MHz	110	-20	3.69G	3.681089G	3.698864G	3.55G	3.7G	1	Pass
3690MHz	110	-10	3.69G	3.681081G	3.698893G	3.55G	3.7G	1	Pass
3690MHz	110	0	3.69G	3.681082G	3.698879G	3.55G	3.7G	1	Pass
3690MHz	110	10	3.69G	3.681084G	3.698892G	3.55G	3.7G	1	Pass
3690MHz	93.5	20	3.69G	3.681083G	3.698893G	3.55G	3.7G	1	Pass



Frequency Stability Result

Appendix I

Mode	Voltage (V)	Temp (°C)	Ch (Hz)	Fl (Hz)	Fh (Hz)	Fl Limit (Hz)	Fh Limit (Hz)	Port	Result
3690MHz	110	20	3.69G	3.681077G	3.698894G	3.55G	3.7G	1	Pass
3690MHz	126.5	20	3.69G	3.681084G	3.698878G	3.55G	3.7G	1	Pass
3690MHz	110	30	3.69G	3.681078G	3.698891G	3.55G	3.7G	1	Pass
3690MHz	110	40	3.69G	3.681089G	3.698894G	3.55G	3.7G	1	Pass
3690MHz	110	50	3.69G	3.681079G	3.698895G	3.55G	3.7G	1	Pass
Band 48_LTE_20MHz_(16QAM)_2TX			-	-	-	-	-	-	-
3560MHz	110	-30	3.56G	3.5511G	3.568896G	3.55G	3.7G	1	Pass
3560MHz	110	-20	3.56G	3.551095G	3.568897G	3.55G	3.7G	1	Pass
3560MHz	110	-10	3.56G	3.551106G	3.568894G	3.55G	3.7G	1	Pass
3560MHz	110	0	3.56G	3.551092G	3.568895G	3.55G	3.7G	1	Pass
3560MHz	110	10	3.56G	3.551099G	3.568899G	3.55G	3.7G	1	Pass
3560MHz	93.5	20	3.56G	3.551095G	3.568886G	3.55G	3.7G	1	Pass
3560MHz	110	20	3.56G	3.551104G	3.5689G	3.55G	3.7G	1	Pass
3560MHz	126.5	20	3.56G	3.551099G	3.5689G	3.55G	3.7G	1	Pass
3560MHz	110	30	3.56G	3.551105G	3.568905G	3.55G	3.7G	1	Pass
3560MHz	110	40	3.56G	3.551085G	3.568889G	3.55G	3.7G	1	Pass
3560MHz	110	50	3.56G	3.551097G	3.568901G	3.55G	3.7G	1	Pass
3690MHz	110	-30	3.69G	3.681092G	3.698888G	3.55G	3.7G	1	Pass
3690MHz	110	-20	3.69G	3.681092G	3.698889G	3.55G	3.7G	1	Pass
3690MHz	110	-10	3.69G	3.681101G	3.698875G	3.55G	3.7G	1	Pass
3690MHz	110	0	3.69G	3.681093G	3.698888G	3.55G	3.7G	1	Pass
3690MHz	110	10	3.69G	3.681099G	3.698888G	3.55G	3.7G	1	Pass
3690MHz	93.5	20	3.69G	3.681095G	3.69889G	3.55G	3.7G	1	Pass
3690MHz	110	20	3.69G	3.681097G	3.698881G	3.55G	3.7G	1	Pass
3690MHz	126.5	20	3.69G	3.681099G	3.698889G	3.55G	3.7G	1	Pass
3690MHz	110	30	3.69G	3.68109G	3.698887G	3.55G	3.7G	1	Pass
3690MHz	110	40	3.69G	3.681105G	3.698876G	3.55G	3.7G	1	Pass
3690MHz	110	50	3.69G	3.681099G	3.698888G	3.55G	3.7G	1	Pass
Band 48_LTE_20MHz_(64QAM)_2TX			-	-	-	-	-	-	-
3560MHz	110	-30	3.56G	3.551093G	3.568907G	3.55G	3.7G	1	Pass
3560MHz	110	-20	3.56G	3.551094G	3.568907G	3.55G	3.7G	1	Pass
3560MHz	110	-10	3.56G	3.551084G	3.568893G	3.55G	3.7G	1	Pass
3560MHz	110	0	3.56G	3.551083G	3.568899G	3.55G	3.7G	1	Pass
3560MHz	110	10	3.56G	3.551091G	3.568892G	3.55G	3.7G	1	Pass
3560MHz	93.5	20	3.56G	3.551105G	3.568904G	3.55G	3.7G	1	Pass
3560MHz	110	20	3.56G	3.551089G	3.568894G	3.55G	3.7G	1	Pass
3560MHz	126.5	20	3.56G	3.5511G	3.568904G	3.55G	3.7G	1	Pass
3560MHz	110	30	3.56G	3.551106G	3.568905G	3.55G	3.7G	1	Pass
3560MHz	110	40	3.56G	3.551106G	3.568905G	3.55G	3.7G	1	Pass
3560MHz	110	50	3.56G	3.551105G	3.568904G	3.55G	3.7G	1	Pass
3690MHz	110	-30	3.69G	3.681091G	3.6989G	3.55G	3.7G	1	Pass
3690MHz	110	-20	3.69G	3.681085G	3.698895G	3.55G	3.7G	1	Pass
3690MHz	110	-10	3.69G	3.681092G	3.698898G	3.55G	3.7G	1	Pass
3690MHz	110	0	3.69G	3.681089G	3.6989G	3.55G	3.7G	1	Pass



Frequency Stability Result

Appendix I

Mode	Voltage (V)	Temp (°C)	Ch (Hz)	Fl (Hz)	Fh (Hz)	Fl Limit (Hz)	Fh Limit (Hz)	Port	Result
3690MHz	110	10	3.69G	3.681081G	3.69889G	3.55G	3.7G	1	Pass
3690MHz	93.5	20	3.69G	3.681081G	3.698891G	3.55G	3.7G	1	Pass
3690MHz	110	20	3.69G	3.681084G	3.698894G	3.55G	3.7G	1	Pass
3690MHz	126.5	20	3.69G	3.681085G	3.698896G	3.55G	3.7G	1	Pass
3690MHz	110	30	3.69G	3.681087G	3.698897G	3.55G	3.7G	1	Pass
3690MHz	110	40	3.69G	3.681092G	3.698903G	3.55G	3.7G	1	Pass
3690MHz	110	50	3.69G	3.681093G	3.698903G	3.55G	3.7G	1	Pass

Bandwidth (MHz)	Test Channel	Frequency error (Hz)		
		E-TM 3.1 (QPSK)	E-TM 3.2 (16QAM)	E-TM 3.3 (64QAM)
10MHz	Bottom	-4.99	-17.8	-10.81
	Middle	-8.42	-5.75	-4.29
	Top	1.82	4.2	4.53

Bandwidth (MHz)	Test Channel	Frequency error (Hz)		
		E-TM 3.1 (QPSK)	E-TM 3.2 (16QAM)	E-TM 3.3 (64QAM)
20MHz	Bottom	-5.98	-2.37	2.66
	Middle	-5.84	-6.59	3.9
	Top	-6.57	-5.1	-3.47