

# FCC PART 15.247



## EMI MEASUREMENT AND TEST REPORT

For

Video54 Technologies, Inc

883 North Shoreline Blvd, Suite A-100  
CA, USA 94043

**FCC ID: S9GMF2501**

<b>This Report Concerns:</b> <input checked="" type="checkbox"/> Original Report	<b>Equipment Type:</b> Media Adaptor, 802.11b/g
<b>Test Engineer:</b> Snell Leong 	
<b>Report No.:</b> R0505122	
<b>Report Date:</b> 2005-06-13	
<b>Reviewed By:</b> Richard Lee 	
<b>Prepared By:</b> Bay Area Compliance Laboratory Corporation (BACL) 230 Commercial Street Sunnyvale, CA 94085 Tel: (408) 732-9162 Fax: (408) 732 9164	

**Note:** The test report is specially limited to the above company and this particular sample only. It may not be duplicated without prior written consent of Bay Area Compliance Laboratory Corporation. This report **must not** be used by the client to claim product certification, approval, or endorsement by NVLAP, NIST or any agency of the US Government.

**TABLE OF CONTENTS**

<b>GENERAL INFORMATION.....</b>	<b>4</b>
PRODUCT DESCRIPTION FOR EQUIPMENT UNDER TEST (EUT) .....	4
OBJECTIVE .....	4
RELATED SUBMITTAL(S)/GRANT(S).....	4
TEST METHODOLOGY .....	4
TEST FACILITY .....	4
<b>SYSTEM TEST CONFIGURATION.....</b>	<b>6</b>
JUSTIFICATION .....	6
EUT EXERCISE SOFTWARE.....	6
SPECIAL ACCESSORIES.....	6
SCHEMATICS / BLOCK DIAGRAM .....	6
EQUIPMENT MODIFICATIONS .....	6
LOCAL SUPPORT EQUIPMENT LIST AND DETAILS .....	6
POWER SUPPLY INFORMATION.....	6
INTERFACE PORTS AND CABLING.....	6
CONFIGURATION OF TEST SYSTEM .....	7
TEST SETUP BLOCK DIAGRAM.....	7
<b>SUMMARY OF TEST RESULTS.....</b>	<b>8</b>
<b>§15.203 - ANTENNA REQUIREMENT.....</b>	<b>9</b>
STANDARD APPLICABLE .....	9
<b>§15.207(A) - CONDUCTED EMISSIONS.....</b>	<b>10</b>
MEASUREMENT UNCERTAINTY .....	10
EUT SETUP.....	10
SPECTRUM ANALYZER SETUP .....	10
TEST EQUIPMENT LIST AND DETAILS.....	10
TEST PROCEDURE .....	10
SUMMARY OF TEST RESULTS .....	11
CONDUCTED EMISSIONS TEST DATA .....	11
PLOT OF CONDUCTED EMISSIONS TEST DATA .....	11
<b>§2.1051 - SPURIOUS EMISSIONS AT ANTENNA TERMINALS.....</b>	<b>14</b>
STANDARD APPLICABLE .....	14
EQUIPMENT LISTS .....	14
MEASUREMENT RESULT .....	14
<b>§15.205 &amp; §15.209 - SPURIOUS RADIATED EMISSION.....</b>	<b>18</b>
MEASUREMENT UNCERTAINTY .....	18
EUT SETUP.....	19
SPECTRUM ANALYZER SETUP .....	19
TEST EQUIPMENT LIST AND DETAILS.....	19
TEST PROCEDURE .....	20
CORRECTED AMPLITUDE & MARGIN CALCULATION .....	20
ENVIRONMENTAL CONDITIONS .....	20
SUMMARY OF TEST RESULTS .....	21
RADIATED EMISSION TEST RESULT FOR 802.11B.....	22
RADIATED EMISSION TEST RESULT FOR 802.11G .....	24
<b>§15.247(A)(2) – 6 DB BANDWIDTH.....</b>	<b>26</b>
STANDARD APPLICABLE .....	26
MEASUREMENT PROCEDURE.....	26
EQUIPMENT LISTS .....	26
MEASUREMENT RESULT .....	27
<b>§15.247(B)(3) - PEAK OUTPUT POWER MEASUREMENT.....</b>	<b>31</b>
STANDARD APPLICABLE .....	31

---

MEASUREMENT PROCEDURE.....	31
EQUIPMENT LISTS .....	31
MEASUREMENT RESULT .....	31
<b>§15.247(D) - 100 KHZ BANDWIDTH OF BAND EDGES .....</b>	<b>36</b>
STANDARD APPLICABLE .....	36
MEASUREMENT PROCEDURE.....	36
EQUIPMENT LISTS .....	36
MEASUREMENT RESULT .....	36
<b>§15.247(E) - POWER SPECTRAL DENSITY .....</b>	<b>39</b>
STANDARD APPLICABLE .....	39
MEASUREMENT PROCEDURE.....	39
EQUIPMENT LISTS .....	39
MEASUREMENT RESULT .....	39

---

## GENERAL INFORMATION

---

### Product Description for Equipment Under Test (EUT)

The *Video54 Technologies, Inc's* product, FCC ID: *S9GMF2501*, Model: *MF2501* or the "EUT" as referred to this report is a Media Adaptor, 802.11b/g which measures approximately 140mmL x 120mmW x 70mmH. The EUT operates at the frequency range of 2412– 2462MHz, with maximum output power of 0.125W (20.97dBm).

*\* The test data gathered are from typical production sample, serial number: WN82153FB000454 provided by the manufacturer.*

### Objective

This type approval report is prepared on behalf of *Video54 Technologies, Inc* in accordance with Part 2, Subpart J, Part 15, Subparts A , B and C of the Federal Communication Commissions rules.

The objective is to determine compliance with FCC rules for Output Power, Antenna Requirements, 6 dB Bandwidth, power spectral density, 100 kHz Bandwidth of Band Edges Measurement, Spurious Emission, Conducted and Spurious Radiated Emission.

### Related Submittal(s)/Grant(s)

No Related Submittals.

### Test Methodology

All measurements contained in this report were conducted with ANSI C63.4-2003, American National Standard for Methods of Measurement of Radio-Noise Emissions from Low-Voltage Electrical and Electronic Equipment in the range of 9 kHz to 40 GHz.

All radiated and conducted emissions measurement was performed at Bay Area Compliance Laboratory, Corp. The radiated testing was performed at an antenna-to-EUT distance of 3 meters.

### Test Facility

The Open Area Test site used by BACL to collect radiated and conducted emission measurement data is located in the back parking lot of the building at 230 Commercial Street, Sunnyvale, California, USA.

Test site at BACL has been fully described in reports submitted to the Federal Communication Commission (FCC) and Voluntary Control Council for Interference (VCCI). The details of these reports has been found to be in compliance with the requirements of Section 2.948 of the FCC Rules on February 11 and December 10, 1997 and Article 8 of the VCCI regulations on December 25, 1997. The facility also complies with the radiated and AC line conducted test site criteria set forth in ANSI C63.4-2003.

The Federal Communications Commission and Voluntary Control Council for Interference has the reports on file and is listed under FCC file 31040/SIT 1300F2 and VCCI Registration No.: C-1298 and R-1234. The test site has been approved by the FCC and VCCI for public use and is listed in the FCC Public Access Link (PAL) database.

---

Additionally, BACL is a National Institute of Standards and Technology (NIST) accredited laboratory, under the National Voluntary Laboratory Accredited Program (Lab Code 200167-0). The current scope of accreditations can be found at <http://ts.nist.gov/ts/hdocs/210/214/scopes/2001670.htm>

## SYSTEM TEST CONFIGURATION

### Justification

The host system was configured for testing according to ANSI C63.4-2003.

The EUT was tested in the normal (native) operating mode to represent *worst*-case results during the final qualification test.

### EUT Exercise Software

The EUT exercise program used during radiated and conducted testing was designed to exercise the system components. The test software, provided by the customer, is started the Windows terminal program under the Windows 98/2000/ME/XP operating system.

Once loaded, set the Tx channel to low, mid and high for testing.

### Special Accessories

As shown in following test block diagram, all interface cables used for compliance testing are shielded.

### Schematics / Block Diagram

Please refer to Appendix A.

### Equipment Modifications

No modifications were made to the EUT.

### Local Support Equipment List and Details

Manufacturer	Description	Model	Serial Number	FCC ID
IBM	Laptop PC	2662	N/A	N/A

### Power Supply Information

Manufacturer	Description	Model	Serial Number	FCC ID
Unifive	AD-DC Adaptor	US300520	501-0145002	None

### Interface Ports and Cabling

Cable Description	Length (M)	From	To
Ethernet Cable	2.0	Ethernet port / EUT	Ethernet Port / PC

### Configuration of Test System

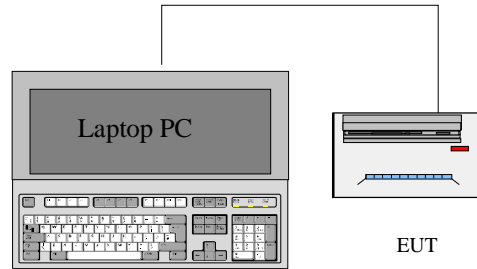

### Test Setup Block Diagram

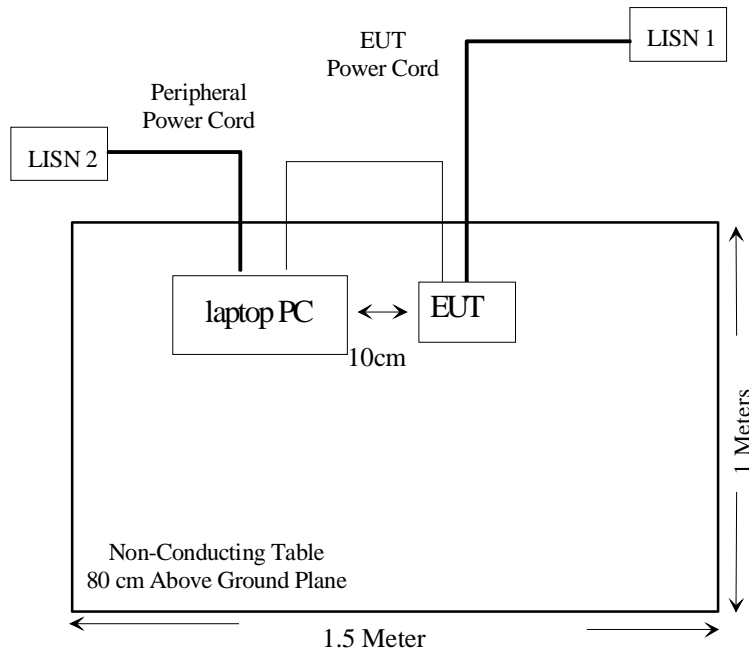

## SUMMARY OF TEST RESULTS

Results reported relate only to the product tested.

FCC RULES	DESCRIPTION OF TEST	RESULT
§2.1091	RF Exposure	Pass
§15.203	Antenna Requirement	Pass
§15.205	Restricted Band	Pass
§ 15.207 (a)	Conducted Emissions	Pass
§2.1051	Spurious Emission at Antenna Port	Pass
§15.209 (a)	Radiated Emission	Pass*
§15.247 (a)(2)	6 dB Bandwidth	Pass
§15.247 (b)(3)	Maximum Peak Output Power	Pass
§ 15.247 (d)	100 kHz Bandwidth of Frequency Band Edge	Pass
§15.247 (e)	Peak Power Spectral Density	Pass

\*: Test data are within the measurement uncertainty.



---

## **§15.203 - ANTENNA REQUIREMENT**

---

### **Standard Applicable**

According to § 15.203, an intentional radiator shall be designed to ensure that no antenna other than that furnished by the responsible party shall be used with the device.

And according to § 15.247 (b) (4), if transmitting antennas of directional gain greater than 6 dBi are used the power shall be reduced by the amount in dB that the directional gain of the antenna exceeds 6 dBi.

The antenna for this device is an integral antenna with gain of 3.3dBi.

## §15.207(a) - CONDUCTED EMISSIONS

### Measurement Uncertainty

All measurements involve certain levels of uncertainties. The factors contributing to uncertainties are spectrum analyzer, cable loss, and LISN.

Based on NIS 81, The Treatment of Uncertainty in EMC Measurements, the best estimate of the uncertainty of any conducted emissions measurement at BACL is  $\pm 2.4$  dB.

### EUT Setup

The measurement was performed in the shield room, using the same setup per ANSI C63.4-2003 measurement procedure. The specification used was FCC 15 Subpart B limits.

The spacing between the peripherals was 10 centimeters.

External I/O cables were draped along the edge of the test table and bundle when necessary.

### Spectrum Analyzer Setup

The EMI test receiver was set to investigate the spectrum from 150 kHz to 30Mhz.

### Test Equipment List and Details

Manufacturer	Description	Model	Serial Number	Cal. Date
Rohde & Schwarz	LISN	ESH2-Z5	871884/039	2004-08-16
Rohde & Schwarz	EMI Test Receiver	ESCS30	100176	2004-09-15
Fluke	Calibrated Voltmeter	189	18485-38	2004-07-18

\* **Statement of Traceability:** BACL attests that all calibrations have been performed per the NVLAP requirements, traceable to NIST.

### Test Procedure

During the conducted emission test, the power cord of the host system was connected to the auxiliary outlet of the first LISN.

Maximizing procedure was performed on the six (6) highest emissions of each modes tested to ensure EUT is compliant with all installation combination.

All data was recorded in the peak detection mode. Quasi-peak readings were only performed when an emission was found to be marginal (within  $-4$  dB $\mu$ V of specification limits). Quasi-peak readings are distinguished with a "Qp".

## Summary of Test Results

According to the recorded data in following table, the EUT complies with the FCC Conducted margin for a Class B device, with the *worst* margin reading of:

-3.8 dB at 24.900 MHz in the Neutral mode

## Environmental Conditions

Temperature:	22° C
Relative Humidity:	59%
ATM Pressure:	1023 mbar

*The testing was performed by Snell Leong on 2005-05-23.*

## Conducted Emissions Test Data

Frequency MHz	LINE CONDUCTED EMISSIONS			FCC PART 15 CLASS B	
	Amplitude dB $\mu$ V	Detector Qp/Ave/Peak	Phase Line/Neutral	Limit dB $\mu$ V	Margin dB
24.900	46.2	Ave	Neutral	50.00	-3.8
1.430	41.6	Ave	Neutral	46.00	-4.4
0.615	39.3	Ave	Neutral	46.00	-6.7
1.430	48.6	QP	Neutral	56.00	-7.4
0.615	48.2	QP	Neutral	56.00	-7.8
0.205	44.5	Ave	Neutral	53.41	-8.9
0.210	54.2	QP	Line	63.21	-9.0
0.210	43.2	Ave	Line	53.21	-10.0
1.480	36.0	Ave	Line	46.00	-10.0
0.205	52.9	QP	Neutral	63.41	-10.5
24.900	48.7	QP	Neutral	60.00	-11.3
1.480	43.0	QP	Line	56.00	-13.0
26.000	37.0	Ave	Line	50.00	-13.0
26.000	45.7	QP	Line	60.00	-14.3
0.320	45.0	QP	Line	59.71	-14.7
0.320	33.9	Ave	Line	49.71	-15.8

## Plot of Conducted Emissions Test Data

Plot(s) of Conducted Emissions Test Data is presented hereinafter as reference.

Bay Area Compliance Laboratory Corp  
Class B

23. May 05 09:54

23/May/05  
Snell

EUT: 2.4GHz AP  
Manuf: Video54  
Op Cond: Normal  
Operator: SNELL  
Comment: N  
120VAC

Scan Settings (3 Ranges)			Receiver Settings				
Start	Stop	Step	IF BW	Detector	M-Time	Atten	Preset
150k	1M	5k	9k	QP+AV	20ms	15dB LN	OFF
1M	5M	10k	9k	QP+AV	1ms	15dB LN	OFF
5M	30M	100k	9k	QP+AV	1ms	15dB LN	OFF

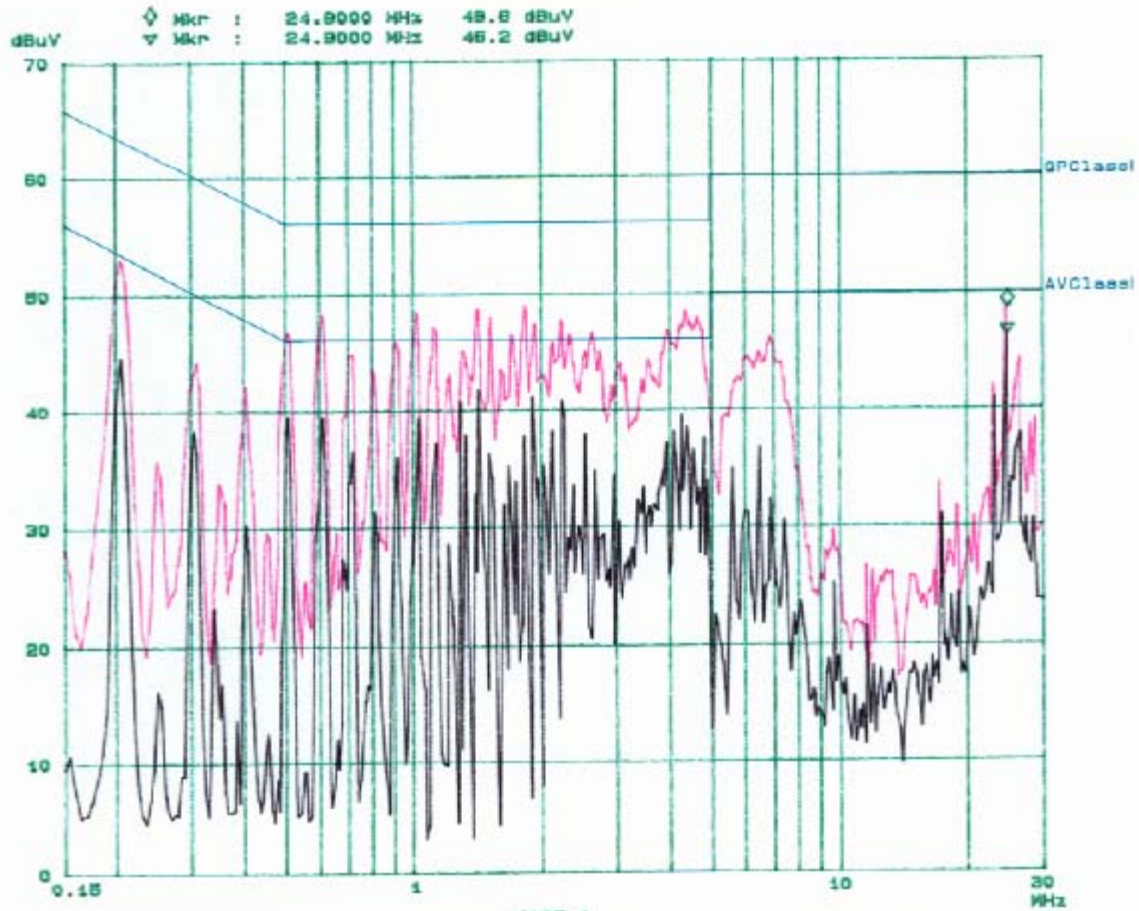

# Bay Area Compliance Laboratory Corp Class B

23. May 05 09:31

*23/May/05  
Snell*

EUT: 2.4GHz AP  
Manuf: Video54  
Op Cond: Normal  
Operator: SNELL  
Comment: L  
120VAC

### Scan Settings (3 Ranges)

Frequencies			Receiver Settings				
Start	Stop	Step	IF BW	Detector	M-Time	Atten	Preamp
150k	1M	5k	9k	QP+AV	20ms	15dB LN	OFF
1M	5M	10k	9k	QP+AV	1ms	15dB LN	OFF
5M	30M	100k	9k	QP+AV	1ms	15dB LN	OFF

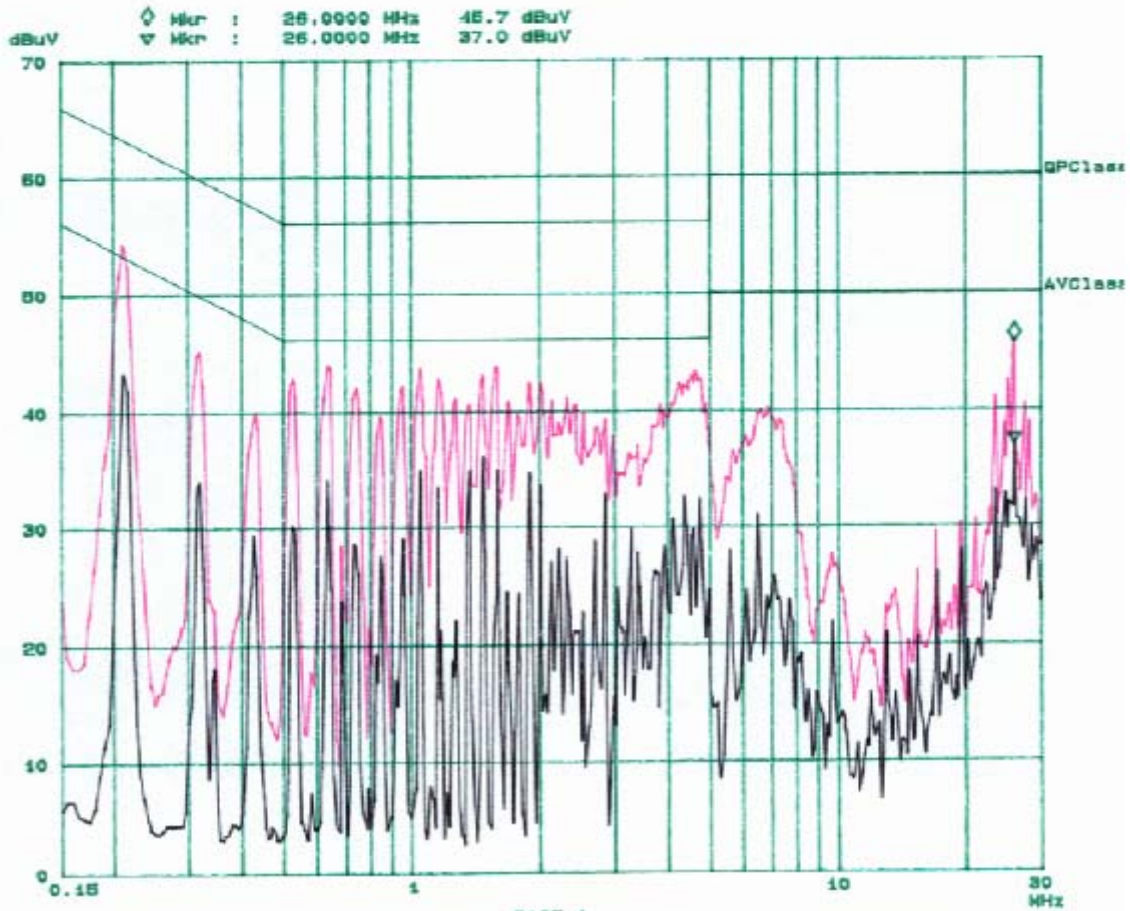

## §2.1051 - SPURIOUS EMISSIONS AT ANTENNA TERMINALS

### Standard Applicable

Requirements: CFR 47, § 2.1051.

The spectrum was to be investigated to the tenth harmonics of the highest fundamental frequency as specified in § 2.1057.

### Measurement Procedure

The RF output of the EUT was connected to a spectrum analyzer through appropriate attenuation. The resolution bandwidth of the spectrum analyzer was set at 100 kHz. Sufficient scans were taken to show any out of band emissions up to 10<sup>th</sup> harmonic.

### Equipment Lists

Manufacturer	Description	Model	Serial Number	Cal. Date
Agilent	Analyzer, Spectrum	E4446A	US44300386	11/10/2004

\* **Statement of Traceability: BAEL Corp.** attests that all calibrations have been performed per the NVLAP requirements, traceable to the NIST.

### Measurement Result

Please refer to following pages for plots of spurious emission.

#### Environmental Conditions

Temperature:	22° C
Relative Humidity:	59%
ATM Pressure:	1023 mbar

*The testing was performed by Snell Leong on 2005-05-23.*

802.11b

Low Channel

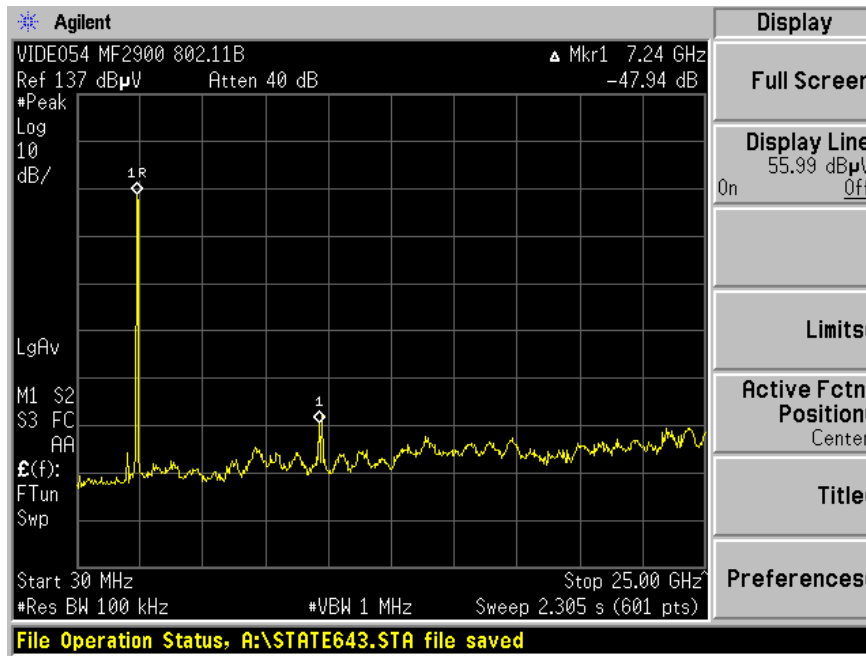

Mid Channel

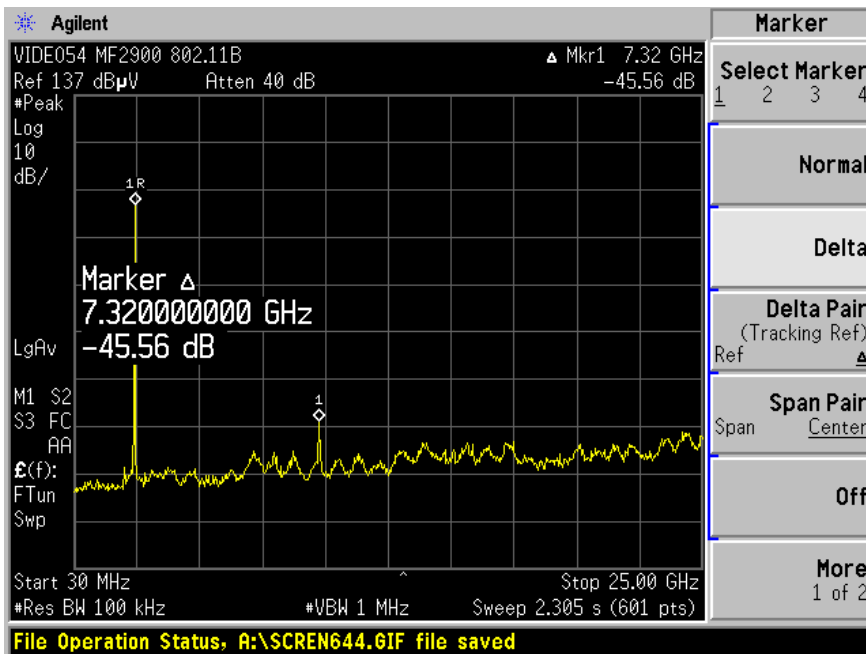

High Channel

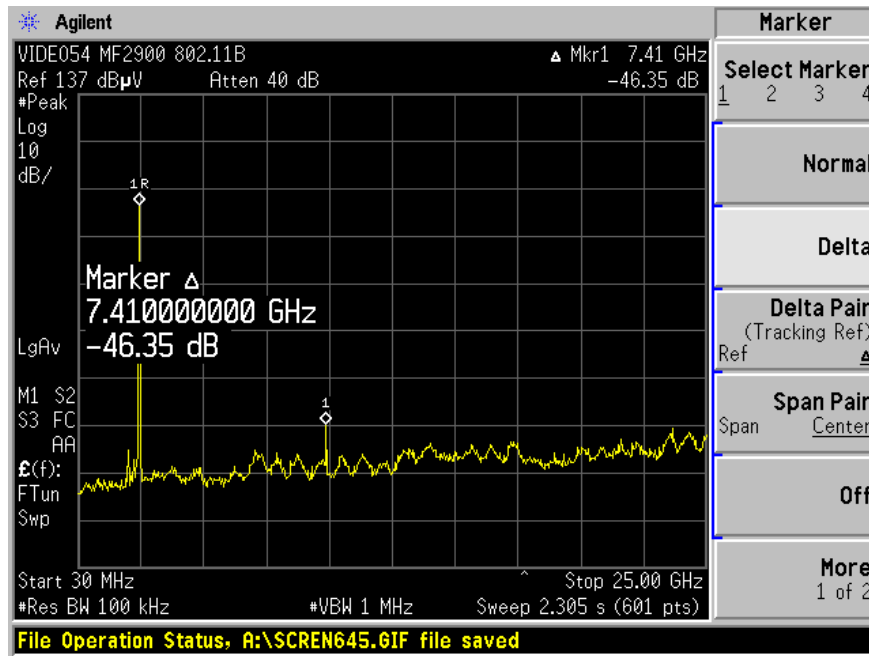

802.11g

Low Channel

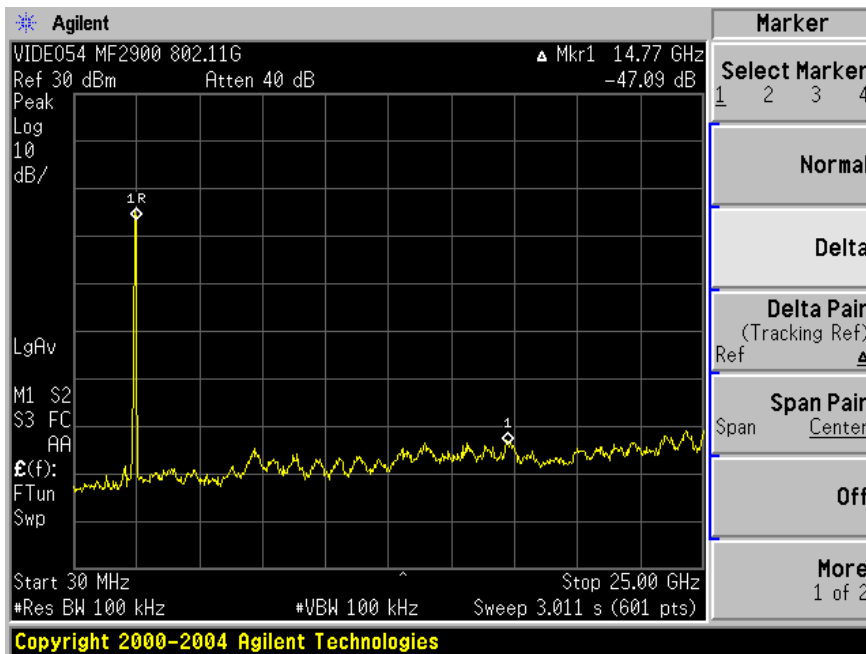



Mid Channel

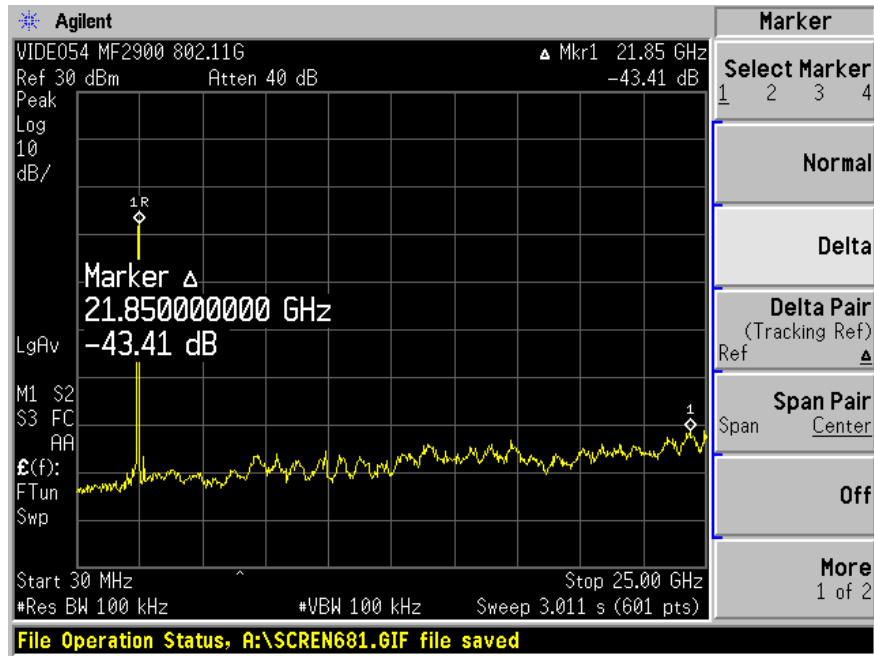

High Channel

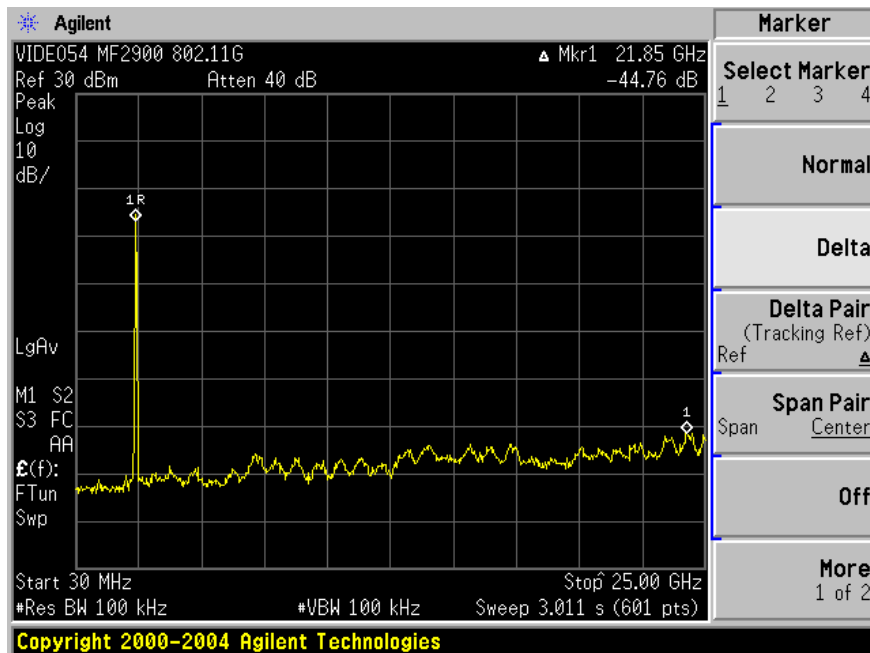

## §15.205 & §15.209 - SPURIOUS RADIATED EMISSION

### Measurement Uncertainty

All measurements involve certain levels of uncertainties. The factors contributing to uncertainties are spectrum analyzer, cable loss, antenna factor calibration, antenna directivity, antenna factor variation with height, antenna phase center variation, antenna factor frequency interpolation, measurement distance variation, site imperfections, mismatch (average), and system repeatability.

Based on NIS 81, The Treatment of Uncertainty in EMC Measurements, the best estimate of the uncertainty of a radiation emissions measurement at BAEL is  $\pm 4.0$  dB.

According to §15.205, except as shown in paragraph (d) of this section, only spurious emissions are permitted in any of the frequency bands listed below:

MHz	MHz	MHz	GHz
0.090 – 0.110	16.42 – 16.423	399.9 – 410	4.5 – 5.15
<sup>1</sup> 0.495 – 0.505	16.69475 – 16.69525	608 – 614	5.35 – 5.46
2.1735 – 2.1905	16.80425 – 16.80475	960 – 1240	7.25 – 7.75
4.125 – 4.128	25.5 – 25.67	1300 – 1427	8.025 – 8.5
4.17725 – 4.17775	37.5 – 38.25	1435 – 1626.5	9.0 – 9.2
4.20725 – 4.20775	73 – 74.6	1645.5 – 1646.5	9.3 – 9.5
6.215 – 6.218	74.8 – 75.2	1660 – 1710	10.6 – 12.7
6.26775 – 6.26825	108 – 121.94	1718.8 – 1722.2	13.25 – 13.4
6.31175 – 6.31225	123 – 138	2200 – 2300	14.47 – 14.5
8.291 – 8.294	149.9 – 150.05	2310 – 2390	15.35 – 16.2
8.362 – 8.366	156.52475 – 156.52525	2483.5 – 2500	17.7 – 21.4
8.37625 – 8.38675	156.7 – 156.9	2655 – 2900	22.01 – 23.12
8.41425 – 8.41475	162.0125 – 167.17	3260 – 3267	23.6 – 24.0
12.29 – 12.293	167.72 – 173.2	3332 – 3339	31.2 – 31.8
12.51975 – 12.57725	240 – 285	3345.8 – 3358	36.43 – 36.5
13.36 – 13.41	322 – 335.4	3600 – 4400	( <sup>2</sup> )

<sup>1</sup> Until February 1, 1999, this restricted band shall be 0.490-0.510MHz

<sup>2</sup> Above 38.6

Except as provided in paragraph (d) and (e), the filed strength of emissions appearing within these frequency bands shall not exceed the limits shown in Section 15.209. At frequencies equal to or less than 1000MHz, compliance with the limits in Section 15.209 shall be demonstrated using measurement instrumentation employing a CISPR quasi-peak detector. Above 1000MHz, compliance with the emission limits in Section 15.209 shall be demonstrated based on the average value of the measured emissions. The provisions in Section 15.35 apply to these measurements.

According to §15.209, the device shall meet radiated emission general requirements.

Except for Class A device, the filed strength of radiated emissions from unintentional radiators at a distance of 3 meters shall not exceed the following values:

Frequency of Emission (MHz)	Field Strength	
	(Microvolts/meter)	(dB $\mu$ V/meter)
30 - 88	100	40
88 - 216	150	43.5
216 - 960	200	46
Above 960	500	54

### EUT Setup

The radiated emission tests were performed in the open area 3-meter test site, using the setup accordance with the ANSI C63.4-2003. The specification used was the FCC 15.209 limits.

The spacing between the peripherals was 10 centimeters.

External I/O cables were draped along the edge of the test table and bundle when necessary.

The EUT was connected to the power adapter which is connected with 120Vac/60Hz power source.

### Spectrum Analyzer Setup

According to FCC Rules, 47 CFR, Section 15.33, the frequency was investigated from 30 to 25000 MHz.

During the radiated emission test, the spectrum analyzer was set with the following configurations:

<u>Frequency Range</u>	<u>RBW</u>	<u>Video B/W</u>
Below 30MHz	10kHz	10kHz
30 – 1000MHz	100kHz	100kHz
Above 1000MHz	1MHz	1MHz

For Average measurement: RBW = 1MHz, VBW = 10Hz (above 1000MHz)

### Test Equipment List and Details

Manufacturer	Description	Model	Serial Number	Cal. Date
EMCO	Antenna, Biconical	3110B	9603-2315	12/14/2004
HP	Amplifier, Pre (.1 ~1300MHz)	8447D	2944A10198	8/20/2004
Agilent	Analyzer, Spectrum	E4446A	US44300386	11/10/2004
EMCO	Antenna, Log-Periodic	3148	4-1155	12/14/2004
HP	Pre, Amplifier (1 ~ 26.5 GHz)	8449B	3147A00400	03/14/2005
Wisewave	Antenna, Horn, Std	ARH-2823-02	10555-02	12/13/2004

\* **Statement of Traceability:** BACL attests that all calibrations have been performed per the NVLAP requirements, traceable to NIST.

## Test Procedure

For the radiated emissions test, the EUT, and all support equipment power cords was connected to the AC floor outlet.

Maximizing procedure was performed on the highest emissions to ensure that the EUT complied with all installation combinations.

All data was recorded in the peak detection mode. Quasi-peak readings performed only when an emission was found to be marginal (within -4 dB $\mu$ V of specification limits), and are distinguished with a "Qp" in the data table.

## Corrected Amplitude & Margin Calculation

The Corrected Amplitude is calculated by adding the Antenna Factor and Cable Factor, and subtracting the Amplifier Gain from the Amplitude reading. The basic equation is as follows:

$$\text{Corr. Ampl.} = \text{Indicated Reading} + \text{Antenna Factor} + \text{Cable Factor} - \text{Amplifier Gain}$$

The "**Margin**" column of the following data tables indicates the degree of compliance with the applicable limit. For example, a margin of -7dB means the emission is 7dB below the maximum limit for Class B. The equation for margin calculation is as follows:

$$\text{Margin} = \text{Corr. Ampl.} - \text{FCC 15.209 Limit}$$

## Environmental Conditions

Temperature:	22° C
Relative Humidity:	59%
ATM Pressure:	1023 mbar

*The testing was performed by Snell Leong on 2005-05-23.*

## Summary of Test Results

According to the data hereinafter, the EUT test data are within the measurement uncertainty  $\pm 4.0$  dB, and had the worst margin of:

802.11b:

- 5.0 dB at 7236.00 MHz in the Vertical polarization, Low Channel**
- 1.7 dB at 7326.00 MHz in the Vertical polarization, Middle Channel**
- 0.6 dB at 7386.00 MHz in the Vertical polarization, High Channel**
- 7.0 dB at 276.00 MHz in the Horizontal polarization, Unintentional Emission**

802.11g:

- 3.7 dB at 7236.00 MHz in the Vertical polarization, Low Channel**
- 1.5 dB at 7326.00 MHz in the Vertical polarization, Middle Channel**
- 1.5 dB at 7386.00 MHz in the Vertical polarization, High Channel**
- 7.0 dB at 276.00 MHz in the Horizontal polarization, Unintentional Emission**

**Radiated Emission Test Result for 802.11b**

INDICATED			TABLE	ANTENNA		CORRECTION FACTOR			CORRECTED AMPLITUDE	FCC 15 SUBPART C	
Frequency MHz	Ampl. dBμV/m	Comments	Angle Degree	Height Meter	Polar H/V	Antenna dB	Cable dB	Amp. dB	Corr. Ampl. dBμV/m	Limit dBμV/m	Margin dB
<b>Low Channel, 1-25GHz</b>											
7236.0000	42.6	Ave	180	2.0	v	36.7	4.3	34.7	49.0	54	-5.0
7236.0000	36.7	Ave	90	2.0	h	36.7	4.3	34.7	43.1	54	-10.9
4824.0000	41.2	Ave	270	2.4	v	32.5	3.1	34.8	42.0	54	-12.0
4824.0000	39.5	Ave	180	2.3	h	32.5	3.1	34.8	40.3	54	-13.7
4824.0000	56.0	Peak	180	2.3	h	32.5	3.1	34.8	56.8	74	-17.3
7236.0000	49.2	Peak	90	2.0	v	36.7	4.3	34.7	55.6	74	-18.4
4824.0000	54.1	Peak	270	2.4	v	32.5	3.1	34.8	54.9	74	-19.1
7236.0000	46.4	Peak	180	2.0	h	36.7	4.3	34.7	52.7	74	-21.3
<b>Middle Channel, 1-25GHz</b>											
7326.0000	46.0	Ave	270	2.4	v	36.7	4.3	34.7	52.3	54	-1.7
4884.0000	44.8	Ave	180	2.2	h	32.5	3.1	34.8	45.6	54	-8.4
7326.0000	39.0	Ave	180	2.1	h	36.7	4.3	34.7	45.3	54	-8.7
4884.0000	63.0	Peak	180	2.2	h	32.5	3.1	34.8	63.8	74	-10.2
4884.0000	41.9	Ave	270	2.4	v	32.5	3.1	34.8	42.7	54	-11.4
4884.0000	59.9	Peak	270	2.4	v	32.5	3.1	34.8	60.7	74	-13.3
7326.0000	50.0	Peak	270	2.4	v	36.7	4.3	34.7	56.4	74	-17.6
7326.0000	48.9	Peak	180	2.3	h	36.7	4.3	34.7	55.2	74	-18.8
<b>High Channel, 1-25GHz</b>											
7386.0000	47.0	Ave	270	2.4	v	36.7	4.3	34.7	53.4	54	-0.6
7386.0000	40.2	Ave	90	2.1	h	36.7	4.3	34.7	46.5	54	-7.5
4924.0000	42.8	Ave	90	2.1	h	32.5	3.1	34.8	43.6	54	-10.4
4924.0000	41.4	Ave	270	2.4	v	32.5	3.1	34.8	42.2	54	-11.8
4924.0000	59.9	Peak	90	2.1	h	32.5	3.1	34.8	60.7	74	-13.3
7386.0000	53.0	Peak	270	2.4	v	36.7	4.3	34.7	59.3	74	-14.7
4924.0000	57.6	Peak	270	2.4	v	32.5	3.1	34.8	58.4	74	-15.6
7386.0000	46.2	Peak	90	2.1	h	36.7	4.3	34.7	52.6	74	-21.4

*30MHz – 1GHz*

Frequency MHz	Indicated		Table Height Meter	Antenna		Correction Factor			FCC 15 Subpart B	
	Ampl. dB $\mu$ V/m	Direction Degree		Polar H/V	Antenna dB	Cable Loss dB	Amp. dB	Corr. Ampl. dB $\mu$ V/m	Limit dB $\mu$ V/m	Margin dB
276.00	49.5	280	2.8	H	13.4	3.5	27.4	39.0	46	-7.0
920.00	36.7	240	3.1	H	22.1	6.9	27.3	38.4	46	-7.6
920.00	34.9	330	3.0	V	22.1	6.9	27.3	36.6	46	-9.4
276.00	46.8	250	1.0	V	13.4	3.5	27.4	36.3	46	-9.7
460.00	42.9	240	3.1	H	17.2	4.7	28.5	36.3	46	-9.7
184.00	45.3	330	1.2	V	11.6	2.8	27.8	31.9	43.5	-11.6
250.00	46.2	270	3.2	H	11.9	3.4	27.4	34.1	46	-11.9
250.00	45.9	75	1.8	V	11.9	3.4	27.4	33.8	46	-12.2
368.00	40.2	240	3.1	H	14.8	4.1	27.8	31.3	46	-14.7
184.00	41.2	270	2.1	H	11.6	2.8	27.8	27.8	43.5	-15.8
460.00	36.8	270	1.0	V	17.2	4.7	28.5	30.2	46	-15.8
350.00	38.7	280	2.8	H	14.5	4.2	27.7	29.7	46	-16.3
368.00	36.0	270	1.0	V	14.8	4.1	27.8	27.1	46	-19.0
350.00	33.0	250	1.0	V	14.5	4.2	27.7	24.0	46	-22.0

FUND = Fundamental

AVG = average

**Radiated Emission Test Result for 802.11g**

INDICATED			TABLE	ANTENNA		CORRECTION FACTOR			CORRECTED AMPLITUDE	FCC 15 SUBPART C	
Frequency	Ampl.	Comments	Angle	Height	Polar	Antenna	Cable	Amp.	Corr. Ampl.	Limit	Margin
MHz	dB $\mu$ V/m		Degree	Meter	H/V	dB	dB	dB	dB $\mu$ V/m	dB $\mu$ V/m	dB
<b>Low Channel, 1-25GHz</b>											
7236.0000	43.9	Ave	180	2.0	v	36.7	4.3	34.7	50.3	54	-3.7
7236.0000	37.8	Ave	90	2.0	h	36.7	4.3	34.7	44.2	54	-9.8
4824.0000	42.4	Ave	270	2.4	v	32.5	3.1	34.8	43.2	54	-10.8
4824.0000	40.7	Ave	180	2.3	h	32.5	3.1	34.8	41.5	54	-12.5
4824.0000	57.6	Peak	180	2.3	h	32.5	3.1	34.8	58.4	74	-15.6
7236.0000	50.7	Peak	90	2.0	v	36.7	4.3	34.7	57.1	74	-16.9
4824.0000	55.8	Peak	270	2.4	v	32.5	3.1	34.8	56.6	74	-17.4
7236.0000	47.8	Peak	180	2.0	h	36.7	4.3	34.7	54.1	74	-19.9
<b>Middle Channel, 1-25GHz</b>											
7326.0000	46.2	Ave	270	2.4	v	36.7	4.3	34.7	52.5	54	-1.5
4884.0000	45.7	Ave	180	2.2	h	32.5	3.1	34.8	46.5	54	-7.5
7326.0000	39.7	Ave	180	2.1	h	36.7	4.3	34.7	46.1	54	-7.9
4884.0000	64.2	Peak	180	2.2	h	32.5	3.1	34.8	65.0	74	-9.0
4884.0000	42.7	Ave	270	2.4	v	32.5	3.1	34.8	43.5	54	-10.5
4884.0000	61.1	Peak	270	2.4	v	32.5	3.1	34.8	61.9	74	-12.1
7326.0000	51.0	Peak	270	2.4	v	36.7	4.3	34.7	57.4	74	-16.6
7326.0000	49.9	Peak	180	2.3	h	36.7	4.3	34.7	56.2	74	-17.8
<b>High Channel, 1-25GHz</b>											
7386.0000	46.2	Ave	270	2.4	v	36.7	4.3	34.7	52.5	54	-1.5
7386.0000	41.0	Ave	90	2.1	h	36.7	4.3	34.7	47.3	54	-6.7
4924.0000	43.7	Ave	90	2.1	h	32.5	3.1	34.8	44.5	54	-9.5
4924.0000	42.3	Ave	270	2.4	v	32.5	3.1	34.8	43.1	54	-10.9
4924.0000	61.1	Peak	90	2.1	h	32.5	3.1	34.8	61.9	74	-12.1
7386.0000	54.0	Peak	270	2.4	v	36.7	4.3	34.7	60.4	74	-13.6
4924.0000	58.8	Peak	270	2.4	v	32.5	3.1	34.8	59.6	74	-14.4
7386.0000	47.1	Peak	90	2.1	h	36.7	4.3	34.7	53.5	74	-20.5



*30MHz – 1GHz*

Frequency MHz	Indicated		Table Height Meter	Antenna		Correction Factor			FCC 15 Subpart B	
	Ampl. dB $\mu$ V/m	Direction Degree		Polar H/V	Antenna dB	Cable Loss dB	Amp. dB	Corr. Ampl. dB $\mu$ V/m	Limit dB $\mu$ V/m	Margin dB
276.00	49.0	280	2.8	H	13.4	3.5	27.4	39.0	46	-7.0
920.00	36.3	240	3.1	H	22.1	6.9	27.3	38.4	46	-7.6
920.00	34.5	330	3.0	V	22.1	6.9	27.3	36.6	46	-9.4
276.00	46.3	250	1.0	V	13.4	3.5	27.4	36.3	46	-9.7
460.00	42.5	240	3.1	H	17.2	4.7	28.5	36.3	46	-9.7
184.00	44.9	330	1.2	V	11.6	2.8	27.8	31.9	43.5	-11.6
250.00	45.8	270	3.2	H	11.9	3.4	27.4	34.1	46	-11.9
250.00	45.4	75	1.8	V	11.9	3.4	27.4	33.8	46	-12.2
368.00	39.8	240	3.1	H	14.8	4.1	27.8	31.3	46	-14.7
184.00	40.7	270	2.1	H	11.6	2.8	27.8	27.8	43.5	-15.8
460.00	36.5	270	1.0	V	17.2	4.7	28.5	30.2	46	-15.8
350.00	38.4	280	2.8	H	14.5	4.2	27.7	29.7	46	-16.3
368.00	35.6	270	1.0	V	14.8	4.1	27.8	27.1	46	-19.0
350.00	32.7	250	1.0	V	14.5	4.2	27.7	24.0	46	-22.0

FUND = Fundamental

AVG = average

## §15.247(a)(2) – 6 dB BANDWIDTH

### Standard Applicable

According to §15.247(a)(2), for digital modulation techniques, the minimum 6dB bandwidth shall be at least 500 kHz.

### Measurement Procedure

1. Check the calibration of the measuring instrument using either an internal calibrator or a known signal from an external generator.
2. Position the EUT without connection to measurement instrument. Turn on the EUT and connect it to measurement instrument. Then set it to any one convenient frequency within its operating range. Set a reference level on the measuring instrument equal to the highest peak value.
3. Measure the frequency difference of two frequencies that were attenuated 6 dB from the reference level. Record the frequency difference as the emission bandwidth. (6 dB bandwidth for DTS)
4. Repeat above procedures until all frequencies measured were complete.

### Equipment Lists

Manufacturer	Description	Model	Serial Number	Cal. Date
Agilent	Analyzer, Spectrum	E4446A	US44300386	11/10/2004

\* **Statement of Traceability: BACL Corp.** attests that all calibrations have been performed per the NVLAP requirements, traceable to the NIST.

**Measurement Result****Environmental Conditions**

Temperature:	22° C
Relative Humidity:	59%
ATM Pressure:	1023 mbar

*The testing was performed by Snell Leong on 2005-05-23.*

**Test Result**

## 802.11b

Channel	Frequency (MHz)	Measured (MHz)	Standard (kHz)	Result
Low	2412	12.17	≥ 500	Pass
Mid	2442	12.00	≥ 500	Pass
High	2462	12.33	≥ 500	Pass

## 802.11g

Channel	Frequency (MHz)	Measured (MHz)	Standard (kHz)	Result
Low	2412	16.67	≥ 500	Pass
Mid	2442	16.67	≥ 500	Pass
High	2462	16.42	≥ 500	Pass

802.11b

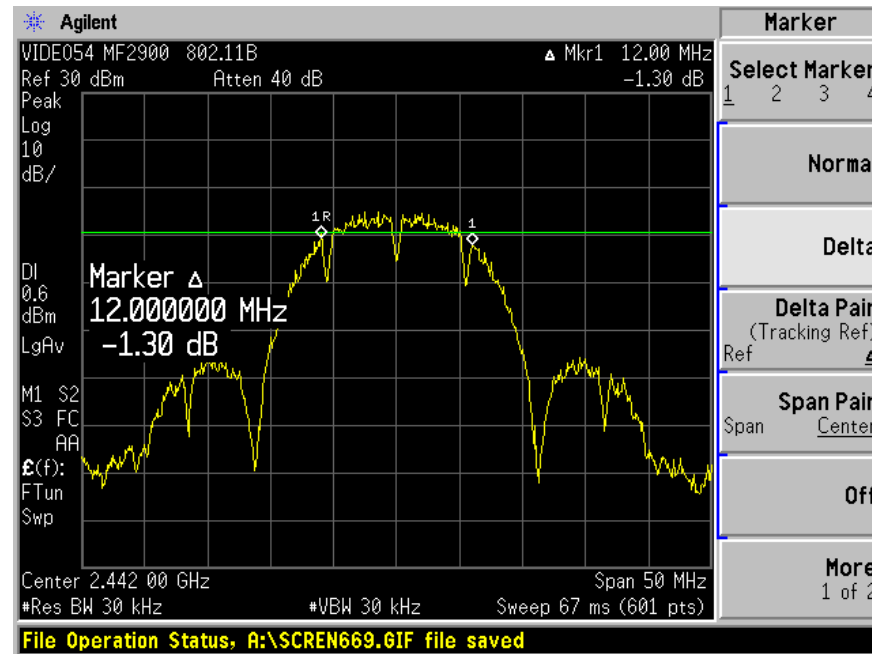
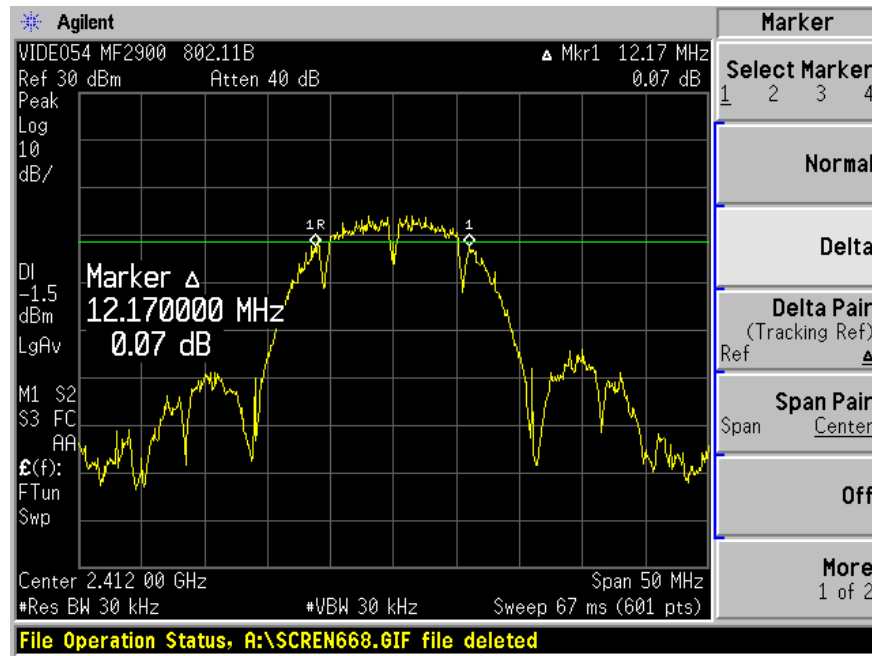

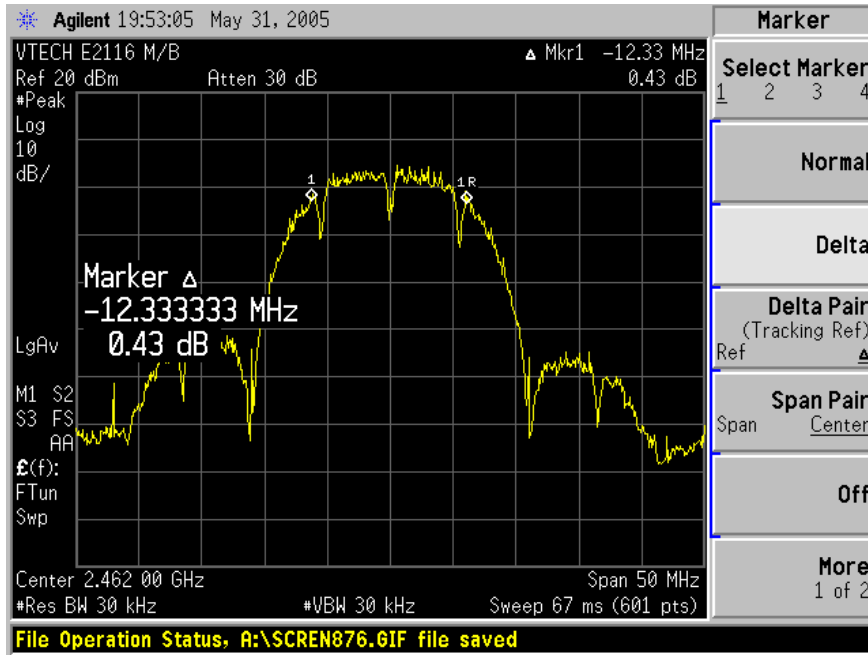

802.11g

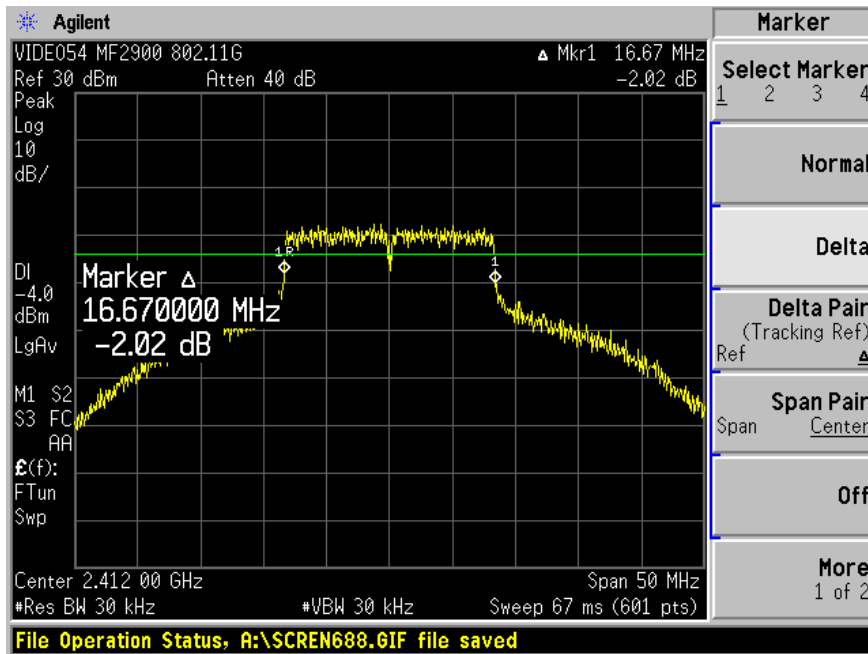

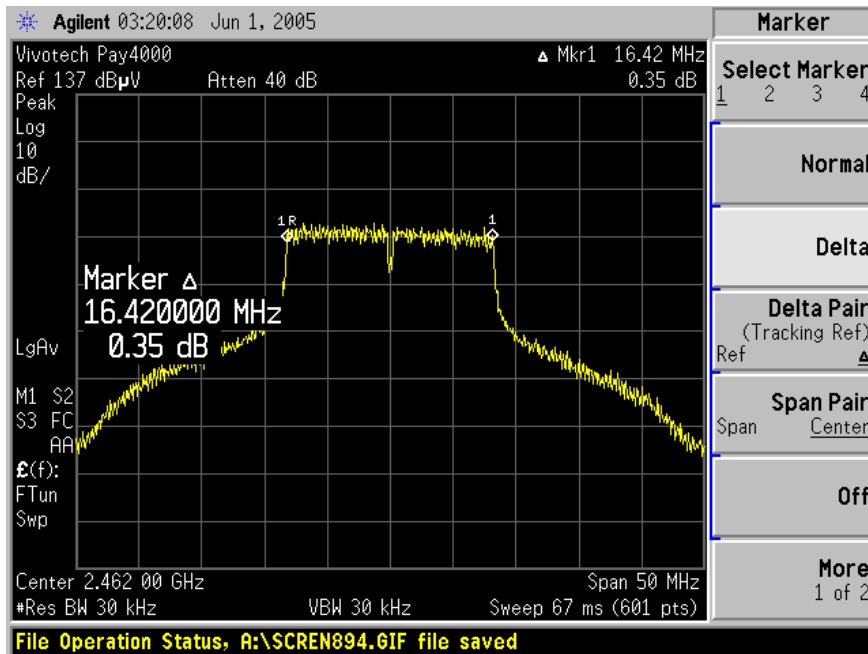
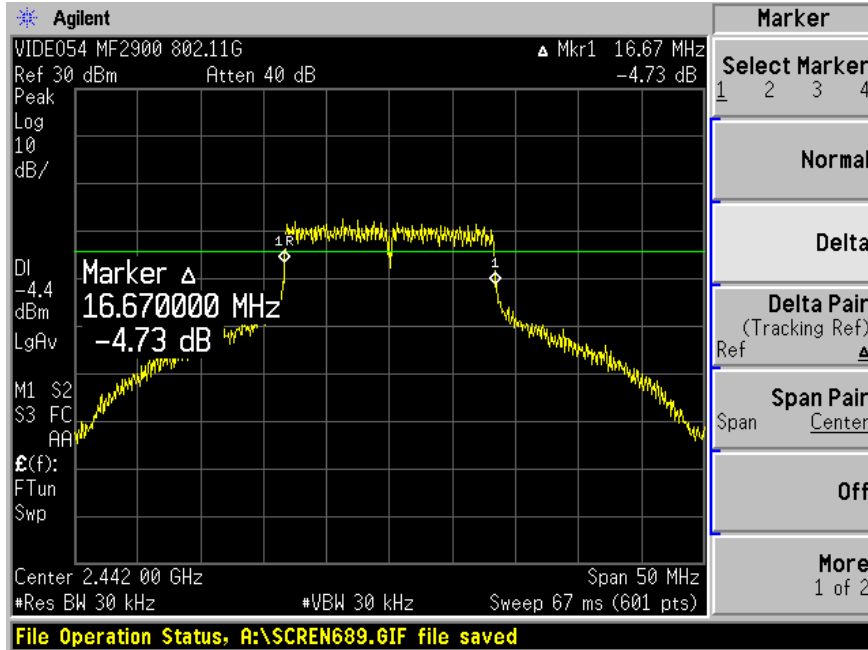

## §15.247(b)(3) - PEAK OUTPUT POWER MEASUREMENT

### Standard Applicable

According to §15.247(b) (3), for systems using digital modulation in 2400-2483.5 MHz: 1 Watt

### Measurement Procedure

1. Place the EUT on a bench and set it in transmitting mode.
2. Remove the antenna from the EUT and then connect a low loss RF cable from the antenna port to a spectrum analyzer.
3. Add a correction factor to the display.

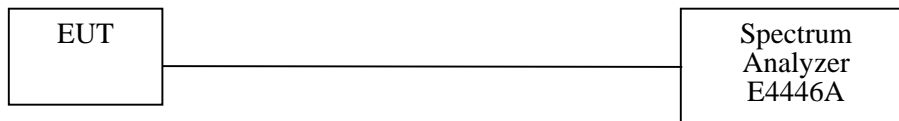

### Equipment Lists

Manufacturer	Description	Model	Serial Number	Cal. Date
Agilent	Analyzer, Spectrum	E4446A	US44300386	11/10/2004

\* **Statement of Traceability:** **BACL Corp.** attests that all calibrations have been performed per the NVLAP requirements, traceable to the NIST.

### Measurement Result

#### Environmental Conditions

Temperature:	22° C
Relative Humidity:	59%
ATM Pressure:	1023 mbar

*The testing was performed by Snell Leong on 2005-05-23.*

**Output Power**

## 802.11b

Channel	Frequency MHz	Max Peak Output Power		Limit (m Watt)	Result
		(dBm)	(m Watt)		
Low	2412	20.26	106.17	1000	pass
Mid	2442	20.73	118.30	1000	pass
High	2462	20.21	104.95	1000	pass

## 802.11g

Channel	Frequency MHz	Max Peak Output Power		Limit (m Watt)	Result
		(dBm)	(m Watt)		
Low	2412	20.97	125.03	1000	pass
Mid	2442	20.8	120.23	1000	pass
High	2462	21.01	126.18	1000	pass



802.11b

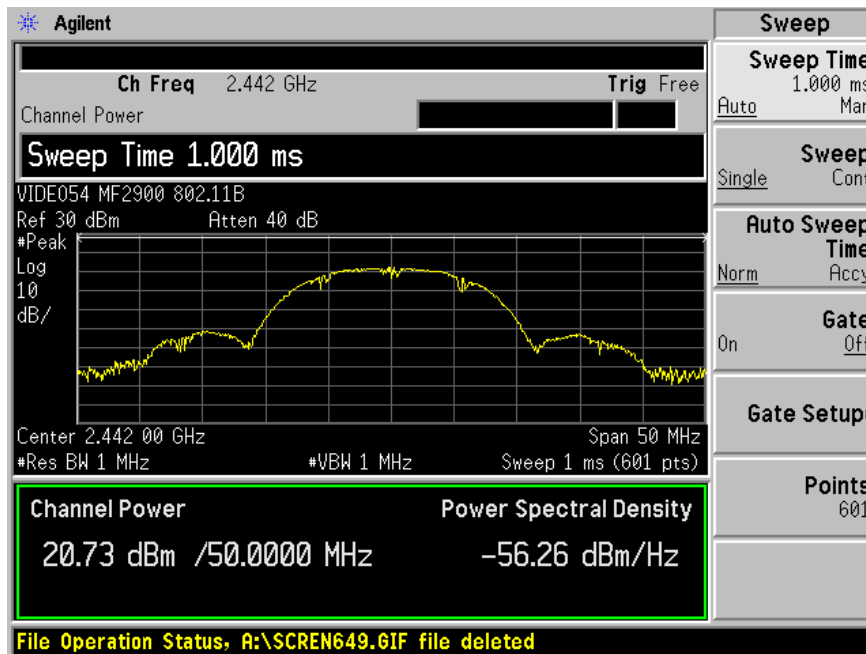
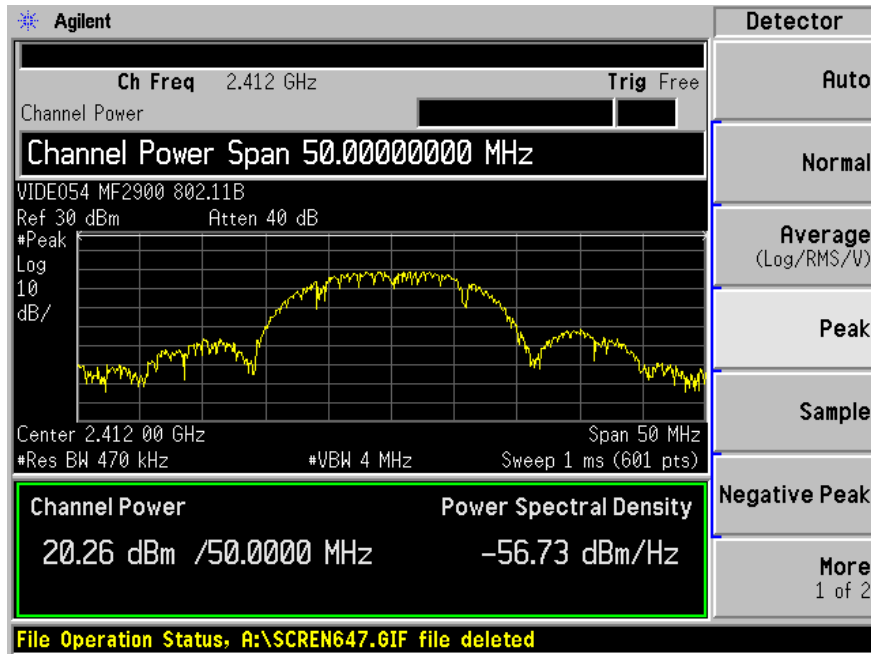

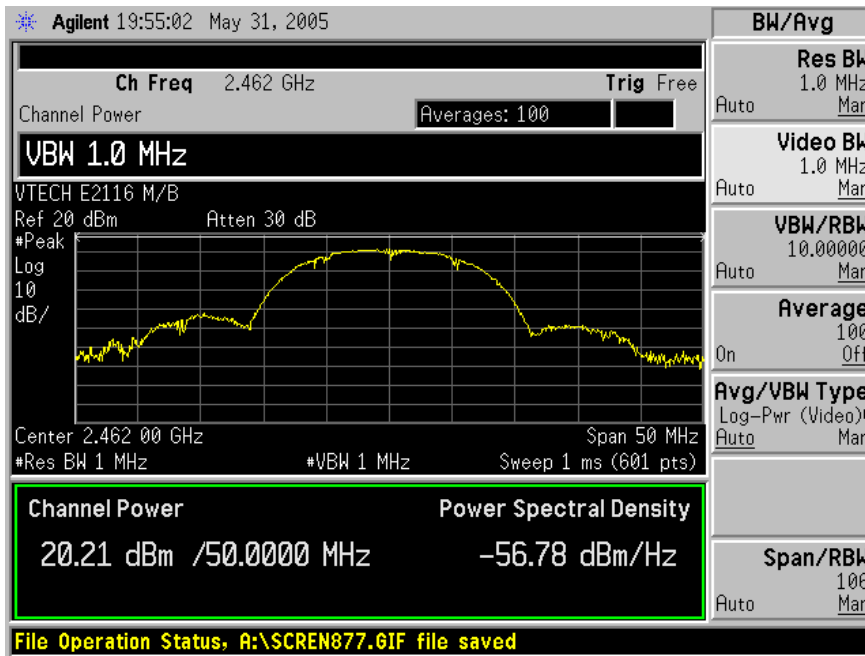

802.11g

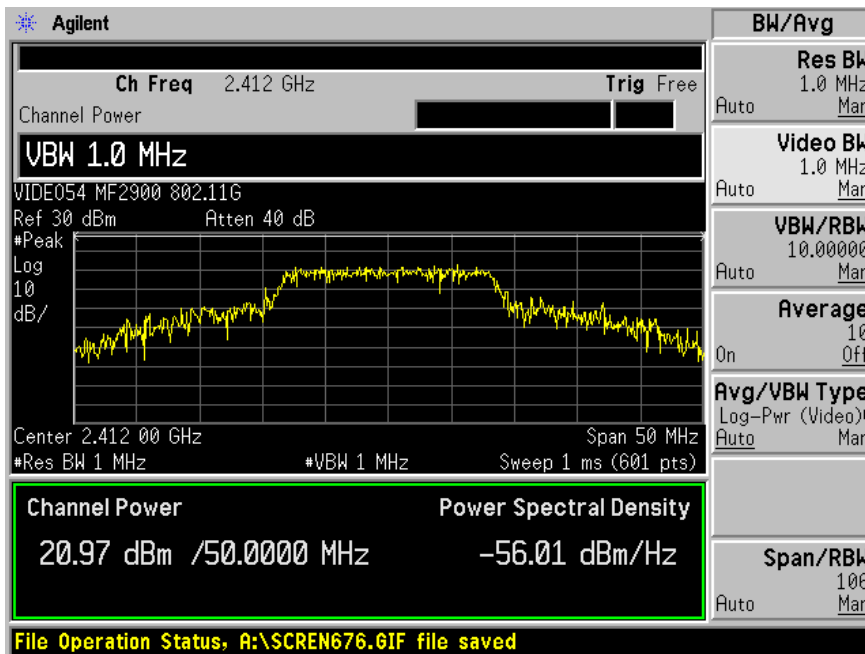

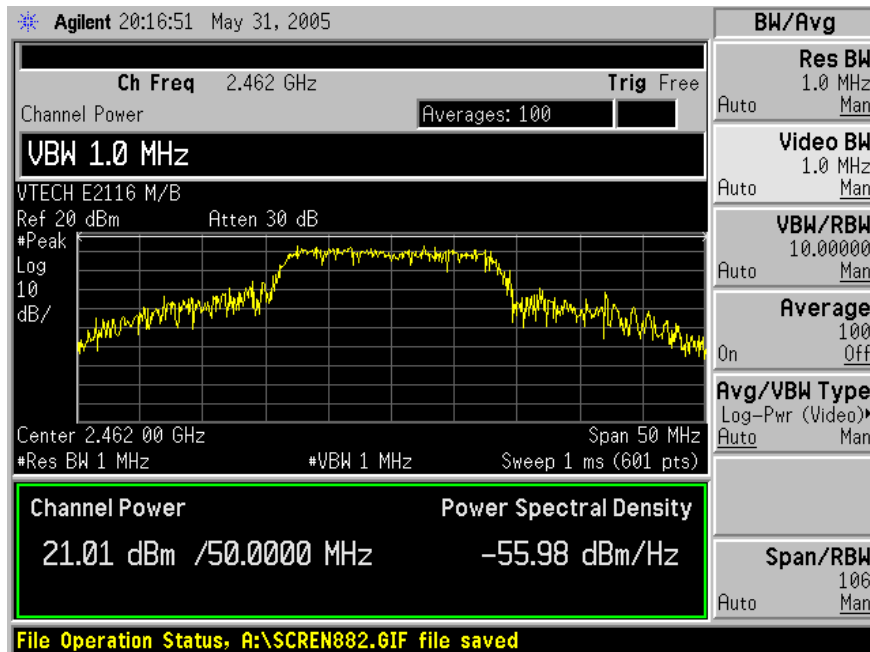
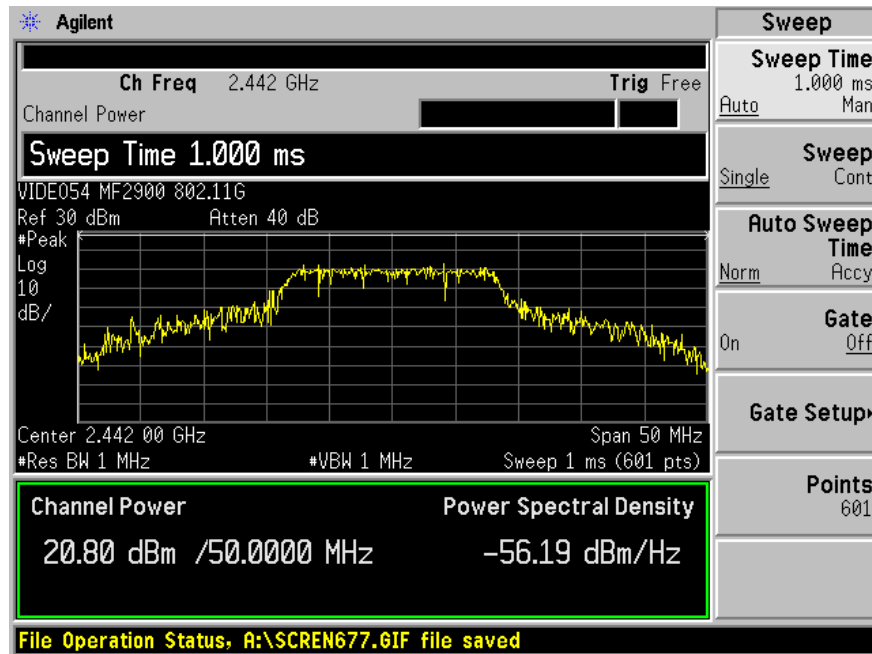

## **§15.247(d) - 100 KHZ BANDWIDTH OF BAND EDGES**

### **Standard Applicable**

According to §15.247(d), in *any* 100 kHz bandwidth outside the frequency bands in which the spread spectrum intentional radiator is operating, the radio frequency power that is produced by the intentional radiator shall be at least 20 dB below that in the 100 kHz bandwidth within the band that contains the highest level of the desired power, based on either an RF conducted or a radiated measurement. In addition, radiated emissions which fall in the restricted bands, as defined in §15.205(a), must also comply with the radiated emission limits specified in §15.209(a) see §15.205(c).

### **Measurement Procedure**

1. Check the calibration of the measuring instrument using either an internal calibrator or a known signal from an external generator.
2. Position the EUT without connection to measurement instrument. Turn on the EUT and connect its antenna terminal to measurement instrument via a low loss cable. Then set it to any one measured frequency within its operating range, and make sure the instrument is operated in its linear range.
3. Set both RBW and VBW of spectrum analyzer to 100 kHz with a convenient frequency span including 100kHz bandwidth from band edge.
4. Measure the highest amplitude appearing on spectral display and set it as a reference level. Plot the graph with marking the highest point and edge frequency.
5. Repeat above procedures until all measured frequencies were complete.

### **Equipment Lists**

<b>Manufacturer</b>	<b>Description</b>	<b>Model</b>	<b>Serial Number</b>	<b>Cal. Date</b>
Agilent	Analyzer, Spectrum	E4446A	US44300386	11/10/2004

\* **Statement of Traceability: BACL Corp.** attests that all calibrations have been performed per the NVLAP requirements, traceable to the NIST.

### **Measurement Result**

#### **Environmental Conditions**

Temperature:	22° C
Relative Humidity:	59%
ATM Pressure:	1023 mbar

*The testing was performed by Snell Leong on 2005-05-23.*

Please refer to following pages for plots of band edge.

802.11b

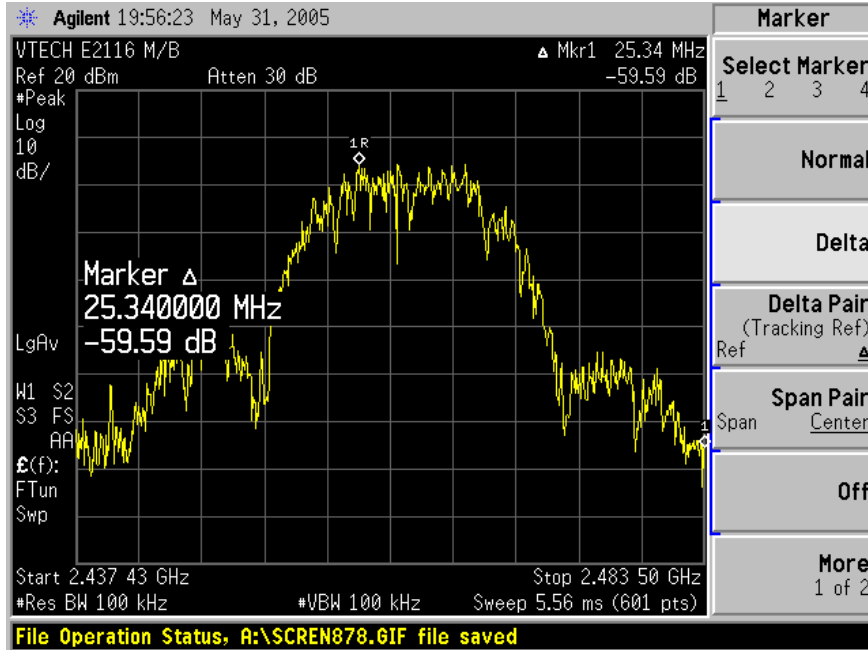
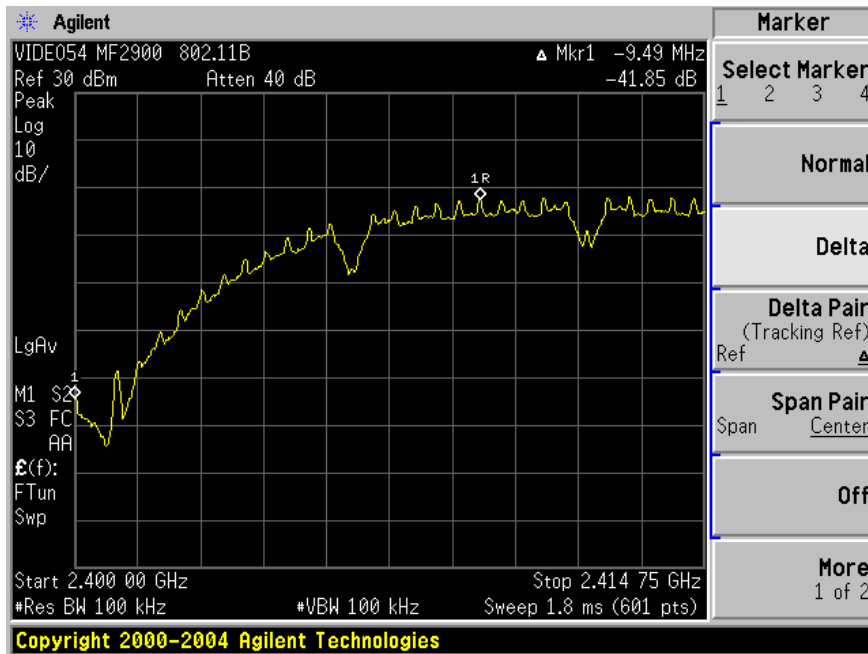

802.11g

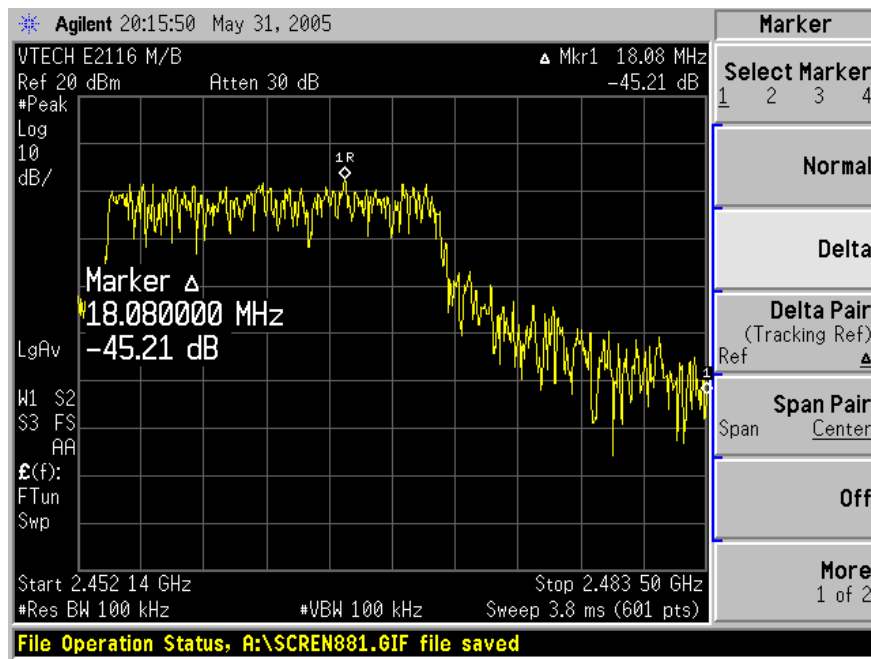
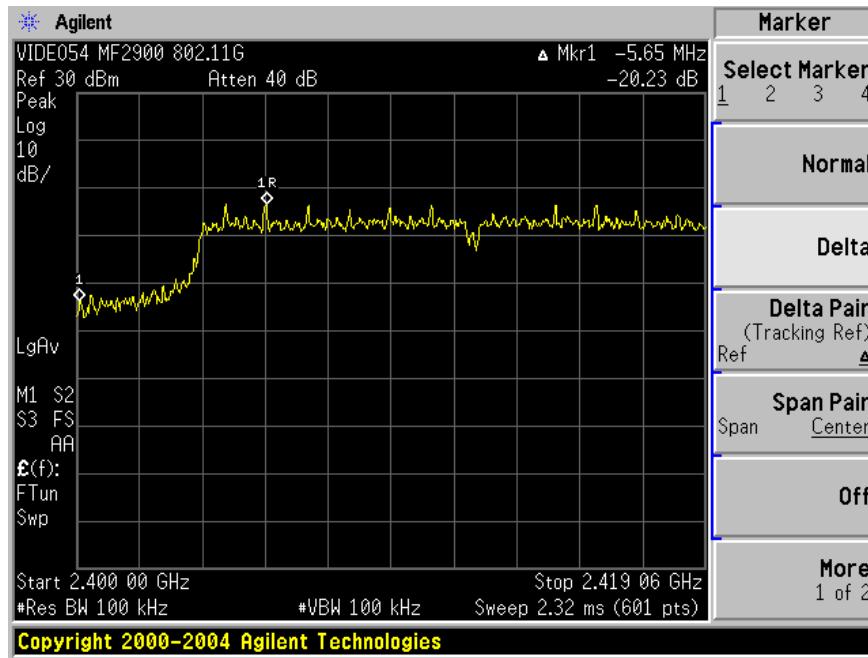

## §15.247(e) - POWER SPECTRAL DENSITY

### Standard Applicable

According to §15.247 (e), for direct sequence systems, the peak power spectral density conducted from the intentional radiator to the antenna shall not be greater than 8 dBm in any 3 kHz band during any time interval of continuous transmission.

### Measurement Procedure

1. Check the calibration of the measuring instrument using either an internal calibrator or a known signal from an external generator.
2. Position the EUT was set without connection to measurement instrument. Turn on the EUT and connect its antenna terminal to measurement instrument via a low loss cable. Then set it to any one measured frequency within its operating range, and make sure the instrument is operated in its linear range.
3. Adjust the center frequency of SA on any frequency be measured and set SA to 1.5MHz span mode. And then, set RBW and VBW of spectrum analyzer to proper value. (DTS)
4. Repeat above procedures until all frequencies measured were complete.

### Equipment Lists

Manufacturer	Description	Model	Serial Number	Cal. Date
Agilent	Analyzer, Spectrum	E4446A	US44300386	11/10/2004

\* **Statement of Traceability: BACL Corp.** attests that all calibrations have been performed per the NVLAP requirements, traceable to the NIST.

### Measurement Result

#### Environmental Conditions

Temperature:	22° C
Relative Humidity:	59%
ATM Pressure:	1023 mbar

*The testing was performed by Snell Leong on 2005-05-23.*

**Test Result**

802.11b

Channel	Frequency (MHz)	Peak Power Spectral Density (dBm)	Standard (dBm)	Result
Low	2412	-3.53	≤ 8	Pass
Mid	2442	-4.33	≤ 8	Pass
High	2462	-4.36	≤ 8	Pass

802.11g

Channel	Frequency (MHz)	Peak Power Spectral Density (dBm)	Standard (dBm)	Result
Low	2412	-3.05	≤ 8	Pass
Mid	2442	-3.25	≤ 8	Pass
High	2462	-3.10	≤ 8	Pass



802.11b

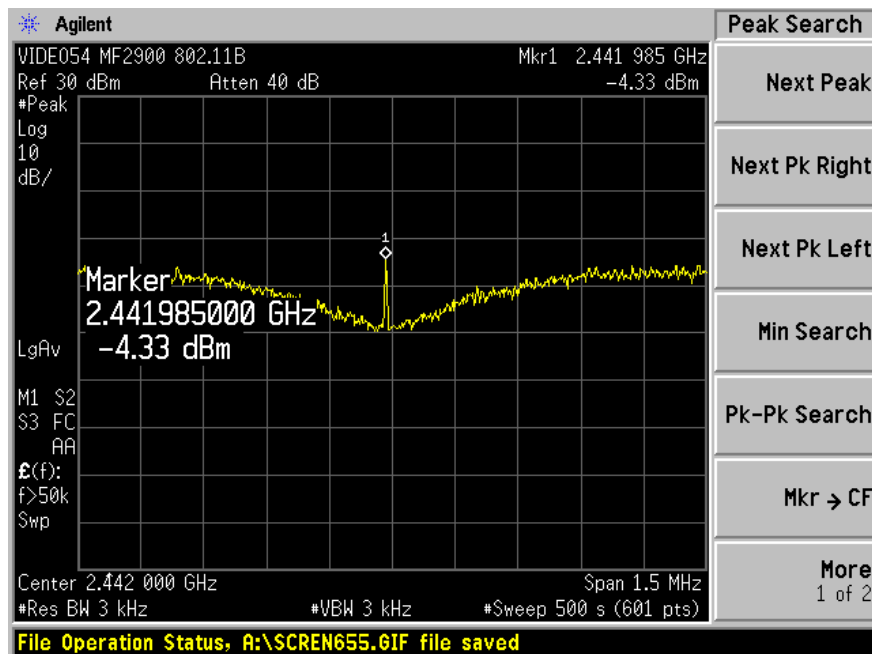
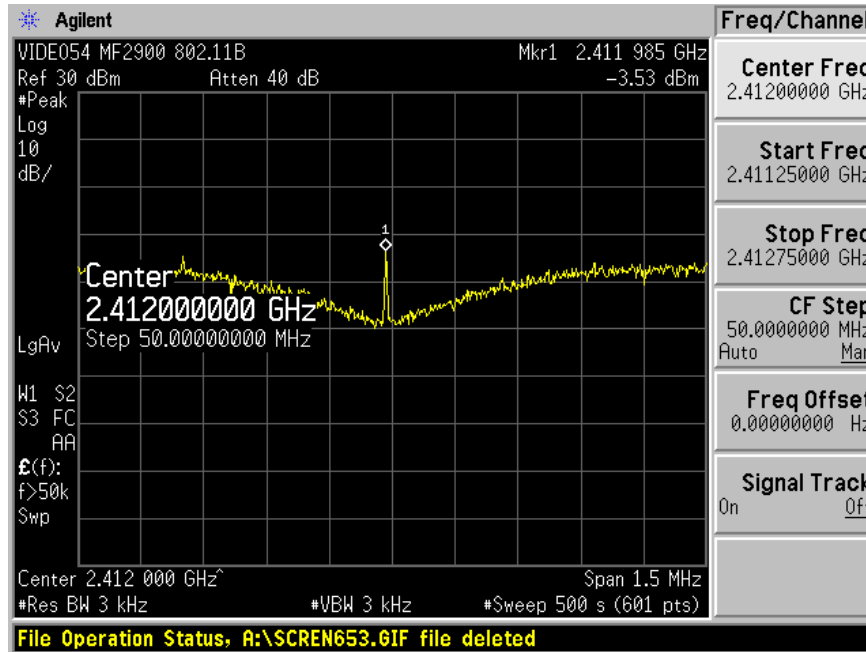

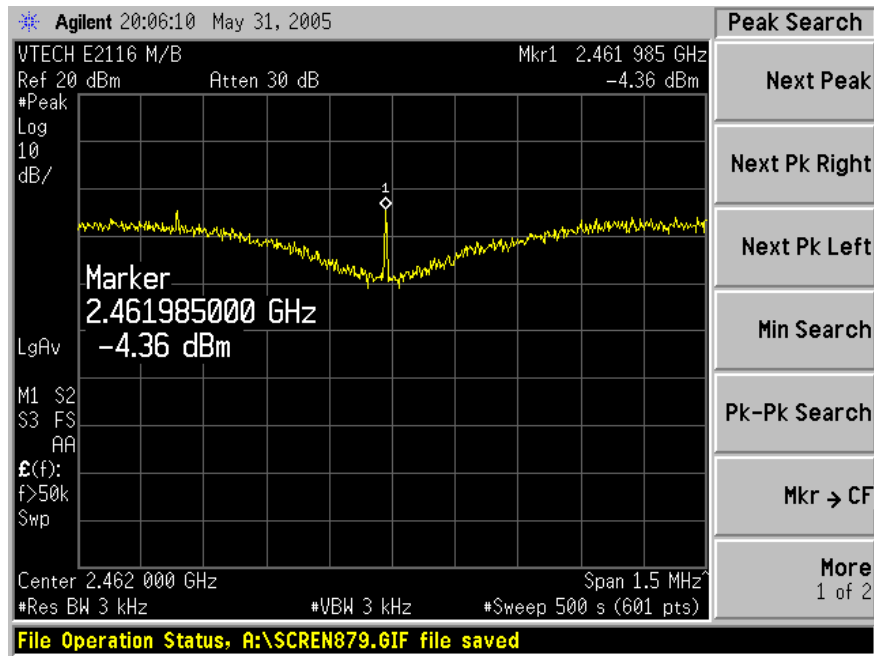

802.11g

