

*Electromagnetic Emissions Test Report
Application for Grant of Equipment Authorization
Class II Permissive Change
pursuant to
Industry Canada RSS-Gen Issue 2 / RSS 210 Issue 7
FCC Part 15, Subpart E
on the
Ruckus Wireless
Transmitter
Model: 7962*

UPN: 5912A-7962
FCC ID: S9G7962

GRANTEE: Ruckus Wireless
880 West Maude Ave. Suite 101
Sunnyvale, CA 94085

TEST SITE(S): Elliott Laboratories
684 W. Maude Ave
Sunnyvale, CA 94086
IC Site Registration #: IC 2845-1

REPORT DATE: March 31, 2009

REISSUE DATE: November 4, 2009

FINAL TEST DATE: February 9, February 10, February 11 and
October 29, 2009

AUTHORIZED SIGNATORY:



Mark E. Hill
Staff Engineer



Testing Cert #2016-01

Elliott Laboratories is accredited by the A2LA, certificate number 2016-01, to perform the test(s) listed in this report. This report shall not be reproduced, except in its entirety, without the written approval of Elliott Laboratories

File: R75044 Rev 2

Page 1 of 23

REVISION HISTORY

Rev #	Date	Comments	Modified By
1	April 8, 2009	First Release	-
2	November 4, 2009	Reissued to add new test data to reflect changes in the FCC's requirements for DFS master devices operating in the 5470-5725 MHz band	D. Guidotti M. Hill

TABLE OF CONTENTS

COVER PAGE.....1

REVISION HISTORY2

TABLE OF CONTENTS3

SCOPE.....5

OBJECTIVE.....6

STATEMENT OF COMPLIANCE.....6

TEST RESULTS SUMMARY7

 UNII / LELAN DEVICES7

 GENERAL REQUIREMENTS APPLICABLE TO ALL BANDS.....10

MEASUREMENT UNCERTAINTIES.....10

EQUIPMENT UNDER TEST (EUT) DETAILS.....11

 GENERAL.....11

 OTHER EUT DETAILS.....11

 ANTENNA SYSTEM11

 ENCLOSURE.....11

 MODIFICATIONS.....11

 SUPPORT EQUIPMENT.....11

 EUT INTERFACE PORTS12

 EUT OPERATION.....12

TEST SITE.....13

 GENERAL INFORMATION.....13

 CONDUCTED EMISSIONS CONSIDERATIONS13

 RADIATED EMISSIONS CONSIDERATIONS13

MEASUREMENT INSTRUMENTATION14

 RECEIVER SYSTEM14

 INSTRUMENT CONTROL COMPUTER14

 LINE IMPEDANCE STABILIZATION NETWORK (LISN).....14

 FILTERS/ATTENUATORS15

 ANTENNAS.....15

 ANTENNA MAST AND EQUIPMENT TURNTABLE.....15

 INSTRUMENT CALIBRATION.....15

TABLE OF CONTENTS (Continued)

TEST PROCEDURES	16
EUT AND CABLE PLACEMENT	16
CONDUCTED EMISSIONS.....	16
RADIATED EMISSIONS.....	16
RADIATED EMISSIONS.....	17
CONDUCTED EMISSIONS FROM ANTENNA PORT	18
BANDWIDTH MEASUREMENTS	19
SPECIFICATION LIMITS AND SAMPLE CALCULATIONS.....	20
GENERAL TRANSMITTER RADIATED EMISSIONS SPECIFICATION LIMITS	20
FCC 15.407 (A) OUTPUT POWER LIMITS	20
OUTPUT POWER LIMITS –LELAN DEVICES.....	21
OUTPUT POWER AND SPURIOUS LIMITS –UNII AND LELAN DEVICES	21
SAMPLE CALCULATIONS - CONDUCTED EMISSIONS	21
SAMPLE CALCULATIONS - RADIATED EMISSIONS.....	22
SAMPLE CALCULATIONS - FIELD STRENGTH TO EIRP CONVERSION.....	23
<i>EXHIBIT 1: Test Equipment Calibration Data.....</i>	<i>1</i>
<i>EXHIBIT 2: Test Measurement Data.....</i>	<i>2</i>
<i>EXHIBIT 3: Photographs of Test Configurations.....</i>	<i>3</i>
<i>EXHIBIT 4: Operator's Manual</i>	<i>4</i>
<i>EXHIBIT 5: RF Exposure Information.....</i>	<i>5</i>

SCOPE

An electromagnetic emissions test has been performed on the Ruckus Wireless model 7962 pursuant to the following rules:

Industry Canada RSS-Gen Issue 2
RSS 210 Issue 7 “Low-power Licence-exempt Radiocommunication Devices (All Frequency Bands): Category I Equipment”
FCC Part 15, Subpart E requirements for UNII Devices (using FCC DA 02-2138, August 30, 2002)

Conducted and radiated emissions data has been collected, reduced, and analyzed within this report in accordance with measurement guidelines set forth in the following reference standards and as outlined in Elliott Laboratories test procedures:

ANSI C63.4:2003
FCC UNII test procedure 2002-08 DA-02-2138, August 2002

The intentional radiator above has been tested in a simulated typical installation to demonstrate compliance with the relevant Industry Canada performance and procedural standards.

Final system data was gathered in a mode that tended to maximize emissions by varying orientation of EUT, orientation of power and I/O cabling, antenna search height, and antenna polarization.

Every practical effort was made to perform an impartial test using appropriate test equipment of known calibration. All pertinent factors have been applied to reach the determination of compliance.

The test results recorded herein are based on a single type test of the Ruckus Wireless model 7962 and therefore apply only to the tested sample. The sample was selected and prepared by Craig Owens of Ruckus Wireless.

OBJECTIVE

The primary objective of the manufacturer is compliance with the regulations outlined in the previous section.

Prior to marketing in the USA, all unlicensed transmitters and transceivers require certification. Receive-only devices operating between 30 MHz and 960 MHz are subject to either certification or a manufacturer's declaration of conformity, with all other receive-only devices exempt from the technical requirements.

Prior to marketing in Canada, Class I transmitters, receivers and transceivers require certification. Class II devices are required to meet the appropriate technical requirements but are exempt from certification requirements.

Certification is a procedure where the manufacturer submits test data and technical information to a certification body and receives a certificate or grant of equipment authorization upon successful completion of the certification body's review of the submitted documents. Once the equipment authorization has been obtained, the label indicating compliance must be attached to all identical units, which are subsequently manufactured.

Maintenance of compliance is the responsibility of the manufacturer. Any modification of the product which may result in increased emissions should be checked to ensure compliance has been maintained (i.e., printed circuit board layout changes, different line filter, different power supply, harnessing or I/O cable changes, etc.).

STATEMENT OF COMPLIANCE

The tested sample of Ruckus Wireless model 7962 complied with the requirements of the following regulations:

RSS 210 Issue 7 "Low-power Licence-exempt Radiocommunication Devices (All Frequency Bands): Category I Equipment"
FCC Part 15, Subpart E requirements for UNII Devices

Maintenance of compliance is the responsibility of the manufacturer. Any modification of the product which may result in increased emissions should be checked to ensure compliance has been maintained (i.e., printed circuit board layout changes, different line filter, different power supply, harnessing or I/O cable changes, etc.).

TEST RESULTS SUMMARY**UNII / LELAN DEVICES****Operation in the 5.25 – 5.35 GHz Band**

FCC Rule Part	RSS Rule Part	Description	Measured Value / Comments	Limit / Requirement	Result (margin)
15.407(a) (2)		26dB Bandwidth	802.11a 23.3 MHz 802.11 HT20 25.3 MHz 802.11 HT40 47.7 MHz	N/A – limits output power if < 20MHz	N/A
15.407(a) (2)	A9.2(2)	Output Power	802.11a 23.1 dBm (0.205W) 802.11 HT20 23.0dBm (0.198W) 802.11 HT40 23.8dBm (0.241)	24 dBm / 250mW (eirp < 30dBm)	Complies
15.407(a) (2))		Power Spectral Density	802.11a 10.95dBm/MHz	11 dBm/MHz	Complies
	A9.2(2) / A9.5 (2)	Power Spectral Density	802.11 HT20 10.6dBm/MHz 802.11 HT40 7.97dBm/MHz	11 dBm / MHz ¹	Complies
	A9.5 (2)	Peak Spectral Density	802.11a 10.95dBm/MHz 802.11 HT20 10.6dBm/MHz 802.11 HT40 7.97dBm/MHz	Shall not exceed the average value by more than 3dB	Complies

¹ Reduced from 11dBm because highest value exceeded the average value by more than 3dB

Operation in the 5.47 – 5.725 GHz Band

FCC Rule Part	RSS Rule Part	Description	Measured Value / Comments	Limit / Requirement	Result (margin)
15.407(a) (2)		26dB Bandwidth	802.11a 22.8 MHz 802.11 HT20 25.8 MHz 802.11 HT40 47.5 MHz	N/A – limits output power if < 20MHz	N/A
15.407(a) (2)	A9.2(2)	Output Power	802.11a 23.1 dBm (0.206W) 802.11 HT20 23.5dBm (0.224) 802.11 HT40 23.5dBm (0.224)	24 dBm / 250mW (eirp < 30dBm)	Complies
15.407(a) (2))		Power Spectral Density	802.11a 10.99dBm/MHz	11 dBm/MHz	Complies
	A9.2(2) / A9.5 (2)	Power Spectral Density	802.11 HT20 10.95dBm/MHz 802.11 HT40 8.01dBm/MHz	11 dBm / MHz ¹	Complies
N/A	??	Non-operation in 5600 – 5650 MHz sub band	Device cannot operate in the 5600 – 5650 MHz band –refer to Operational Description		Complies

General requirements for all bands

FCC Rule Part	RSS Rule Part	Description	Measured Value / Comments	Limit / Requirement	Result
	A9.5a	Modulation	Digital Modulation is used	Digital modulation is required	Complies
	RSP 100	99% bandwidth	802.11a 17.2 MHz 802.11 HT20 18.1 MHz 802.11 HT40 36.8 MHz	Information only	
15.407(b) (5) / 15.209	A9.3	Spurious Emissions below 1GHz	No emissions below 1GHz		Complies
15.407(b) (2)	A9.3	Spurious Emissions above 1GHz	53.9dBμV/m @ 5350.0MHz (-0.1dB)		Complies
15.407(a)(6)	-	Peak Excursion Ratio	12.2 dB	< 13dB	Complies
	A9.5 (3)	Channel Selection	Spurious emissions tested at outermost channels in each band	Device was tested on the top, bottom and center channels in each band	N/A

¹ Reduced from 11dBm because highest value exceeded the average value by more than 3dB

FCC Rule Part	RSS Rule Part	Description	Measured Value / Comments	Limit / Requirement	Result
15			Measurements on three channels in each band		
15.407 (c)	A9.5(4)	Operation in the absence of information to transmit	Operation is discontinued in the absence of information	Device shall automatically discontinue operation in the absence of information to transmit	Complies
15.407 (g)	A9.5 (5)	Frequency Stability	Frequency stability is better than 10ppm		Complies
15.407 (h1)	A9.4	Transmit Power Control	TPC is not required as the device operates at below 500mW eirp	The U-NII device shall have the capability to operate with a mean EIRP value lower than 24dBm (250mW)	Complies
15.407 (h2)	A9.4	Dynamic frequency Selection (device with radar detection)	Refer to separate test report, reference R74524	Threshold -64dBm Channel Availability Check > 60s Channel closing transmission time < 260ms Channel move time < 10s Non occupancy period > 30minutes	Complies
	A9.7	User Manual information	Refer to Exhibit 6 for details		Complies

GENERAL REQUIREMENTS APPLICABLE TO ALL BANDS

FCC Rule Part	RSS Rule part	Description	Measured Value / Comments	Limit / Requirement	Result (margin)
15.203	-	RF Connector	All antennas are internal		Complies
15.109	RSS GEN 7.2.3 Table 1	Receiver spurious emissions	50.9dB μ V/m @ 7066.7MHz (-3.1dB)	Refer to standard	Complies
15.207	RSS GEN Table 2	AC Conducted Emissions	52.6dB μ V @ 13.853MHz (-7.4dB)	Refer to standard	Complies
15.247 (b) (5) 15.407 (f)	RSS 102	RF Exposure Requirements	Refer to MPE calculations in Exhibit 11, RSS 102 declaration and User Manual statements	Refer to OET 65, FCC Part 1 and RSS 102	Complies
	RSP 100 RSS GEN 7.1.5	User Manual		Statement required regarding non-interference	Complies
	RSP 100 RSS GEN 7.1.5	User Manual	Antennas are non-detachable	Statement required regarding detachable antenna	N/A

MEASUREMENT UNCERTAINTIES

ISO/IEC 17025 requires that an estimate of the measurement uncertainties associated with the emissions test results be included in the report. The measurement uncertainties given below were calculated using the approach described in CISPR 16-4-2:2003 using a coverage factor of k=2, which gives a level of confidence of approximately 95%. The levels were found to be below levels of U_{cispr} and therefore no adjustment of the data for measurement uncertainty is required.

Measurement Type	Frequency Range (MHz)	Calculated Uncertainty (dB)
Conducted Emissions	0.15 to 30	± 2.4
Radiated Emissions	0.015 to 30	± 3.0
Radiated Emissions	30 to 1000	± 3.6
Radiated Emissions	1000 to 40000	± 6.0

EQUIPMENT UNDER TEST (EUT) DETAILS**GENERAL**

The Ruckus Wireless model 7962 is an Access Point that is designed to distribute WiFi. Since the EUT would be placed on a table top during operation, the EUT was treated as table-top equipment during testing to simulate the end-user environment. The electrical rating of the EUT is 120/230 Volts, 50/60 Hz, 0.5 Amps using an external AC/DC adapter. The EUT can also be powered over the POE port.

The sample was received on February 9, 2009 and tested on February 9, February 10, February 11 and October 29, 2009. The EUT consisted of the following component(s):

Manufacturer	Model	Description	Serial Number	FCC ID
Ruckus Wireless, Inc.	7962	802.11 a/b/g/n Access Point	0901000003	S9G7962

OTHER EUT DETAILS

The following power supplies are supported in addition to any PoE injector or switch. Ruckus does not supply the PoE supply.

DVE	S024EU1200150	Power Supply	-	-
-----	---------------	--------------	---	---

ANTENNA SYSTEM

The six antennas (3 for each band) used in the system are internal to the device.

ENCLOSURE

The EUT enclosure is primarily constructed of plastic. It measures approximately 19 cm wide by 15 cm deep by 10 cm high.

MODIFICATIONS

The EUT did not require modifications during testing in order to comply with emissions specifications.

SUPPORT EQUIPMENT

No equipment was used as local support equipment for emissions testing.

The following equipment was used as remote support equipment for emissions testing:

Manufacturer	Model	Description	Serial Number	FCC ID
Dell	-	Laptop Computer	-	DoC

EUT INTERFACE PORTS

The I/O cabling configuration during emissions testing was as follows:

Port	Connected To	Cable(s)		
		Description	Shielded or Unshielded	Length(m)
Ethernet	Laptop	CAT5	Unshielded	3m
DC Power	AC/DC Adapter	Multiconductor	Shielded	1.5

EUT OPERATION

During transmit mode testing, the EUT was set to continuously transmit at the desired channel, power, and mode. For receive mode testing, the EUT was configured in a receive only mode.

TEST SITE**GENERAL INFORMATION**

Final test measurements were taken on February 9, February 10 and February 11, 2009 at the test sites listed below. Pursuant to section 2.948 of the FCC's Rules and section 3.3 of RSP-100, construction, calibration, and equipment data has been filed with the Commission and with industry Canada.

Site	Registration Numbers		Location
	FCC	Canada	
SVOATS #1	90592	IC 2845A-1	684 West Maude Ave, Sunnyvale CA 94085-3518

ANSI C63.4:2003 recommends that ambient noise at the test site be at least 6 dB below the allowable limits. Ambient levels are below this requirement with the exception, on OATS sites, of predictable local TV, radio, and mobile communications traffic. The test site(s) contain separate areas for radiated and conducted emissions testing. Considerable engineering effort has been expended to ensure that the facilities conform to all pertinent requirements of ANSI C63.4:2003.

CONDUCTED EMISSIONS CONSIDERATIONS

Conducted emissions testing is performed in conformance with ANSI C63.4:2003. Measurements are made with the EUT connected to the public power network through a nominal, standardized RF impedance, which is provided by a line impedance stabilization network, known as a LISN. A LISN is inserted in series with each current-carrying conductor in the EUT power cord.

RADIATED EMISSIONS CONSIDERATIONS

The FCC has determined that radiation measurements made in a shielded enclosure are not suitable for determining levels of radiated emissions. Radiated measurements are performed in an open field environment or in a semi-anechoic chamber. The test sites are maintained free of conductive objects within the CISPR defined elliptical area incorporated in ANSI C63.4:2003 guidelines and meet the Normalized Site Attenuation (NSA) requirements of ANSI C63.4:2003.

MEASUREMENT INSTRUMENTATION

RECEIVER SYSTEM

An EMI receiver as specified in CISPR 16-1 is used for emissions measurements. The receivers used can measure over the frequency range of 9 kHz up to 2000 MHz. These receivers allow both ease of measurement and high accuracy to be achieved. The receivers have Peak, Average, and CISPR (Quasi-peak) detectors built into their design so no external adapters are necessary. The receiver automatically sets the required bandwidth for the CISPR detector used during measurements. If the repetition frequency of the signal being measured is below 20Hz, peak measurements are made in lieu of Quasi-Peak measurements.

For measurements above the frequency range of the receivers, a spectrum analyzer is utilized because it provides visibility of the entire spectrum along with the precision and versatility required to support engineering analysis. Average measurements above 1000MHz are performed on the spectrum analyzer using the linear-average method with a resolution bandwidth of 1 MHz and a video bandwidth of 10 Hz, unless the signal is pulsed in which case the average (or video) bandwidth of the measuring instrument is reduced to onset of pulse desensitization and then increased.

INSTRUMENT CONTROL COMPUTER

The receivers utilize either a Rohde & Schwarz EZM Spectrum Monitor/Controller or contain an internal Spectrum Monitor/Controller to view and convert the receiver measurements to the field strength at an antenna or voltage developed at the LISN measurement port, which is then compared directly with the appropriate specification limit. This provides faster, more accurate readings by performing the conversions described under Sample Calculations within the Test Procedures section of this report. Results are printed in a graphic and/or tabular format, as appropriate. A personal computer is used to record all measurements made with the receivers.

The Spectrum Monitor provides a visual display of the signal being measured. In addition, the controller or a personal computer run automated data collection programs which control the receivers. This provides added accuracy since all site correction factors, such as cable loss and antenna factors are added automatically.

LINE IMPEDANCE STABILIZATION NETWORK (LISN)

Line conducted measurements utilize a fifty microhenry Line Impedance Stabilization Network as the monitoring point. The LISN used also contains a 250 uH CISPR adapter. This network provides for calibrated radio frequency noise measurements by the design of the internal low pass and high pass filters on the EUT and measurement ports, respectively.

FILTERS/ATTENUATORS

External filters and precision attenuators are often connected between the receiving antenna or LISN and the receiver. This eliminates saturation effects and non-linear operation due to high amplitude transient events.

ANTENNAS

A loop antenna is used below 30 MHz. For the measurement range 30 MHz to 1000 MHz either a combination of a biconical antenna and a log periodic or a bi-log antenna is used. Above 1000 MHz, horn antennas are used. The antenna calibration factors to convert the received voltage to an electric field strength are included with appropriate cable loss and amplifier gain factors to determine an overall site factor, which is then programmed into the test receivers or incorporated into the test software.

ANTENNA MAST AND EQUIPMENT TURNTABLE

The antennas used to measure the radiated electric field strength are mounted on a non-conductive antenna mast equipped with a motor-drive to vary the antenna height. Measurements below 30 MHz are made with the loop antenna at a fixed height of 1m above the ground plane.

ANSI C63.4:2003 specifies that the test height above ground for table mounted devices shall be 80 centimeters. Floor mounted equipment shall be placed on the ground plane if the device is normally used on a conductive floor or separated from the ground plane by insulating material from 3 to 12 mm if the device is normally used on a non-conductive floor. During radiated measurements, the EUT is positioned on a motorized turntable in conformance with this requirement.

INSTRUMENT CALIBRATION

All test equipment is regularly checked to ensure that performance is maintained in accordance with the manufacturer's specifications. All antennas are calibrated at regular intervals with respect to tuned half-wave dipoles. An exhibit of this report contains the list of test equipment used and calibration information.

TEST PROCEDURES

EUT AND CABLE PLACEMENT

The regulations require that interconnecting cables be connected to the available ports of the unit and that the placement of the unit and the attached cables simulate the worst case orientation that can be expected from a typical installation, so far as practicable. To this end, the position of the unit and associated cabling is varied within the guidelines of ANSI C63.4:2003, and the worst-case orientation is used for final measurements.

CONDUCTED EMISSIONS

Conducted emissions are measured at the plug end of the power cord supplied with the EUT. Excess power cord length is wrapped in a bundle between 30 and 40 centimeters in length near the center of the cord. Preliminary measurements are made to determine the highest amplitude emission relative to the specification limit for all the modes of operation. Placement of system components and varying of cable positions are performed in each mode. A final peak mode scan is then performed in the position and mode for which the highest emission was noted on all current carrying conductors of the power cord.

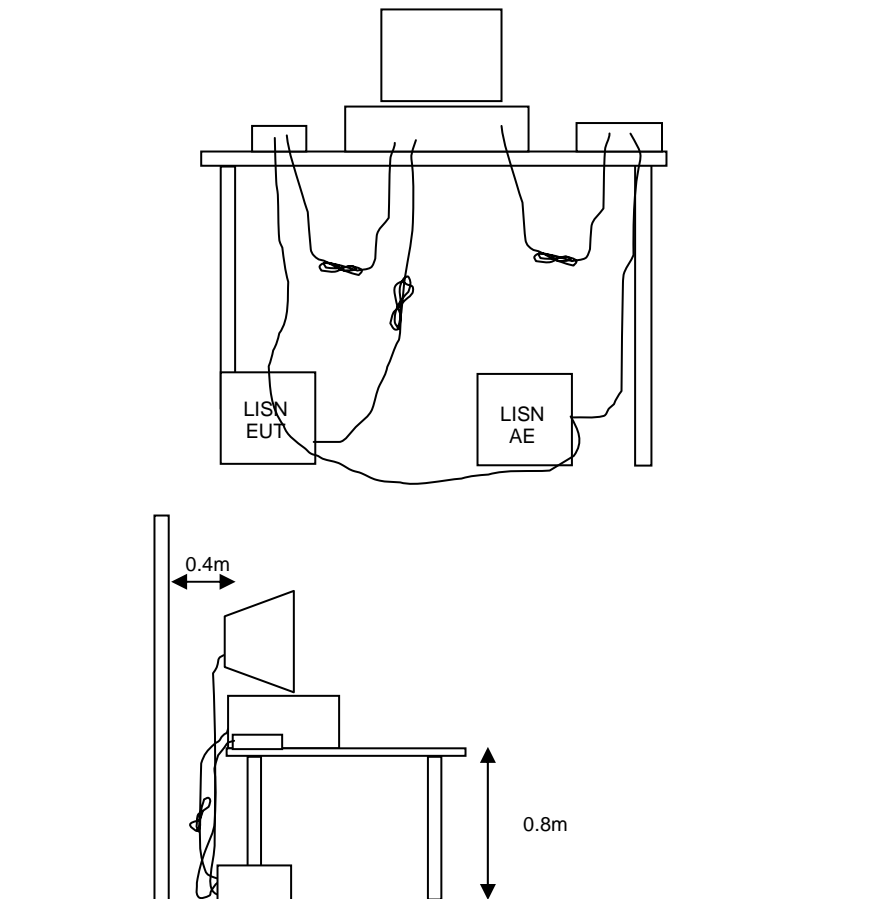

RADIATED EMISSIONS

A preliminary scan of the radiated emissions is performed in which all significant EUT frequencies are identified with the system in a nominal configuration. At least two scans are performed, one scan for each antenna polarization (horizontal and vertical; loop parallel and perpendicular to the EUT). During the preliminary scans, the EUT is rotated through 360°, the antenna height is varied (for measurements above 30 MHz) and cable positions are varied to determine the highest emission relative to the limit. Preliminary scans may be performed in a fully anechoic chamber for the purposes of identifying the frequencies of the highest emissions from the EUT.

A speaker is provided in the receiver to aid in discriminating between EUT and ambient emissions. Other methods used during the preliminary scan for EUT emissions involve scanning with near field magnetic loops, monitoring I/O cables with RF current clamps, and cycling power to the EUT.

Final maximization is a phase in which the highest amplitude emissions identified in the spectral search are viewed while the EUT azimuth angle is varied from 0 to 360 degrees relative to the receiving antenna. The azimuth, which results in the highest emission is then maintained while varying the antenna height from one to four meters (for measurements above 30 MHz, measurements below 30 MHz are made with the loop antenna at a fixed height of 1m). The result is the identification of the highest amplitude for each of the highest peaks. Each recorded level is corrected in the receiver using appropriate factors for cables, connectors, antennas, and preamplifier gain.

When testing above 18 GHz, the receive antenna is located at 1 meter from the EUT and the antenna height is restricted to a maximum of 2.5 meters.

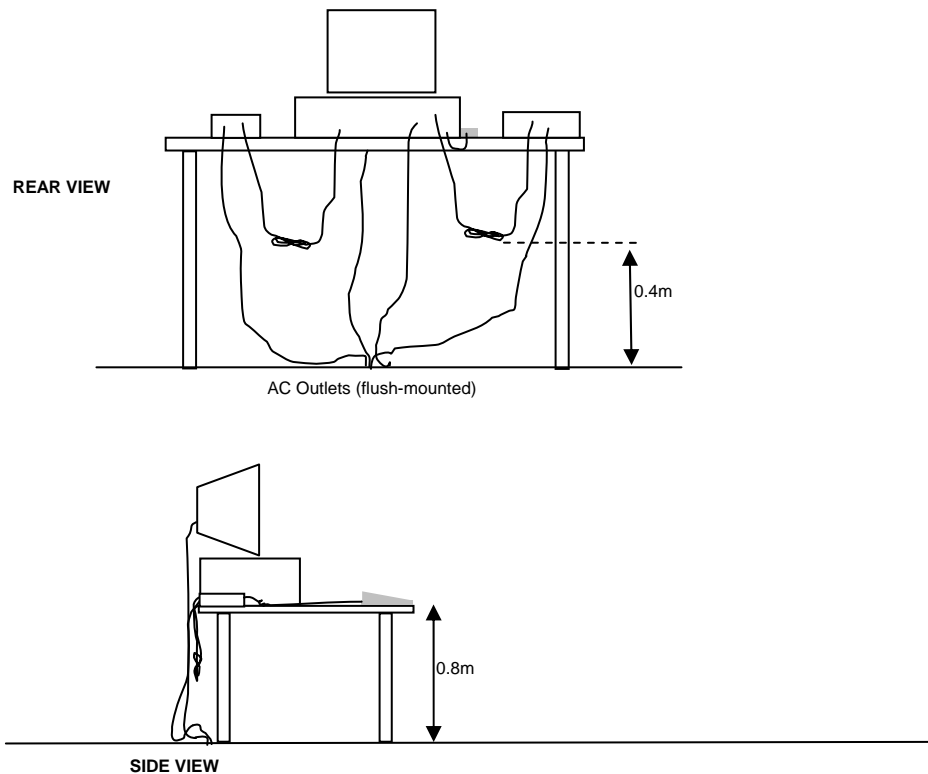

Typical Test Configuration for Radiated Field Strength Measurements

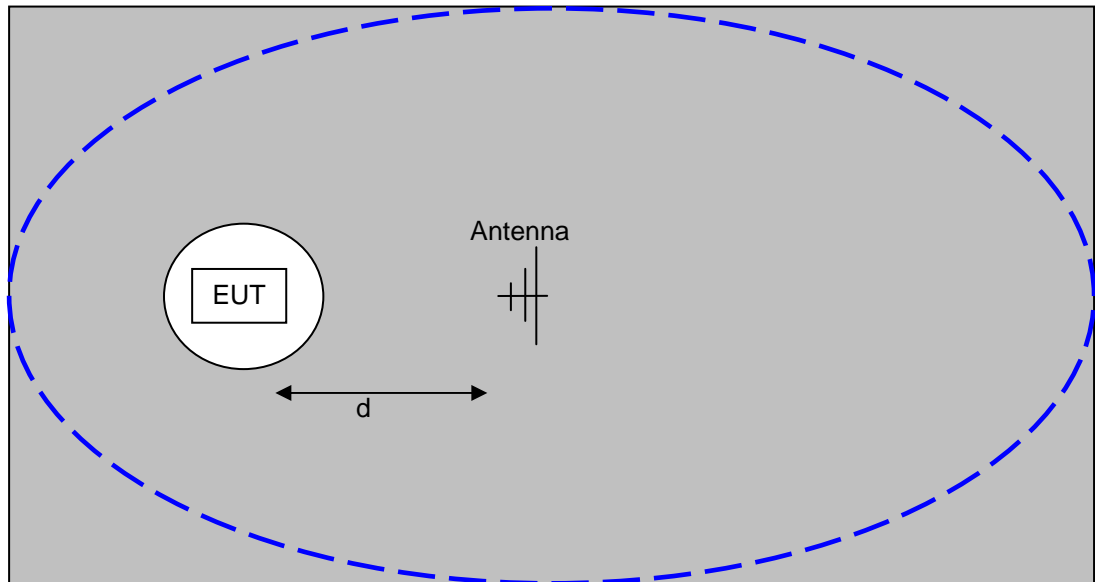

The ground plane extends beyond the ellipse defined in CISPR 16 / CISPR 22 / ANSI C63.4 and is large enough to accommodate test distances (d) of 3m and 10m. Refer to the test data tables for the actual measurement distance.

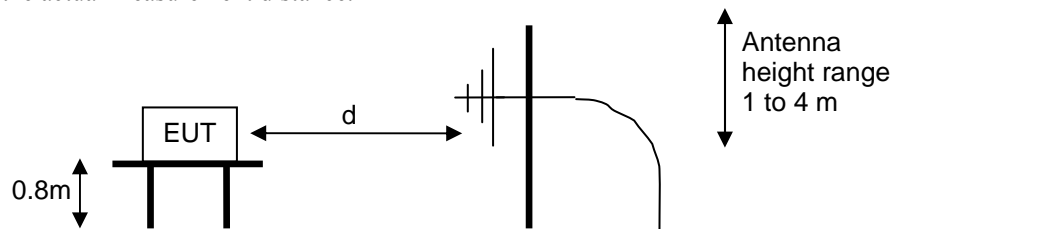

Test Configuration for Radiated Field Strength Measurements
OATS- Plan and Side Views

CONDUCTED EMISSIONS FROM ANTENNA PORT

Direct measurements of power, bandwidth and power spectral density are performed, where possible, with the antenna port of the EUT connected to either the power meter or spectrum analyzer via a suitable attenuator and/or filter. These are used to ensure that the front end of the measurement instrument is not overloaded by the fundamental transmission.

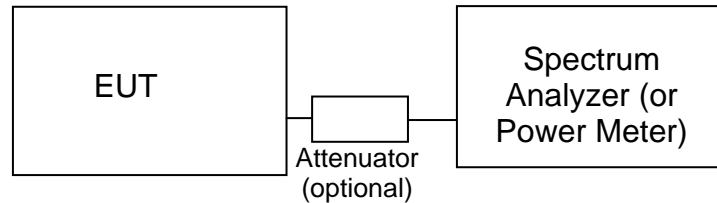

Test Configuration for Antenna Port Measurements

Measurement bandwidths (video and resolution) are set in accordance with the relevant standards and Elliott's test procedures for the type of radio being tested. When power measurements are made using a resolution bandwidth less than the signal bandwidth the power is calculated by summing the power across the signal bandwidth using either the analyzer channel power function or by capturing the trace data and calculating the power using software. In both cases the summed power is corrected to account for the equivalent noise bandwidth (ENBW) of the resolution bandwidth used.

If power averaging is used (typically for certain digital modulation techniques), the EUT is configured to transmit continuously. Power averaging is performed using either the built-in function of the analyzer or, if the analyzer does not feature power averaging, using external software. In both cases the average power is calculated over a number of sweeps (typically 100). When the EUT cannot be configured to continuously transmit then either the analyzer is configured to perform a gated sweep to ensure that the power is averaged over periods that the device is transmitting or power averaging is disabled and a max-hold feature is used.

If a power meter is used to make output power measurements the sensor head type (peak or average) is stated in the test data table.

BANDWIDTH MEASUREMENTS

The 6dB, 20dB and/or 26dB signal bandwidth is measured in using the bandwidths recommended by ANSI C63.4. When required, the 99% bandwidth is measured using the methods detailed in RSS GEN.

SPECIFICATION LIMITS AND SAMPLE CALCULATIONS

The limits for conducted emissions are given in units of microvolts, and the limits for radiated emissions are given in units of microvolts per meter at a specified test distance. Data is measured in the logarithmic form of decibels relative to one microvolt, or dB microvolts (dBuV). For radiated emissions, the measured data is converted to the field strength at the antenna in dB microvolts per meter (dBuV/m). The results are then converted to the linear forms of uV and uV/m for comparison to published specifications.

For reference, converting the specification limits from linear to decibel form is accomplished by taking the base ten logarithm, then multiplying by 20. These limits in both linear and logarithmic form are as follows:

GENERAL TRANSMITTER RADIATED EMISSIONS SPECIFICATION LIMITS

The table below shows the limits for the spurious emissions from transmitters that fall in restricted bands¹ (with the exception of transmitters operating under FCC Part 15 Subpart D and RSS 210 Annex 9), the limits for all emissions from a low power device operating under the general rules of RSS 310 (tables 3 and 4), RSS 210 (table 2) and FCC Part 15 Subpart C section 15.209.

Frequency Range (MHz)	Limit (uV/m)	Limit (dBuV/m @ 3m)
0.009-0.490	2400/F _{KHz} @ 300m	67.6-20*log ₁₀ (F _{KHz}) @ 300m
0.490-1.705	24000/F _{KHz} @ 30m	87.6-20*log ₁₀ (F _{KHz}) @ 30m
1.705 to 30	30 @ 30m	29.5 @ 30m
30 to 88	100 @ 3m	40 @ 3m
88 to 216	150 @ 3m	43.5 @ 3m
216 to 960	200 @ 3m	46.0 @ 3m
Above 960	500 @ 3m	54.0 @ 3m

FCC 15.407 (a) OUTPUT POWER LIMITS

The table below shows the limits for output power and output power density. Where the signal bandwidth is less than 20 MHz the maximum output power is reduced to the power spectral density limit plus 10 times the log of the bandwidth (in MHz).

Operating Frequency (MHz)	Output Power	Power Spectral Density
5150 - 5250	50mW (17 dBm)	4 dBm/MHz
5250 - 5350	250 mW (24 dBm)	11 dBm/MHz
5725 - 5825	1 Watts (30 dBm)	17 dBm/MHz

¹ The restricted bands are detailed in FCC 15.203, RSS 210 Table 1 and RSS 310 Table 2

For system using antennas with gains exceeding 6dBi, the output power and power spectral density limits are reduced by 1dB for every dB the antenna gain exceeds 6dBi. Fixed point-to-point applications using the 5725 – 5825 MHz band may use antennas with gains of up to 23dBi without this limitation. If the gain exceeds 23dBi then the output power limit of 1 Watt is reduced by 1dB for every dB the gain exceeds 23dBi.

The peak excursion envelope is limited to 13dB.

OUTPUT POWER LIMITS –LELAN DEVICES

The table below shows the limits for output power and output power density defined by RSS 210. Where the signal bandwidth is less than 20 MHz the maximum output power is reduced to the power spectral density limit plus 10 times the log of the bandwidth (in MHz).

Operating Frequency (MHz)	Output Power	Power Spectral Density
5150 - 5250	200mW (23 dBm) eirp	10 dBm/MHz eirp
5250 - 5350	250 mW (24 dBm) ¹ 1W (30dBm) eirp	11 dBm/MHz
5470 - 5725	250 mW (24 dBm) ² 1W (30dBm) eirp	11 dBm/MHz
5725 – 5825	1 Watts (30 dBm) 4W eirp	17 dBm/MHz

In addition, the power spectral density limit shall be reduced by 1dB for every dB the highest power spectral density exceeds the “average” power spectral density) by more than 3dB. The “average” power spectral density is determined by dividing the output power by $10\log(\text{EBW})$ where EBW is the 99% power bandwidth.

Fixed point-to-point applications using the 5725 – 5825 MHz band may use antennas with gains of up to 23dBi without this limitation. If the gain exceeds 23dBi then the output power limit of 1 Watt is reduced by 1dB for every dB the gain exceeds 23dBi.

OUTPUT POWER AND SPURIOUS LIMITS –UNII and LELAN DEVICES

The spurious emissions limits for signals below 1GHz are the FCC/RSS-GEN general limits. For emissions above 1GHz, signals in restricted bands are subject to the FCC/RSS GEN general limits. All other signals have a limit of -27dBm/MHz , which is a field strength of 68.3dBuV/m/MHz at a distance of 3m. This is an average limit so the peak value of the emission may not exceed -7dBm/MHz (68.3dBuV/m/MHz at a distance of 3m). For devices operating in the 5725-5850Mhz bands under the LELAN/UNII rules, the limit within 10Mhz of the allocated band is increased to -17dBm/MHz .

SAMPLE CALCULATIONS - CONDUCTED EMISSIONS

Receiver readings are compared directly to the conducted emissions specification limit (decibel form) as follows:

¹ If EIRP exceeds 500mW the device must employ TPC

² If EIRP exceeds 500mW the device must employ TPC

$$R_T - S = M$$

where:

R_T = Receiver Reading in dBuV

S = Specification Limit in dBuV

M = Margin to Specification in +/- dB

SAMPLE CALCULATIONS - RADIATED EMISSIONS

Receiver readings are compared directly to the specification limit (decibel form). The receiver internally corrects for cable loss, preamplifier gain, and antenna factor. The calculations are in the reverse direction of the actual signal flow, thus cable loss is added and the amplifier gain is subtracted. The Antenna Factor converts the voltage at the antenna coaxial connector to the field strength at the antenna elements.

A distance factor, when used for electric field measurements above 30MHz, is calculated by using the following formula:

$$F_d = 20 * \text{LOG}_{10} (D_m/D_s)$$

where:

F_d = Distance Factor in dB

D_m = Measurement Distance in meters

D_s = Specification Distance in meters

For electric field measurements below 30MHz the extrapolation factor is either determined by making measurements at multiple distances or a theoretical value is calculated using the formula:

$$F_d = 40 * \text{LOG}_{10} (D_m/D_s)$$

Measurement Distance is the distance at which the measurements were taken and Specification Distance is the distance at which the specification limits are based. The antenna factor converts the voltage at the antenna coaxial connector to the field strength at the antenna elements.

The margin of a given emission peak relative to the limit is calculated as follows:

$$R_c = R_r + F_d$$

and

$$M = R_c - L_s$$

where:

$$R_r = \text{Receiver Reading in dBuV/m}$$

$$F_d = \text{Distance Factor in dB}$$

$$R_c = \text{Corrected Reading in dBuV/m}$$

$$L_s = \text{Specification Limit in dBuV/m}$$

$$M = \text{Margin in dB Relative to Spec}$$

SAMPLE CALCULATIONS - FIELD STRENGTH TO EIRP CONVERSION

Where the radiated electric field strength is expressed in terms of the equivalent isotropic radiated power (eirp), or where a field strength measurement of output power is made in lieu of a direct measurement, the following formula is used to convert between eirp and field strength at a distance of 3m from the equipment under test:

$$E = \frac{1000000 \sqrt{30 P}}{3} \text{ microvolts per meter}$$

where P is the eirp (Watts)

EXHIBIT 1: Test Equipment Calibration Data

2 Pages

Radiated Emissions, 30 - 26,500 MHz, 13-Nov-08**Engineer: Rafael Varelas**

<u>Manufacturer</u>	<u>Description</u>	<u>Model #</u>	<u>Asset #</u>	<u>Cal Due</u>
EMCO	Antenna, Horn, 1-18 GHz	3115	487	15-Jul-10
Hewlett Packard	SpecAn 30 Hz -40 GHz, SV (SA40) Red	8564E (84125C)	1148	24-Nov-08

Radiated Emissions, 30 - 26,500 MHz, 23-Nov-08**Engineer: Rafael Varelas**

<u>Manufacturer</u>	<u>Description</u>	<u>Model #</u>	<u>Asset #</u>	<u>Cal Due</u>
Hewlett Packard	Microwave Preamplifier, 1-26.5GHz	8449B	785	06-Jun-09
Hewlett Packard	SpecAn 30 Hz -40 GHz, SV (SA40) Red	8564E (84125C)	1148	24-Nov-08
Micro-Tronics	Band Reject Filter, 2400-2500 MHz	BRM50702-02	1683	05-Aug-09
EMCO	Antenna, Horn, 1-18 GHz	3115	487	15-Jul-10

Radiated Emissions, 30 - 26,500 MHz, 18-Dec-08**Engineer: Rafael Varelas**

<u>Manufacturer</u>	<u>Description</u>	<u>Model #</u>	<u>Asset #</u>	<u>Cal Due</u>
Hewlett Packard	Microwave Preamplifier, 1-26.5GHz	8449B	870	09-Oct-09
Hewlett Packard	SpecAn 30 Hz -40 GHz, SV (SA40) Red	8564E (84125C)	1148	24-Dec-08
Hewlett Packard	High Pass filter, 8.2 GHz (Red System)	P/N 84300-80039 (84125C)	1152	13-Oct-09
EMCO	Antenna, Horn, 1-18 GHz	3115	1561	10-Jun-10

Radiated Emissions, 1000 - 18,000 MHz, 04-Feb-09**Engineer: Rafael Varelas**

<u>Manufacturer</u>	<u>Description</u>	<u>Model #</u>	<u>Asset #</u>	<u>Cal Due</u>
Hewlett Packard	Microwave Preamplifier, 1-26.5GHz	8449B	785	06-Jun-09
Hewlett Packard	SpecAn 30 Hz -40 GHz, SV (SA40) Red	8564E (84125C)	1148	24-Mar-09
Hewlett Packard	High Pass filter, 8.2 GHz (Red System)	P/N 84300-80039 (84125C)	1152	13-Oct-09
EMCO	Antenna, Horn, 1-18 GHz	3115	1561	10-Jun-10

Radiated Emissions, 30 - 18,000 MHz, 11-Feb-09**Engineer: Joseph Cadigal**

<u>Manufacturer</u>	<u>Description</u>	<u>Model #</u>	<u>Asset #</u>	<u>Cal Due</u>
Elliott Laboratories	Biconical Antenna, 30-300 MHz	EL30.300	54	26-Mar-09
Hewlett Packard	Microwave Preamplifier, 1-26.5GHz	8449B	263	09-Oct-09
Narda West	High Pass Filter, 8 GHz	HPF 180	821	18-Mar-09
Hewlett Packard	SpecAn 30 Hz -40 GHz, SV (SA40) Red	8564E (84125C)	1148	24-Mar-09
Rohde & Schwarz	Test Receiver, 9 kHz-2750 MHz	ESCS 30	1337	02-Oct-09
EMCO	Antenna, Horn, 1-18 GHz	3115	1561	10-Jun-10

Radiated Emissions, 1000 - 18,000 MHz, 12-Feb-09**Engineer: Rafael Varelas**

<u>Manufacturer</u>	<u>Description</u>	<u>Model #</u>	<u>Asset #</u>	<u>Cal Due</u>
Hewlett Packard	SpecAn 9 KHz-26.5 GHz, Non-Program	8563E	284	29-Dec-09
Hewlett Packard	Microwave Preamplifier, 1-26.5GHz	8449B	870	09-Oct-09
EMCO	Antenna, Horn, 1-18 GHz	3115	1561	10-Jun-10

Radio Spurious Emissions, 29-Oct-09**Engineer: Suhaila Khushzad**

<u>Manufacturer</u>	<u>Description</u>	<u>Model #</u>	<u>Asset #</u>	<u>Cal Due</u>
EMCO	Antenna, Horn, 1-18 GHz	3115	487	15-Jul-10
Hewlett Packard	Microwave Preamplifier, 1-26.5GHz	8449B	870	19-Aug-10
Hewlett Packard	SpecAn 30 Hz -40 GHz, SV (SA40) Red	8564E (84125C)	1148	12-Mar-10
Hewlett Packard	High Pass filter, 8.2 GHz (Red System)	P/N 84300-80039 (84125C)	1152	28-Sep-10

Radiated Emissions, 30 - 26,500 MHz, 13-Nov-08**Engineer: Rafael Varelas**

<u>Manufacturer</u>	<u>Description</u>	<u>Model #</u>	<u>Asset #</u>	<u>Cal Due</u>
EMCO	Antenna, Horn, 1-18 GHz	3115	487	15-Jul-10
Hewlett Packard	SpecAn 30 Hz -40 GHz, SV (SA40) Red	8564E (84125C)	1148	24-Nov-08

Radiated Emissions, 30 - 26,500 MHz, 23-Nov-08**Engineer: Rafael Varelas**

<u>Manufacturer</u>	<u>Description</u>	<u>Model #</u>	<u>Asset #</u>	<u>Cal Due</u>
Hewlett Packard	Microwave Preampfier, 1-26.5GHz	8449B	785	06-Jun-09
Hewlett Packard	SpecAn 30 Hz -40 GHz, SV (SA40) Red	8564E (84125C)	1148	24-Nov-08
Micro-Tronics	Band Reject Filter, 2400-2500 MHz	BRM50702-02	1683	05-Aug-09
EMCO	Antenna, Horn, 1-18 GHz	3115	487	15-Jul-10

Radiated Emissions, 30 - 26,500 MHz, 18-Dec-08**Engineer: Rafael Varelas**

<u>Manufacturer</u>	<u>Description</u>	<u>Model #</u>	<u>Asset #</u>	<u>Cal Due</u>
Hewlett Packard	Microwave Preampfier, 1-26.5GHz	8449B	870	09-Oct-09
Hewlett Packard	SpecAn 30 Hz -40 GHz, SV (SA40) Red	8564E (84125C)	1148	24-Dec-08
Hewlett Packard	High Pass filter, 8.2 GHz (Red System)	P/N 84300-80039 (84125C)	1152	13-Oct-09
EMCO	Antenna, Horn, 1-18 GHz	3115	1561	10-Jun-10

Radiated Emissions, 1000 - 18,000 MHz, 04-Feb-09**Engineer: Rafael Varelas**

<u>Manufacturer</u>	<u>Description</u>	<u>Model #</u>	<u>Asset #</u>	<u>Cal Due</u>
Hewlett Packard	Microwave Preampfier, 1-26.5GHz	8449B	785	06-Jun-09
Hewlett Packard	SpecAn 30 Hz -40 GHz, SV (SA40) Red	8564E (84125C)	1148	24-Mar-09
Hewlett Packard	High Pass filter, 8.2 GHz (Red System)	P/N 84300-80039 (84125C)	1152	13-Oct-09
EMCO	Antenna, Horn, 1-18 GHz	3115	1561	10-Jun-10

Radiated Emissions, 30 - 18,000 MHz, 11-Feb-09**Engineer: Joseph Cadigal**

<u>Manufacturer</u>	<u>Description</u>	<u>Model #</u>	<u>Asset #</u>	<u>Cal Due</u>
Elliott Laboratories	Biconical Antenna, 30-300 MHz	EL30.300	54	26-Mar-09
Hewlett Packard	Microwave Preampfier, 1-26.5GHz	8449B	263	09-Oct-09
Narda West	High Pass Filter, 8 GHz	HPF 180	821	18-Mar-09
Hewlett Packard	SpecAn 30 Hz -40 GHz, SV (SA40) Red	8564E (84125C)	1148	24-Mar-09
Rohde & Schwarz	Test Receiver, 9 kHz-2750 MHz	ESCS 30	1337	02-Oct-09
EMCO	Antenna, Horn, 1-18 GHz	3115	1561	10-Jun-10

Radiated Emissions, 1000 - 18,000 MHz, 12-Feb-09**Engineer: Rafael Varelas**

<u>Manufacturer</u>	<u>Description</u>	<u>Model #</u>	<u>Asset #</u>	<u>Cal Due</u>
Hewlett Packard	SpecAn 9 KHz-26.5 GHz, Non-Program	8563E	284	29-Dec-09
Hewlett Packard	Microwave Preampfier, 1-26.5GHz	8449B	870	09-Oct-09
EMCO	Antenna, Horn, 1-18 GHz	3115	1561	10-Jun-10

Radio Antenna Port (Power and Spurious Emissions), 19-March-09**Engineer: Rafael Varelas**

<u>Manufacturer</u>	<u>Description</u>	<u>Model #</u>	<u>Asset #</u>	<u>Cal Due</u>
Hewlett Packard	SpecAn 30 Hz -40 GHz, SV (SA40) Red	8564E (84125C)	1148	24-Mar-09

Radio Antenna Port (Power and Spurious Emissions), 20-March-09**Engineer: Rafael Varelas**

<u>Manufacturer</u>	<u>Description</u>	<u>Model #</u>	<u>Asset #</u>	<u>Cal Due</u>
Hewlett Packard	SpecAn 30 Hz -40 GHz, SV (SA40) Red	8564E (84125C)	1148	24-Mar-09

Radio Antenna Port (Power and Spurious Emissions), 29-Oct-09**Engineer: Suhaila Khushzad**

<u>Manufacturer</u>	<u>Description</u>	<u>Model #</u>	<u>Asset #</u>	<u>Cal Due</u>
Hewlett Packard	SpecAn 30 Hz -40 GHz, SV (SA40) Red	8564E (84125C)	1148	12-Mar-10

Radio Antenna Port (Power and Spurious Emissions), 29-Oct-09**Engineer: Mehran Birgani**

<u>Manufacturer</u>	<u>Description</u>	<u>Model #</u>	<u>Asset #</u>	<u>Cal Due</u>
Agilent	PSA, Spectrum Analyzer, (installed options, 111, 115, 123, 1DS, B7J, HYY,	E4446A	2139	30-Dec-09

EXHIBIT 2: Test Measurement Data

92 Pages



EMC Test Data

Client:	Ruckus Wireless	Job Number:	J77250
Model:	7962	T-Log Number:	T77266
Contact:	Craig Owens	Account Manager:	Dean Eriksen
Emissions Standard(s):	FCC Part 15.E/RSS-210	Class:	B
Immunity Standard(s):	-	Environment:	-

EMC Test Data

For The

Ruckus Wireless

Model

7962

Date of Last Test: 10/29/2009

Client:	Ruckus Wireless	Job Number:	J77250
Model:	7962	T-Log Number:	T77266
Contact:	Craig Owens	Account Manager:	Dean Eriksen
Standard:	FCC Part 15.E/RSS-210	Class:	N/A

RSS 210 and FCC 15.407 (UNII) Radiated Spurious Emissions

Test Specific Details

Objective: The objective of this test session is to perform final qualification testing of the EUT with respect to the specification listed above.

Date of Test: Refer to individual run	Config. Used: 1
Test Engineer: Refer to individual run	Config Change: none
Test Location: Refer to individual run	EUT Voltage: 120V/60Hz

General Test Configuration

The EUT and all local support equipment were located on the turntable for radiated spurious emissions testing. For radiated emissions testing the measurement antenna was located 3 meters from the EUT.

Ambient Conditions:

Temperature:	20 °C
Rel. Humidity:	38 %

Summary of Results

Run #	Mode	Channel	Power Setting	Measured Power	Test Performed	Limit	Result / Margin
1	802.11a Legacy	5150-5250 Low	14dBm		Restricted Band Edge at 5150 MHz	15.209	73.1dBµV/m @ 5150MHz (-0.9dB)
	802.11a Legacy	5150-5250 Low	21dBm		Radiated Emissions, 1 - 40 GHz	FCC 15.209 / 15 E	56.8dBµV/m @ 10360.1MHz (-11.5dB)
	802.11a Legacy	5150-5250 Center	21dBm		Radiated Emissions, 1 - 40 GHz	FCC 15.209 / 15 E	59.0dBµV/m @ 10400.5MHz (-9.3dB)
	802.11a Legacy	5150-5250 High	21dBm		Radiated Emissions, 1 - 40 GHz	FCC 15.209 / 15 E	60.3dBµV/m @ 10480.0MHz (-8.0dB)
2	802.11a Legacy	5250-5350 Low	21dBm		Radiated Emissions, 1 - 40 GHz	FCC 15.209 / 15 E	59.4dBµV/m @ 10520.5MHz (-8.9dB)
	802.11a Legacy	5250-5350 Center	21dBm		Radiated Emissions, 1 - 40 GHz	FCC 15.209 / 15 E	70.6dBµV/m @ 10600.9MHz (-3.4dB)
	802.11a Legacy	5250-5350 High	21dBm		Radiated Emissions, 1 - 40 GHz	FCC 15.209 / 15 E	49.3dBµV/m @ 10640.4MHz (-4.7dB)
	802.11a Legacy	5250-5350 High	16.5dBm		Restricted Band Edge at 5350 MHz	15.209	53.6dBµV/m @ 5350.0MHz (-0.4dB)
3	802.11a Legacy	5470-5725 Low	19.5dBm		Restricted Band Edge at 5460 MHz	15.209	52.9dBµV/m @ 5459.8MHz (-1.1dB)
	802.11a Legacy	5470-5725 Low	21dBm		Radiated Emissions, 1 - 40 GHz	FCC 15.209 / 15 E	45.5dBµV/m @ 11001.1MHz (-8.5dB)
	802.11a Legacy	5470-5725 Center	21dBm		Radiated Emissions, 1 - 40 GHz	FCC 15.209 / 15 E	52.8dBµV/m @ 11160.2MHz (-1.2dB)
	802.11a Legacy	5470-5725 High	21dBm		Radiated Emissions, 1 - 40 GHz	FCC 15.209 / 15 E	43.5dBµV/m @ 11398.7MHz (-10.5dB)

Client:	Ruckus Wireless	Job Number:	J77250
Model:	7962	T-Log Number:	T77266
Contact:	Craig Owens	Account Manager:	Dean Eriksen
Standard:	FCC Part 15.E/RSS-210	Class:	N/A

Modifications Made During Testing

No modifications were made to the EUT during testing

Deviations From The Standard

No deviations were made from the requirements of the standard.

Run #1, Radiated Spurious Emissions, 30 - 40,000 MH. Operation in the 5150-5250 MHz Band

Date of Test: 2/9/2009 & 2/11/09
 Test Engineer: Joseph Cadigal/Rafael Varelas
 Test Location: SVOATS #1

Run #1a: Low Channel @ 5180 MHz

Fundamental Signal Field Strength

Frequency MHz	Level dB μ V/m	Pol v/h	15.209 / 15.247		Detector Pk/QP/Avg	Azimuth degrees	Height meters	Comments
			Limit	Margin				
5181.600	106.4	V	-	-	AVG	287	1.2	RB 1 MHz; VB: 10 Hz, 14dbm
5180.300	115.2	V	-	-	PK	287	1.2	RB 1 MHz; VB: 1 MHz, 14dbm
5182.570	98.2	H	-	-	AVG	358	1.4	RB 1 MHz; VB: 10 Hz, 21dBm
5182.730	107.6	H	-	-	PK	358	1.4	RB 1 MHz; VB: 1 MHz, 21dBm

5150 MHz Band Edge Signal Radiated Field Strength

Frequency MHz	Level dB μ V/m	Pol v/h	FCC 15.209		Detector Pk/QP/Avg	Azimuth degrees	Height meters	Comments
			Limit	Margin				
5149.900	52.7	V	54.0	-1.3	Avg	287	1.2	RB 1 MHz; VB: 10 Hz, 14dbm
5149.980	73.1	V	74.0	-0.9	PK	287	1.2	RB 1 MHz; VB: 1 MHz, 14dbm
5149.900	51.5	H	54.0	-2.5	Avg	358	1.4	RB 1 MHz; VB: 10 Hz, 21dBm
5149.880	67.5	H	74.0	-6.5	PK	358	1.4	RB 1 MHz; VB: 1 MHz, 21dBm

Spurious Radiated Emissions:

Power Setting = 21dbm

Frequency MHz	Level dB μ V/m	Pol v/h	15.209 / 15E		Detector Pk/QP/Avg	Azimuth degrees	Height meters	Comments
			Limit	Margin				
10360.130	56.8	V	68.3	-11.5	AVG	238	1.0	RB 1 MHz; VB: 10 Hz
10359.960	68.9	V	88.3	-19.4	PK	238	1.0	RB 1 MHz; VB: 1 MHz
10360.490	56.6	H	68.3	-11.7	AVG	163	1.1	RB 1 MHz; VB: 10 Hz
10360.120	68.6	H	88.3	-19.7	PK	163	1.1	RB 1 MHz; VB: 1 MHz

Note 1: For emissions in restricted bands, the limit of 15.209 was used. For all other emissions, the average limit was set to -27dBm/MHz (~68dBuV/m).

Client: Ruckus Wireless	Job Number: J77250
Model: 7962	T-Log Number: T77266
Contact: Craig Owens	Account Manager: Dean Eriksen
Standard: FCC Part 15.E/RSS-210	Class: N/A

Run #1a: Continued

Power = 14dBm

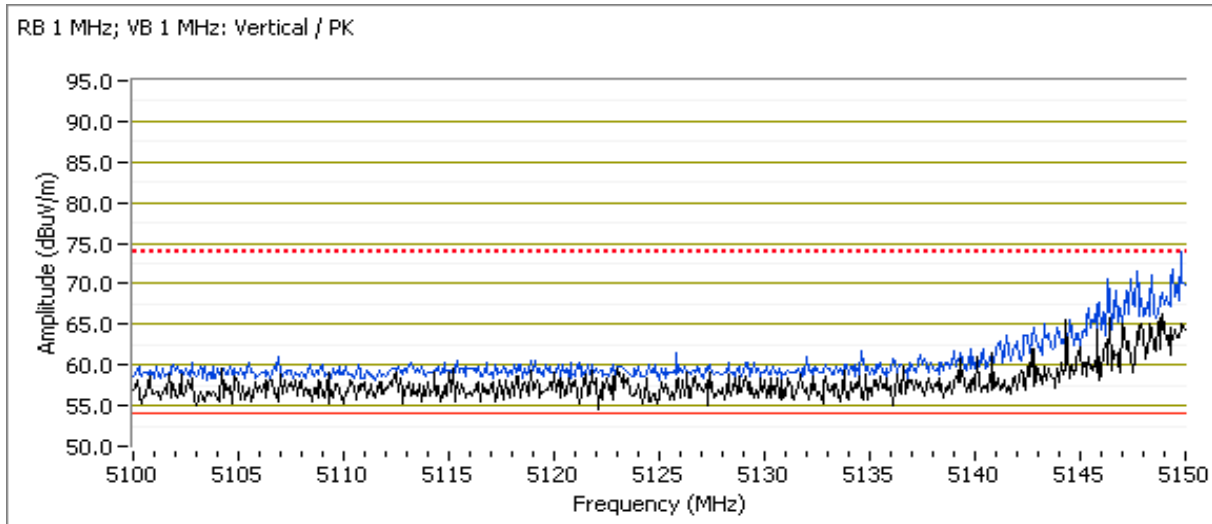
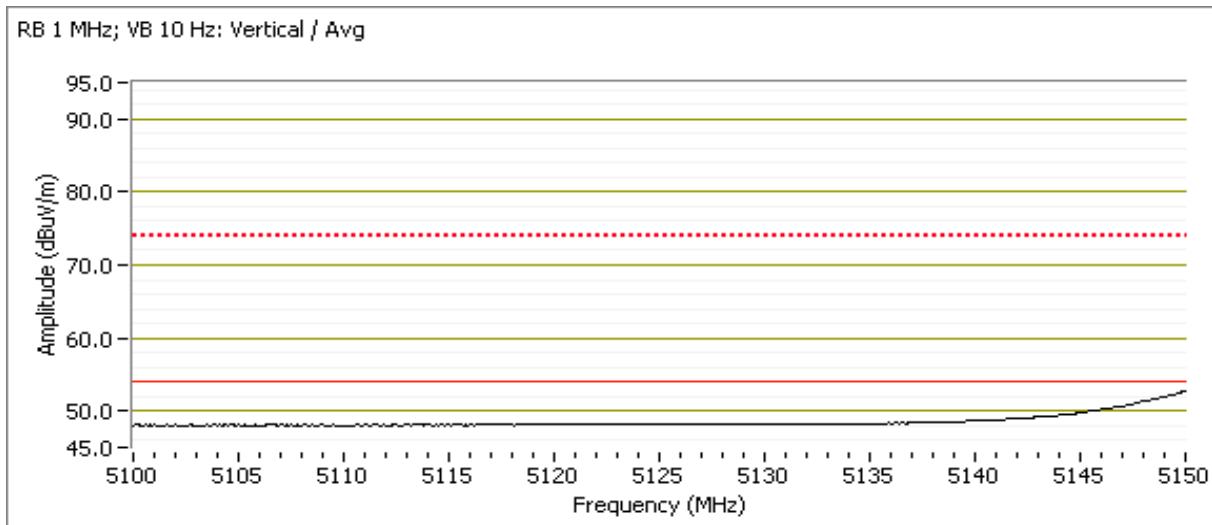

Client: Ruckus Wireless	Job Number: J77250
Model: 7962	T-Log Number: T77266
Contact: Craig Owens	Account Manager: Dean Eriksen
Standard: FCC Part 15.E/RSS-210	Class: N/A

Run #1a: Continued

Power = 21dBm

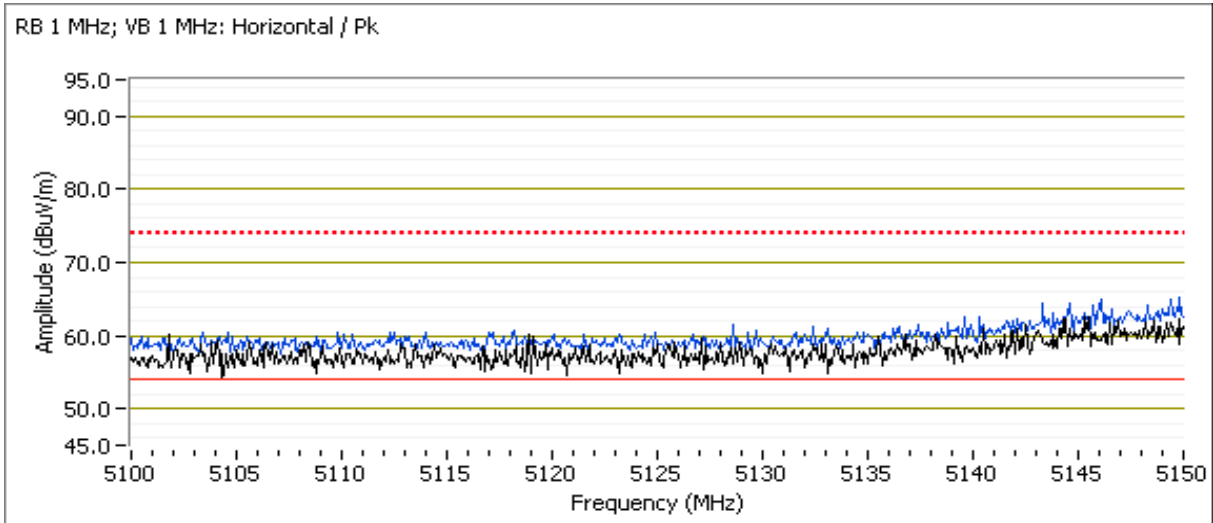
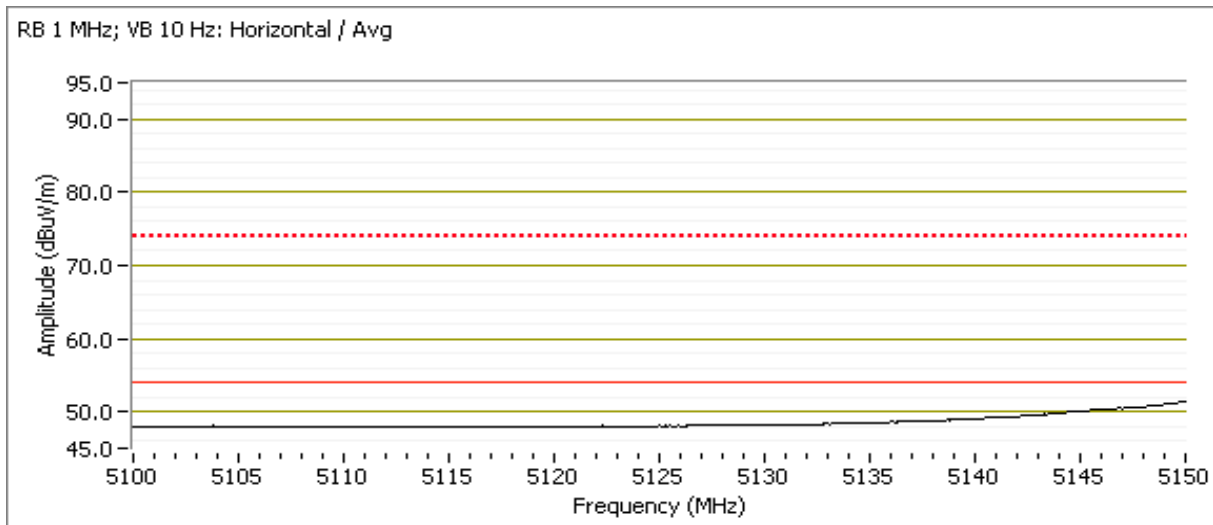

Client:	Ruckus Wireless	Job Number:	J77250
Model:	7962	T-Log Number:	T77266
Contact:	Craig Owens	Account Manager:	Dean Eriksen
Standard:	FCC Part 15.E/RSS-210	Class:	N/A

Run #1b: Center Channel

Date of Test: 2/9/2009
 Test Engineer: Joseph Cadigal
 Test Location: SVOATS #1

Spurious Radiated Emissions:

Power Setting = 21dbm

Frequency	Level	Pol	15.209 / 15E		Detector	Azimuth	Height	Comments
MHz	dB μ V/m	v/h	Limit	Margin	PK/QP/Avg	degrees	meters	
10400.510	59.0	V	68.3	-9.3	AVG	120	1.4	RB 1 MHz; VB: 10 Hz
10401.150	70.6	V	88.3	-17.7	PK	120	1.4	RB 1 MHz; VB: 1 MHz
10401.500	56.7	H	68.3	-11.6	AVG	163	1.1	RB 1 MHz; VB: 10 Hz
10399.420	68.3	H	88.3	-20.0	PK	163	1.1	RB 1 MHz; VB: 1 MHz

Note 1: For emissions in restricted bands, the limit of 15.209 was used. For all other emissions, the **average** limit was set to -27dBm/MHz (-68dB μ V/m).

Run #1c: High Channel @ 5240MHz

Spurious Radiated Emissions:

Power Setting = 21dbm

Frequency	Level	Pol	15.209 / 15E		Detector	Azimuth	Height	Comments
MHz	dB μ V/m	v/h	Limit	Margin	PK/QP/Avg	degrees	meters	
10480.000	60.3	V	68.3	-8.0	AVG	360	1.4	RB 1 MHz; VB: 10 Hz
10481.220	73.8	V	88.3	-14.5	PK	360	1.4	RB 1 MHz; VB: 1 MHz
10479.740	54.8	H	68.3	-13.5	AVG	162	1.1	RB 1 MHz; VB: 10 Hz
10478.760	67.0	H	88.3	-21.3	PK	162	1.1	RB 1 MHz; VB: 1 MHz

Client:	Ruckus Wireless	Job Number:	J77250
Model:	7962	T-Log Number:	T77266
Contact:	Craig Owens	Account Manager:	Dean Eriksen
Standard:	FCC Part 15.E/RSS-210	Class:	N/A

Run #2, Radiated Spurious Emissions, 30 - 40,000 MH. Operation in the 5250-5350 MHz Band

Run #2a: Low Channel 5260 MHz

Power Setting = 21dbm

Date of Test: 2/9/2009

Test Engineer: Joseph Cadigal

Test Location: SVOATS #1

Spurious Radiated Emissions:

Note: If device is not for indoor use only then measure 5250 MHz band edge to comply with -68.3dBuV/m limit

Frequency	Level	Pol	15.209 / 15E		Detector	Azimuth	Height	Comments
MHz	dB μ V/m	v/h	Limit	Margin	Pk/QP/Avg	degrees	meters	
10520.510	59.4	V	68.3	-8.9	AVG	360	1.7	RB 1 MHz; VB: 10 Hz
10520.890	73.0	V	88.3	-15.3	PK	360	1.7	RB 1 MHz; VB: 1 MHz
10518.670	56.1	H	68.3	-12.2	AVG	199	1.1	RB 1 MHz; VB: 10 Hz
10521.460	69.7	H	88.3	-18.6	PK	199	1.1	RB 1 MHz; VB: 1 MHz

Note 1: For emissions in restricted bands, the limit of 15.209 was used. For all other emissions, the **average** limit was set to -27dBm/MHz (-68dBuV/m).

Run #2b: Center Channel

Power Setting = 21dbm

5300MHz

Date of Test: 2/10/2009

Test Engineer: Joseph Cadigal

Test Location: SVOATS #1

Spurious Radiated Emissions:

Frequency	Level	Pol	15.209 / 15E		Detector	Azimuth	Height	Comments
MHz	dB μ V/m	v/h	Limit	Margin	Pk/QP/Avg	degrees	meters	
10600.120	47.5	H	54.0	-6.5	AVG	104	1.1	RB 1 MHz; VB: 10 Hz
10600.620	59.9	H	74.0	-14.1	PK	104	1.1	RB 1 MHz; VB: 1 MHz
10599.050	56.4	V	68.3	-11.9	AVG	0	1.3	RB 1 MHz; VB: 10 Hz
10600.930	70.6	V	74.0	-3.4	PK	0	1.3	RB 1 MHz; VB: 1 MHz

Note 1: For emissions in restricted bands, the limit of 15.209 was used. For all other emissions, the **average** limit was set to -

Client:	Ruckus Wireless	Job Number:	J77250
Model:	7962	T-Log Number:	T77266
Contact:	Craig Owens	Account Manager:	Dean Eriksen
Standard:	FCC Part 15.E/RSS-210	Class:	N/A

Run #2c: High Channel

5320MHz

Date of Test: 2/9/2009 & 2/11/09

Test Engineer: Joseph Cadigal/Rafael Varelas

Test Location: SVOATS #1

Fundamental Signal Field Strength

Frequency	Level	Pol	15.209 / 15.247		Detector	Azimuth	Height	Comments
MHz	dB μ V/m	v/h	Limit	Margin	Pk/QP/Avg	degrees	meters	
5318.170	106.7	V	-	-	AVG	291	1.3	RB 1 MHz; VB: 10 Hz
5315.830	115.0	V	-	-	PK	291	1.3	RB 1 MHz; VB: 1 MHz
5318.730	95.3	H	-	-	AVG	55	1.3	RB 1 MHz; VB: 10 Hz
5322.270	104.0	H	-	-	PK	55	1.3	RB 1 MHz; VB: 1 MHz

5350 MHz Band Edge Signal Radiated Field Strength

Frequency	Level	Pol	FCC 15.209		Detector	Azimuth	Height	Comments
MHz	dB μ V/m	v/h	Limit	Margin	Pk/QP/Avg	degrees	meters	
5350.000	53.6	V	54.0	-0.4	Avg	291	1.3	RB 1 MHz; VB: 10 Hz
5350.260	70.6	V	74.0	-3.4	PK	291	1.3	RB 1 MHz; VB: 1 MHz
5350.000	49.3	H	54.0	-4.7	Avg	55	1.3	RB 1 MHz; VB: 10 Hz
5351.360	62.8	H	74.0	-11.2	PK	55	1.3	RB 1 MHz; VB: 1 MHz

Spurious Radiated Emissions:

Frequency	Level	Pol	15.209 / 15E		Detector	Azimuth	Height	Comments
MHz	dB μ V/m	v/h	Limit	Margin	Pk/QP/Avg	degrees	meters	
10640.360	49.3	V	54.0	-4.7	AVG	180	1.1	RB 1 MHz; VB: 10 Hz
10641.080	63.4	V	74.0	-10.6	PK	180	1.1	RB 1 MHz; VB: 1 MHz
10640.120	47.5	H	54.0	-6.5	AVG	104	1.1	RB 1 MHz; VB: 10 Hz
10640.620	59.9	H	74.0	-14.1	PK	104	1.1	RB 1 MHz; VB: 1 MHz

Note 1: For emissions in restricted bands, the limit of 15.209 was used. For all other emissions, the **average** limit was set to -

Client: Ruckus Wireless	Job Number: J77250
Model: 7962	T-Log Number: T77266
Contact: Craig Owens	Account Manager: Dean Eriksen
Standard: FCC Part 15.E/RSS-210	Class: N/A

Run #2c: Continued

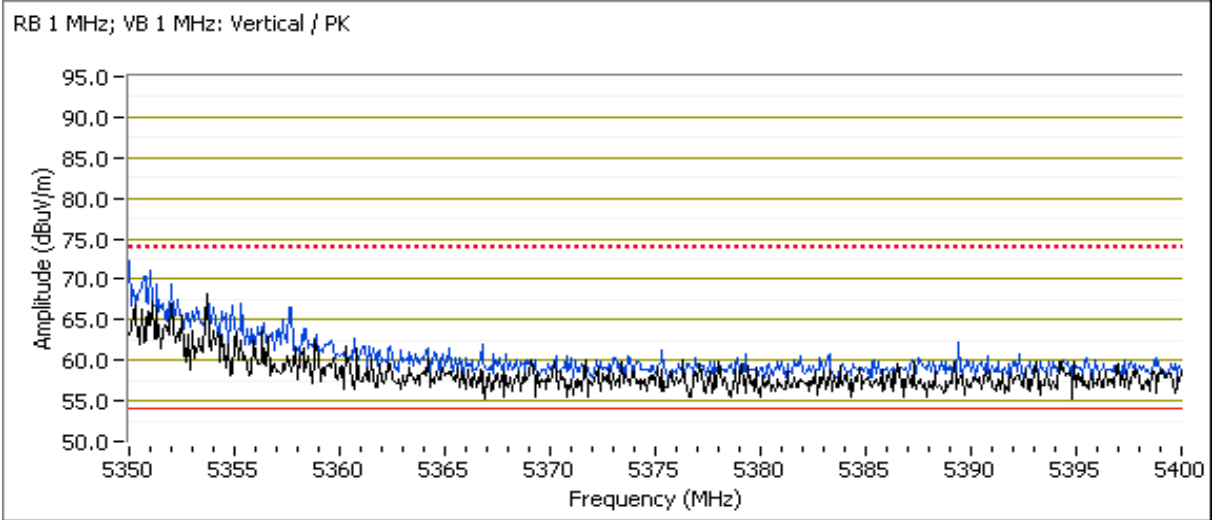
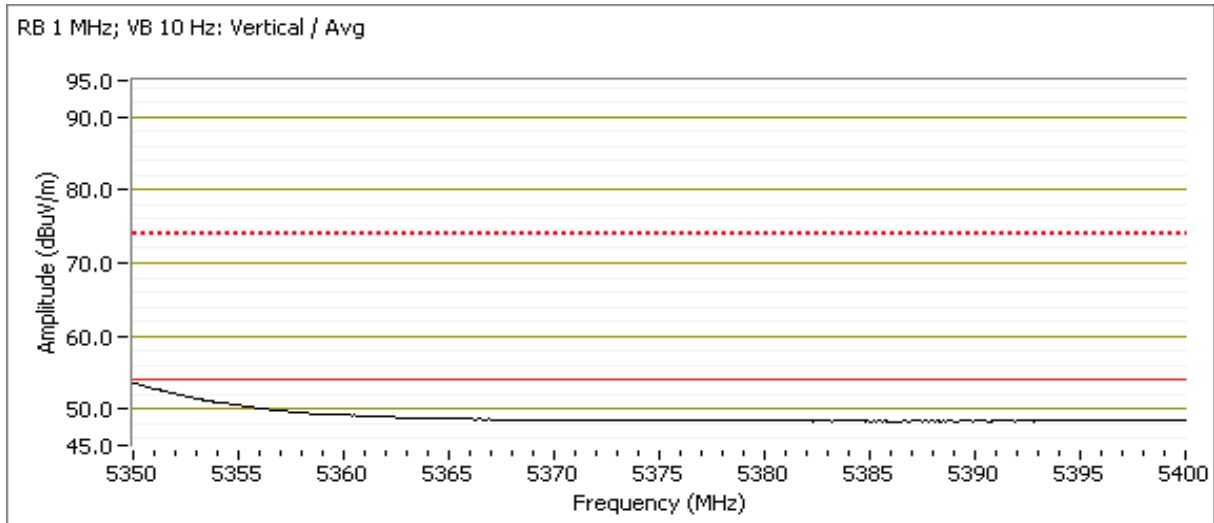

Client: Ruckus Wireless	Job Number: J77250
Model: 7962	T-Log Number: T77266
Contact: Craig Owens	Account Manager: Dean Eriksen
Standard: FCC Part 15.E/RSS-210	Class: N/A

Run #2c: Continued

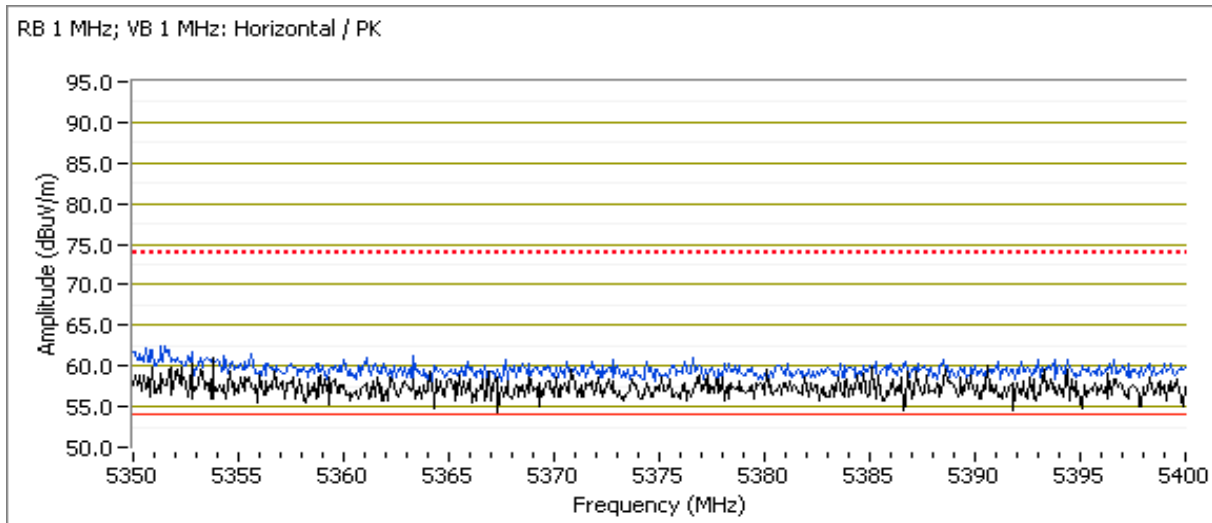
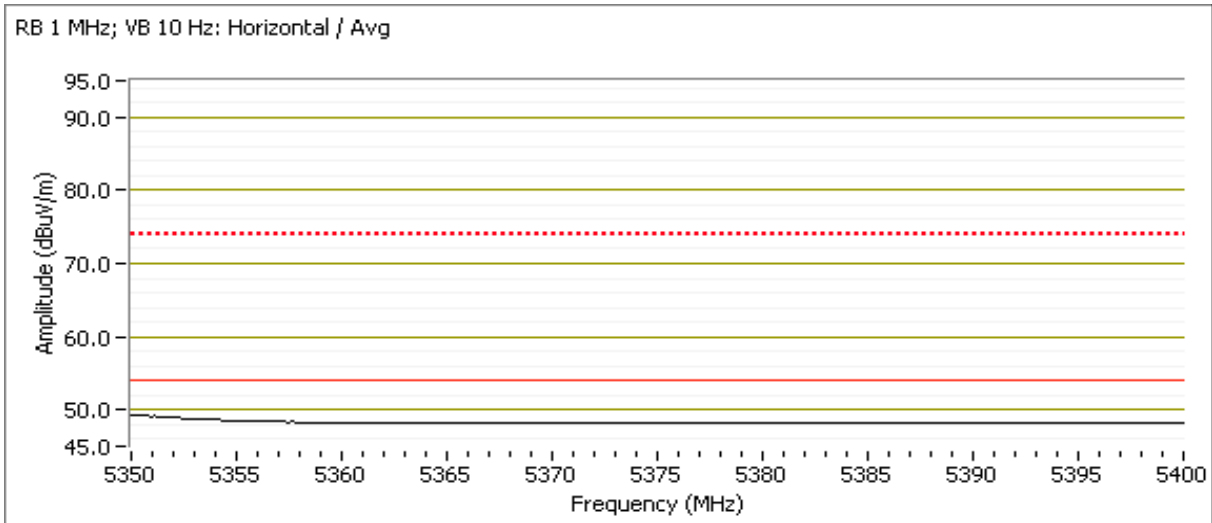

Client:	Ruckus Wireless	Job Number:	J77250
Model:	7962	T-Log Number:	T77266
Contact:	Craig Owens	Account Manager:	Dean Eriksen
Standard:	FCC Part 15.E/RSS-210	Class:	N/A

Run #3, Radiated Spurious Emissions, 30 - 40,000 MH. Operation in the 5470-5725 MHz Band
Run #3a: Low Channel

Date of Test: 2/9/2009 & 2/11/09
 Test Engineer: Joseph Cadigal/Rafael Varelas
 Test Location: SVOATS #1

Fundamental Signal Field Strength

Frequency	Level	Pol	15.209 / 15.247		Detector	Azimuth	Height	Comments
MHz	dB μ V/m	v/h	Limit	Margin	PK/QP/Avg	degrees	meters	
5501.630	112.6	V	-	-	AVG	265	1.0	RB 1 MHz; VB: 10 Hz
5502.900	121.9	V	-	-	PK	265	1.0	RB 1 MHz; VB: 1 MHz
5506.130	98.8	H	-	-	AVG	154	1.6	RB 1 MHz; VB: 10 Hz
5504.530	107.0	H	-	-	PK	154	1.6	RB 1 MHz; VB: 1 MHz

5350-5460 MHz Restricted Band Edge Signal Radiated Field Strength

Frequency	Level	Pol	FCC 15.209		Detector	Azimuth	Height	Comments
MHz	dB μ V/m	v/h	Limit	Margin	PK/QP/Avg	degrees	meters	
5459.830	52.9	V	54.0	-1.1	Avg	265	1.0	RB 1 MHz; VB: 10 Hz, 19.5dBm
5459.170	70.7	V	74.0	-3.3	PK	265	1.0	RB 1 MHz; VB: 1 MHz
5458.650	48.7	H	54.0	-5.3	Avg	154	1.6	RB 1 MHz; VB: 10 Hz
5459.970	61.0	H	74.0	-13.0	PK	154	1.6	RB 1 MHz; VB: 1 MHz

5460 - 5470 MHz Band Edge Radiated Field Strength

Frequency	Level	Pol	15 E		Detector	Azimuth	Height	Comments
MHz	dB μ V/m	v/h	Limit	Margin	PK/QP/Avg	degrees	meters	
5469.900	58.3	V	68.3	-10.0	Avg	265	1.0	RB 1 MHz; VB: 10 Hz
5469.400	75.5	V	88.3	-12.8	PK	265	1.0	RB 1 MHz; VB: 1 MHz
5469.710	49.7	H	68.3	-18.6	Avg	154	1.6	RB 1 MHz; VB: 10 Hz
5467.940	65.1	H	88.3	-23.2	PK	154	1.6	RB 1 MHz; VB: 1 MHz

Spurious Radiated Emissions:

Frequency	Level	Pol	15.209 / 15E		Detector	Azimuth	Height	Comments
MHz	dB μ V/m	v/h	Limit	Margin	PK/QP/Avg	degrees	meters	
11001.110	45.5	V	54.0	-8.5	AVG	335	1.1	RB 1 MHz; VB: 10 Hz
11000.790	58.0	V	74.0	-16.0	PK	335	1.1	RB 1 MHz; VB: 1 MHz
11001.430	44.4	H	54.0	-9.6	AVG	270	1.1	RB 1 MHz; VB: 10 Hz
10999.080	56.2	H	74.0	-17.8	PK	270	1.1	RB 1 MHz; VB: 1 MHz

Note 1: For emissions in restricted bands, the limit of 15.209 was used. For all other emissions, the average limit was set to -

Client: Ruckus Wireless	Job Number: J77250
Model: 7962	T-Log Number: T77266
Contact: Craig Owens	Account Manager: Dean Eriksen
Standard: FCC Part 15.E/RSS-210	Class: N/A

Run #3a: Continued

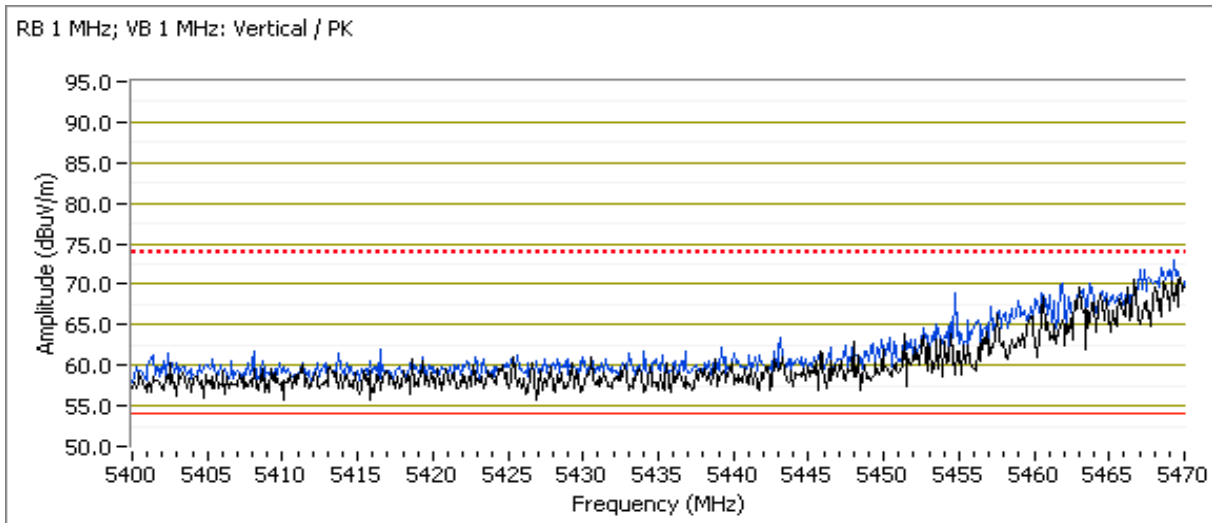
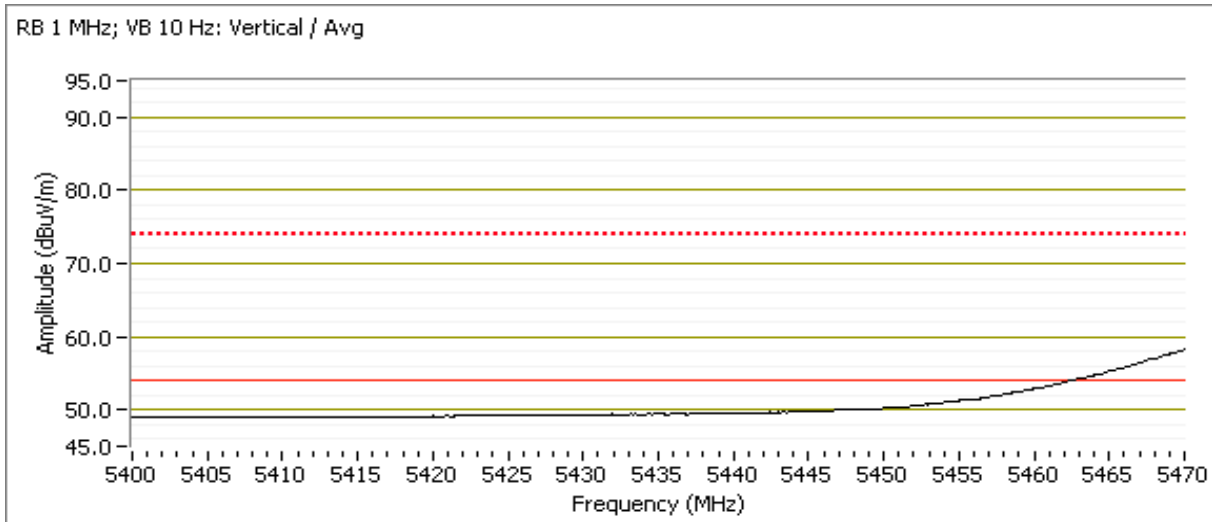

Client:	Ruckus Wireless	Job Number:	J77250
Model:	7962	T-Log Number:	T77266
Contact:	Craig Owens	Account Manager:	Dean Eriksen
Standard:	FCC Part 15.E/RSS-210	Class:	N/A

Run #3a: Continued

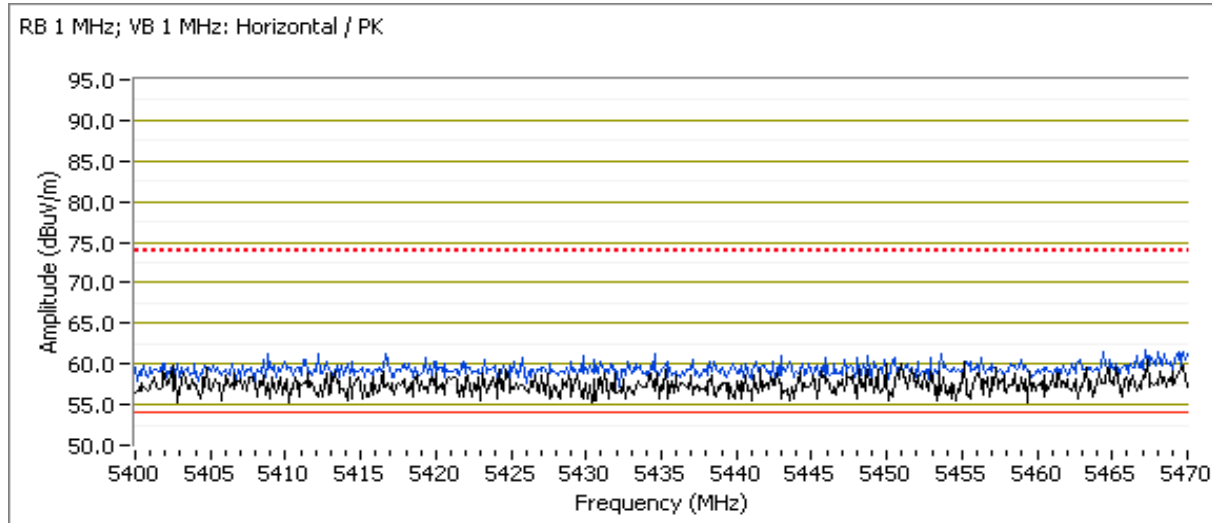
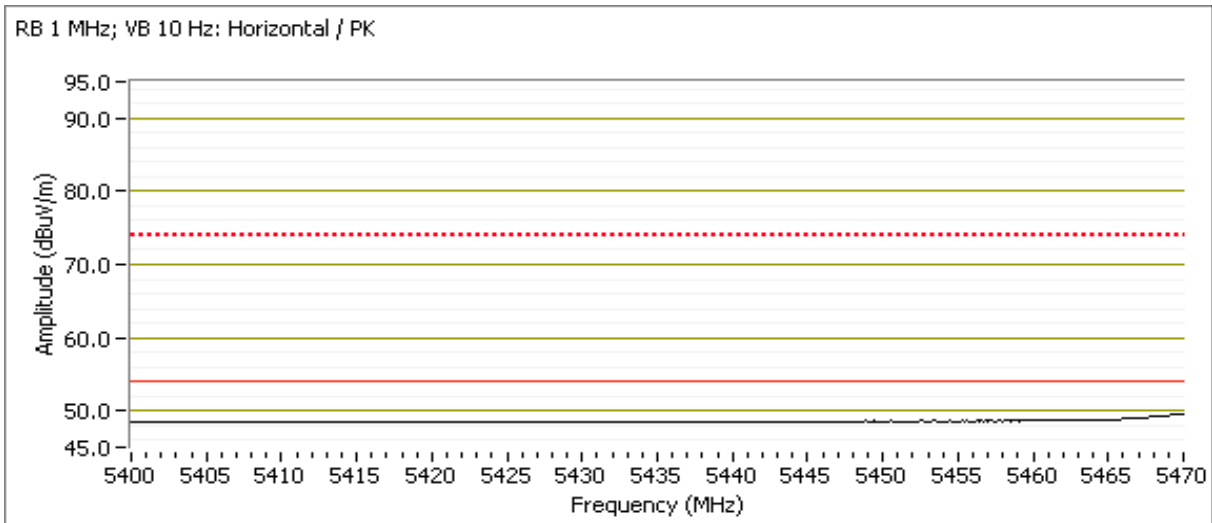

Client: Ruckus Wireless	Job Number: J77250
Model: 7962	T-Log Number: T77266
Contact: Craig Owens	Account Manager: Dean Eriksen
Standard: FCC Part 15.E/RSS-210	Class: N/A

Run #3b: Center Channel

5580MHz

Date of Test: 10/29/2009
Test Engineer: Suhaila Khushzad
Test Location: OATS #2

Spurious Radiated Emissions:

Frequency MHz	Level dB μ V/m	Pol v/h	15.209 / 15E		Detector Pk/QP/Avg	Azimuth degrees	Height meters	Comments
			Limit	Margin				
11160.200	52.8	H	54.0	-1.2	AVG	321	1.3	RB 1 MHz; VB: 10 Hz
11159.670	51.2	V	54.0	-2.8	AVG	86	1.1	RB 1 MHz; VB: 10 Hz
11159.400	63.7	H	74.0	-10.3	PK	321	1.3	RB 1 MHz; VB: 1 MHz
11159.200	62.2	V	74.0	-11.8	PK	86	1.1	RB 1 MHz; VB: 1 MHz
16739.070	53.0	V	68.3	-15.3	AVG	67	1.1	RB 1 MHz; VB: 10 Hz
16741.830	48.1	H	68.3	-20.2	AVG	244	1.0	RB 1 MHz; VB: 10 Hz
16728.530	65.6	V	88.3	-22.7	PK	67	1.1	RB 1 MHz; VB: 1 MHz
16750.670	60.0	H	88.3	-28.3	PK	244	1.0	RB 1 MHz; VB: 1 MHz

Note 1: For emissions in restricted bands, the limit of 15.209 was used. For all other emissions, the **average** limit was set to -27dBm/MHz (~68dB μ V/m).

Run #3c: High Channel

5700MHz

Date of Test: 2/10/2009
Test Engineer: Joseph Cadigal
Test Location: SVOATS #1

Spurious Radiated Emissions:

Frequency MHz	Level dB μ V/m	Pol v/h	15.209 / 15E		Detector Pk/QP/Avg	Azimuth degrees	Height meters	Comments
			Limit	Margin				
11398.690	43.5	V	54.0	-10.5	AVG	172	1.1	RB 1 MHz; VB: 10 Hz
11398.600	54.7	V	74.0	-19.3	PK	172	1.1	RB 1 MHz; VB: 1 MHz
11398.540	43.5	H	54.0	-10.5	AVG	200	1.1	RB 1 MHz; VB: 10 Hz
11401.080	54.4	H	74.0	-19.6	PK	200	1.1	RB 1 MHz; VB: 1 MHz

Note 1: For emissions in restricted bands, the limit of 15.209 was used. For all other emissions, the **average** limit was set to -27dBm/MHz (~68dB μ V/m).

Client:	Ruckus Wireless	Job Number:	J77250
Model:	7962	T-Log Number:	T77266
		Account Manager:	Dean Eriksen
Contact:	Craig Owens		
Standard:	FCC Part 15.E/RSS-210	Class:	N/A

RSS 210 and FCC 15.407 (UNII) Radiated Spurious Emissions

Test Specific Details

Objective: The objective of this test session is to perform final qualification testing of the EUT with respect to the specification listed above.

Date of Test: Refer to individual run	Config. Used: 1
Test Engineer: Refer to individual run	Config Change: none
Test Location: Refer to individual run	EUT Voltage: 120V/60Hz

General Test Configuration

The EUT and all local support equipment were located on the turntable for radiated spurious emissions testing. For radiated emissions testing the measurement antenna was located 3 meters from the EUT.

Ambient Conditions:

Temperature:	20 °C
Rel. Humidity:	38 %

Summary of Results

Run #	Mode	Channel	Power Setting	Measured Power	Test Performed	Limit	Result / Margin
1	802.11a Legacy	5150-5250 Low	14dBm		Restricted Band Edge at 5150 MHz	15.209	53.9dBµV/m @ 5150.0MHz (-0.1dB)
	802.11a Legacy	5150-5250 Low	21dBm		Radiated Emissions, 1 - 40 GHz	FCC 15.209 / 15 E	56.6dBµV/m @ 10359.5MHz (-11.7dB)
	802.11a Legacy	5150-5250 Center	21dBm		Radiated Emissions, 1 - 40 GHz	FCC 15.209 / 15 E	58.8dBµV/m @ 10401.3MHz (-9.5dB)
	802.11a Legacy	5150-5250 High	21dBm		Radiated Emissions, 1 - 40 GHz	FCC 15.209 / 15 E	59.9dBµV/m @ 10479.9MHz (-8.4dB)
2	802.11a Legacy	5250-5350 Low	21dBm		Radiated Emissions, 1 - 40 GHz	FCC 15.209 / 15 E	65.2dBµV/m @ 10360.9MHz (-3.1dB)
	802.11a Legacy	5250-5350 Center	21dBm		Radiated Emissions, 1 - 40 GHz	FCC 15.209 / 15 E	56.2dBµV/m @ 10599.0MHz (-12.1dB)
	802.11a Legacy	5250-5350 High	21dBm		Radiated Emissions, 1 - 40 GHz	FCC 15.209 / 15 E	49.0dBµV/m @ 10639.1MHz (-5.0dB)
	802.11a Legacy	5250-5350 High	16dBm		Restricted Band Edge at 5350 MHz	15.209	53.9dBµV/m @ 5350.0MHz (-0.1dB)
3	802.11a Legacy	5470-5725 Low	19.5dBm		Restricted Band Edge at 5460 MHz	15.209	53.8dBµV/m @ 5460.0MHz (-0.2dB)
	802.11a Legacy	5470-5725 Low	21dBm		Radiated Emissions, 1 - 40 GHz	FCC 15.209 / 15 E	41.7dBµV/m @ 11000.2MHz (-12.3dB)
	802.11a Legacy	5470-5725 Center	21dBm		Radiated Emissions, 1 - 40 GHz	FCC 15.209 / 15 E	N/A - Worse Case was 802.11a Legacy
	802.11a Legacy	5470-5725 High	21dBm		Radiated Emissions, 1 - 40 GHz	FCC 15.209 / 15 E	43.5dBµV/m @ 11398.6MHz (-10.5dB)

Client:	Ruckus Wireless	Job Number:	J77250
Model:	7962	T-Log Number:	T77266
Contact:	Craig Owens	Account Manager:	Dean Eriksen
Standard:	FCC Part 15.E/RSS-210	Class:	N/A

Modifications Made During Testing

No modifications were made to the EUT during testing

Deviations From The Standard

No deviations were made from the requirements of the standard.

Preliminary testing showed that 802.11a Legacy was worse case mode for center channel emissions in the 5470-5725 MHz band. No testing performed at 5580 MHz for 802.11 HT20.

Run #1, Radiated Spurious Emissions, 30 - 40,000 MH. Operation in the 5150-5250 MHz Band

Power Setting = 21dbm

11n MCS0 HT20 mode

Date of Test: 2/10/2009 & 2/11/09

Test Engineer: Joseph Cadigal/Rafael Varelas

Test Location: SVOATS #1

Run #1a: Low Channel @ 5180 MHz

Fundamental Signal Field Strength

Frequency	Level	Pol	15.209 / 15.247		Detector	Azimuth	Height	Comments
MHz	dB μ V/m	v/h	Limit	Margin	Pk/QP/Avg	degrees	meters	
5181.630	106.0	V	-	-	AVG	287	1.2	RB 1 MHz; VB: 10 Hz, 14dbm
5184.170	114.5	V	-	-	PK	287	1.2	RB 1 MHz; VB: 1 MHz, 14dbm
5182.930	98.3	H	-	-	AVG	358	1.4	RB 1 MHz; VB: 10 Hz, 21dBm
5181.130	106.7	H	-	-	PK	358	1.4	RB 1 MHz; VB: 1 MHz, 21dBm

5150 MHz Band Edge Signal Radiated Field Strength

Frequency	Level	Pol	FCC 15.209		Detector	Azimuth	Height	Comments
MHz	dB μ V/m	v/h	Limit	Margin	Pk/QP/Avg	degrees	meters	
5149.970	53.9	V	54.0	-0.1	Avg	287	1.2	RB 1 MHz; VB: 10 Hz, 14dbm
5147.440	72.0	V	74.0	-2.0	PK	287	1.2	RB 1 MHz; VB: 1 MHz, 14dbm
5149.940	51.9	H	54.0	-2.1	Avg	358	1.4	RB 1 MHz; VB: 10 Hz, 21dBm
5150.330	67.7	H	74.0	-6.3	PK	358	1.4	RB 1 MHz; VB: 1 MHz, 21dBm

Client: Ruckus Wireless	Job Number: J77250
Model: 7962	T-Log Number: T77266
Contact: Craig Owens	Account Manager: Dean Eriksen
Standard: FCC Part 15.E/RSS-210	Class: N/A

Power = 14dBm

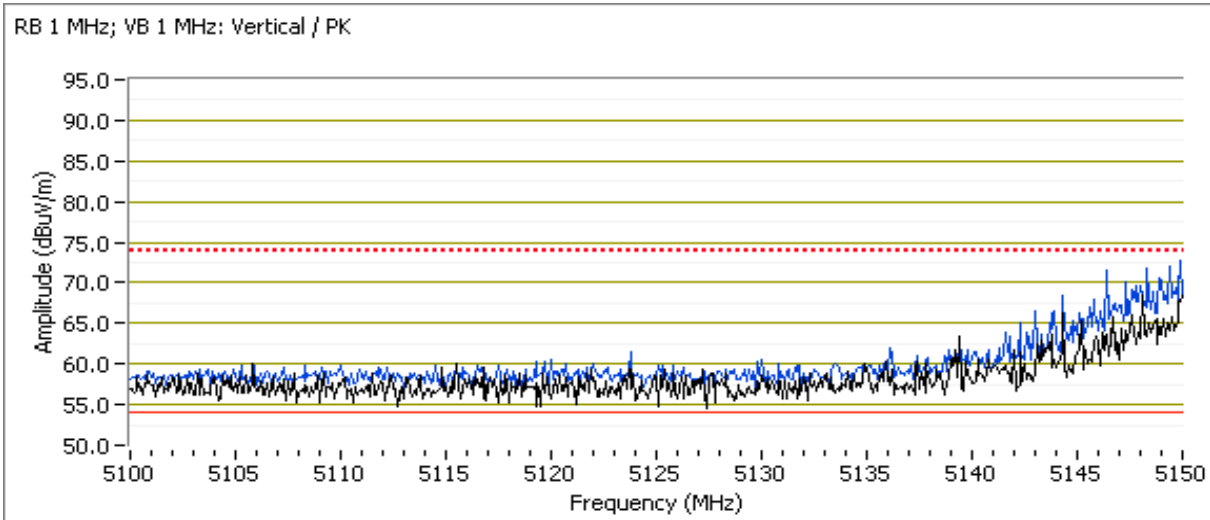
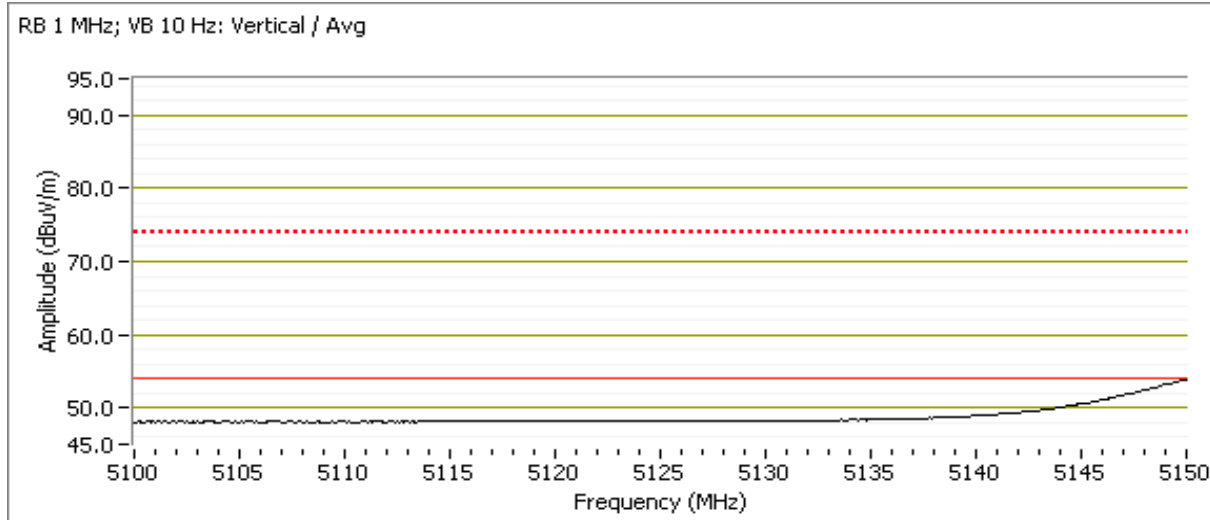

Client: Ruckus Wireless	Job Number: J77250
Model: 7962	T-Log Number: T77266
Contact: Craig Owens	Account Manager: Dean Eriksen
Standard: FCC Part 15.E/RSS-210	Class: N/A

Power = 21dBm

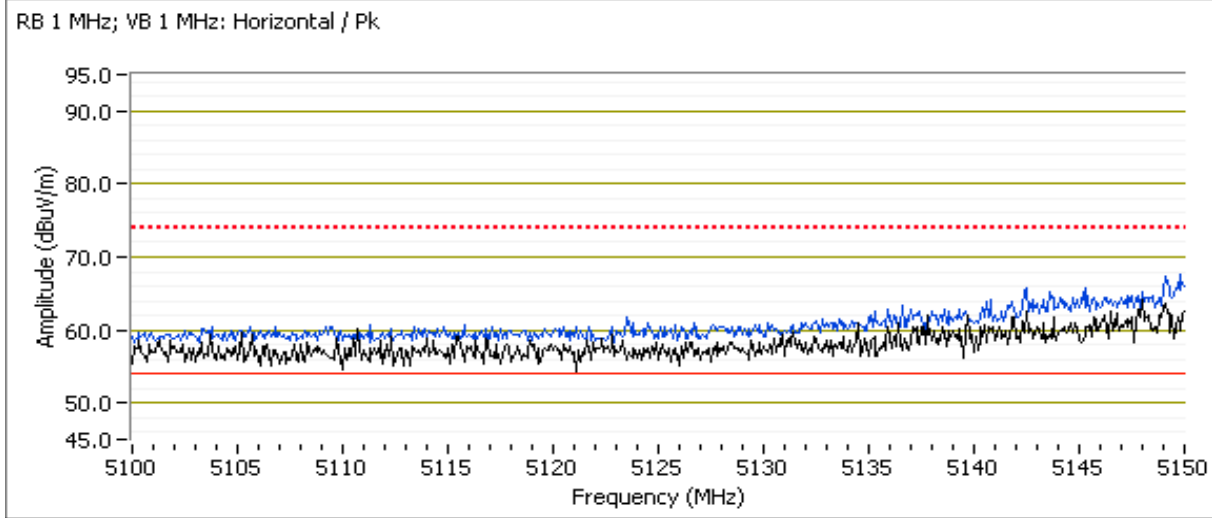
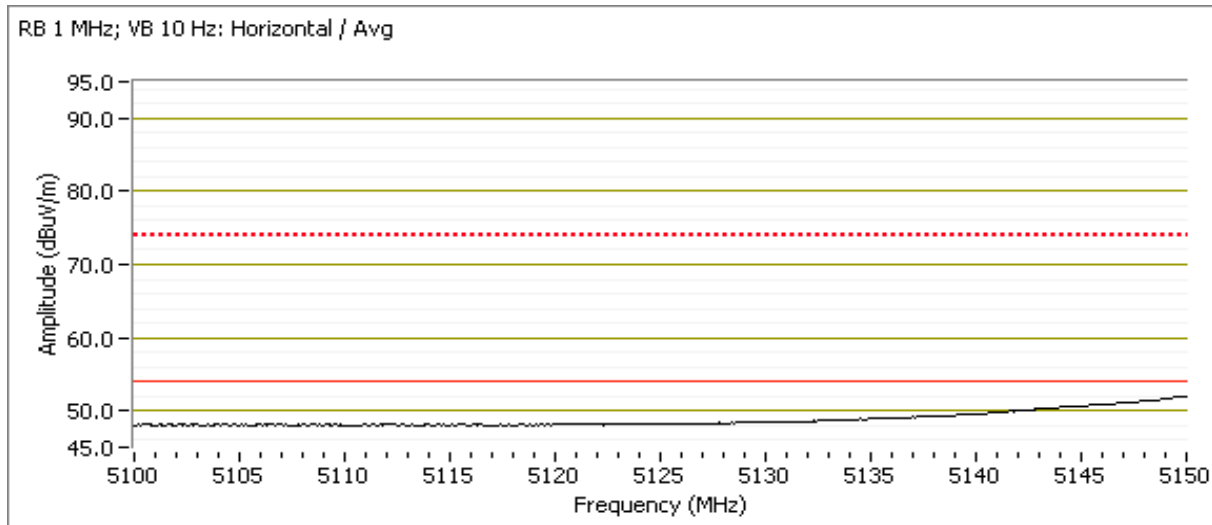



EMC Test Data

Client:	Ruckus Wireless	Job Number:	J77250
Model:	7962	T-Log Number:	T77266
Contact:	Craig Owens	Account Manager:	Dean Eriksen
Standard:	FCC Part 15.E/RSS-210	Class:	N/A

Spurious Radiated Emissions:

Power Setting = 21dbm

Frequency MHz	Level dB μ V/m	Pol v/h	15.209 / 15E		Detector Pk/QP/Avg	Azimuth degrees	Height meters	Comments
			Limit	Margin				
10359.530	56.6	V	68.3	-11.7	AVG	238	1.0	RB 1 MHz; VB: 10 Hz
10358.870	68.7	V	88.3	-19.6	PK	238	1.0	RB 1 MHz; VB: 1 MHz
10361.080	56.3	H	68.3	-12.0	AVG	163	1.1	RB 1 MHz; VB: 10 Hz
10360.740	68.6	H	88.3	-19.7	PK	163	1.1	RB 1 MHz; VB: 1 MHz

Note 1: For emissions in restricted bands, the limit of 15.209 was used. For all other emissions, the **average** limit was set to -27dBm/MHz (-68dBuV/m).

Run #1a: Center Channel

5200MHz

Date of Test: 2/10/2009

Test Engineer: Joseph Cadigal

Test Location: SVOATS #1

Spurious Radiated Emissions:

Power Setting = 21dbm

Frequency MHz	Level dB μ V/m	Pol v/h	15.209 / 15E		Detector Pk/QP/Avg	Azimuth degrees	Height meters	Comments
			Limit	Margin				
10401.250	58.8	V	68.3	-9.5	AVG	120	1.4	RB 1 MHz; VB: 10 Hz
10399.580	70.0	V	88.3	-18.3	PK	120	1.4	RB 1 MHz; VB: 1 MHz
10400.820	57.1	H	68.3	-11.2	AVG	163	1.1	RB 1 MHz; VB: 10 Hz
10401.140	69.1	H	88.3	-19.2	PK	163	1.1	RB 1 MHz; VB: 1 MHz

Note 1: For emissions in restricted bands, the limit of 15.209 was used. For all other emissions, the **average** limit was set to -27dBm/MHz (-68dBuV/m).

Run #1a: High Channel @ 5240MHz

Spurious Radiated Emissions:

Power Setting = 21dbm

Frequency MHz	Level dB μ V/m	Pol v/h	15.209 / 15E		Detector Pk/QP/Avg	Azimuth degrees	Height meters	Comments
			Limit	Margin				
10479.890	59.9	V	68.3	-8.4	AVG	360	1.4	RB 1 MHz; VB: 10 Hz
10479.850	72.7	V	88.3	-15.6	PK	360	1.4	RB 1 MHz; VB: 1 MHz
10479.620	54.4	H	68.3	-13.9	AVG	166	1.1	RB 1 MHz; VB: 10 Hz
10478.510	66.3	H	88.3	-22.0	PK	166	1.1	RB 1 MHz; VB: 1 MHz

Client:	Ruckus Wireless	Job Number:	J77250
Model:	7962	T-Log Number:	T77266
Contact:	Craig Owens	Account Manager:	Dean Eriksen
Standard:	FCC Part 15.E/RSS-210	Class:	N/A

Run #1c: High Channel @ 5260 MHz

Date of Test: 2/10/2009
 Test Engineer: Joseph Cadigal
 Test Location: SVOATS #1

Spurious Radiated Emissions:

Power Setting = 17dbm

Frequency MHz	Level dB μ V/m	Pol v/h	15.209 / 15E		Detector Pk/QP/Avg	Azimuth degrees	Height meters	Comments
			Limit	Margin				
10519.590	58.8	V	68.3	-9.5	AVG	360	1.7	RB 1 MHz; VB: 10 Hz
10519.670	71.6	V	88.3	-16.7	PK	360	1.7	RB 1 MHz; VB: 1 MHz
10518.610	55.7	H	68.3	-12.6	AVG	198	1.1	RB 1 MHz; VB: 10 Hz
10521.410	69.5	H	88.3	-18.8	PK	198	1.1	RB 1 MHz; VB: 1 MHz

Note 1: For emissions in restricted bands, the limit of 15.209 was used. For all other emissions, the **average** limit was set to -27dBm/MHz (~68dBuV/m).

Run #2, Radiated Spurious Emissions, 30 - 40,000 MH. Operation in the 5250-5350 MHz Band, MCS0, HT20

Run #2a: Low Channel

Power Setting = 21dbm

5260MHz

Date of Test: 2/10/2009
 Test Engineer: Joseph Cadigal
 Test Location: SVOATS #1

Spurious Radiated Emissions:

Note: If device is not for indoor use only then measure 5250 MHz band edge to comply with -68.3dBuV/m limit

Frequency MHz	Level dB μ V/m	Pol v/h	15.209 / 15E		Detector Pk/QP/Avg	Azimuth degrees	Height meters	Comments
			Limit	Margin				
10360.940	65.2	H	68.3	-3.1	AVG	332	1.2	RB 1 MHz; VB: 10 Hz
10360.170	77.8	H	88.3	-10.5	PK	332	1.2	RB 1 MHz; VB: 1 MHz
10361.300	57.9	V	68.3	-10.4	AVG	184	1.0	RB 1 MHz; VB: 10 Hz
10359.990	69.9	V	88.3	-18.4	PK	184	1.0	RB 1 MHz; VB: 1 MHz

Note 1: For emissions in restricted bands, the limit of 15.209 was used. For all other emissions, the **average** limit was set to -27dBm/MHz (~68dBuV/m).

Client:	Ruckus Wireless	Job Number:	J77250
Model:	7962	T-Log Number:	T77266
Contact:	Craig Owens	Account Manager:	Dean Eriksen
Standard:	FCC Part 15.E/RSS-210	Class:	N/A

Run #2b: Center Channel
Power Setting = 21dbm

Date of Test: 2/10/2009
Test Engineer: Joseph Cadigal
Test Location: SVOATS #1

Spurious Radiated Emissions:

Frequency	Level	Pol	15.209 / 15E		Detector	Azimuth	Height	Comments
MHz	dB μ V/m	v/h	Limit	Margin	Pk/QP/Avg	degrees	meters	
10599.000	56.2	V	68.3	-12.1	AVG	0	1.3	RB 1 MHz; VB: 10 Hz
10599.250	68.9	V	88.3	-19.4	PK	0	1.3	RB 1 MHz; VB: 1 MHz
10599.830	52.1	H	68.3	-16.2	AVG	358	1.1	RB 1 MHz; VB: 10 Hz
10598.880	63.3	H	88.3	-25.0	PK	358	1.1	RB 1 MHz; VB: 1 MHz

Note 1: For emissions in restricted bands, the limit of 15.209 was used. For all other emissions, the **average** limit was set to -27dBm/MHz (-68dB μ V/m).

Run #2c: High Channel

Date of Test: 2/10/2009 & 2/11/09
Test Engineer: Joseph Cadigal/Rafael Varelas
Test Location: SVOATS #1

Fundamental Signal Field Strength

Frequency	Level	Pol	15.209 / 15.247		Detector	Azimuth	Height	Comments
MHz	dB μ V/m	v/h	Limit	Margin	Pk/QP/Avg	degrees	meters	
5317.470	106.1	V	-	-	AVG	291	1.3	RB 1 MHz; VB: 10 Hz
5320.330	114.9	V	-	-	PK	291	1.3	RB 1 MHz; VB: 1 MHz
5318.500	94.0	H	-	-	AVG	55	1.3	RB 1 MHz; VB: 10 Hz
5319.870	102.9	H	-	-	PK	55	1.3	RB 1 MHz; VB: 1 MHz

5350 MHz Band Edge Signal Radiated Field Strength

Frequency	Level	Pol	FCC 15.209		Detector	Azimuth	Height	Comments
MHz	dB μ V/m	v/h	Limit	Margin	Pk/QP/Avg	degrees	meters	
5350.010	53.9	V	54.0	-0.1	Avg	291	1.3	RB 1 MHz; VB: 10 Hz
5351.170	71.9	V	74.0	-2.1	PK	291	1.3	RB 1 MHz; VB: 1 MHz
5350.000	49.0	H	54.0	-5.0	Avg	55	1.3	RB 1 MHz; VB: 10 Hz
5350.430	63.6	H	74.0	-10.4	PK	55	1.3	RB 1 MHz; VB: 1 MHz

Client: Ruckus Wireless	Job Number: J77250
Model: 7962	T-Log Number: T77266
Contact: Craig Owens	Account Manager: Dean Eriksen
Standard: FCC Part 15.E/RSS-210	Class: N/A

Spurious Radiated Emissions:

Frequency MHz	Level dB μ V/m	Pol v/h	15.209 / 15E		Detector Pk/QP/Avg	Azimuth degrees	Height meters	Comments
			Limit	Margin				
10639.110	49.0	V	54.0	-5.0	AVG	180	1.1	RB 1 MHz; VB: 10 Hz
10640.520	61.6	V	74.0	-12.4	PK	180	1.1	RB 1 MHz; VB: 1 MHz

Note 1: For emissions in restricted bands, the limit of 15.209 was used. For all other emissions, the average limit was set to -27dBm/MHz (~68dBuV/m).

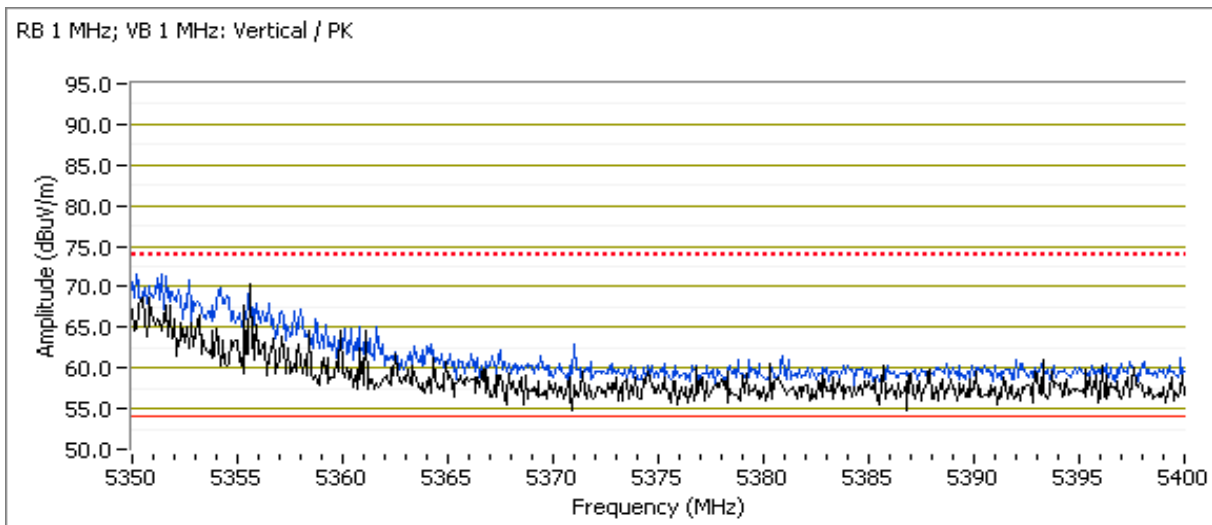
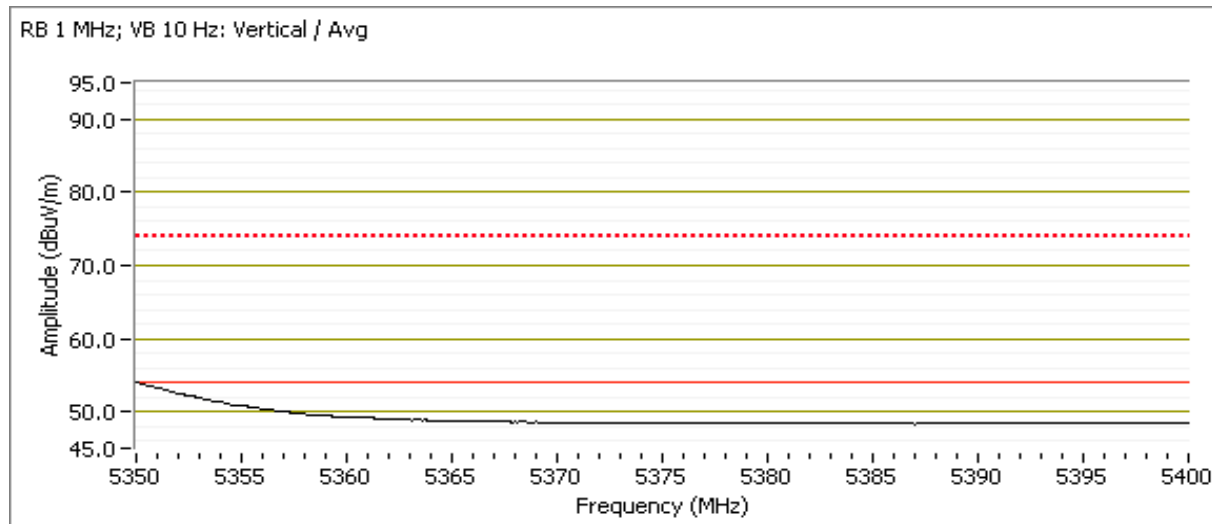

Client: Ruckus Wireless	Job Number: J77250
Model: 7962	T-Log Number: T77266
Contact: Craig Owens	Account Manager: Dean Eriksen
Standard: FCC Part 15.E/RSS-210	Class: N/A

RB 1 MHz; VB 10 Hz: Horizontal / Avg

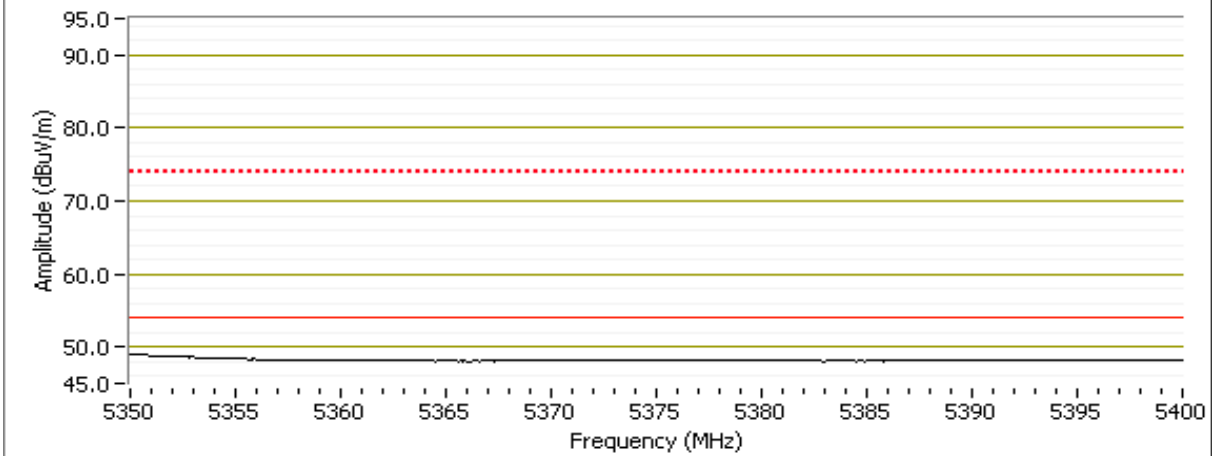

RB 1 MHz; VB 1 MHz: Horizontal / PK

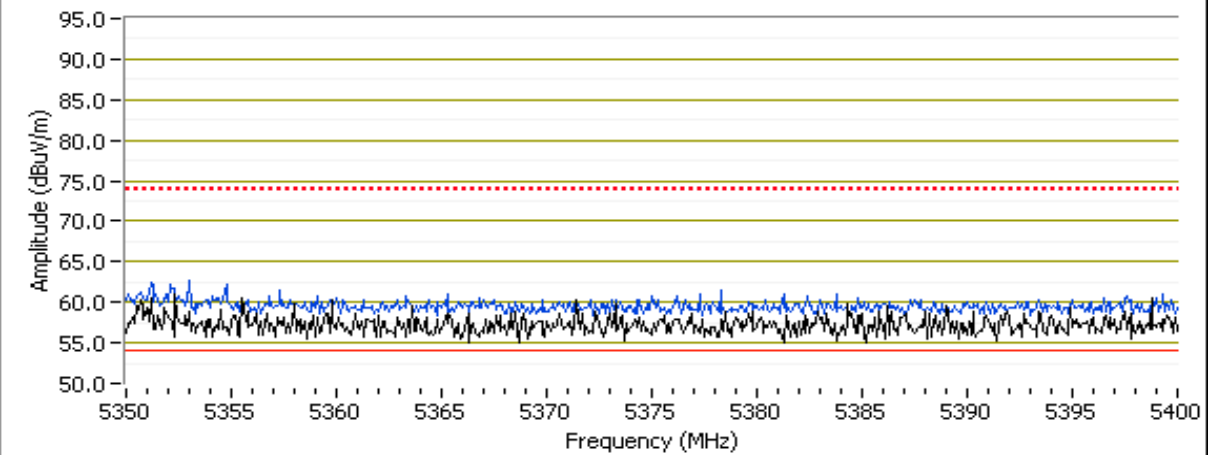

Client:	Ruckus Wireless	Job Number:	J77250
Model:	7962	T-Log Number:	T77266
Contact:	Craig Owens	Account Manager:	Dean Eriksen
Standard:	FCC Part 15.E/RSS-210	Class:	N/A

Run #3, Radiated Spurious Emissions, 30 - 40,000 MH. Operation in the 5470-5725 MHz Band
Run #3a: Low Channel

Date of Test: 2/10/2009 & 2/11/09
 Test Engineer: Joseph Cadigal/Rafael Varelas
 Test Location: SVOATS #1

Fundamental Signal Field Strength

Frequency	Level	Pol	15.209 / 15.247		Detector	Azimuth	Height	Comments
MHz	dB μ V/m	v/h	Limit	Margin	PK/QP/Avg	degrees	meters	
5501.630	112.3	V	-	-	AVG	265	1.0	RB 1 MHz; VB: 10 Hz
5498.170	120.6	V	-	-	PK	265	1.0	RB 1 MHz; VB: 1 MHz
5506.500	98.3	H	-	-	AVG	154	1.6	RB 1 MHz; VB: 10 Hz
5505.830	106.5	H	-	-	PK	154	1.6	RB 1 MHz; VB: 1 MHz

5350-5460 MHz Restricted Band Edge Signal Radiated Field Strength

Frequency	Level	Pol	FCC 15.209		Detector	Azimuth	Height	Comments
MHz	dB μ V/m	v/h	Limit	Margin	PK/QP/Avg	degrees	meters	
5459.960	53.8	V	54.0	-0.2	Avg	265	1.0	RB 1 MHz; VB: 10 Hz
5458.890	71.1	V	74.0	-2.9	PK	265	1.0	RB 1 MHz; VB: 1 MHz
5457.880	48.7	H	54.0	-5.3	Avg	154	1.6	RB 1 MHz; VB: 10 Hz
5457.900	60.7	H	74.0	-13.3	PK	154	1.6	RB 1 MHz; VB: 1 MHz

5460 - 5470 MHz Band Edge Radiated Field Strength

Can omit this test if it is being done conducted

Frequency	Level	Pol	15 E		Detector	Azimuth	Height	Comments
MHz	dB μ V/m	v/h	Limit	Margin	PK/QP/Avg	degrees	meters	
5469.870	59.1	V	68.3	-9.2	Avg	265	1.0	RB 1 MHz; VB: 10 Hz
5469.890	76.5	V	88.3	-11.8	PK	265	1.0	RB 1 MHz; VB: 1 MHz
5469.750	49.6	H	68.3	-18.7	Avg	154	1.6	RB 1 MHz; VB: 10 Hz
5469.630	62.5	H	88.3	-25.8	PK	154	1.6	RB 1 MHz; VB: 1 MHz

Spurious Radiated Emissions:

Frequency	Level	Pol	15.209 / 15E		Detector	Azimuth	Height	Comments
MHz	dB μ V/m	v/h	Limit	Margin	PK/QP/Avg	degrees	meters	
11000.180	41.7	H	54.0	-12.3	AVG	270	1.1	RB 1 MHz; VB: 10 Hz
10999.490	53.3	H	74.0	-20.7	PK	270	1.1	RB 1 MHz; VB: 1 MHz
11001.340	41.7	V	54.0	-12.3	AVG	335	1.1	RB 1 MHz; VB: 10 Hz
10998.750	53.3	V	74.0	-20.7	PK	335	1.1	RB 1 MHz; VB: 1 MHz

Note 1: For emissions in restricted bands, the limit of 15.209 was used. For all other emissions, the average limit was set to -27dBm/MHz (~68dBuV/m).

Client:	Ruckus Wireless	Job Number:	J77250
Model:	7962	T-Log Number:	T77266
Contact:	Craig Owens	Account Manager:	Dean Eriksen
Standard:	FCC Part 15.E/RSS-210	Class:	N/A

RB 1 MHz; VB 10 Hz: Vertical / Avg

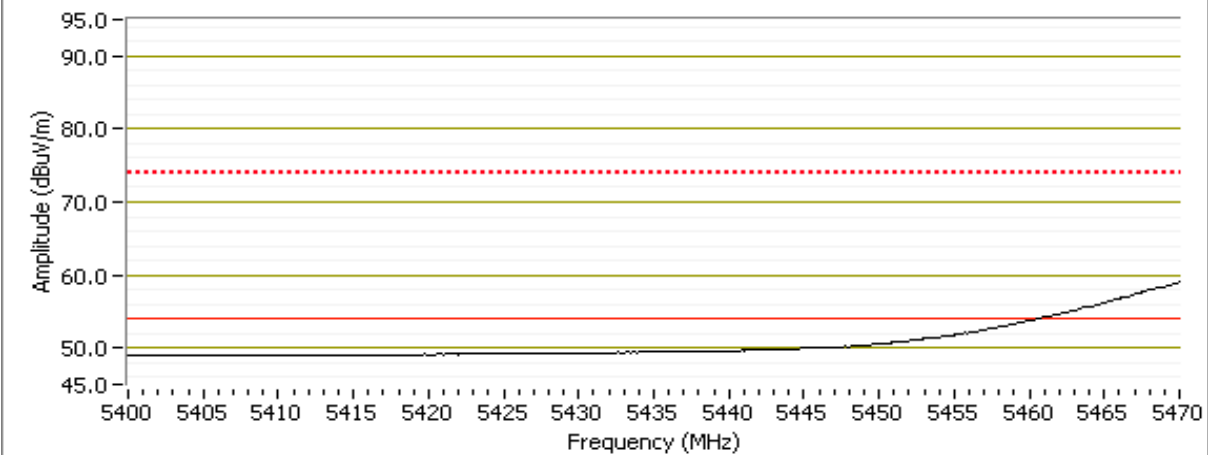

RB 1 MHz; VB 1 MHz: Vertical / PK

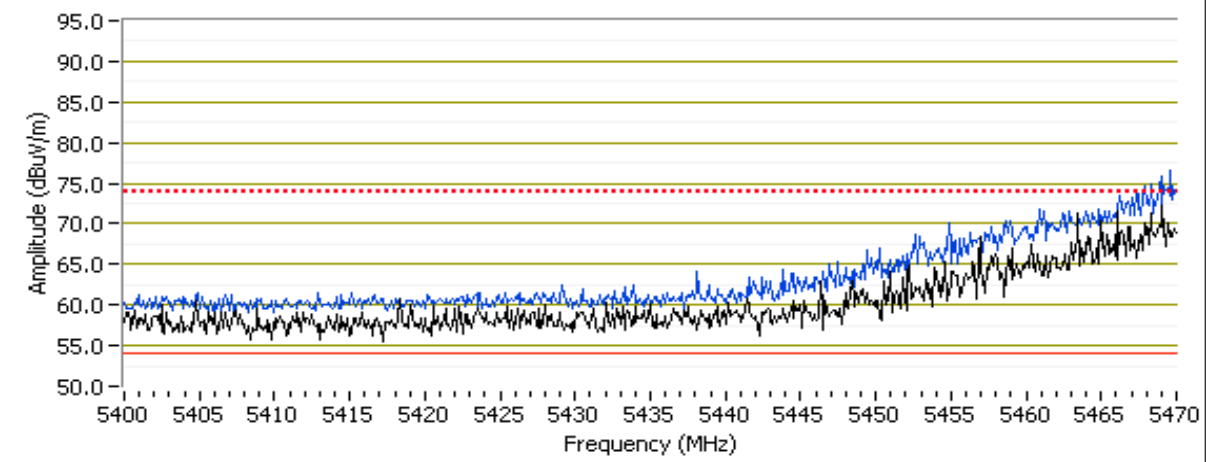

Client: Ruckus Wireless	Job Number: J77250
Model: 7962	T-Log Number: T77266
Contact: Craig Owens	Account Manager: Dean Eriksen
Standard: FCC Part 15.E/RSS-210	Class: N/A

RB 1 MHz; VB 10 Hz: Horizontal / Avg

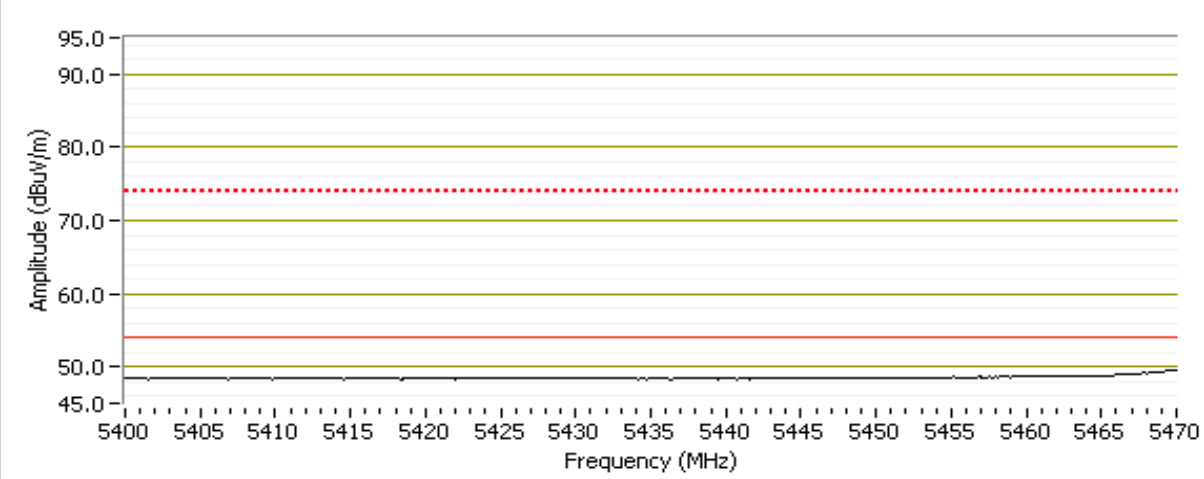

RB 1 MHz; VB 1 MHz: Horizontal / PK

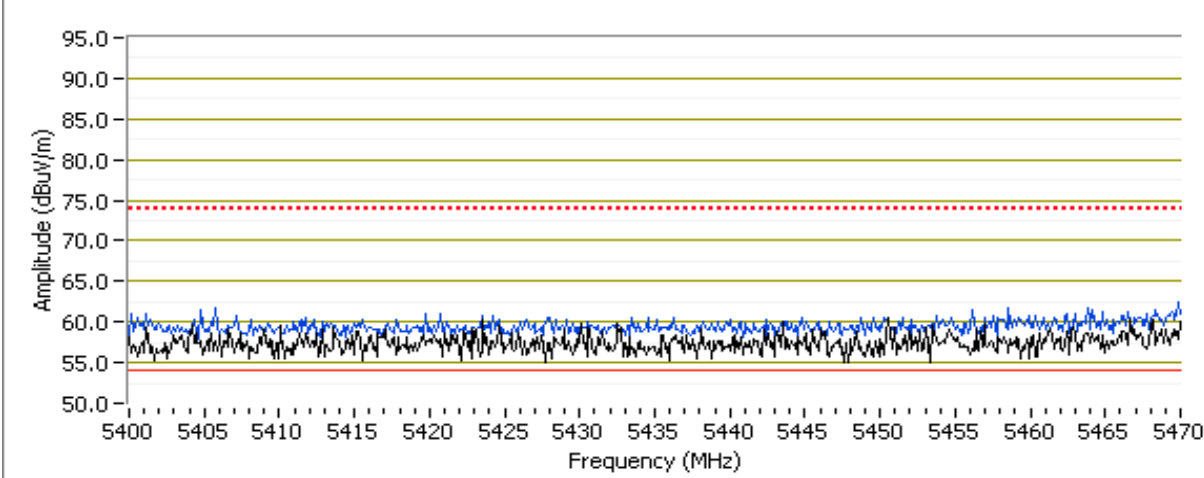

Client:	Ruckus Wireless	Job Number:	J77250
Model:	7962	T-Log Number:	T77266
Contact:	Craig Owens	Account Manager:	Dean Eriksen
Standard:	FCC Part 15.E/RSS-210	Class:	N/A

Run #3c: High Channel

5700MHz

Date of Test: 2/10/2009

Test Engineer: Joseph Cadigal

Test Location: SVOATS #1

Spurious Radiated Emissions:

Frequency MHz	Level dB μ V/m	Pol v/h	15.209 / 15E		Detector Pk/QP/Avg	Azimuth degrees	Height meters	Comments
			Limit	Margin				
11398.550	43.5	H	54.0	-10.5	AVG	200	1.1	RB 1 MHz; VB: 10 Hz
11398.890	54.8	H	74.0	-19.2	PK	200	1.1	RB 1 MHz; VB: 1 MHz
11398.500	43.4	V	54.0	-10.6	AVG	172	1.1	RB 1 MHz; VB: 10 Hz
11401.200	55.1	V	74.0	-18.9	PK	172	1.1	RB 1 MHz; VB: 1 MHz

Note 1: For emissions in restricted bands, the limit of 15.209 was used. For all other emissions, the **average** limit was set to -27dBm/MHz (~68dB μ V/m).

Client:	Ruckus Wireless	Job Number:	J77250
Model:	7962	T-Log Number:	T77266
Contact:	Craig Owens	Account Manager:	Dean Eriksen
Standard:	FCC Part 15.E/RSS-210	Class:	N/A

RSS 210 and FCC 15.407 (UNII) Radiated Spurious Emissions

Test Specific Details

Objective: The objective of this test session is to perform final qualification testing of the EUT with respect to the specification listed above.

General Test Configuration

The EUT and all local support equipment were located on the turntable for radiated spurious emissions testing. For radiated emissions testing the measurement antenna was located 3 meters from the EUT.

Ambient Conditions: Temperature: 20 °C
Rel. Humidity: 38 %

Summary of Results

Run #	Mode	Channel	Power Setting	Measured Power	Test Performed	Limit	Result / Margin
1	MCS0 HT40	5150-5250 Low	12.5dBm	-	Restricted Band Edge at 5150 MHz	15.209	53.9dBµV/m @ 5149.9MHz (-0.1dB)
	MCS0 HT40	5150-5250 Low	20dBm	-	Radiated Emissions, 1 - 40 GHz	FCC 15.209 / 15 E	42.5dBµV/m @ 10381.4MHz (-25.8dB)
	MCS0 HT40	5150-5250 High	20dBm	-	Radiated Emissions, 1 - 40 GHz	FCC 15.209 / 15 E	41.9dBµV/m @ 10461.4MHz (-26.4dB)
2	MCS0 HT40	5250-5350 Low	20dBm	-	Radiated Emissions, 1 - 40 GHz	FCC 15.209 / 15 E	42.0dBµV/m @ 10539.2MHz (-26.3dB)
	MCS0 HT40	5250-5350 High	20dBm	-	Radiated Emissions, 1 - 40 GHz	FCC 15.209 / 15 E	42.1dBµV/m @ 10620.2MHz (-11.9dB)
	MCS0 HT40	5250-5350 High	17.5dBm	-	Restricted Band Edge at 5350 MHz	15.209	53.1dBµV/m @ 5350.0MHz (-0.9dB)
3	MCS0 HT40	5470-5725 Low	20dBm	-	Restricted Band Edge at 5460 MHz	15.209	53.1dBµV/m @ 5459.6MHz (-0.9dB)
	MCS0 HT40	5470-5725 Low	20dBm	-	Radiated Emissions, 1 - 40 GHz	FCC 15.209 / 15 E	42.2dBµV/m @ 11021.4MHz (-11.8dB)
	MCS0 HT40	5470-5725 Center	20dBm	-	Radiated Emissions, 1 - 40 GHz	FCC 15.209 / 15 E	N/A - Worse Case was 802.11a Legacy
	MCS0 HT40	5470-5725 High	20dBm	-	Radiated Emissions, 1 - 40 GHz	FCC 15.209 / 15 E	43.3dBµV/m @ 11340.8MHz (-10.7dB)

Preliminary testing showed that 802.11a Legacy was worse case mode for center channel emissions in the 5470-5725 MHz band. No testing performed at 5550 MHz for 802.11 HT40.

Client:	Ruckus Wireless	Job Number:	J77250
Model:	7962	T-Log Number:	T77266
Contact:	Craig Owens	Account Manager:	Dean Eriksen
Standard:	FCC Part 15.E/RSS-210	Class:	N/A

Modifications Made During Testing

No modifications were made to the EUT during testing

Deviations From The Standard

No deviations were made from the requirements of the standard.

Run #1, Radiated Spurious Emissions, 30 - 40,000 MH. Operation in the 5150-5250 MHz Band
11n MCS0 HT40 mode

Date of Test: 2/10/2009 & 2/11/09
Test Engineer: Joseph Cadigal/Rafael Varelas
Test Location: SVOATS #1

Run #1a: Low Channel @ 5190 MHz

Fundamental Signal Field Strength

Frequency MHz	Level dB μ V/m	Pol v/h	15.209 / 15.247		Detector Pk/QP/Avg	Azimuth degrees	Height meters	Comments
			Limit	Margin				
5207.070	95.6	V	-	-	AVG	303	1.3	RB 1 MHz; VB: 10 Hz
5181.600	104.4	V	-	-	PK	303	1.3	RB 1 MHz; VB: 1 MHz
5207.070	83.5	H	-	-	AVG	350	1.7	RB 1 MHz; VB: 10 Hz
5206.730	91.7	H	-	-	PK	350	1.7	RB 1 MHz; VB: 1 MHz

5150 MHz Band Edge Signal Radiated Field Strength

Frequency MHz	Level dB μ V/m	Pol v/h	FCC 15.209		Detector Pk/QP/Avg	Azimuth degrees	Height meters	Comments
			Limit	Margin				
5149.900	53.9	V	54.0	-0.1	Avg	303	1.3	RB 1 MHz; VB: 10 Hz
5148.830	69.2	V	74.0	-4.8	PK	303	1.3	RB 1 MHz; VB: 1 MHz
5147.310	48.4	H	54.0	-5.6	Avg	350	1.7	RB 1 MHz; VB: 10 Hz
5148.790	61.2	V	74.0	-12.8	PK	350	1.7	RB 1 MHz; VB: 1 MHz

Spurious Radiated Emissions:

Power Setting = 20dBm

Frequency MHz	Level dB μ V/m	Pol v/h	15.209 / 15E		Detector Pk/QP/Avg	Azimuth degrees	Height meters	Comments
			Limit	Margin				
10381.370	42.5	V	68.3	-25.8	AVG	120	1.0	RB 1 MHz; VB: 10 Hz
10378.910	53.5	V	88.3	-34.8	PK	120	1.0	RB 1 MHz; VB: 1 MHz
10381.470	42.5	H	68.3	-25.8	AVG	113	1.3	RB 1 MHz; VB: 10 Hz
10379.570	53.5	H	88.3	-34.8	PK	113	1.3	RB 1 MHz; VB: 1 MHz

Note 1: For emissions in restricted bands, the limit of 15.209 was used. For all other emissions, the average limit was set to -27dBm/MHz (~68dBuV/m).

Client: Ruckus Wireless	Job Number: J77250
Model: 7962	T-Log Number: T77266
Contact: Craig Owens	Account Manager: Dean Eriksen
Standard: FCC Part 15.E/RSS-210	Class: N/A

Run #1a: Continued

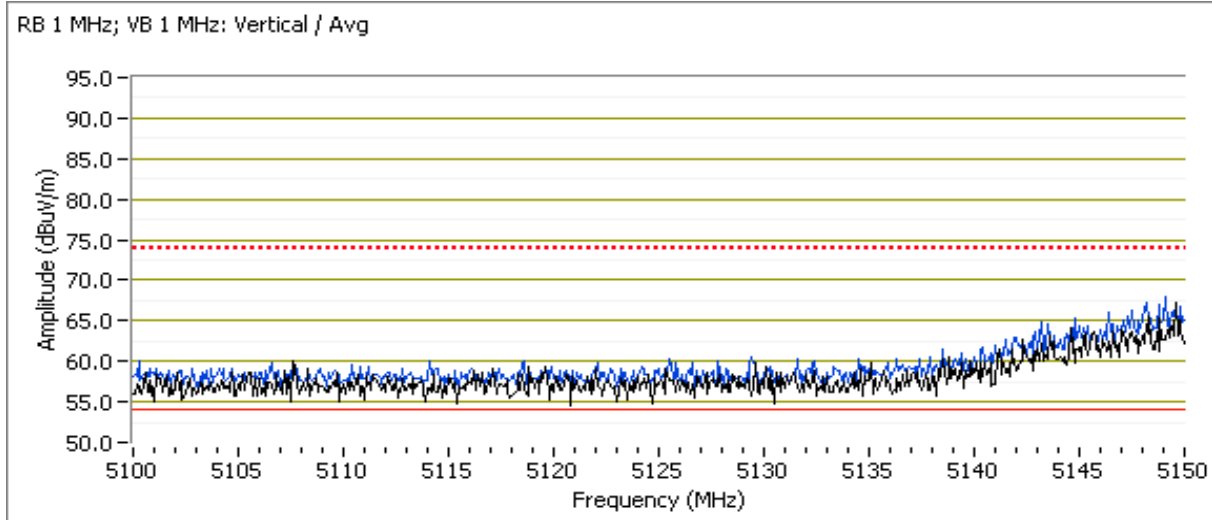
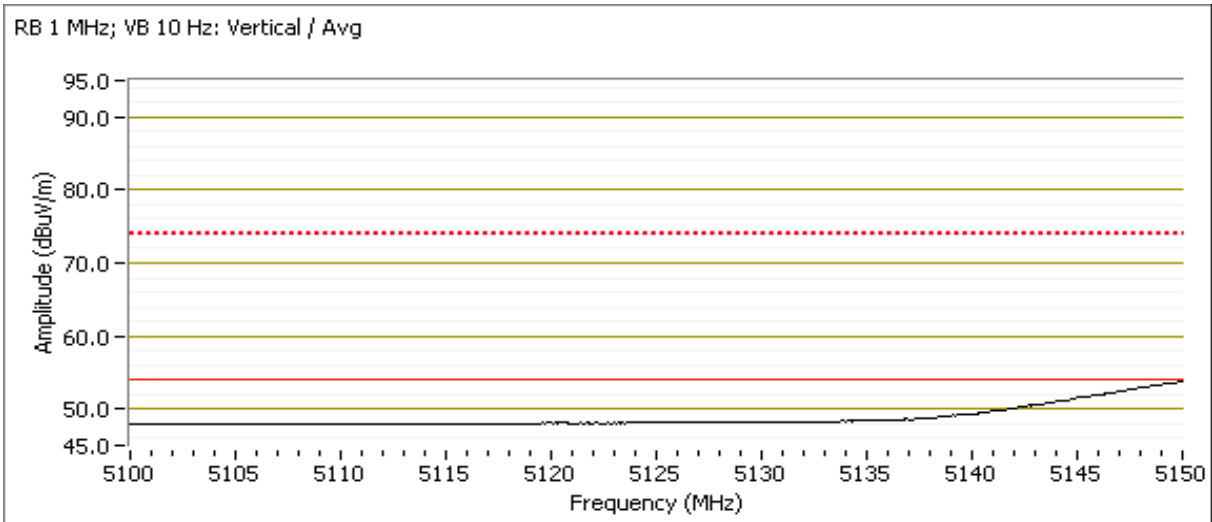

Client: Ruckus Wireless	Job Number: J77250
Model: 7962	T-Log Number: T77266
Contact: Craig Owens	Account Manager: Dean Eriksen
Standard: FCC Part 15.E/RSS-210	Class: N/A

Run #1a: Continued

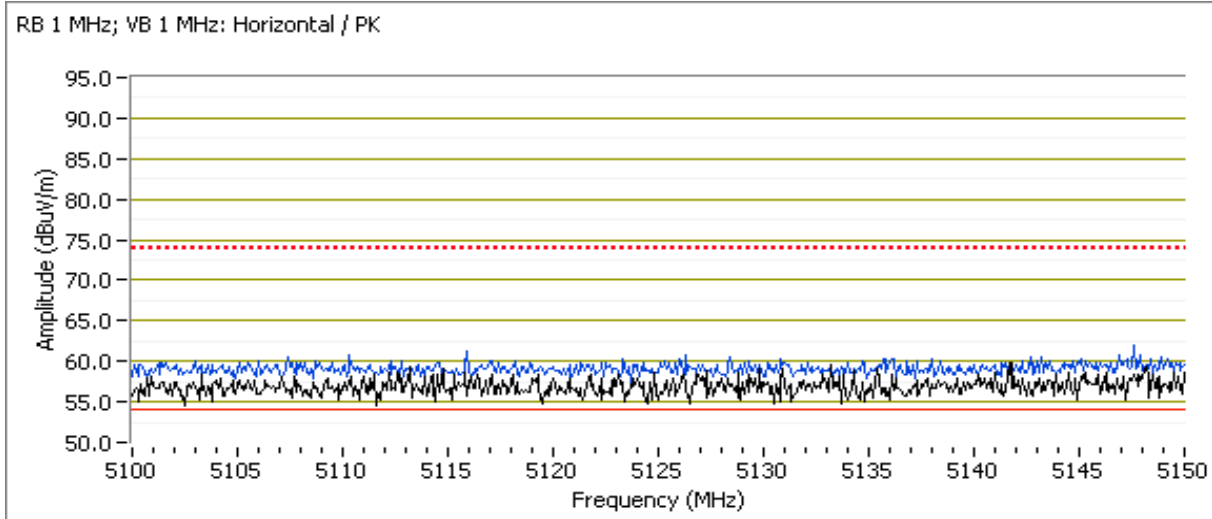
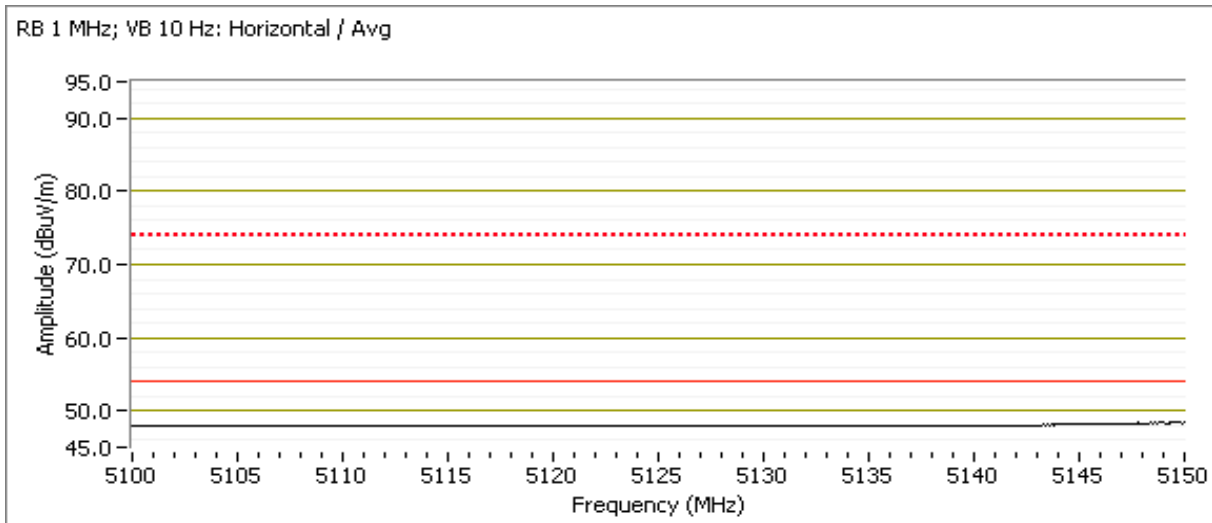

Client: Ruckus Wireless	Job Number: J77250
Model: 7962	T-Log Number: T77266
	Account Manager: Dean Eriksen
Contact: Craig Owens	
Standard: FCC Part 15.E/RSS-210	Class: N/A

Run #1b: High Channel @ 5230 MHz
Power Setting = 20dBm

Date of Test: 2/10/2009
Test Engineer: Joseph Cadigal
Test Location: SVOATS #1

Spurious Radiated Emissions:
Power Setting = 20dbm

Frequency	Level	Pol	15.209 / 15E		Detector	Azimuth	Height	Comments
MHz	dB μ V/m	v/h	Limit	Margin	Pk/QP/Avg	degrees	meters	
10461.420	41.9	V	68.3	-26.4	AVG	219	1.0	RB 1 MHz; VB: 10 Hz
10460.340	53.1	V	88.3	-35.2	PK	219	1.0	RB 1 MHz; VB: 1 MHz

Note 1: For emissions in restricted bands, the limit of 15.209 was used. For all other emissions, the **average** limit was set to -27dBm/MHz (-68dBuV/m).

Run #2, Radiated Spurious Emissions, 30 - 40,000 MH. Operation in the 5250-5350 MHz Band
Run #2a: Low Channel @ 5270 MHz

Date of Test: 2/10/2009
Test Engineer: Joseph Cadigal
Test Location: SVOATS #1

Spurious Radiated Emissions:
Power Setting = 20dbm

Note: If device is not for indoor use only then measure 5250 MHz band edge to comply with -68.3dBuV/m limit

Frequency	Level	Pol	15.209 / 15E		Detector	Azimuth	Height	Comments
MHz	dB μ V/m	v/h	Limit	Margin	Pk/QP/Avg	degrees	meters	
10539.240	42.0	V	68.3	-26.3	AVG	88	1.0	RB 1 MHz; VB: 10 Hz
10539.680	54.1	V	88.3	-34.2	PK	88	1.0	RB 1 MHz; VB: 1 MHz

Note 1: For emissions in restricted bands, the limit of 15.209 was used. For all other emissions, the **average** limit was set to -27dBm/MHz (-68dBuV/m).

Client:	Ruckus Wireless	Job Number:	J77250
Model:	7962	T-Log Number:	T77266
Contact:	Craig Owens	Account Manager:	Dean Eriksen
Standard:	FCC Part 15.E/RSS-210	Class:	N/A

Run #2b: High Channel @ 5310 MHz

Date of Test: 2/10/2009 & 2/11/09
 Test Engineer: Joseph Cadigal/Rafael Varelas
 Test Location: SVOATS #1

Fundamental Signal Field Strength

Frequency	Level	Pol	15.209 / 15.247		Detector	Azimuth	Height	Comments
MHz	dB μ V/m	v/h	Limit	Margin	Pk/QP/Avg	degrees	meters	
5292.870	97.8	V	-	-	AVG	283	1.3	RB 1 MHz; VB: 10 Hz
5296.800	106.3	V	-	-	PK	283	1.3	RB 1 MHz; VB: 1 MHz
5293.070	86.8	H	-	-	AVG	153	1.4	RB 1 MHz; VB: 10 Hz
5295.270	94.6	H	-	-	PK	153	1.4	RB 1 MHz; VB: 1 MHz

5350 MHz Band Edge Signal Radiated Field Strength

Power Setting = 17.5dbm

Frequency	Level	Pol	FCC 15.209		Detector	Azimuth	Height	Comments
MHz	dB μ V/m	v/h	Limit	Margin	Pk/QP/Avg	degrees	meters	
5350.000	53.1	V	54.0	-0.9	Avg	283	1.3	RB 1 MHz; VB: 10 Hz
5351.830	67.2	V	74.0	-6.8	PK	283	1.3	RB 1 MHz; VB: 1 MHz
5350.000	49.6	H	54.0	-4.4	Avg	153	1.4	RB 1 MHz; VB: 10 Hz
5351.650	61.6	H	74.0	-12.4	PK	153	1.4	RB 1 MHz; VB: 1 MHz

Spurious Radiated Emissions:

Power Setting = 20dbm

Frequency	Level	Pol	15.209 / 15E		Detector	Azimuth	Height	Comments
MHz	dB μ V/m	v/h	Limit	Margin	Pk/QP/Avg	degrees	meters	
10620.240	42.1	H	54.0	-11.9	AVG	332	1.0	RB 1 MHz; VB: 10 Hz
10618.790	53.8	H	74.0	-20.2	PK	332	1.0	RB 1 MHz; VB: 1 MHz
10619.030	42.0	V	54.0	-12.0	AVG	88	1.0	RB 1 MHz; VB: 10 Hz
10618.880	53.6	V	74.0	-20.4	PK	88	1.0	RB 1 MHz; VB: 1 MHz

Note 1: For emissions in restricted bands, the limit of 15.209 was used. For all other emissions, the **average** limit was set to -27dBm/MHz (-68dB μ V/m).

Client: Ruckus Wireless	Job Number: J77250
Model: 7962	T-Log Number: T77266
Contact: Craig Owens	Account Manager: Dean Eriksen
Standard: FCC Part 15.E/RSS-210	Class: N/A

RB 1 MHz; VB 10 Hz: Vertical / Avg

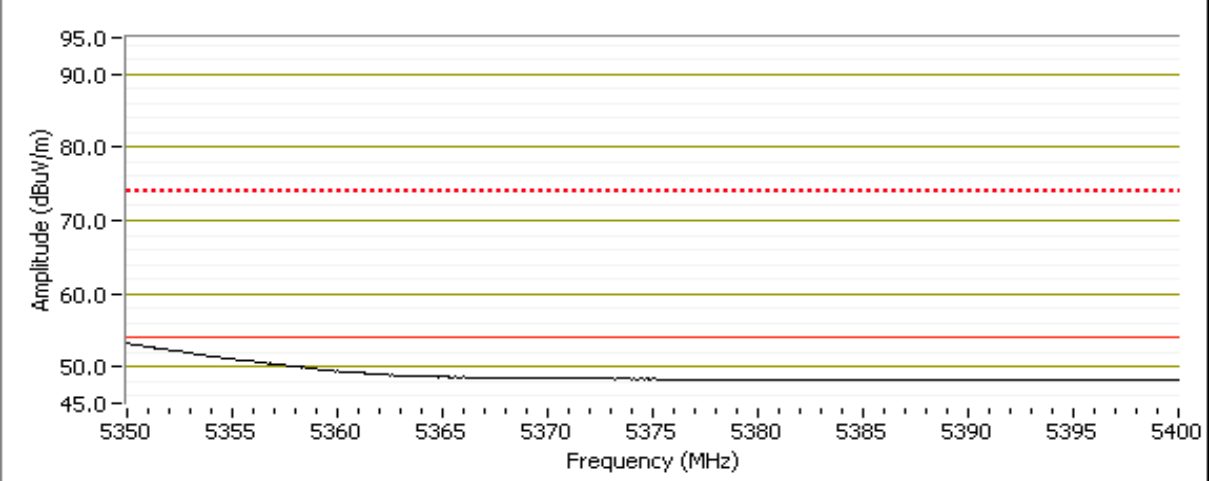

RB 1 MHz; VB 1 MHz: Vertical / Avg

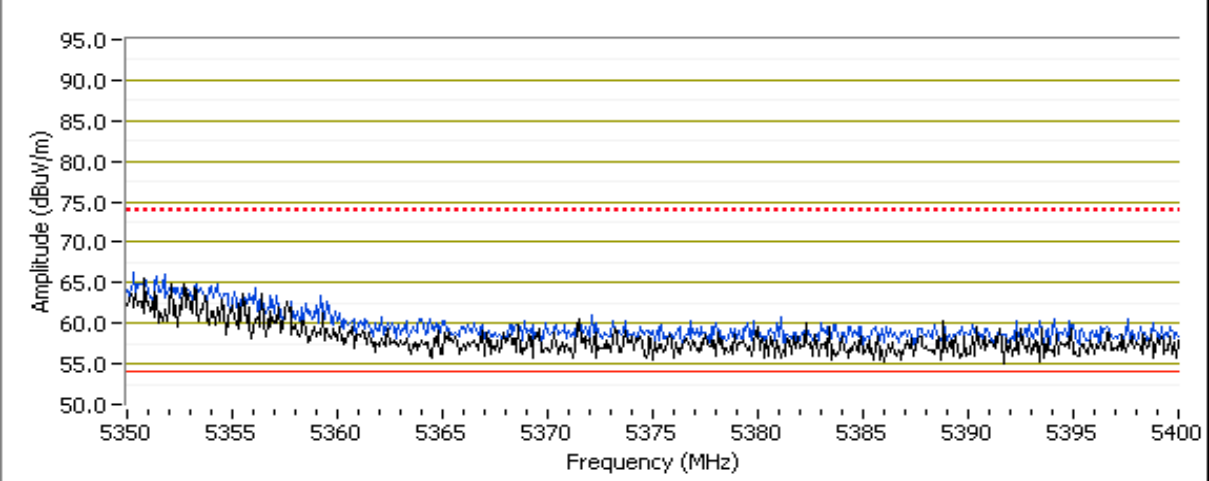

Client: Ruckus Wireless	Job Number: J77250
Model: 7962	T-Log Number: T77266
Contact: Craig Owens	Account Manager: Dean Eriksen
Standard: FCC Part 15.E/RSS-210	Class: N/A

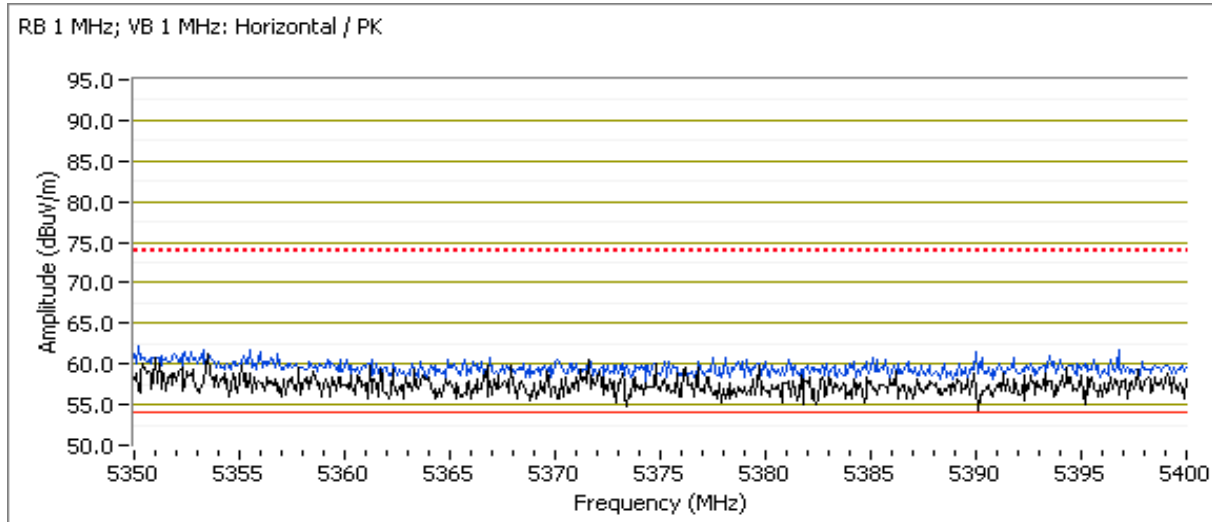
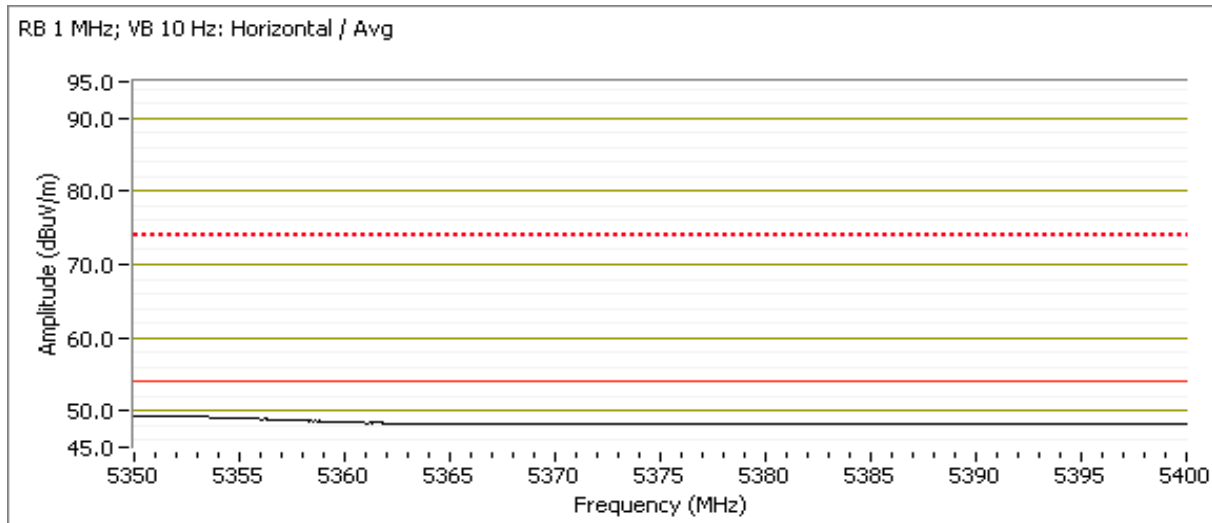

Client:	Ruckus Wireless	Job Number:	J77250
Model:	7962	T-Log Number:	T77266
Contact:	Craig Owens	Account Manager:	Dean Eriksen
Standard:	FCC Part 15.E/RSS-210	Class:	N/A

Run #3, Radiated Spurious Emissions, 30 - 40,000 MH. Operation in the 5470-5725 MHz Band
Run #3a: Low Channel @ 5510 MHz

Date of Test: 2/10/2009 & 2/11/09
 Test Engineer: Joseph Cadigal/Rafael Varelas
 Test Location: SVOATS #1

Fundamental Signal Field Strength

Frequency	Level	Pol	15.209 / 15.247		Detector	Azimuth	Height	Comments
MHz	dB μ V/m	v/h	Limit	Margin	PK/QP/Avg	degrees	meters	
5524.330	103.6	V	-	-	AVG	264	1.0	RB 1 MHz; VB: 10 Hz
5521.530	112.4	V	-	-	PK	264	1.0	RB 1 MHz; VB: 1 MHz
5514.270	89.7	H	-	-	AVG	160	1.4	RB 1 MHz; VB: 10 Hz
5513.270	97.6	H	-	-	PK	160	1.4	RB 1 MHz; VB: 1 MHz

5350-5460 MHz Restricted Band Edge Signal Radiated Field Strength

Frequency	Level	Pol	FCC 15.209		Detector	Azimuth	Height	Comments
MHz	dB μ V/m	v/h	Limit	Margin	PK/QP/Avg	degrees	meters	
5459.600	53.1	V	54.0	-0.9	Avg	264	1.0	RB 1 MHz; VB: 10 Hz
5459.290	68.5	V	74.0	-5.5	PK	264	1.0	RB 1 MHz; VB: 1 MHz
5457.010	48.6	H	54.0	-5.4	Avg	160	1.4	RB 1 MHz; VB: 10 Hz
5459.350	60.9	H	74.0	-13.1	PK	160	1.4	RB 1 MHz; VB: 1 MHz

5460 - 5470 MHz Band Edge Radiated Field Strength

Frequency	Level	Pol	15 E		Detector	Azimuth	Height	Comments
MHz	dB μ V/m	v/h	Limit	Margin	PK/QP/Avg	degrees	meters	
5469.670	55.2	V	68.3	-13.1	Avg	264	1.0	RB 1 MHz; VB: 10 Hz
5467.160	77.4	V	88.3	-10.9	PK	264	1.0	RB 1 MHz; VB: 1 MHz
5468.860	48.7	H	68.3	-19.6	Avg	160	1.4	RB 1 MHz; VB: 10 Hz
5469.580	62.5	H	88.3	-25.8	PK	160	1.4	RB 1 MHz; VB: 1 MHz

Spurious Radiated Emissions:

Power Setting = 20dbm

Frequency	Level	Pol	15.209 / 15E		Detector	Azimuth	Height	Comments
MHz	dB μ V/m	v/h	Limit	Margin	PK/QP/Avg	degrees	meters	
11021.430	42.2	V	54.0	-11.8	AVG	153	1.0	RB 1 MHz; VB: 10 Hz
11020.440	54.0	V	74.0	-20.0	PK	153	1.0	RB 1 MHz; VB: 1 MHz
11021.150	42.2	H	54.0	-11.8	AVG	0	1.0	RB 1 MHz; VB: 10 Hz
11019.670	53.4	H	74.0	-20.6	PK	0	1.0	RB 1 MHz; VB: 1 MHz

Note 1: For emissions in restricted bands, the limit of 15.209 was used. For all other emissions, the average limit was set to -27dBm/MHz (~68dBuV/m).

Client: Ruckus Wireless	Job Number: J77250
Model: 7962	T-Log Number: T77266
Contact: Craig Owens	Account Manager: Dean Eriksen
Standard: FCC Part 15.E/RSS-210	Class: N/A

Run #3a: Continued

RB 1 MHz; VB 10 Hz: Vertical / Avg

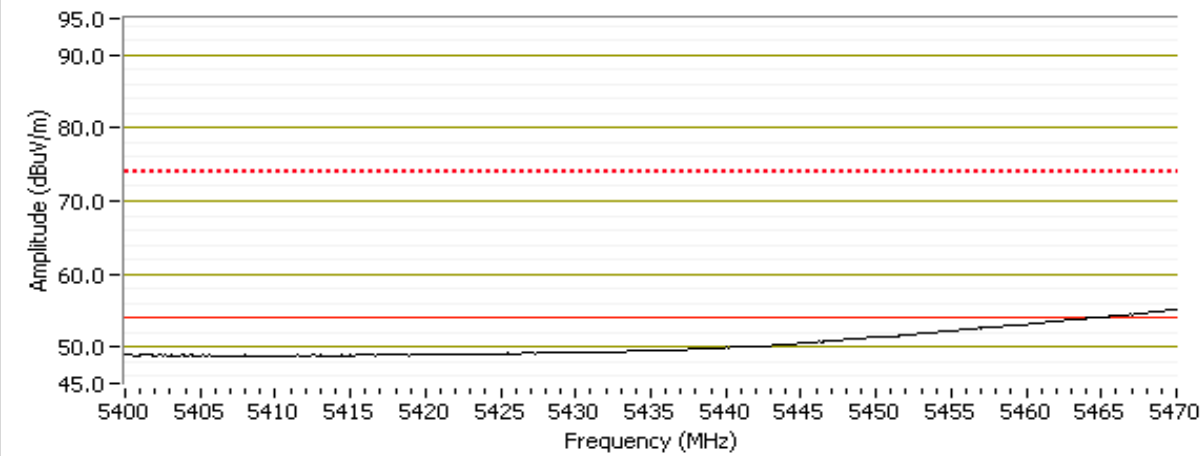

RB 1 MHz; VB 1 MHz: Vertical / PK

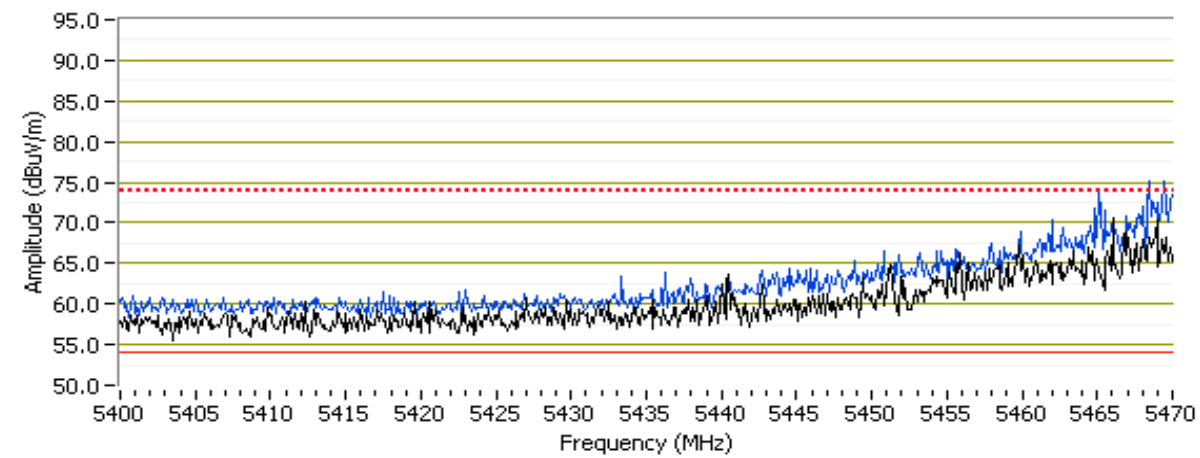

Client: Ruckus Wireless	Job Number: J77250
Model: 7962	T-Log Number: T77266
Contact: Craig Owens	Account Manager: Dean Eriksen
Standard: FCC Part 15.E/RSS-210	Class: N/A

Run #3a: Continued

RB 1 MHz; VB 10 Hz: Horizontal / Avg

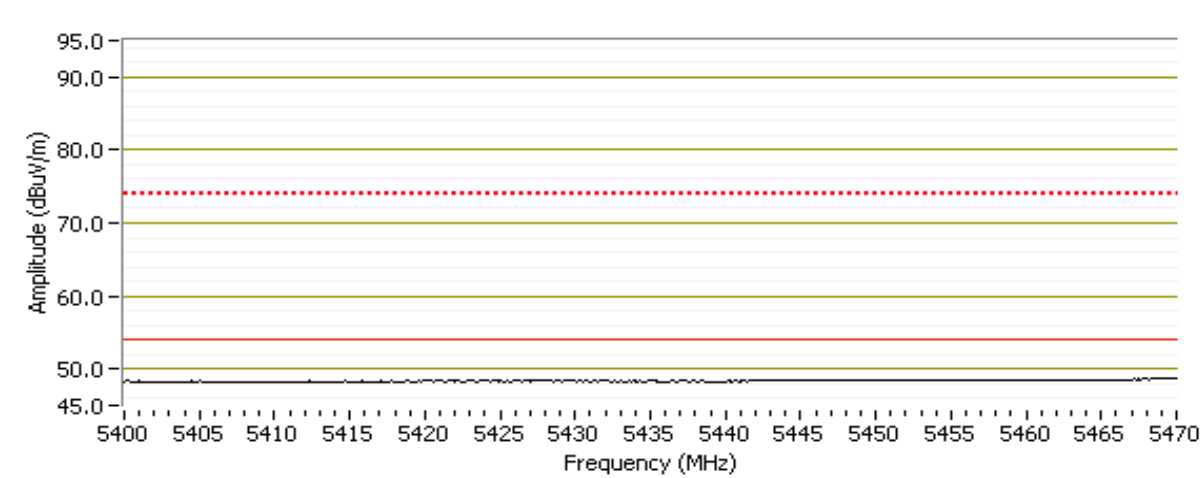

RB 1 MHz; VB 1 MHz: Horizontal / PK

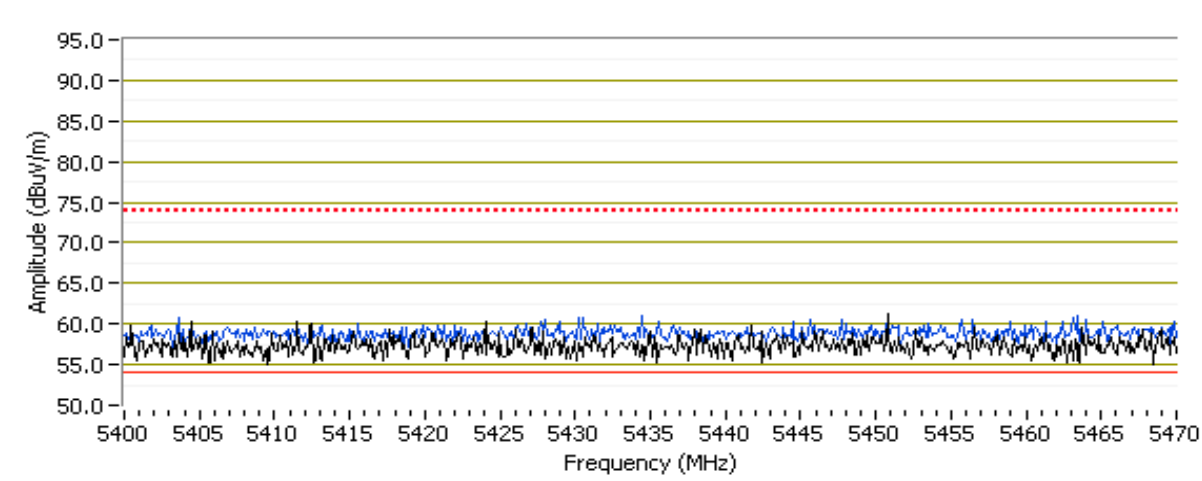

Client:	Ruckus Wireless	Job Number:	J77250
Model:	7962	T-Log Number:	T77266
Contact:	Craig Owens	Account Manager:	Dean Eriksen
Standard:	FCC Part 15.E/RSS-210	Class:	N/A

Run #3c: High Channel @ 5670 MHz

Date of Test: 2/10/2009
 Test Engineer: Joseph Cadigal
 Test Location: SVOATS #1

Spurious Radiated Emissions:

Power Setting = 20dbm

Frequency	Level	Pol	15.209 / 15E		Detector	Azimuth	Height	Comments
MHz	dB μ V/m	v/h	Limit	Margin	Pk/QP/Avg	degrees	meters	
11340.830	43.3	H	54.0	-10.7	AVG	215	1.0	RB 1 MHz; VB: 10 Hz
11340.300	54.6	H	74.0	-19.4	PK	215	1.0	RB 1 MHz; VB: 1 MHz
11340.800	43.2	V	54.0	-10.8	AVG	147	2.1	RB 1 MHz; VB: 10 Hz
11339.580	54.7	V	74.0	-19.3	PK	147	2.1	RB 1 MHz; VB: 1 MHz

Note 1: For emissions in restricted bands, the limit of 15.209 was used. For all other emissions, the **average** limit was set to -27dBm/MHz (-68dBuV/m).

Client:	Ruckus Wireless	Job Number:	J77250
Model:	7962	T-Log Number:	T77266
		Account Manager:	Dean Eriksen
Contact:	Craig Owens		
Standard:	FCC Part 15.E/RSS-210	Class:	B

Radiated Emissions - Receive Mode

Test Specific Details

Objective: The objective of this test session is to perform final qualification testing of the EUT with respect to the specification listed above.

Date of Test: 2/10/2009 & 2/11/09

Config. Used: 1

Test Engineer: Joseph Cadigal/R. Varelas

Config Change: none

Test Location: SVOATS #1 / Chamber #2

EUT Voltage: 120V/60Hz

General Test Configuration

The EUT and all local support equipment were located on the turntable for radiated emissions testing. Remote support equipment was located approximately 30 meters from the test area with all I/O connections running on top of the groundplane.

The test distance and extrapolation factor (if applicable) are detailed under each run description.

Note, **preliminary** testing indicates that the emissions were maximized by orientation of the EUT and elevation of the measurement antenna. **Maximized** testing indicated that the emissions were maximized by orientation of the EUT, elevation of the measurement antenna, and manipulation of the EUT's interface cables.

Ambient Conditions:	Temperature:	20 °C
	Rel. Humidity:	38 %

Summary of Results

Run #	Test Performed	Limit	Result	Margin
2 - RX on 5200 MHz Legacy Mode	RE, 30 - 1000MHz, Maximized Emissions	RSS GEN	Pass	28.9dBµV/m @ 153.215MHz (-14.6dB)
3a - RX on 5200 MHz Legacy Mode	RE, 1000 - 18000MHz, Maximized Emissions	RSS GEN	Pass	44.1dBµV/m @ 6933.4MHz (-9.9dB)
3b - RX on 5200 MHz HT40 Mode	RE, 1000 - 18000MHz, Maximized Emissions	RSS GEN	Pass	46.0dBµV/m @ 6933.4MHz (-8.0dB)
5 - RX on 5300 MHz Legacy Mode	RE, 30 - 1000MHz, Maximized Emissions	RSS GEN	Pass	26.9dBµV/m @ 53.771MHz (-13.1dB)
6a - RX on 5300 MHz Legacy Mode	RE, 1000 - 18000MHz, Maximized Emissions	RSS GEN	Pass	50.9dBµV/m @ 7066.7MHz (-3.1dB)
6b - RX on 5300 MHz HT40 Mode	RE, 1000 - 18000MHz, Maximized Emissions	RSS GEN	Pass	50.7dBµV/m @ 7066.7MHz (-3.3dB)
8 - RX on 5600 MHz Legacy Mode	RE, 30 - 1000MHz, Maximized Emissions	RSS GEN	Pass	26.0dBµV/m @ 53.847MHz (-14.0dB)
9a - RX on 5600 MHz Legacy Mode	RE, 1000 - 18000MHz, Maximized Emissions	RSS GEN	Pass	49.7dBµV/m @ 7466.7MHz (-4.3dB)
9b - RX on 5600 MHz HT40 Mode	RE, 1000 - 18000MHz, Maximized Emissions	RSS GEN	Pass	49.9dBµV/m @ 7466.7MHz (-4.1dB)

Client: Ruckus Wireless	Job Number: J77250
Model: 7962	T-Log Number: T77266
Contact: Craig Owens	Account Manager: Dean Eriksen
Standard: FCC Part 15.E/RSS-210	Class: B

Modifications Made During Testing

No modifications were made to the EUT during testing

Deviations From The Standard

No deviations were made from the requirements of the standard.

Run #1: Preliminary Radiated Emissions, 30-1000 MHz

EUT set to Receive mode at 5200 MHz

Frequency Range	Test Distance	Limit Distance	Extrapolation Factor
30 - 1000 MHz	3	3	0.0

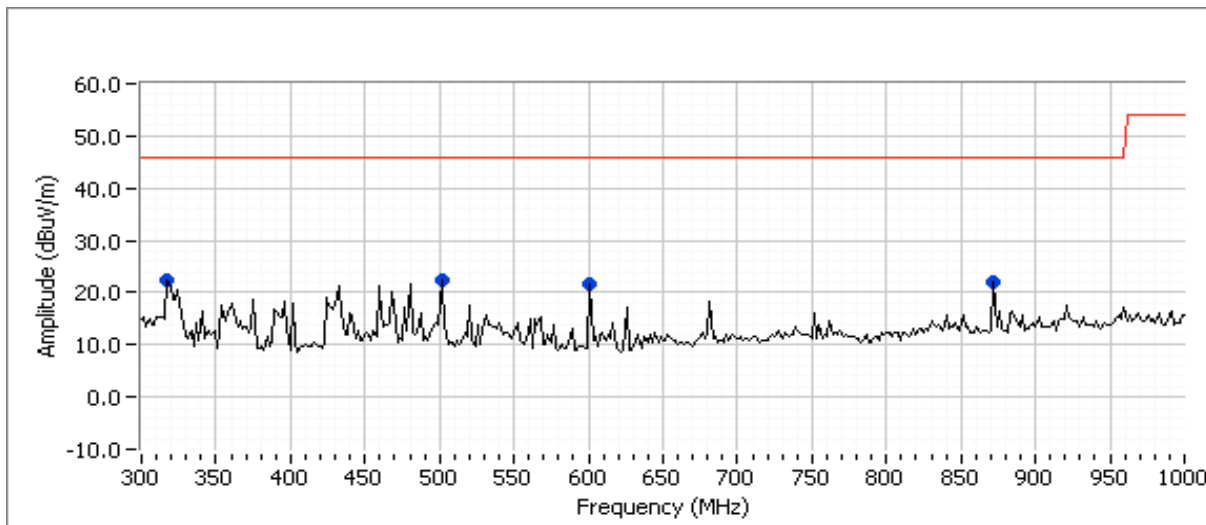
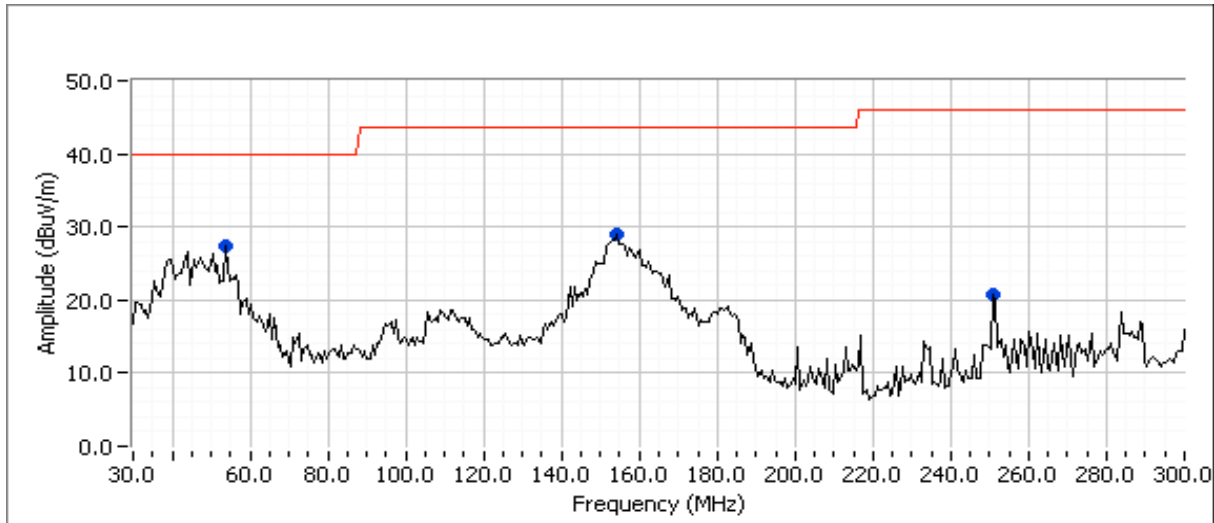

Client:	Ruckus Wireless	Job Number:	J77250
Model:	7962	T-Log Number:	T77266
Contact:	Craig Owens	Account Manager:	Dean Eriksen
Standard:	FCC Part 15.E/RSS-210	Class:	B

Run #1: Preliminary Radiated Emissions, 30-1000 MHz

Frequency MHz	Level dB μ V/m	Pol v/h	RSS Gen		Detector Pk/QP/Avg	Azimuth degrees	Height meters	Comments
			Limit	Margin				
53.938	27.3	V	40.0	-12.7	Peak	271	1.7	
153.215	29.1	H	43.5	-14.4	Peak	238	1.7	
873.468	23.2	H	46.0	-22.8	Peak	61	1.7	
500.006	23.1	H	46.0	-22.9	Peak	331	1.7	
319.041	21.8	V	46.0	-24.2	Peak	298	1.7	
600.005	21.1	V	46.0	-24.9	Peak	269	1.7	
250.013	20.8	H	46.0	-25.2	Peak	299	1.7	

Run #2: Maximized Readings From Run #1

Frequency MHz	Level dB μ V/m	Pol v/h	RSS Gen		Detector Pk/QP/Avg	Azimuth degrees	Height meters	Comments
			Limit	Margin				
153.215	28.9	H	43.5	-14.6	QP	238	1.7	
53.938	24.5	V	40.0	-15.5	QP	271	1.7	

Run #3a: Maximized readings, 1000 - 18000 MHz
EUT set to Receive mode at 5200 MHz, Lagacy Mode

Frequency Range	Test Distance	Limit Distance	Extrapolation Factor
1000 - 18000 MHz	3	3	0.0

Frequency MHz	Level dB μ V/m	Pol v/h	RSS Gen		Detector Pk/QP/Avg	Azimuth degrees	Height meters	Comments
			Limit	Margin				
6933.390	44.1	V	54.0	-9.9	AVG	356	1.3	RB 1 MHz; VB: 10 Hz
10400.920	37.8	H	54.0	-16.2	AVG	316	1.0	RB 1 MHz; VB: 10 Hz
10401.090	37.8	V	54.0	-16.2	AVG	0	1.0	RB 1 MHz; VB: 10 Hz
6933.390	36.7	H	54.0	-17.3	AVG	100	1.0	RB 1 MHz; VB: 10 Hz
3466.560	29.8	H	54.0	-24.2	AVG	314	1.8	RB 1 MHz; VB: 10 Hz
3465.680	29.7	V	54.0	-24.3	AVG	360	1.7	RB 1 MHz; VB: 10 Hz
6933.440	49.7	V	74.0	-24.3	PK	356	1.3	RB 1 MHz; VB: 1 MHz
10400.640	49.1	H	74.0	-24.9	PK	316	1.0	RB 1 MHz; VB: 1 MHz
10398.700	48.6	V	74.0	-25.4	PK	0	1.0	RB 1 MHz; VB: 1 MHz
6933.370	46.9	H	74.0	-27.1	PK	100	1.0	RB 1 MHz; VB: 1 MHz
3466.080	40.9	H	74.0	-33.1	PK	314	1.8	RB 1 MHz; VB: 1 MHz
3467.050	40.8	V	74.0	-33.2	PK	360	1.7	RB 1 MHz; VB: 1 MHz

Note 1: Above 1 GHz, the FCC specifies the limit as an average measurement. In addition, the FCC states that the peak reading of any emission above 1 GHz, can not exceed the average limit by more than 20 dB.

Client:	Ruckus Wireless	Job Number:	J77250
Model:	7962	T-Log Number:	T77266
Contact:	Craig Owens	Account Manager:	Dean Eriksen
Standard:	FCC Part 15.E/RSS-210	Class:	B

Run #3b: Maximized readings, 1000 - 18000 MHz
 EUT set to Receive mode at 5200 MHz, HT-40 Mode

Frequency Range	Test Distance	Limit Distance	Extrapolation Factor
1000 - 18000 MHz	3	3	0.0

Frequency MHz	Level dB μ V/m	Pol v/h	RSS Gen		Detector Pk/QP/Avg	Azimuth degrees	Height meters	Comments
			Limit	Margin				
6933.410	46.0	V	54.0	-8.0	AVG	354	1.3	RB 1 MHz; VB: 10 Hz
6933.350	37.9	H	54.0	-16.1	AVG	93	1.6	RB 1 MHz; VB: 10 Hz
10401.180	37.8	H	54.0	-16.2	AVG	0	1.0	RB 1 MHz; VB: 10 Hz
10400.440	37.7	V	54.0	-16.3	AVG	0	1.0	RB 1 MHz; VB: 10 Hz
6933.480	51.1	V	74.0	-22.9	PK	354	1.3	RB 1 MHz; VB: 1 MHz
3466.730	30.2	V	54.0	-23.8	AVG	112	1.6	RB 1 MHz; VB: 10 Hz
3468.040	29.6	H	54.0	-24.4	AVG	221	1.0	RB 1 MHz; VB: 10 Hz
10400.380	49.2	H	74.0	-24.8	PK	0	1.0	RB 1 MHz; VB: 1 MHz
10400.430	49.0	V	74.0	-25.0	PK	0	1.0	RB 1 MHz; VB: 1 MHz
6933.630	47.4	H	74.0	-26.6	PK	93	1.6	RB 1 MHz; VB: 1 MHz
3467.140	41.1	V	74.0	-32.9	PK	112	1.6	RB 1 MHz; VB: 1 MHz
3466.840	41.0	H	74.0	-33.0	PK	221	1.0	RB 1 MHz; VB: 1 MHz

Note 1: Above 1 GHz, the FCC specifies the limit as an average measurement. In addition, the FCC states that the peak reading of any emission above 1 GHz, can not exceed the average limit by more than 20 dB.

Client: Ruckus Wireless	Job Number: J77250
Model: 7962	T-Log Number: T77266
Contact: Craig Owens	Account Manager: Dean Eriksen
Standard: FCC Part 15.E/RSS-210	Class: B

Run #4: Preliminary Radiated Emissions, 30-1000 MHz
 EUT set to Receive mode at 5300 MHz

Frequency Range	Test Distance	Limit Distance	Extrapolation Factor
30 - 1000 MHz	3	3	0.0

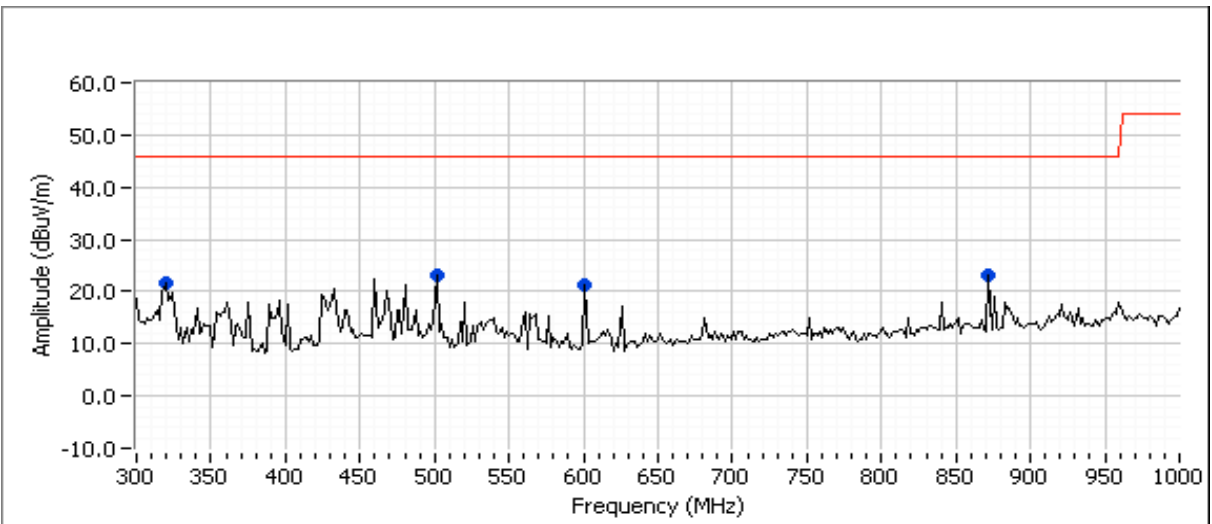
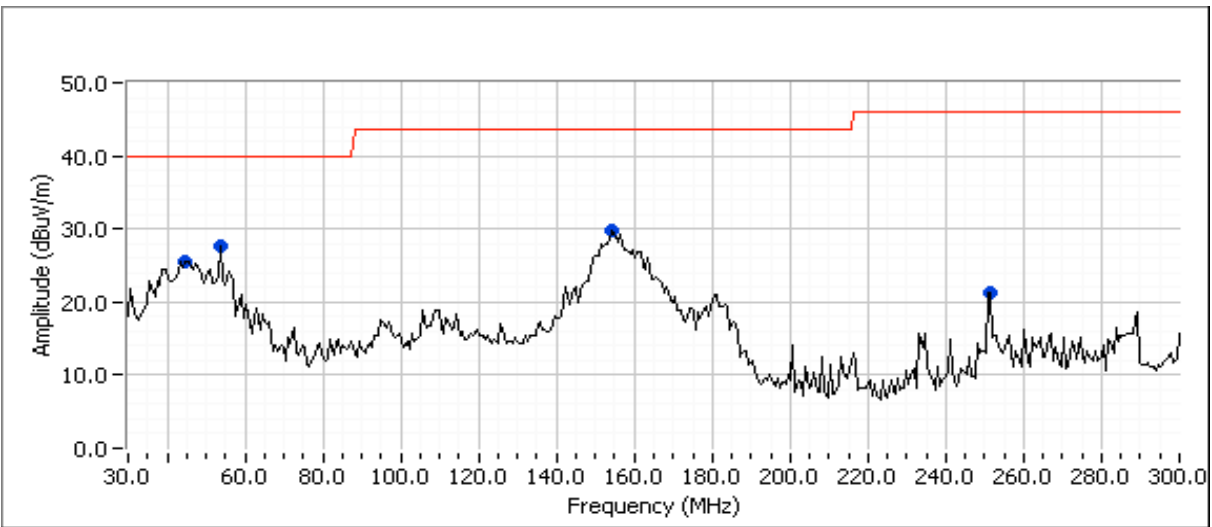

Client:	Ruckus Wireless	Job Number:	J77250
Model:	7962	T-Log Number:	T77266
Contact:	Craig Owens	Account Manager:	Dean Eriksen
Standard:	FCC Part 15.E/RSS-210	Class:	B

Run #4: Preliminary Radiated Emissions, 30-1000 MHz

Frequency	Level	Pol	RSS Gen		Detector	Azimuth	Height	Comments
MHz	dB μ V/m	v/h	Limit	Margin	Pk/QP/Avg	degrees	meters	
53.771	27.6	V	40.0	-12.4	Peak	0	1.7	
153.251	29.8	H	43.5	-13.7	Peak	239	1.7	
251.016	21.3	H	46.0	-24.7	Peak	299	1.7	
45.779	25.5	V	40.0	-14.5	Peak	301	1.7	
500.006	23.1	H	46.0	-22.9	Peak	331	1.7	
600.005	21.1	V	46.0	-24.9	Peak	269	1.7	
873.468	23.2	H	46.0	-22.8	Peak	61	1.7	
319.041	21.8	V	46.0	-24.2	Peak	298	1.7	

Run #5: Maximized Readings From Run #4

Frequency	Level	Pol	RSS Gen		Detector	Azimuth	Height	Comments
MHz	dB μ V/m	v/h	Limit	Margin	Pk/QP/Avg	degrees	meters	
53.771	26.9	V	40.0	-13.1	QP	0	1.7	
153.251	28.9	H	43.5	-14.6	QP	239	1.7	

Run #6a: Maximized readings, 1000 - 18000 MHz
EUT set to Receive mode at 5300 MHz, Lagacy Mode

Frequency Range	Test Distance	Limit Distance	Extrapolation Factor
1000 - 18000 MHz	3	3	0.0

Frequency	Level	Pol	RSS Gen		Detector	Azimuth	Height	Comments
MHz	dB μ V/m	v/h	Limit	Margin	Pk/QP/Avg	degrees	meters	
7066.740	50.9	V	54.0	-3.1	AVG	274	1.7	RB 1 MHz; VB: 10 Hz
7066.740	39.1	H	54.0	-14.9	AVG	269	2.0	RB 1 MHz; VB: 10 Hz
10600.930	38.3	H	54.0	-15.7	AVG	300	1.0	RB 1 MHz; VB: 10 Hz
10601.110	38.2	V	54.0	-15.8	AVG	317	1.0	RB 1 MHz; VB: 10 Hz
7066.660	54.0	V	74.0	-20.0	PK	274	1.7	RB 1 MHz; VB: 1 MHz
3534.630	30.3	H	54.0	-23.7	AVG	198	1.0	RB 1 MHz; VB: 10 Hz
3533.300	30.3	V	54.0	-23.7	AVG	322	1.0	RB 1 MHz; VB: 10 Hz
10600.070	50.1	V	74.0	-23.9	PK	317	1.0	RB 1 MHz; VB: 1 MHz
10599.660	49.3	H	74.0	-24.7	PK	300	1.0	RB 1 MHz; VB: 1 MHz
7066.650	48.2	H	74.0	-25.8	PK	269	2.0	RB 1 MHz; VB: 1 MHz
3532.020	42.2	H	74.0	-31.8	PK	198	1.0	RB 1 MHz; VB: 1 MHz
3534.820	42.2	V	74.0	-31.8	PK	322	1.0	RB 1 MHz; VB: 1 MHz

Note 1: Above 1 GHz, the FCC specifies the limit as an average measurement. In addition, the FCC states that the peak reading of any emission above 1 GHz, can not exceed the average limit by more than 20 dB.

Client: Ruckus Wireless	Job Number: J77250
Model: 7962	T-Log Number: T77266
Contact: Craig Owens	Account Manager: Dean Eriksen
Standard: FCC Part 15.E/RSS-210	Class: B

Run #6b: Maximized readings, 1000 - 18000 MHz
EUT set to Receive mode at 5300 MHz, HT-40 Mode

Frequency Range	Test Distance	Limit Distance	Extrapolation Factor
1000 - 18000 MHz	3	3	0.0

Frequency MHz	Level dB μ V/m	Pol v/h	RSS Gen		Detector Pk/QP/Avg	Azimuth degrees	Height meters	Comments
			Limit	Margin				
7066.710	50.7	V	54.0	-3.3	AVG	269	1.9	RB 1 MHz; VB: 10 Hz
10600.860	38.4	H	54.0	-15.6	AVG	245	1.0	RB 1 MHz; VB: 10 Hz
10600.920	38.3	V	54.0	-15.7	AVG	280	1.0	RB 1 MHz; VB: 10 Hz
7066.720	38.2	H	54.0	-15.8	AVG	277	1.6	RB 1 MHz; VB: 10 Hz
7066.790	54.2	V	74.0	-19.8	PK	269	1.9	RB 1 MHz; VB: 1 MHz
10600.910	50.6	V	74.0	-23.4	PK	280	1.0	RB 1 MHz; VB: 1 MHz
3533.170	30.3	V	54.0	-23.7	AVG	284	1.0	RB 1 MHz; VB: 10 Hz
3533.070	30.1	H	54.0	-23.9	AVG	248	1.0	RB 1 MHz; VB: 10 Hz
10600.560	49.6	H	74.0	-24.4	PK	245	1.0	RB 1 MHz; VB: 1 MHz
7066.540	48.3	H	74.0	-25.7	PK	277	1.6	RB 1 MHz; VB: 1 MHz
3532.550	41.6	V	74.0	-32.4	PK	284	1.0	RB 1 MHz; VB: 1 MHz
3534.100	41.4	H	74.0	-32.6	PK	248	1.0	RB 1 MHz; VB: 1 MHz

Note 1: Above 1 GHz, the FCC specifies the limit as an average measurement. In addition, the FCC states that the peak reading of any emission above 1 GHz, can not exceed the average limit by more than 20 dB.

Client: Ruckus Wireless	Job Number: J77250
Model: 7962	T-Log Number: T77266
Contact: Craig Owens	Account Manager: Dean Eriksen
Standard: FCC Part 15.E/RSS-210	Class: B

Run #7: Preliminary Radiated Emissions, 30-1000 MHz
 EUT set to Receive mode at 5600 MHz

Frequency Range	Test Distance	Limit Distance	Extrapolation Factor
30 - 1000 MHz	3	3	0.0

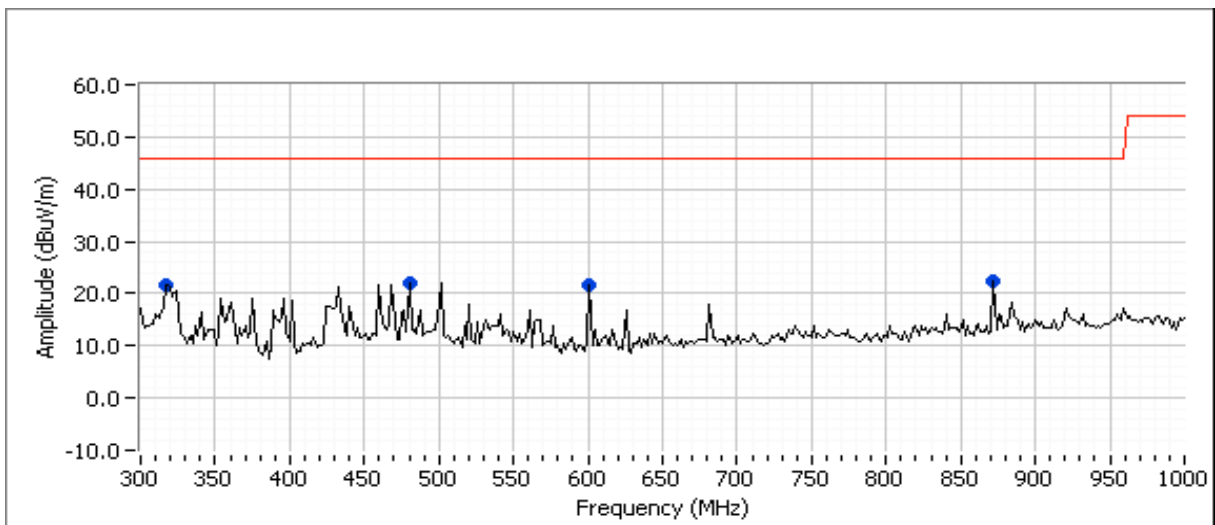
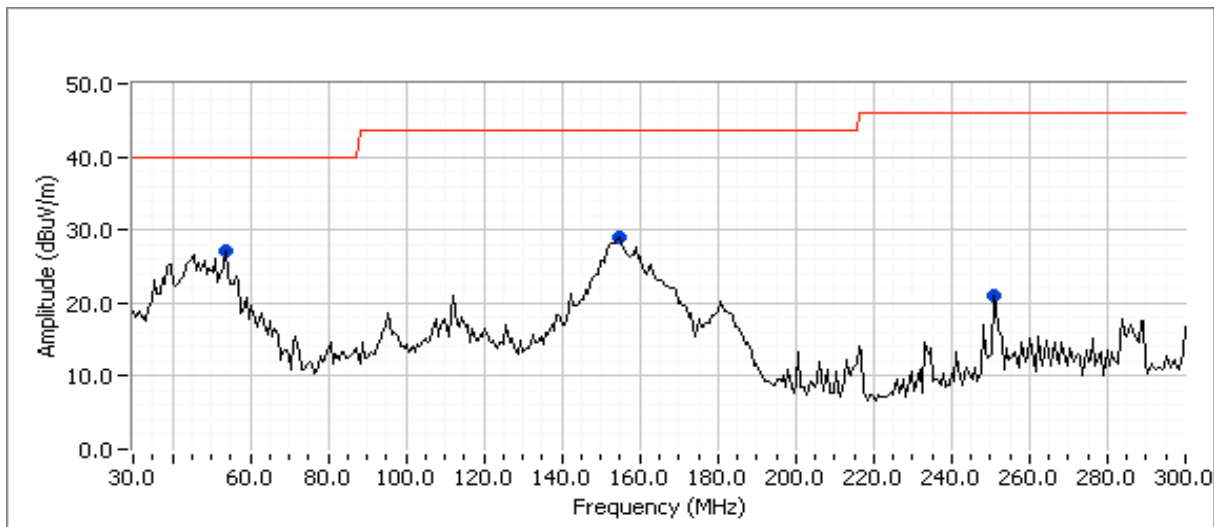



EMC Test Data

Client:	Ruckus Wireless	Job Number:	J77250
Model:	7962	T-Log Number:	T77266
Contact:	Craig Owens	Account Manager:	Dean Eriksen
Standard:	FCC Part 15.E/RSS-210	Class:	B

Run #7: Preliminary Radiated Emissions, 30-1000 MHz

Frequency	Level	Pol	RSS Gen		Detector	Azimuth	Height	Comments
MHz	dB μ V/m	v/h	Limit	Margin	Pk/QP/Avg	degrees	meters	
53.847	27.0	V	40.0	-13.0	Peak	89	1.7	
154.395	29.1	H	43.5	-14.4	Peak	241	1.7	
871.674	22.4	V	46.0	-23.6	Peak	360	1.7	
480.001	22.0	H	46.0	-24.0	Peak	31	1.7	
600.018	21.7	V	46.0	-24.3	Peak	58	1.7	
319.032	21.5	V	46.0	-24.5	Peak	298	1.7	
250.008	21.1	H	46.0	-24.9	Peak	301	1.7	

Run #8: Maximized Readings From Run #7

Frequency	Level	Pol	RSS Gen		Detector	Azimuth	Height	Comments
MHz	dB μ V/m	v/h	Limit	Margin	Pk/QP/Avg	degrees	meters	
53.847	26.0	V	40.0	-14.0	QP	89	1.7	
154.395	28.9	H	43.5	-14.6	QP	241	1.7	

Run #9a: Maximized readings, 18000 - 18000 MHz EUT set to Receive mode at 5600 MHz, Legacy Mode

Frequency Range	Test Distance	Limit Distance	Extrapolation Factor
1000 - 18000 MHz	3	3	0.0

Frequency	Level	Pol	RSS Gen		Detector	Azimuth	Height	Comments
MHz	dB μ V/m	v/h	Limit	Margin	Pk/QP/Avg	degrees	meters	
7466.720	49.7	V	54.0	-4.3	AVG	332	1.8	RB 1 MHz; VB: 10 Hz
7466.730	44.5	H	54.0	-9.5	AVG	234	1.5	RB 1 MHz; VB: 10 Hz
11200.920	38.6	H	54.0	-15.4	AVG	224	1.0	RB 1 MHz; VB: 10 Hz
11201.100	38.6	V	54.0	-15.4	AVG	314	1.0	RB 1 MHz; VB: 10 Hz
3733.390	38.4	V	54.0	-15.6	AVG	256	1.5	RB 1 MHz; VB: 10 Hz
3733.370	34.4	H	54.0	-19.6	AVG	69	1.8	RB 1 MHz; VB: 10 Hz
7466.660	53.6	V	74.0	-20.4	PK	332	1.8	RB 1 MHz; VB: 1 MHz
11200.950	52.5	H	74.0	-21.5	PK	224	1.0	RB 1 MHz; VB: 1 MHz
7466.950	50.1	H	74.0	-23.9	PK	234	1.5	RB 1 MHz; VB: 1 MHz
11200.500	49.4	V	74.0	-24.6	PK	314	1.0	RB 1 MHz; VB: 1 MHz
3733.330	46.4	V	74.0	-27.6	PK	256	1.5	RB 1 MHz; VB: 1 MHz
3733.320	44.2	H	74.0	-29.8	PK	69	1.8	RB 1 MHz; VB: 1 MHz

Note 1: Above 1 GHz, the FCC specifies the limit as an average measurement. In addition, the FCC states that the peak reading of any emission above 1 GHz, can not exceed the average limit by more than 20 dB.

Client:	Ruckus Wireless	Job Number:	J77250
Model:	7962	T-Log Number:	T77266
Contact:	Craig Owens	Account Manager:	Dean Eriksen
Standard:	FCC Part 15.E/RSS-210	Class:	B

Run #9b: Maximized readings, 1000 - 18000 MHz
 EUT set to Receive mode at 5600 MHz, HT-40 Mode

Frequency Range	Test Distance	Limit Distance	Extrapolation Factor
1000 - 18000 MHz	3	3	0.0

Frequency MHz	Level dB μ V/m	Pol v/h	RSS Gen		Detector Pk/QP/Avg	Azimuth degrees	Height meters	Comments
			Limit	Margin				
7466.700	49.9	V	54.0	-4.1	AVG	328	1.9	RB 1 MHz; VB: 10 Hz
7466.720	44.0	H	54.0	-10.0	AVG	219	1.6	RB 1 MHz; VB: 10 Hz
3733.400	39.0	V	54.0	-15.0	AVG	325	1.3	RB 1 MHz; VB: 10 Hz
11200.840	38.8	H	54.0	-15.2	AVG	214	1.0	RB 1 MHz; VB: 10 Hz
11200.910	38.5	V	54.0	-15.5	AVG	263	1.0	RB 1 MHz; VB: 10 Hz
7466.620	53.9	V	74.0	-20.1	PK	328	1.9	RB 1 MHz; VB: 1 MHz
11200.750	53.1	H	74.0	-20.9	PK	214	1.0	RB 1 MHz; VB: 1 MHz
3733.320	31.3	H	54.0	-22.7	AVG	360	1.0	RB 1 MHz; VB: 10 Hz
7466.480	50.2	H	74.0	-23.8	PK	219	1.6	RB 1 MHz; VB: 1 MHz
11200.560	49.8	V	74.0	-24.2	PK	263	1.0	RB 1 MHz; VB: 1 MHz
3733.340	45.7	V	74.0	-28.3	PK	325	1.3	RB 1 MHz; VB: 1 MHz
3732.190	42.1	H	74.0	-31.9	PK	360	1.0	RB 1 MHz; VB: 1 MHz

Note 1: Above 1 GHz, the FCC specifies the limit as an average measurement. In addition, the FCC states that the peak reading of any emission above 1 GHz, can not exceed the average limit by more than 20 dB.



EMC Test Data

Client:	Ruckus Wireless	Job Number:	J77270
Model:	7962	T-Log Number:	T77267
		Account Manager:	Dean Eriksen
Contact:	Craig Owens		-
Emissions Standard(s):	FCC Part 15.247/RSS-210	Class:	B
Immunity Standard(s):	-	Environment:	-

EMC Test Data

For The

Ruckus Wireless

Model

7962

Date of Last Test: 10/29/2009

Client:	Ruckus Wireless	Job Number:	J77270
Model:	7962	T-Log Number:	T77267
Contact:	Craig Owens	Account Manager:	Dean Eriksen
Standard:	FCC Part 15.247/RSS-210	Class:	N/A

**RSS-210 (LELAN) and FCC 15.407(UNII)
Antenna Port Measurements
Power, PSD, Peak Excursion, Bandwidth and Spurious Emissions**

Test Specific Details

Objective: The objective of this test session is to perform final qualification testing of the EUT with respect to the specification listed above.

Date of Test: 3/19/2009
Test Engineer: Mehran Birgani
Test Location: SVOATS #2

Config. Used: 1
Config Change: None
EUT Voltage: 120V/60Hz

General Test Configuration

When measuring the conducted emissions from the EUT's antenna port, the antenna port of the EUT was connected to the spectrum analyzer or power meter via a suitable attenuator to prevent overloading the measurement system. All measurements are corrected to allow for the external attenuators and cables used.

Ambient Conditions: Temperature: 18.7 °C
Rel. Humidity: 36 %

Summary of Results

Run #	Test Performed	Limit	Pass / Fail	Result / Margin
1	Power, 5250 - 5350MHz	15.407(a) (1), (2)	Pass	23.1 dBm (0.205W)
1	Power, 5470 - 5725MHz	15.407(a) (1), (2)	Pass	23.1 dBm (0.205W)
1	PSD, 5250 - 5350MHz	15.407(a) (1), (2)	Pass	10.95 dBm/MHz
1	PSD, 5470 - 5725MHz	15.407(a) (1), (2)	Pass	10.99 dBm/MHz
1	26dB Bandwidth	15.407	-	22.8 MHz
1	99% Bandwidth	RSS 210	-	17.2 MHz
2	Peak Excursion Envelope	15.407(a) (6)	Pass	12.1 dB
3	Antenna Conducted Out of Band Spurious	15.407(b)	Pass	All emissions below the -27dBm/MHz limit

Modifications Made During Testing

No modifications were made to the EUT during testing

Deviations From The Standard

No deviations were made from the requirements of the standard.

Client: Ruckus Wireless	Job Number: J77270
Model: 7962	T-Log Number: T77267
Contact: Craig Owens	Account Manager: Dean Eriksen
Standard: FCC Part 15.247/RSS-210	Class: N/A

Note - Testing performed on 5580 MHz, was done on 10/29/09 by Suhaila Khushzad and Mehran Birgani

Run #1: Bandwidth, Output Power and Power spectral Density

	Chain 1	Chain 2	Chain 3	Coherent	Effective ⁵
Antenna Gain (dBi):	3.0	3.0	3.0	No	3.0

Frequency (MHz)	Software Setting	26dB BW (MHz)	Measured Output Power ¹ dBm			Total		Limit (dBm)	Max Power (W)	Pass or Fail
			Chain 1	Chain 2	Chain 3	mW	dBm			
5260	19.5	31.4	17.9	18.9	18.2	205.4	23.1	24.0	0.205	PASS
5300	19.5	30.0	17.7	18.5	17.8	189.9	22.8	24.0		PASS
5320	16.5	23.3	15.1	14.9	15.0	94.9	19.8	24.0		PASS
5500	19.5	22.8	18.2	17.4	17.2	173.5	22.4	24.0	0.205	PASS
5580	21.0	26.1	17.4	18.2	17.7	179.7	22.5	24.0		PASS
5700	19.0	25.5	18.9	18.3	17.8	205.5	23.1	24.0		PASS

Frequency (MHz)	99% ⁴ BW	Total Power	PSD ² dBm/MHz			Total PSD		Limit		Pass or Fail
			Chain 1	Chain 2	Chain 3	mW/MHz	dBm/MHz	FCC	RSS 210 ³	
5260	17.1	23.1	5.9	6.7	5.9	12.5	10.95	11.0	11.0	PASS
5300	17.1	22.8	5.4	6.3	5.5	11.3	10.52	11.0	11.0	PASS
5320	16.9	19.8	3.0	2.5	2.8	5.7	7.54	11.0	11.0	PASS
5500	16.9	22.4	6.1	5.0	5.0	10.4	10.17	11.0	11.0	PASS
5580	17.2	22.5	4.9	5.8	5.1	10.2	10.08	11.0	11.0	PASS
5700	17.0	23.1	6.7	6.2	5.7	12.6	10.99	11.0	11.0	PASS

Note 1:	Output power measured using a spectrum analyzer (see plots below): RBW=1MHz, VB=3 MHz, sample detector, power averaging on (transmitted signal was continuous) and power integration over 50 MHz
Note 2:	Measured using the same analyzer settings used for output power.
Note 3:	For RSS-210 the limit for the 5150 - 5250 MHz band accounts for the antenna gain as the maximum eirp allowed is 10dBm/MHz. The limits are also corrected for instances where the highest measured value of the PSD exceeds the average PSD (calculated from the measured power divided by the measured 99% bandwidth) by more than 3dB by the amount that the measured value exceeds the average by more than 3dB.
Note 4:	99% Bandwidth measured in accordance with RSS GEN - RB > 1% of span and VB >=3xRB
Note 5:	For MIMO systems the total output power and total PSD are calculated from the sum of the powers of the individual chains (in linear terms). The antenna gain used to determine the EIRP and limits for PSD/Output power depends on the operating mode of the MIMO device. If the signals on the non-coherent between the transmit chains then the gain used to determine the limits is the highest gain of the individual chains and the EIRP is the sum of the products of gain and power on each chain. If the signals are coherent then the effective antenna gain is the sum (in linear terms) of the gains for each chain and the EIRP is the product of the effective gain and total power.

Client: Ruckus Wireless	Job Number: J77270
Model: 7962	T-Log Number: T77267
Contact: Craig Owens	Account Manager: Dean Eriksen
Standard: FCC Part 15.247/RSS-210	Class: N/A

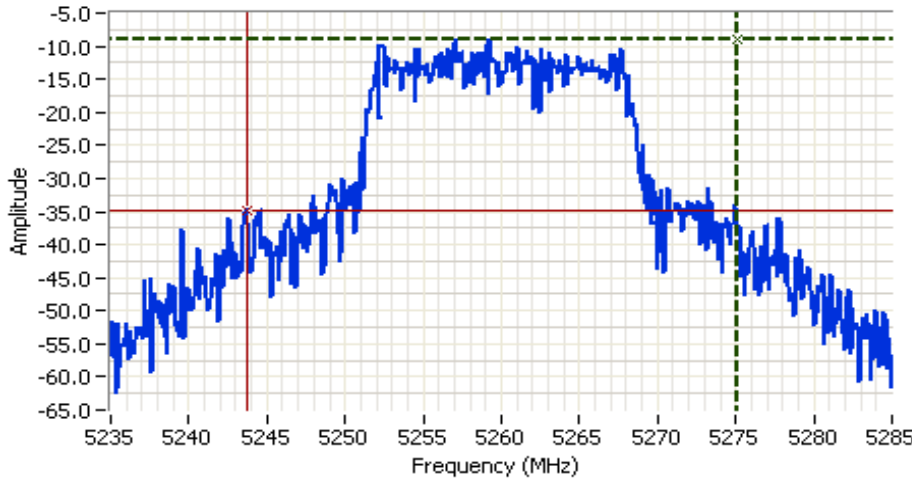

Analyzer Settings
 Agilent Technologies, E4446A
 CF: 5260.000 MHz
 SPAN: 50.000 MHz
 RB: 1.000 MHz
 VB: 3.000 MHz
 Detector: PK (CISPR)
 Attn: 10 DB
 RL Offset: 0.0 DB
 Sweep Time: 1.0ms
 Ref Lvl: 0.0 DBM

Comments
 26dB BW: 31.4 MHz
 802.11a chain 2

Cursor 1	5275.0833	-8.96		Delta Freq.	31.417
Cursor 2	5243.6667	-34.96		Delta Amplitude	26.00

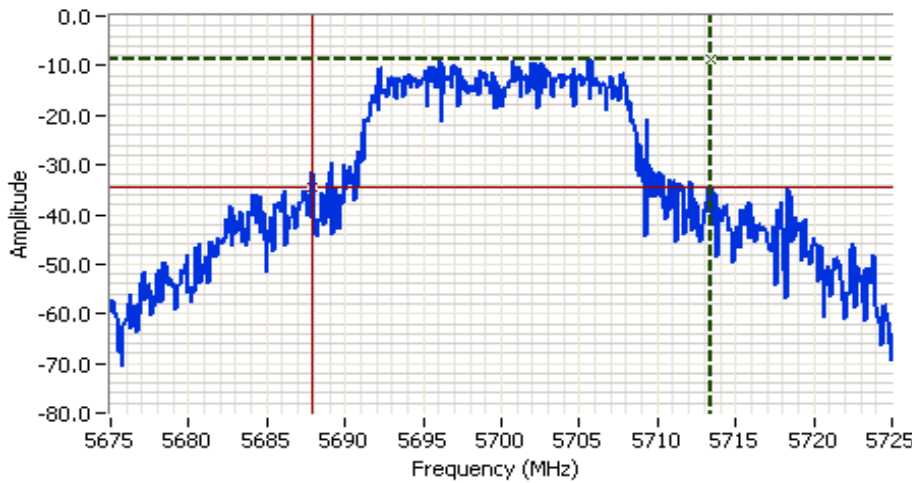

Analyzer Settings
 Agilent Technologies, E4446A
 CF: 5700.000 MHz
 SPAN: 50.000 MHz
 RB: 1.000 MHz
 VB: 3.000 MHz
 Detector: PK (CISPR)
 Attn: 10 DB
 RL Offset: 0.0 DB
 Sweep Time: 1.0ms
 Ref Lvl: 0.0 DBM

Comments
 26dB BW: 25.5 MHz
 802.11a chain 2

Cursor 1	5713.4167	-8.60		Delta Freq.	25.500
Cursor 2	5687.9167	-34.60		Delta Amplitude	26.00



Client: Ruckus Wireless	Job Number: J77270
Model: 7962	T-Log Number: T77267
Contact: Craig Owens	Account Manager: Dean Eriksen
Standard: FCC Part 15.247/RSS-210	Class: N/A

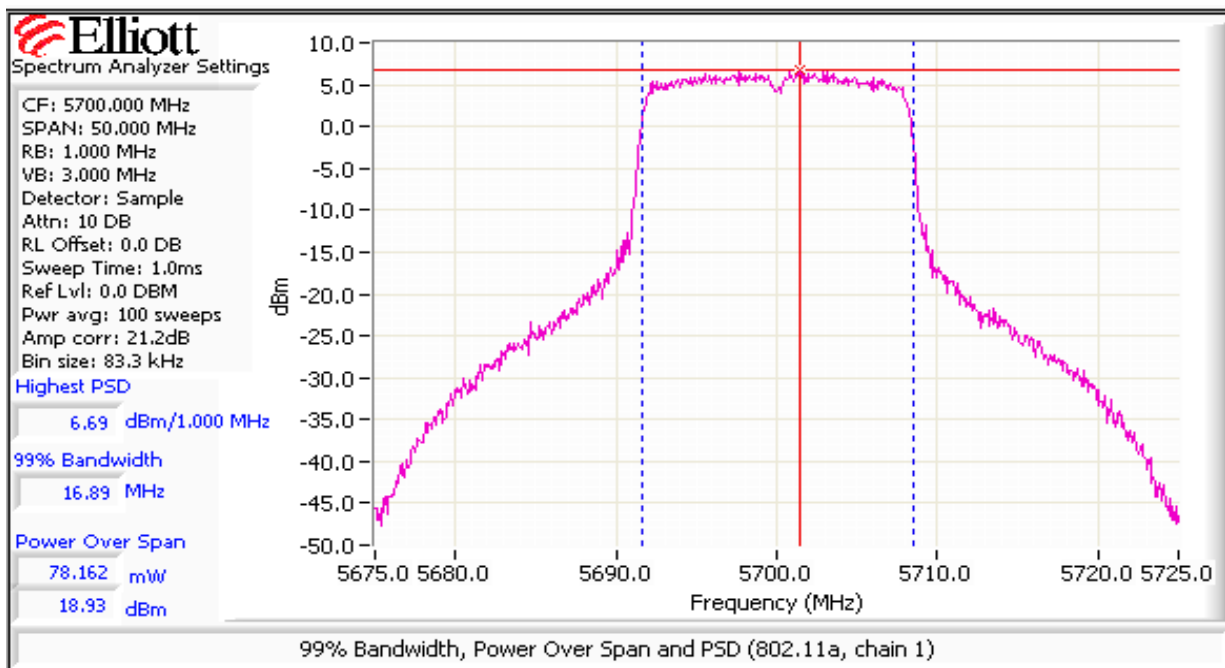
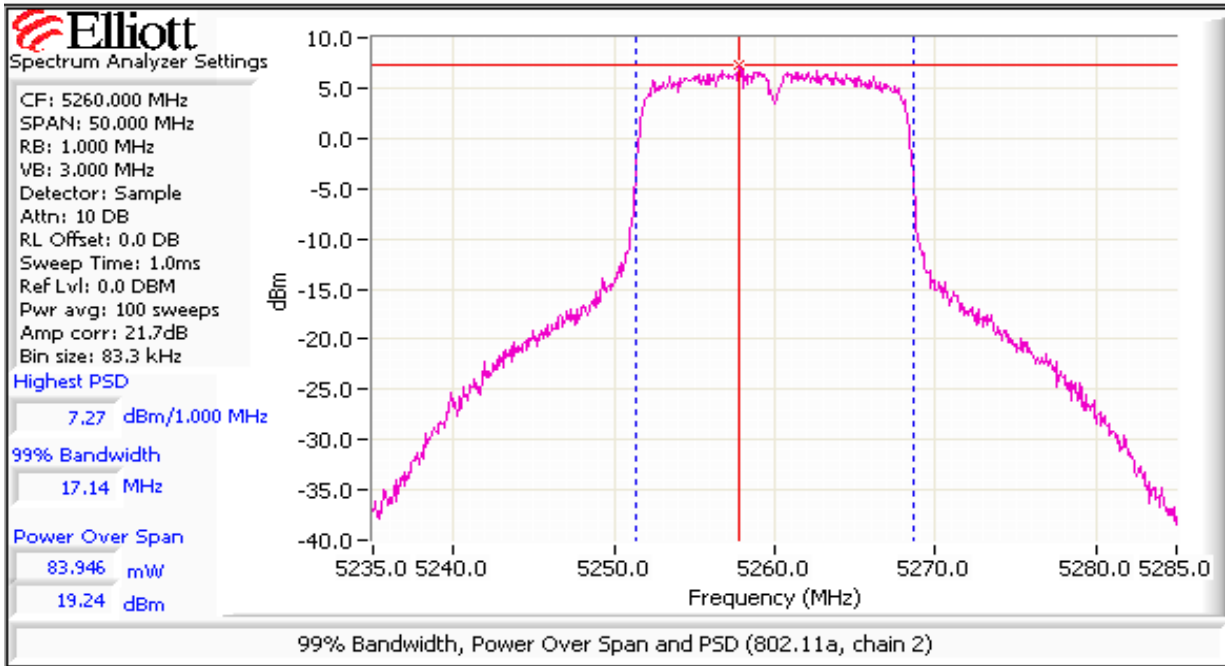

Client: Ruckus Wireless	Job Number: J77270
Model: 7962	T-Log Number: T77267
Contact: Craig Owens	Account Manager: Dean Eriksen
Standard: FCC Part 15.247/RSS-210	Class: N/A

Run #2: Peak Excursion Measurement

Device meets the requirement for the peak excursion

Freq (MHz)	Peak Excursion(dB) Value	Peak Excursion(dB) Limit	Freq (MHz)	Peak Excursion(dB) Value	Peak Excursion(dB) Limit	Freq (MHz)	Peak Excursion(dB) Value	Peak Excursion(dB) Limit
5180		13.0	5260	9.4	13.0	5500	9.1	13.0
5200		13.0	5300	9.0	13.0	5580	12.1	13.0
5240		13.0	5320	9.4	13.0	5700	9.4	13.0

Plots Showing Peak Excursion

Trace A: RBW = 1MHz, VBW = 3MHz, Peak hold

Trace B: Same settings as used for power/PSD measurements (RBW = 1 MHz, VBW = 3MHz, Integrated average power)

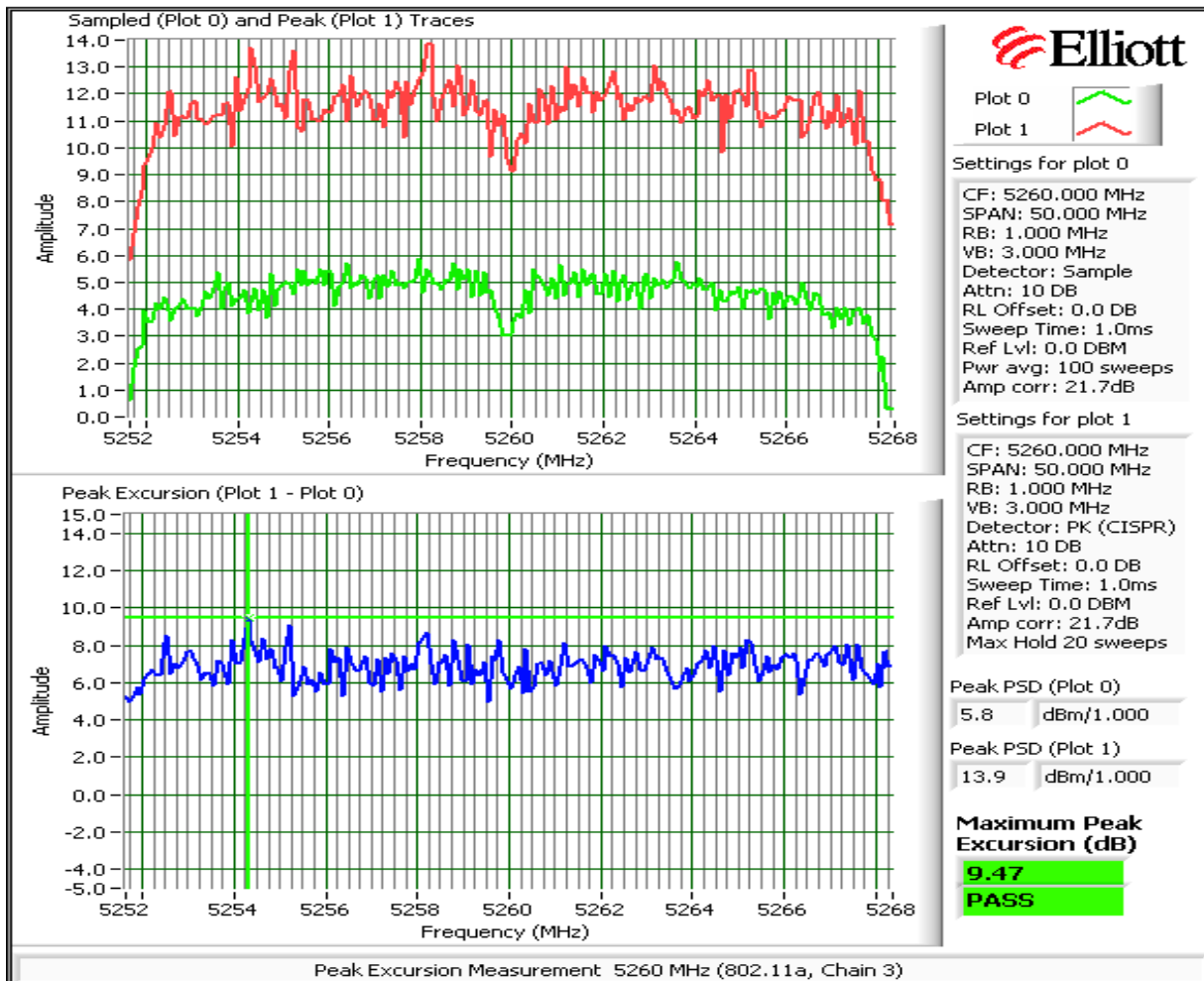

Client: Ruckus Wireless	Job Number: J77270
Model: 7962	T-Log Number: T77267
Contact: Craig Owens	Account Manager: Dean Eriksen
Standard: FCC Part 15.247/RSS-210	Class: N/A

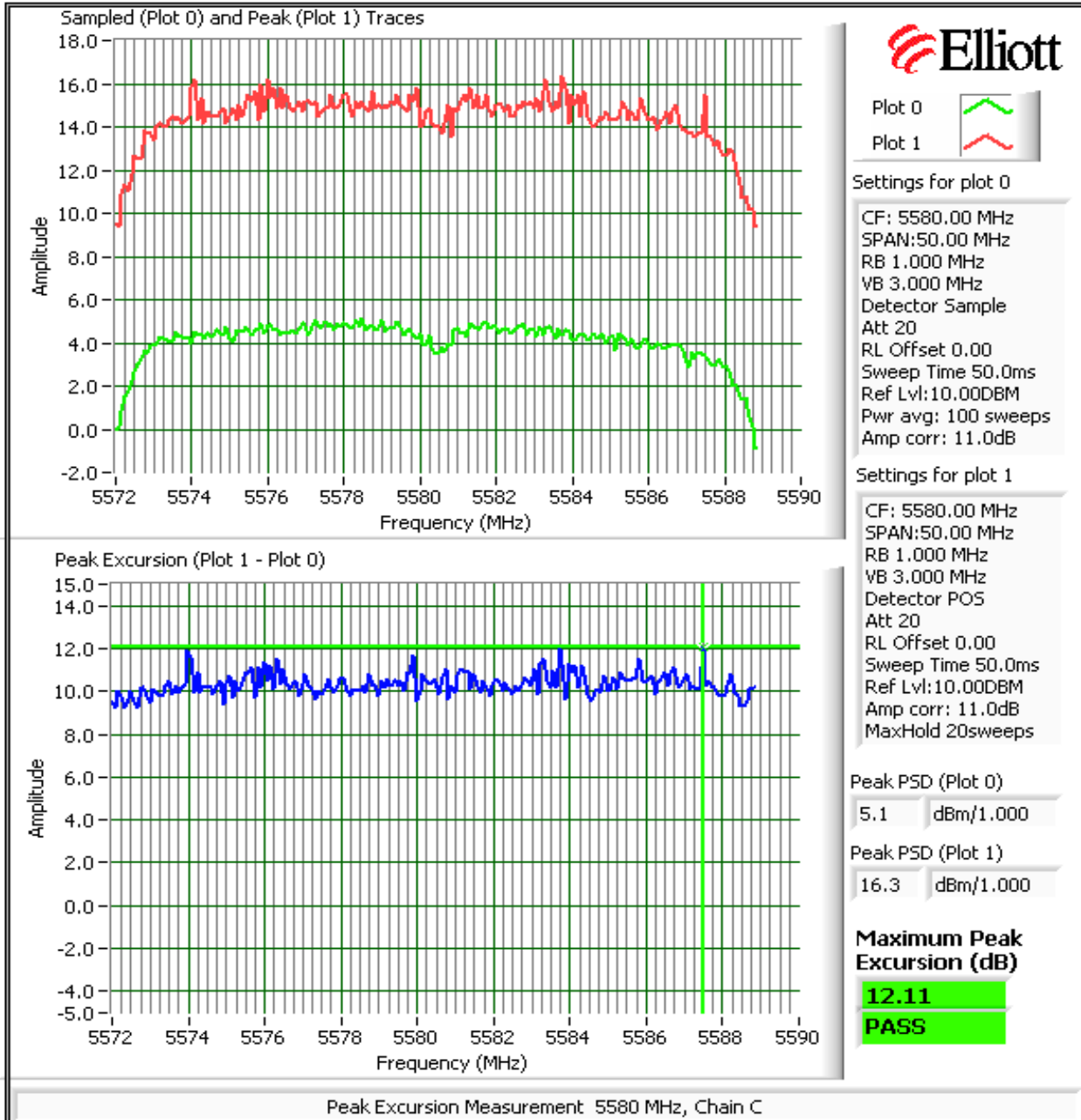

Client: Ruckus Wireless	Job Number: J77270
Model: 7962	T-Log Number: T77267
Contact: Craig Owens	Account Manager: Dean Eriksen
Standard: FCC Part 15.247/RSS-210	Class: N/A

Run #3: Out Of Band Spurious Emissions - Antenna Conducted

MIMO Devices: Antenna gain used is the effective gain calculated in the power section of this data sheet. The plots were obtained with all chains transmitting simultaneously and connected to the analyzer via a combiner. Unused ports of the combiner were terminated in the appropriate load (50 ohms).

Number of transmit chains: 3
 Maximum Antenna Gain: 3.0 dBi
 Spurious Limit: -27.0 dBm/MHz eirp
 Limit Used On Plots ^{Note 1}: -30.0 dBm/MHz Average Limit (RB=1MHz, VB=10Hz)
 -10.0 dBm/MHz Peak Limit (RB=VB=1MHz)

- Note 1: The -27dBm/MHz limit is an eirp limit. The limit for antenna port conducted measurements is adjusted to take into consideration the maximum antenna gain (limit = -27dBm - antenna gain). Radiated field strength measurements for signals more than 50MHz from the bands and that are close to the limit are made to determine compliance as the antenna gain is not known at these frequencies.
- Note 2: All spurious signals below 1GHz are measured during digital device radiated emissions test.
- Note 3: Signals within 10MHz of the 5.725 or 5.825 Band edge are subject to a limit of -17dBm EIRP
- Note 4: If the device is for outdoor use then the -27dBm eirp limit also applies in the 5150 - 5250 MHz band.
- Note 5: Signals that fall in the restricted bands of 15.205 are subject to the limit of 15.209.

Plots Showing Out-Of-Band Emissions (RBW=VBW=1MHz)

Low channel, 5250 - 5350 MHz Band

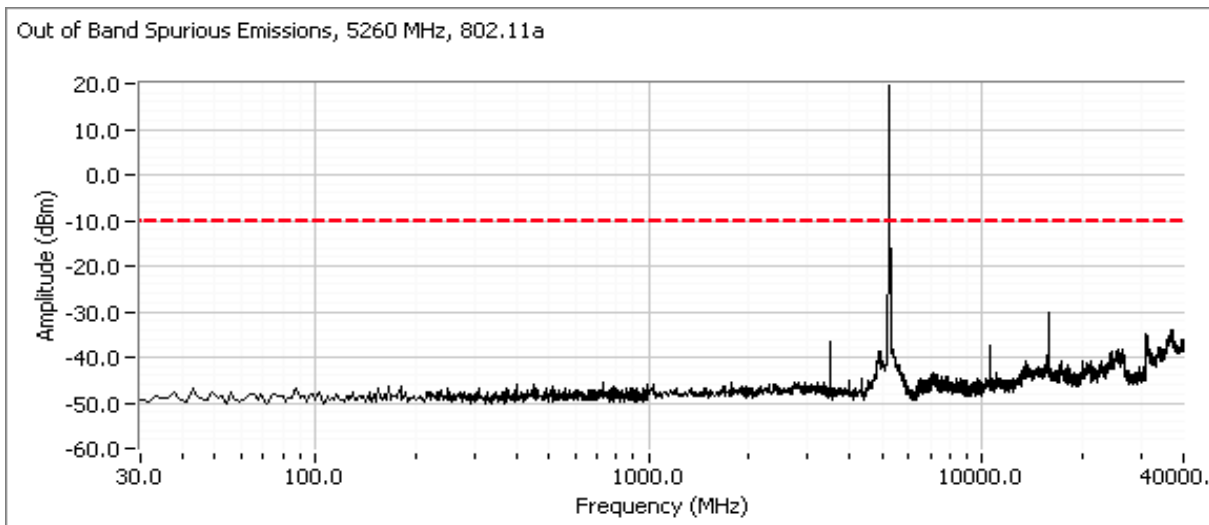

Client: Ruckus Wireless	Job Number: J77270
Model: 7962	T-Log Number: T77267
Contact: Craig Owens	Account Manager: Dean Eriksen
Standard: FCC Part 15.247/RSS-210	Class: N/A

Center channel, 5250 - 5350 MHz Band

Out of Band Spurious Emissions, 5300 MHz, 802.11a

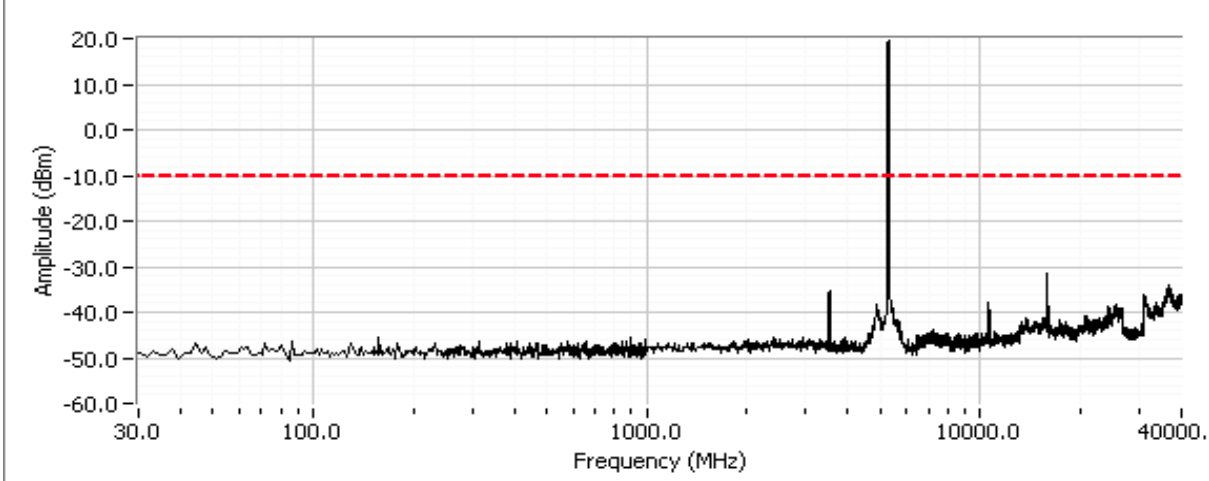

High channel, 5250 - 5350 MHz Band

Compliance with the radiated limits for the restricted band immediately above 5350MHz is demonstrated through the radiated emissions tests.

Out of Band Spurious Emissions, 5320 MHz, 802.11a

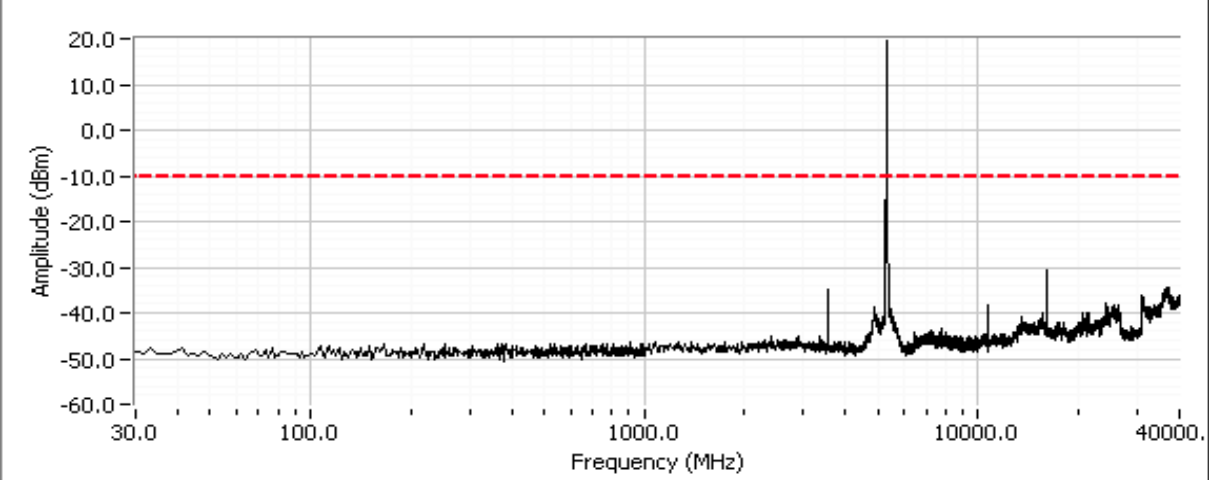

Client: Ruckus Wireless	Job Number: J77270
Model: 7962	T-Log Number: T77267
Contact: Craig Owens	Account Manager: Dean Eriksen
Standard: FCC Part 15.247/RSS-210	Class: N/A

Low channel, 5470 - 5725 MHz Band

Includes a plot from 5460 - 5500 MHz showing compliance with the limit immediately below the allocated band from 5460-5470 MHz. Compliance with the radiated limits for the restricted band below 5460 MHz is demonstrated through the radiated emissions tests.

Out of Band Spurious Emissions, 5500 MHz, 802.11a

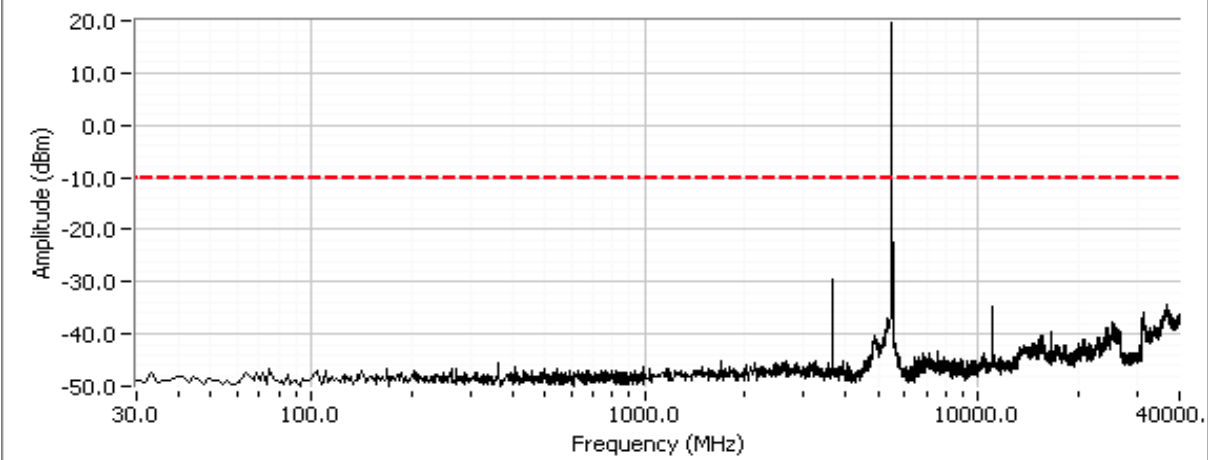

Out of Band Spurious Emissions, 5500 MHz, 802.11a, Bandedge

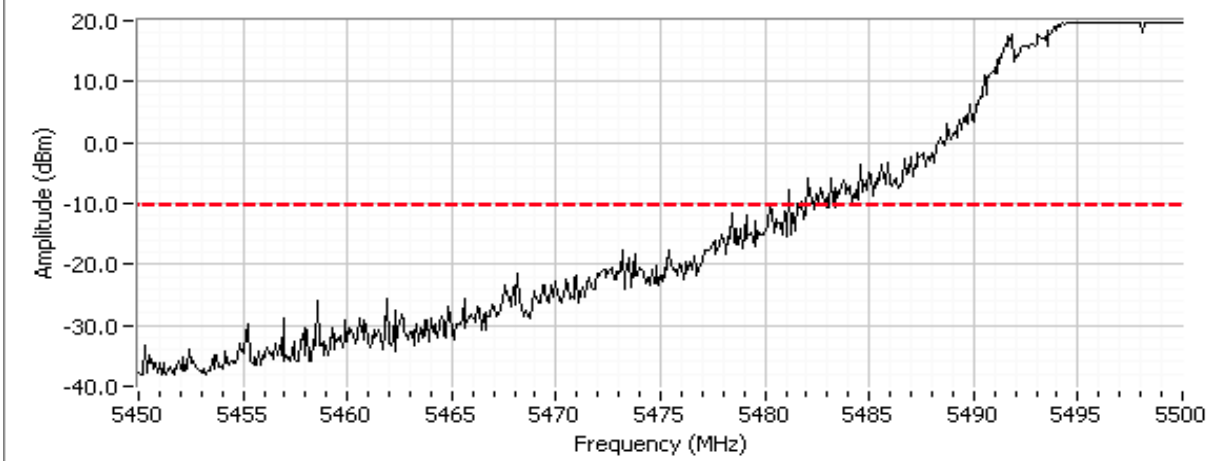

Client: Ruckus Wireless	Job Number: J77270
Model: 7962	T-Log Number: T77267
Contact: Craig Owens	Account Manager: Dean Eriksen
Standard: FCC Part 15.247/RSS-210	Class: N/A

Center channel, 5470 - 5725 MHz Band

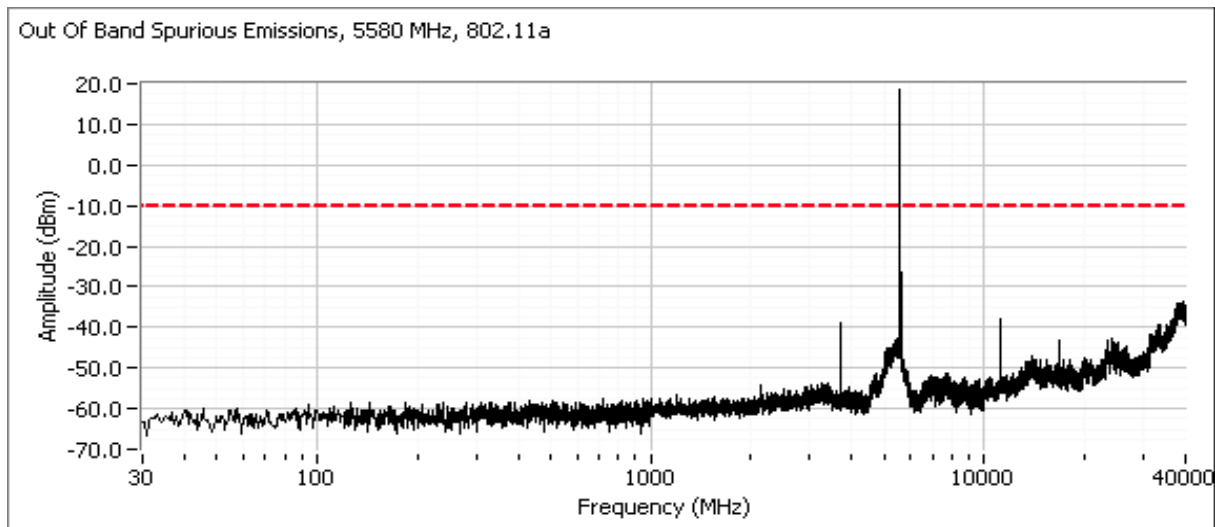

High channel, 5470 - 5725 MHz Band

Includes a plot from 5700 - 5780 MHz showing compliance with the limit immediately above the allocated band.

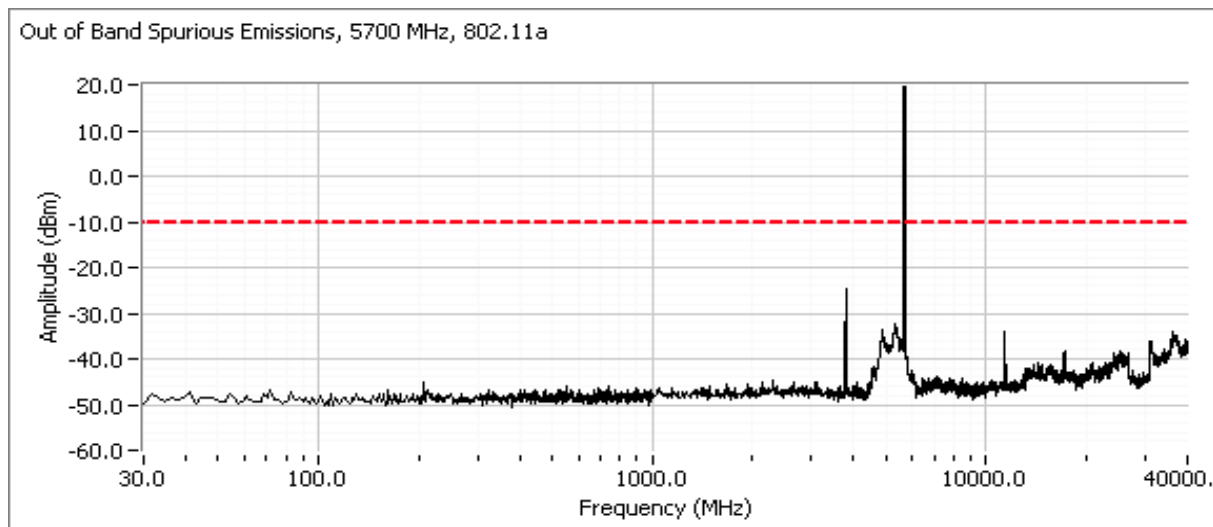

Client: Ruckus Wireless	Job Number: J77270
Model: 7962	T-Log Number: T77267
Contact: Craig Owens	Account Manager: Dean Eriksen
Standard: FCC Part 15.247/RSS-210	Class: N/A

Out of Band Spurious Emissions, 5700 MHz, 802.11a, Bandedge

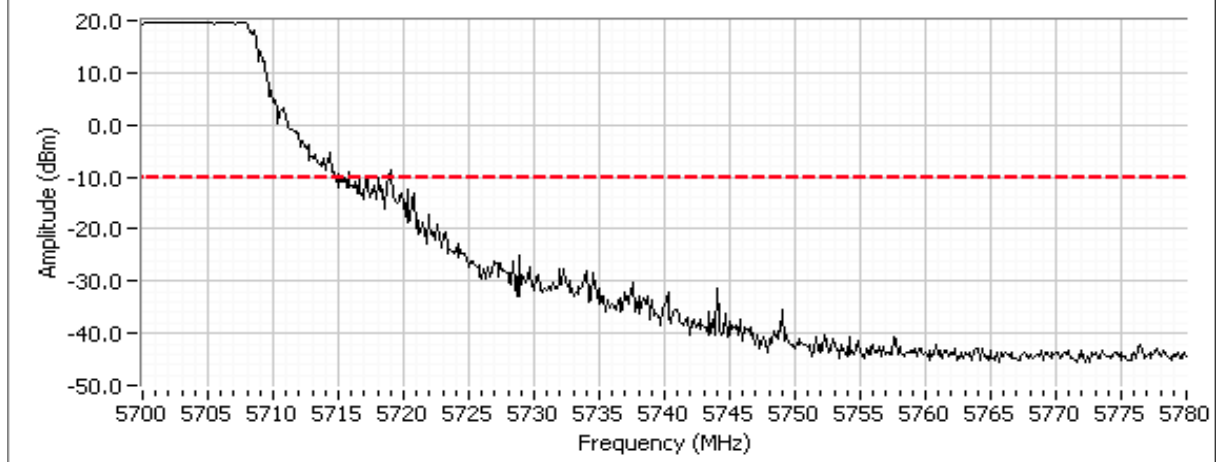

Client: Ruckus Wireless	Job Number: J77270
Model: 7962	T-Log Number: T77267
Contact: Craig Owens	Account Manager: Dean Eriksen
Standard: FCC Part 15.247/RSS-210	Class: N/A

Run #4: 20dB Bandwidth - Channels Adjacent to 5600-5650MHz band

Date of Test: 10/29/2009 Config. Used: 1
 Test Engineer: Suhaila K/Mehran B Config Change: None
 Test Location: SVOATS #2 EUT Voltage: 120V/60Hz

These measurements are used to demonstrate that the 20dB bandwidth of the channels either side of the 5600-5650 MHz band do not fall into the 5600-5650 MHz band.

Measurements made with RB=VB=300kHz, peak detector.

20dB bandwidth - 5580MHz, Chain A

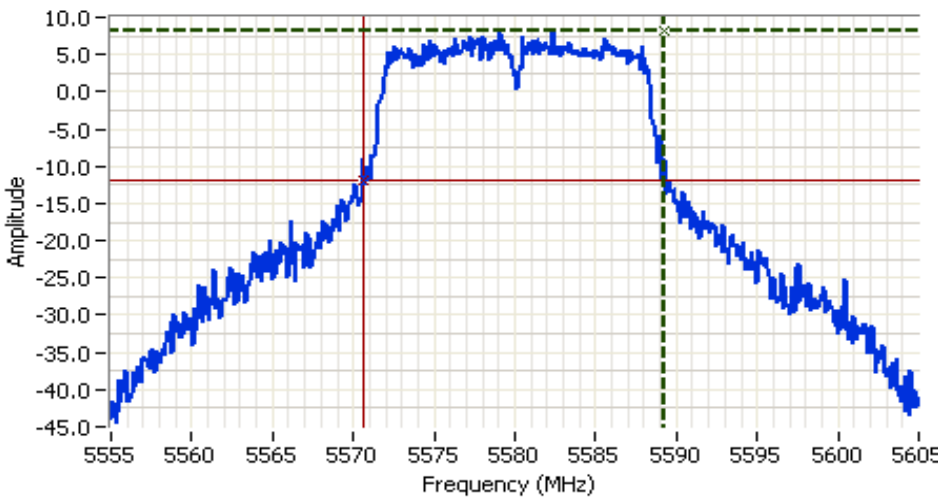

Analyzer Settings

CF: 5580.000 MHz
 SPAN:50.000 MHz
 RB 300 kHz
 VB 300 kHz
 Detector POS
 Att 20
 RL Offset 11.00
 Sweep Time 50.0ms
 Ref Lvl:21.00DBM

Comments

20dB BW: 18.667 MHz
 802.11a, Chain 1

Cursor 1	5589.2500	8.17	
Cursor 2	5570.5833	-11.83	

Delta Freq. 18.667
 Delta Amplitude 20.00

Client: Ruckus Wireless	Job Number: J77270
Model: 7962	T-Log Number: T77267
Contact: Craig Owens	Account Manager: Dean Eriksen
Standard: FCC Part 15.247/RSS-210	Class: N/A

20dB bandwidth - 5580MHz, Chain B

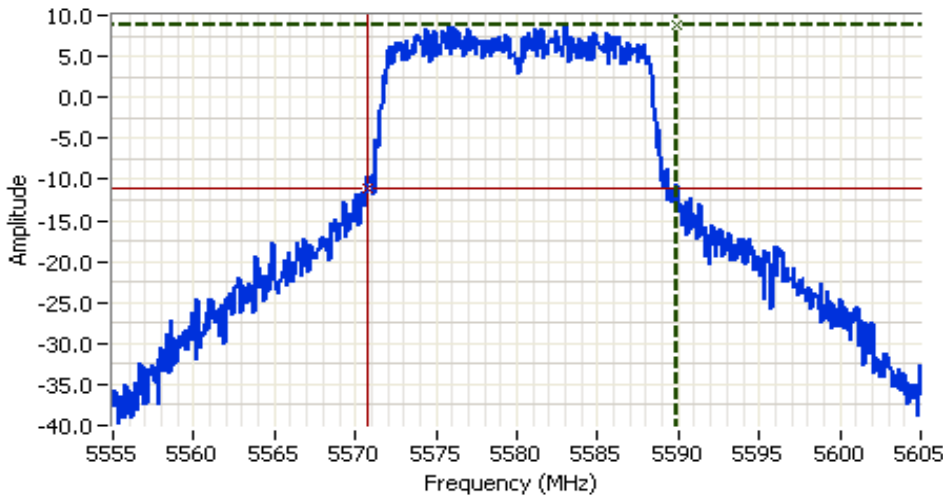

Analyzer Settings

HP8564E
 CF: 5580.000 MHz
 SPAN:50.000 MHz
 RB 300 kHz
 VB 300 kHz
 Detector POS
 Att 20
 RL Offset 11.00
 Sweep Time 50.0ms
 Ref Lvl:21.00DBM

Comments

20dB BW: 19.167 MHz

Cursor 1	5589.9167	8.83		Delta Freq.	19.167
Cursor 2	5570.7500	-11.17		Delta Amplitude	20.00



20dB bandwidth - 5580MHz, Chain C

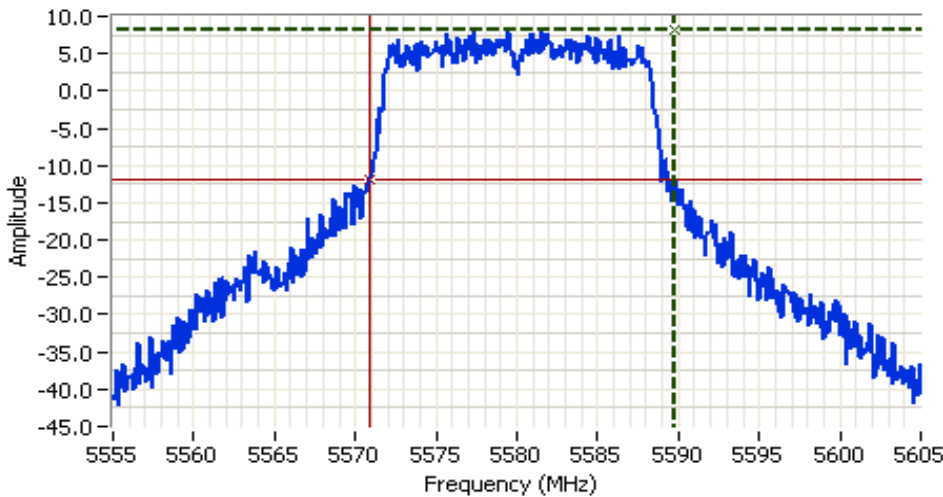

Analyzer Settings

HP8564E
 CF: 5580.000 MHz
 SPAN:50.000 MHz
 RB 300 kHz
 VB 300 kHz
 Detector POS
 Att 20
 RL Offset 11.00
 Sweep Time 50.0ms
 Ref Lvl:21.00DBM

Comments

20dB BW: 18.833 MHz
 802.11a, Chain 2

Cursor 1	5589.7500	8.17		Delta Freq.	18.833
Cursor 2	5570.9167	-11.83		Delta Amplitude	20.00



Client: Ruckus Wireless	Job Number: J77270
Model: 7962	T-Log Number: T77267
Contact: Craig Owens	Account Manager: Dean Eriksen
Standard: FCC Part 15.247/RSS-210	Class: N/A

20dB bandwidth - 5660MHz, Chain A

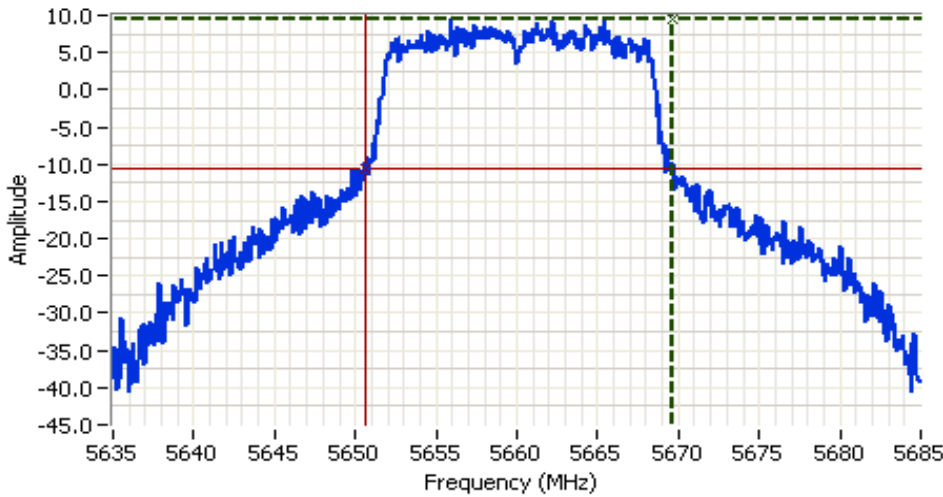



Analyzer Settings

HP8564E
 CF: 5660.000 MHz
 SPAN: 50.000 MHz
 RB 300 kHz
 VB 300 kHz
 Detector POS
 Att 20
 RL Offset 11.00
 Sweep Time 50.0ms
 Ref Lvl: 21.00DBM

Comments

20dB BW: 19.000 MHz
 802.11a, Chain 1

Cursor 1 5669.6667 9.50 

Cursor 2 5650.6667 -10.50 

Delta Freq. 19.000

Delta Amplitude 20.00



20dB bandwidth - 5660MHz, Chain B

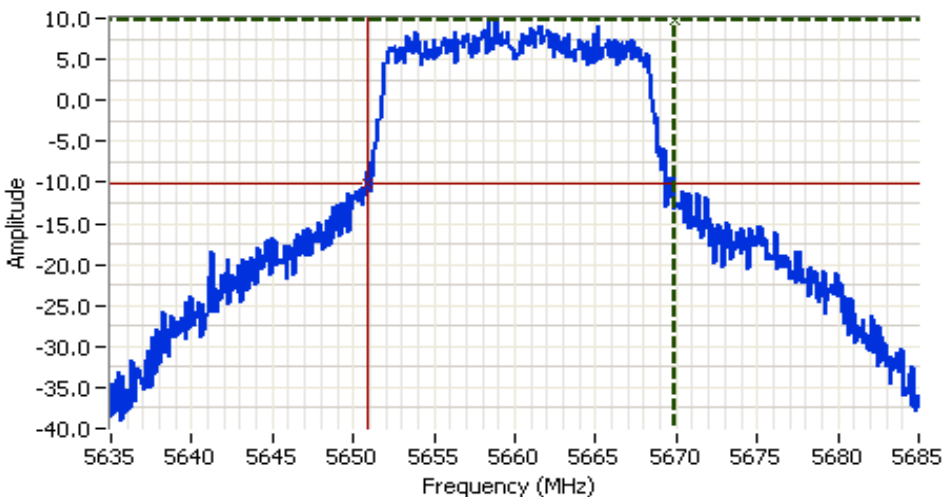

Analyzer Settings

HP8564E
 CF: 5660.000 MHz
 SPAN: 50.000 MHz
 RB 300 kHz
 VB 300 kHz
 Detector POS
 Att 20
 RL Offset 11.00
 Sweep Time 50.0ms
 Ref Lvl: 21.00DBM

Comments

20dB BW: 19.000 MHz
 802.11a, Chain 2

Cursor 1 5669.8333 9.83 

Cursor 2 5650.8333 -10.17 

Delta Freq. 19.000

Delta Amplitude 20.00



Client: Ruckus Wireless	Job Number: J77270
Model: 7962	T-Log Number: T77267
Contact: Craig Owens	Account Manager: Dean Eriksen
Standard: FCC Part 15.247/RSS-210	Class: N/A

20dB bandwidth - 5660MHz, Chain C

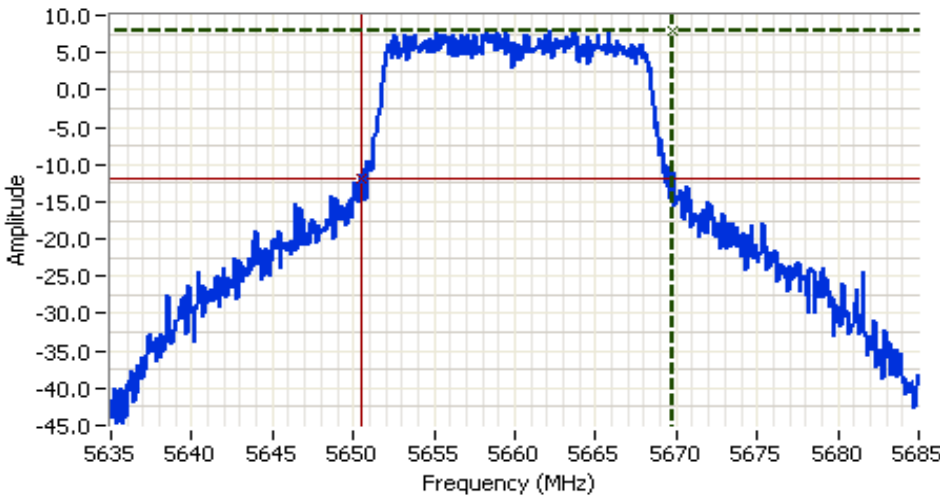

Analyzer Settings

HP8564E
 CF: 5660.000 MHz
 SPAN: 50.000 MHz
 RB 300 kHz
 VB 300 kHz
 Detector POS
 Att 20
 RL Offset 11.00
 Sweep Time 50.0ms
 Ref Lvl: 21.00DBM

Comments

20dB BW: 19.250 MHz
 802.11a, Chain 3

Cursor 1	5669.7500	8.00		Delta Freq.	19.250	
Cursor 2	5650.5000	-12.00		Delta Amplitude	20.00	

Client: Ruckus Wireless	Job Number: J77270
Model: 7962	T-Log Number: T77267
	Account Manager: Dean Eriksen
Contact: Craig Owens	
Standard: FCC Part 15.247/RSS-210	Class: N/A

Note - Testing performed on 5580 MHz, was done on 10/29/09 by Suhaila Khushzad and Mehran Birgani

Run #1: Bandwidth, Output Power and Power spectral Density

	Chain 1	Chain 2	Chain 3	Coherent	Effective ⁵
Antenna Gain (dBi):	3.0	3.0	3.0	No	3.0

Frequency (MHz)	Software Setting	26dB BW (MHz)	Measured Output Power ¹ dBm			Total		Limit (dBm)	Max Power (W)	Pass or Fail
			Chain 1	Chain 2	Chain 3	mW	dBm			
5260	19.0	25.3	17.4	18.6	18.2	193.7	22.9	24.0	0.198	PASS
5300	19.5	25.3	17.6	18.4	18.5	197.5	23.0	24.0		PASS
5320	16.0	26.2	14.4	14.8	14.9	88.6	19.5	24.0		PASS
5500	19.5	26.8	18.0	17.5	17.3	173.0	22.4	24.0	0.223	PASS
5580	20.0	25.8	16.5	17.4	16.8	147.5	21.7	24.0		PASS
5700	19.5	27.1	19.1	18.7	18.3	223.0	23.5	24.0		PASS

Frequency (MHz)	99% ⁴ BW	Total Power	PSD ² dBm/MHz			Total PSD		Limit		Pass or Fail
			Chain 1	Chain 2	Chain 3	mW/MHz	dBm/MHz	FCC	RSS 210 ³	
5260	18.2	22.9	4.7	6.0	5.6	10.5	10.21	11.0	11.0	PASS
5300	18.1	23.0	5.5	6.0	6.1	11.6	10.63	11.0	11.0	PASS
5320	18.1	19.5	2.0	2.3	2.4	5.0	7.01	11.0	11.0	PASS
5500	18.1	22.4	5.6	5.2	4.8	9.9	9.97	11.0	11.0	PASS
5580	18.1	21.7	4.0	5.2	4.2	8.5	9.27	11.0	11.0	PASS
5700	18.1	23.5	6.5	6.1	5.9	12.4	10.95	11.0	11.0	PASS

Note 1:	Output power measured using a spectrum analyzer (see plots below): RBW=1MHz, VB=3 MHz, sample detector, power averaging on (transmitted signal was continuous) and power integration over 50 MHz
Note 2:	Measured using the same analyzer settings used for output power.
Note 3:	For RSS-210 the limit for the 5150 - 5250 MHz band accounts for the antenna gain as the maximum eirp allowed is 10dBm/MHz. The limits are also corrected for instances where the highest measured value of the PSD exceeds the average PSD (calculated from the measured power divided by the measured 99% bandwidth) by more than 3dB by the amount that the measured value exceeds the average by more than 3dB.
Note 4:	99% Bandwidth measured in accordance with RSS GEN - RB > 1% of span and VB >=3xRB
Note 5:	For MIMO systems the total output power and total PSD are calculated from the sum of the powers of the individual chains (in linear terms). The antenna gain used to determine the EIRP and limits for PSD/Output power depends on the operating mode of the MIMO device. If the signals on the non-coherent between the transmit chains then the gain used to determine the limits is the highest gain of the individual chains and the EIRP is the sum of the products of gain and power on each chain. If the signals are coherent then the effective antenna gain is the sum (in linear terms) of the gains for each chain and the EIRP is the product of the effective gain and total power.

Client: Ruckus Wireless	Job Number: J77270
Model: 7962	T-Log Number: T77267
Contact: Craig Owens	Account Manager: Dean Eriksen
Standard: FCC Part 15.247/RSS-210	Class: N/A

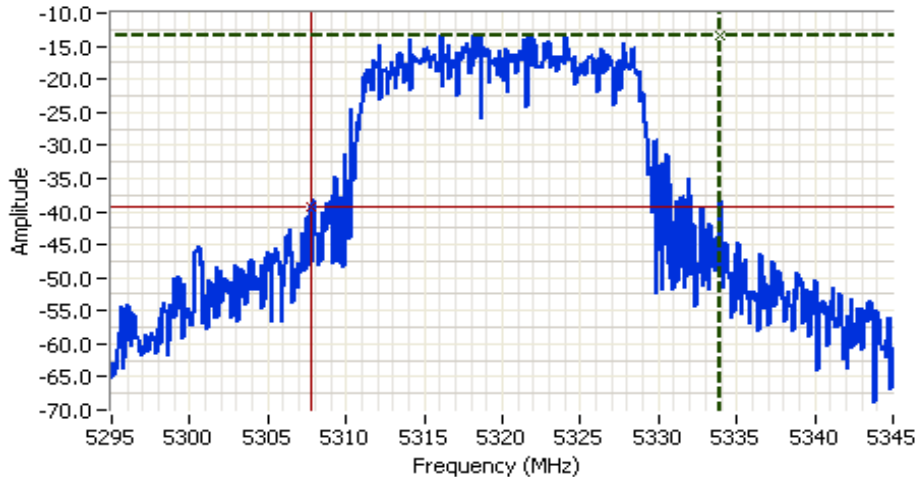

Analyzer Settings
 Agilent Technologies, E4446A
 CF: 5320.000 MHz
 SPAN: 50.000 MHz
 RB: 1.000 MHz
 VB: 3.000 MHz
 Detector: PK (CISPR)
 Attn: 10 DB
 RL Offset: 0.0 DB
 Sweep Time: 1.0ms
 Ref Lvl: 0.0 DBM

Comments
 26dB BW: 26.167 MHz
 802.11n 20MHz, chain 2

Cursor 1 5333.9167 -13.29    Delta Freq. 26.167
 Cursor 2 5307.7500 -39.29    Delta Amplitude 26.00

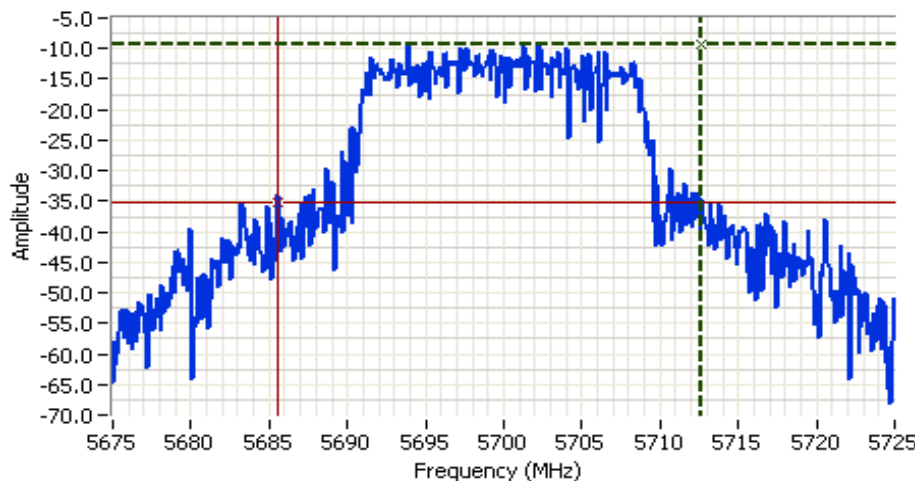

Analyzer Settings
 Agilent Technologies, E4446A
 CF: 5700.000 MHz
 SPAN: 50.000 MHz
 RB: 1.000 MHz
 VB: 3.000 MHz
 Detector: PK (CISPR)
 Attn: 10 DB
 RL Offset: 0.0 DB
 Sweep Time: 1.0ms
 Ref Lvl: 0.0 DBM

Comments
 26dB BW: 27.083 MHz
 802.11n 20MHz, chain 2

Cursor 1 5712.6667 -9.28    Delta Freq. 27.083
 Cursor 2 5685.5833 -35.27    Delta Amplitude 26.00



Client: Ruckus Wireless	Job Number: J77270
Model: 7962	T-Log Number: T77267
Contact: Craig Owens	Account Manager: Dean Eriksen
Standard: FCC Part 15.247/RSS-210	Class: N/A

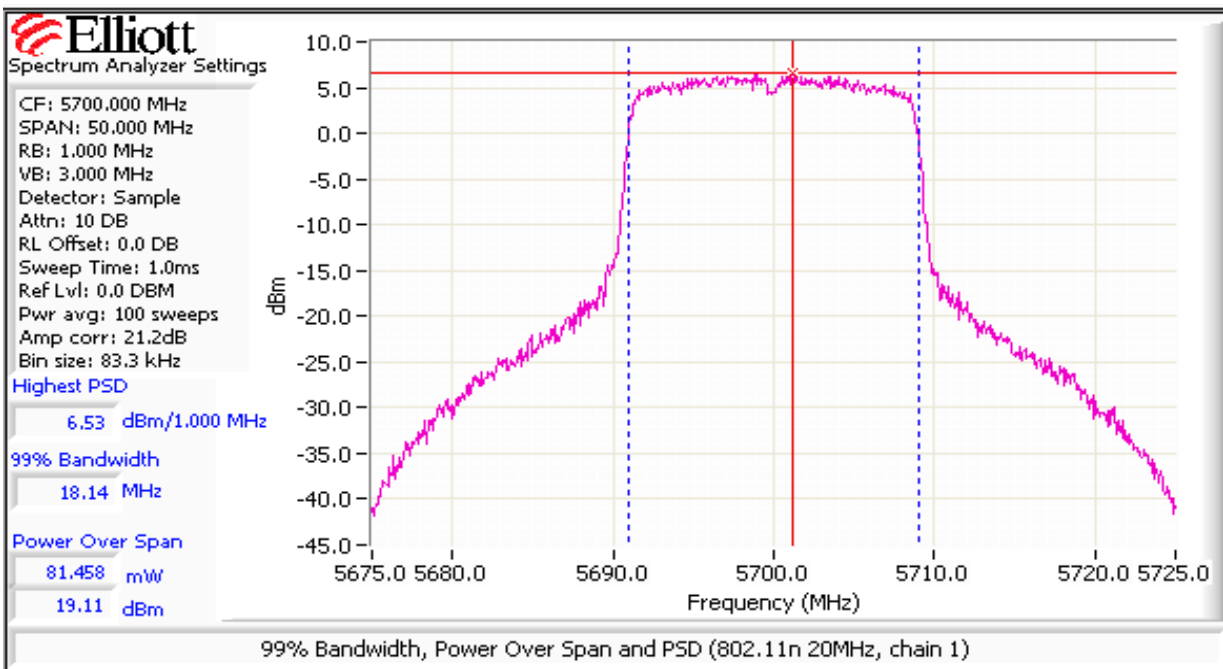
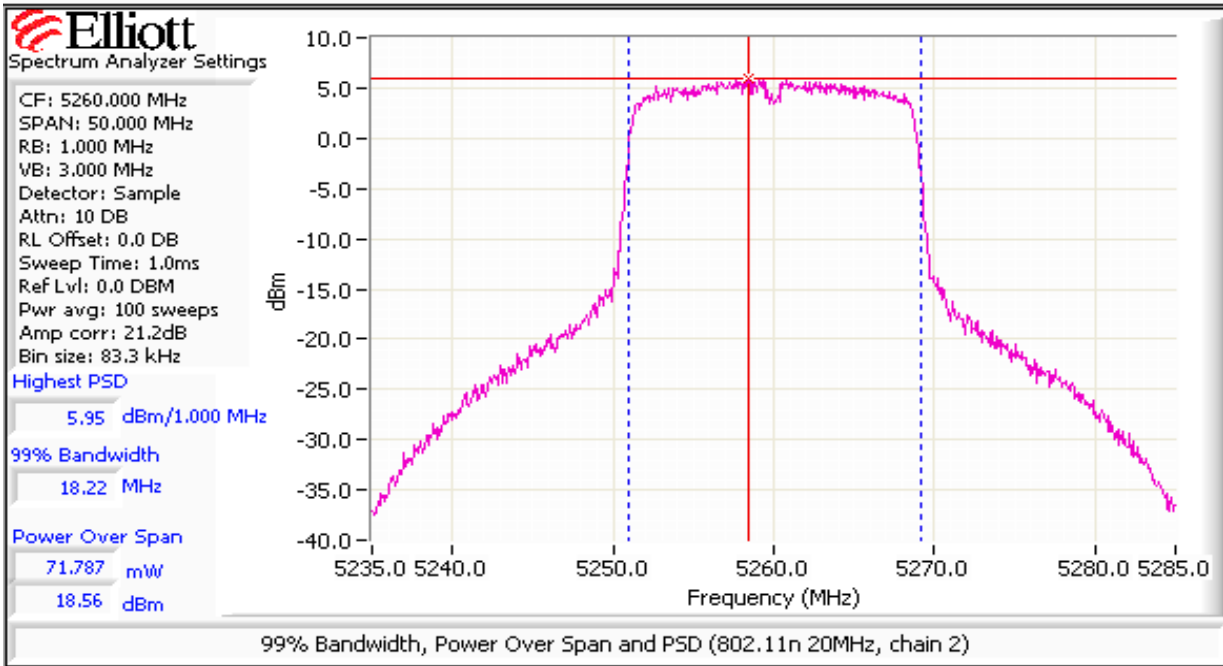

Client: Ruckus Wireless	Job Number: J77270
Model: 7962	T-Log Number: T77267
Contact: Craig Owens	Account Manager: Dean Eriksen
Standard: FCC Part 15.247/RSS-210	Class: N/A

Run #2: Peak Excursion Measurement

Device meets the requirement for the peak excursion

Freq (MHz)	Peak Excursion(Value)	Peak Excursion(Limit)	Freq (MHz)	Peak Excursion(Value)	Peak Excursion(Limit)	Freq (MHz)	Peak Excursion(Value)	Peak Excursion(Limit)
5180		13.0	5260	9.6	13.0	5500	9.3	13.0
5200		13.0	5300	9.0	13.0	5580	9.2	13.0
5240		13.0	5320	9.2	13.0	5700	9.4	13.0

Plots Showing Peak Excursion

Trace A: RBW = 1MHz, VBW = 3MHz, Peak hold

Trace B: Same settings as used for power/PSD measurements (RBW = 1 MHz, VBW = 3MHz, Integrated average power)

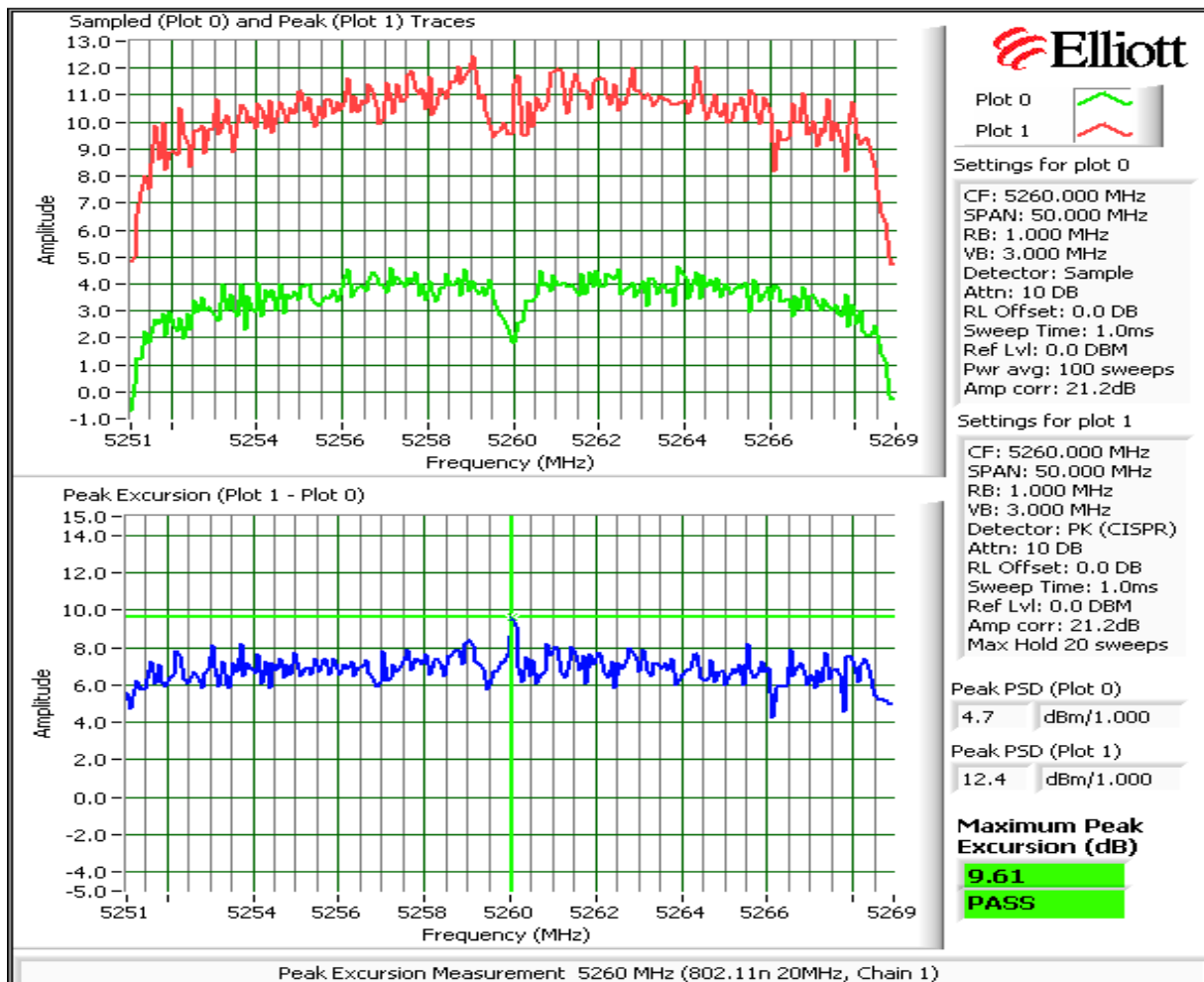

Client: Ruckus Wireless	Job Number: J77270
Model: 7962	T-Log Number: T77267
Contact: Craig Owens	Account Manager: Dean Eriksen
Standard: FCC Part 15.247/RSS-210	Class: N/A

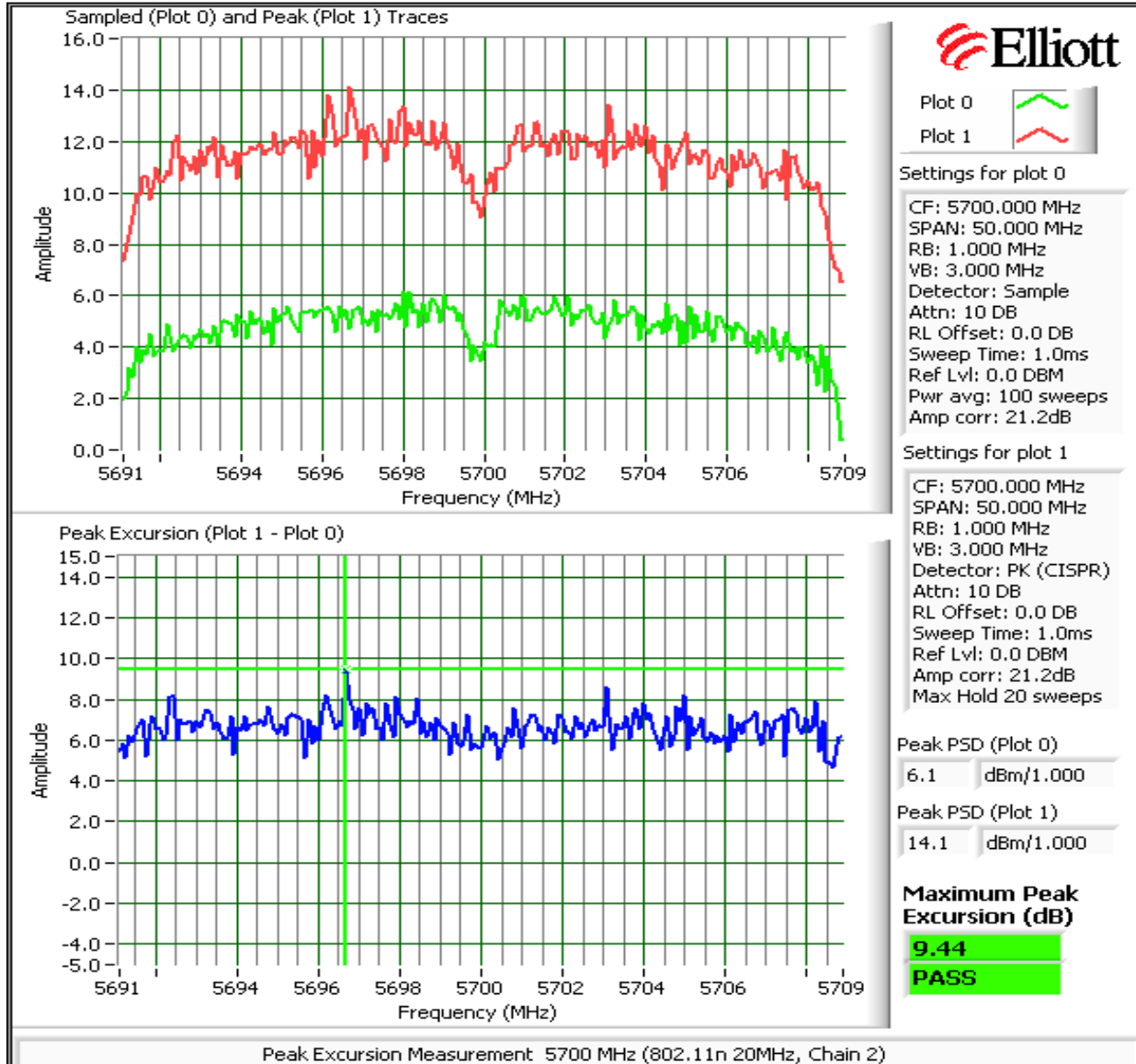

Client:	Ruckus Wireless	Job Number:	J77270
Model:	7962	T-Log Number:	T77267
Contact:	Craig Owens	Account Manager:	Dean Eriksen
Standard:	FCC Part 15.247/RSS-210	Class:	N/A

Run #3: Out Of Band Spurious Emissions - Antenna Conducted

MIMO Devices: Antenna gain used is the effective gain calculated in the power section of this data sheet. The plots were obtained with all chains transmitting simultaneously and connected to the analyzer via a combiner. Unused ports of the combiner were terminated in the appropriate load (50 ohms).

Number of transmit chains: 3
 Maximum Antenna Gain: 3.0 dBi
 Spurious Limit: -27.0 dBm/MHz eirp
 Limit Used On Plots ^{Note 1}: -30.0 dBm/MHz Average Limit (RB=1MHz, VB=10Hz)
 -10.0 dBm/MHz Peak Limit (RB=VB=1MHz)

- Note 1: The -27dBm/MHz limit is an eirp limit. The limit for antenna port conducted measurements is adjusted to take into consideration the maximum antenna gain (limit = -27dBm - antenna gain). Radiated field strength measurements for signals more than 50MHz from the bands and that are close to the limit are made to determine compliance as the antenna gain is not known at these frequencies.
- Note 2: All spurious signals below 1GHz are measured during digital device radiated emissions test.
- Note 3: Signals within 10MHz of the 5.725 or 5.825 Band edge are subject to a limit of -17dBm EIRP
- Note 4: If the device is for outdoor use then the -27dBm eirp limit also applies in the 5150 - 5250 MHz band.
- Note 5: Signals that fall in the restricted bands of 15.205 are subject to the limit of 15.209.

Plots Showing Out-Of-Band Emissions (RBW=VBW=1MHz)

Low channel, 5250 - 5350 MHz Band

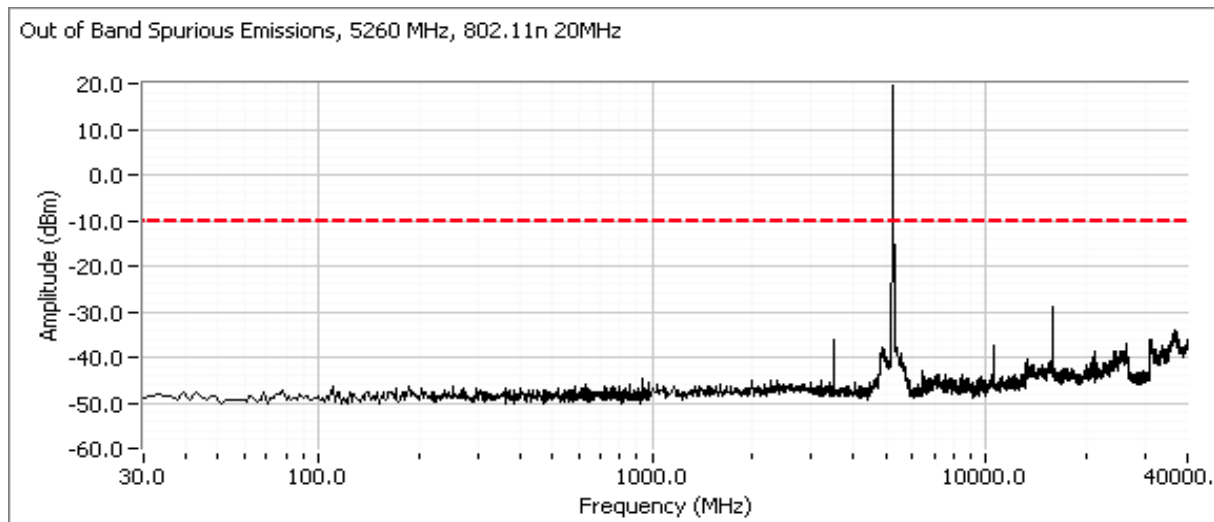

Client: Ruckus Wireless	Job Number: J77270
Model: 7962	T-Log Number: T77267
Contact: Craig Owens	Account Manager: Dean Eriksen
Standard: FCC Part 15.247/RSS-210	Class: N/A

Center channel, 5250 - 5350 MHz Band

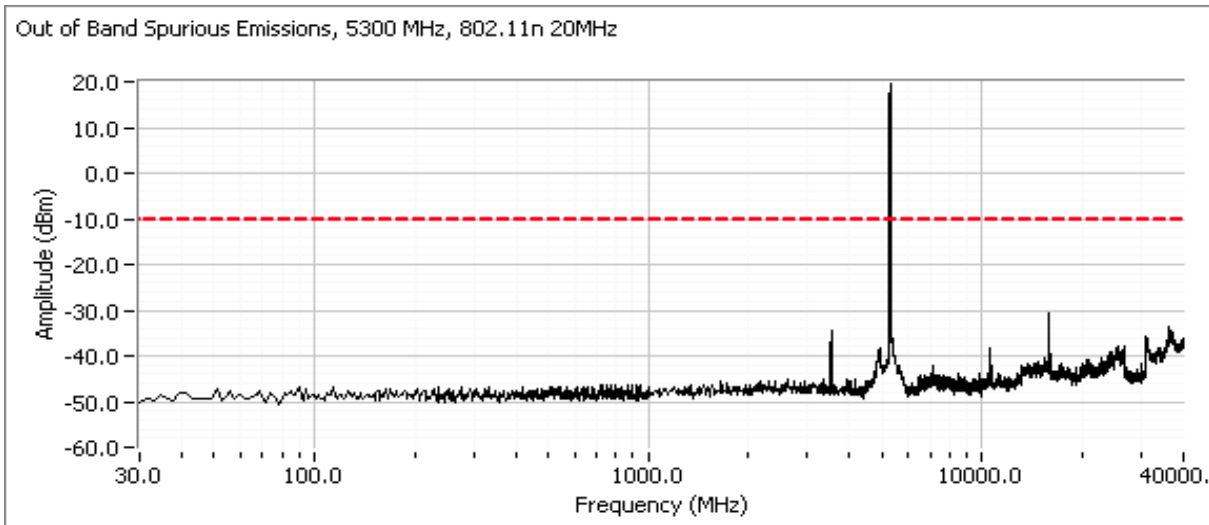

High channel, 5250 - 5350 MHz Band

Compliance with the radiated limits for the restricted band immediately above 5350MHz is demonstrated through the radiated emissions tests.

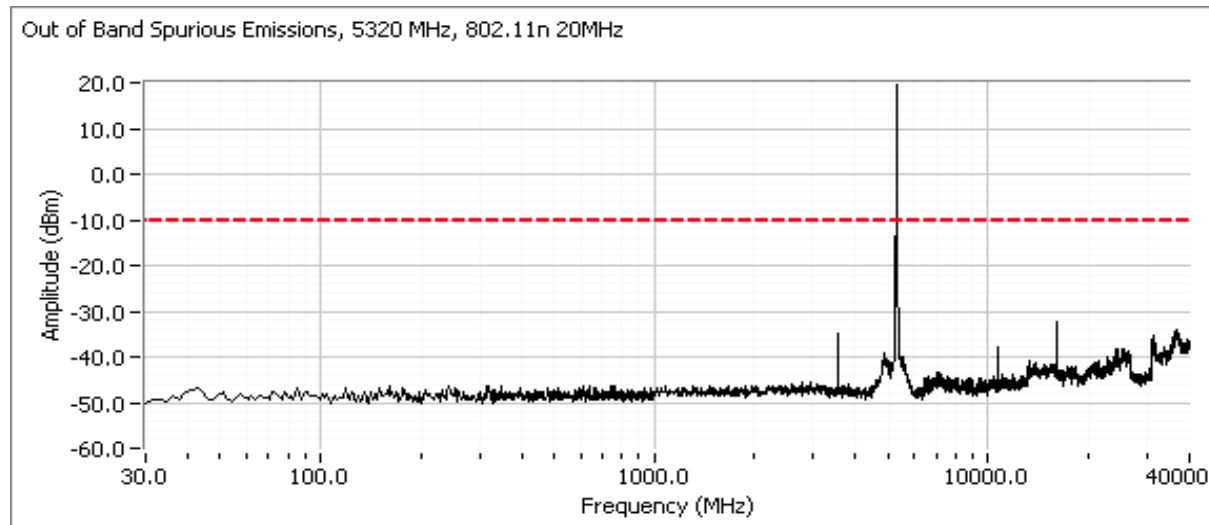

Client: Ruckus Wireless	Job Number: J77270
Model: 7962	T-Log Number: T77267
Contact: Craig Owens	Account Manager: Dean Eriksen
Standard: FCC Part 15.247/RSS-210	Class: N/A

Low channel, 5470 - 5725 MHz Band

Includes a plot from 5460 - 5500 MHz showing compliance with the limit immediately below the allocated band from 5460-5470 MHz. Compliance with the radiated limits for the restricted band below 5460 MHz is demonstrated through the radiated emissions test

Out of Band Spurious Emissions, 5500 MHz, 802.11n 20MHz

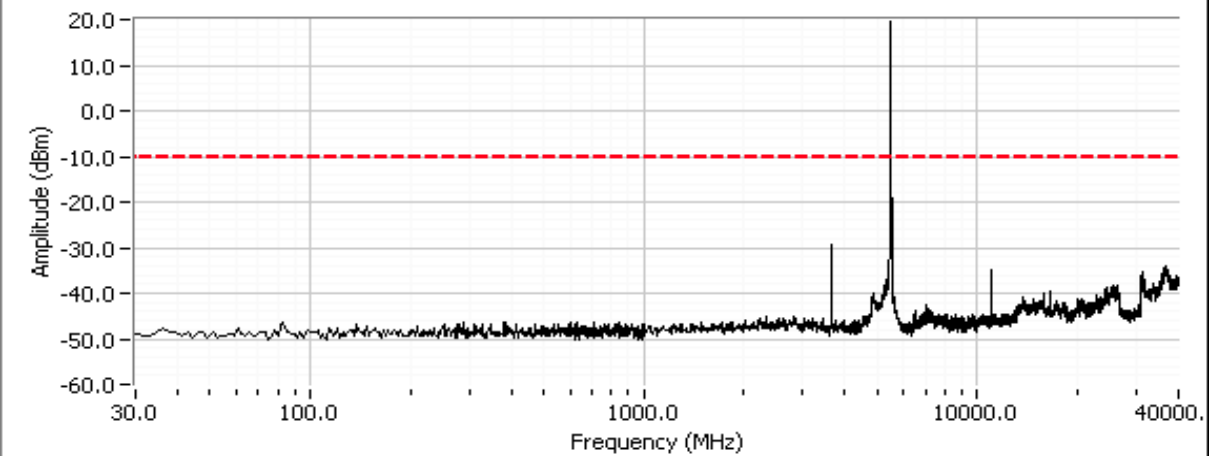

Out of Band Spurious Emissions, 5500 MHz, 802.11n 20MHz, Bandedge

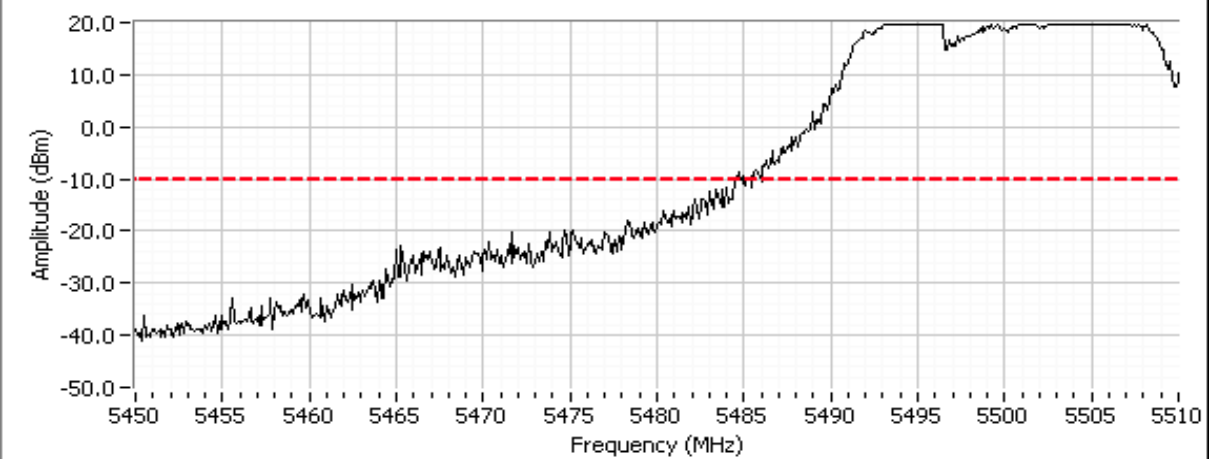

Client: Ruckus Wireless	Job Number: J77270
Model: 7962	T-Log Number: T77267
Contact: Craig Owens	Account Manager: Dean Eriksen
Standard: FCC Part 15.247/RSS-210	Class: N/A

Center channel, 5470 - 5725 MHz Band

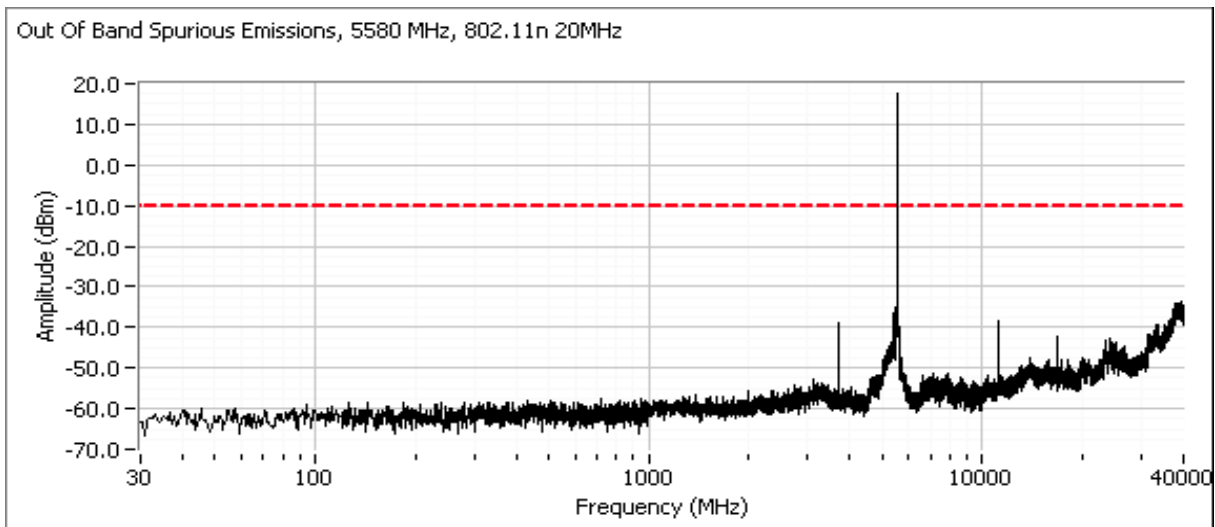

High channel, 5470 - 5725 MHz Band

Includes a plot from 5700 - 5780 MHz showing compliance with the limit immediately above the allocated band.

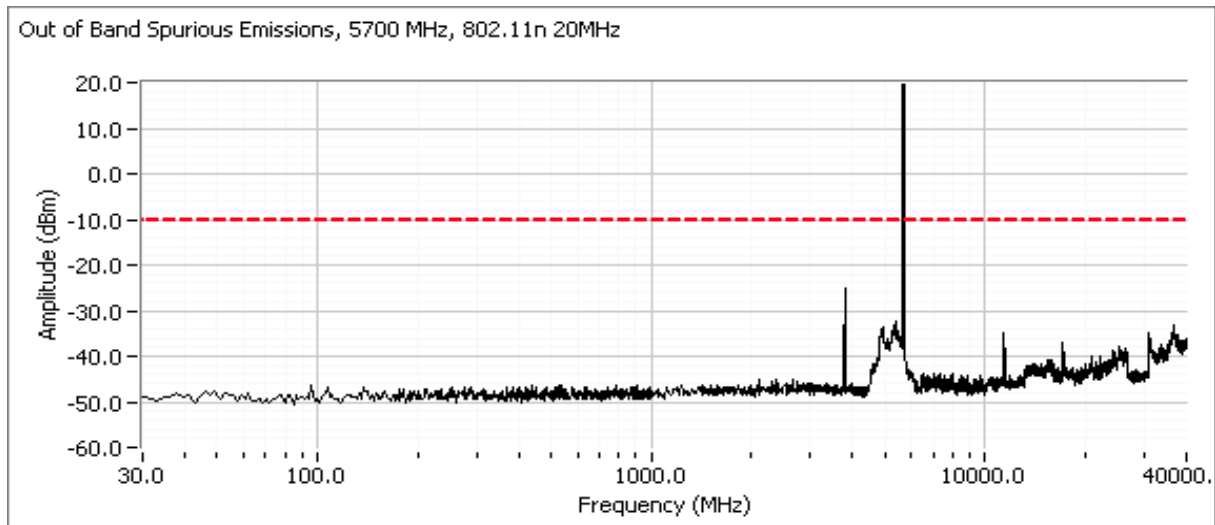

Client: Ruckus Wireless	Job Number: J77270
Model: 7962	T-Log Number: T77267
Contact: Craig Owens	Account Manager: Dean Eriksen
Standard: FCC Part 15.247/RSS-210	Class: N/A

Out of Band Spurious Emissions, 5700 MHz, 802.11n 20MHz, Bandedge

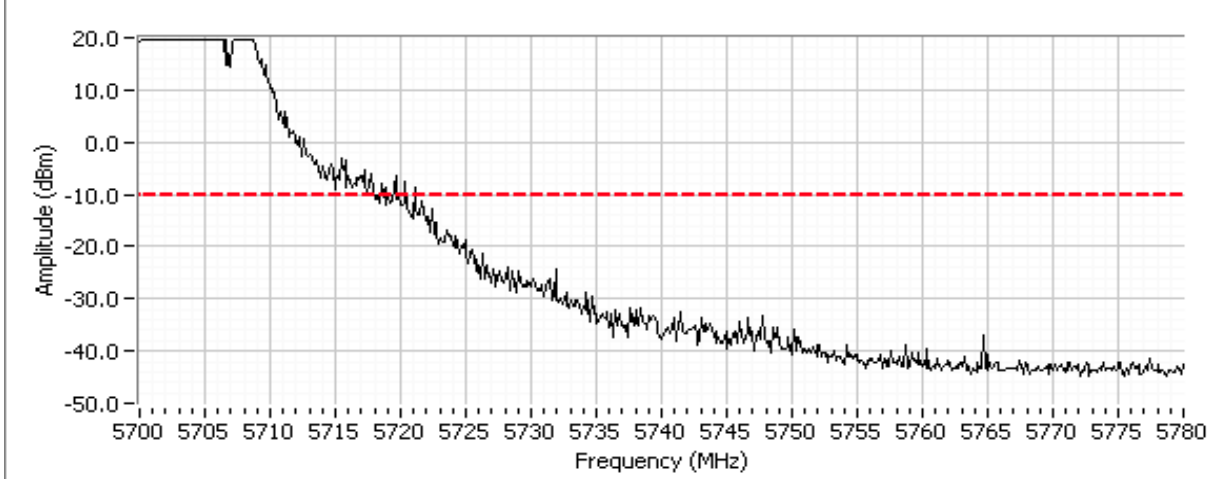

Run #4: 20dB Bandwidth - Channels Adjacent to 5600-5650MHz band

Date of Test: 10/29/2009

Config. Used: 1

Test Engineer: Suhaila K/Mehran B

Config Change: None

Test Location: SVOATS #2

EUT Voltage: 120V/60Hz

20dB bandwidth - 5580MHz, HT20, Chain A

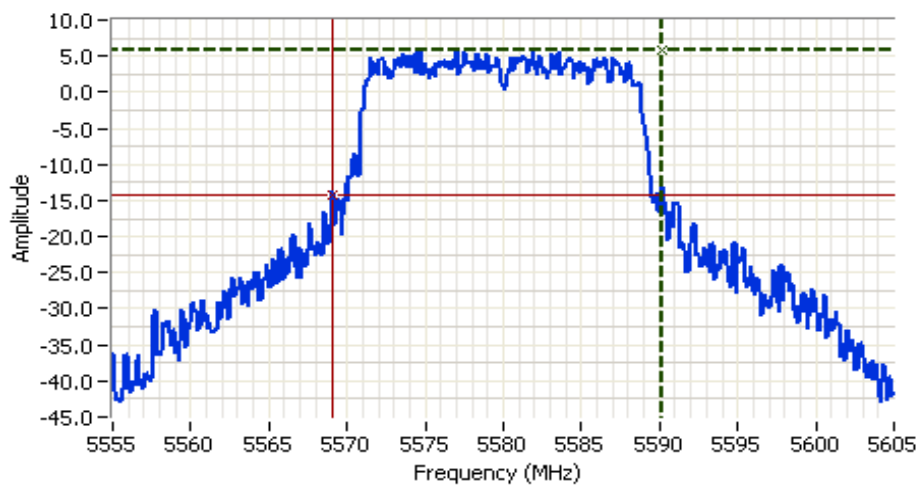

Analyzer Settings
 Agilent Technologies, E4446A
 CF: 5580.000 MHz
 SPAN: 50.000 MHz
 RB: 300 kHz
 VB: 300 kHz
 Detector: POS
 Attn: 20 DB
 RL Offset: 10.4 DB
 Sweep Time: 1.0ms
 Ref Lvl: 20.0 DBM

Comments
 802.11n 20MHz Chain 1
 20dB BW: 21.17 MHz
 FH = 5590.167 MHz

Cursor 1	5590.1667	5.80	
Cursor 2	5569.0000	-14.20	

Delta Freq. 21.167
 Delta Amplitude 20.00

Client: Ruckus Wireless	Job Number: J77270
Model: 7962	T-Log Number: T77267
Contact: Craig Owens	Account Manager: Dean Eriksen
Standard: FCC Part 15.247/RSS-210	Class: N/A

20dB bandwidth - 5580MHz, HT20, Chain B

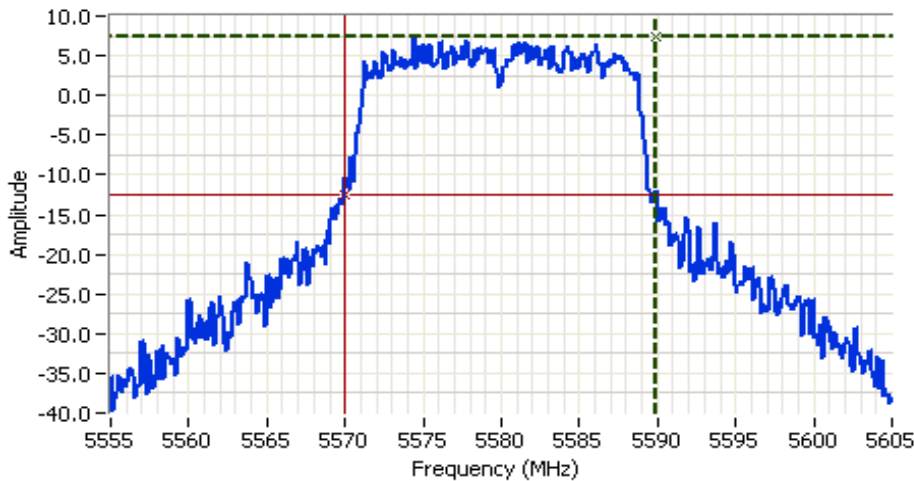

Analyzer Settings
 Agilent Technologies, E4446A
 CF: 5580.000 MHz
 SPAN: 50.000 MHz
 RB: 300 kHz
 VB: 300 kHz
 Detector: POS
 Attn: 20 DB
 RL Offset: 10.4 DB
 Sweep Time: 1.0ms
 Ref Lvl: 20.0 DBM

Comments
 802.11n 20MHz Chain 2
 20dB BW: 19.92 MHz
 FH = 5589.917 MHz

Cursor 1 5589.9167 7.38  Delta Freq. 19.917

Cursor 2 5570.0000 -12.62  Delta Amplitude 20.00



20dB bandwidth - 5580MHz, HT20, Chain C

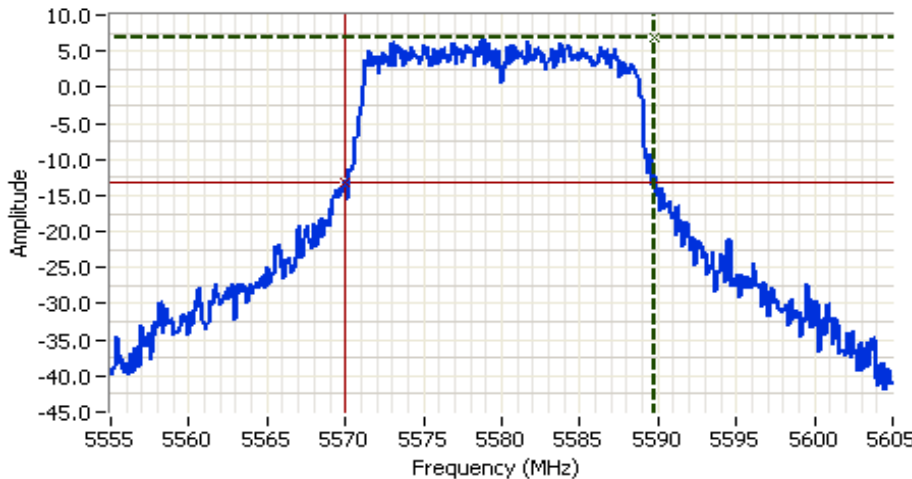

Analyzer Settings
 Agilent Technologies, E4446A
 CF: 5580.000 MHz
 SPAN: 50.000 MHz
 RB: 300 kHz
 VB: 300 kHz
 Detector: POS
 Attn: 20 DB
 RL Offset: 10.4 DB
 Sweep Time: 1.0ms
 Ref Lvl: 20.0 DBM

Comments
 802.11n 20MHz Chain 3
 20dB BW: 19.83 MHz
 FH = 5589.75 MHz

Cursor 1 5589.7500 6.76  Delta Freq. 19.833

Cursor 2 5569.9167 -13.24  Delta Amplitude 20.00



Client: Ruckus Wireless	Job Number: J77270
Model: 7962	T-Log Number: T77267
Contact: Craig Owens	Account Manager: Dean Eriksen
Standard: FCC Part 15.247/RSS-210	Class: N/A

20dB bandwidth - 5660MHz, HT20, Chain A

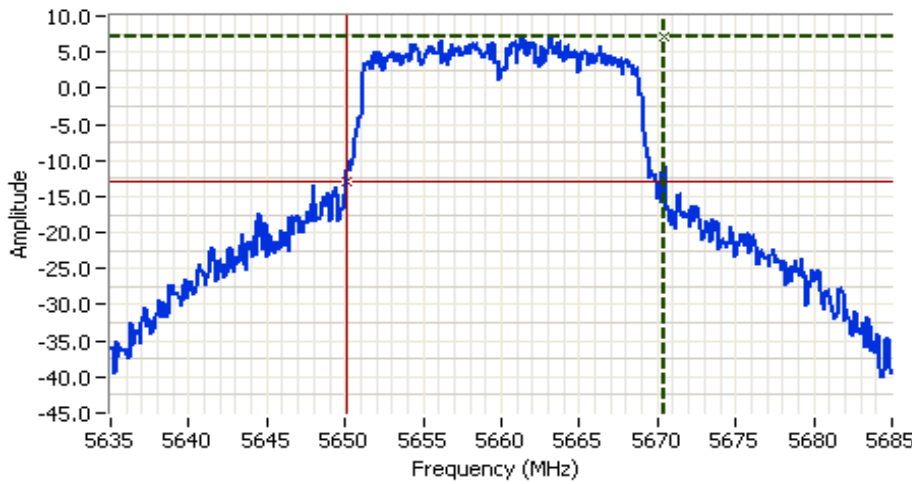

Analyzer Settings
 Agilent Technologies, E4446A
 CF: 5660.000 MHz
 SPAN: 50.000 MHz
 RB: 300 kHz
 VB: 300 kHz
 Detector: POS
 Attn: 20 DB
 RL Offset: 10.4 DB
 Sweep Time: 1.0ms
 Ref Lvl: 20.0 DBM

Comments
 802.11n 20MHz Chain 1
 20dB BW: 20.25 MHz
 FL = 5650.167 MHz

Cursor 1 5670.4167 7.08    Delta Freq. 20.250

Cursor 2 5650.1667 -12.92    Delta Amplitude 20.00



20dB bandwidth - 5660MHz, HT20, Chain B

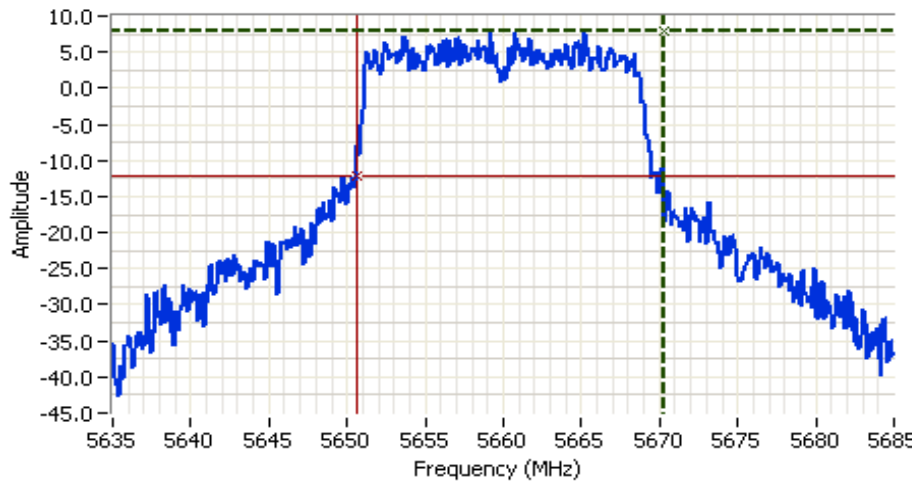

Analyzer Settings
 Agilent Technologies, E4446A
 CF: 5660.000 MHz
 SPAN: 50.000 MHz
 RB: 300 kHz
 VB: 300 kHz
 Detector: POS
 Attn: 20 DB
 RL Offset: 10.4 DB
 Sweep Time: 1.0ms
 Ref Lvl: 20.0 DBM

Comments
 802.11n 20MHz Chain 2
 20dB BW: 19.67 MHz
 FL = 5650.583 MHz

Cursor 1 5670.2500 7.83    Delta Freq. 19.667

Cursor 2 5650.5833 -12.17    Delta Amplitude 20.00



Client: Ruckus Wireless	Job Number: J77270
Model: 7962	T-Log Number: T77267
Contact: Craig Owens	Account Manager: Dean Eriksen
Standard: FCC Part 15.247/RSS-210	Class: N/A

20dB bandwidth - 5660MHz, HT20, Chain C

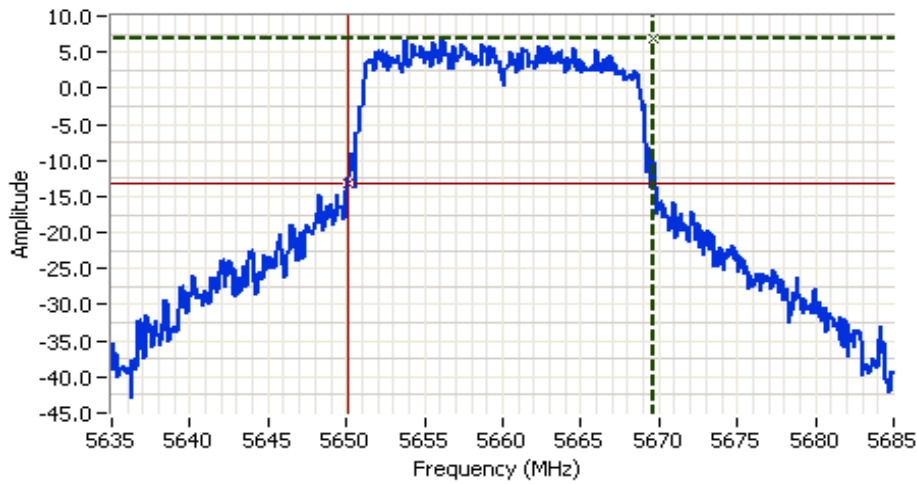

Analyzer Settings
 Agilent Technologies, E4446A
 CF: 5660.000 MHz
 SPAN: 50.000 MHz
 RB: 300 kHz
 VB: 300 kHz
 Detector: POS
 Attn: 20 DB
 RL Offset: 10.4 DB
 Sweep Time: 1.0ms
 Ref Lvl: 20.0 DBM

Comments
 802.11n 20MHz Chain 3
 20dB BW: 19.50 MHz
 FL = 5650.167 MHz

Cursor 1	5669.6667	6.78	
Cursor 2	5650.1667	-13.22	

Delta Freq. 19.500
 Delta Amplitude 20.00



Client:	Ruckus Wireless	Job Number:	J77270
Model:	7962	T-Log Number:	T77267
Contact:	Craig Owens	Account Manager:	Dean Eriksen
Standard:	FCC Part 15.247/RSS-210	Class:	N/A

RSS-210 (LELAN) and FCC 15.407(UNII) Antenna Port Measurements Power, PSD, Peak Excursion, Bandwidth and Spurious Emissions

Test Specific Details

Objective: The objective of this test session is to perform final qualification testing of the EUT with respect to the specification listed above.

Date of Test: 3/20/2009
 Test Engineer: Rafael Varelas
 Test Location: SVOATS #2

Config. Used: 1
 Config Change: None
 EUT Voltage: 120V/60Hz

General Test Configuration

When measuring the conducted emissions from the EUT's antenna port, the antenna port of the EUT was connected to the spectrum analyzer or power meter via a suitable attenuator to prevent overloading the measurement system. All measurements are corrected to allow for the external attenuators and cables used.

Ambient Conditions: Temperature: 18.5 °C
 Rel. Humidity: 40 %

Summary of Results

Run #	Test Performed	Limit	Pass / Fail	Result / Margin
1	Power, 5250 - 5350MHz	15.407(a) (1), (2)	Pass	23.8 dBm (0.241W)
1	Power, 5470 - 5725MHz	15.407(a) (1), (2)	Pass	23.5 dBm (0.224W)
1	PSD, 5250 - 5350MHz	15.407(a) (1), (2)	Pass	7.97 dBm/MHz
1	PSD, 5470 - 5725MHz	15.407(a) (1), (2)	Pass	8.01 dBm/MHz
1	26dB Bandwidth	15.407	-	47.2 MHz
1	99% Bandwidth	RSS 210	-	37.1 MHz
2	Peak Excursion Envelope	15.407(a) (6)	Pass	12.2 dB
3	Antenna Conducted Out of Band Spurious	15.407(b)	Pass	All emissions below the -27dBm/MHz limit

Modifications Made During Testing

No modifications were made to the EUT during testing

Deviations From The Standard

No deviations were made from the requirements of the standard.

Client:	Ruckus Wireless	Job Number:	J77270
Model:	7962	T-Log Number:	T77267
Contact:	Craig Owens	Account Manager:	Dean Eriksen
Standard:	FCC Part 15.247/RSS-210	Class:	N/A

Note - Testing performed on 5550 MHz, was done on 10/29/09 by Suhaila Khushzad and Mehran Birgani

Run #1: Bandwidth, Output Power and Power spectral Density

	Chain 1	Chain 2	Chain 3	Coherent	Effective ⁵
Antenna Gain (dBi):	3.0	3.0	3.0	No	3.0

Frequency (MHz)	Software Setting	26dB BW (MHz)	Measured Output Power ¹ dBm			Total		Limit (dBm)	Max Power (W)	Pass or Fail
			Chain 1	Chain 2	Chain 3	mW	dBm			
5270	20.0	50.3	18.8	19.5	18.8	240.8	23.8	24.0	0.241	PASS
5310	17.5	47.7	15.3	16.2	16.1	116.5	20.7	24.0		PASS
5510	20.0	47.2	18.7	18.3	18.2	208.3	23.2	24.0	0.224	PASS
5550	20.0	47.5	16.4	16.7	16.6	136.1	21.3	24.0		PASS
5670	19.5	49.5	19.5	18.4	18.2	224.0	23.5	24.0		PASS

Frequency (MHz)	99% ⁴ BW	Total Power	PSD ² dBm/MHz			Total PSD		Limit		Pass or Fail
			Chain 1	Chain 2	Chain 3	mW/MHz	dBm/MHz	FCC	RSS 210 ³	
5270	37.1	23.8	3.3	3.5	2.8	6.3	7.97	11.0	11.0	PASS
5310	36.8	20.7	-0.1	0.8	0.5	3.3	5.20	11.0	11.0	PASS
5510	36.8	23.2	3.3	2.5	2.3	5.6	7.49	11.0	11.0	PASS
5550	36.5	21.3	0.9	0.8	0.9	3.7	5.64	11.0	11.0	PASS
5670	36.8	23.5	3.7	2.8	3.2	6.3	8.01	11.0	11.0	PASS

- Note 1: Output power measured using a spectrum analyzer (see plots below): RBW=1MHz, VB=3 MHz, sample detector, power averaging on (transmitted signal was continuous) and power integration over 50 MHz
- Note 2: Measured using the same analyzer settings used for output power.
- Note 3: For RSS-210 the limit for the 5150 - 5250 MHz band accounts for the antenna gain as the maximum eirp allowed is 10dBm/MHz. The limits are also corrected for instances where the highest measured value of the PSD exceeds the average PSD (calculated from the measured power divided by the measured 99% bandwidth) by more than 3dB by the amount that the measured value exceeds the average by more than 3dB.
- Note 4: 99% Bandwidth measured in accordance with RSS GEN - RB > 1% of span and VB >= 3xRB
- Note 5: For MIMO systems the total output power and total PSD are calculated from the sum of the powers of the individual chains (in linear terms). The antenna gain used to determine the EIRP and limits for PSD/Output power depends on the operating mode of the MIMO device. If the signals are non-coherent between the transmit chains then the gain used to determine the limits is the highest gain of the individual chains and the EIRP is the sum of the products of gain and power on each chain. If the signals are coherent then the effective antenna gain is the sum (in linear terms) of the gains for each chain and the EIRP is the product of the effective gain and total power.

Client: Ruckus Wireless	Job Number: J77270
Model: 7962	T-Log Number: T77267
Contact: Craig Owens	Account Manager: Dean Eriksen
Standard: FCC Part 15.247/RSS-210	Class: N/A

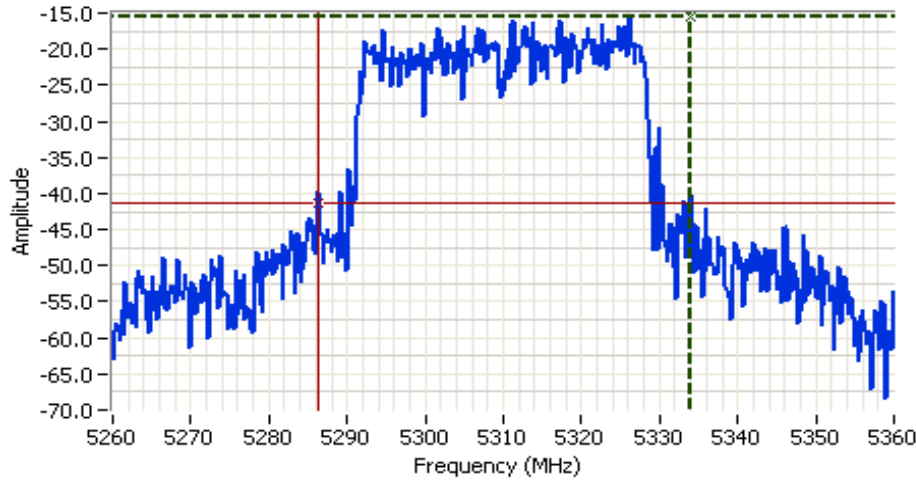

Analyzer Settings
 Agilent Technologies, E4446A
 CF: 5310.000 MHz
 SPAN: 100.000 MHz
 RB: 1.000 MHz
 VB: 3.000 MHz
 Detector: PK (CISPR)
 Attn: 10 DB
 RL Offset: 0.0 DB
 Sweep Time: 1.0ms
 Ref Lvl: 0.0 DBM

Comments
 26dB BW: 47.667 MHz
 802.11n 40MHz, chain 1

Cursor 1	5334.0000	-15.39	
Cursor 2	5286.3333	-41.39	

Delta Freq. 47.667
 Delta Amplitude 26.00

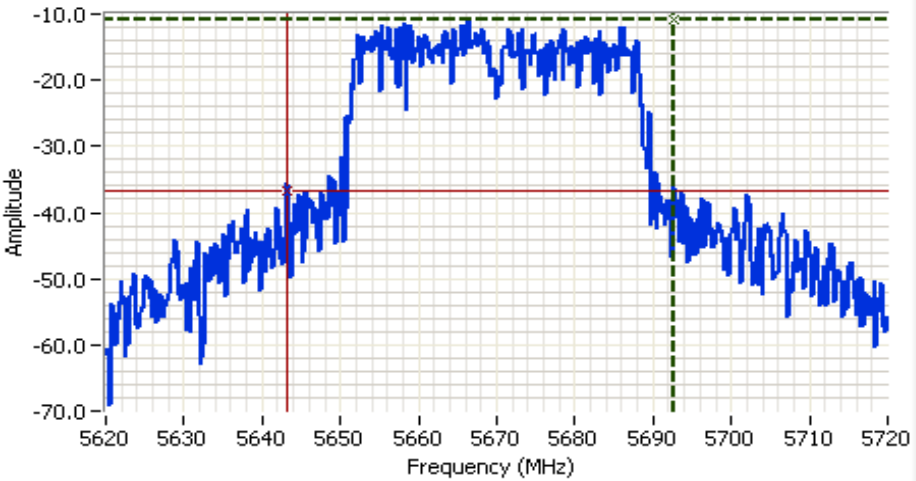

Analyzer Settings
 Agilent Technologies, E4446A
 CF: 5670.000 MHz
 SPAN: 100.000 MHz
 RB: 1.000 MHz
 VB: 3.000 MHz
 Detector: PK (CISPR)
 Attn: 10 DB
 RL Offset: 0.0 DB
 Sweep Time: 1.0ms
 Ref Lvl: 0.0 DBM

Comments
 26dB BW: 49.500 MHz
 802.11n 40MHz Chain 1

Cursor 1	5692.6667	-10.87	
Cursor 2	5643.1667	-36.87	

Delta Freq. 49.500
 Delta Amplitude 26.00



Client: Ruckus Wireless	Job Number: J77270
Model: 7962	T-Log Number: T77267
Contact: Craig Owens	Account Manager: Dean Eriksen
Standard: FCC Part 15.247/RSS-210	Class: N/A

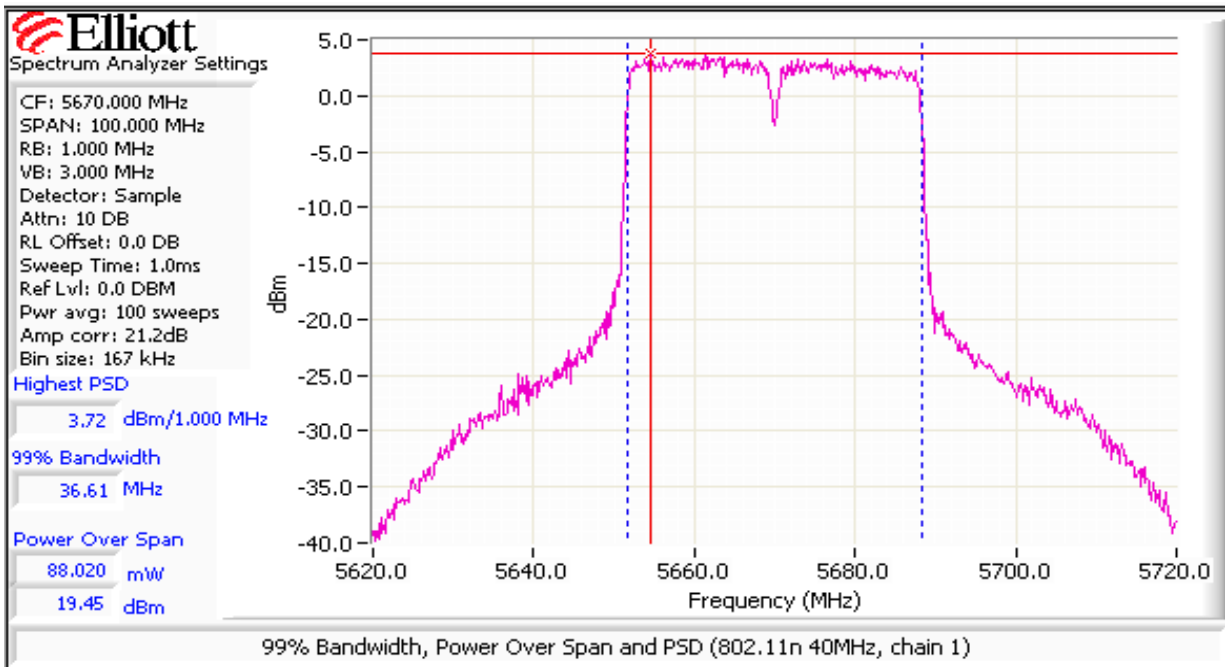
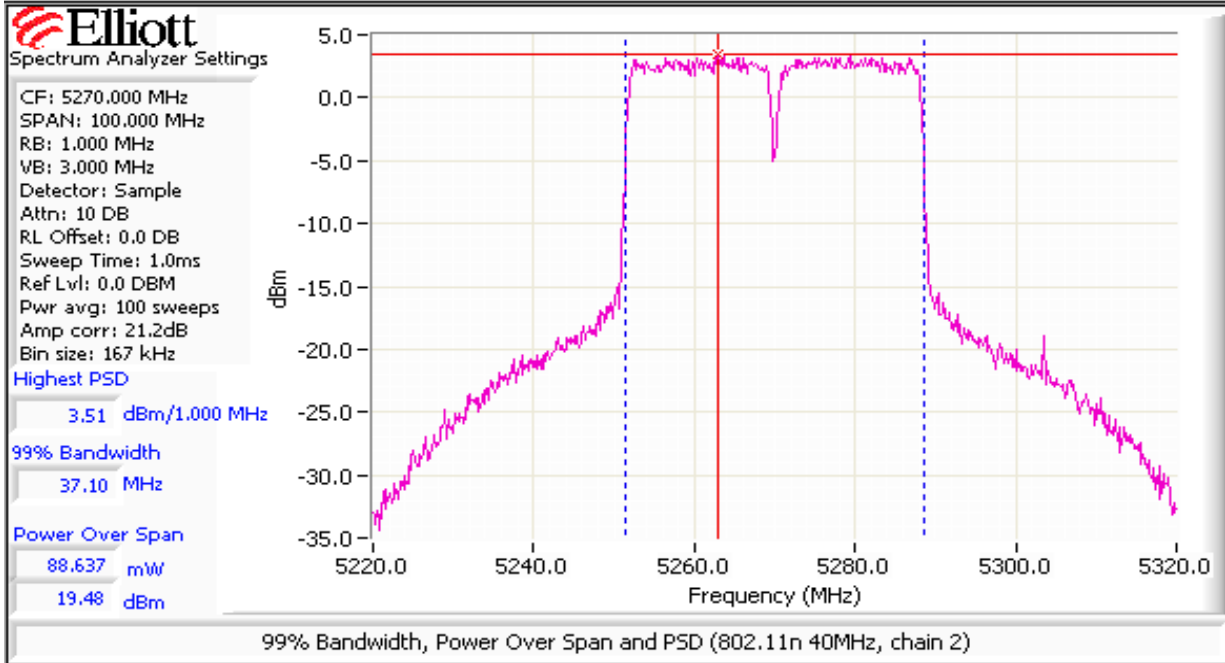

Client: Ruckus Wireless	Job Number: J77270
Model: 7962	T-Log Number: T77267
Contact: Craig Owens	Account Manager: Dean Eriksen
Standard: FCC Part 15.247/RSS-210	Class: N/A

Run #2: Peak Excursion Measurement

Device meets the requirement for the peak excursion

Freq (MHz)	Peak Excursion(dB) Value	Peak Excursion(dB) Limit	Freq (MHz)	Peak Excursion(dB) Value	Peak Excursion(dB) Limit	Freq (MHz)	Peak Excursion(dB) Value	Peak Excursion(dB) Limit
			5270	10.0	13.0	5510	9.3	13.0
						5550	10.8	13.0
			5310	12.2	13.0	5670	12.0	13.0

Plots Showing Peak Excursion

Trace A: RBW = 1MHz, VBW = 3MHz, Peak hold

Trace B: Same settings as used for power/PSD measurements (RBW = 1 MHz, VBW = 3MHz, Integrated average power)

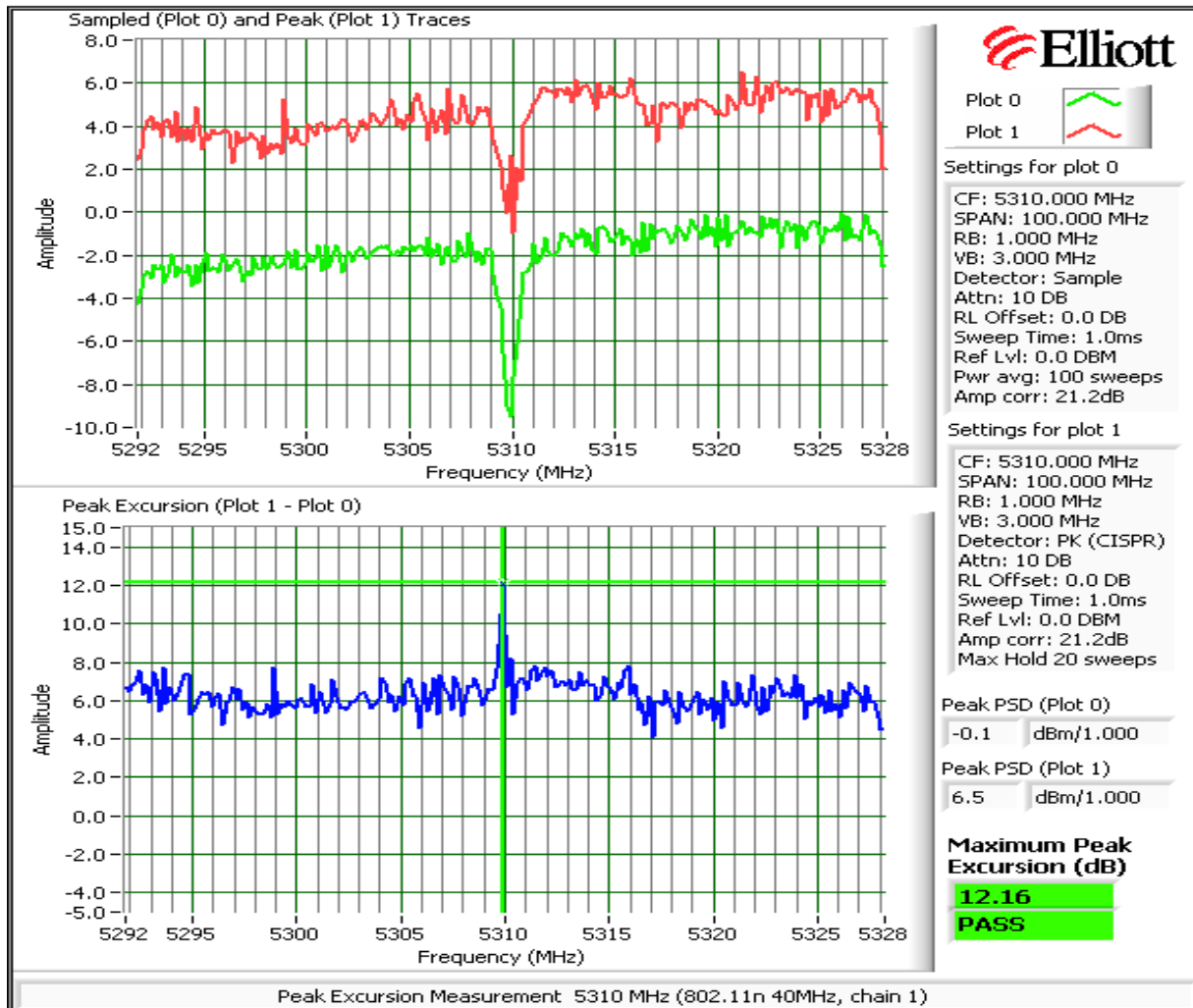

Client: Ruckus Wireless	Job Number: J77270
Model: 7962	T-Log Number: T77267
Contact: Craig Owens	Account Manager: Dean Eriksen
Standard: FCC Part 15.247/RSS-210	Class: N/A

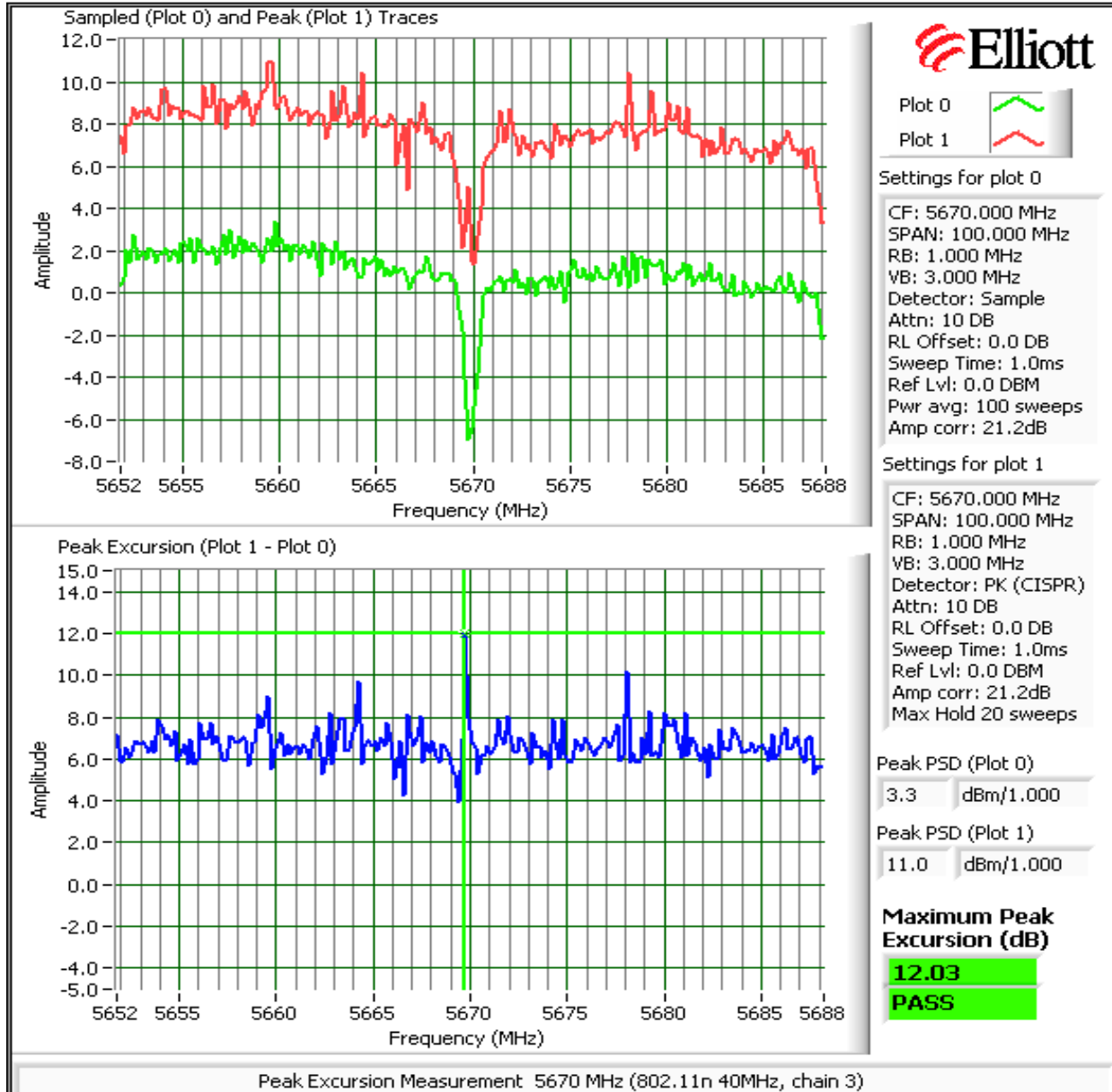

Client: Ruckus Wireless	Job Number: J77270
Model: 7962	T-Log Number: T77267
Contact: Craig Owens	Account Manager: Dean Eriksen
Standard: FCC Part 15.247/RSS-210	Class: N/A

Run #3: Out Of Band Spurious Emissions - Antenna Conducted

MIMO Devices: Antenna gain used is the effective gain calculated in the power section of this data sheet. The plots were obtained with all chains transmitting simultaneously and connected to the analyzer via a combiner. Unused ports of the combiner were terminated in the appropriate load (50 ohms).

Number of transmit chains: 3
 Maximum Antenna Gain: 3.0 dBi
 Spurious Limit: -27.0 dBm/MHz eirp
 Limit Used On Plots ^{Note 1}: -30.0 dBm/MHz Average Limit (RB=1MHz, VB=10Hz)
 -10.0 dBm/MHz Peak Limit (RB=VB=1MHz)

- Note 1: The -27dBm/MHz limit is an eirp limit. The limit for antenna port conducted measurements is adjusted to take into consideration the maximum antenna gain (limit = -27dBm - antenna gain). Radiated field strength measurements for signals more than 50MHz from the bands and that are close to the limit are made to determine compliance as the antenna gain is not known at these frequencies.
- Note 2: All spurious signals below 1GHz are measured during digital device radiated emissions test.
- Note 3: Signals within 10MHz of the 5.725 or 5.825 Band edge are subject to a limit of -17dBm EIRP
- Note 4: If the device is for outdoor use then the -27dBm eirp limit also applies in the 5150 - 5250 MHz band.
- Note 5: Signals that fall in the restricted bands of 15.205 are subject to the limit of 15.209.

Plots Showing Out-Of-Band Emissions (RBW=VBW=1MHz)

Low channel, 5250 - 5350 MHz Band

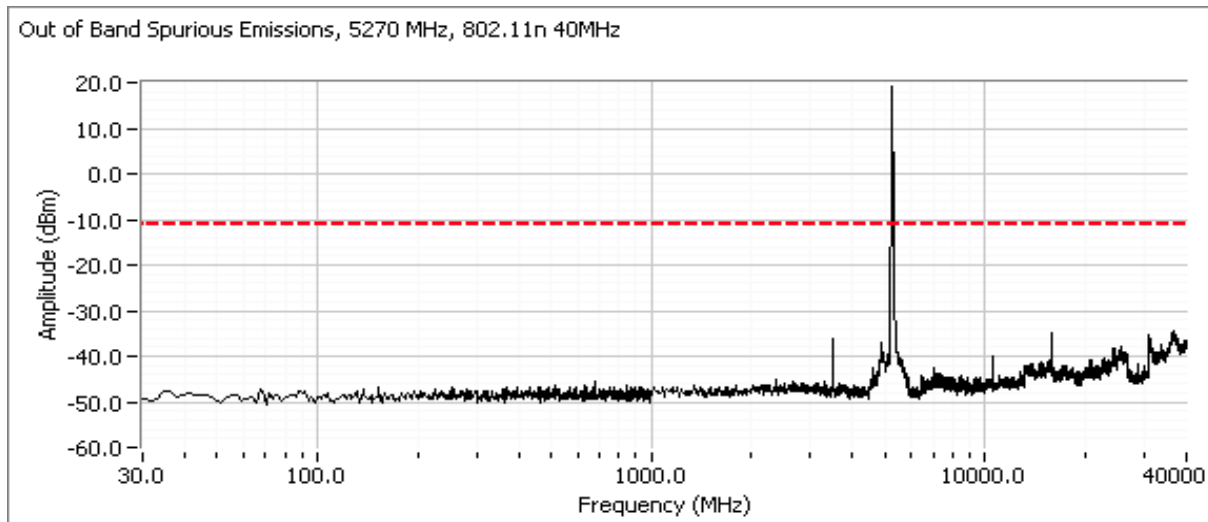

Client: Ruckus Wireless	Job Number: J77270
Model: 7962	T-Log Number: T77267
Contact: Craig Owens	Account Manager: Dean Eriksen
Standard: FCC Part 15.247/RSS-210	Class: N/A

High channel, 5250 - 5350 MHz Band

Compliance with the radiated limits for the restricted band immediately above 5350MHz is demonstrated through the radiated emissions tests.

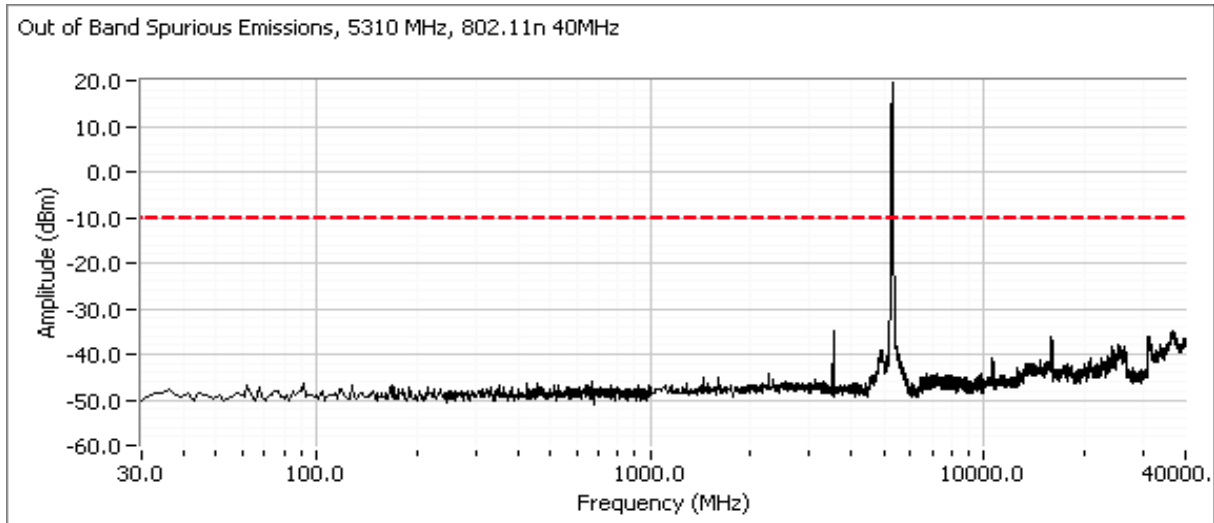

Low channel, 5470 - 5725 MHz Band

Includes a plot from 5460 - 5500 MHz showing compliance with the limit immediately below the allocated band from 5460-5470 MHz. Compliance with the radiated limits for the restricted band below 5460 MHz is demonstrated through the radiated emissions test

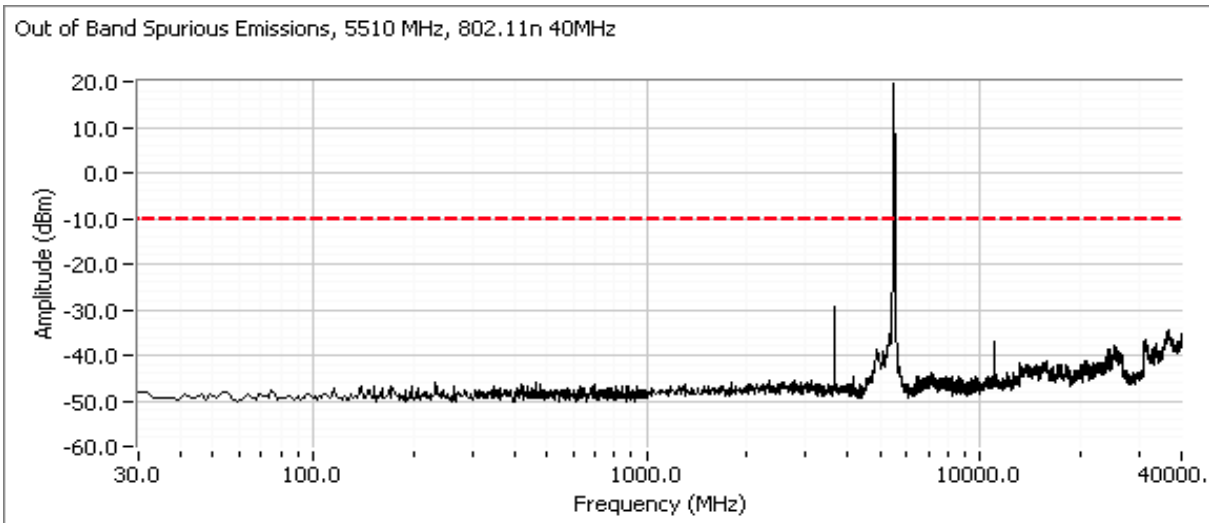

Client: Ruckus Wireless	Job Number: J77270
Model: 7962	T-Log Number: T77267
Contact: Craig Owens	Account Manager: Dean Eriksen
Standard: FCC Part 15.247/RSS-210	Class: N/A

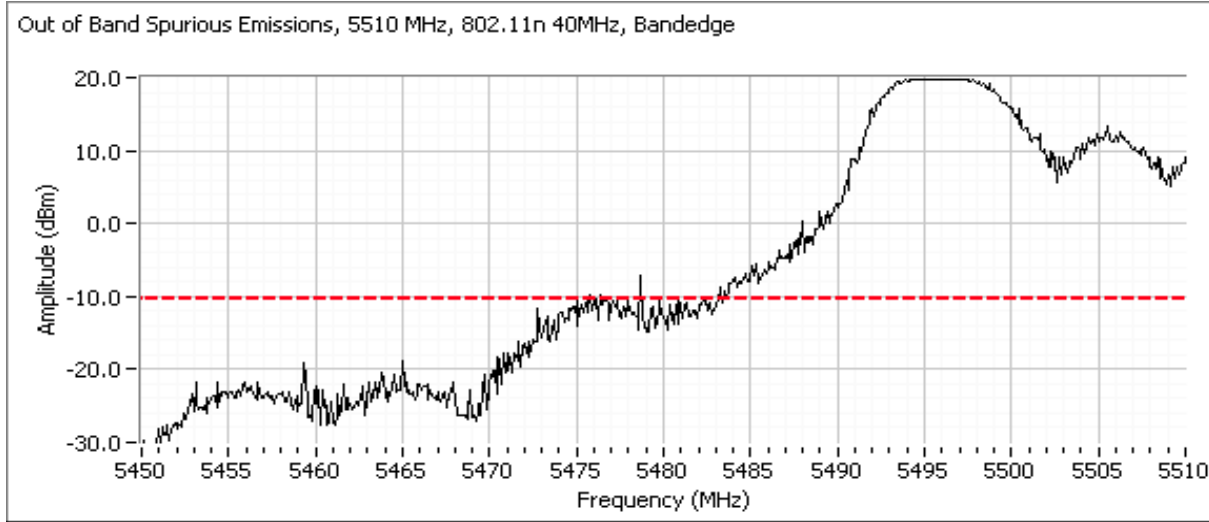

Center channel, 5470 - 5725 MHz Band

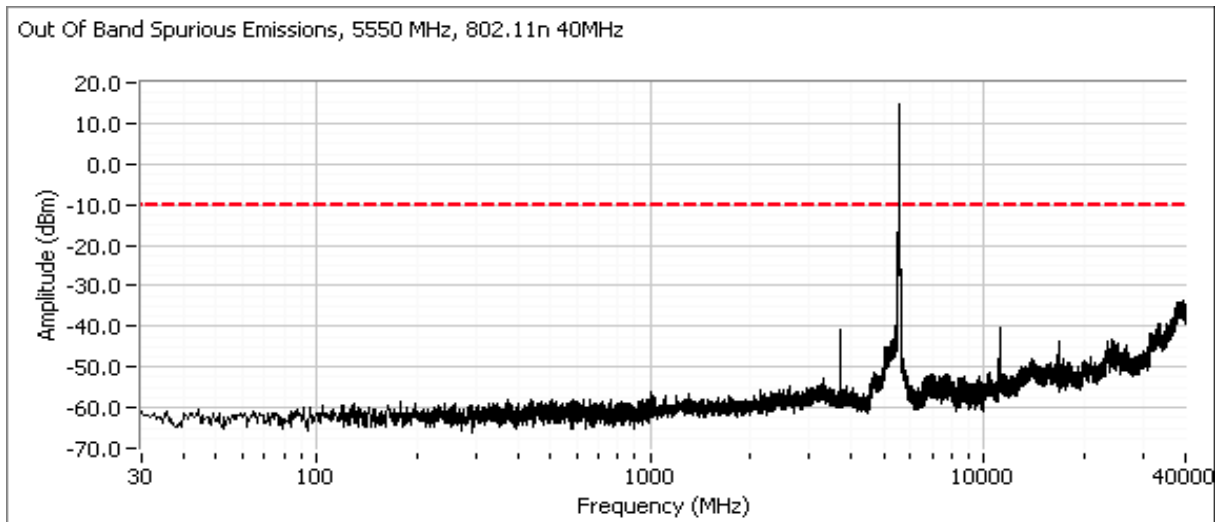

Client: Ruckus Wireless	Job Number: J77270
Model: 7962	T-Log Number: T77267
Contact: Craig Owens	Account Manager: Dean Eriksen
Standard: FCC Part 15.247/RSS-210	Class: N/A

High channel, 5470 - 5725 MHz Band

Includes a plot from 5700 - 5780 MHz showing compliance with the limit immediately above the allocated band.

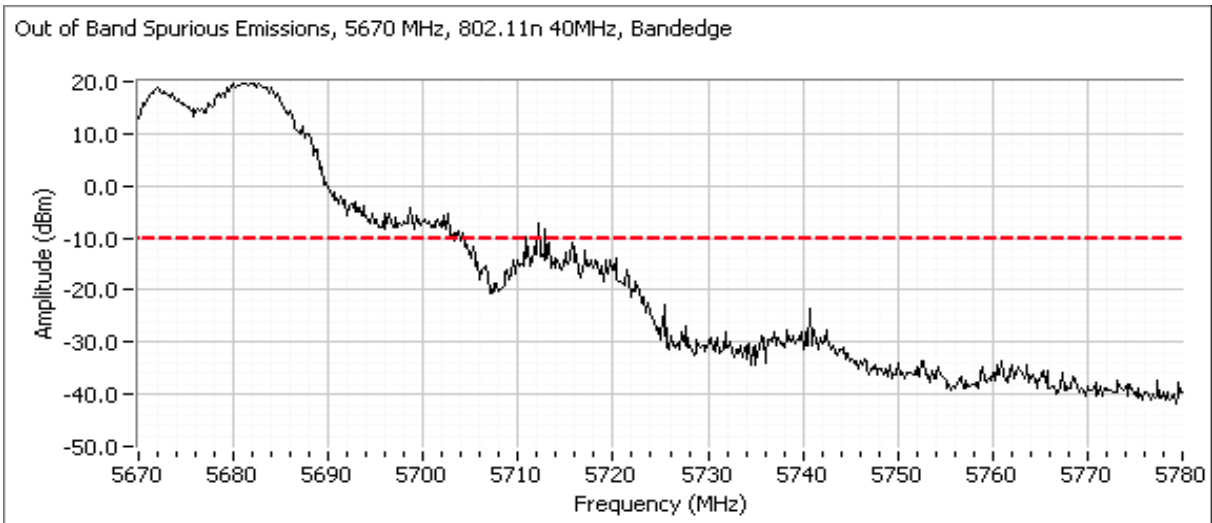
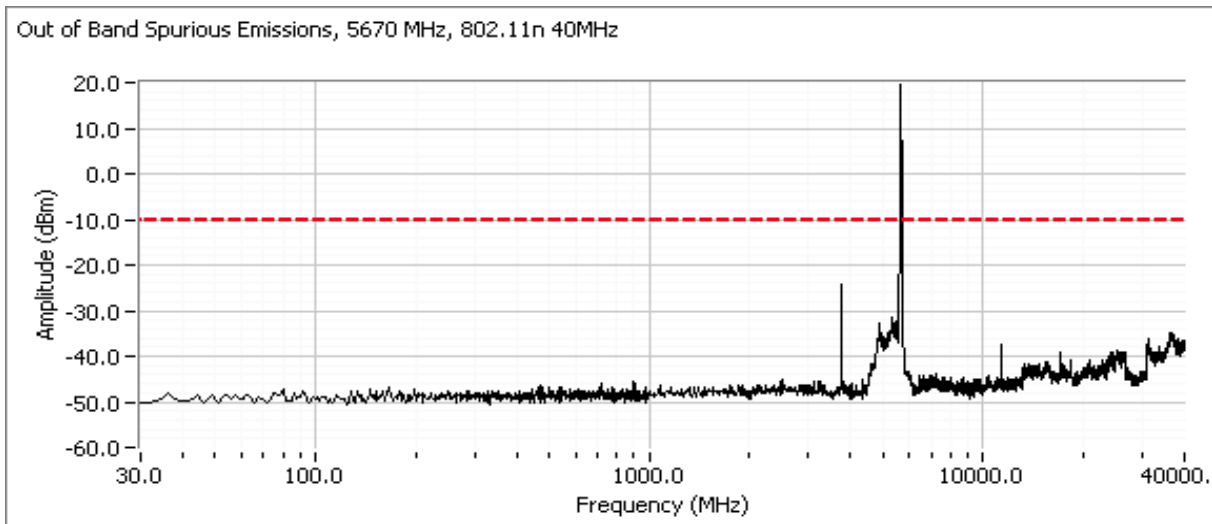

Client: Ruckus Wireless	Job Number: J77270
Model: 7962	T-Log Number: T77267
Contact: Craig Owens	Account Manager: Dean Eriksen
Standard: FCC Part 15.247/RSS-210	Class: N/A

Run #4: 20dB Bandwidth - Channels Adjacent to 5600-5650MHz band

Date of Test: 10/29/2009 Config. Used: 1
 Test Engineer: Suhaila K/Mehran B Config Change: None
 Test Location: SVOATS #2 EUT Voltage: 120V/60Hz

20dB bandwidth - 5550MHz, HT40, Chain A

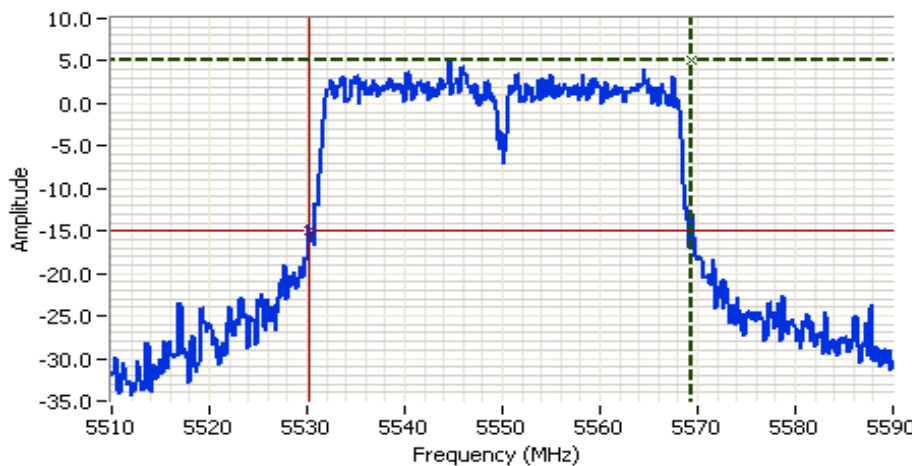

Analyzer Settings
 Agilent Technologies, E4446A
 CF: 5550.000 MHz
 SPAN: 80.000 MHz
 RB: 300 kHz
 VB: 300 kHz
 Detector: POS
 Attn: 20 DB
 RL Offset: 10.4 DB
 Sweep Time: 1.0ms
 Ref Lvl: 20.0 DBM

Comments
 802.11n 40MHz Chain 1
 20dB BW: 39.3 MHz
 FH = 5569.467 MHz

Cursor 1 5569.4667 5.11 Delta Freq. 39.333
 Cursor 2 5530.1333 -14.89 Delta Amplitude 20.00



20dB bandwidth - 5550MHz, HT40, Chain B

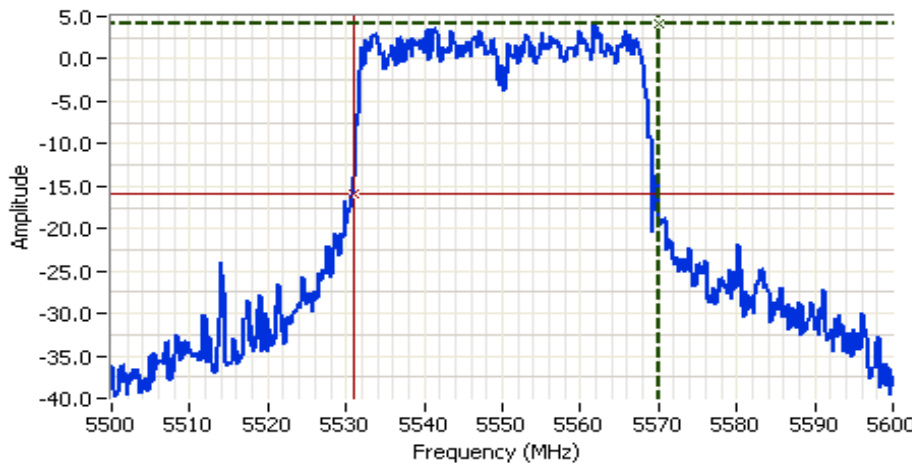

Analyzer Settings
 Agilent Technologies, E4446A
 CF: 5550.000 MHz
 SPAN: 100.000 MHz
 RB: 300 kHz
 VB: 300 kHz
 Detector: POS
 Attn: 20 DB
 RL Offset: 10.4 DB
 Sweep Time: 1.0ms
 Ref Lvl: 20.0 DBM

Comments
 802.11n 40MHz Chain 2
 20dB BW: 39.00 MHz
 FH = 5570.000 MHz

Cursor 1 5570.0000 4.12 Delta Freq. 39.000
 Cursor 2 5531.0000 -15.88 Delta Amplitude 20.00



Client: Ruckus Wireless	Job Number: J77270
Model: 7962	T-Log Number: T77267
Contact: Craig Owens	Account Manager: Dean Eriksen
Standard: FCC Part 15.247/RSS-210	Class: N/A

20dB bandwidth - 5550MHz, HT40, Chain C

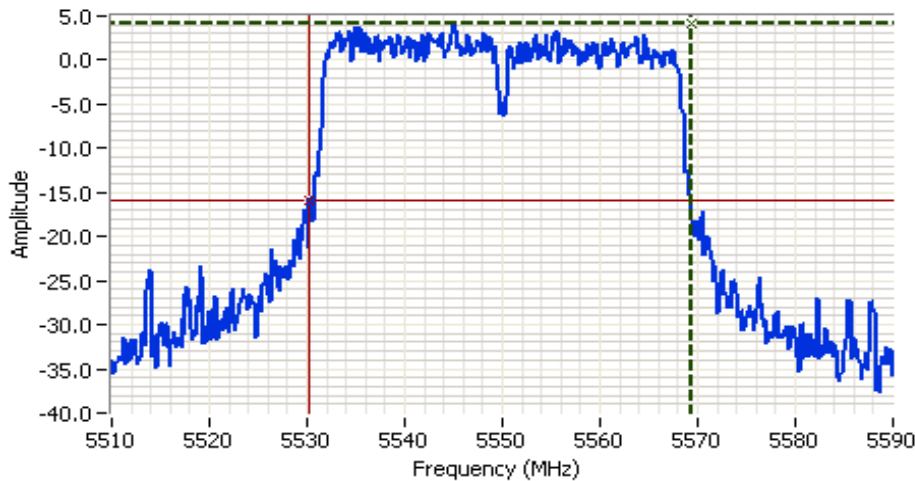

Analyzer Settings
 Agilent Technologies, E4446A
 CF: 5550.000 MHz
 SPAN: 80.000 MHz
 RB: 300 kHz
 VB: 300 kHz
 Detector: POS
 Attn: 20 DB
 RL Offset: 10.4 DB
 Sweep Time: 1.0ms
 Ref Lvl: 20.0 DBM

Comments
 802.11n 40MHz Chain 3
 20dB BW: 39.07 MHz
 FH = 5569.333 MHz

Cursor 1 5569.3333 4.05
 Cursor 2 5530.2667 -15.95

Delta Freq. 39.067
 Delta Amplitude 20.00



20dB bandwidth - 5670MHz, HT40, Chain A

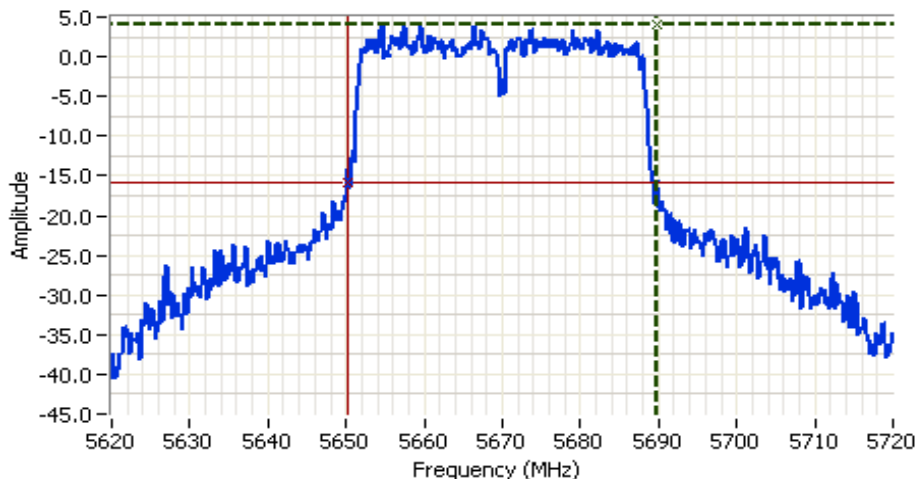

Analyzer Settings
 Agilent Technologies, E4446A
 CF: 5670.000 MHz
 SPAN: 100.000 MHz
 RB: 300 kHz
 VB: 300 kHz
 Detector: POS
 Attn: 20 DB
 RL Offset: 10.4 DB
 Sweep Time: 1.0ms
 Ref Lvl: 20.0 DBM

Comments
 802.11n 40MHz Chain 1
 20dB BW: 39.50 MHz
 FL = 5650.167 MHz

Cursor 1 5689.6667 4.07
 Cursor 2 5650.1667 -15.93

Delta Freq. 39.500
 Delta Amplitude 20.00



Client: Ruckus Wireless	Job Number: J77270
Model: 7962	T-Log Number: T77267
Contact: Craig Owens	Account Manager: Dean Eriksen
Standard: FCC Part 15.247/RSS-210	Class: N/A

20dB bandwidth - 5670MHz, HT40, Chain B

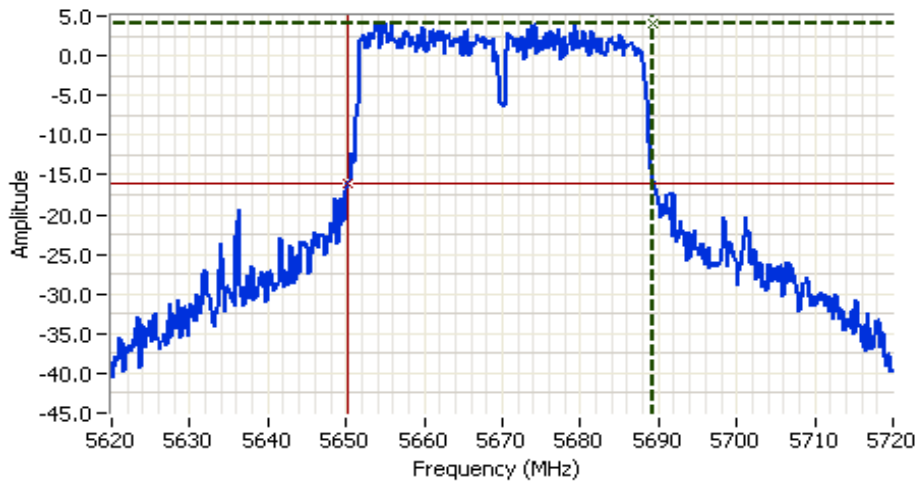

Analyzer Settings
 Agilent Technologies, E4446A
 CF: 5670.000 MHz
 SPAN: 100.000 MHz
 RB: 300 kHz
 VB: 300 kHz
 Detector: POS
 Attn: 20 DB
 RL Offset: 10.4 DB
 Sweep Time: 1.0ms
 Ref Lvl: 20.0 DBM

Comments
 802.11n 40MHz Chain 2
 20dB BW: 39.00 MHz
 FL = 5650.333 MHz

Cursor 1 5689.3333 3.96
 Cursor 2 5650.3333 -16.04

Delta Freq. 39.000
 Delta Amplitude 20.00



20dB bandwidth - 5670MHz, HT40, Chain C

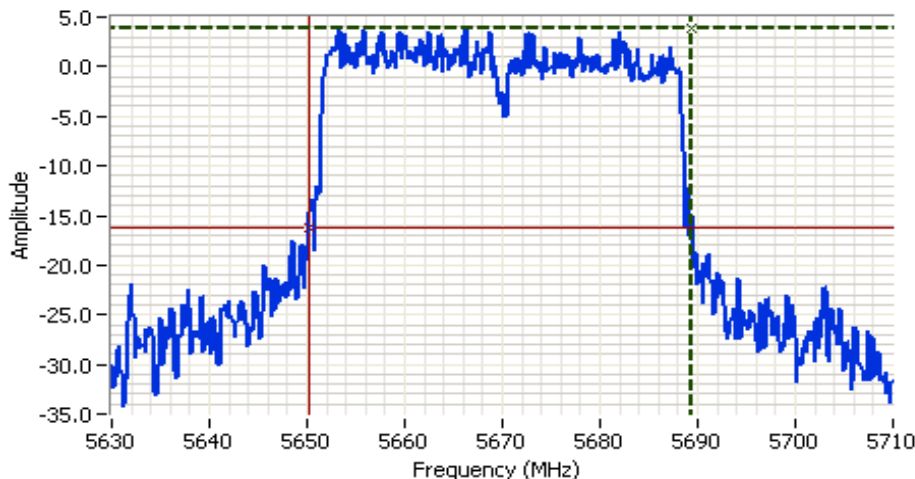

Analyzer Settings
 Agilent Technologies, E4446A
 CF: 5670.000 MHz
 SPAN: 80.000 MHz
 RB: 300 kHz
 VB: 300 kHz
 Detector: POS
 Attn: 20 DB
 RL Offset: 10.4 DB
 Sweep Time: 1.0ms
 Ref Lvl: 20.0 DBM

Comments
 802.11n 40MHz Chain 3
 20dB BW: 39.20 MHz
 FL = 5650.267 MHz

Cursor 1 5689.4667 3.82
 Cursor 2 5650.2667 -16.18

Delta Freq. 39.200
 Delta Amplitude 20.00



EXHIBIT 3: Photographs of Test Configurations

EXHIBIT 4: Operator's Manual

EXHIBIT 5: RF Exposure Information