



2.45GHz ULTRA COMPACT CHIP ANTENNA DATA GUIDE

DESCRIPTION

The exciting ANT-2.45-CHP is one of the world's smallest high-performance 2.4GHz Chip Antennas. It is ideal for all 2.4GHz applications including Bluetooth, 802.11, Home RF, ZigBee and other popular standards. The antenna uses advanced Low Temperature Co-fired Ceramic (LTCC) technology and a proprietary element to achieve superior size and performance characteristics. The tiny SMD package measures a mere 6.5mm (L) x 2.2mm (W) x 1.0mm (H) and is compatible with hand- and reflow-assembly. Favorable electrical specifications, stability, and outstanding cost-effectiveness make it the logical choice for a wide variety of applications.

PHYSICAL DIMENSIONS

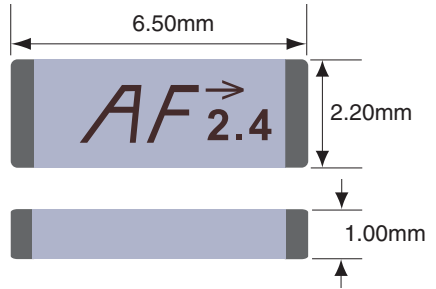

Actual Size



FEATURES

- Incredibly compact SMD package
- Superior LTCC technology
- 50Ω characteristic impedance
- Low loss
- Wide bandwidth
- Favorable linear polarization
- > Unity gain
- No external matching required
- Highly stable over temperature and humidity
- Fully hand- and reflow-assembly compatible
- Cost-effective

APPLICATIONS

Any 2.4GHz wireless product including:

- Bluetooth
- 802.11
- ZigBee
- Wireless PCMCIA Cards
- Telemetry
- Data Collection
- Industrial Process Monitoring
- Compact Wireless Products
- External Antenna Elimination

ORDERING INFORMATION

PART #	DESCRIPTION
ANT-2.45-CHP-x	2.45GHz Ultra-Compact Chip Antenna
x= "T" for Tape/Reel, "B" for Bulk	
Standard Reel is 3,000 pcs. Quantities less than 3,000 pcs. supplied in bulk.	

SPECIFICATIONS

PHYSICAL SPECIFICATIONS

Dimensions (mm)	6.5(L) x 2.2(W) x 1.0(H)
Operating/Storage Temperature	-40~+85°C
Construction	LTCC

ELECTRICAL PERFORMANCE

Center Frequency	2.45GHz
Bandwidth	180.0MHz
Pattern	Omni-directional
Polarization	Linear
VSWR	≤2.0 (Max.)
Maximum Gain	+0.5dBi
Impedance	50Ω
Power Handling	3W (Max.)

PAD LAYOUT

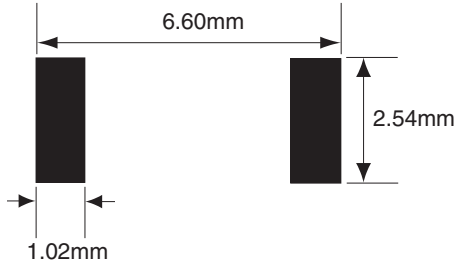

PIN CONFIGURATION

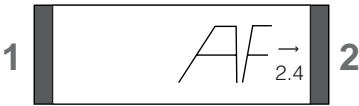

Pin No.	Pin Description
1	Feed Termination Pin connects to the transmitter or receiver.
2	Solder Termination Pin is soldered for physical support. There is no electrical connection.

LAYOUT DETAILS

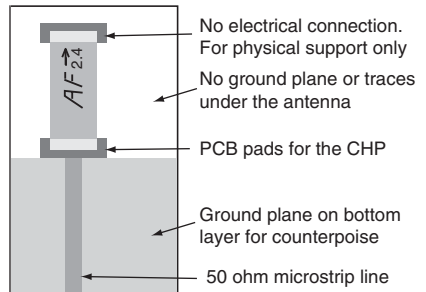

ASSEMBLY CONSIDERATIONS

The antenna is designed to support hand or automated assembly. To avoid damage to the part, the reflow/solder guidelines found below should be carefully followed. The antenna is single ended meaning that one pad is electrically connected while the other is for mechanical support only. The antenna terminals are not interchangeable so polarity must be observed during assembly.

Hand Soldering

This antenna is designed for high-volume automated assembly, however, it may be successfully attached by hand assembly techniques. A hand-solder temperature of 225° or lower should be used. Do not exceed a 10 sec. heating time.

Reflow Temperature Profile

The single most critical stage in the automated assembly process is the reflow process. The reflow profile below should be closely followed since excessive temperatures or transport times during reflow will irreparably damage the antennas. Assembly personnel will need to pay careful attention to the oven's profile to ensure that it meets the requirements necessary to successfully reflow all components while still meeting the limits mandated by the antennas themselves.

REFLOW SOLDERING PROFILE

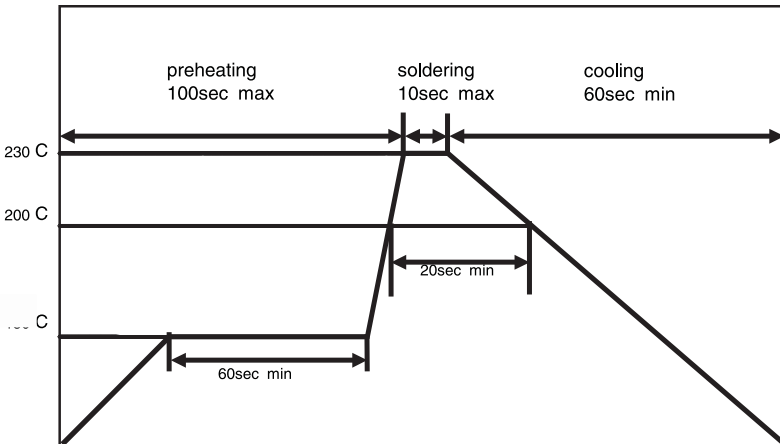

Absolute Maximum Solder Times

Hand-Solder Temp. TX +225°C for 10 Sec.

Hand-Solder Temp. RX +225°C for 10 Sec.

Recommended Solder Melting Point +180°C

Reflow Oven: +220°C Max. (See adjoining diagram)

LAYOUT CONSIDERATIONS

The antenna's wide bandwidth and good stability allow it to perform well and accommodate differing layout requirements. Despite this, proper layout is vital to ensure correct operation. Improper placement of planes, traces or system components will result in nulls or complete detuning. Failure by the designer to respect and account for these requirements will result in unsatisfactory performance. Ideally the antenna will be mounted on the board in such a way as to allow an unobstructed field of view. The area under the backside of the antenna must be free of components, traces, and planes. Components may be placed to the rear of the antenna in the ground plane counterpoise area. The feed trace from the RF stage to the antenna must be a microstrip trace or coax transmission line and should be kept as short as practical.

Two sample layouts and their associated data are illustrated on the following pages. They are intended to be representative and it is not necessary to follow them precisely. They do however, exhibit layout techniques and the differences that occur with differing size PCB's and layouts. After your own layout is complete the performance of the antenna in your specific product should be carefully checked using tools like a network analyzer. In some cases the size of the product's PCB, proximity of the case or other factors may make a custom version of the antenna necessary. You may contact Antenna Factor for more information.

MICROSTRIP CALCULATIONS

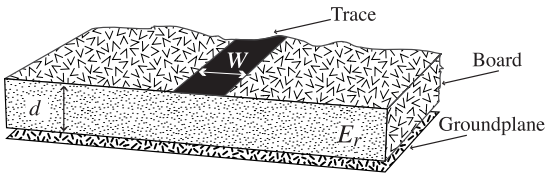

$$E_e = \frac{E_r + 1}{2} + \frac{E_r - 1}{2} \cdot \frac{1}{\sqrt{1 + 12d/W}}$$

$$Z_0 = \begin{cases} \frac{60 \cdot \ln\left(\frac{8d}{W} + \frac{W}{4d}\right)}{120\pi} & \text{For } \frac{W}{d} \leq 1 \\ \frac{120\pi}{\sqrt{E_e} \cdot \left(\frac{W}{d} + 1.393 + 0.667 \cdot \ln\left(\frac{W}{d} + 1.444\right)\right)} & \text{For } \frac{W}{d} \geq 1 \end{cases}$$

Microstrip Formulas (E_r = Dielectric constant of PC board material)

Dielectric Constant	Width/Height (W/d)	Effective Dielectric Constant	Characteristic Impedance
4.8	1.8	3.59	50.0
4	2	3.07	51.0
2.55	3	2.12	48.0

TEST BOARD PATTERNS

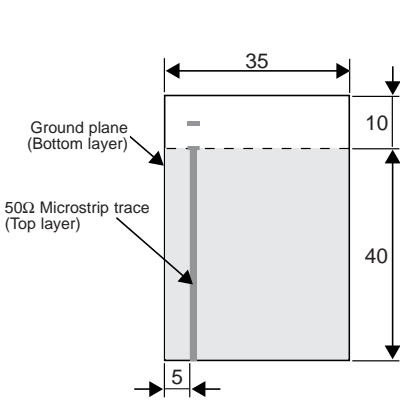

Test Board 1

Unit: mm
 Board Thickness: 0.023"
 Board Material: FR4

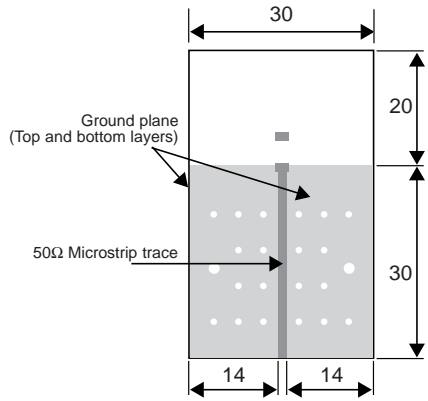

Test Board 2

Unit: mm
 Board Thickness: 0.031"
 Board Material: FR4

RETURN LOSS

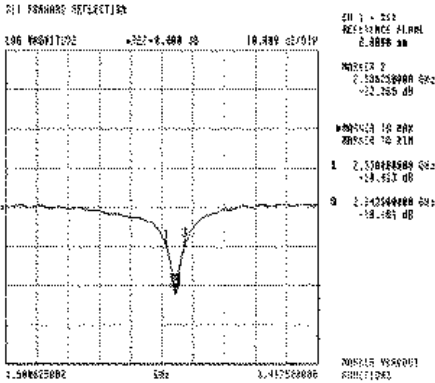

Test Board 1

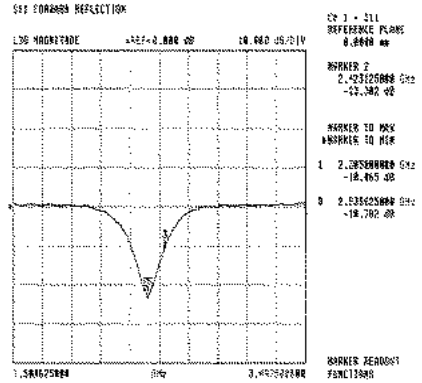

Test Board 2

2.45GHz H-Plane
Vertical

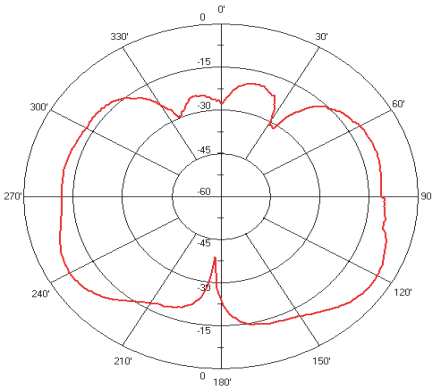

2.45GHz H-Plane
Horizontal

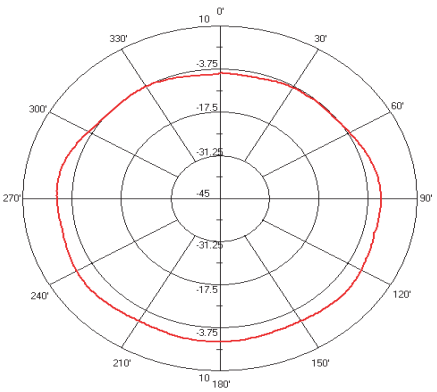

2.45GHz E-Plane
Vertical

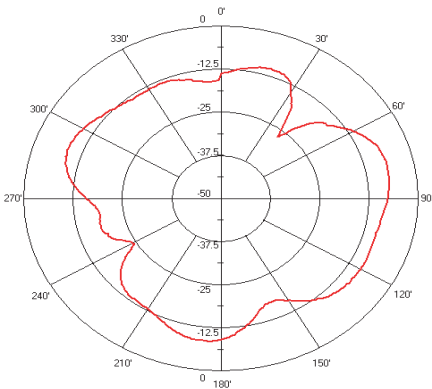

2.45GHz E-Plane
Horizontal

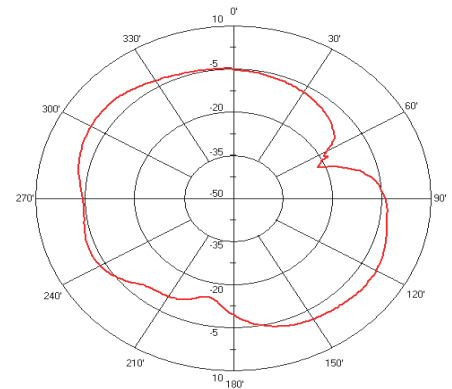

2.45GHz H-Plane
Vertical

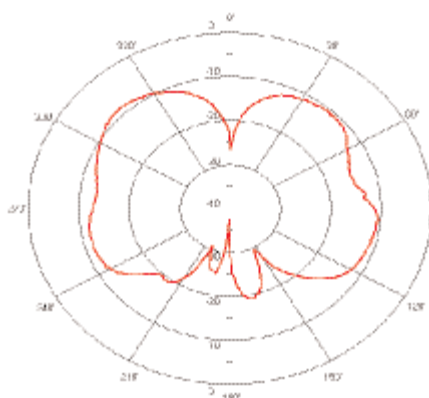

2.45GHz H-Plane
Horizontal

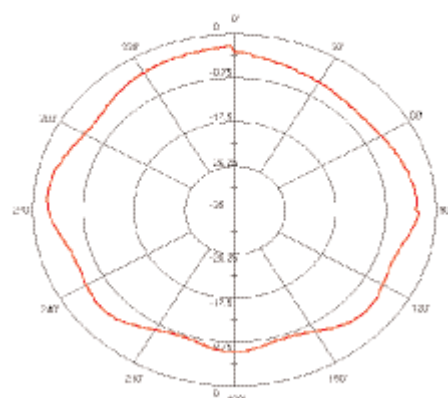

2.45GHz E-Plane
Vertical

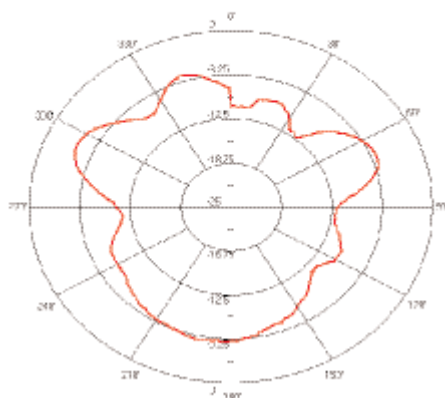

2.45GHz E-Plane
Horizontal

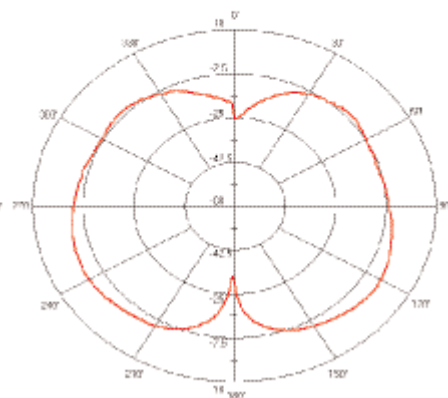



U.S. CORPORATE HEADQUARTERS

ANTENNA FACTOR, INC.

**575 SE ASHLEY PLACE
GRANTS PASS, OR 97526**

Phone: (541) 956-0931

Fax: (541) 471-6251

www.antennafactor.com

Disclaimer

Antenna Factor is continually striving to improve the quality and function of its products; for this reason, we reserve the right to make changes without notice. The information contained in this Data Sheet is believed to be accurate as of the time of publication. Specifications are based on representative lot samples. Values may vary from lot to lot and are not guaranteed. Antenna Factor makes no guarantee, warranty, or representation regarding the suitability of any product for use in a specific application. None of these devices is intended for use in applications of a critical nature where the safety of life or property is at risk. The user assumes full liability for the use of product in such applications. Under no conditions will Antenna Factor be responsible for losses arising from the use or failure of the device in any application, other than the repair, replacement, or refund limited to the original product purchase price. Some devices described in this publication are patented. Under no circumstances shall any user be conveyed any license or right to the use or ownership of these patents.

© 2005 by Antenna Factor, Inc. The stylized Antenna Factor logo, and Antenna Factor are trademarks of Linx Technologies, Inc.
Printed in U.S.A.