

# ELECTROMAGNETIC EMISSIONS COMPLIANCE REPORT

## INTENTIONAL RADIATOR CERTIFICATION TO FCC PART 15 SUBPART C REQUIREMENT

OF

**Product Name:** Juno T41/5  
**Brand Name:** Trimble  
**Marketing Name:** RH42G  
**Model No.:** JUNO/T41/5-BWC2RFG  
**Model Difference:** N/A  
**FCC ID:** S9E-JUNO41WN  
**Report No.:** ER/2015/60001  
**Issue Date:** Jun. 26, 2015  
**FCC Rule Part:** §15.247, Cat: DSS  
**Prepared for:** Trimble Navigation Limited  
 345 SW Avery Avenue, Corvallis, OR 97333  
 SGS Taiwan Ltd.  
**Prepared by:** Electronics & Communication Laboratory  
 No.134, Wu Kung Road, New Taipei Industrial  
 Park, Wuku District, New Taipei City, Taiwan  
 24803



*Note: This report shall not be reproduced except in full, without the written approval of SGS Taiwan Ltd. This document may be altered or revised by SGS Taiwan Ltd. personnel only, and shall be noted in the revision section of the document.*

Unless otherwise stated the results shown in this test report refer only to the sample(s) tested and such sample(s) are retained for 90 days only.

除非另有說明，此報告結果僅對測試之樣品負責，同時此樣品僅保留90天。本報告未經本公司書面許可，不可部份複製。

This document is issued by the Company subject to its General Conditions of Service printed overleaf, available on request or accessible at [www.sgs.com/terms\\_and\\_conditions.htm](http://www.sgs.com/terms_and_conditions.htm) and, for electronic format documents, subject to Terms and Conditions for Electronic Documents at [www.sgs.com/terms\\_e-document.htm](http://www.sgs.com/terms_e-document.htm). Attention is drawn to the limitation of liability, indemnification and jurisdiction issues defined therein. Any holder of this document is advised that information contained hereon reflects the Company's findings at the time of its intervention only and within the limits of Client's instructions, if any. The Company's sole responsibility is to its Client and this document does not exonerate parties to a transaction from exercising all their rights and obligations under the transaction documents. This document cannot be reproduced except in full, without prior written approval of the Company. Any unauthorized alteration, forgery or falsification of the content or appearance of this document is unlawful and offenders may be prosecuted to the fullest extent of the law.

SGS Taiwan Ltd.

No.134,WuKungRoad,NewTaipeiIndustrialPark,WukuDistrict,NewTaipeiCity,Taiwan24803/新北市五股區新北產業園區五工路 134 號

台灣檢驗科技股份有限公司

t (886-2) 2299-3279

f (886-2) 2298-0488

www.tw.sgs.com

Member of SGS Group

## VERIFICATION OF COMPLIANCE

**Applicant:** Trimble Navigation Limited  
345 SW Avery Avenue, Corvallis, OR 97333

**Product Name:** Juno T41/5

**Brand Name:** Trimble

**Marketing Name:** RH42G

**Model No.:** JUNO/T41/5-BWC2RFG

**Model Difference:** N/A

**FCC ID:** S9E-JUNO41WN

**Report Number:** ER/2015/60001

**Date of test:** Jun. 03, 2015 ~ Jun. 18, 2015

**Date of EUT Received:** Jun. 03, 2015

**We hereby certify that:**

The above equipment was tested by SGS Taiwan Ltd. Electronics & Communication Laboratory. The test data, data evaluation, test procedures, and equipment configurations shown in this report were made in accordance with the procedures given in ANSI C63.10:2009 and the energy emitted by the sample EUT tested as described in this report is in compliance with conducted and radiated emission limits.

The test results of this report relate only to the tested sample identified in this report.

*Test By:* Curry Chen *Date:* Jun. 26, 2015

---

*Curry Chen / Engineer*

*Prepared By:* Violetta Tang *Date:* Jun. 26, 2015

---

*Violetta Tang / Clerk*

*Approved By:* Jim Chang *Date:* Jun. 26, 2015

---

*Jim Chang / Asst. Manager*

Unless otherwise stated the results shown in this test report refer only to the sample(s) tested and such sample(s) are retained for 90 days only. 除非另有說明，此報告結果僅對測試之樣品負責，同時此樣品僅保留90天。本報告未經本公司書面許可，不可部份複製。  
This document is issued by the Company subject to its General Conditions of Service printed overleaf, available on request or accessible at [www.sgs.com/terms\\_and\\_conditions.htm](http://www.sgs.com/terms_and_conditions.htm) and, for electronic format documents, subject to Terms and Conditions for Electronic Documents at [www.sgs.com/terms\\_e-document.htm](http://www.sgs.com/terms_e-document.htm). Attention is drawn to the limitation of liability, indemnification and jurisdiction issues defined therein. Any holder of this document is advised that information contained hereon reflects the Company's findings at the time of its intervention only and within the limits of Client's instructions, if any. The Company's sole responsibility is to its Client and this document does not exonerate parties to a transaction from exercising all their rights and obligations under the transaction documents. This document cannot be reproduced except in full, without prior written approval of the Company. Any unauthorized alteration, forgery or falsification of the content or appearance of this document is unlawful and offenders may be prosecuted to the fullest extent of the law.

## Revision History

| Report Number | Revision | Description                  | Issue Date    |
|---------------|----------|------------------------------|---------------|
| ER/2015/60001 | Rev.00   | Initial creation of document | Jun. 26, 2015 |
|               |          |                              |               |
|               |          |                              |               |
|               |          |                              |               |

Unless otherwise stated the results shown in this test report refer only to the sample(s) tested and such sample(s) are retained for 90 days only.

除非另有說明，此報告結果僅對測試之樣品負責，同時此樣品僅保留90天。本報告未經本公司書面許可，不可部份複製。

This document is issued by the Company subject to its General Conditions of Service printed overleaf, available on request or accessible at [www.sgs.com/terms\\_and\\_conditions.htm](http://www.sgs.com/terms_and_conditions.htm) and, for electronic format documents, subject to Terms and Conditions for Electronic Documents at [www.sgs.com/terms\\_e-document.htm](http://www.sgs.com/terms_e-document.htm). Attention is drawn to the limitation of liability, indemnification and jurisdiction issues defined therein. Any holder of this document is advised that information contained hereon reflects the Company's findings at the time of its intervention only and within the limits of Client's instructions, if any. The Company's sole responsibility is to its Client and this document does not exonerate parties to a transaction from exercising all their rights and obligations under the transaction documents. This document cannot be reproduced except in full, without prior written approval of the Company. Any unauthorized alteration, forgery or falsification of the content or appearance of this document is unlawful and offenders may be prosecuted to the fullest extent of the law.

SGS Taiwan Ltd.

No.134,WuKungRoad,NewTaipeiIndustrialPark,WukuDistrict,NewTaipeiCity,Taiwan24803/新北市五股區新北產業園區五工路 134 號

台灣檢驗科技股份有限公司

t (886-2) 2299-3279

f (886-2) 2298-0488

[www.tw.sgs.com](http://www.tw.sgs.com)

Member of SGS Group

## Table of Contents

|  |           |
|--|-----------|
| <b>1. GENERAL INFORMATION.....</b>                     | <b>7</b>  |
| 1.1. Product description.....                          | 7         |
| 1.2. Product Feature of Equipment Under Test.....      | 8         |
| 1.3. Test Methodology of Applied Standards.....        | 9         |
| 1.4. Test Facility.....                                | 9         |
| 1.5. Special Accessories.....                          | 9         |
| 1.6. Equipment Modifications.....                      | 9         |
| <b>2. SYSTEM TEST CONFIGURATION.....</b>               | <b>10</b> |
| 2.1. EUT Configuration.....                            | 10        |
| 2.2. EUT Exercise.....                                 | 10        |
| 2.3. Test Procedure.....                               | 10        |
| 2.4. Measurement Results Explanation Example.....      | 10        |
| 2.5. Configuration of Tested System.....               | 11        |
| <b>3. SUMMARY OF TEST RESULTS.....</b>                 | <b>12</b> |
| <b>4. DESCRIPTION OF TEST MODES.....</b>               | <b>13</b> |
| 4.1. Operated in 2400 ~ 2483.5MHz Band.....            | 13        |
| 4.2. The Worst Test Modes and Channel Details.....     | 14        |
| <b>5. MEASUREMENT UNCERTAINTY.....</b>                 | <b>15</b> |
| <b>6. CONDUCTED EMISSION TEST.....</b>                 | <b>16</b> |
| 6.1. Standard Applicable.....                          | 16        |
| 6.2. Measurement Equipment Used.....                   | 16        |
| 6.3. EUT Setup.....                                    | 16        |
| 6.4. Test SET-UP (Block Diagram of Configuration)..... | 17        |
| 6.5. Measurement Procedure.....                        | 17        |
| 6.6. Measurement Result.....                           | 17        |
| <b>7. PEAK OUTPUT POWER MEASUREMENT.....</b>           | <b>20</b> |
| 7.1. Standard Applicable.....                          | 20        |
| 7.2. Measurement Equipment Used.....                   | 20        |
| 7.3. Test Set-up:.....                                 | 20        |
| 7.4. Measurement Procedure:.....                       | 20        |
| 7.5. Measurement Result.....                           | 21        |

Unless otherwise stated the results shown in this test report refer only to the sample(s) tested and such sample(s) are retained for 90 days only.

除非另有說明，此報告結果僅對測試之樣品負責，同時此樣品僅保留90天。本報告未經本公司書面許可，不可部份複製。

This document is issued by the Company subject to its General Conditions of Service printed overleaf, available on request or accessible at [www.sgs.com/terms\\_and\\_conditions.htm](http://www.sgs.com/terms_and_conditions.htm) and, for electronic format documents, subject to Terms and Conditions for Electronic Documents at [www.sgs.com/terms\\_e-document.htm](http://www.sgs.com/terms_e-document.htm). Attention is drawn to the limitation of liability, indemnification and jurisdiction issues defined therein. Any holder of this document is advised that information contained hereon reflects the Company's findings at the time of its intervention only and within the limits of Client's instructions, if any. The Company's sole responsibility is to its Client and this document does not exonerate parties to a transaction from exercising all their rights and obligations under the transaction documents. This document cannot be reproduced except in full, without prior written approval of the Company. Any unauthorized alteration, forgery or falsification of the content or appearance of this document is unlawful and offenders may be prosecuted to the fullest extent of the law.

SGS Taiwan Ltd.

No. 134, WuKungRoad, NewTaipeiIndustrialPark, WukuDistrict, NewTaipeiCity, Taiwan24803/新北市五股區新北產業園區五工路 134 號

台灣檢驗科技股份有限公司

t (886-2) 2299-3279

f (886-2) 2298-0488

www.tw.sgs.com

Member of SGS Group

|   |           |
|---|-----------|
| <b>8. 20dB BANDWIDTH MEASUREMENT.....</b>                                   | <b>22</b> |
| 8.1. Standard Applicable .....  | 22        |
| 8.2. Measurement Equipment Used .....                                       | 22        |
| 8.3. Test Set-up.....   | 22        |
| 8.4. Measurement Procedure.....   | 22        |
| 8.5. Measurement Result.....  | 23        |
| <b>9. CONDUCTED BAND EDGES AND SPURIOUS EMISSION MEASUREMENT.....</b>       | <b>29</b> |
| 9.1. Standard Applicable .....  | 29        |
| 9.2. Measurement Equipment Used .....                                       | 29        |
| 9.3. Test SET-UP .....  | 29        |
| 9.4. Measurement Procedure.....   | 30        |
| 9.5. Measurement Result.....  | 30        |
| <b>10. RADIATED BANDEDGE AND SPURIOUS EMISSION MEASUREMENT .....</b>        | <b>36</b> |
| 10.1. Standard Applicable .....   | 36        |
| 10.2. Measurement Equipment Used .....                                      | 37        |
| 10.3. Test SET-UP .....   | 37        |
| 10.4. Measurement Procedure.....  | 39        |
| 10.5. Field Strength Calculation.....                                       | 40        |
| 10.6. Test Results of Radiated Spurious Emissions form 9 KHz to 30 MHz..... | 40        |
| 10.7. Measurement Result.....   | 40        |
| <b>11. FREQUENCY SEPARATION.....</b>  | <b>57</b> |
| 11.1. Standard Applicable .....   | 57        |
| 11.2. Measurement Equipment Used .....                                      | 57        |
| 11.3. Test Set-up.....  | 57        |
| 11.4. Measurement Procedure.....  | 57        |
| 11.5. Measurement Result.....   | 58        |
| <b>12. NUMBER OF HOPPING FREQUENCY.....</b>                                 | <b>59</b> |
| 12.1. Standard Applicable .....   | 59        |
| 12.2. Measurement Equipment Used .....                                      | 59        |
| 12.3. Test Set-up.....  | 59        |
| 12.4. Measurement Procedure.....  | 59        |
| 12.5. Measurement Result.....   | 59        |

Unless otherwise stated the results shown in this test report refer only to the sample(s) tested and such sample(s) are retained for 90 days only.

除非另有說明，此報告結果僅對測試之樣品負責，同時此樣品僅保留90天。本報告未經本公司書面許可，不可部份複製。

This document is issued by the Company subject to its General Conditions of Service printed overleaf, available on request or accessible at [www.sgs.com/terms\\_and\\_conditions.htm](http://www.sgs.com/terms_and_conditions.htm) and, for electronic format documents, subject to Terms and Conditions for Electronic Documents at [www.sgs.com/terms\\_e-document.htm](http://www.sgs.com/terms_e-document.htm). Attention is drawn to the limitation of liability, indemnification and jurisdiction issues defined therein. Any holder of this document is advised that information contained hereon reflects the Company's findings at the time of its intervention only and within the limits of Client's instructions, if any. The Company's sole responsibility is to its Client and this document does not exonerate parties to a transaction from exercising all their rights and obligations under the transaction documents. This document cannot be reproduced except in full, without prior written approval of the Company. Any unauthorized alteration, forgery or falsification of the content or appearance of this document is unlawful and offenders may be prosecuted to the fullest extent of the law.

SGS Taiwan Ltd.

No.134,WuKungRoad,NewTaipeiIndustrialPark,WukuDistrict,NewTaipeiCity,Taiwan24803/新北市五股區新北產業園區五工路 134 號

台灣檢驗科技股份有限公司

t (886-2) 2299-3279

f (886-2) 2298-0488

www.tw.sgs.com

Member of SGS Group

**13. TIME OF OCCUPANCY (DWELL TIME)..... 61**

13.1. Standard Applicable ..... 61

13.2. Measurement Equipment Used ..... 61

13.3. Test Set-up..... 61

13.4. Measurement Procedure..... 62

13.5. Tabular Result of the Measurement ..... 63

13.6. Measurement Result..... 65

Unless otherwise stated the results shown in this test report refer only to the sample(s) tested and such sample(s) are retained for 90 days only.

除非另有說明，此報告結果僅對測試之樣品負責，同時此樣品僅保留90天。本報告未經本公司書面許可，不可部份複製。

This document is issued by the Company subject to its General Conditions of Service printed overleaf, available on request or accessible at [www.sgs.com/terms\\_and\\_conditions.htm](http://www.sgs.com/terms_and_conditions.htm) and, for electronic format documents, subject to Terms and Conditions for Electronic Documents at [www.sgs.com/terms\\_e-document.htm](http://www.sgs.com/terms_e-document.htm). Attention is drawn to the limitation of liability, indemnification and jurisdiction issues defined therein. Any holder of this document is advised that information contained hereon reflects the Company's findings at the time of its intervention only and within the limits of Client's instructions, if any. The Company's sole responsibility is to its Client and this document does not exonerate parties to a transaction from exercising all their rights and obligations under the transaction documents. This document cannot be reproduced except in full, without prior written approval of the Company. Any unauthorized alteration, forgery or falsification of the content or appearance of this document is unlawful and offenders may be prosecuted to the fullest extent of the law.

SGS Taiwan Ltd.

No.134,WuKungRoad,NewTaipeiIndustrialPark,WukuDistrict,NewTaipeiCity,Taiwan24803/新北市五股區新北產業園區五工路 134 號

台灣檢驗科技股份有限公司

t (886-2) 2299-3279

f (886-2) 2298-0488

[www.tw.sgs.com](http://www.tw.sgs.com)

Member of SGS Group

# 1. GENERAL INFORMATION

## 1.1. Product description

General:

|                   |   |  |
|-------------------|---|--|
| Product Name:     | Juno T41/5  |  |
| Brand Name:       | Trimble   |  |
| Marketing Name:   | RH42G   |  |
| Model No.:        | JUNO/T41/5-BWC2RFG  |  |
| Model Difference: | N/A   |  |
| Hardware Version: | V9  |  |
| Software Version: | 1.0.8(Build 396)  |  |
| Data Cable (USB): | Model No.: A9136939, Supplier: Sinbon                         |  |
| Power Supply:     | 3.7Vdc Rechargeable Li-ion Battery or 5Vdc from AC/DC Adapter |  |
|                   | Battery:  | Model No.: S11GD103A, Supplier: LICO                         |
|                   | Adapter:  | Model No.: PSA10F-050Q,<br>Supplier: PHIHONG TECHNOLOGY CO., |

Bluetooth\_BR+EDR:

|                      |   |
|----------------------|---|
| Bluetooth Version:   | V2.1 + EDR (GFSK + $\pi/4$ DQPSK + 8DPSK) |
| Channel number:      | 79 channels                               |
| Modulation type:     | Frequency Hopping Spread Spectrum         |
| Transmit Power:      | 5.93dBm                                   |
| Frequency Range:     | 2.402GHz – 2.480GHz                       |
| Dwell Time:          | $\leq 0.4s$                               |
| Antenna Designation: | PIFA Antenna, Gain: 2.5dBi                |

Unless otherwise stated the results shown in this test report refer only to the sample(s) tested and such sample(s) are retained for 90 days only.

除非另有說明，此報告結果僅對測試之樣品負責，同時此樣品僅保留90天。本報告未經本公司書面許可，不可部份複製。

This document is issued by the Company subject to its General Conditions of Service printed overleaf, available on request or accessible at [www.sgs.com/terms\\_and\\_conditions.htm](http://www.sgs.com/terms_and_conditions.htm) and, for electronic format documents, subject to Terms and Conditions for Electronic Documents at [www.sgs.com/terms\\_e-document.htm](http://www.sgs.com/terms_e-document.htm). Attention is drawn to the limitation of liability, indemnification and jurisdiction issues defined therein. Any holder of this document is advised that information contained hereon reflects the Company's findings at the time of its intervention only and within the limits of Client's instructions, if any. The Company's sole responsibility is to its Client and this document does not exonerate parties to a transaction from exercising all their rights and obligations under the transaction documents. This document cannot be reproduced except in full, without prior written approval of the Company. Any unauthorized alteration, forgery or falsification of the content or appearance of this document is unlawful and offenders may be prosecuted to the fullest extent of the law.

SGS Taiwan Ltd.

No.134,WuKungRoad,NewTaipeiIndustrialPark,WukuDistrict,NewTaipeiCity,Taiwan24803/新北市五股區新北產業園區五工路 134 號

台灣檢驗科技股份有限公司

t (886-2) 2299-3279

f (886-2) 2298-0488

www.tw.sgs.com

Member of SGS Group

## 1.2. Product Feature of Equipment Under Test

The equipment under Test (Hereafter Called: EUT) is Juno T41/5 supporting, GSM / WCDMA / CDMA, Wi-Fi 802.11bgn, Bluetooth with RFID features, and below is details of information.

| Product Feature               |                    |
|-------------------------------|--------------------|
| Product Name:                 | Juno T41/5         |
| Brand Name:                   | Trimble            |
| Marketing Name:               | RH42G              |
| Model No.:                    | JUNO/T41/5-BWC2RFG |
| Model Difference:             | N/A                |
| FCC ID                        | S9E-JUNO41WN       |
| GSM Operating Band(s)         | GSM 850 / 1900MHz  |
| GPRS / EGPRS Multi Slot Class | Class 12           |
| WCDMA Operating Band(s)       | FDD Band II / V    |
| CDMA / EVDO Operating Band(s) | BC0 / BC1 / BC10   |
| Wi-Fi Specification           | 802.11b/g/n        |
| Bluetooth Version             | V2.1+EDR           |
| RFID Specification            | RFID               |

**Note:** The above EUT information was declared by manufacturer. Please refer to the specifications or user's manual for more detailed description.

Unless otherwise stated the results shown in this test report refer only to the sample(s) tested and such sample(s) are retained for 90 days only.

除非另有說明，此報告結果僅對測試之樣品負責，同時此樣品僅保留90天。本報告未經本公司書面許可，不可部份複製。

This document is issued by the Company subject to its General Conditions of Service printed overleaf, available on request or accessible at [www.sgs.com/terms\\_and\\_conditions.htm](http://www.sgs.com/terms_and_conditions.htm) and, for electronic format documents, subject to Terms and Conditions for Electronic Documents at [www.sgs.com/terms\\_e-document.htm](http://www.sgs.com/terms_e-document.htm). Attention is drawn to the limitation of liability, indemnification and jurisdiction issues defined therein. Any holder of this document is advised that information contained hereon reflects the Company's findings at the time of its intervention only and within the limits of Client's instructions, if any. The Company's sole responsibility is to its Client and this document does not exonerate parties to a transaction from exercising all their rights and obligations under the transaction documents. This document cannot be reproduced except in full, without prior written approval of the Company. Any unauthorized alteration, forgery or falsification of the content or appearance of this document is unlawful and offenders may be prosecuted to the fullest extent of the law.

SGS Taiwan Ltd.

No.134,WuKungRoad,NewTaipeiIndustrialPark,WukuDistrict,NewTaipeiCity,Taiwan24803/新北市五股區新北產業園區五工路 134 號

台灣檢驗科技股份有限公司

t (886-2) 2299-3279

f (886-2) 2298-0488

www.tw.sgs.com

Member of SGS Group



### 1.3. Test Methodology of Applied Standards

FCC Part 15, Subpart C §15.247

FCC Public Notice DA 00-705 Measurement Guidelines

ANSI C63.10:2009

Note:

1. All test items have been performed and record as per the above standards.
2. The composite system is compliance with FCC Subpart B is authorized under the certification procedure.
3. The EUT was placed 0.8m height for frequency above 1GHz in accordance with ANSI C63.10 :2009

### 1.4. Test Facility

SGS Taiwan Ltd. Electronics & Communication Laboratory No.134, Wu Kung Road, New Taipei Industrial Park, Wuku District, New Taipei City, Taiwan. (TAF code 0513)

FCC Registration Numbers are: 990257 (Wuku)

Canada Registration Number: 4620A-5.

### 1.5. Special Accessories

There is no special accessory used while test was conducted.

### 1.6. Equipment Modifications

There was no modification incorporated into the EUT.

Unless otherwise stated the results shown in this test report refer only to the sample(s) tested and such sample(s) are retained for 90 days only.

除非另有說明，此報告結果僅對測試之樣品負責，同時此樣品僅保留90天。本報告未經本公司書面許可，不可部份複製。

This document is issued by the Company subject to its General Conditions of Service printed overleaf, available on request or accessible at [www.sgs.com/terms\\_and\\_conditions.htm](http://www.sgs.com/terms_and_conditions.htm) and, for electronic format documents, subject to Terms and Conditions for Electronic Documents at [www.sgs.com/terms\\_e-document.htm](http://www.sgs.com/terms_e-document.htm). Attention is drawn to the limitation of liability, indemnification and jurisdiction issues defined therein. Any holder of this document is advised that information contained hereon reflects the Company's findings at the time of its intervention only and within the limits of Client's instructions, if any. The Company's sole responsibility is to its Client and this document does not exonerate parties to a transaction from exercising all their rights and obligations under the transaction documents. This document cannot be reproduced except in full, without prior written approval of the Company. Any unauthorized alteration, forgery or falsification of the content or appearance of this document is unlawful and offenders may be prosecuted to the fullest extent of the law.

SGS Taiwan Ltd.

No.134,WuKungRoad,NewTaipeiIndustrialPark,WukuDistrict,NewTaipeiCity,Taiwan24803/新北市五股區新北產業園區五工路 134 號

台灣檢驗科技股份有限公司

t (886-2) 2299-3279

f (886-2) 2298-0488

[www.tw.sgs.com](http://www.tw.sgs.com)

Member of SGS Group

## 2. SYSTEM TEST CONFIGURATION

### 2.1. EUT Configuration

The EUT configuration for testing is installed on RF field strength measurement to meet the Commissions requirement and operating in a manner which intends to maximize its emission characteristics in a continuous normal application.

### 2.2. EUT Exercise

An engineering test mode (software/firmware) that applicant provided was utilized to manipulate the EUT into transmit, selection of the test channel, and modulation scheme.

### 2.3. Test Procedure

#### 2.3.1 Conducted Emissions

The EUT is placed on as turn table which is 0.8 m above ground plane. Conducted emissions from the EUT measured in the frequency range between 0.15 MHz and 30MHz,. The CISPR Quasi-Peak and Average detector mode is employed according to §15.107. The two LISNs provide 50 ohm/ 50uH of coupling impedance for the measuring instrument. Both lines of the power mains connected to the EUT were checked for maximum conducted interference.

#### 2.3.2 Radiated Emissions

The EUT is placed on as turn table. For emissions testing at or below 1 GHz, the table height shall be 0.8 m above the reference ground plane. For emission measurements above 1 GHz, the table height shall be 0.8 m. The turn table shall rotate 360 degrees to determine the position of maximum emission level. EUT is set 3m away from the receiving antenna which varied from 1m to 4m to find out the highest emission. And also, each emission was to be maximized by changing the polarization of receiving antenna both horizontal and vertical. In order to find out the max. emission, the relative positions of this hand-held transmitter (EUT) was rotated through three orthogonal axes and measurement procedures for electric field radiated emissions above 1 GHz the EUT measurement is to be made “while keeping the antenna in the ‘cone of radiation’ from that area and pointed at the area both in azimuth and elevation, with polarization oriented for maximum response.” is still within the 3dB illumination BW of the measurement antenna.

### 2.4. Measurement Results Explanation Example

#### For all conducted test items:

The offset level is set in the spectrum analyzer to compensate the RF cable loss and attenuation factor between EUT conducted port and spectrum analyzer. With the offset compensation, the spectrum analyzer reading level is exactly EUT RF output level.

#### Note:

The spectrum analyzer offset is derived from RF cable loss and attenuator factor.

Following shows an offset computation example with cable loss 1dB and 10dB attenuator.

Offset = RF cable loss (dB)+ attenuation factor(dB) =1+10=11(dB)

Unless otherwise stated the results shown in this test report refer only to the sample(s) tested and such sample(s) are retained for 90 days only.

除非另有說明，此報告結果僅對測試之樣品負責，同時此樣品僅保留90天。本報告未經本公司書面許可，不可部份複製。

This document is issued by the Company subject to its General Conditions of Service printed overleaf, available on request or accessible at [www.sgs.com/terms\\_and\\_conditions.htm](http://www.sgs.com/terms_and_conditions.htm) and, for electronic format documents, subject to Terms and Conditions for Electronic Documents at [www.sgs.com/terms\\_e-document.htm](http://www.sgs.com/terms_e-document.htm). Attention is drawn to the limitation of liability, indemnification and jurisdiction issues defined therein. Any holder of this document is advised that information contained hereon reflects the Company's findings at the time of its intervention only and within the limits of Client's instructions, if any. The Company's sole responsibility is to its Client and this document does not exonerate parties to a transaction from exercising all their rights and obligations under the transaction documents. This document cannot be reproduced except in full, without prior written approval of the Company. Any unauthorized alteration, forgery or falsification of the content or appearance of this document is unlawful and offenders may be prosecuted to the fullest extent of the law.

## 2.5. Configuration of Tested System

**Fig. 2-1 Radiated Emission**

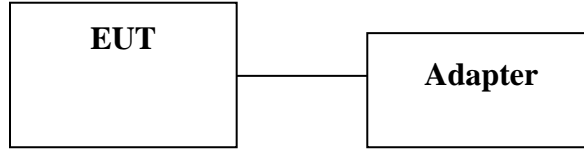

**Fig. 2-2 Conducted (Antenna Port) Configuration**

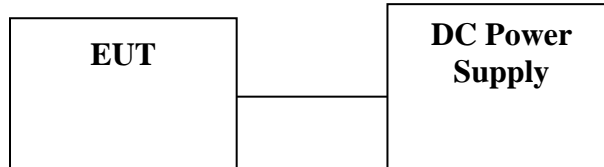

**Fig. 2-3 AC Power Line Conducted Emission**

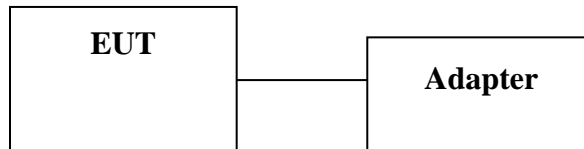

**Table 2-1 Equipment Used in Tested System**

| Item | Equipment               | Mfr/Brand | Model/Type No. | Series No. | Data Cable | Power Cord |
|------|-------------------------|-----------|----------------|------------|------------|------------|
| 1.   | Bluetooth Test Software | N/A       | N/A            | N/A        | N/A        | N/A        |
| 2.   | DC Power Supply         | HP        | E3640A         | KR93300208 | N/A        | N/A        |

Unless otherwise stated the results shown in this test report refer only to the sample(s) tested and such sample(s) are retained for 90 days only.

除非另有說明，此報告結果僅對測試之樣品負責，同時此樣品僅保留90天。本報告未經本公司書面許可，不可部份複製。

This document is issued by the Company subject to its General Conditions of Service printed overleaf, available on request or accessible at [www.sgs.com/terms\\_and\\_conditions.htm](http://www.sgs.com/terms_and_conditions.htm) and, for electronic format documents, subject to Terms and Conditions for Electronic Documents at [www.sgs.com/terms\\_e-document.htm](http://www.sgs.com/terms_e-document.htm). Attention is drawn to the limitation of liability, indemnification and jurisdiction issues defined therein. Any holder of this document is advised that information contained hereon reflects the Company's findings at the time of its intervention only and within the limits of Client's instructions, if any. The Company's sole responsibility is to its Client and this document does not exonerate parties to a transaction from exercising all their rights and obligations under the transaction documents. This document cannot be reproduced except in full, without prior written approval of the Company. Any unauthorized alteration, forgery or falsification of the content or appearance of this document is unlawful and offenders may be prosecuted to the fullest extent of the law.

SGS Taiwan Ltd.

No.134,WuKungRoad,NewTaipeiIndustrialPark,WukuDistrict,NewTaipeiCity,Taiwan24803/新北市五股區新北產業園區五工路 134 號

台灣檢驗科技股份有限公司

t (886-2) 2299-3279

f (886-2) 2298-0488

www.tw.sgs.com

Member of SGS Group

### 3. SUMMARY OF TEST RESULTS

| FCC Rules             | Description Of Test                       | Result    |
|-----------------------|---|-----------|
| §15.207(a)            | AC Power Line Conducted Emission          | Compliant |
| §15.247(b)(1)         | Peak Output Power                         | Compliant |
| §15.247(a)(1)         | 20dB Bandwidth                            | Compliant |
| §15.247(d)            | Conducted Band Edge and Spurious Emission | Compliant |
| §15.247(d)            | Radiated Band Edge and Spurious Emission  | Compliant |
| §15.247(a)(1)         | Frequency Separation                      | Compliant |
| §15.247(a)(1)(iii)    | Number of hopping frequency               | Compliant |
| §15.247(a)(1)(iii)    | Time of Occupancy                         | Compliant |
| §15.203<br>§15.247(b) | Antenna Requirement                       | Compliant |

Unless otherwise stated the results shown in this test report refer only to the sample(s) tested and such sample(s) are retained for 90 days only.

除非另有說明，此報告結果僅對測試之樣品負責，同時此樣品僅保留90天。本報告未經本公司書面許可，不可部份複製。

This document is issued by the Company subject to its General Conditions of Service printed overleaf, available on request or accessible at [www.sgs.com/terms\\_and\\_conditions.htm](http://www.sgs.com/terms_and_conditions.htm) and, for electronic format documents, subject to Terms and Conditions for Electronic Documents at [www.sgs.com/terms\\_e-document.htm](http://www.sgs.com/terms_e-document.htm). Attention is drawn to the limitation of liability, indemnification and jurisdiction issues defined therein. Any holder of this document is advised that information contained hereon reflects the Company's findings at the time of its intervention only and within the limits of Client's instructions, if any. The Company's sole responsibility is to its Client and this document does not exonerate parties to a transaction from exercising all their rights and obligations under the transaction documents. This document cannot be reproduced except in full, without prior written approval of the Company. Any unauthorized alteration, forgery or falsification of the content or appearance of this document is unlawful and offenders may be prosecuted to the fullest extent of the law.

SGS Taiwan Ltd.

No.134,WuKungRoad,NewTaipeiIndustrialPark,WukuDistrict,NewTaipeiCity,Taiwan24803/新北市五股區新北產業園區五工路 134 號

台灣檢驗科技股份有限公司

t (886-2) 2299-3279

f (886-2) 2298-0488

[www.tw.sgs.com](http://www.tw.sgs.com)

Member of SGS Group

#### 4. DESCRIPTION OF TEST MODES

##### 4.1. Operated in 2400 ~ 2483.5MHz Band

79 channels are provided for Bluetooth

| CH | FREQUENCY | CH | FREQUENCY | CH | FREQUENCY | CH | FREQUENCY |
|----|-----------|----|-----------|----|-----------|----|-----------|
| 0  | 2402 MHz  | 20 | 2422 MHz  | 40 | 2442 MHz  | 70 | 2462 MHz  |
| 1  | 2403 MHz  | 21 | 2423 MHz  | 41 | 2443 MHz  | 71 | 2463 MHz  |
| 2  | 2404 MHz  | 22 | 2424 MHz  | 42 | 2444 MHz  | 72 | 2464 MHz  |
| 3  | 2405 MHz  | 23 | 2425 MHz  | 43 | 2445 MHz  | 73 | 2465 MHz  |
| 4  | 2406 MHz  | 24 | 2426 MHz  | 44 | 2446 MHz  | 74 | 2466 MHz  |
| 5  | 2407 MHz  | 25 | 2427 MHz  | 45 | 2447 MHz  | 75 | 2467 MHz  |
| 6  | 2408 MHz  | 26 | 2428 MHz  | 46 | 2448 MHz  | 76 | 2468 MHz  |
| 7  | 2409 MHz  | 27 | 2429 MHz  | 47 | 2449 MHz  | 77 | 2469 MHz  |
| 8  | 2410 MHz  | 28 | 2430 MHz  | 48 | 2450 MHz  | 78 | 2470 MHz  |
| 9  | 2411 MHz  | 29 | 2431 MHz  | 49 | 2451 MHz  | 79 | 2471 MHz  |
| 10 | 2412 MHz  | 30 | 2432 MHz  | 50 | 2452 MHz  | 70 | 2472 MHz  |
| 11 | 2413 MHz  | 31 | 2433 MHz  | 51 | 2453 MHz  | 71 | 2473 MHz  |
| 12 | 2414 MHz  | 32 | 2434 MHz  | 52 | 2454 MHz  | 72 | 2474 MHz  |
| 13 | 2415 MHz  | 33 | 2435 MHz  | 53 | 2455 MHz  | 73 | 2475 MHz  |
| 14 | 2416 MHz  | 34 | 2436 MHz  | 54 | 2456 MHz  | 74 | 2476 MHz  |
| 15 | 2417 MHz  | 35 | 2437 MHz  | 55 | 2457 MHz  | 75 | 2477 MHz  |
| 16 | 2418 MHz  | 36 | 2438 MHz  | 56 | 2458 MHz  | 76 | 2478 MHz  |
| 17 | 2419 MHz  | 37 | 2439 MHz  | 57 | 2459 MHz  | 77 | 2479 MHz  |
| 18 | 2420 MHz  | 38 | 2440 MHz  | 58 | 2460 MHz  | 78 | 2480 MHz  |
| 19 | 2421 MHz  | 39 | 2441 MHz  | 59 | 2461 MHz  |    |           |

Unless otherwise stated the results shown in this test report refer only to the sample(s) tested and such sample(s) are retained for 90 days only.

除非另有說明，此報告結果僅對測試之樣品負責，同時此樣品僅保留90天。本報告未經本公司書面許可，不可部份複製。

This document is issued by the Company subject to its General Conditions of Service printed overleaf, available on request or accessible at [www.sgs.com/terms\\_and\\_conditions.htm](http://www.sgs.com/terms_and_conditions.htm) and, for electronic format documents, subject to Terms and Conditions for Electronic Documents at [www.sgs.com/terms\\_e-document.htm](http://www.sgs.com/terms_e-document.htm). Attention is drawn to the limitation of liability, indemnification and jurisdiction issues defined therein. Any holder of this document is advised that information contained hereon reflects the Company's findings at the time of its intervention only and within the limits of Client's instructions, if any. The Company's sole responsibility is to its Client and this document does not exonerate parties to a transaction from exercising all their rights and obligations under the transaction documents. This document cannot be reproduced except in full, without prior written approval of the Company. Any unauthorized alteration, forgery or falsification of the content or appearance of this document is unlawful and offenders may be prosecuted to the fullest extent of the law.

SGS Taiwan Ltd.

No.134,WuKungRoad,NewTaipeiIndustrialPark,WukuDistrict,NewTaipeiCity,Taiwan24803/新北市五股區新北產業園區五工路 134 號

台灣檢驗科技股份有限公司

t (886-2) 2299-3279

f (886-2) 2298-0488

www.tw.sgs.com

Member of SGS Group

**4.2. The Worst Test Modes and Channel Details**

- 1 The EUT has been tested under operating condition.
- 2 Test program used to control the EUT for staying in continuous transmitting and receiving mode is programmed.
- 3 Investigation has been done on all the possible configurations for searching the worst case.

**RADIATED EMISSION TEST:**

| RADIATED EMISSION TEST (BELOW 1 GHz) |                   |                |            |             |              |
|--------------------------------------|-------------------|----------------|------------|-------------|--------------|
| MODE                                 | AVAILABLE CHANNEL | TESTED CHANNEL | MODULATION | PACKET TYPE | ANTENNA PORT |
| Bluetooth                            | 0 to 78           | 0,39,78        | 8-DQPK     | 3DH5        | MAIN         |
| RADIATED EMISSION TEST (ABOVE 1 GHz) |                   |                |            |             |              |
| MODE                                 | AVAILABLE CHANNEL | TESTED CHANNEL | MODULATION | PACKET TYPE | ANTENNA PORT |
| Bluetooth                            | 0 to 78           | 0,39,78        | 8-DQPK     | 3DH5        | MAIN         |

**Note:**

The field strength of radiation emission was measured as EUT stand-up position (H mode) and lie down position (E1, E2 mode) for Bluetooth BR+EDR Transmitter for channel Low, Mid and High, the worst case E2 position was reported.

**ANTENNA PORT CONDUCTED MEASUREMENT:**

| CONDUCTED TEST                     |                   |                |            |             |              |
|------------------------------------|-------------------|----------------|------------|-------------|--------------|
| Peak Output Power, 20dB Band Width |                   |                |            |             |              |
| MODE                               | AVAILABLE CHANNEL | TESTED CHANNEL | MODULATION | PACKET TYPE | ANTENNA PORT |
| Bluetooth                          | 0 to 78           | 0,39,78        | GFSK       | DH5         | MAIN         |
|                                    | 0 to 78           | 0,39,78        | /4-DQPSK   | 2DH5        | MAIN         |
|                                    | 0 to 78           | 0,39,78        | 8-DQPK     | 3DH5        | MAIN         |
| Band Edge                          |                   |                |            |             |              |
| Bluetooth                          | 0 to 78           | 0,78           | 8-DQPK     | 3DH5        | MAIN         |
| Frequency Separation               |                   |                |            |             |              |
| Bluetooth                          | 0 to 78           | 0,1,2          | GFSK       | DH5         | MAIN         |
| Number of hopping frequency        |                   |                |            |             |              |
| Bluetooth                          | 0 to 78           | 0 to 78        | GFSK       | DH5         | MAIN         |
| Time of Occupancy (Dwell time)     |                   |                |            |             |              |
| Bluetooth                          | 0 to 78           | 0,39,78        | GFSK       | DH1/DH3/DH5 | MAIN         |
| Bluetooth                          | 0 to 78           | 39             | /4-DQPSK   | DH1/DH3/DH5 | MAIN         |
| Bluetooth                          | 0 to 78           | 39             | 8-DPSK     | DH1/DH3/DH5 | MAIN         |

Unless otherwise stated the results shown in this test report refer only to the sample(s) tested and such sample(s) are retained for 90 days only.

除非另有說明，此報告結果僅對測試之樣品負責，同時此樣品僅保留90天。本報告未經本公司書面許可，不可部份複製。

This document is issued by the Company subject to its General Conditions of Service printed overleaf, available on request or accessible at [www.sgs.com/terms\\_and\\_conditions.htm](http://www.sgs.com/terms_and_conditions.htm) and, for electronic format documents, subject to Terms and Conditions for Electronic Documents at [www.sgs.com/terms\\_e-document.htm](http://www.sgs.com/terms_e-document.htm). Attention is drawn to the limitation of liability, indemnification and jurisdiction issues defined therein. Any holder of this document is advised that information contained hereon reflects the Company's findings at the time of its intervention only and within the limits of Client's instructions, if any. The Company's sole responsibility is to its Client and this document does not exonerate parties to a transaction from exercising all their rights and obligations under the transaction documents. This document cannot be reproduced except in full, without prior written approval of the Company. Any unauthorized alteration, forgery or falsification of the content or appearance of this document is unlawful and offenders may be prosecuted to the fullest extent of the law.

## 5. MEASUREMENT UNCERTAINTY

| Test Items                                | Uncertainty                 |
|---|-----------------------------|
| AC Power Line Conducted Emission          | +/- 2.586 dB                |
| Peak Output Power                         | +/- 0.84 dB                 |
| 20dB Bandwidth                            | +/- 51.33 Hz                |
| 100 KHz Bandwidth Of Frequency Band Edges | +/- 0.84 dB                 |
| Frequency Separation                      | +/- 51.33 Hz                |
| Number of hopping frequency               | +/- 51.33 Hz                |
| Time of Occupancy                         | +/- 51.33 Hz                |
| Temperature                               | +/- 0.65 °C                 |
| Humidity                                  | +/- 4.6 %                   |
| DC / AC Power Source                      | DC= +/- 0.13%, AC= +/- 0.2% |

### Radiated Spurious Emission:

|  |                            |
|--|----------------------------|
| Measurement uncertainty<br>(Polarization : <b>Vertical</b> ) | 30MHz - 180MHz: +/- 3.37dB |
|  | 180MHz -417MHz: +/- 3.19dB |
|  | 0.417GHz-1GHz: +/- 3.19dB  |
|  | 1GHz - 18GHz: +/- 4.04dB   |
|  | 18GHz - 40GHz: +/- 4.04dB  |

|  |                            |
|--|----------------------------|
| Measurement uncertainty<br>(Polarization : <b>Horizontal</b> ) | 30MHz - 167MHz: +/- 4.22dB |
|  | 167MHz -500MHz: +/- 3.44dB |
|  | 0.5GHz-1GHz: +/- 3.39dB    |
|  | 1GHz - 18GHz: +/- 4.08dB   |
|  | 18GHz - 40GHz: +/- 4.08dB  |

This uncertainty represents an expanded uncertainty expressed at approximately the 95% confidence level using a coverage factor of k=2.

Unless otherwise stated the results shown in this test report refer only to the sample(s) tested and such sample(s) are retained for 90 days only.

除非另有說明，此報告結果僅對測試之樣品負責，同時此樣品僅保留90天。本報告未經本公司書面許可，不可部份複製。

This document is issued by the Company subject to its General Conditions of Service printed overleaf, available on request or accessible at [www.sgs.com/terms\\_and\\_conditions.htm](http://www.sgs.com/terms_and_conditions.htm) and, for electronic format documents, subject to Terms and Conditions for Electronic Documents at [www.sgs.com/terms\\_e-document.htm](http://www.sgs.com/terms_e-document.htm). Attention is drawn to the limitation of liability, indemnification and jurisdiction issues defined therein. Any holder of this document is advised that information contained hereon reflects the Company's findings at the time of its intervention only and within the limits of Client's instructions, if any. The Company's sole responsibility is to its Client and this document does not exonerate parties to a transaction from exercising all their rights and obligations under the transaction documents. This document cannot be reproduced except in full, without prior written approval of the Company. Any unauthorized alteration, forgery or falsification of the content or appearance of this document is unlawful and offenders may be prosecuted to the fullest extent of the law.

SGS Taiwan Ltd.

No.134,WuKungRoad,NewTaipeiIndustrialPark,WukuDistrict,NewTaipeiCity,Taiwan24803/新北市五股區新北產業園區五工路 134 號

台灣檢驗科技股份有限公司

t (886-2) 2299-3279

f (886-2) 2298-0488

[www.tw.sgs.com](http://www.tw.sgs.com)

Member of SGS Group

## 6. CONDUCTED EMISSION TEST

### 6.1. Standard Applicable

According to §15.207, frequency within 150 kHz to 30MHz shall not exceed the limit table as below.

| Frequency range<br>MHz | Limits<br>dB(uV) |          |
|------------------------|------------------|----------|
|                        | Quasi-peak       | Average  |
| 0.15 to 0.50           | 66 to 56         | 56 to 46 |
| 0.50 to 5              | 56               | 46       |
| 5 to 30                | 60               | 50       |

Note

- 1.The lower limit shall apply at the transition frequencies
- 2.The limit decreases linearly with the logarithm of the frequency in the range 0.15 MHz to 0.50 MHz.

### 6.2. Measurement Equipment Used

| Conducted Emission Test Site |              |                         |               |            |            |
|------------------------------|--------------|-------------------------|---------------|------------|------------|
| EQUIPMENT TYPE               | MFR          | MODEL NUMBER            | SERIAL NUMBER | LAST CAL.  | CAL DUE.   |
| EMI Test Receiver            | R&S          | ESCI7                   | 100760        | 05/04/2015 | 05/03/2016 |
| LISN                         | SCHWARZ BECK | NSLK 8127               | 8127-649      | 05/15/2015 | 05/14/2016 |
| LISN                         | FCC          | FCC-LISN-50/250-25-2-01 | 04034         | 03/13/2015 | 03/12/2016 |
| Coaxial Cables               | N/A          | WK CE Cable             | N/A           | 11/26/2014 | 11/25/2015 |

### 6.3. EUT Setup

1. The conducted emission tests were performed in the test site, using the setup in accordance with the ANSI 63.10:2009.
2. The AC/DC Power adaptor of EUT was plug-in LISN. The EUT was placed flushed with the rear of the table.
3. The LISN was connected with 120Vac/60Hz power source.

Unless otherwise stated the results shown in this test report refer only to the sample(s) tested and such sample(s) are retained for 90 days only.

除非另有說明，此報告結果僅對測試之樣品負責，同時此樣品僅保留90天。本報告未經本公司書面許可，不可部份複製。

This document is issued by the Company subject to its General Conditions of Service printed overleaf, available on request or accessible at [www.sgs.com/terms\\_and\\_conditions.htm](http://www.sgs.com/terms_and_conditions.htm) and, for electronic format documents, subject to Terms and Conditions for Electronic Documents at [www.sgs.com/terms\\_e-document.htm](http://www.sgs.com/terms_e-document.htm). Attention is drawn to the limitation of liability, indemnification and jurisdiction issues defined therein. Any holder of this document is advised that information contained hereon reflects the Company's findings at the time of its intervention only and within the limits of Client's instructions, if any. The Company's sole responsibility is to its Client and this document does not exonerate parties to a transaction from exercising all their rights and obligations under the transaction documents. This document cannot be reproduced except in full, without prior written approval of the Company. Any unauthorized alteration, forgery or falsification of the content or appearance of this document is unlawful and offenders may be prosecuted to the fullest extent of the law.

SGS Taiwan Ltd.

No.134,WuKungRoad,NewTaipeiIndustrialPark,WukuDistrict,NewTaipeiCity,Taiwan24803/新北市五股區新北產業園區五工路 134 號

台灣檢驗科技股份有限公司

t (886-2) 2299-3279

f (886-2) 2298-0488

www.tw.sgs.com

Member of SGS Group



#### 6.4. Test SET-UP (Block Diagram of Configuration)

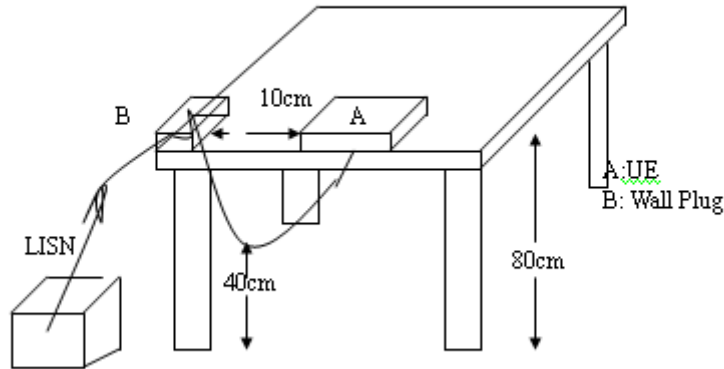

#### 6.5. Measurement Procedure

1. The EUT was placed on a table which is 0.8m above ground plane.
2. Maximum procedure was performed on the six highest emissions to ensure EUT compliance.
3. Repeat above procedures until all frequency measured were complete.

#### 6.6. Measurement Result

Note: Refer to next page for measurement data and plots.

Note2: The \* reveals the worst-case results that closet to the limit

Unless otherwise stated the results shown in this test report refer only to the sample(s) tested and such sample(s) are retained for 90 days only.

除非另有說明，此報告結果僅對測試之樣品負責，同時此樣品僅保留90天。本報告未經本公司書面許可，不可部份複製。

This document is issued by the Company subject to its General Conditions of Service printed overleaf, available on request or accessible at [www.sgs.com/terms\\_and\\_conditions.htm](http://www.sgs.com/terms_and_conditions.htm) and, for electronic format documents, subject to Terms and Conditions for Electronic Documents at [www.sgs.com/terms\\_e-document.htm](http://www.sgs.com/terms_e-document.htm). Attention is drawn to the limitation of liability, indemnification and jurisdiction issues defined therein. Any holder of this document is advised that information contained hereon reflects the Company's findings at the time of its intervention only and within the limits of Client's instructions, if any. The Company's sole responsibility is to its Client and this document does not exonerate parties to a transaction from exercising all their rights and obligations under the transaction documents. This document cannot be reproduced except in full, without prior written approval of the Company. Any unauthorized alteration, forgery or falsification of the content or appearance of this document is unlawful and offenders may be prosecuted to the fullest extent of the law.

SGS Taiwan Ltd.

No.134,WuKungRoad,NewTaipeiIndustrialPark,WukuDistrict,NewTaipeiCity,Taiwan24803/新北市五股區新北產業園區五工路 134 號

台灣檢驗科技股份有限公司

t (886-2) 2299-3279

f (886-2) 2298-0488

www.tw.sgs.com

Member of SGS Group

## AC POWER LINE CONDUCTED EMISSION TEST DATA

|                 |                |            |               |
|-----------------|----------------|------------|---------------|
| Operation Mode: | Operation mode | Test Date: | Jun. 18, 2015 |
| Temperature:    | 24             | Humidity:  | 66 %          |
|                 |                | Test By:   | Marcus        |
|                 |                | Phase:     | L1            |

|                                   |                     |                    |
|-----------------------------------|---------------------|--------------------|
| Site: ConductionRoom              | Phase: <b>L1</b>    | Temperature: 24 °C |
| Limit: FCC Class B Conduction(OP) | Power: AC 120V/60Hz | Humidity: 66%      |
| Mode: Operation                   |                     |                    |
| Note:                             |                     |                    |

### Conducted Emission

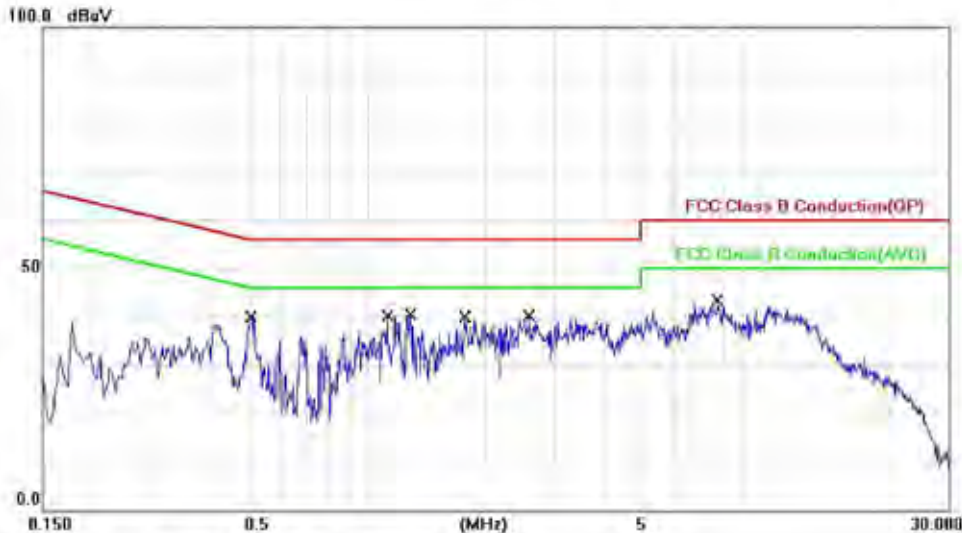

| No. | Mk. | Freq.  | Reading Level | Correct Factor | Measurement | Limit | Over   | Detector | Comment |
|-----|-----|--------|---------------|----------------|-------------|-------|--------|----------|---------|
|     |     | MHz    | dBuV          | dB             | dBuV        | dBuV  | dB     |          |         |
| 1   |     | 0.5073 | 37.30         | 0.04           | 37.34       | 56.00 | -18.66 | QP       |         |
| 2 * |     | 0.5073 | 29.30         | 0.04           | 29.34       | 46.00 | -16.66 | AVG      |         |
| 3   |     | 1.1260 | 32.00         | 0.05           | 32.05       | 56.00 | -23.95 | QP       |         |
| 4   |     | 1.1260 | 21.10         | 0.05           | 21.15       | 46.00 | -24.85 | AVG      |         |
| 5   |     | 1.2904 | 36.00         | 0.06           | 36.06       | 56.00 | -19.94 | QP       |         |
| 6   |     | 1.2904 | 24.40         | 0.06           | 24.46       | 46.00 | -21.54 | AVG      |         |
| 7   |     | 1.7730 | 33.80         | 0.07           | 33.87       | 56.00 | -22.13 | QP       |         |
| 8   |     | 1.7730 | 23.80         | 0.07           | 23.87       | 46.00 | -22.13 | AVG      |         |
| 9   |     | 2.5580 | 34.10         | 0.09           | 34.19       | 56.00 | -21.81 | QP       |         |
| 10  |     | 2.5580 | 23.00         | 0.09           | 23.09       | 46.00 | -22.91 | AVG      |         |
| 11  |     | 7.7400 | 35.70         | 0.24           | 35.94       | 60.00 | -24.06 | QP       |         |
| 12  |     | 7.7400 | 23.70         | 0.24           | 23.94       | 50.00 | -26.06 | AVG      |         |

Unless otherwise stated the results shown in this test report refer only to the sample(s) tested and such sample(s) are retained for 90 days only.

除非另有說明，此報告結果僅對測試之樣品負責，同時此樣品僅保留90天。本報告未經本公司書面許可，不可部份複製。

This document is issued by the Company subject to its General Conditions of Service printed overleaf, available on request or accessible at [www.sgs.com/terms\\_and\\_conditions.htm](http://www.sgs.com/terms_and_conditions.htm) and, for electronic format documents, subject to Terms and Conditions for Electronic Documents at [www.sgs.com/terms\\_e-document.htm](http://www.sgs.com/terms_e-document.htm). Attention is drawn to the limitation of liability, indemnification and jurisdiction issues defined therein. Any holder of this document is advised that information contained hereon reflects the Company's findings at the time of its intervention only and within the limits of Client's instructions, if any. The Company's sole responsibility is to its Client and this document does not exonerate parties to a transaction from exercising all their rights and obligations under the transaction documents. This document cannot be reproduced except in full, without prior written approval of the Company. Any unauthorized alteration, forgery or falsification of the content or appearance of this document is unlawful and offenders may be prosecuted to the fullest extent of the law.

SGS Taiwan Ltd.

No.134,WuKungRoad,NewTaipeiIndustrialPark,WukuDistrict,NewTaipeiCity,Taiwan24803/新北市五股區新北產業園區五工路 134 號

台灣檢驗科技股份有限公司

t (886-2) 2299-3279

f (886-2) 2298-0488

www.tw.sgs.com

Member of SGS Group

|                 |                |           |            |               |        |
|-----------------|----------------|-----------|------------|---------------|--------|
| Operation Mode: | Operation mode |           | Test Date: | Jun. 18, 2015 |        |
| Temperature:    | 24             | Humidity: | 66 %       | Test By:      | Marcus |
|                 |                |           | Phase:     | N             |        |

|                                   |                     |                    |
|-----------------------------------|---------------------|--------------------|
| Site: ConductionRoom              | Phase: N            | Temperature: 24 °C |
| Limit: FCC Class B Conduction(QP) | Power: AC 120V/60Hz | Humidity: 66%      |
| Mode: Operation                   |                     |                    |
| Note:                             |                     |                    |

Conducted Emission

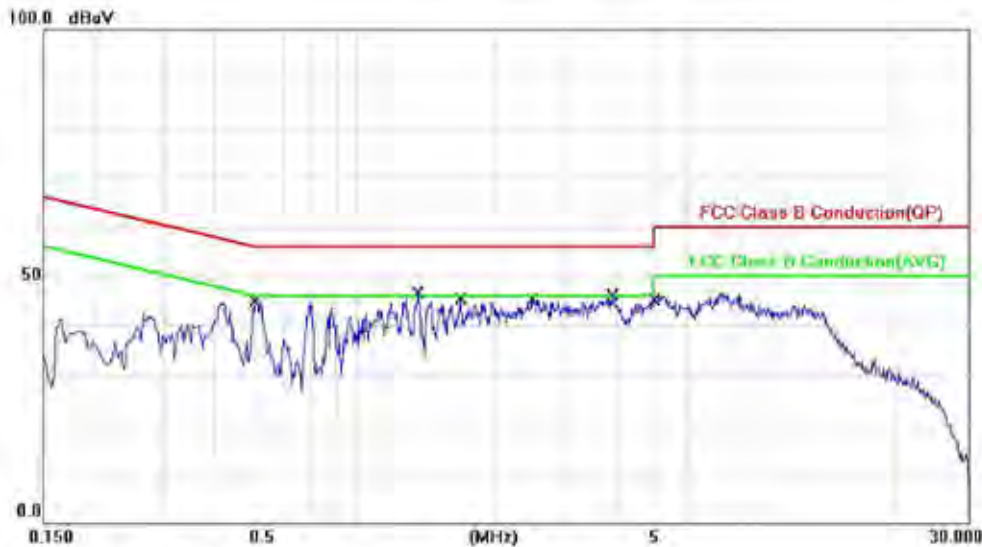

| No. | Mk. | Freq.  | Reading Level | Correct Factor | Measurement | Limit | Over   | Detector | Comment |
|-----|-----|--------|---------------|----------------|-------------|-------|--------|----------|---------|
|     |     | MHz    | dBuV          | dB             | dBuV        | dBuV  | dB     |          |         |
| 1   |     | 0.5070 | 42.30         | 0.06           | 42.36       | 56.00 | -13.64 | QP       |         |
| 2   | *   | 0.5070 | 34.20         | 0.06           | 34.26       | 46.00 | -11.74 | AVG      |         |
| 3   |     | 1.2857 | 41.90         | 0.08           | 41.98       | 56.00 | -14.02 | QP       |         |
| 4   |     | 1.2857 | 31.70         | 0.08           | 31.78       | 46.00 | -14.22 | AVG      |         |
| 5   |     | 1.6290 | 38.20         | 0.08           | 38.28       | 56.00 | -17.72 | QP       |         |
| 6   |     | 1.6290 | 27.00         | 0.08           | 27.08       | 46.00 | -18.92 | AVG      |         |
| 7   |     | 2.4645 | 39.60         | 0.11           | 39.71       | 56.00 | -16.29 | QP       |         |
| 8   |     | 2.4645 | 28.60         | 0.11           | 28.71       | 46.00 | -17.29 | AVG      |         |
| 9   |     | 3.8870 | 39.80         | 0.13           | 39.93       | 56.00 | -16.07 | QP       |         |
| 10  |     | 3.8870 | 27.90         | 0.13           | 28.03       | 46.00 | -17.97 | AVG      |         |
| 11  |     | 4.9854 | 39.40         | 0.16           | 39.56       | 56.00 | -16.44 | QP       |         |
| 12  |     | 4.9854 | 27.10         | 0.16           | 27.26       | 46.00 | -18.74 | AVG      |         |

Unless otherwise stated the results shown in this test report refer only to the sample(s) tested and such sample(s) are retained for 90 days only.

除非另有說明，此報告結果僅對測試之樣品負責，同時此樣品僅保留90天。本報告未經本公司書面許可，不可部份複製。

This document is issued by the Company subject to its General Conditions of Service printed overleaf, available on request or accessible at [www.sgs.com/terms\\_and\\_conditions.htm](http://www.sgs.com/terms_and_conditions.htm) and, for electronic format documents, subject to Terms and Conditions for Electronic Documents at [www.sgs.com/terms\\_e-document.htm](http://www.sgs.com/terms_e-document.htm). Attention is drawn to the limitation of liability, indemnification and jurisdiction issues defined therein. Any holder of this document is advised that information contained hereon reflects the Company's findings at the time of its intervention only and within the limits of Client's instructions, if any. The Company's sole responsibility is to its Client and this document does not exonerate parties to a transaction from exercising all their rights and obligations under the transaction documents. This document cannot be reproduced except in full, without prior written approval of the Company. Any unauthorized alteration, forgery or falsification of the content or appearance of this document is unlawful and offenders may be prosecuted to the fullest extent of the law.

SGS Taiwan Ltd.

No.134,WuKungRoad,NewTaipeiIndustrialPark,WukuDistrict,NewTaipeiCity,Taiwan24803/新北市五股區新北產業園區五工路 134 號

台灣檢驗科技股份有限公司

t (886-2) 2299-3279

f (886-2) 2298-0488

www.tw.sgs.com

Member of SGS Group

## 7. PEAK OUTPUT POWER MEASUREMENT

### 7.1. Standard Applicable

For frequency hopping systems operating in the 2400-2483.5 MHz band employing at least 75 hopping channels, The Limit: 1Watt. For all other frequency hopping systems in the 2400 – 2483.5MHz band: The Limit: 0.125 Watts. The power limit for 1Mbps is 1watt, and 2Mbps, 3Mbps and AFH mode are 0.125 watts.

### 7.2. Measurement Equipment Used

| Conducted Emission Test Site |               |              |               |            |            |
|------------------------------|---------------|--------------|---------------|------------|------------|
| EQUIPMENT TYPE               | MFR           | MODEL NUMBER | SERIAL NUMBER | LAST CAL.  | CAL DUE.   |
| Spectrum Analyzer            | Agilent       | E4446A       | MY51100003    | 01/29/2015 | 01/28/2016 |
| DC Block                     | Mini-Circuits | BLK-18-S+    | 1             | 01/02/2015 | 01/01/2016 |
| Attenuator                   | Mini-Circuit  | BW-S10W2+    | 002           | 01/02/2015 | 01/01/2016 |
| Splitter                     | Agilent       | 11636B       | N/A           | 01/02/2015 | 01/01/2016 |

### 7.3. Test Set-up:

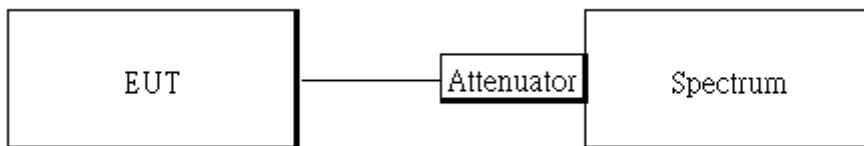

### 7.4. Measurement Procedure:

1. Place the EUT on the table and set it in transmitting mode.
2. The testing follows FCC Public Notice DA 00-705 Measurement Guidelines.
3. Remove the antenna from the EUT and then connect a low loss RF cable from the antenna port to the power meter or spectrum. (Max Hold, Detector = Peak, RBW >=20dB bandwidth)
4. Record the max. reading.
5. Repeat above procedures until all default test channel is completed.

Unless otherwise stated the results shown in this test report refer only to the sample(s) tested and such sample(s) are retained for 90 days only.

除非另有說明，此報告結果僅對測試之樣品負責，同時此樣品僅保留90天。本報告未經本公司書面許可，不可部份複製。

This document is issued by the Company subject to its General Conditions of Service printed overleaf, available on request or accessible at [www.sgs.com/terms\\_and\\_conditions.htm](http://www.sgs.com/terms_and_conditions.htm) and, for electronic format documents, subject to Terms and Conditions for Electronic Documents at [www.sgs.com/terms\\_e-document.htm](http://www.sgs.com/terms_e-document.htm). Attention is drawn to the limitation of liability, indemnification and jurisdiction issues defined therein. Any holder of this document is advised that information contained hereon reflects the Company's findings at the time of its intervention only and within the limits of Client's instructions, if any. The Company's sole responsibility is to its Client and this document does not exonerate parties to a transaction from exercising all their rights and obligations under the transaction documents. This document cannot be reproduced except in full, without prior written approval of the Company. Any unauthorized alteration, forgery or falsification of the content or appearance of this document is unlawful and offenders may be prosecuted to the fullest extent of the law.

SGS Taiwan Ltd.

No.134,WuKungRoad,NewTaipeiIndustrialPark,WukuDistrict,NewTaipeiCity,Taiwan24803/新北市五股區新北產業園區五工路 134 號

台灣檢驗科技股份有限公司

t (886-2) 2299-3279

f (886-2) 2298-0488

www.tw.sgs.com

Member of SGS Group

7.5. Measurement Result

| GFSK (1 Mbps)           |                 |                    |                   |            |
|-------------------------|-----------------|--------------------|-------------------|------------|
| Channel                 | Frequency (MHz) | Output Power (dBm) | Output Power (mW) | Limit (mW) |
| 0                       | 2402.00         | 1.57               | 1.43549           | 1000       |
| 39                      | 2441.00         | 2.15               | 1.64059           | 1000       |
| 78                      | 2480.00         | 2.69               | 1.85780           | 1000       |
| $\pi/4$ -DQPSK (2 Mbps) |                 |                    |                   |            |
| Channel                 | Frequency (MHz) | Output Power (dBm) | Output Power (mW) | Limit (mW) |
| 0                       | 2402.00         | 4.34               | 2.71644           | 125        |
| 39                      | 2441.00         | 4.81               | 3.02691           | 125        |
| 78                      | 2480.00         | 5.42               | 3.48337           | 125        |
| 8-DPSK (3 Mbps)         |                 |                    |                   |            |
| Channel                 | Frequency (MHz) | Output Power (dBm) | Output Power (mW) | Limit (mW) |
| 0                       | 2402.00         | 4.76               | 2.99226           | 125        |
| 39                      | 2441.00         | 5.31               | 3.39625           | 125        |
| 78                      | 2480.00         | <b>5.93</b>        | 3.91742           | 125        |

*NOTE: cable loss as 11dB that offsets in the spectrum.*

Unless otherwise stated the results shown in this test report refer only to the sample(s) tested and such sample(s) are retained for 90 days only.

除非另有說明，此報告結果僅對測試之樣品負責，同時此樣品僅保留90天。本報告未經本公司書面許可，不可部份複製。

This document is issued by the Company subject to its General Conditions of Service printed overleaf, available on request or accessible at [www.sgs.com/terms\\_and\\_conditions.htm](http://www.sgs.com/terms_and_conditions.htm) and, for electronic format documents, subject to Terms and Conditions for Electronic Documents at [www.sgs.com/terms\\_e-document.htm](http://www.sgs.com/terms_e-document.htm). Attention is drawn to the limitation of liability, indemnification and jurisdiction issues defined therein. Any holder of this document is advised that information contained hereon reflects the Company's findings at the time of its intervention only and within the limits of Client's instructions, if any. The Company's sole responsibility is to its Client and this document does not exonerate parties to a transaction from exercising all their rights and obligations under the transaction documents. This document cannot be reproduced except in full, without prior written approval of the Company. Any unauthorized alteration, forgery or falsification of the content or appearance of this document is unlawful and offenders may be prosecuted to the fullest extent of the law.

SGS Taiwan Ltd.

No.134,WuKungRoad,NewTaipeiIndustrialPark,WukuDistrict,NewTaipeiCity,Taiwan24803/新北市五股區新北產業園區五工路 134 號

台灣檢驗科技股份有限公司

t (886-2) 2299-3279

f (886-2) 2298-0488

www.tw.sgs.com

Member of SGS Group

## 8. 20dB BANDWIDTH MEASUREMENT

### 8.1. Standard Applicable

For frequency hopping systems operating in the 2400MHz-2483.5 MHz no limit for 20dB bandwidth.

### 8.2. Measurement Equipment Used

| Conducted Emission Test Site |               |              |               |            |            |
|------------------------------|---------------|--------------|---------------|------------|------------|
| EQUIPMENT TYPE               | MFR           | MODEL NUMBER | SERIAL NUMBER | LAST CAL.  | CAL DUE.   |
| Spectrum Analyzer            | Agilent       | E4446A       | MY51100003    | 01/29/2015 | 01/28/2016 |
| DC Block                     | Mini-Circuits | BLK-18-S+    | 1             | 01/02/2015 | 01/01/2016 |
| Attenuator                   | Mini-Circuit  | BW-S10W2+    | 002           | 01/02/2015 | 01/01/2016 |
| Splitter                     | Agilent       | 11636B       | N/A           | 01/02/2015 | 01/01/2016 |

### 8.3. Test Set-up

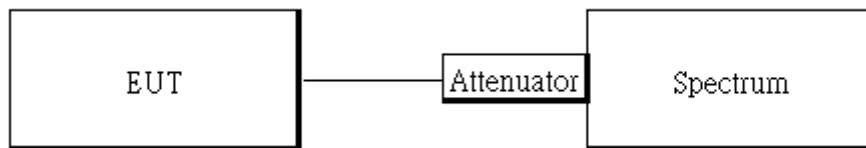

### 8.4. Measurement Procedure

1. Place the EUT on the table and set it in transmitting mode.
2. The testing follows FCC Public Notice DA 00-705 Measurement Guidelines.
3. Remove the antenna from the EUT and then connect a low loss RF cable from the antenna port to the spectrum analyzer.
4. Set the spectrum analyzer as RBW=10 kHz (1 % of 20 dB Bandwidth.), VBW = 30 kHz, Span= 3MHz, Sweep=auto, Detector = Peak, and Max hold for 20dB Bandwidth test.
5. Mark the peak frequency and -20dB (upper and lower) frequency
6. Repeat above procedures until all test default channel is completed

#### NOTE:

1. cable loss as 11dB that offsets in the spectrum
2. For the plot of bandwidth measurement, the marker of the 20dB BW is arrow-mark

Unless otherwise stated the results shown in this test report refer only to the sample(s) tested and such sample(s) are retained for 90 days only.

除非另有說明，此報告結果僅對測試之樣品負責，同時此樣品僅保留90天。本報告未經本公司書面許可，不可部份複製。

This document is issued by the Company subject to its General Conditions of Service printed overleaf, available on request or accessible at [www.sgs.com/terms\\_and\\_conditions.htm](http://www.sgs.com/terms_and_conditions.htm) and, for electronic format documents, subject to Terms and Conditions for Electronic Documents at [www.sgs.com/terms\\_e-document.htm](http://www.sgs.com/terms_e-document.htm). Attention is drawn to the limitation of liability, indemnification and jurisdiction issues defined therein. Any holder of this document is advised that information contained hereon reflects the Company's findings at the time of its intervention only and within the limits of Client's instructions, if any. The Company's sole responsibility is to its Client and this document does not exonerate parties to a transaction from exercising all their rights and obligations under the transaction documents. This document cannot be reproduced except in full, without prior written approval of the Company. Any unauthorized alteration, forgery or falsification of the content or appearance of this document is unlawful and offenders may be prosecuted to the fullest extent of the law.

8.5. Measurement Result

| GFSK     |                 |                       |                     |
|----------|-----------------|-----------------------|---------------------|
| Channel  | Frequency (MHz) | 20 dB Bandwidth (MHz) | 2/3 Bandwidth (MHz) |
| 0        | 2402            | 0.928                 | -                   |
| 39       | 2441            | 0.927                 | -                   |
| 78       | 2480            | 0.927                 | -                   |
| /4-DQPSK |                 |                       |                     |
| Channel  | Frequency (MHz) | 20 dB Bandwidth (MHz) | 2/3 Bandwidth (MHz) |
| 0        | 2402            | 1.341                 | 0.894               |
| 39       | 2441            | 1.347                 | 0.898               |
| 78       | 2480            | 1.347                 | 0.898               |
| 8-DPSK   |                 |                       |                     |
| Channel  | Frequency (MHz) | 20 dB Bandwidth (MHz) | 2/3 Bandwidth (MHz) |
| 0        | 2402            | 1.345                 | 0.897               |
| 39       | 2441            | 1.342                 | 0.895               |
| 78       | 2480            | 1.342                 | 0.895               |

Unless otherwise stated the results shown in this test report refer only to the sample(s) tested and such sample(s) are retained for 90 days only.

除非另有說明，此報告結果僅對測試之樣品負責，同時此樣品僅保留90天。本報告未經本公司書面許可，不可部份複製。

This document is issued by the Company subject to its General Conditions of Service printed overleaf, available on request or accessible at [www.sgs.com/terms\\_and\\_conditions.htm](http://www.sgs.com/terms_and_conditions.htm) and, for electronic format documents, subject to Terms and Conditions for Electronic Documents at [www.sgs.com/terms\\_e-document.htm](http://www.sgs.com/terms_e-document.htm). Attention is drawn to the limitation of liability, indemnification and jurisdiction issues defined therein. Any holder of this document is advised that information contained hereon reflects the Company's findings at the time of its intervention only and within the limits of Client's instructions, if any. The Company's sole responsibility is to its Client and this document does not exonerate parties to a transaction from exercising all their rights and obligations under the transaction documents. This document cannot be reproduced except in full, without prior written approval of the Company. Any unauthorized alteration, forgery or falsification of the content or appearance of this document is unlawful and offenders may be prosecuted to the fullest extent of the law.

SGS Taiwan Ltd.

No.134,WuKungRoad,NewTaipeiIndustrialPark,WukuDistrict,NewTaipeiCity,Taiwan24803/新北市五股區新北產業園區五工路 134 號

台灣檢驗科技股份有限公司

t (886-2) 2299-3279

f (886-2) 2298-0488

www.tw.sgs.com

Member of SGS Group



### 20dB Band Width Test Data CH-Low (GFSK mode)

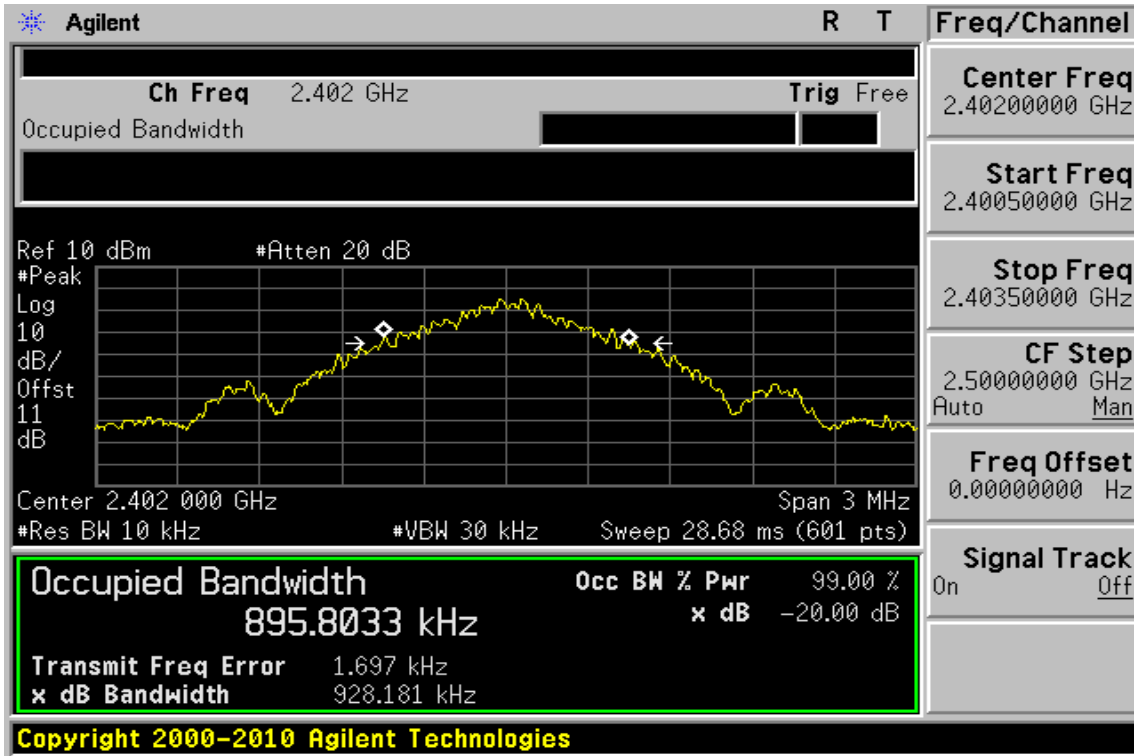

### 20dB Band Width Test Data CH-Mid (GFSK mode)

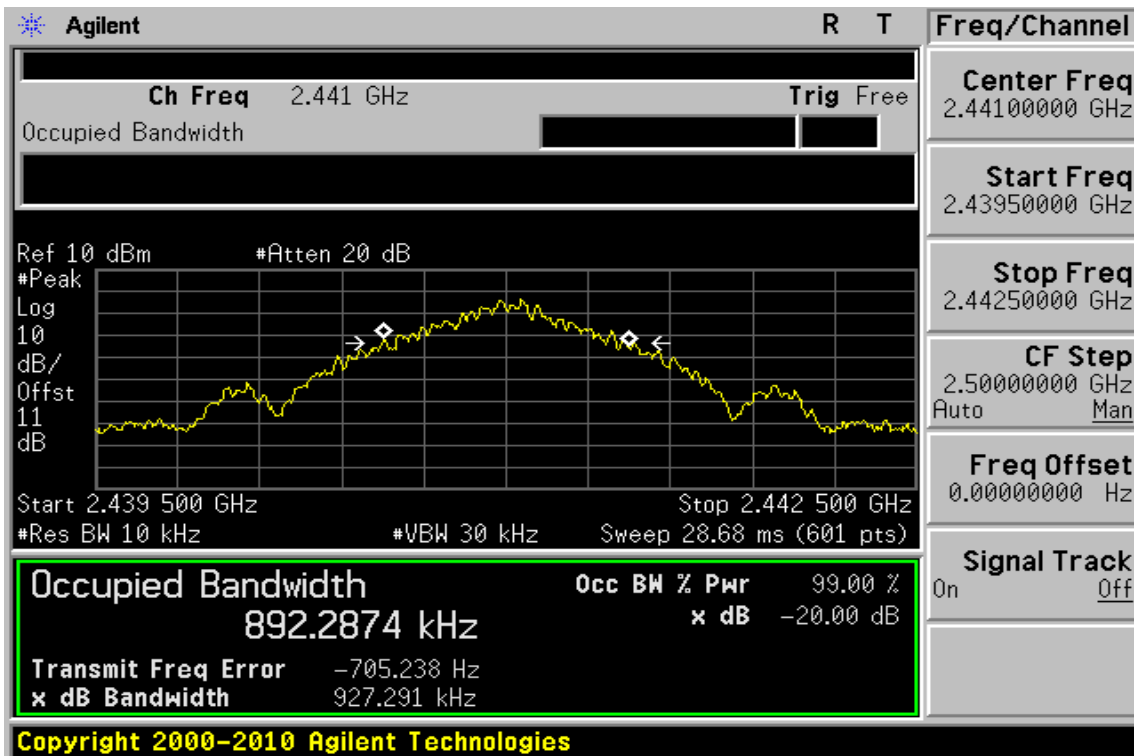

Unless otherwise stated the results shown in this test report refer only to the sample(s) tested and such sample(s) are retained for 90 days only.

除非另有說明，此報告結果僅對測試之樣品負責，同時此樣品僅保留90天。本報告未經本公司書面許可，不可部份複製。

This document is issued by the Company subject to its General Conditions of Service printed overleaf, available on request or accessible at [www.sgs.com/terms\\_and\\_conditions.htm](http://www.sgs.com/terms_and_conditions.htm) and, for electronic format documents, subject to Terms and Conditions for Electronic Documents at [www.sgs.com/terms\\_e-document.htm](http://www.sgs.com/terms_e-document.htm). Attention is drawn to the limitation of liability, indemnification and jurisdiction issues defined therein. Any holder of this document is advised that information contained hereon reflects the Company's findings at the time of its intervention only and within the limits of Client's instructions, if any. The Company's sole responsibility is to its Client and this document does not exonerate parties to a transaction from exercising all their rights and obligations under the transaction documents. This document cannot be reproduced except in full, without prior written approval of the Company. Any unauthorized alteration, forgery or falsification of the content or appearance of this document is unlawful and offenders may be prosecuted to the fullest extent of the law.

SGS Taiwan Ltd.

No.134,WuKungRoad,NewTaipeiIndustrialPark,WukuDistrict,NewTaipeiCity,Taiwan24803/新北市五股區新北產業園區五工路 134 號

台灣檢驗科技股份有限公司

t (886-2) 2299-3279

f (886-2) 2298-0488

www.tw.sgs.com

Member of SGS Group



20dB Band Width Test Data CH-High (GFSK mode)

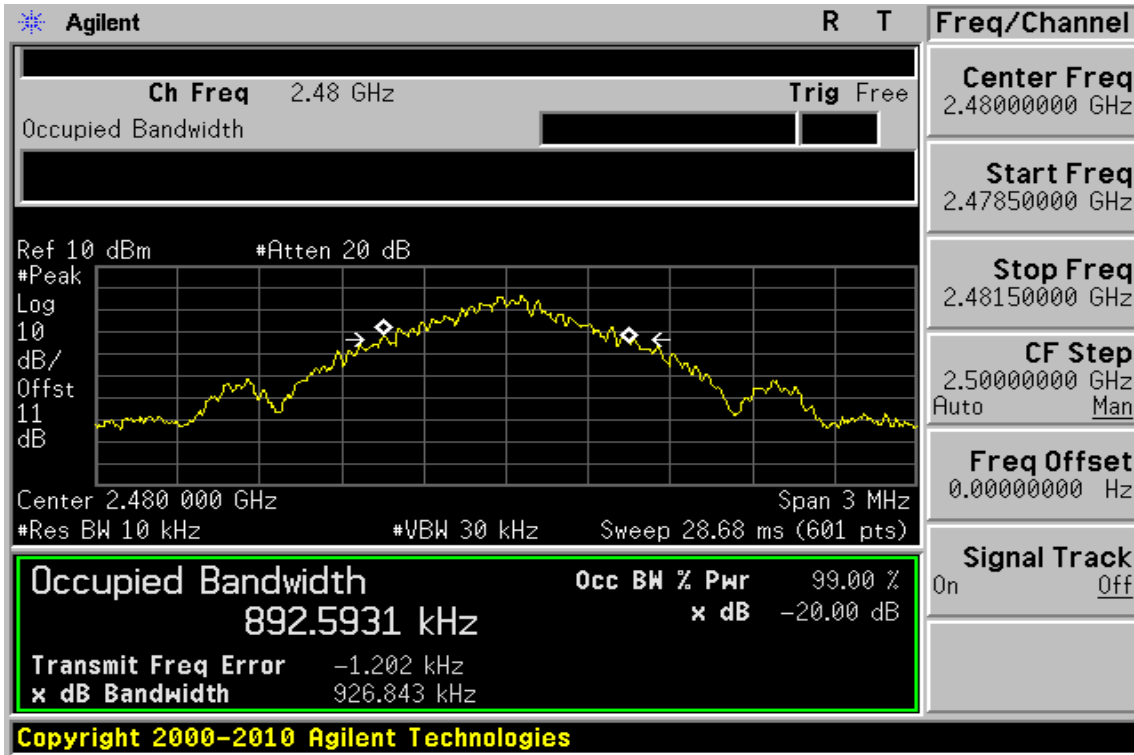

20dB Band Width Test Data CH-Low ( /4-DQPSK mode)

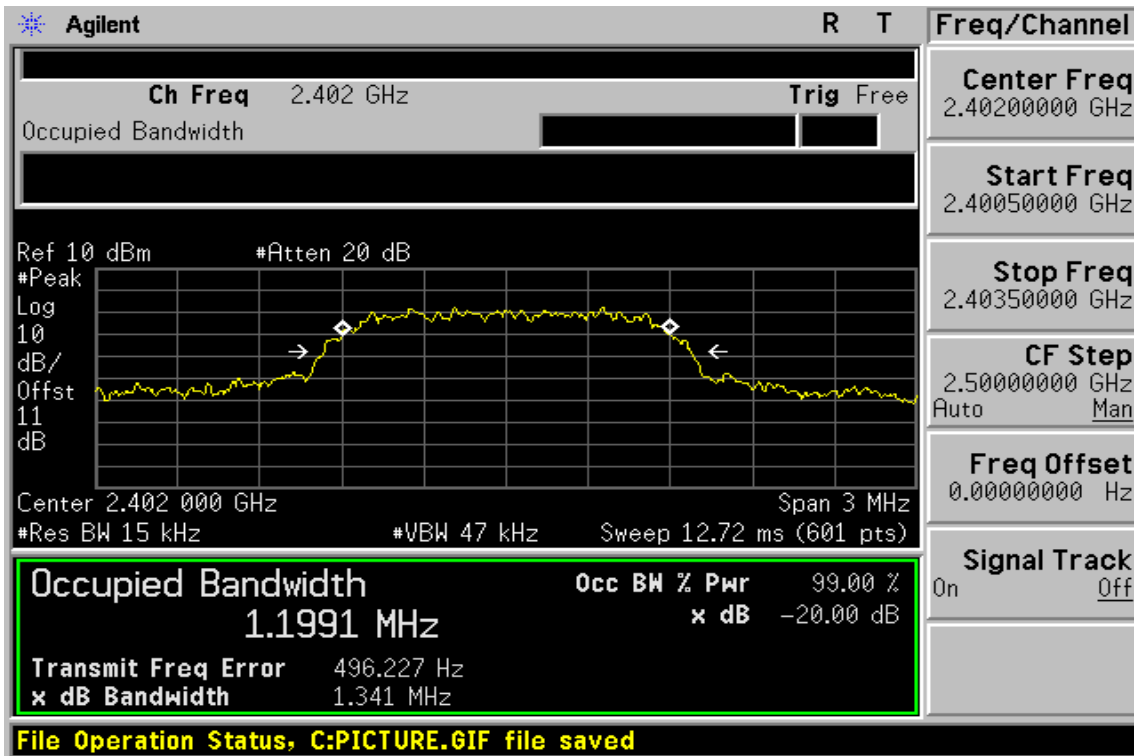

Unless otherwise stated the results shown in this test report refer only to the sample(s) tested and such sample(s) are retained for 90 days only.

除非另有說明，此報告結果僅對測試之樣品負責，同時此樣品僅保留90天。本報告未經本公司書面許可，不可部份複製。

This document is issued by the Company subject to its General Conditions of Service printed overleaf, available on request or accessible at [www.sgs.com/terms\\_and\\_conditions.htm](http://www.sgs.com/terms_and_conditions.htm) and, for electronic format documents, subject to Terms and Conditions for Electronic Documents at [www.sgs.com/terms\\_e-document.htm](http://www.sgs.com/terms_e-document.htm). Attention is drawn to the limitation of liability, indemnification and jurisdiction issues defined therein. Any holder of this document is advised that information contained hereon reflects the Company's findings at the time of its intervention only and within the limits of Client's instructions, if any. The Company's sole responsibility is to its Client and this document does not exonerate parties to a transaction from exercising all their rights and obligations under the transaction documents. This document cannot be reproduced except in full, without prior written approval of the Company. Any unauthorized alteration, forgery or falsification of the content or appearance of this document is unlawful and offenders may be prosecuted to the fullest extent of the law.

SGS Taiwan Ltd.

No.134,WuKungRoad,NewTaipeiIndustrialPark,WukuDistrict,NewTaipeiCity,Taiwan24803/新北市五股區新北產業園區五工路 134 號

台灣檢驗科技股份有限公司

t (886-2) 2299-3279

f (886-2) 2298-0488

www.tw.sgs.com

Member of SGS Group

20dB Band Width Test Data CH-Mid ( /4-DQPSK mode)

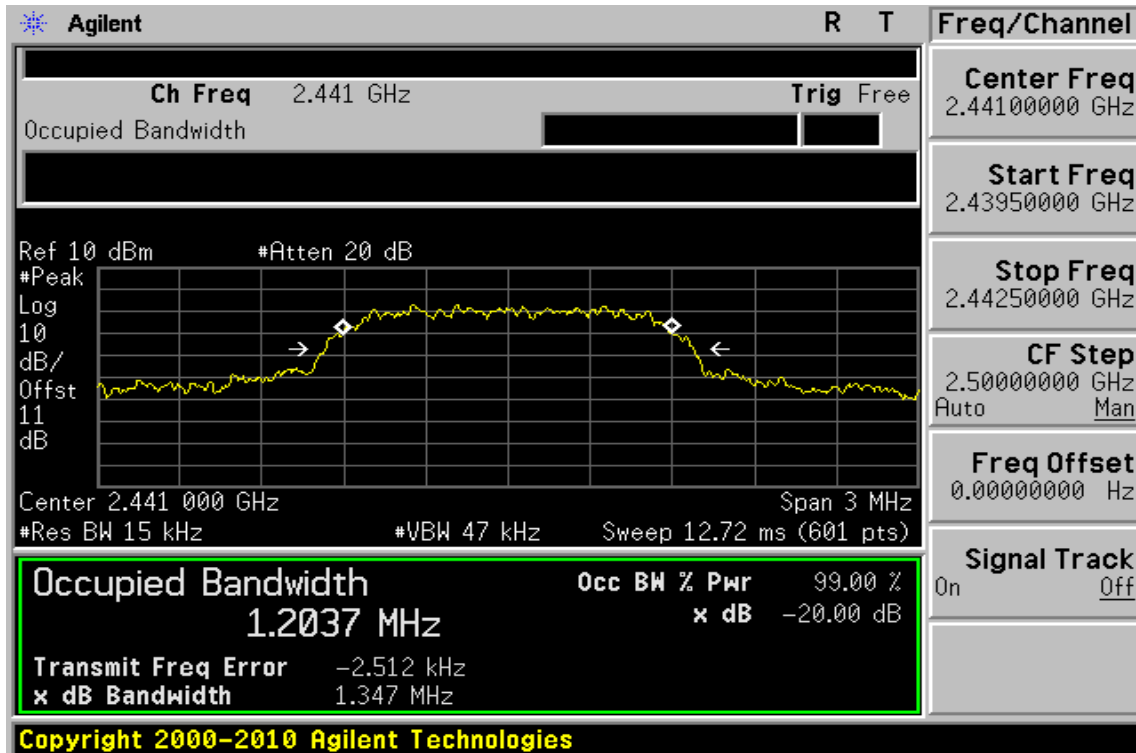

20dB Band Width Test Data CH-High ( /4-DQPSK mode)

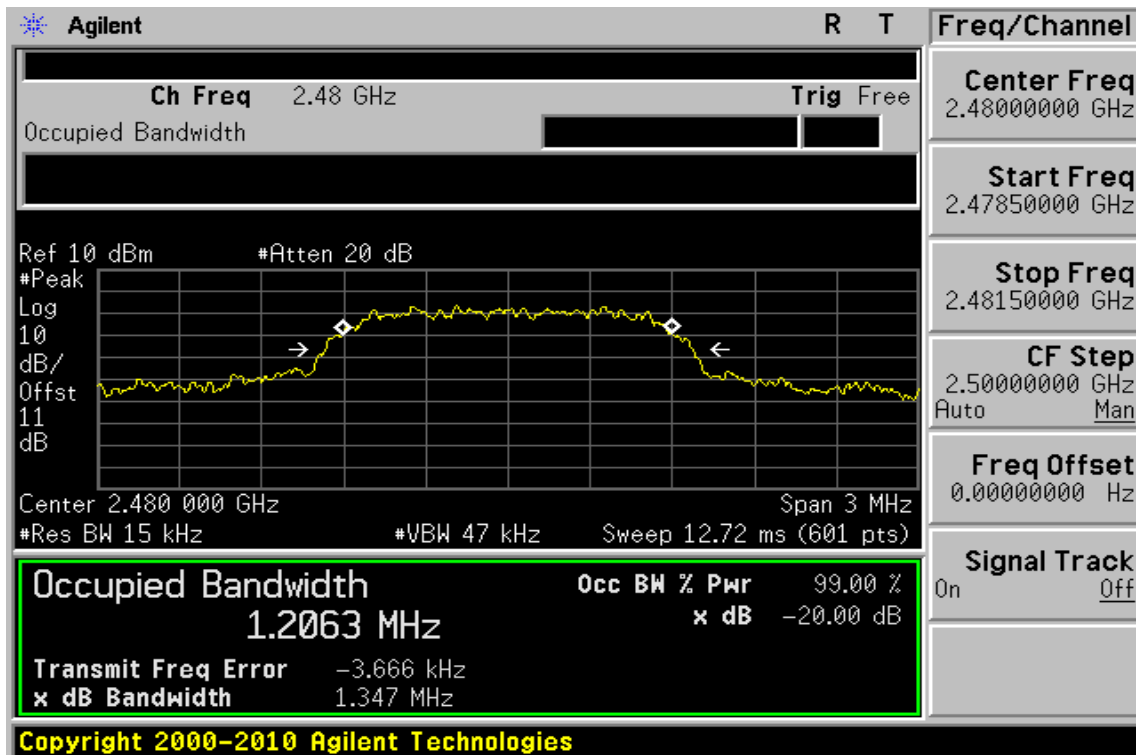

Unless otherwise stated the results shown in this test report refer only to the sample(s) tested and such sample(s) are retained for 90 days only.

除非另有說明，此報告結果僅對測試之樣品負責，同時此樣品僅保留90天。本報告未經本公司書面許可，不可部份複製。

This document is issued by the Company subject to its General Conditions of Service printed overleaf, available on request or accessible at [www.sgs.com/terms\\_and\\_conditions.htm](http://www.sgs.com/terms_and_conditions.htm) and, for electronic format documents, subject to Terms and Conditions for Electronic Documents at [www.sgs.com/terms\\_e-document.htm](http://www.sgs.com/terms_e-document.htm). Attention is drawn to the limitation of liability, indemnification and jurisdiction issues defined therein. Any holder of this document is advised that information contained hereon reflects the Company's findings at the time of its intervention only and within the limits of Client's instructions, if any. The Company's sole responsibility is to its Client and this document does not exonerate parties to a transaction from exercising all their rights and obligations under the transaction documents. This document cannot be reproduced except in full, without prior written approval of the Company. Any unauthorized alteration, forgery or falsification of the content or appearance of this document is unlawful and offenders may be prosecuted to the fullest extent of the law.

### 20dB Band Width Test Data CH-Low (8-DPSK mode)

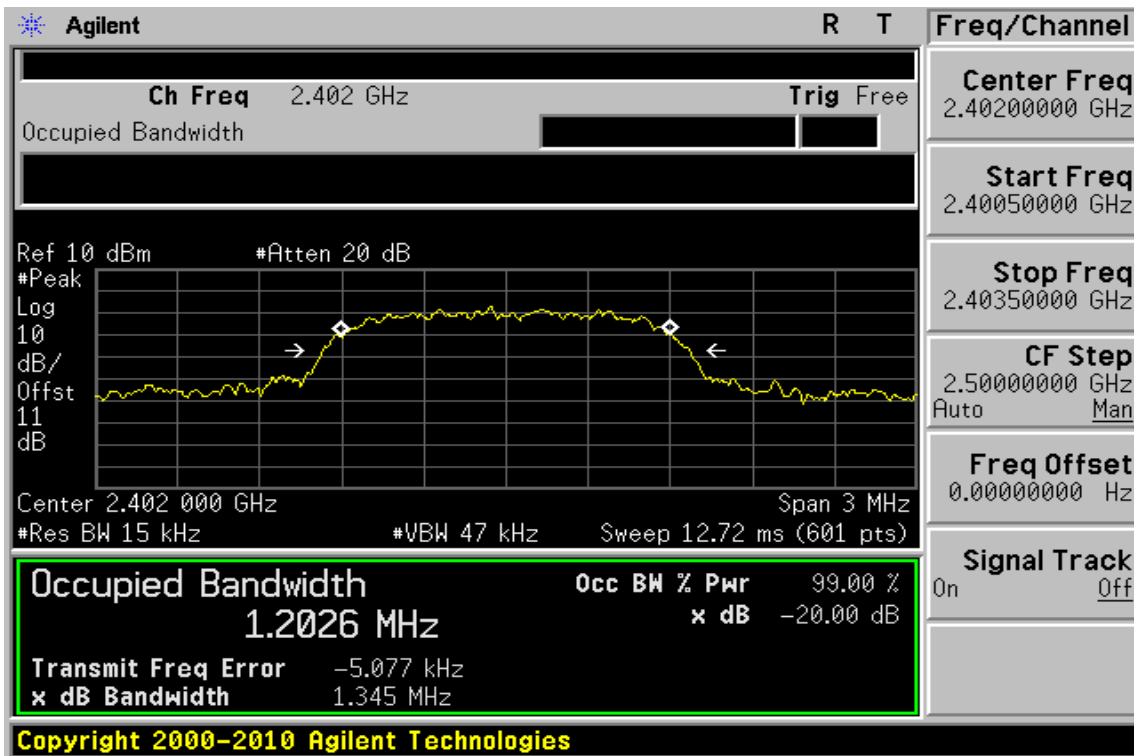

### 20dB Band Width Test Data CH-Mid (8-DPSK mode)

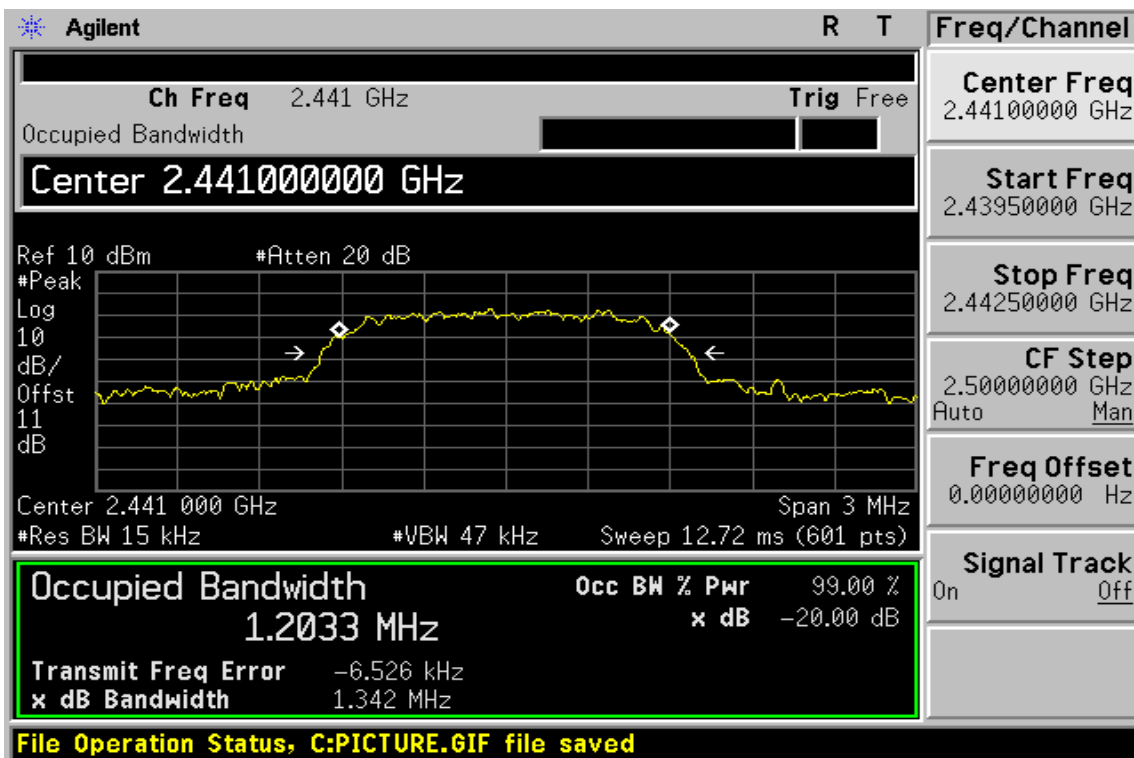

Unless otherwise stated the results shown in this test report refer only to the sample(s) tested and such sample(s) are retained for 90 days only.

除非另有說明，此報告結果僅對測試之樣品負責，同時此樣品僅保留90天。本報告未經本公司書面許可，不可部份複製。

This document is issued by the Company subject to its General Conditions of Service printed overleaf, available on request or accessible at [www.sgs.com/terms\\_and\\_conditions.htm](http://www.sgs.com/terms_and_conditions.htm) and, for electronic format documents, subject to Terms and Conditions for Electronic Documents at [www.sgs.com/terms\\_e-document.htm](http://www.sgs.com/terms_e-document.htm). Attention is drawn to the limitation of liability, indemnification and jurisdiction issues defined therein. Any holder of this document is advised that information contained hereon reflects the Company's findings at the time of its intervention only and within the limits of Client's instructions, if any. The Company's sole responsibility is to its Client and this document does not exonerate parties to a transaction from exercising all their rights and obligations under the transaction documents. This document cannot be reproduced except in full, without prior written approval of the Company. Any unauthorized alteration, forgery or falsification of the content or appearance of this document is unlawful and offenders may be prosecuted to the fullest extent of the law.

SGS Taiwan Ltd.

No.134,WuKungRoad,NewTaipeiIndustrialPark,WukuDistrict,NewTaipeiCity,Taiwan24803/新北市五股區新北產業園區五工路 134 號

台灣檢驗科技股份有限公司

t (886-2) 2299-3279

f (886-2) 2298-0488

www.tw.sgs.com

Member of SGS Group

### 20dB Width Test Data CH-High (8-DPSK mode)

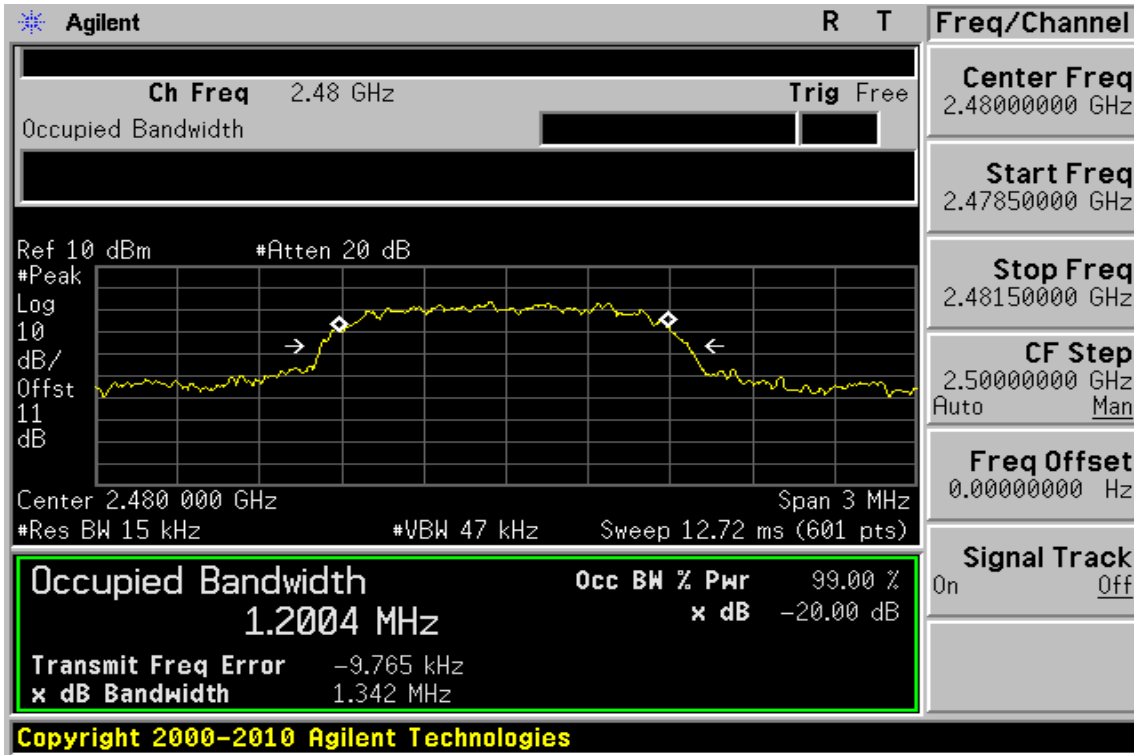

Unless otherwise stated the results shown in this test report refer only to the sample(s) tested and such sample(s) are retained for 90 days only.

除非另有說明，此報告結果僅對測試之樣品負責，同時此樣品僅保留90天。本報告未經本公司書面許可，不可部份複製。

This document is issued by the Company subject to its General Conditions of Service printed overleaf, available on request or accessible at [www.sgs.com/terms\\_and\\_conditions.htm](http://www.sgs.com/terms_and_conditions.htm) and, for electronic format documents, subject to Terms and Conditions for Electronic Documents at [www.sgs.com/terms\\_e-document.htm](http://www.sgs.com/terms_e-document.htm). Attention is drawn to the limitation of liability, indemnification and jurisdiction issues defined therein. Any holder of this document is advised that information contained hereon reflects the Company's findings at the time of its intervention only and within the limits of Client's instructions, if any. The Company's sole responsibility is to its Client and this document does not exonerate parties to a transaction from exercising all their rights and obligations under the transaction documents. This document cannot be reproduced except in full, without prior written approval of the Company. Any unauthorized alteration, forgery or falsification of the content or appearance of this document is unlawful and offenders may be prosecuted to the fullest extent of the law.

SGS Taiwan Ltd.

No.134,WuKungRoad,NewTaipeiIndustrialPark,WukuDistrict,NewTaipeiCity,Taiwan24803/新北市五股區新北產業園區五工路 134 號

台灣檢驗科技股份有限公司

t (886-2) 2299-3279

f (886-2) 2298-0488

www.tw.sgs.com

Member of SGS Group

## 9. CONDUCTED BAND EDGES AND SPURIOUS EMISSION MEASUREMENT

### 9.1. Standard Applicable

In any 100 kHz bandwidth outside the frequency band in which the spread spectrum or digitally modulated intentional radiator is operating, the radio frequency power that is produced by the intentional radiator shall be at least 20 dB below that in the 100 kHz bandwidth within the band that contains the highest level of the desired power, based on either an RF conducted or a radiated measurement, provided the transmitter demonstrates compliance with the peak conducted power limits. In addition, radiated emissions which fall in the restricted bands, as defined in §15.205(a), must also comply with the radiated emission limits specified in §15.209(a).

### 9.2. Measurement Equipment Used

| Conducted Emission Test Site |               |              |               |            |            |
|------------------------------|---------------|--------------|---------------|------------|------------|
| EQUIPMENT TYPE               | MFR           | MODEL NUMBER | SERIAL NUMBER | LAST CAL.  | CAL DUE.   |
| Spectrum Analyzer            | Agilent       | E4446A       | MY51100003    | 01/29/2015 | 01/28/2016 |
| DC Block                     | Mini-Circuits | BLK-18-S+    | 1             | 01/02/2015 | 01/01/2016 |
| Attenuator                   | Mini-Circuit  | BW-S10W2+    | 002           | 01/02/2015 | 01/01/2016 |
| Splitter                     | Agilent       | 11636B       | N/A           | 01/02/2015 | 01/01/2016 |

### 9.3. Test SET-UP

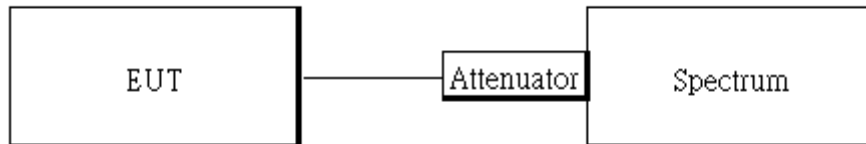

Unless otherwise stated the results shown in this test report refer only to the sample(s) tested and such sample(s) are retained for 90 days only.

除非另有說明，此報告結果僅對測試之樣品負責，同時此樣品僅保留90天。本報告未經本公司書面許可，不可部份複製。

This document is issued by the Company subject to its General Conditions of Service printed overleaf, available on request or accessible at [www.sgs.com/terms\\_and\\_conditions.htm](http://www.sgs.com/terms_and_conditions.htm) and, for electronic format documents, subject to Terms and Conditions for Electronic Documents at [www.sgs.com/terms\\_e-document.htm](http://www.sgs.com/terms_e-document.htm). Attention is drawn to the limitation of liability, indemnification and jurisdiction issues defined therein. Any holder of this document is advised that information contained hereon reflects the Company's findings at the time of its intervention only and within the limits of Client's instructions, if any. The Company's sole responsibility is to its Client and this document does not exonerate parties to a transaction from exercising all their rights and obligations under the transaction documents. This document cannot be reproduced except in full, without prior written approval of the Company. Any unauthorized alteration, forgery or falsification of the content or appearance of this document is unlawful and offenders may be prosecuted to the fullest extent of the law.

SGS Taiwan Ltd.

No.134,WuKungRoad,NewTaipeiIndustrialPark,WukuDistrict,NewTaipeiCity,Taiwan24803/新北市五股區新北產業園區五工路 134 號

台灣檢驗科技股份有限公司

t (886-2) 2299-3279

f (886-2) 2298-0488

www.tw.sgs.com

Member of SGS Group

### 9.4. Measurement Procedure

#### Conducted Band Edge:

1. Place the EUT on the table and set it in transmitting mode.
2. The testing follows FCC Public Notice DA 00-705 Measurement Guidelines.
3. Remove the antenna from the EUT and then connect a low loss RF cable from the antenna port to the spectrum analyzer.
4. Set center frequency of spectrum analyzer = operating frequency.
5. Set the spectrum analyzer as RBW, VBW=300 kHz, Sweep = auto
6. Mark Peak, 2.390GHz and 2.4835GHz and record the max. level.
7. Repeat above procedures until all frequency measured were complete.

#### Conducted Spurious Emission:

1. To connect Antenna Port of EUT to Spectrum.
2. The testing follows FCC Public Notice DA 00-705 Measurement Guidelines.
3. Set RBW = 100K & VBW = 300K, Detector =Peak, Sweep = Auto
4. Allow trace to fully stabilize.
5. Use the peak marker function to determine the maximum power level in any 100 kHz band segment within the fundamental EBW.
6. Repeat above procedures until all default test channel measured were complete.

The field strength is calculated by adding the Antenna Factor and Cable Factor and subtracting the Amplifier Gain and Duty Cycle Correction Factor (if any) from the measured reading. The basic equation with a sample calculation is as follows:

$$FS = RA + AF + CL - AG$$

|       |                        |  |
|-------|------------------------|--|
| Where | FS = Field Strength    | CL = Cable Attenuation Factor (Cable Loss) |
|       | RA = Reading Amplitude | AG = Amplifier Gain                        |
|       | AF = Antenna Factor    |  |

### 9.5. Measurement Result

Note: Refer to next page spectrum analyzer data chart and tabular data sheets.

#### NOTE:

1. Cable loss as 11dB that offsets in the spectrum
2. The occurrence of the spike on the conducted emission is the signal of the fundamental emission.

Unless otherwise stated the results shown in this test report refer only to the sample(s) tested and such sample(s) are retained for 90 days only.

除非另有說明，此報告結果僅對測試之樣品負責，同時此樣品僅保留90天。本報告未經本公司書面許可，不可部份複製。

This document is issued by the Company subject to its General Conditions of Service printed overleaf, available on request or accessible at [www.sgs.com/terms\\_and\\_conditions.htm](http://www.sgs.com/terms_and_conditions.htm) and, for electronic format documents, subject to Terms and Conditions for Electronic Documents at [www.sgs.com/terms\\_e-document.htm](http://www.sgs.com/terms_e-document.htm). Attention is drawn to the limitation of liability, indemnification and jurisdiction issues defined therein. Any holder of this document is advised that information contained hereon reflects the Company's findings at the time of its intervention only and within the limits of Client's instructions, if any. The Company's sole responsibility is to its Client and this document does not exonerate parties to a transaction from exercising all their rights and obligations under the transaction documents. This document cannot be reproduced except in full, without prior written approval of the Company. Any unauthorized alteration, forgery or falsification of the content or appearance of this document is unlawful and offenders may be prosecuted to the fullest extent of the law.

**Band Edges Test Data CH-Low (Hopping mode)**

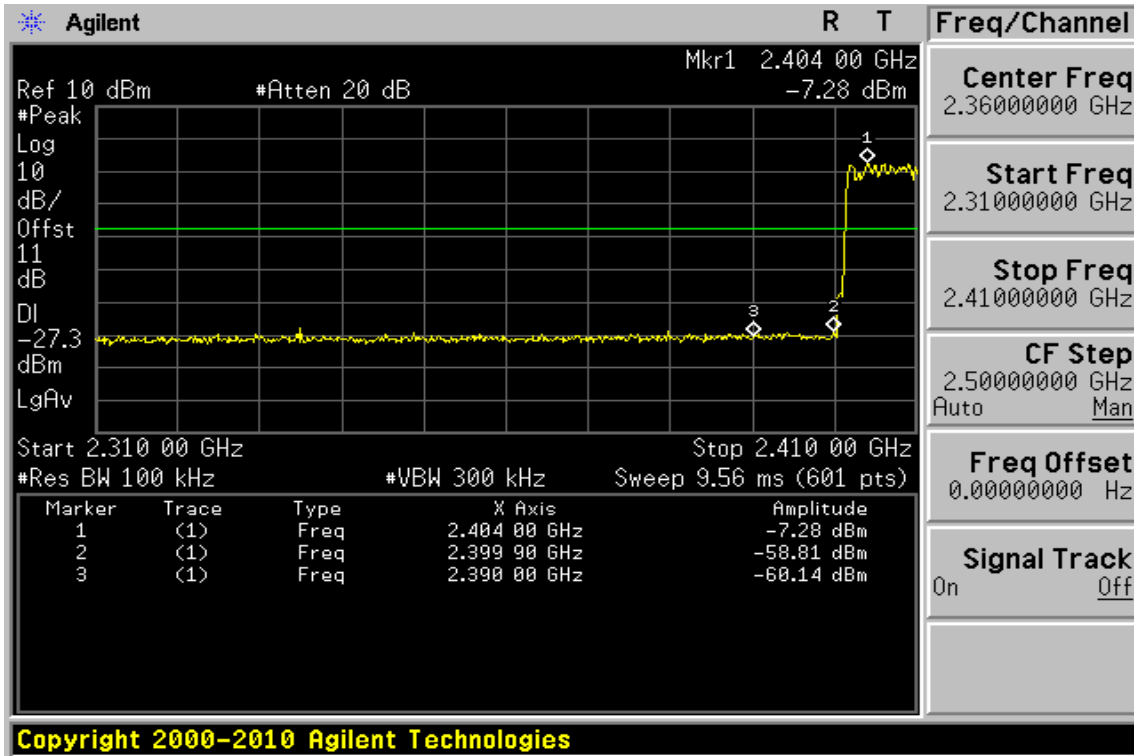

**Band Edges Test Data CH-High**

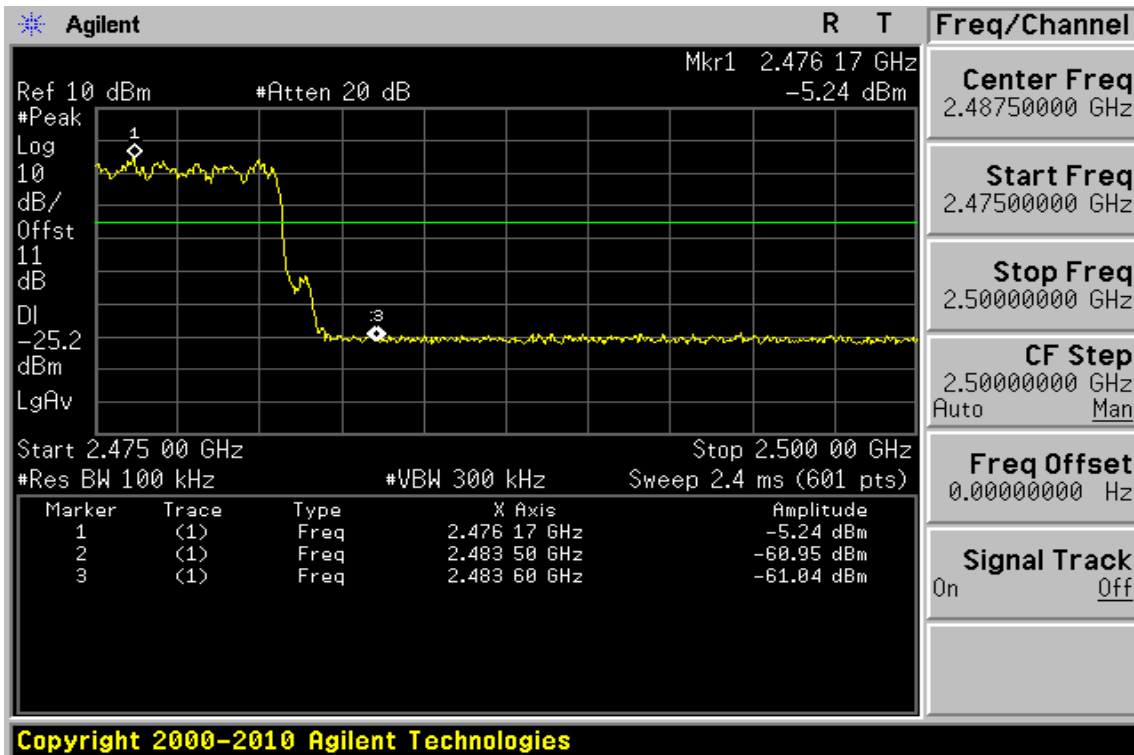

Unless otherwise stated the results shown in this test report refer only to the sample(s) tested and such sample(s) are retained for 90 days only.

除非另有說明，此報告結果僅對測試之樣品負責，同時此樣品僅保留90天。本報告未經本公司書面許可，不可部份複製。

This document is issued by the Company subject to its General Conditions of Service printed overleaf, available on request or accessible at [www.sgs.com/terms\\_and\\_conditions.htm](http://www.sgs.com/terms_and_conditions.htm) and, for electronic format documents, subject to Terms and Conditions for Electronic Documents at [www.sgs.com/terms\\_e-document.htm](http://www.sgs.com/terms_e-document.htm). Attention is drawn to the limitation of liability, indemnification and jurisdiction issues defined therein. Any holder of this document is advised that information contained hereon reflects the Company's findings at the time of its intervention only and within the limits of Client's instructions, if any. The Company's sole responsibility is to its Client and this document does not exonerate parties to a transaction from exercising all their rights and obligations under the transaction documents. This document cannot be reproduced except in full, without prior written approval of the Company. Any unauthorized alteration, forgery or falsification of the content or appearance of this document is unlawful and offenders may be prosecuted to the fullest extent of the law.

SGS Taiwan Ltd.

No.134,WuKungRoad,NewTaipeiIndustrialPark,WukuDistrict,NewTaipeiCity,Taiwan24803/新北市五股區新北產業園區五工路 134 號

台灣檢驗科技股份有限公司

t (886-2) 2299-3279

f (886-2) 2298-0488

www.tw.sgs.com

Member of SGS Group



**Band Edges Test Data CH-Low (Non-Hopping mode)**

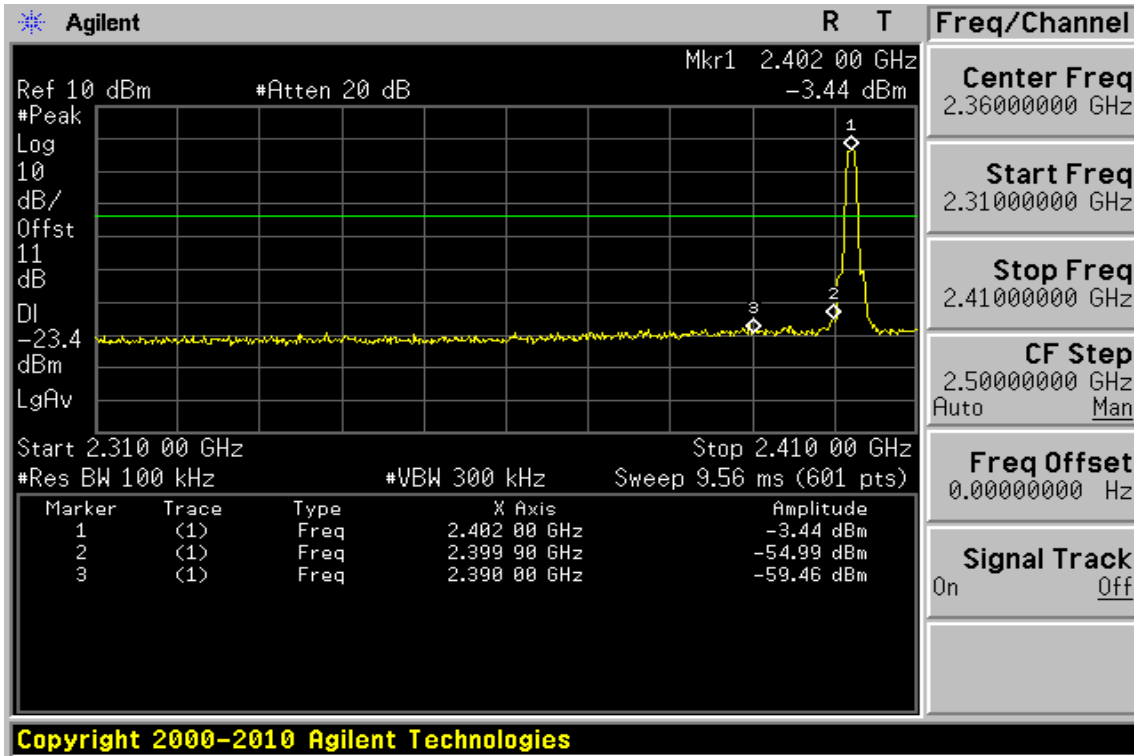

**Band Edges Test Data CH-High**

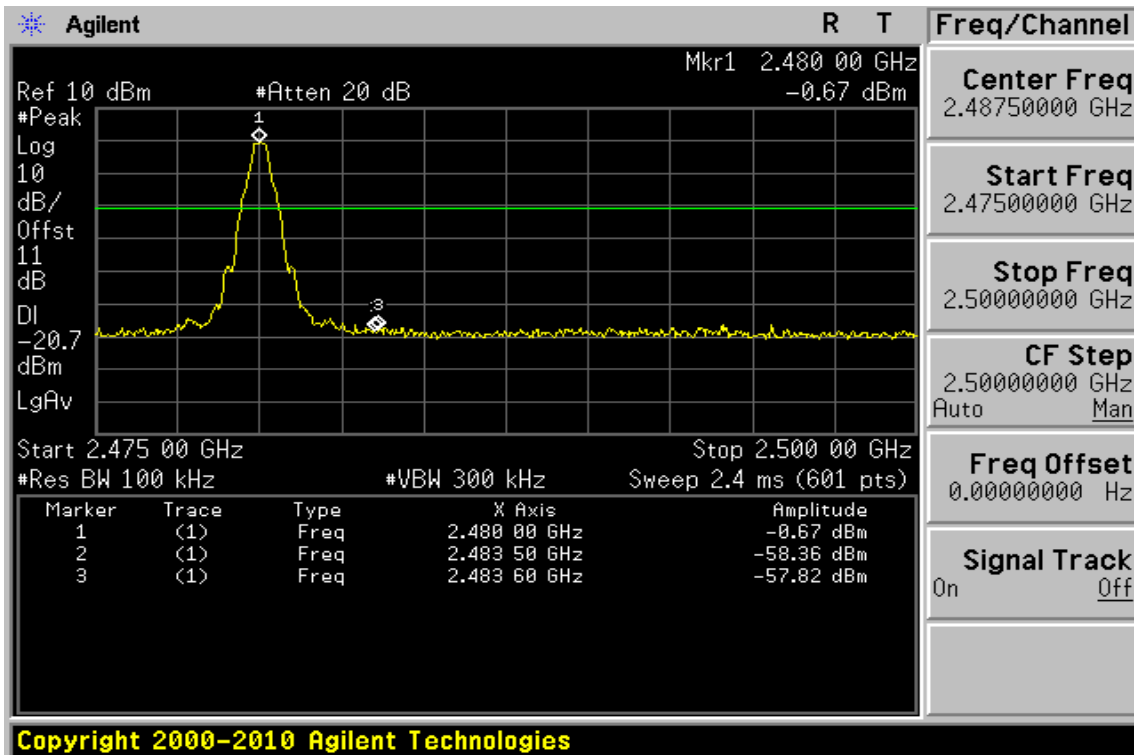

Unless otherwise stated the results shown in this test report refer only to the sample(s) tested and such sample(s) are retained for 90 days only.

除非另有說明，此報告結果僅對測試之樣品負責，同時此樣品僅保留90天。本報告未經本公司書面許可，不可部份複製。

This document is issued by the Company subject to its General Conditions of Service printed overleaf, available on request or accessible at [www.sgs.com/terms\\_and\\_conditions.htm](http://www.sgs.com/terms_and_conditions.htm) and, for electronic format documents, subject to Terms and Conditions for Electronic Documents at [www.sgs.com/terms\\_e-document.htm](http://www.sgs.com/terms_e-document.htm). Attention is drawn to the limitation of liability, indemnification and jurisdiction issues defined therein. Any holder of this document is advised that information contained hereon reflects the Company's findings at the time of its intervention only and within the limits of Client's instructions, if any. The Company's sole responsibility is to its Client and this document does not exonerate parties to a transaction from exercising all their rights and obligations under the transaction documents. This document cannot be reproduced except in full, without prior written approval of the Company. Any unauthorized alteration, forgery or falsification of the content or appearance of this document is unlawful and offenders may be prosecuted to the fullest extent of the law.

SGS Taiwan Ltd.

No.134,WuKungRoad,NewTaipeiIndustrialPark,WukuDistrict,NewTaipeiCity,Taiwan24803/新北市五股區新北產業園區五工路 134 號

台灣檢驗科技股份有限公司

t (886-2) 2299-3279

f (886-2) 2298-0488

www.tw.sgs.com

Member of SGS Group



### Conducted Spurious Emission Measurement Result Ch Low 30MHz – 3GHz

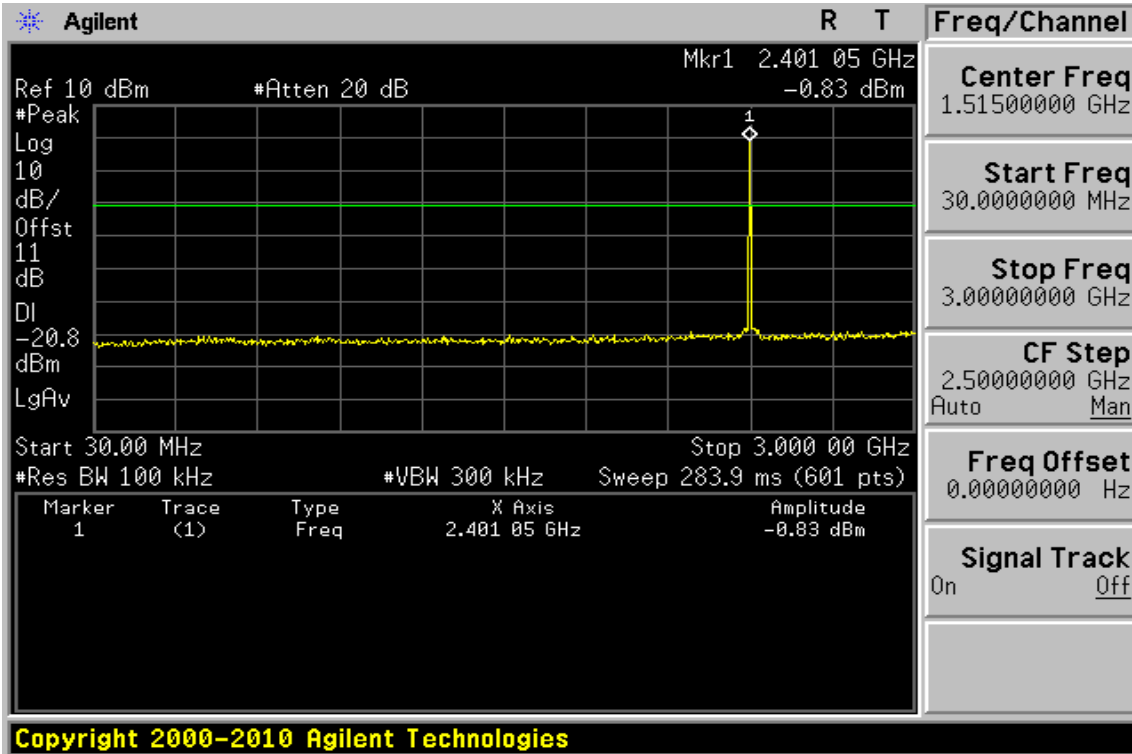

### Ch Low 3GHz – 26.5GHz

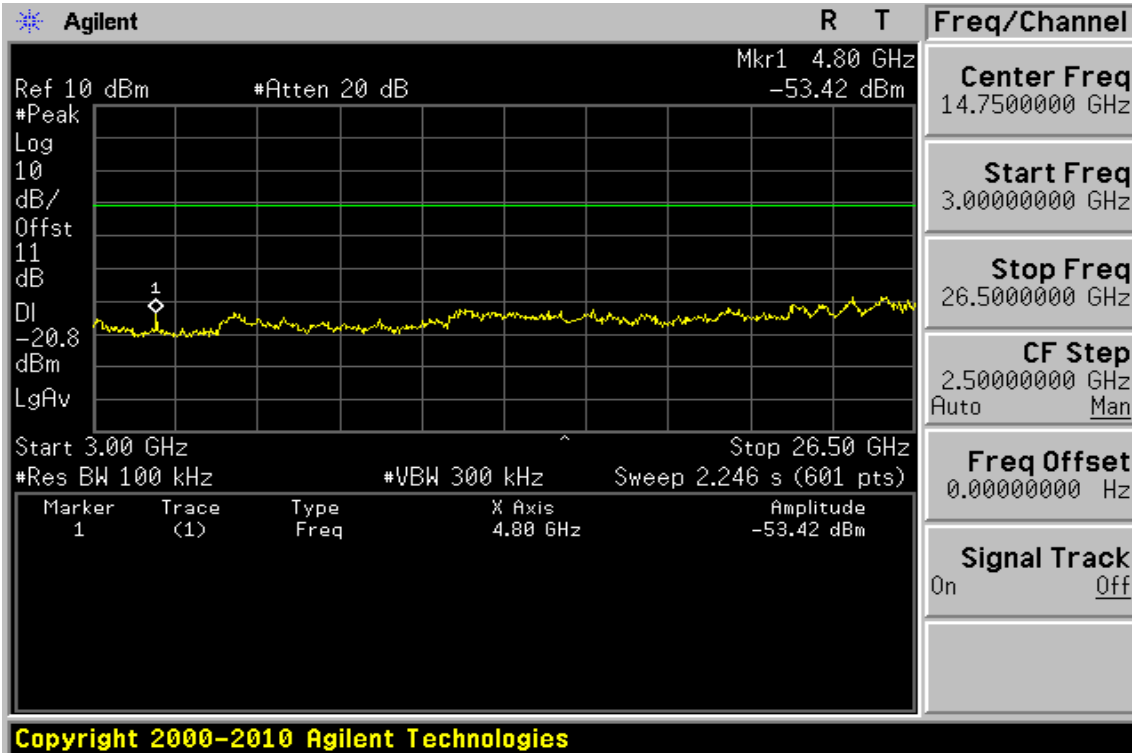

Unless otherwise stated the results shown in this test report refer only to the sample(s) tested and such sample(s) are retained for 90 days only.

除非另有說明，此報告結果僅對測試之樣品負責，同時此樣品僅保留90天。本報告未經本公司書面許可，不可部份複製。

This document is issued by the Company subject to its General Conditions of Service printed overleaf, available on request or accessible at [www.sgs.com/terms\\_and\\_conditions.htm](http://www.sgs.com/terms_and_conditions.htm) and, for electronic format documents, subject to Terms and Conditions for Electronic Documents at [www.sgs.com/terms\\_e-document.htm](http://www.sgs.com/terms_e-document.htm). Attention is drawn to the limitation of liability, indemnification and jurisdiction issues defined therein. Any holder of this document is advised that information contained hereon reflects the Company's findings at the time of its intervention only and within the limits of Client's instructions, if any. The Company's sole responsibility is to its Client and this document does not exonerate parties to a transaction from exercising all their rights and obligations under the transaction documents. This document cannot be reproduced except in full, without prior written approval of the Company. Any unauthorized alteration, forgery or falsification of the content or appearance of this document is unlawful and offenders may be prosecuted to the fullest extent of the law.

SGS Taiwan Ltd.

No.134,WuKungRoad,NewTaipeiIndustrialPark,WukuDistrict,NewTaipeiCity,Taiwan24803/新北市五股區新北產業園區五工路 134 號

台灣檢驗科技股份有限公司

t (886-2) 2299-3279

f (886-2) 2298-0488

www.tw.sgs.com

Member of SGS Group

Ch Mid 30MHz – 3GHz

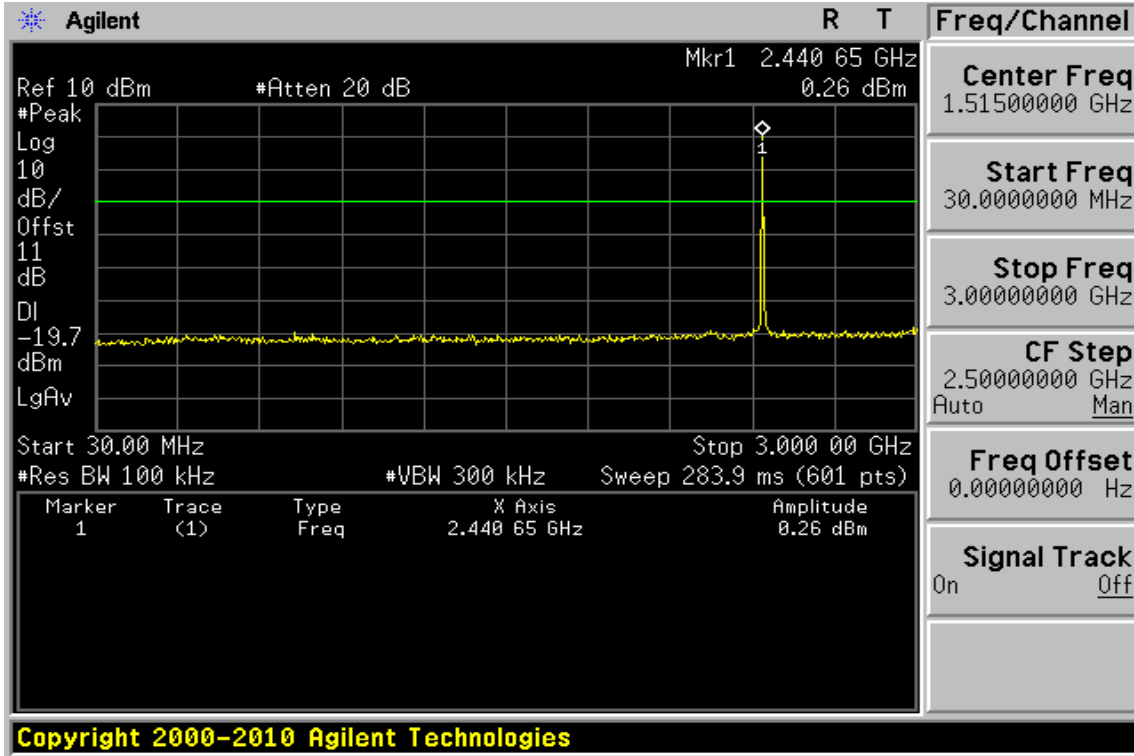

Ch Mid 3GHz – 26.5GHz

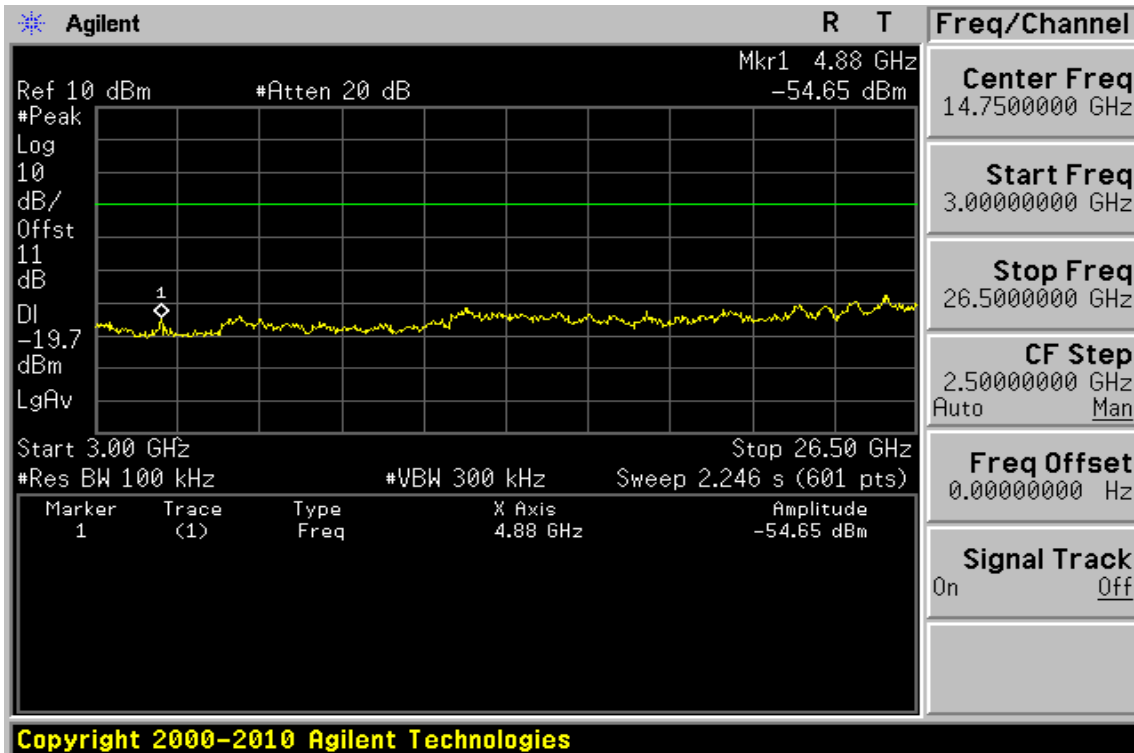

Unless otherwise stated the results shown in this test report refer only to the sample(s) tested and such sample(s) are retained for 90 days only.

除非另有說明，此報告結果僅對測試之樣品負責，同時此樣品僅保留90天。本報告未經本公司書面許可，不可部份複製。

This document is issued by the Company subject to its General Conditions of Service printed overleaf, available on request or accessible at [www.sgs.com/terms\\_and\\_conditions.htm](http://www.sgs.com/terms_and_conditions.htm) and, for electronic format documents, subject to Terms and Conditions for Electronic Documents at [www.sgs.com/terms\\_e-document.htm](http://www.sgs.com/terms_e-document.htm). Attention is drawn to the limitation of liability, indemnification and jurisdiction issues defined therein. Any holder of this document is advised that information contained hereon reflects the Company's findings at the time of its intervention only and within the limits of Client's instructions, if any. The Company's sole responsibility is to its Client and this document does not exonerate parties to a transaction from exercising all their rights and obligations under the transaction documents. This document cannot be reproduced except in full, without prior written approval of the Company. Any unauthorized alteration, forgery or falsification of the content or appearance of this document is unlawful and offenders may be prosecuted to the fullest extent of the law.

SGS Taiwan Ltd.

No.134,WuKungRoad,NewTaipeiIndustrialPark,WukuDistrict,NewTaipeiCity,Taiwan24803/新北市五股區新北產業園區五工路 134 號

台灣檢驗科技股份有限公司

t (886-2) 2299-3279

f (886-2) 2298-0488

www.tw.sgs.com

Member of SGS Group

### Ch High 30MHz – 3GHz

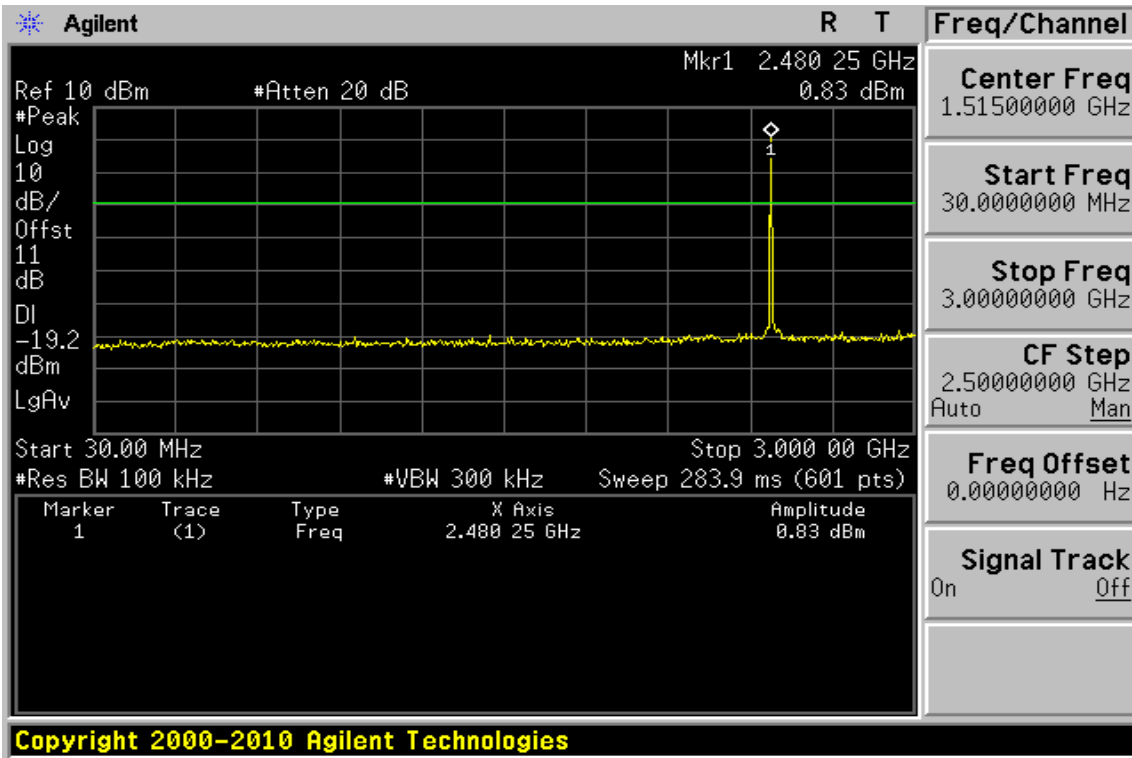

### Ch High 3GHz – 26.5GHz

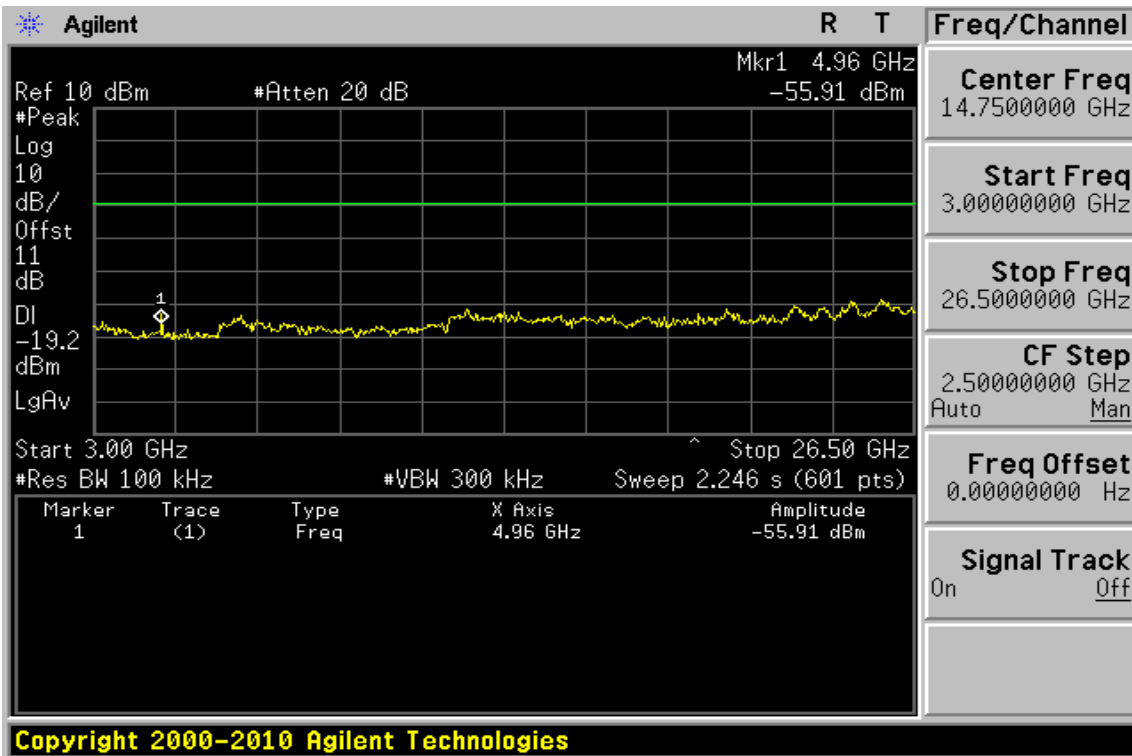

Unless otherwise stated the results shown in this test report refer only to the sample(s) tested and such sample(s) are retained for 90 days only.

除非另有說明，此報告結果僅對測試之樣品負責，同時此樣品僅保留90天。本報告未經本公司書面許可，不可部份複製。

This document is issued by the Company subject to its General Conditions of Service printed overleaf, available on request or accessible at [www.sgs.com/terms\\_and\\_conditions.htm](http://www.sgs.com/terms_and_conditions.htm) and, for electronic format documents, subject to Terms and Conditions for Electronic Documents at [www.sgs.com/terms\\_e-document.htm](http://www.sgs.com/terms_e-document.htm). Attention is drawn to the limitation of liability, indemnification and jurisdiction issues defined therein. Any holder of this document is advised that information contained hereon reflects the Company's findings at the time of its intervention only and within the limits of Client's instructions, if any. The Company's sole responsibility is to its Client and this document does not exonerate parties to a transaction from exercising all their rights and obligations under the transaction documents. This document cannot be reproduced except in full, without prior written approval of the Company. Any unauthorized alteration, forgery or falsification of the content or appearance of this document is unlawful and offenders may be prosecuted to the fullest extent of the law.

SGS Taiwan Ltd.

No.134,WuKungRoad,NewTaipeiIndustrialPark,WukuDistrict,NewTaipeiCity,Taiwan24803/新北市五股區新北產業園區五工路 134 號

台灣檢驗科技股份有限公司

t (886-2) 2299-3279

f (886-2) 2298-0488

www.tw.sgs.com

Member of SGS Group

## 10. RADIATED BANDEDGE AND SPURIOUS EMISSION MEASUREMENT

### 10.1. Standard Applicable

In any 100 kHz bandwidth outside the frequency band in which the spread spectrum or digitally modulated intentional radiator is operating, the radio frequency power that is produced by the intentional radiator shall be at least 20 dB below that in the 100 kHz bandwidth within the band that contains the highest level of the desired power, based on either an RF conducted or a radiated measurement, provided the transmitter demonstrates compliance with the peak conducted power limits. In addition, radiated emissions which fall in the restricted bands must also comply with the §15.209 limit as below.

And according to §15.33(a) (1), for an intentional radiator operates below 10GHz, the frequency range of measurements: to the tenth harmonic of the highest fundamental frequency or to 40GHz, whichever is lower.

| Frequency (MHz) | Field strength (microvolts/meter) | Distance (meters) |
|-----------------|-----------------------------------|-------------------|
| 0.009-0.490     | 2400/F(KHz)                       | 300               |
| 0.490-1.705     | 24000/F(KHz)                      | 30                |
| 1.705-30        | 30                                | 30                |
| 30-88           | 100                               | 3                 |
| 88-216          | 150                               | 3                 |
| 216-960         | 200                               | 3                 |
| Above 960       | 500                               | 3                 |

**Note:**

1. The lower limit shall apply at the transition frequencies.
2. Emission level (dBμV/m) = 20 log Emission level (dBμV/m)

Unless otherwise stated the results shown in this test report refer only to the sample(s) tested and such sample(s) are retained for 90 days only.

除非另有說明，此報告結果僅對測試之樣品負責，同時此樣品僅保留90天。本報告未經本公司書面許可，不可部份複製。

This document is issued by the Company subject to its General Conditions of Service printed overleaf, available on request or accessible at [www.sgs.com/terms\\_and\\_conditions.htm](http://www.sgs.com/terms_and_conditions.htm) and, for electronic format documents, subject to Terms and Conditions for Electronic Documents at [www.sgs.com/terms\\_e-document.htm](http://www.sgs.com/terms_e-document.htm). Attention is drawn to the limitation of liability, indemnification and jurisdiction issues defined therein. Any holder of this document is advised that information contained hereon reflects the Company's findings at the time of its intervention only and within the limits of Client's instructions, if any. The Company's sole responsibility is to its Client and this document does not exonerate parties to a transaction from exercising all their rights and obligations under the transaction documents. This document cannot be reproduced except in full, without prior written approval of the Company. Any unauthorized alteration, forgery or falsification of the content or appearance of this document is unlawful and offenders may be prosecuted to the fullest extent of the law.

SGS Taiwan Ltd.

No.134,WuKungRoad,NewTaipeiIndustrialPark,WukuDistrict,NewTaipeiCity,Taiwan24803/新北市五股區新北產業園區五工路 134 號

台灣檢驗科技股份有限公司

t (886-2) 2299-3279

f (886-2) 2298-0488

www.tw.sgs.com

Member of SGS Group

**10.2. Measurement Equipment Used**

| 966 Chamber            |                       |              |               |            |            |
|------------------------|-----------------------|--------------|---------------|------------|------------|
| EQUIPMENT TYPE         | MFR                   | MODEL NUMBER | SERIAL NUMBER | LAST CAL.  | CAL DUE.   |
| EMI Test Receiver      | R&S                   | ESC17        | 100760        | 05/04/2015 | 05/03/2016 |
| EXA Spectrum Analyzer  | Agilent               | N9010A       | MY50420195    | 12/22/2014 | 12/21/2015 |
| Loop Antenna           | ETS.LINDGREN          | 6502         | 00148045      | 07/03/2014 | 07/02/2015 |
| Bilog Antenna          | SCHWAZBECK            | VULB9168     | 378           | 12/23/2014 | 12/22/2015 |
| Horn antenna           | ETS.LINDGREN          | 3117         | 123995        | 05/05/2015 | 05/04/2016 |
| Horn Antenna           | Schwarzbeck           | BBHA9170     | 184           | 12/25/2014 | 12/24/2015 |
| Pre-Amplifier          | Agilent               | 8447D        | 2944A07676    | 01/02/2015 | 01/01/2016 |
| Pre-Amplifier          | Agilent               | 8449B        | 3008A00578    | 01/02/2015 | 01/01/2016 |
| Pre-Amplifier          | EMC Instruments Corp. | EMC184045    | 980135        | 01/02/2015 | 01/01/2016 |
| Filter 2400-2483.5 MHz | EWT                   | EWT-14-0166  | M2            | 01/02/2015 | 01/01/2016 |
| Attenuator             | Mini-Circuit          | BW-S10W2+    | 004           | 01/02/2015 | 01/01/2016 |
| Turn Table             | HD                    | DT420        | N/A           | N.C.R      | N.C.R      |
| Antenna Tower          | HD                    | MA240-N      | 240/657       | N.C.R      | N.C.R      |
| Controller             | HD                    | HD100        | N/A           | N.C.R      | N.C.R      |
| Low Loss Cable         | Huber Suhner          | 966_Rx       | 9             | 01/02/2015 | 01/01/2016 |

NOTE: N.C.R refers to Not Calibrated Required.

**10.3. Test SET-UP**

(A) Radiated Emission Test Set-UP Frequency Below 30MHz.

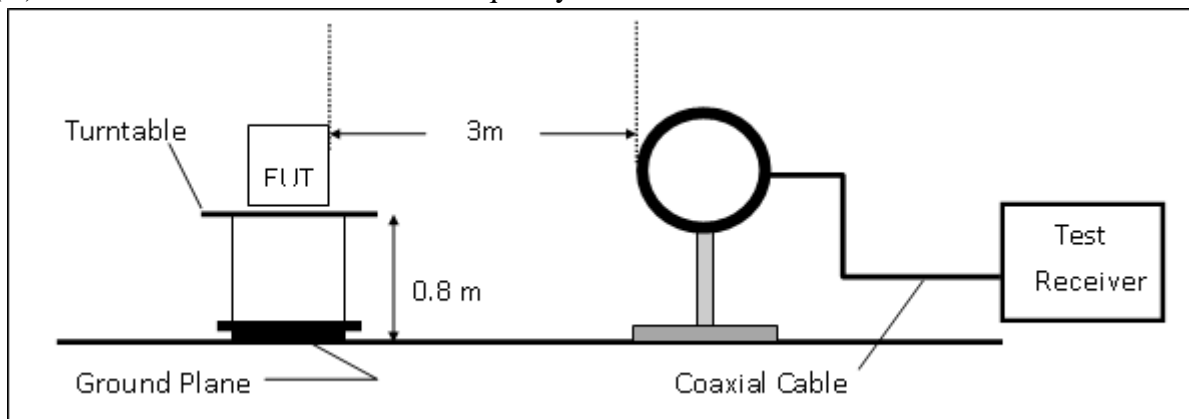

Unless otherwise stated the results shown in this test report refer only to the sample(s) tested and such sample(s) are retained for 90 days only.

除非另有說明，此報告結果僅對測試之樣品負責，同時此樣品僅保留90天。本報告未經本公司書面許可，不可部份複製。

This document is issued by the Company subject to its General Conditions of Service printed overleaf, available on request or accessible at [www.sgs.com/terms\\_and\\_conditions.htm](http://www.sgs.com/terms_and_conditions.htm) and, for electronic format documents, subject to Terms and Conditions for Electronic Documents at [www.sgs.com/terms\\_e-document.htm](http://www.sgs.com/terms_e-document.htm). Attention is drawn to the limitation of liability, indemnification and jurisdiction issues defined therein. Any holder of this document is advised that information contained hereon reflects the Company's findings at the time of its intervention only and within the limits of Client's instructions, if any. The Company's sole responsibility is to its Client and this document does not exonerate parties to a transaction from exercising all their rights and obligations under the transaction documents. This document cannot be reproduced except in full, without prior written approval of the Company. Any unauthorized alteration, forgery or falsification of the content or appearance of this document is unlawful and offenders may be prosecuted to the fullest extent of the law.

(B) Radiated Emission Test Set-Up, Frequency form 30MHz to 1000MHz

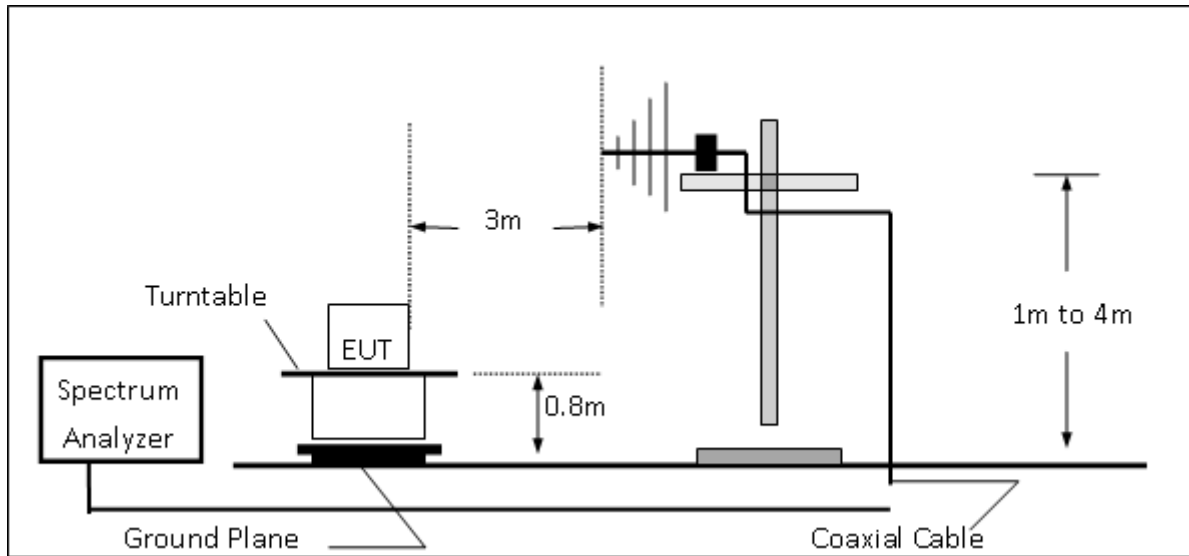

(C) Radiated Emission Test Set-UP Frequency Over 1 GHz

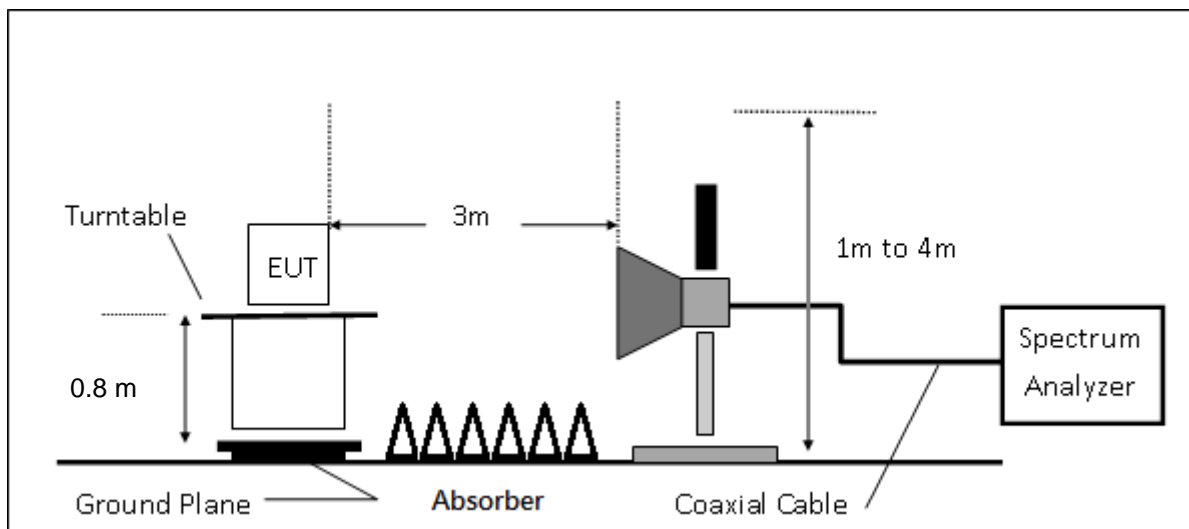

Unless otherwise stated the results shown in this test report refer only to the sample(s) tested and such sample(s) are retained for 90 days only.

除非另有說明，此報告結果僅對測試之樣品負責，同時此樣品僅保留90天。本報告未經本公司書面許可，不可部份複製。

This document is issued by the Company subject to its General Conditions of Service printed overleaf, available on request or accessible at [www.sgs.com/terms\\_and\\_conditions.htm](http://www.sgs.com/terms_and_conditions.htm) and, for electronic format documents, subject to Terms and Conditions for Electronic Documents at [www.sgs.com/terms\\_e-document.htm](http://www.sgs.com/terms_e-document.htm). Attention is drawn to the limitation of liability, indemnification and jurisdiction issues defined therein. Any holder of this document is advised that information contained hereon reflects the Company's findings at the time of its intervention only and within the limits of Client's instructions, if any. The Company's sole responsibility is to its Client and this document does not exonerate parties to a transaction from exercising all their rights and obligations under the transaction documents. This document cannot be reproduced except in full, without prior written approval of the Company. Any unauthorized alteration, forgery or falsification of the content or appearance of this document is unlawful and offenders may be prosecuted to the fullest extent of the law.

## 10.4. Measurement Procedure

### Radiated Emission

1. The testing follows FCC Public Notice DA 00-705 Measurement Guidelines.
2. The EUT was placed on a turn table with 0.8m for frequency < 1GHz and 0.8m for frequency > 1GHz above ground plane.
3. The turn table shall rotate 360 degrees to determine the position of maximum emission level.
4. EUT is set 3m away from the receiving antenna which varied from 1m to 4m to find out the highest emissions.
5. Use the follow spectrum analyzer setting:
  - (1) Span = wide enough to fully capture the emission being measured
  - (2) RBW = 1 MHz for  $f \geq 1$  GHz, 100 kHz for  $f < 1$  GHz, VBW  $\geq$  RBW, Sweep = auto, Detector function = peak, Trace = max hold
  - (3) For average measurement: use duty cycle correction factor method per 15.35(c)
 
$$\text{Duty Cycle} = \text{On time} / 100 \text{ milliseconds}$$

$$\text{On time} = N1 * L1 + N2 * L2 + \dots + N(n-1) * LN(n-1) + N(n) * L(n)$$
 Where N1 is number of type 1 pulses, L1 is length of type 1 pulses, etc.  
 Average Emission Level = Peak Emission Level + 20\*log (duty Cycle)
6. When measurement procedures for electric field radiated emissions above 1 GHz the EUT measurement is to be made “while keeping the antenna in the ‘cone of radiation’ from that area and pointed at the area both in azimuth and elevation, with polarization oriented for maximum response.” is still within the 3dB illumination BW of the measurement antenna.
7. Maximum procedure was performed on the six highest emissions to ensure EUT compliance.
8. And also, each emission was to be maximized by changing the polarization of receiving antenna both horizontal and vertical.
9. Repeat above procedures until all frequency of the interest measured were complete.

Unless otherwise stated the results shown in this test report refer only to the sample(s) tested and such sample(s) are retained for 90 days only.

除非另有說明，此報告結果僅對測試之樣品負責，同時此樣品僅保留90天。本報告未經本公司書面許可，不可部份複製。

This document is issued by the Company subject to its General Conditions of Service printed overleaf, available on request or accessible at [www.sgs.com/terms\\_and\\_conditions.htm](http://www.sgs.com/terms_and_conditions.htm) and, for electronic format documents, subject to Terms and Conditions for Electronic Documents at [www.sgs.com/terms\\_e-document.htm](http://www.sgs.com/terms_e-document.htm). Attention is drawn to the limitation of liability, indemnification and jurisdiction issues defined therein. Any holder of this document is advised that information contained hereon reflects the Company's findings at the time of its intervention only and within the limits of Client's instructions, if any. The Company's sole responsibility is to its Client and this document does not exonerate parties to a transaction from exercising all their rights and obligations under the transaction documents. This document cannot be reproduced except in full, without prior written approval of the Company. Any unauthorized alteration, forgery or falsification of the content or appearance of this document is unlawful and offenders may be prosecuted to the fullest extent of the law.

SGS Taiwan Ltd.

No.134,WuKungRoad,NewTaipeiIndustrialPark,WukuDistrict,NewTaipeiCity,Taiwan24803/新北市五股區新北產業園區五工路 134 號

台灣檢驗科技股份有限公司

t (886-2) 2299-3279

f (886-2) 2298-0488

www.tw.sgs.com

Member of SGS Group

### 10.5. Field Strength Calculation

The field strength is calculated by adding the Antenna Factor and Cable Factor and subtracting the Amplifier Gain and Duty Cycle Correction Factor (if any) from the measured reading. The basic equation with a sample calculation is as follows:

$$FS = RA + AF + CL - AG$$

|       |                        |  |
|-------|------------------------|--|
| Where | FS = Field Strength    | CL = Cable Attenuation Factor (Cable Loss) |
|       | RA = Reading Amplitude | AG = Amplifier Gain                        |
|       | AF = Antenna Factor    |  |

The limit of the emission level is expressed in dBuV/m, which converts  $20 \cdot \log(uV/m)$

Actual FS(dBμV/m) = SPA. Reading level(dBμV) + Factor(dB)

Factor(dB) = Antenna Factor(dBμV/m) + Cable Loss(dB) – Pre\_Amplifier Gain(dB)

**Note :**

“F” : denotes Fundamental Frequency. ; “H” : denotes Harmonic Frequency.

“E” : denotes Band Edge Frequency. ; “S” : denotes Spurious Frequency.

### 10.6. Test Results of Radiated Spurious Emissions form 9 KHz to 30 MHz

The low frequency, which started from 9 kHz to 30MHz, was pre-scanned and the result which was 20dB lower than the limit per 15.31(o) was not reported.

### 10.7. Measurement Result

Note: Refer to next page spectrum analyzer data chart and tabular data sheets.

Unless otherwise stated the results shown in this test report refer only to the sample(s) tested and such sample(s) are retained for 90 days only.

除非另有說明，此報告結果僅對測試之樣品負責，同時此樣品僅保留90天。本報告未經本公司書面許可，不可部份複製。

This document is issued by the Company subject to its General Conditions of Service printed overleaf, available on request or accessible at [www.sgs.com/terms\\_and\\_conditions.htm](http://www.sgs.com/terms_and_conditions.htm) and, for electronic format documents, subject to Terms and Conditions for Electronic Documents at [www.sgs.com/terms\\_e-document.htm](http://www.sgs.com/terms_e-document.htm). Attention is drawn to the limitation of liability, indemnification and jurisdiction issues defined therein. Any holder of this document is advised that information contained hereon reflects the Company's findings at the time of its intervention only and within the limits of Client's instructions, if any. The Company's sole responsibility is to its Client and this document does not exonerate parties to a transaction from exercising all their rights and obligations under the transaction documents. This document cannot be reproduced except in full, without prior written approval of the Company. Any unauthorized alteration, forgery or falsification of the content or appearance of this document is unlawful and offenders may be prosecuted to the fullest extent of the law.



**Radiated Band Edge Measurement Result: (Hopping Mode)**

|                       |                |                          |                   |
|-----------------------|----------------|--------------------------|-------------------|
| Operation Band        | :EDR+Hopping   | Test Date                | :2015-06-16       |
| Fundamental Frequency | :2402 MHz      | Temp./Humi.              | :23 deg_C / 62 RH |
| Operation Mode        | :Band Edge LOW | Engineer                 | :Curry            |
| EUT Pol.              | :E2 Plane      | Measurement Antenna Pol. | :VERTICAL         |

| Freq.   | Note    | Detector Mode | Spectrum Reading Level | Factor | Actual FS    | Limit @3m    | Margin |
|---------|---------|---------------|------------------------|--------|--------------|--------------|--------|
| MHz     | F/H/E/S | PK/QP/AV      | dB $\mu$ V             | dB     | dB $\mu$ V/m | dB $\mu$ V/m | dB     |
| 2390.00 | E       | Average       | 30.02                  | 5.16   | 35.18        | 54.00        | -18.82 |
| 2390.00 | E       | Peak          | 41.58                  | 5.16   | 46.74        | 74.00        | -27.26 |

|                       |                |                          |                   |
|-----------------------|----------------|--------------------------|-------------------|
| Operation Band        | :EDR+Hopping   | Test Date                | :2015-06-16       |
| Fundamental Frequency | :2402 MHz      | Temp./Humi.              | :23 deg_C / 62 RH |
| Operation Mode        | :Band Edge LOW | Engineer                 | :Curry            |
| EUT Pol.              | :E2 Plane      | Measurement Antenna Pol. | :HORIZONTAL       |

| Freq.   | Note    | Detector Mode | Spectrum Reading Level | Factor | Actual FS    | Limit @3m    | Margin |
|---------|---------|---------------|------------------------|--------|--------------|--------------|--------|
| MHz     | F/H/E/S | PK/QP/AV      | dB $\mu$ V             | dB     | dB $\mu$ V/m | dB $\mu$ V/m | dB     |
| 2390.00 | E       | Average       | 30.07                  | 5.16   | 35.23        | 54.00        | -18.77 |
| 2390.00 | E       | Peak          | 41.24                  | 5.16   | 46.40        | 74.00        | -27.60 |

Unless otherwise stated the results shown in this test report refer only to the sample(s) tested and such sample(s) are retained for 90 days only.

除非另有說明，此報告結果僅對測試之樣品負責，同時此樣品僅保留90天。本報告未經本公司書面許可，不可部份複製。

This document is issued by the Company subject to its General Conditions of Service printed overleaf, available on request or accessible at [www.sgs.com/terms\\_and\\_conditions.htm](http://www.sgs.com/terms_and_conditions.htm) and, for electronic format documents, subject to Terms and Conditions for Electronic Documents at [www.sgs.com/terms\\_e-document.htm](http://www.sgs.com/terms_e-document.htm). Attention is drawn to the limitation of liability, indemnification and jurisdiction issues defined therein. Any holder of this document is advised that information contained hereon reflects the Company's findings at the time of its intervention only and within the limits of Client's instructions, if any. The Company's sole responsibility is to its Client and this document does not exonerate parties to a transaction from exercising all their rights and obligations under the transaction documents. This document cannot be reproduced except in full, without prior written approval of the Company. Any unauthorized alteration, forgery or falsification of the content or appearance of this document is unlawful and offenders may be prosecuted to the fullest extent of the law.

SGS Taiwan Ltd.

No.134,WuKungRoad,NewTaipeiIndustrialPark,WukuDistrict,NewTaipeiCity,Taiwan24803/新北市五股區新北產業園區五工路 134 號

台灣檢驗科技股份有限公司

t (886-2) 2299-3279

f (886-2) 2298-0488

www.tw.sgs.com

Member of SGS Group

|                       |                 |                          |                   |
|-----------------------|-----------------|--------------------------|-------------------|
| Operation Band        | :EDR+Hopping    | Test Date                | :2015-06-16       |
| Fundamental Frequency | :2480 MHz       | Temp./Humi.              | :23 deg_C / 62 RH |
| Operation Mode        | :Band Edge HIGH | Engineer                 | :Curry            |
| EUT Pol.              | :E2 Plane       | Measurement Antenna Pol. | :VERTICAL         |

| Freq.   | Note    | Detector Mode | Spectrum Reading Level | Factor | Actual FS    | Limit @3m    | Margin |
|---------|---------|---------------|------------------------|--------|--------------|--------------|--------|
| MHz     | F/H/E/S | PK/QP/AV      | dB $\mu$ V             | dB     | dB $\mu$ V/m | dB $\mu$ V/m | dB     |
| 2483.50 | E       | Average       | 29.84                  | 6.01   | 35.85        | 54.00        | -18.15 |
| 2483.50 | E       | Peak          | 40.32                  | 6.01   | 46.33        | 74.00        | -27.67 |

|                       |                 |                          |                   |
|-----------------------|-----------------|--------------------------|-------------------|
| Operation Band        | :EDR+Hopping    | Test Date                | :2015-06-18       |
| Fundamental Frequency | :2480 MHz       | Temp./Humi.              | :23 deg_C / 62 RH |
| Operation Mode        | :Band Edge HIGH | Engineer                 | :Curry            |
| EUT Pol.              | :E2 Plane       | Measurement Antenna Pol. | :HORIZONTAL       |

| Freq.   | Note    | Detector Mode | Spectrum Reading Level | Factor | Actual FS    | Limit @3m    | Margin |
|---------|---------|---------------|------------------------|--------|--------------|--------------|--------|
| MHz     | F/H/E/S | PK/QP/AV      | dB $\mu$ V             | dB     | dB $\mu$ V/m | dB $\mu$ V/m | dB     |
| 2483.50 | E       | Average       | 29.91                  | 6.01   | 35.92        | 54.00        | -18.08 |
| 2483.50 | E       | Peak          | 42.34                  | 6.01   | 48.35        | 74.00        | -25.65 |

Unless otherwise stated the results shown in this test report refer only to the sample(s) tested and such sample(s) are retained for 90 days only.

除非另有說明，此報告結果僅對測試之樣品負責，同時此樣品僅保留90天。本報告未經本公司書面許可，不可部份複製。

This document is issued by the Company subject to its General Conditions of Service printed overleaf, available on request or accessible at [www.sgs.com/terms\\_and\\_conditions.htm](http://www.sgs.com/terms_and_conditions.htm) and, for electronic format documents, subject to Terms and Conditions for Electronic Documents at [www.sgs.com/terms\\_e-document.htm](http://www.sgs.com/terms_e-document.htm). Attention is drawn to the limitation of liability, indemnification and jurisdiction issues defined therein. Any holder of this document is advised that information contained hereon reflects the Company's findings at the time of its intervention only and within the limits of Client's instructions, if any. The Company's sole responsibility is to its Client and this document does not exonerate parties to a transaction from exercising all their rights and obligations under the transaction documents. This document cannot be reproduced except in full, without prior written approval of the Company. Any unauthorized alteration, forgery or falsification of the content or appearance of this document is unlawful and offenders may be prosecuted to the fullest extent of the law.

SGS Taiwan Ltd.

No.134,WuKungRoad,NewTaipeiIndustrialPark,WukuDistrict,NewTaipeiCity,Taiwan24803/新北市五股區新北產業園區五工路 134 號

台灣檢驗科技股份有限公司

t (886-2) 2299-3279

f (886-2) 2298-0488

www.tw.sgs.com

Member of SGS Group

**Radiated Emission – Band Edge (Non-Hopping Mode):**

|                       |                |                          |                   |
|-----------------------|----------------|--------------------------|-------------------|
| Operation Band        | :EDR           | Test Date                | :2015-06-16       |
| Fundamental Frequency | :2402 MHz      | Temp./Humi.              | :23 deg_C / 62 RH |
| Operation Mode        | :Band Edge LOW | Engineer                 | :Curry            |
| EUT Pol.              | :E2 Plane      | Measurement Antenna Pol. | :VERTICAL         |

| Freq.   | Note    | Detector Mode | Spectrum Reading Level | Factor | Actual FS    | Limit @3m    | Margin |
|---------|---------|---------------|------------------------|--------|--------------|--------------|--------|
| MHz     | F/H/E/S | PK/QP/AV      | dB $\mu$ V             | dB     | dB $\mu$ V/m | dB $\mu$ V/m | dB     |
| 2390.00 | E       | Average       | 30.53                  | 5.16   | 35.69        | 54.00        | -18.31 |
| 2390.00 | E       | Peak          | 44.30                  | 5.16   | 49.46        | 74.00        | -24.54 |

|                       |                |                          |                   |
|-----------------------|----------------|--------------------------|-------------------|
| Operation Band        | :EDR           | Test Date                | :2015-06-16       |
| Fundamental Frequency | :2402 MHz      | Temp./Humi.              | :23 deg_C / 62 RH |
| Operation Mode        | :Band Edge LOW | Engineer                 | :Curry            |
| EUT Pol.              | :E2 Plane      | Measurement Antenna Pol. | :HORIZONTAL       |

| Freq.   | Note    | Detector Mode | Spectrum Reading Level | Factor | Actual FS    | Limit @3m    | Margin |
|---------|---------|---------------|------------------------|--------|--------------|--------------|--------|
| MHz     | F/H/E/S | PK/QP/AV      | dB $\mu$ V             | dB     | dB $\mu$ V/m | dB $\mu$ V/m | dB     |
| 2390.00 | E       | Average       | 30.58                  | 5.16   | 35.74        | 54.00        | -18.26 |
| 2390.00 | E       | Peak          | 45.09                  | 5.16   | 50.25        | 74.00        | -23.75 |

Unless otherwise stated the results shown in this test report refer only to the sample(s) tested and such sample(s) are retained for 90 days only.

除非另有說明，此報告結果僅對測試之樣品負責，同時此樣品僅保留90天。本報告未經本公司書面許可，不可部份複製。

This document is issued by the Company subject to its General Conditions of Service printed overleaf, available on request or accessible at [www.sgs.com/terms\\_and\\_conditions.htm](http://www.sgs.com/terms_and_conditions.htm) and, for electronic format documents, subject to Terms and Conditions for Electronic Documents at [www.sgs.com/terms\\_e-document.htm](http://www.sgs.com/terms_e-document.htm). Attention is drawn to the limitation of liability, indemnification and jurisdiction issues defined therein. Any holder of this document is advised that information contained hereon reflects the Company's findings at the time of its intervention only and within the limits of Client's instructions, if any. The Company's sole responsibility is to its Client and this document does not exonerate parties to a transaction from exercising all their rights and obligations under the transaction documents. This document cannot be reproduced except in full, without prior written approval of the Company. Any unauthorized alteration, forgery or falsification of the content or appearance of this document is unlawful and offenders may be prosecuted to the fullest extent of the law.

SGS Taiwan Ltd.

No.134,WuKungRoad,NewTaipeiIndustrialPark,WukuDistrict,NewTaipeiCity,Taiwan24803/新北市五股區新北產業園區五工路 134 號

台灣檢驗科技股份有限公司

t (886-2) 2299-3279

f (886-2) 2298-0488

www.tw.sgs.com

|                       |                 |                          |                   |
|-----------------------|-----------------|--------------------------|-------------------|
| Operation Band        | :EDR            | Test Date                | :2015-06-16       |
| Fundamental Frequency | :2480 MHz       | Temp./Humi.              | :23 deg_C / 62 RH |
| Operation Mode        | :Band Edge HIGH | Engineer                 | :Curry            |
| EUT Pol.              | :E2 Plane       | Measurement Antenna Pol. | :VERTICAL         |

| Freq.   | Note    | Detector Mode | Spectrum Reading Level | Factor | Actual FS    | Limit @3m    | Margin |
|---------|---------|---------------|------------------------|--------|--------------|--------------|--------|
| MHz     | F/H/E/S | PK/QP/AV      | dB $\mu$ V             | dB     | dB $\mu$ V/m | dB $\mu$ V/m | dB     |
| 2483.50 | E       | Average       | 32.10                  | 6.01   | 38.11        | 54.00        | -15.89 |
| 2483.50 | E       | Peak          | 45.57                  | 6.01   | 51.58        | 74.00        | -22.42 |

|                       |                 |                          |                   |
|-----------------------|-----------------|--------------------------|-------------------|
| Operation Band        | :EDR            | Test Date                | :2015-06-16       |
| Fundamental Frequency | :2480 MHz       | Temp./Humi.              | :23 deg_C / 62 RH |
| Operation Mode        | :Band Edge HIGH | Engineer                 | :Curry            |
| EUT Pol.              | :E2 Plane       | Measurement Antenna Pol. | :HORIZONTAL       |

| Freq.   | Note    | Detector Mode | Spectrum Reading Level | Factor | Actual FS    | Limit @3m    | Margin |
|---------|---------|---------------|------------------------|--------|--------------|--------------|--------|
| MHz     | F/H/E/S | PK/QP/AV      | dB $\mu$ V             | dB     | dB $\mu$ V/m | dB $\mu$ V/m | dB     |
| 2483.50 | E       | Average       | 34.07                  | 6.01   | 40.08        | 54.00        | -13.92 |
| 2483.50 | E       | Peak          | 47.69                  | 6.01   | 53.70        | 74.00        | -20.30 |

Unless otherwise stated the results shown in this test report refer only to the sample(s) tested and such sample(s) are retained for 90 days only.

除非另有說明，此報告結果僅對測試之樣品負責，同時此樣品僅保留90天。本報告未經本公司書面許可，不可部份複製。

This document is issued by the Company subject to its General Conditions of Service printed overleaf, available on request or accessible at [www.sgs.com/terms\\_and\\_conditions.htm](http://www.sgs.com/terms_and_conditions.htm) and, for electronic format documents, subject to Terms and Conditions for Electronic Documents at [www.sgs.com/terms\\_e-document.htm](http://www.sgs.com/terms_e-document.htm). Attention is drawn to the limitation of liability, indemnification and jurisdiction issues defined therein. Any holder of this document is advised that information contained hereon reflects the Company's findings at the time of its intervention only and within the limits of Client's instructions, if any. The Company's sole responsibility is to its Client and this document does not exonerate parties to a transaction from exercising all their rights and obligations under the transaction documents. This document cannot be reproduced except in full, without prior written approval of the Company. Any unauthorized alteration, forgery or falsification of the content or appearance of this document is unlawful and offenders may be prosecuted to the fullest extent of the law.

SGS Taiwan Ltd.

No.134,WuKungRoad,NewTaipeiIndustrialPark,WukuDistrict,NewTaipeiCity,Taiwan24803/新北市五股區新北產業園區五工路 134 號

台灣檢驗科技股份有限公司

t (886-2) 2299-3279

f (886-2) 2298-0488

www.tw.sgs.com

Member of SGS Group

**Radiated Spurious Emission Measurement Result:**

**For Frequency form 30MHz to 1000MHz**

|                       |           |                          |                   |
|-----------------------|-----------|--------------------------|-------------------|
| Operation Band        | :EDR      | Test Date                | :2015-06-16       |
| Fundamental Frequency | :2402 MHz | Temp./Humi.              | :23 deg_C / 62 RH |
| Operation Mode        | :TX LOW   | Engineer                 | :Curry            |
| EUT Pol.              | :E2 Plane | Measurement Antenna Pol. | :VERTICAL         |

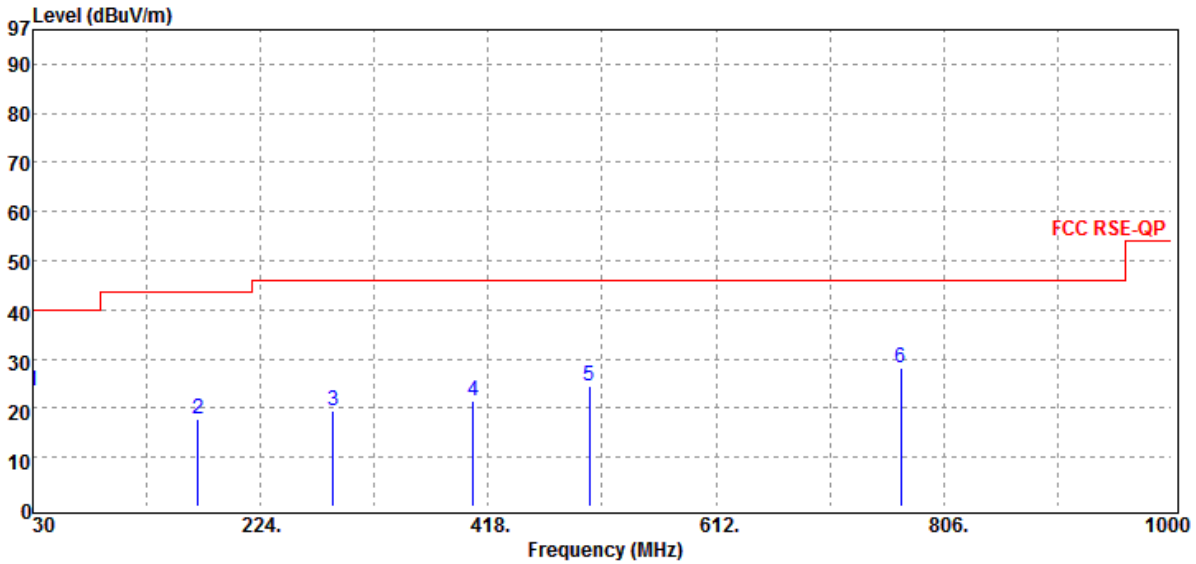

| Freq.<br>MHz | Note<br>F/H/E/S | Detector<br>Mode<br>PK/QP/AV | Spectrum<br>Reading Level<br>dBμV | Factor<br>dB | Actual<br>FS<br>dBμV/m | Limit<br>@3m<br>dBμV/m | Margin<br>dB |
|--------------|-----------------|------------------------------|-----------------------------------|--------------|------------------------|------------------------|--------------|
| 30.00        | S               | Peak                         | 33.77                             | -10.26       | 23.51                  | 40.00                  | -16.49       |
| 170.65       | S               | Peak                         | 27.23                             | -9.29        | 17.94                  | 43.50                  | -25.56       |
| 286.08       | S               | Peak                         | 27.82                             | -8.26        | 19.56                  | 46.00                  | -26.44       |
| 405.39       | S               | Peak                         | 27.33                             | -5.94        | 21.39                  | 46.00                  | -24.61       |
| 504.33       | S               | Peak                         | 28.89                             | -4.41        | 24.48                  | 46.00                  | -21.52       |
| 769.14       | S               | Peak                         | 27.15                             | 0.99         | 28.14                  | 46.00                  | -17.86       |

Unless otherwise stated the results shown in this test report refer only to the sample(s) tested and such sample(s) are retained for 90 days only.

除非另有說明，此報告結果僅對測試之樣品負責，同時此樣品僅保留90天。本報告未經本公司書面許可，不可部份複製。

This document is issued by the Company subject to its General Conditions of Service printed overleaf, available on request or accessible at [www.sgs.com/terms\\_and\\_conditions.htm](http://www.sgs.com/terms_and_conditions.htm) and, for electronic format documents, subject to Terms and Conditions for Electronic Documents at [www.sgs.com/terms\\_e-document.htm](http://www.sgs.com/terms_e-document.htm). Attention is drawn to the limitation of liability, indemnification and jurisdiction issues defined therein. Any holder of this document is advised that information contained hereon reflects the Company's findings at the time of its intervention only and within the limits of Client's instructions, if any. The Company's sole responsibility is to its Client and this document does not exonerate parties to a transaction from exercising all their rights and obligations under the transaction documents. This document cannot be reproduced except in full, without prior written approval of the Company. Any unauthorized alteration, forgery or falsification of the content or appearance of this document is unlawful and offenders may be prosecuted to the fullest extent of the law.

|                       |           |                          |                   |
|-----------------------|-----------|--------------------------|-------------------|
| Operation Band        | :EDR      | Test Date                | :2015-06-16       |
| Fundamental Frequency | :2402 MHz | Temp./Humi.              | :23 deg_C / 62 RH |
| Operation Mode        | :TX LOW   | Engineer                 | :Curry            |
| EUT Pol.              | :E2 Plane | Measurement Antenna Pol. | :HORIZONTAL       |

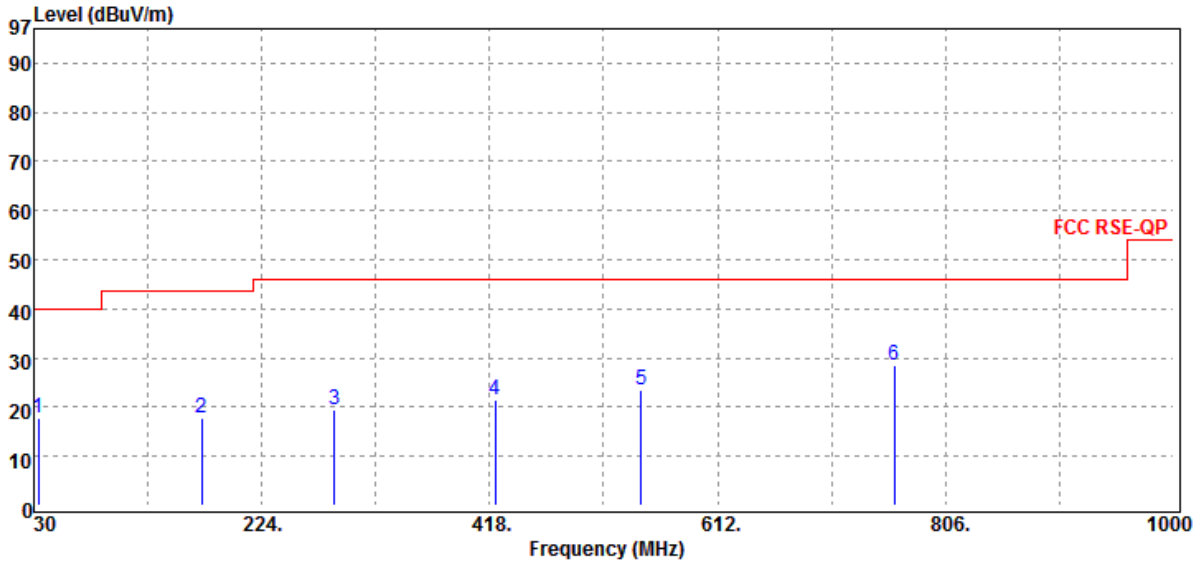

| Freq.  | Note    | Detector | Spectrum      | Factor | Actual | Limit  | Margin |
|--------|---------|----------|---------------|--------|--------|--------|--------|
| MHz    | F/H/E/S | Mode     | Reading Level | dB     | FS     | @3m    | dB     |
|        |         | PK/QP/AV | dBμV          |        | dBμV/m | dBμV/m |        |
| 33.88  | S       | Peak     | 28.08         | -10.19 | 17.89  | 40.00  | -22.11 |
| 172.59 | S       | Peak     | 27.28         | -9.56  | 17.72  | 43.50  | -25.78 |
| 286.08 | S       | Peak     | 27.82         | -8.26  | 19.56  | 46.00  | -26.44 |
| 422.85 | S       | Peak     | 27.25         | -5.69  | 21.56  | 46.00  | -24.44 |
| 547.01 | S       | Peak     | 27.69         | -4.03  | 23.66  | 46.00  | -22.34 |
| 762.35 | S       | Peak     | 27.51         | 1.14   | 28.65  | 46.00  | -17.35 |

Unless otherwise stated the results shown in this test report refer only to the sample(s) tested and such sample(s) are retained for 90 days only.

除非另有說明，此報告結果僅對測試之樣品負責，同時此樣品僅保留90天。本報告未經本公司書面許可，不可部份複製。

This document is issued by the Company subject to its General Conditions of Service printed overleaf, available on request or accessible at [www.sgs.com/terms\\_and\\_conditions.htm](http://www.sgs.com/terms_and_conditions.htm) and, for electronic format documents, subject to Terms and Conditions for Electronic Documents at [www.sgs.com/terms\\_e-document.htm](http://www.sgs.com/terms_e-document.htm). Attention is drawn to the limitation of liability, indemnification and jurisdiction issues defined therein. Any holder of this document is advised that information contained hereon reflects the Company's findings at the time of its intervention only and within the limits of Client's instructions, if any. The Company's sole responsibility is to its Client and this document does not exonerate parties to a transaction from exercising all their rights and obligations under the transaction documents. This document cannot be reproduced except in full, without prior written approval of the Company. Any unauthorized alteration, forgery or falsification of the content or appearance of this document is unlawful and offenders may be prosecuted to the fullest extent of the law.

SGS Taiwan Ltd.

No.134,WuKungRoad,NewTaipeiIndustrialPark,WukuDistrict,NewTaipeiCity,Taiwan24803/新北市五股區新北產業園區五工路 134 號

台灣檢驗科技股份有限公司

t (886-2) 2299-3279

f (886-2) 2298-0488

www.tw.sgs.com

Member of SGS Group

|                       |           |                          |                   |
|-----------------------|-----------|--------------------------|-------------------|
| Operation Band        | :EDR      | Test Date                | :2015-06-16       |
| Fundamental Frequency | :2441 MHz | Temp./Humi.              | :23 deg_C / 62 RH |
| Operation Mode        | :TX MID   | Engineer                 | :Curry            |
| EUT Pol.              | :E2 Plane | Measurement Antenna Pol. | :VERTICAL         |

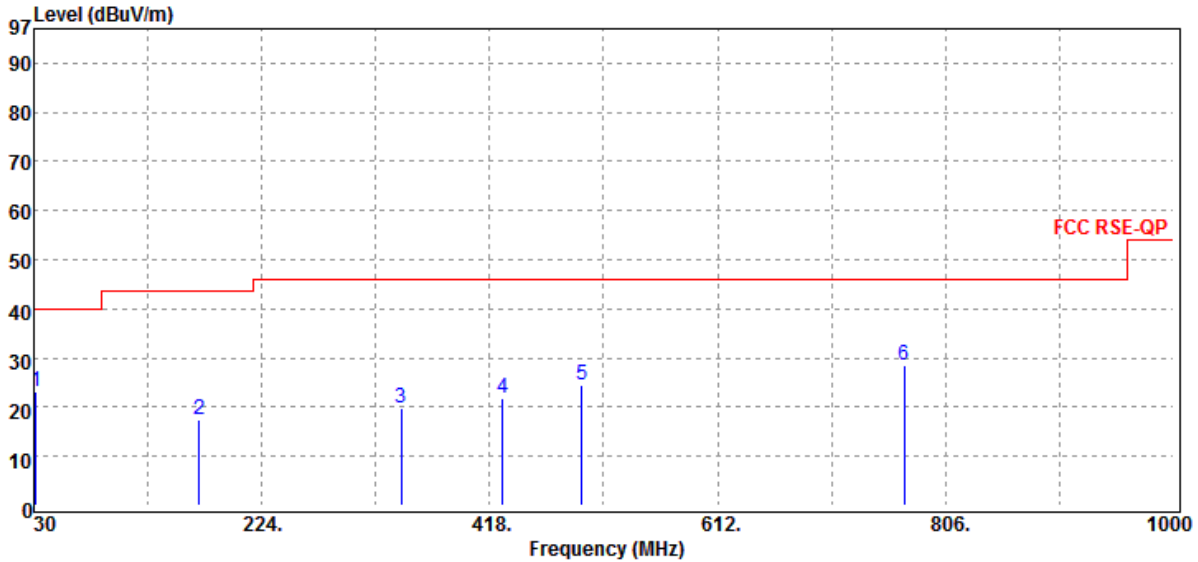

| Freq.<br>MHz | Note<br>F/H/E/S | Detector<br>Mode<br>PK/QP/AV | Spectrum<br>Reading Level<br>dBμV | Factor<br>dB | Actual<br>FS<br>dBμV/m | Limit<br>@3m<br>dBμV/m | Margin<br>dB |
|--------------|-----------------|------------------------------|-----------------------------------|--------------|------------------------|------------------------|--------------|
| 31.94        | S               | Peak                         | 33.54                             | -10.22       | 23.32                  | 40.00                  | -16.68       |
| 170.65       | S               | Peak                         | 26.66                             | -9.29        | 17.37                  | 43.50                  | -26.13       |
| 342.34       | S               | Peak                         | 27.30                             | -7.41        | 19.89                  | 46.00                  | -26.11       |
| 428.67       | S               | Peak                         | 27.62                             | -5.75        | 21.87                  | 46.00                  | -24.13       |
| 496.57       | S               | Peak                         | 28.87                             | -4.33        | 24.54                  | 46.00                  | -21.46       |
| 771.08       | S               | Peak                         | 27.75                             | 0.90         | 28.65                  | 46.00                  | -17.35       |

Unless otherwise stated the results shown in this test report refer only to the sample(s) tested and such sample(s) are retained for 90 days only.

除非另有說明，此報告結果僅對測試之樣品負責，同時此樣品僅保留90天。本報告未經本公司書面許可，不可部份複製。

This document is issued by the Company subject to its General Conditions of Service printed overleaf, available on request or accessible at [www.sgs.com/terms\\_and\\_conditions.htm](http://www.sgs.com/terms_and_conditions.htm) and, for electronic format documents, subject to Terms and Conditions for Electronic Documents at [www.sgs.com/terms\\_e-document.htm](http://www.sgs.com/terms_e-document.htm). Attention is drawn to the limitation of liability, indemnification and jurisdiction issues defined therein. Any holder of this document is advised that information contained hereon reflects the Company's findings at the time of its intervention only and within the limits of Client's instructions, if any. The Company's sole responsibility is to its Client and this document does not exonerate parties to a transaction from exercising all their rights and obligations under the transaction documents. This document cannot be reproduced except in full, without prior written approval of the Company. Any unauthorized alteration, forgery or falsification of the content or appearance of this document is unlawful and offenders may be prosecuted to the fullest extent of the law.

|                       |           |                          |                   |
|-----------------------|-----------|--------------------------|-------------------|
| Operation Band        | :EDR      | Test Date                | :2015-06-16       |
| Fundamental Frequency | :2441 MHz | Temp./Humi.              | :23 deg_C / 62 RH |
| Operation Mode        | :TX MID   | Engineer                 | :Curry            |
| EUT Pol.              | :E2 Plane | Measurement Antenna Pol. | :HORIZONTAL       |

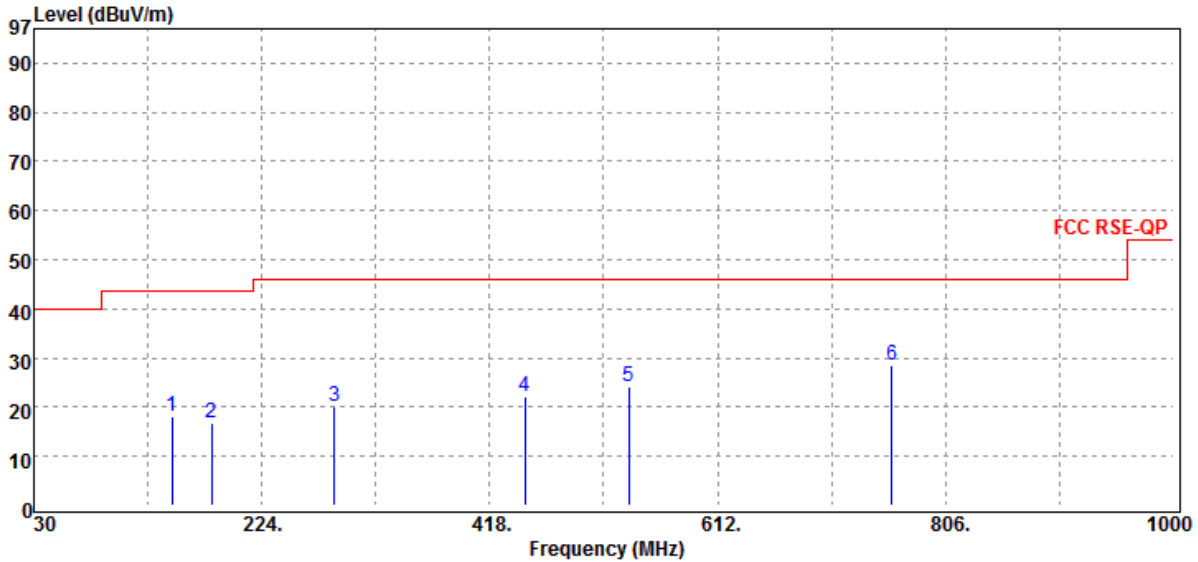

| Freq.<br>MHz | Note<br>F/H/E/S | Detector<br>Mode<br>PK/QP/AV | Spectrum<br>Reading Level<br>dBμV | Factor<br>dB | Actual<br>FS<br>dBμV/m | Limit<br>@3m<br>dBμV/m | Margin<br>dB |
|--------------|-----------------|------------------------------|-----------------------------------|--------------|------------------------|------------------------|--------------|
| 147.37       | S               | Peak                         | 27.59                             | -9.51        | 18.08                  | 43.50                  | -25.42       |
| 181.32       | S               | Peak                         | 27.39                             | -10.70       | 16.69                  | 43.50                  | -26.81       |
| 286.08       | S               | Peak                         | 28.43                             | -8.26        | 20.17                  | 46.00                  | -25.83       |
| 448.07       | S               | Peak                         | 27.86                             | -5.71        | 22.15                  | 46.00                  | -23.85       |
| 536.34       | S               | Peak                         | 28.26                             | -3.99        | 24.27                  | 46.00                  | -21.73       |
| 760.41       | S               | Peak                         | 27.55                             | 1.11         | 28.66                  | 46.00                  | -17.34       |

Unless otherwise stated the results shown in this test report refer only to the sample(s) tested and such sample(s) are retained for 90 days only.

除非另有說明，此報告結果僅對測試之樣品負責，同時此樣品僅保留90天。本報告未經本公司書面許可，不可部份複製。

This document is issued by the Company subject to its General Conditions of Service printed overleaf, available on request or accessible at [www.sgs.com/terms\\_and\\_conditions.htm](http://www.sgs.com/terms_and_conditions.htm) and, for electronic format documents, subject to Terms and Conditions for Electronic Documents at [www.sgs.com/terms\\_e-document.htm](http://www.sgs.com/terms_e-document.htm). Attention is drawn to the limitation of liability, indemnification and jurisdiction issues defined therein. Any holder of this document is advised that information contained hereon reflects the Company's findings at the time of its intervention only and within the limits of Client's instructions, if any. The Company's sole responsibility is to its Client and this document does not exonerate parties to a transaction from exercising all their rights and obligations under the transaction documents. This document cannot be reproduced except in full, without prior written approval of the Company. Any unauthorized alteration, forgery or falsification of the content or appearance of this document is unlawful and offenders may be prosecuted to the fullest extent of the law.



|                       |           |                          |                   |
|-----------------------|-----------|--------------------------|-------------------|
| Operation Band        | :EDR      | Test Date                | :2015-06-16       |
| Fundamental Frequency | :2480 MHz | Temp./Humi.              | :23 deg_C / 62 RH |
| Operation Mode        | :TX HIGH  | Engineer                 | :Curry            |
| EUT Pol.              | :E2 Plane | Measurement Antenna Pol. | :VERTICAL         |

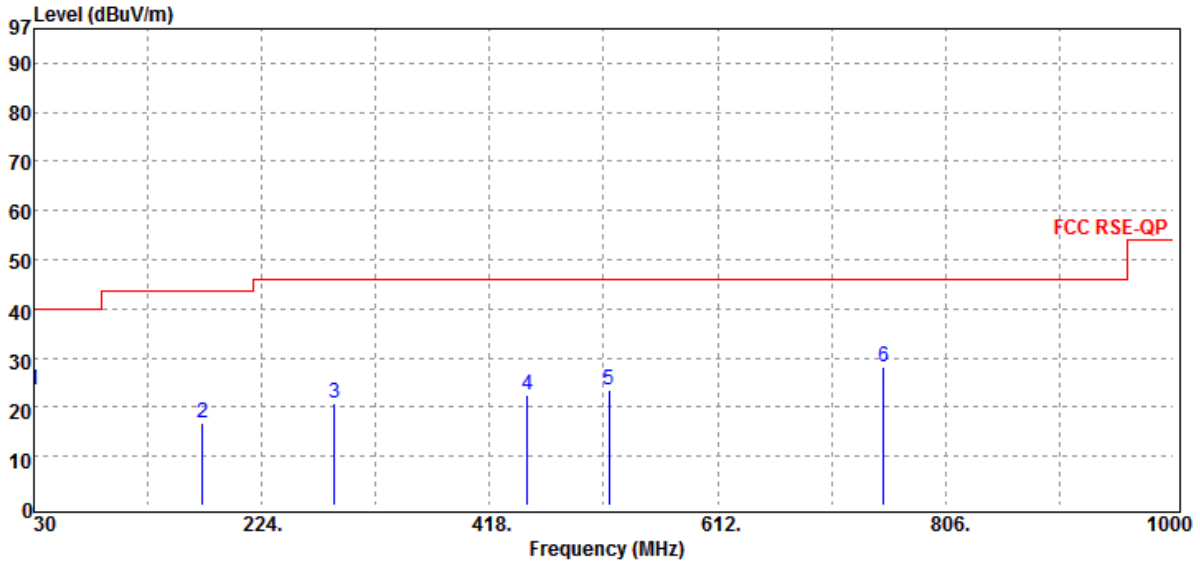

| Freq.  | Note    | Detector | Spectrum      | Factor | Actual       | Limit        | Margin |
|--------|---------|----------|---------------|--------|--------------|--------------|--------|
| MHz    | F/H/E/S | PK/QP/AV | Reading Level | dB     | FS           | @3m          | dB     |
|        |         |          | dB $\mu$ V    |        | dB $\mu$ V/m | dB $\mu$ V/m |        |
| 30.00  | S       | Peak     | 33.68         | -10.26 | 23.42        | 40.00        | -16.58 |
| 173.56 | S       | Peak     | 26.47         | -9.69  | 16.78        | 43.50        | -26.72 |
| 286.08 | S       | Peak     | 28.94         | -8.26  | 20.68        | 46.00        | -25.32 |
| 450.01 | S       | Peak     | 28.12         | -5.68  | 22.44        | 46.00        | -23.56 |
| 519.85 | S       | Peak     | 27.90         | -4.42  | 23.48        | 46.00        | -22.52 |
| 753.62 | S       | Peak     | 27.49         | 0.64   | 28.13        | 46.00        | -17.87 |

Unless otherwise stated the results shown in this test report refer only to the sample(s) tested and such sample(s) are retained for 90 days only.

除非另有說明，此報告結果僅對測試之樣品負責，同時此樣品僅保留90天。本報告未經本公司書面許可，不可部份複製。

This document is issued by the Company subject to its General Conditions of Service printed overleaf, available on request or accessible at [www.sgs.com/terms\\_and\\_conditions.htm](http://www.sgs.com/terms_and_conditions.htm) and, for electronic format documents, subject to Terms and Conditions for Electronic Documents at [www.sgs.com/terms\\_e-document.htm](http://www.sgs.com/terms_e-document.htm). Attention is drawn to the limitation of liability, indemnification and jurisdiction issues defined therein. Any holder of this document is advised that information contained hereon reflects the Company's findings at the time of its intervention only and within the limits of Client's instructions, if any. The Company's sole responsibility is to its Client and this document does not exonerate parties to a transaction from exercising all their rights and obligations under the transaction documents. This document cannot be reproduced except in full, without prior written approval of the Company. Any unauthorized alteration, forgery or falsification of the content or appearance of this document is unlawful and offenders may be prosecuted to the fullest extent of the law.

SGS Taiwan Ltd.

No.134,WuKungRoad,NewTaipeiIndustrialPark,WukuDistrict,NewTaipeiCity,Taiwan24803/新北市五股區新北產業園區五工路 134 號

台灣檢驗科技股份有限公司

t (886-2) 2299-3279

f (886-2) 2298-0488

www.tw.sgs.com

Member of SGS Group

|                       |           |                          |                   |
|-----------------------|-----------|--------------------------|-------------------|
| Operation Band        | :EDR      | Test Date                | :2015-06-16       |
| Fundamental Frequency | :2480 MHz | Temp./Humi.              | :23 deg_C / 62 RH |
| Operation Mode        | :TX HIGH  | Engineer                 | :Curry            |
| EUT Pol.              | :E2 Plane | Measurement Antenna Pol. | :HORIZONTAL       |

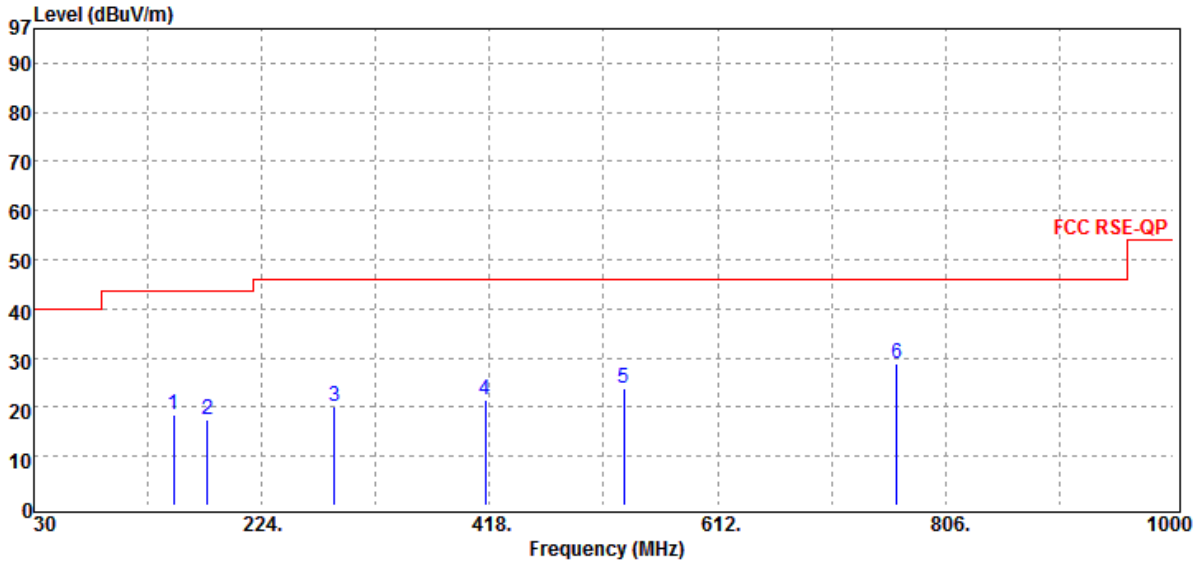

| Freq.<br>MHz | Note<br>F/H/E/S | Detector<br>Mode<br>PK/QP/AV | Spectrum<br>Reading Level<br>dBμV | Factor<br>dB | Actual<br>FS<br>dBμV/m | Limit<br>@3m<br>dBμV/m | Margin<br>dB |
|--------------|-----------------|------------------------------|-----------------------------------|--------------|------------------------|------------------------|--------------|
| 149.31       | S               | Peak                         | 27.93                             | -9.34        | 18.59                  | 43.50                  | -24.91       |
| 177.44       | S               | Peak                         | 27.54                             | -10.21       | 17.33                  | 43.50                  | -26.17       |
| 286.08       | S               | Peak                         | 28.29                             | -8.26        | 20.03                  | 46.00                  | -25.97       |
| 414.12       | S               | Peak                         | 27.31                             | -5.75        | 21.56                  | 46.00                  | -24.44       |
| 532.46       | S               | Peak                         | 27.73                             | -4.03        | 23.70                  | 46.00                  | -22.30       |
| 764.29       | S               | Peak                         | 27.80                             | 1.13         | 28.93                  | 46.00                  | -17.07       |

Unless otherwise stated the results shown in this test report refer only to the sample(s) tested and such sample(s) are retained for 90 days only.

除非另有說明，此報告結果僅對測試之樣品負責，同時此樣品僅保留90天。本報告未經本公司書面許可，不可部份複製。

This document is issued by the Company subject to its General Conditions of Service printed overleaf, available on request or accessible at [www.sgs.com/terms\\_and\\_conditions.htm](http://www.sgs.com/terms_and_conditions.htm) and, for electronic format documents, subject to Terms and Conditions for Electronic Documents at [www.sgs.com/terms\\_e-document.htm](http://www.sgs.com/terms_e-document.htm). Attention is drawn to the limitation of liability, indemnification and jurisdiction issues defined therein. Any holder of this document is advised that information contained hereon reflects the Company's findings at the time of its intervention only and within the limits of Client's instructions, if any. The Company's sole responsibility is to its Client and this document does not exonerate parties to a transaction from exercising all their rights and obligations under the transaction documents. This document cannot be reproduced except in full, without prior written approval of the Company. Any unauthorized alteration, forgery or falsification of the content or appearance of this document is unlawful and offenders may be prosecuted to the fullest extent of the law.

SGS Taiwan Ltd.

No.134,WuKungRoad,NewTaipeiIndustrialPark,WukuDistrict,NewTaipeiCity,Taiwan24803/新北市五股區新北產業園區五工路 134 號

台灣檢驗科技股份有限公司

t (886-2) 2299-3279

f (886-2) 2298-0488

www.tw.sgs.com

Member of SGS Group

**Radiated Spurious Emission Measurement Result:**

**For Frequency above 1 GHz**

|                       |           |                          |                   |
|-----------------------|-----------|--------------------------|-------------------|
| Operation Band        | :EDR      | Test Date                | :2015-06-16       |
| Fundamental Frequency | :2402 MHz | Temp./Humi.              | :23 deg_C / 62 RH |
| Operation Mode        | :TX LOW   | Engineer                 | :Curry            |
| EUT Pol.              | :E2 Plane | Measurement Antenna Pol. | :VERTICAL         |

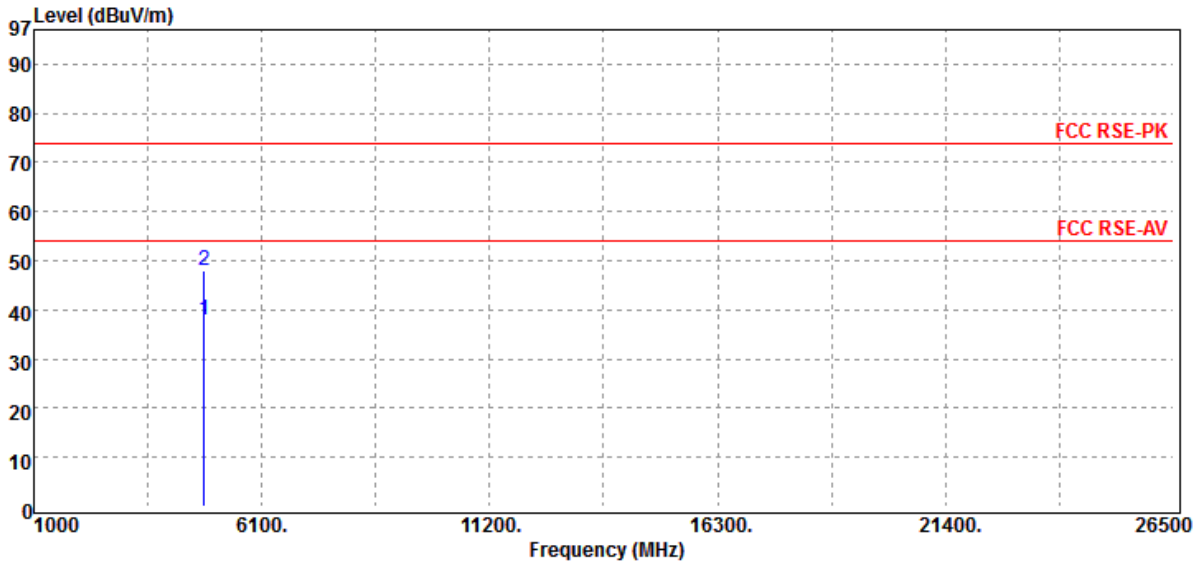

| Freq.<br>MHz | Note<br>F/H/E/S | Detector<br>Mode<br>PK/QP/AV | Spectrum<br>Reading Level<br>dBμV | Factor<br>dB | Actual<br>FS<br>dBμV/m | Limit<br>@3m<br>dBμV/m | Margin<br>dB |
|--------------|-----------------|------------------------------|-----------------------------------|--------------|------------------------|------------------------|--------------|
| 4804.00      | H               | Average                      | 28.21                             | 9.56         | 37.77                  | 54.00                  | -16.23       |
| 4804.00      | H               | Peak                         | 38.56                             | 9.56         | 48.12                  | 74.00                  | -25.88       |

Unless otherwise stated the results shown in this test report refer only to the sample(s) tested and such sample(s) are retained for 90 days only.

除非另有說明，此報告結果僅對測試之樣品負責，同時此樣品僅保留90天。本報告未經本公司書面許可，不可部份複製。

This document is issued by the Company subject to its General Conditions of Service printed overleaf, available on request or accessible at [www.sgs.com/terms\\_and\\_conditions.htm](http://www.sgs.com/terms_and_conditions.htm) and, for electronic format documents, subject to Terms and Conditions for Electronic Documents at [www.sgs.com/terms\\_e-document.htm](http://www.sgs.com/terms_e-document.htm). Attention is drawn to the limitation of liability, indemnification and jurisdiction issues defined therein. Any holder of this document is advised that information contained hereon reflects the Company's findings at the time of its intervention only and within the limits of Client's instructions, if any. The Company's sole responsibility is to its Client and this document does not exonerate parties to a transaction from exercising all their rights and obligations under the transaction documents. This document cannot be reproduced except in full, without prior written approval of the Company. Any unauthorized alteration, forgery or falsification of the content or appearance of this document is unlawful and offenders may be prosecuted to the fullest extent of the law.

SGS Taiwan Ltd.

No.134,WuKungRoad,NewTaipeiIndustrialPark,WukuDistrict,NewTaipeiCity,Taiwan24803/新北市五股區新北產業園區五工路 134 號

台灣檢驗科技股份有限公司

t (886-2) 2299-3279

f (886-2) 2298-0488

www.tw.sgs.com

Member of SGS Group

|                       |           |                          |                   |
|-----------------------|-----------|--------------------------|-------------------|
| Operation Band        | :EDR      | Test Date                | :2015-06-16       |
| Fundamental Frequency | :2402 MHz | Temp./Humi.              | :23 deg_C / 62 RH |
| Operation Mode        | :TX LOW   | Engineer                 | :Curry            |
| EUT Pol.              | :E2 Plane | Measurement Antenna Pol. | :HORIZONTAL       |

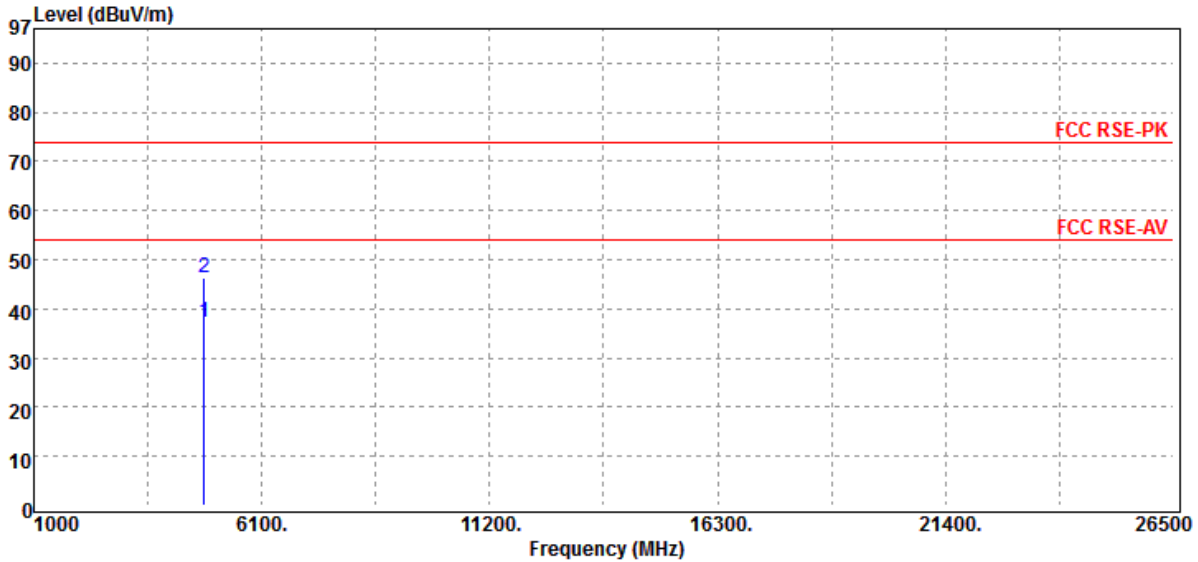

| Freq.   | Note    | Detector | Spectrum      | Factor | Actual       | Limit        | Margin |
|---------|---------|----------|---------------|--------|--------------|--------------|--------|
| MHz     | F/H/E/S | Mode     | Reading Level | dB     | FS           | @3m          | dB     |
|         |         | PK/QP/AV | dB $\mu$ V    |        | dB $\mu$ V/m | dB $\mu$ V/m |        |
| 4804.00 | H       | Average  | 27.76         | 9.56   | 37.32        | 54.00        | -16.68 |
| 4804.00 | H       | Peak     | 36.78         | 9.56   | 46.34        | 74.00        | -27.66 |

Unless otherwise stated the results shown in this test report refer only to the sample(s) tested and such sample(s) are retained for 90 days only.

除非另有說明，此報告結果僅對測試之樣品負責，同時此樣品僅保留90天。本報告未經本公司書面許可，不可部份複製。

This document is issued by the Company subject to its General Conditions of Service printed overleaf, available on request or accessible at [www.sgs.com/terms\\_and\\_conditions.htm](http://www.sgs.com/terms_and_conditions.htm) and, for electronic format documents, subject to Terms and Conditions for Electronic Documents at [www.sgs.com/terms\\_e-document.htm](http://www.sgs.com/terms_e-document.htm). Attention is drawn to the limitation of liability, indemnification and jurisdiction issues defined therein. Any holder of this document is advised that information contained hereon reflects the Company's findings at the time of its intervention only and within the limits of Client's instructions, if any. The Company's sole responsibility is to its Client and this document does not exonerate parties to a transaction from exercising all their rights and obligations under the transaction documents. This document cannot be reproduced except in full, without prior written approval of the Company. Any unauthorized alteration, forgery or falsification of the content or appearance of this document is unlawful and offenders may be prosecuted to the fullest extent of the law.

SGS Taiwan Ltd.

No.134,WuKungRoad,NewTaipeiIndustrialPark,WukuDistrict,NewTaipeiCity,Taiwan24803/新北市五股區新北產業園區五工路 134 號

台灣檢驗科技股份有限公司

t (886-2) 2299-3279

f (886-2) 2298-0488

www.tw.sgs.com

Member of SGS Group

|                       |           |                          |                   |
|-----------------------|-----------|--------------------------|-------------------|
| Operation Band        | :EDR      | Test Date                | :2015-06-16       |
| Fundamental Frequency | :2441 MHz | Temp./Humi.              | :23 deg_C / 62 RH |
| Operation Mode        | :TX MID   | Engineer                 | :Curry            |
| EUT Pol.              | :E2 Plane | Measurement Antenna Pol. | :VERTICAL         |

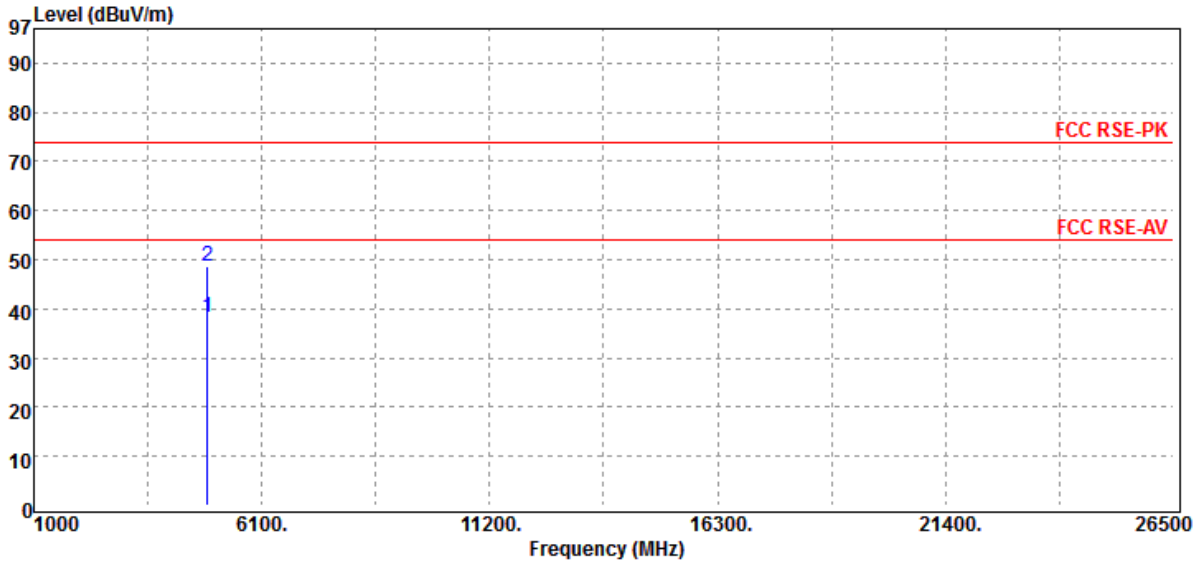

| Freq.   | Note    | Detector | Spectrum      | Factor | Actual       | Limit        | Margin |
|---------|---------|----------|---------------|--------|--------------|--------------|--------|
| MHz     | F/H/E/S | Mode     | Reading Level | dB     | FS           | @3m          | dB     |
|         |         | PK/QP/AV | dB $\mu$ V    |        | dB $\mu$ V/m | dB $\mu$ V/m |        |
| 4882.00 | H       | Average  | 28.47         | 9.85   | 38.32        | 54.00        | -15.68 |
| 4882.00 | H       | Peak     | 38.83         | 9.85   | 48.68        | 74.00        | -25.32 |

Unless otherwise stated the results shown in this test report refer only to the sample(s) tested and such sample(s) are retained for 90 days only.

除非另有說明，此報告結果僅對測試之樣品負責，同時此樣品僅保留90天。本報告未經本公司書面許可，不可部份複製。

This document is issued by the Company subject to its General Conditions of Service printed overleaf, available on request or accessible at [www.sgs.com/terms\\_and\\_conditions.htm](http://www.sgs.com/terms_and_conditions.htm) and, for electronic format documents, subject to Terms and Conditions for Electronic Documents at [www.sgs.com/terms\\_e-document.htm](http://www.sgs.com/terms_e-document.htm). Attention is drawn to the limitation of liability, indemnification and jurisdiction issues defined therein. Any holder of this document is advised that information contained hereon reflects the Company's findings at the time of its intervention only and within the limits of Client's instructions, if any. The Company's sole responsibility is to its Client and this document does not exonerate parties to a transaction from exercising all their rights and obligations under the transaction documents. This document cannot be reproduced except in full, without prior written approval of the Company. Any unauthorized alteration, forgery or falsification of the content or appearance of this document is unlawful and offenders may be prosecuted to the fullest extent of the law.

SGS Taiwan Ltd.

No.134,WuKungRoad,NewTaipeiIndustrialPark,WukuDistrict,NewTaipeiCity,Taiwan24803/新北市五股區新北產業園區五工路 134 號

台灣檢驗科技股份有限公司

t (886-2) 2299-3279

f (886-2) 2298-0488

www.tw.sgs.com

Member of SGS Group

|                       |           |                          |                   |
|-----------------------|-----------|--------------------------|-------------------|
| Operation Band        | :EDR      | Test Date                | :2015-06-16       |
| Fundamental Frequency | :2441 MHz | Temp./Humi.              | :23 deg_C / 62 RH |
| Operation Mode        | :TX MID   | Engineer                 | :Curry            |
| EUT Pol.              | :E2 Plane | Measurement Antenna Pol. | :HORIZONTAL       |

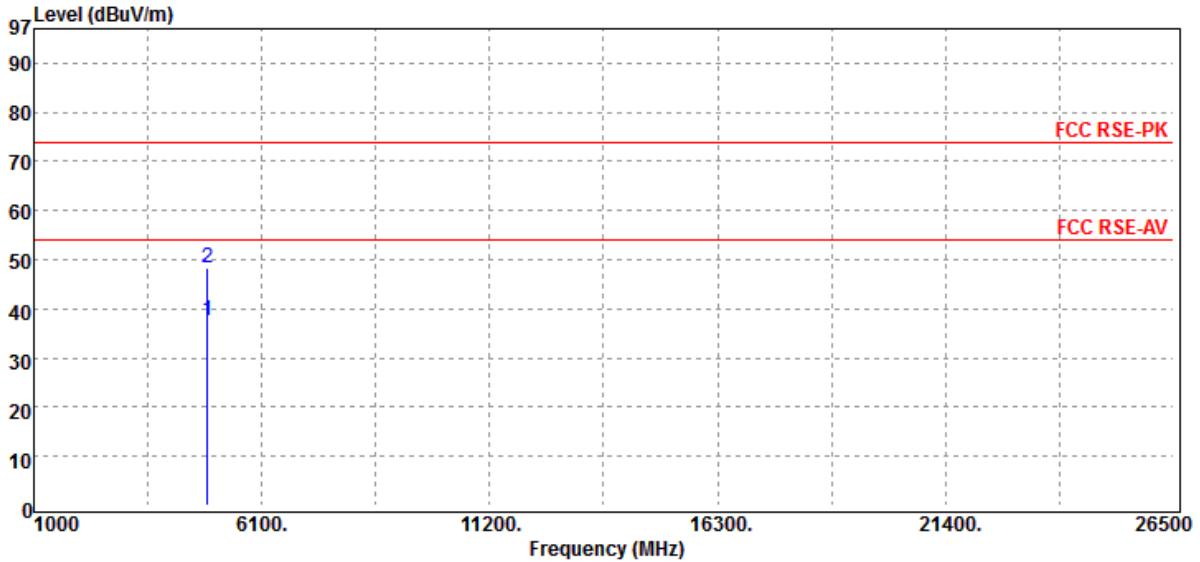

| Freq.   | Note    | Detector | Spectrum      | Factor | Actual       | Limit        | Margin |
|---------|---------|----------|---------------|--------|--------------|--------------|--------|
| MHz     | F/H/E/S | Mode     | Reading Level | dB     | FS           | @3m          | dB     |
|         |         | PK/QP/AV | dB $\mu$ V    |        | dB $\mu$ V/m | dB $\mu$ V/m |        |
| 4882.00 | H       | Average  | 27.88         | 9.85   | 37.73        | 54.00        | -16.27 |
| 4882.00 | H       | Peak     | 38.46         | 9.85   | 48.31        | 74.00        | -25.69 |

Unless otherwise stated the results shown in this test report refer only to the sample(s) tested and such sample(s) are retained for 90 days only.

除非另有說明，此報告結果僅對測試之樣品負責，同時此樣品僅保留90天。本報告未經本公司書面許可，不可部份複製。

This document is issued by the Company subject to its General Conditions of Service printed overleaf, available on request or accessible at [www.sgs.com/terms\\_and\\_conditions.htm](http://www.sgs.com/terms_and_conditions.htm) and, for electronic format documents, subject to Terms and Conditions for Electronic Documents at [www.sgs.com/terms\\_e-document.htm](http://www.sgs.com/terms_e-document.htm). Attention is drawn to the limitation of liability, indemnification and jurisdiction issues defined therein. Any holder of this document is advised that information contained hereon reflects the Company's findings at the time of its intervention only and within the limits of Client's instructions, if any. The Company's sole responsibility is to its Client and this document does not exonerate parties to a transaction from exercising all their rights and obligations under the transaction documents. This document cannot be reproduced except in full, without prior written approval of the Company. Any unauthorized alteration, forgery or falsification of the content or appearance of this document is unlawful and offenders may be prosecuted to the fullest extent of the law.

SGS Taiwan Ltd.

No.134,WuKungRoad,NewTaipeiIndustrialPark,WukuDistrict,NewTaipeiCity,Taiwan24803/新北市五股區新北產業園區五工路 134 號

台灣檢驗科技股份有限公司

t (886-2) 2299-3279

f (886-2) 2298-0488

www.tw.sgs.com

Member of SGS Group

|                       |           |                          |                   |
|-----------------------|-----------|--------------------------|-------------------|
| Operation Band        | :EDR      | Test Date                | :2015-06-16       |
| Fundamental Frequency | :2480 MHz | Temp./Humi.              | :23 deg_C / 62 RH |
| Operation Mode        | :TX HIGH  | Engineer                 | :Curry            |
| EUT Pol.              | :E2 Plane | Measurement Antenna Pol. | :VERTICAL         |

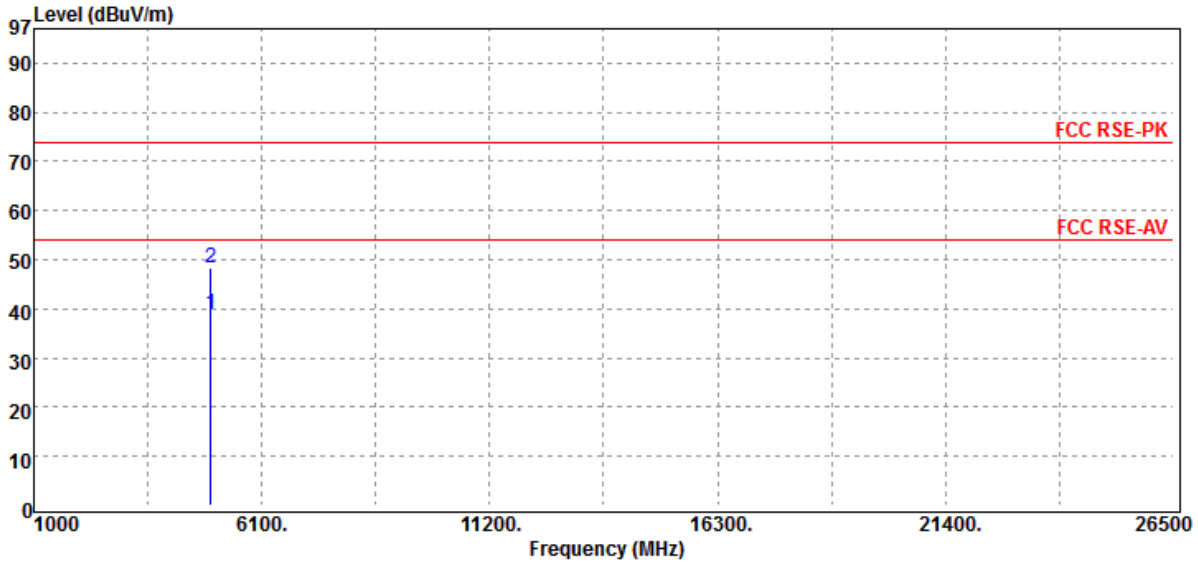

| Freq.   | Note    | Detector | Spectrum      | Factor | Actual       | Limit        | Margin |
|---------|---------|----------|---------------|--------|--------------|--------------|--------|
| MHz     | F/H/E/S | Mode     | Reading Level | dB     | FS           | @3m          | dB     |
|         |         | PK/QP/AV | dB $\mu$ V    |        | dB $\mu$ V/m | dB $\mu$ V/m |        |
| 4960.00 | H       | Average  | 28.92         | 9.86   | 38.78        | 54.00        | -15.22 |
| 4960.00 | H       | Peak     | 38.60         | 9.86   | 48.46        | 74.00        | -25.54 |

Unless otherwise stated the results shown in this test report refer only to the sample(s) tested and such sample(s) are retained for 90 days only.

除非另有說明，此報告結果僅對測試之樣品負責，同時此樣品僅保留90天。本報告未經本公司書面許可，不可部份複製。

This document is issued by the Company subject to its General Conditions of Service printed overleaf, available on request or accessible at [www.sgs.com/terms\\_and\\_conditions.htm](http://www.sgs.com/terms_and_conditions.htm) and, for electronic format documents, subject to Terms and Conditions for Electronic Documents at [www.sgs.com/terms\\_e-document.htm](http://www.sgs.com/terms_e-document.htm). Attention is drawn to the limitation of liability, indemnification and jurisdiction issues defined therein. Any holder of this document is advised that information contained hereon reflects the Company's findings at the time of its intervention only and within the limits of Client's instructions, if any. The Company's sole responsibility is to its Client and this document does not exonerate parties to a transaction from exercising all their rights and obligations under the transaction documents. This document cannot be reproduced except in full, without prior written approval of the Company. Any unauthorized alteration, forgery or falsification of the content or appearance of this document is unlawful and offenders may be prosecuted to the fullest extent of the law.

SGS Taiwan Ltd.

No.134,WuKungRoad,NewTaipeiIndustrialPark,WukuDistrict,NewTaipeiCity,Taiwan24803/新北市五股區新北產業園區五工路 134 號

台灣檢驗科技股份有限公司

t (886-2) 2299-3279

f (886-2) 2298-0488

www.tw.sgs.com

Member of SGS Group

|                       |           |                          |                   |
|-----------------------|-----------|--------------------------|-------------------|
| Operation Band        | :EDR      | Test Date                | :2015-06-16       |
| Fundamental Frequency | :2480 MHz | Temp./Humi.              | :23 deg_C / 62 RH |
| Operation Mode        | :TX HIGH  | Engineer                 | :Curry            |
| EUT Pol.              | :E2 Plane | Measurement Antenna Pol. | :HORIZONTAL       |

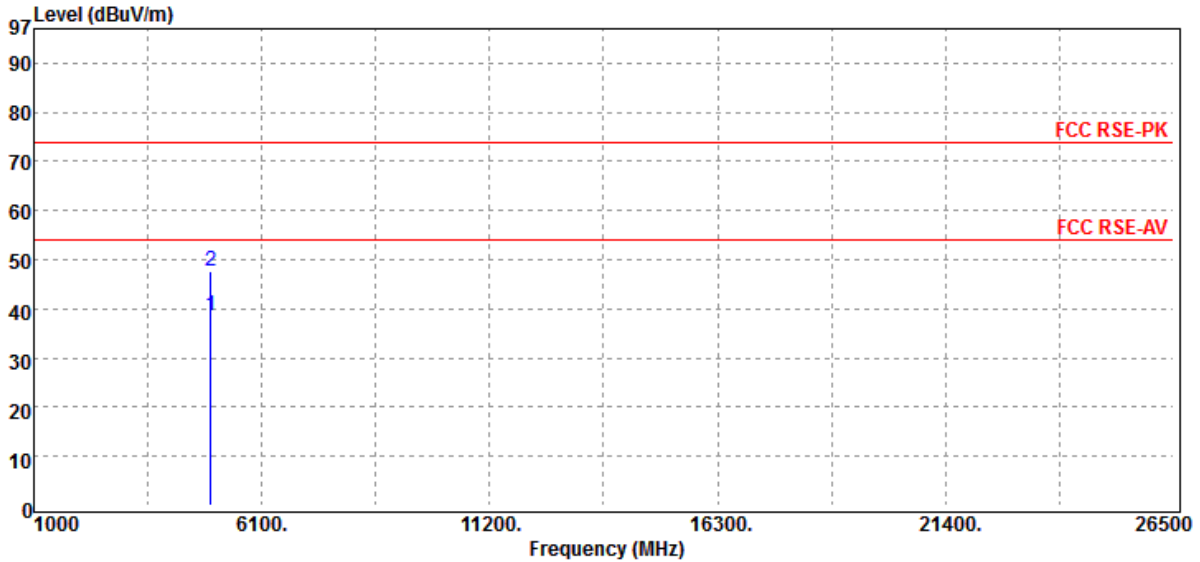

| Freq.   | Note    | Detector Mode | Spectrum Reading Level | Factor | Actual FS | Limit @3m | Margin |
|---------|---------|---------------|------------------------|--------|-----------|-----------|--------|
| MHz     | F/H/E/S | PK/QP/AV      | dBµV                   | dB     | dBµV/m    | dBµV/m    | dB     |
| 4960.00 | H       | Average       | 28.61                  | 9.86   | 38.47     | 54.00     | -15.53 |
| 4960.00 | H       | Peak          | 37.87                  | 9.86   | 47.73     | 74.00     | -26.27 |

Unless otherwise stated the results shown in this test report refer only to the sample(s) tested and such sample(s) are retained for 90 days only.

除非另有說明，此報告結果僅對測試之樣品負責，同時此樣品僅保留90天。本報告未經本公司書面許可，不可部份複製。

This document is issued by the Company subject to its General Conditions of Service printed overleaf, available on request or accessible at [www.sgs.com/terms\\_and\\_conditions.htm](http://www.sgs.com/terms_and_conditions.htm) and, for electronic format documents, subject to Terms and Conditions for Electronic Documents at [www.sgs.com/terms\\_e-document.htm](http://www.sgs.com/terms_e-document.htm). Attention is drawn to the limitation of liability, indemnification and jurisdiction issues defined therein. Any holder of this document is advised that information contained hereon reflects the Company's findings at the time of its intervention only and within the limits of Client's instructions, if any. The Company's sole responsibility is to its Client and this document does not exonerate parties to a transaction from exercising all their rights and obligations under the transaction documents. This document cannot be reproduced except in full, without prior written approval of the Company. Any unauthorized alteration, forgery or falsification of the content or appearance of this document is unlawful and offenders may be prosecuted to the fullest extent of the law.

SGS Taiwan Ltd.

No.134,WuKungRoad,NewTaipeiIndustrialPark,WukuDistrict,NewTaipeiCity,Taiwan24803/新北市五股區新北產業園區五工路 134 號

台灣檢驗科技股份有限公司

t (886-2) 2299-3279

f (886-2) 2298-0488

www.tw.sgs.com

Member of SGS Group



## 11. FREQUENCY SEPARATION

### 11.1. Standard Applicable

Frequency hopping systems shall have hopping channel carrier frequencies separated by minimum of 25 kHz or the  $\frac{2}{3} * 20\text{dB}$  bandwidth of the hopping channel, whichever is greater.

### 11.2. Measurement Equipment Used

| Conducted Emission Test Site |               |              |               |            |            |
|------------------------------|---------------|--------------|---------------|------------|------------|
| EQUIPMENT TYPE               | MFR           | MODEL NUMBER | SERIAL NUMBER | LAST CAL.  | CAL DUE.   |
| Spectrum Analyzer            | Agilent       | E4446A       | MY51100003    | 01/29/2015 | 01/28/2016 |
| DC Block                     | Mini-Circuits | BLK-18-S+    | 1             | 01/02/2015 | 01/01/2016 |
| Attenuator                   | Mini-Circuit  | BW-S10W2+    | 002           | 01/02/2015 | 01/01/2016 |
| Splitter                     | Agilent       | 11636B       | N/A           | 01/02/2015 | 01/01/2016 |

### 11.3. Test Set-up

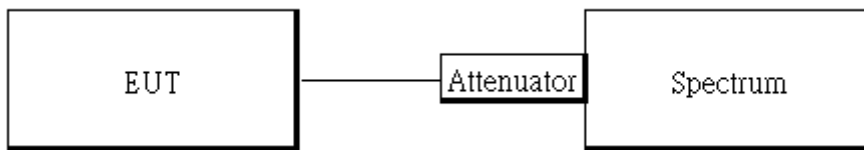

### 11.4. Measurement Procedure

1. Place the EUT on the table and set it in transmitting mode.
2. The testing follows FCC Public Notice DA 00-705 Measurement Guidelines.
3. Remove the antenna from the EUT and then connect a low loss RF cable from the antenna port to the spectrum analyzer.
4. Set center frequency of spectrum analyzer = middle of hopping channel.
5. Set the spectrum analyzer as RBW, VBW=100 kHz, Adjust Span to 5MHz, Sweep = auto.
6. Max hold. Mark 3 Peaks of hopping channel and record the 3 peaks frequency.

Unless otherwise stated the results shown in this test report refer only to the sample(s) tested and such sample(s) are retained for 90 days only.

除非另有說明，此報告結果僅對測試之樣品負責，同時此樣品僅保留90天。本報告未經本公司書面許可，不可部份複製。

This document is issued by the Company subject to its General Conditions of Service printed overleaf, available on request or accessible at [www.sgs.com/terms\\_and\\_conditions.htm](http://www.sgs.com/terms_and_conditions.htm) and, for electronic format documents, subject to Terms and Conditions for Electronic Documents at [www.sgs.com/terms\\_e-document.htm](http://www.sgs.com/terms_e-document.htm). Attention is drawn to the limitation of liability, indemnification and jurisdiction issues defined therein. Any holder of this document is advised that information contained hereon reflects the Company's findings at the time of its intervention only and within the limits of Client's instructions, if any. The Company's sole responsibility is to its Client and this document does not exonerate parties to a transaction from exercising all their rights and obligations under the transaction documents. This document cannot be reproduced except in full, without prior written approval of the Company. Any unauthorized alteration, forgery or falsification of the content or appearance of this document is unlawful and offenders may be prosecuted to the fullest extent of the law.

SGS Taiwan Ltd.

No.134,WuKungRoad,NewTaipeiIndustrialPark,WukuDistrict,NewTaipeiCity,Taiwan24803/新北市五股區新北產業園區五工路 134 號

台灣檢驗科技股份有限公司

t (886-2) 2299-3279

f (886-2) 2298-0488

www.tw.sgs.com

Member of SGS Group

### 11.5. Measurement Result

| Channel separation (MHz) | Limit  | Result |
|--------------------------|--|--------|
| 1                        | $\geq 25$ kHz or<br>2/3 times 20dB bandwidth | PASS   |

### Frequency Separation Test Data

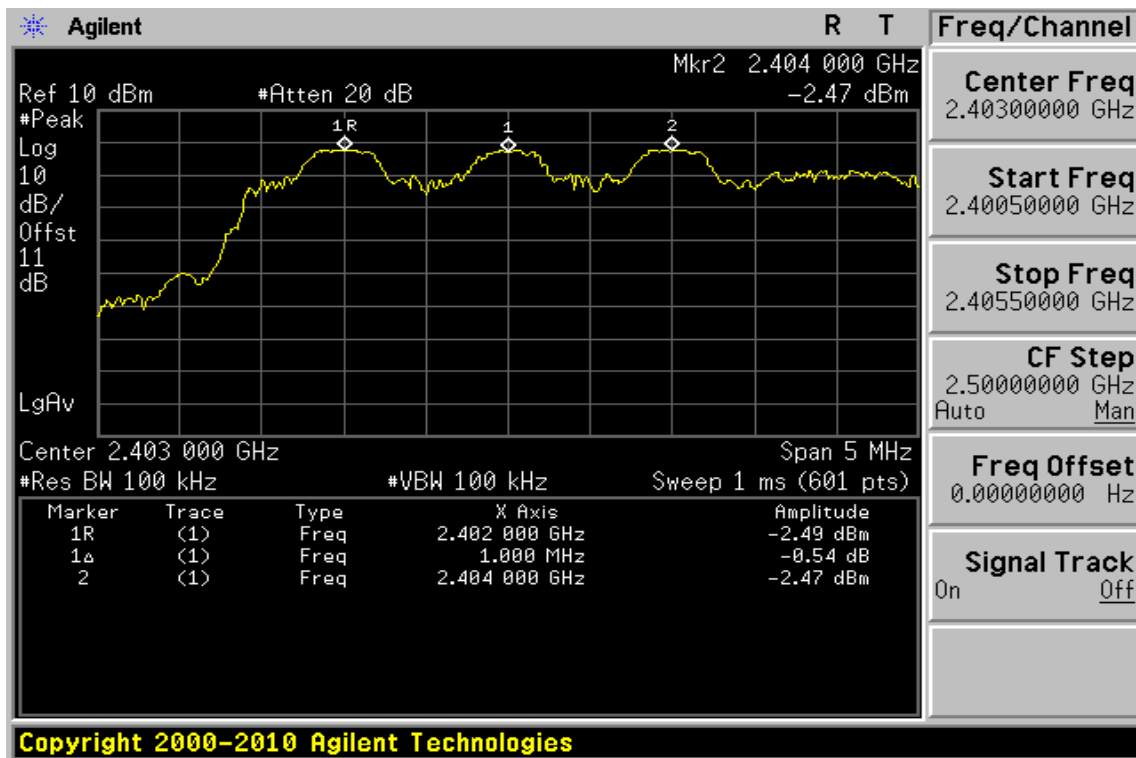

Unless otherwise stated the results shown in this test report refer only to the sample(s) tested and such sample(s) are retained for 90 days only.

除非另有說明，此報告結果僅對測試之樣品負責，同時此樣品僅保留90天。本報告未經本公司書面許可，不可部份複製。

This document is issued by the Company subject to its General Conditions of Service printed overleaf, available on request or accessible at [www.sgs.com/terms\\_and\\_conditions.htm](http://www.sgs.com/terms_and_conditions.htm) and, for electronic format documents, subject to Terms and Conditions for Electronic Documents at [www.sgs.com/terms\\_e-document.htm](http://www.sgs.com/terms_e-document.htm). Attention is drawn to the limitation of liability, indemnification and jurisdiction issues defined therein. Any holder of this document is advised that information contained hereon reflects the Company's findings at the time of its intervention only and within the limits of Client's instructions, if any. The Company's sole responsibility is to its Client and this document does not exonerate parties to a transaction from exercising all their rights and obligations under the transaction documents. This document cannot be reproduced except in full, without prior written approval of the Company. Any unauthorized alteration, forgery or falsification of the content or appearance of this document is unlawful and offenders may be prosecuted to the fullest extent of the law.

SGS Taiwan Ltd.

No.134,WuKungRoad,NewTaipeiIndustrialPark,WukuDistrict,NewTaipeiCity,Taiwan24803/新北市五股區新北產業園區五工路 134 號

台灣檢驗科技股份有限公司

t (886-2) 2299-3279

f (886-2) 2298-0488

www.tw.sgs.com

Member of SGS Group

## 12. NUMBER OF HOPPING FREQUENCY

### 12.1. Standard Applicable

Frequency hopping systems operating in the 2400MHz-2483.5 MHz bands shall use at least 15 hopping frequencies.

### 12.2. Measurement Equipment Used

| Conducted Emission Test Site |               |              |               |            |            |
|------------------------------|---------------|--------------|---------------|------------|------------|
| EQUIPMENT TYPE               | MFR           | MODEL NUMBER | SERIAL NUMBER | LAST CAL.  | CAL DUE.   |
| Spectrum Analyzer            | Agilent       | E4446A       | MY51100003    | 01/29/2015 | 01/28/2016 |
| DC Block                     | Mini-Circuits | BLK-18-S+    | 1             | 01/02/2015 | 01/01/2016 |
| Attenuator                   | Mini-Circuit  | BW-S10W2+    | 002           | 01/02/2015 | 01/01/2016 |
| Splitter                     | Agilent       | 11636B       | N/A           | 01/02/2015 | 01/01/2016 |

### 12.3. Test Set-up

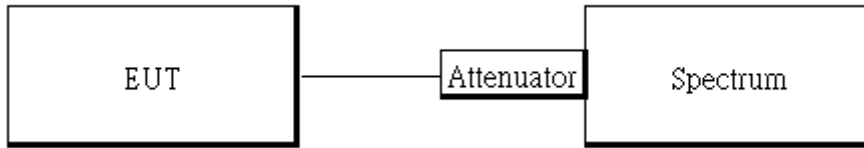

### 12.4. Measurement Procedure

1. Place the EUT on the table and set it in transmitting mode.
2. The testing follows FCC Public Notice DA 00-705 Measurement Guidelines.
3. Remove the antenna from the EUT and then connect a low loss RF cable from the antenna port to the spectrum analyzer.
4. Set spectrum analyzer Start=2400MHz, Stop = 2483.5MHz, Sweep = auto.
5. Set the spectrum analyzer as RBW=430 kHz, VBW=1.5MHz., Detector = Peak
6. Max hold, view and count how many channel in the band.

### 12.5. Measurement Result

#### Tabular Data of Total Channel Number

|                       | Channel Number | Limit |
|-----------------------|----------------|-------|
| 2.4 GHz – 2.441GHz    | 40             | >15   |
| 2.441 GHz – 2.4835GHz | 39             |       |
| 2.4GHz ~2.4835GHz     | (40+39) = 79   |       |

Unless otherwise stated the results shown in this test report refer only to the sample(s) tested and such sample(s) are retained for 90 days only.

除非另有說明，此報告結果僅對測試之樣品負責，同時此樣品僅保留90天。本報告未經本公司書面許可，不可部份複製。

This document is issued by the Company subject to its General Conditions of Service printed overleaf, available on request or accessible at [www.sgs.com/terms\\_and\\_conditions.htm](http://www.sgs.com/terms_and_conditions.htm) and, for electronic format documents, subject to Terms and Conditions for Electronic Documents at [www.sgs.com/terms\\_e-document.htm](http://www.sgs.com/terms_e-document.htm). Attention is drawn to the limitation of liability, indemnification and jurisdiction issues defined therein. Any holder of this document is advised that information contained hereon reflects the Company's findings at the time of its intervention only and within the limits of Client's instructions, if any. The Company's sole responsibility is to its Client and this document does not exonerate parties to a transaction from exercising all their rights and obligations under the transaction documents. This document cannot be reproduced except in full, without prior written approval of the Company. Any unauthorized alteration, forgery or falsification of the content or appearance of this document is unlawful and offenders may be prosecuted to the fullest extent of the law.

Channel Number

2.4 GHz – 2.441GHz

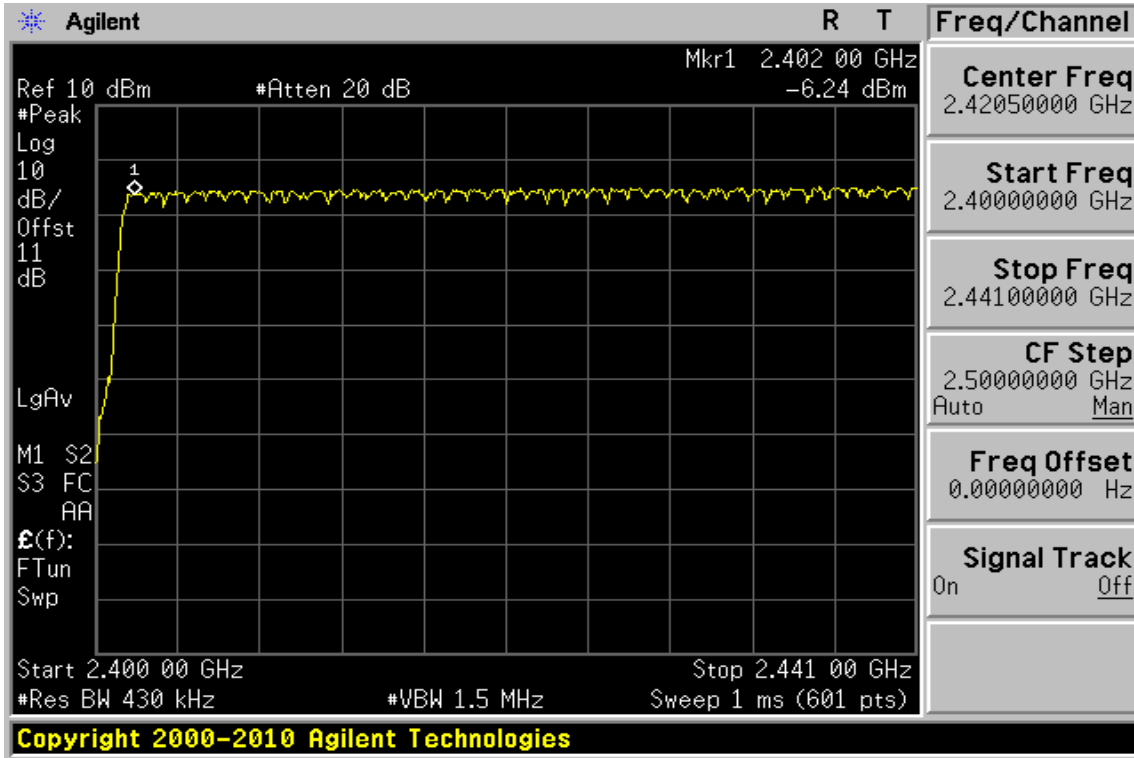

2.441 GHz – 2.4835GHz

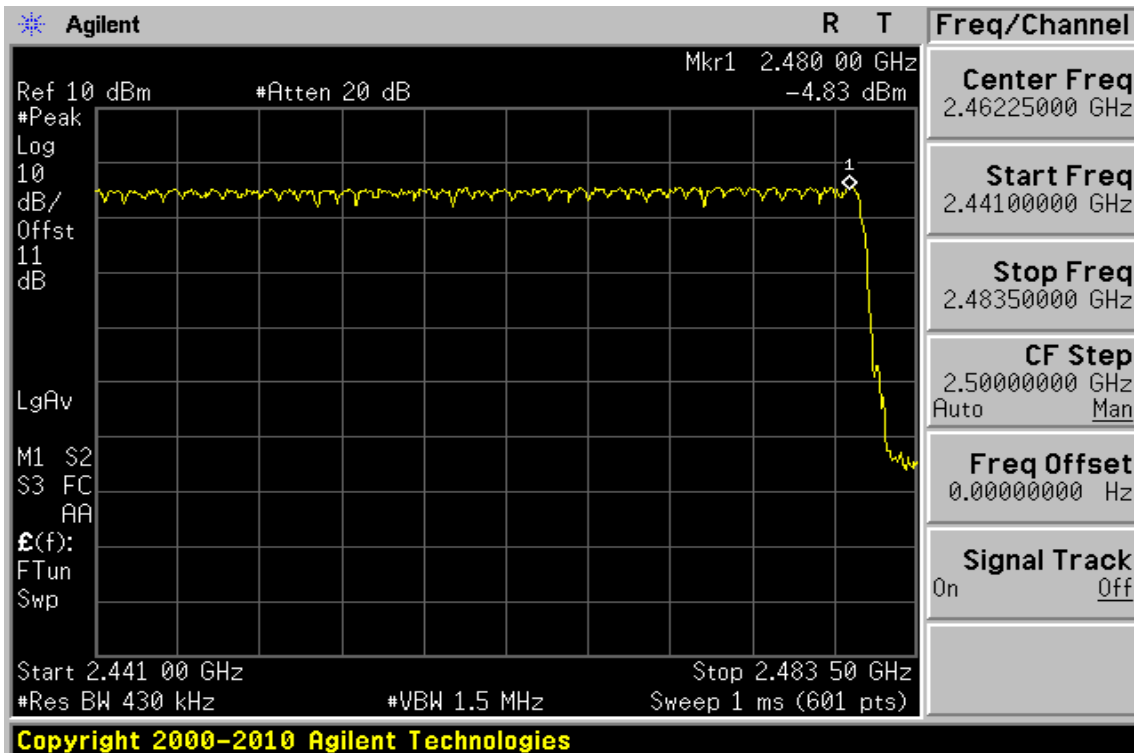

Unless otherwise stated the results shown in this test report refer only to the sample(s) tested and such sample(s) are retained for 90 days only.

除非另有說明，此報告結果僅對測試之樣品負責，同時此樣品僅保留90天。本報告未經本公司書面許可，不可部份複製。

This document is issued by the Company subject to its General Conditions of Service printed overleaf, available on request or accessible at [www.sgs.com/terms\\_and\\_conditions.htm](http://www.sgs.com/terms_and_conditions.htm) and, for electronic format documents, subject to Terms and Conditions for Electronic Documents at [www.sgs.com/terms\\_e-document.htm](http://www.sgs.com/terms_e-document.htm). Attention is drawn to the limitation of liability, indemnification and jurisdiction issues defined therein. Any holder of this document is advised that information contained hereon reflects the Company's findings at the time of its intervention only and within the limits of Client's instructions, if any. The Company's sole responsibility is to its Client and this document does not exonerate parties to a transaction from exercising all their rights and obligations under the transaction documents. This document cannot be reproduced except in full, without prior written approval of the Company. Any unauthorized alteration, forgery or falsification of the content or appearance of this document is unlawful and offenders may be prosecuted to the fullest extent of the law.

SGS Taiwan Ltd.

No.134,WuKungRoad,NewTaipeiIndustrialPark,WukuDistrict,NewTaipeiCity,Taiwan24803/新北市五股區新北產業園區五工路 134 號

台灣檢驗科技股份有限公司

t (886-2) 2299-3279

f (886-2) 2298-0488

www.tw.sgs.com

Member of SGS Group

### 13. TIME OF OCCUPANCY (DWELL TIME)

#### 13.1. Standard Applicable

Frequency hopping systems operating in the 2400MHz-2483.5MHz. The average time of occupancy on any frequency shall not greater than 0.4 s within period of 0.4 seconds multiplied by the number of hopping channel employed.

#### 13.2. Measurement Equipment Used

| Conducted Emission Test Site |               |              |               |            |            |
|------------------------------|---------------|--------------|---------------|------------|------------|
| EQUIPMENT TYPE               | MFR           | MODEL NUMBER | SERIAL NUMBER | LAST CAL.  | CAL DUE.   |
| Spectrum Analyzer            | Agilent       | E4446A       | MY51100003    | 01/29/2015 | 01/28/2016 |
| DC Block                     | Mini-Circuits | BLK-18-S+    | 1             | 01/02/2015 | 01/01/2016 |
| Attenuator                   | Mini-Circuit  | BW-S10W2+    | 002           | 01/02/2015 | 01/01/2016 |
| Splitter                     | Agilent       | 11636B       | N/A           | 01/02/2015 | 01/01/2016 |

#### 13.3. Test Set-up

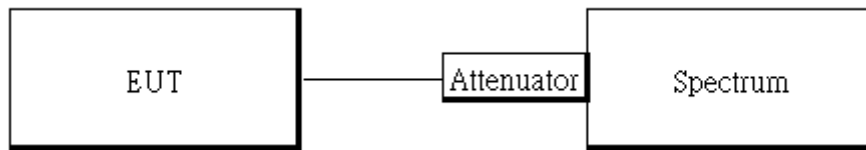

Unless otherwise stated the results shown in this test report refer only to the sample(s) tested and such sample(s) are retained for 90 days only.

除非另有說明，此報告結果僅對測試之樣品負責，同時此樣品僅保留90天。本報告未經本公司書面許可，不可部份複製。

This document is issued by the Company subject to its General Conditions of Service printed overleaf, available on request or accessible at [www.sgs.com/terms\\_and\\_conditions.htm](http://www.sgs.com/terms_and_conditions.htm) and, for electronic format documents, subject to Terms and Conditions for Electronic Documents at [www.sgs.com/terms\\_e-document.htm](http://www.sgs.com/terms_e-document.htm). Attention is drawn to the limitation of liability, indemnification and jurisdiction issues defined therein. Any holder of this document is advised that information contained hereon reflects the Company's findings at the time of its intervention only and within the limits of Client's instructions, if any. The Company's sole responsibility is to its Client and this document does not exonerate parties to a transaction from exercising all their rights and obligations under the transaction documents. This document cannot be reproduced except in full, without prior written approval of the Company. Any unauthorized alteration, forgery or falsification of the content or appearance of this document is unlawful and offenders may be prosecuted to the fullest extent of the law.

SGS Taiwan Ltd.

No.134,WuKungRoad,NewTaipeiIndustrialPark,WukuDistrict,NewTaipeiCity,Taiwan24803/新北市五股區新北產業園區五工路 134 號

台灣檢驗科技股份有限公司

t (886-2) 2299-3279

f (886-2) 2298-0488

www.tw.sgs.com

Member of SGS Group

### 13.4. Measurement Procedure

1. Place the EUT on the table and set it in transmitting mode.
2. The testing follows FCC Public Notice DA 00-705 Measurement Guidelines.
3. Remove the antenna from the EUT and then connect a low loss RF cable from the antenna port to the spectrum analyzer.
4. Set center frequency of spectrum analyzer = operating frequency.
5. Set the spectrum analyzer as RBW, VBW=1MHz, 3MHz, Span = 0Hz , Detector = Peak, Adjust Sweep = 2~8ms.
6. Repeat above procedures until all frequency of the interest measured were complete.

Formula Deduced: time occupancy of one time slot X Hopping rate / total slot in one channel / total channel that hops X period of working channels.

Where, standard hopping rate is 1600 hops/s, slot in one channel for DH1, DH3, and DH5 is 2, 4, and 6, respectively.

DH1 consists of single time slot of the uplink, and one slot of the downlink Total Slot: 2

DH3 consists of three time slot of the uplink, and one slot of the downlink. Total Slot: 4

DH5 consists of five time slot of the uplink, and one slot of the downlink. Total Slot: 6

In AFH mode, hopping rate is 800 hop/s with 6 slots in 20 hopping channels with channel hopping rate (800 / 6 / 20) in Occupancy Time Limit (0.4 \* 20) (S), Hop Over Occupancy Time comes to (800 / 6 / 20) \* (0.4 \* 20) = 53.33

Note: the result of the complete test default channel at 1Mbps is recorded on the test report, 2Mbps, and 3Mbps only records the measurement result at middle channel that reveals no much deviation.

Unless otherwise stated the results shown in this test report refer only to the sample(s) tested and such sample(s) are retained for 90 days only.

除非另有說明，此報告結果僅對測試之樣品負責，同時此樣品僅保留90天。本報告未經本公司書面許可，不可部份複製。

This document is issued by the Company subject to its General Conditions of Service printed overleaf, available on request or accessible at [www.sgs.com/terms\\_and\\_conditions.htm](http://www.sgs.com/terms_and_conditions.htm) and, for electronic format documents, subject to Terms and Conditions for Electronic Documents at [www.sgs.com/terms\\_e-document.htm](http://www.sgs.com/terms_e-document.htm). Attention is drawn to the limitation of liability, indemnification and jurisdiction issues defined therein. Any holder of this document is advised that information contained hereon reflects the Company's findings at the time of its intervention only and within the limits of Client's instructions, if any. The Company's sole responsibility is to its Client and this document does not exonerate parties to a transaction from exercising all their rights and obligations under the transaction documents. This document cannot be reproduced except in full, without prior written approval of the Company. Any unauthorized alteration, forgery or falsification of the content or appearance of this document is unlawful and offenders may be prosecuted to the fullest extent of the law.

SGS Taiwan Ltd.

No.134,WuKungRoad,NewTaipeiIndustrialPark,WukuDistrict,NewTaipeiCity,Taiwan24803/新北市五股區新北產業園區五工路 134 號

台灣檢驗科技股份有限公司

t (886-2) 2299-3279

f (886-2) 2298-0488

[www.tw.sgs.com](http://www.tw.sgs.com)

Member of SGS Group

**13.5. Tabular Result of the Measurement**

| <b>GFSK (1Mbps)</b>     |                    |                                    |                       |
|-------------------------|--------------------|------------------------------------|-----------------------|
| <b>Channel</b>          | <b>PACKET TYPE</b> | <b>Measurement Result<br/>(ms)</b> | <b>Limit<br/>(ms)</b> |
| 0                       | DH1                | 122.56                             | 400ms                 |
|                         | DH3                | 261.28                             | 400ms                 |
|                         | DH5                | 306.13                             | 400ms                 |
| 39                      | DH1                | 122.56                             | 400ms                 |
|                         | DH3                | 261.28                             | 400ms                 |
|                         | DH5                | 306.13                             | 400ms                 |
| 78                      | DH1                | 122.56                             | 400ms                 |
|                         | DH3                | 261.28                             | 400ms                 |
|                         | DH5                | 306.13                             | 400ms                 |
| <b>/4 DQPSK (2Mbps)</b> |                    |                                    |                       |
| <b>Channel</b>          | <b>PACKET TYPE</b> | <b>Measurement Result<br/>(ms)</b> | <b>Limit<br/>(ms)</b> |
| 0                       | DH1                | 122.56                             | 400ms                 |
|                         | DH3                | 262.72                             | 400ms                 |
|                         | DH5                | 306.13                             | 400ms                 |
| <b>8-DPSK (3Mbps)</b>   |                    |                                    |                       |
| <b>Channel</b>          | <b>PACKET TYPE</b> | <b>Measurement Result<br/>(ms)</b> | <b>Limit<br/>(ms)</b> |
| 0                       | DH1                | 122.56                             | 400ms                 |
|                         | DH3                | 261.28                             | 400ms                 |
|                         | DH5                | 306.13                             | 400ms                 |

Unless otherwise stated the results shown in this test report refer only to the sample(s) tested and such sample(s) are retained for 90 days only.

除非另有說明，此報告結果僅對測試之樣品負責，同時此樣品僅保留90天。本報告未經本公司書面許可，不可部份複製。

This document is issued by the Company subject to its General Conditions of Service printed overleaf, available on request or accessible at [www.sgs.com/terms\\_and\\_conditions.htm](http://www.sgs.com/terms_and_conditions.htm) and, for electronic format documents, subject to Terms and Conditions for Electronic Documents at [www.sgs.com/terms\\_e-document.htm](http://www.sgs.com/terms_e-document.htm). Attention is drawn to the limitation of liability, indemnification and jurisdiction issues defined therein. Any holder of this document is advised that information contained hereon reflects the Company's findings at the time of its intervention only and within the limits of Client's instructions, if any. The Company's sole responsibility is to its Client and this document does not exonerate parties to a transaction from exercising all their rights and obligations under the transaction documents. This document cannot be reproduced except in full, without prior written approval of the Company. Any unauthorized alteration, forgery or falsification of the content or appearance of this document is unlawful and offenders may be prosecuted to the fullest extent of the law.

SGS Taiwan Ltd.

No.134,WuKungRoad,NewTaipeiIndustrialPark,WukuDistrict,NewTaipeiCity,Taiwan24803/新北市五股區新北產業園區五工路 134 號

台灣檢驗科技股份有限公司

t (886-2) 2299-3279

f (886-2) 2298-0488

www.tw.sgs.com

Member of SGS Group

A period time = 0.4 (s) \* 79 = 31.6 (s)

**GFSK (1Mbps):**

|         |   |
|---------|---|
| CH Low  | DH1 time slot = 0.383 (ms) * (1600/2/79) * 31.6 = 122.56 (ms) |
|         | DH3 time slot = 1.633 (ms) * (1600/4/79) * 31.6 = 261.28 (ms) |
|         | DH5 time slot = 2.870 (ms) * (1600/6/79) * 31.6 = 306.13 (ms) |
| CH Mid  | DH1 time slot = 0.383 (ms) * (1600/2/79) * 31.6 = 122.56 (ms) |
|         | DH3 time slot = 1.633 (ms) * (1600/4/79) * 31.6 = 261.28 (ms) |
|         | DH5 time slot = 2.870 (ms) * (1600/6/79) * 31.6 = 306.13 (ms) |
| CH High | DH1 time slot = 0.383 (ms) * (1600/2/79) * 31.6 = 122.56 (ms) |
|         | DH3 time slot = 1.633 (ms) * (1600/4/79) * 31.6 = 261.28 (ms) |
|         | DH5 time slot = 2.870 (ms) * (1600/6/79) * 31.6 = 306.13 (ms) |

**1/4 -DQPSK (2Mbps):**

|        |  |
|--------|--|
| CH Mid | 2DH1 time slot = 0.383 (ms) * (1600/2/79) * 31.6 = 122.56 (ms) |
|        | 2DH3 time slot = 1.642 (ms) * (1600/4/79) * 31.6 = 262.72 (ms) |
|        | 2DH5 time slot = 2.870 (ms) * (1600/6/79) * 31.6 = 306.13 (ms) |

**8-DPSK (3Mbps):**

|        |  |
|--------|--|
| CH Mid | 3DH1 time slot = 0.383 (ms) * (1600/2/79) * 31.6 = 122.56 (ms) |
|        | 3DH3 time slot = 1.633 (ms) * (1600/4/79) * 31.6 = 261.28 (ms) |
|        | 3DH5 time slot = 2.870 (ms) * (1600/6/79) * 31.6 = 306.13 (ms) |

Unless otherwise stated the results shown in this test report refer only to the sample(s) tested and such sample(s) are retained for 90 days only.

除非另有說明，此報告結果僅對測試之樣品負責，同時此樣品僅保留90天。本報告未經本公司書面許可，不可部份複製。

This document is issued by the Company subject to its General Conditions of Service printed overleaf, available on request or accessible at [www.sgs.com/terms\\_and\\_conditions.htm](http://www.sgs.com/terms_and_conditions.htm) and, for electronic format documents, subject to Terms and Conditions for Electronic Documents at [www.sgs.com/terms\\_e-document.htm](http://www.sgs.com/terms_e-document.htm). Attention is drawn to the limitation of liability, indemnification and jurisdiction issues defined therein. Any holder of this document is advised that information contained hereon reflects the Company's findings at the time of its intervention only and within the limits of Client's instructions, if any. The Company's sole responsibility is to its Client and this document does not exonerate parties to a transaction from exercising all their rights and obligations under the transaction documents. This document cannot be reproduced except in full, without prior written approval of the Company. Any unauthorized alteration, forgery or falsification of the content or appearance of this document is unlawful and offenders may be prosecuted to the fullest extent of the law.



**AFH Mode:**

| <b>GFSK (1Mbps) for AFH Mode</b>   |                    |                                |                   |
|------------------------------------|--------------------|--------------------------------|-------------------|
| <b>Hopping Channel Number</b>      | <b>PACKET TYPE</b> | <b>Measurement Result (ms)</b> | <b>Limit (ms)</b> |
| 20                                 | DH5                | 153.07                         | 400ms             |
| <b>/4 DQPSK (2Mbps) for Mode</b>   |                    |                                |                   |
| <b>Hopping Channel Number</b>      | <b>PACKET TYPE</b> | <b>Measurement Result (ms)</b> | <b>Limit (ms)</b> |
| 20                                 | DH5                | 153.07                         | 400ms             |
| <b>8-DPSK (3Mbps) for AFH Mode</b> |                    |                                |                   |
| <b>Hopping Channel Number</b>      | <b>PACKET TYPE</b> | <b>Measurement Result (ms)</b> | <b>Limit (ms)</b> |
| 20                                 | DH5                | 153.07                         | 400ms             |

**GFSK (1Mbps):**

$$\text{DH5 time slot} = 2.87 \text{ (ms)} * (800/6/20) * 8 = 153.07 \text{ (ms)}$$

**/4 -DQPSK (2Mbps):**

$$2\text{DH5 time slot} = 2.87 \text{ (ms)} * (800/6/20) * 8 = 153.07 \text{ (ms)}$$

**8-DPSK (3Mbps):**

$$3\text{DH5 time slot} = 2.87 \text{ (ms)} * (800/6/20) * 8 = 153.07 \text{ (ms)}$$

**13.6. Measurement Result**

Note: Refer to next page for plots.

Unless otherwise stated the results shown in this test report refer only to the sample(s) tested and such sample(s) are retained for 90 days only.

除非另有說明，此報告結果僅對測試之樣品負責，同時此樣品僅保留90天。本報告未經本公司書面許可，不可部份複製。

This document is issued by the Company subject to its General Conditions of Service printed overleaf, available on request or accessible at [www.sgs.com/terms\\_and\\_conditions.htm](http://www.sgs.com/terms_and_conditions.htm) and, for electronic format documents, subject to Terms and Conditions for Electronic Documents at [www.sgs.com/terms\\_e-document.htm](http://www.sgs.com/terms_e-document.htm). Attention is drawn to the limitation of liability, indemnification and jurisdiction issues defined therein. Any holder of this document is advised that information contained hereon reflects the Company's findings at the time of its intervention only and within the limits of Client's instructions, if any. The Company's sole responsibility is to its Client and this document does not exonerate parties to a transaction from exercising all their rights and obligations under the transaction documents. This document cannot be reproduced except in full, without prior written approval of the Company. Any unauthorized alteration, forgery or falsification of the content or appearance of this document is unlawful and offenders may be prosecuted to the fullest extent of the law.

CH-Low

DH1

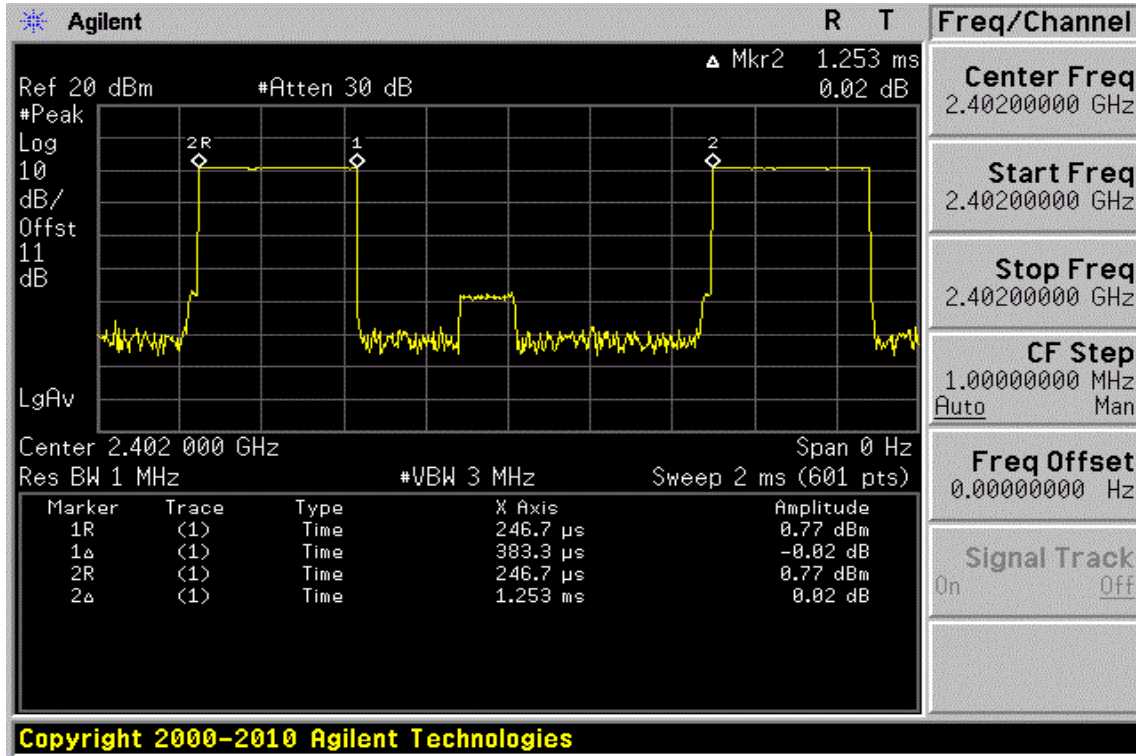

DH3

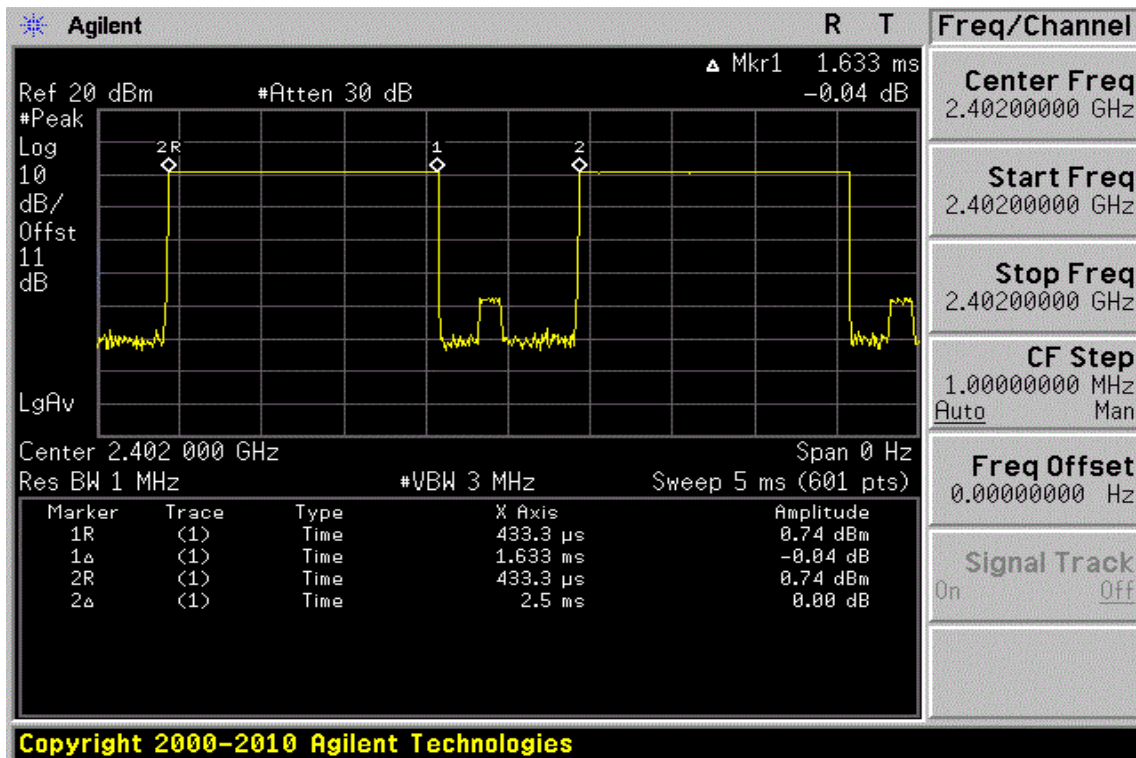

Unless otherwise stated the results shown in this test report refer only to the sample(s) tested and such sample(s) are retained for 90 days only.

除非另有說明，此報告結果僅對測試之樣品負責，同時此樣品僅保留90天。本報告未經本公司書面許可，不可部份複製。

This document is issued by the Company subject to its General Conditions of Service printed overleaf, available on request or accessible at [www.sgs.com/terms\\_and\\_conditions.htm](http://www.sgs.com/terms_and_conditions.htm) and, for electronic format documents, subject to Terms and Conditions for Electronic Documents at [www.sgs.com/terms\\_e-document.htm](http://www.sgs.com/terms_e-document.htm). Attention is drawn to the limitation of liability, indemnification and jurisdiction issues defined therein. Any holder of this document is advised that information contained hereon reflects the Company's findings at the time of its intervention only and within the limits of Client's instructions, if any. The Company's sole responsibility is to its Client and this document does not exonerate parties to a transaction from exercising all their rights and obligations under the transaction documents. This document cannot be reproduced except in full, without prior written approval of the Company. Any unauthorized alteration, forgery or falsification of the content or appearance of this document is unlawful and offenders may be prosecuted to the fullest extent of the law.

SGS Taiwan Ltd.

No.134,WuKungRoad,NewTaipeiIndustrialPark,WukuDistrict,NewTaipeiCity,Taiwan24803/新北市五股區新北產業園區五工路 134 號

台灣檢驗科技股份有限公司

t (886-2) 2299-3279

f (886-2) 2298-0488

www.tw.sgs.com

Member of SGS Group

DH5

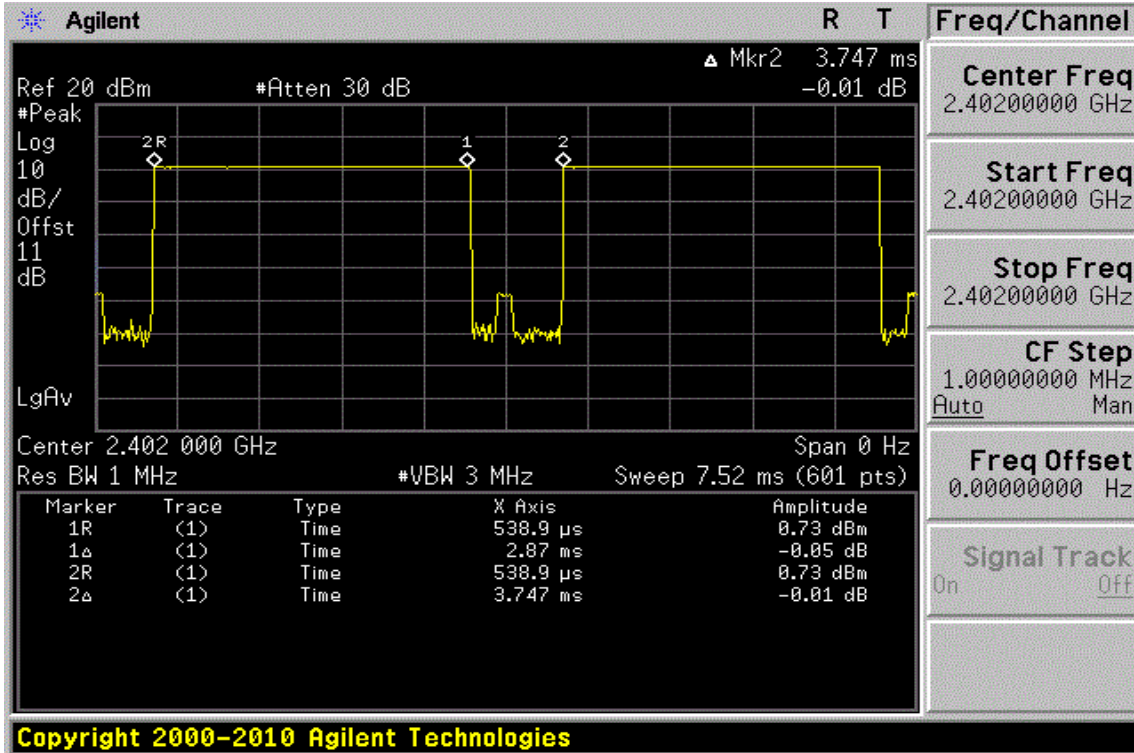

CH-Mid

DH1

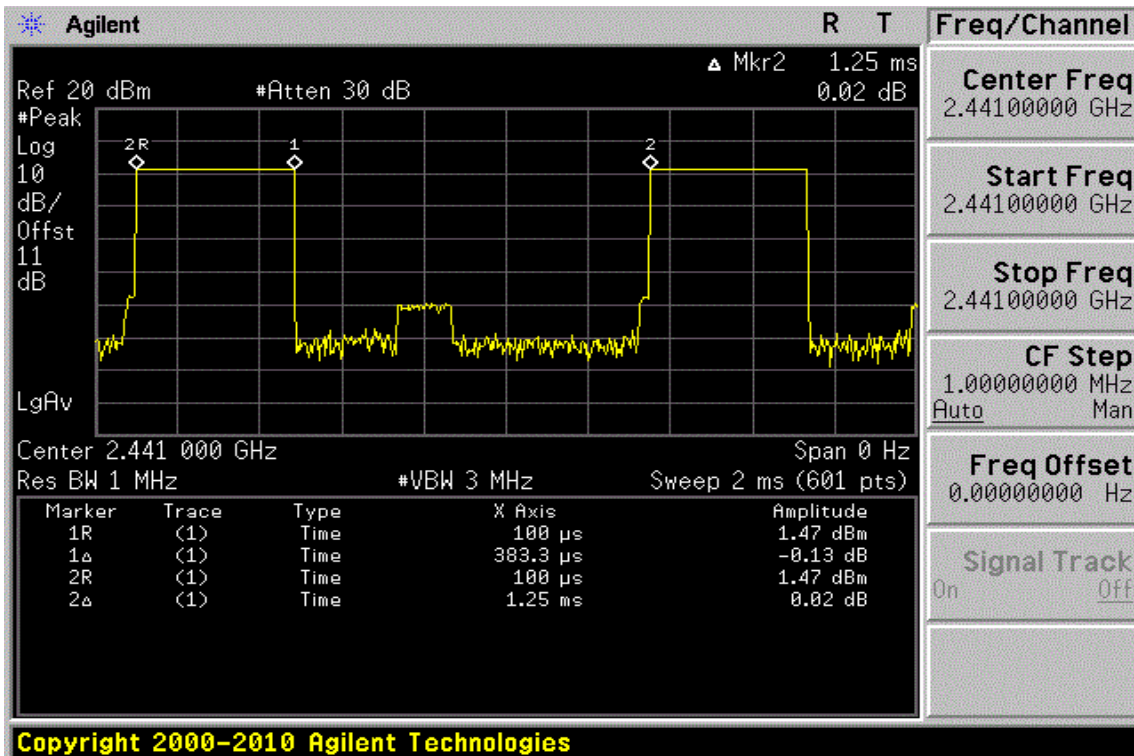

Unless otherwise stated the results shown in this test report refer only to the sample(s) tested and such sample(s) are retained for 90 days only.

除非另有說明，此報告結果僅對測試之樣品負責，同時此樣品僅保留90天。本報告未經本公司書面許可，不可部份複製。

This document is issued by the Company subject to its General Conditions of Service printed overleaf, available on request or accessible at [www.sgs.com/terms\\_and\\_conditions.htm](http://www.sgs.com/terms_and_conditions.htm) and, for electronic format documents, subject to Terms and Conditions for Electronic Documents at [www.sgs.com/terms\\_e-document.htm](http://www.sgs.com/terms_e-document.htm). Attention is drawn to the limitation of liability, indemnification and jurisdiction issues defined therein. Any holder of this document is advised that information contained hereon reflects the Company's findings at the time of its intervention only and within the limits of Client's instructions, if any. The Company's sole responsibility is to its Client and this document does not exonerate parties to a transaction from exercising all their rights and obligations under the transaction documents. This document cannot be reproduced except in full, without prior written approval of the Company. Any unauthorized alteration, forgery or falsification of the content or appearance of this document is unlawful and offenders may be prosecuted to the fullest extent of the law.

SGS Taiwan Ltd.

No. 134, WuKungRoad, NewTaipeiIndustrialPark, WukuDistrict, NewTaipeiCity, Taiwan24803/新北市五股區新北產業園區五工路 134 號

台灣檢驗科技股份有限公司

t (886-2) 2299-3279

f (886-2) 2298-0488

www.tw.sgs.com

Member of SGS Group



DH3

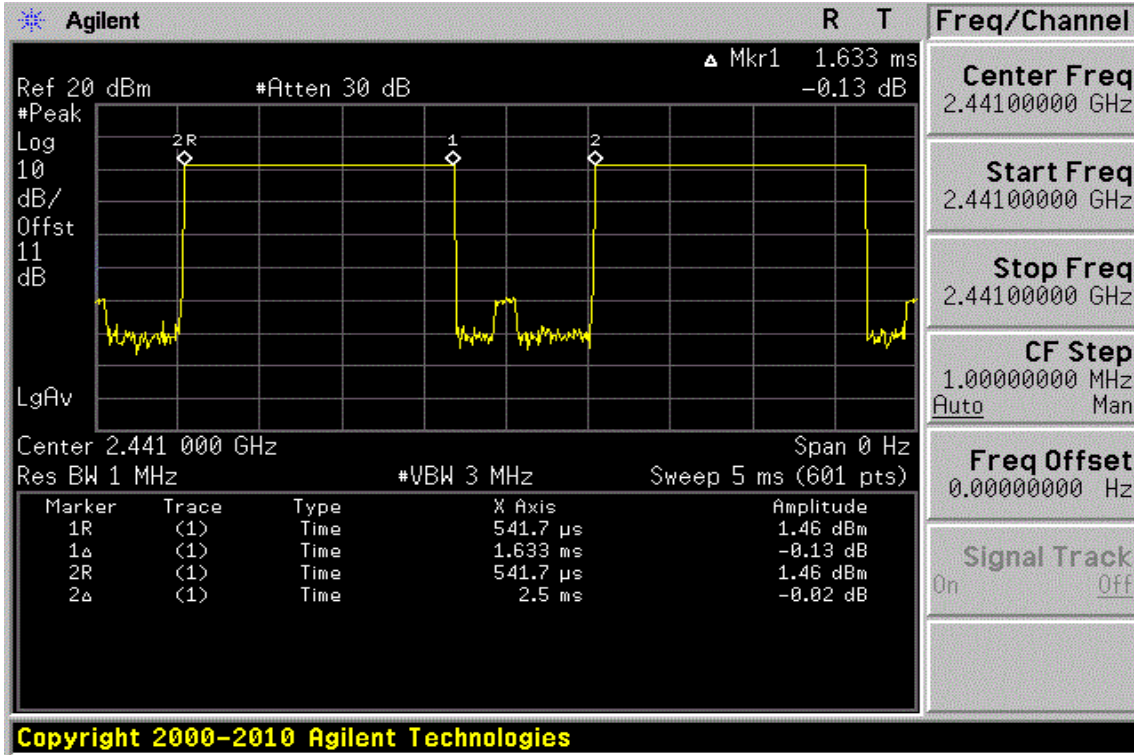

DH5

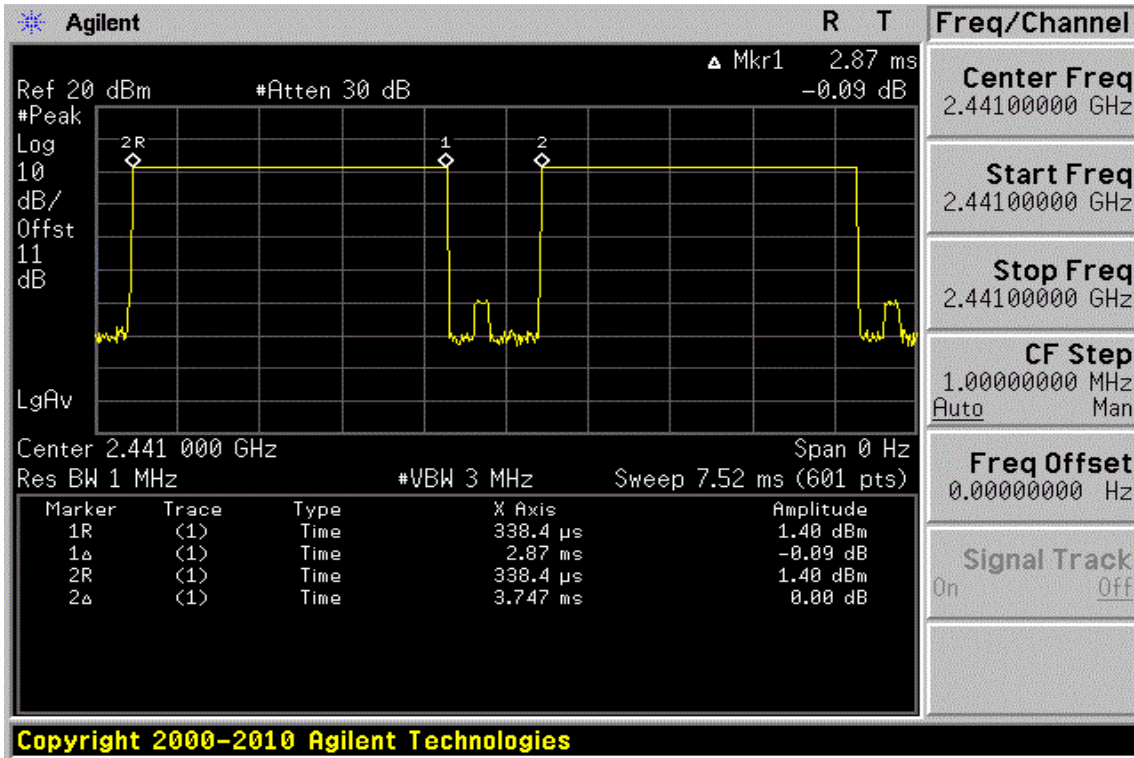

Unless otherwise stated the results shown in this test report refer only to the sample(s) tested and such sample(s) are retained for 90 days only.

除非另有說明，此報告結果僅對測試之樣品負責，同時此樣品僅保留90天。本報告未經本公司書面許可，不可部份複製。

This document is issued by the Company subject to its General Conditions of Service printed overleaf, available on request or accessible at [www.sgs.com/terms\\_and\\_conditions.htm](http://www.sgs.com/terms_and_conditions.htm) and, for electronic format documents, subject to Terms and Conditions for Electronic Documents at [www.sgs.com/terms\\_e-document.htm](http://www.sgs.com/terms_e-document.htm). Attention is drawn to the limitation of liability, indemnification and jurisdiction issues defined therein. Any holder of this document is advised that information contained hereon reflects the Company's findings at the time of its intervention only and within the limits of Client's instructions, if any. The Company's sole responsibility is to its Client and this document does not exonerate parties to a transaction from exercising all their rights and obligations under the transaction documents. This document cannot be reproduced except in full, without prior written approval of the Company. Any unauthorized alteration, forgery or falsification of the content or appearance of this document is unlawful and offenders may be prosecuted to the fullest extent of the law.

SGS Taiwan Ltd.

No.134,WuKungRoad,NewTaipeiIndustrialPark,WukuDistrict,NewTaipeiCity,Taiwan24803/新北市五股區新北產業園區五工路 134 號

台灣檢驗科技股份有限公司

t (886-2) 2299-3279

f (886-2) 2298-0488

www.tw.sgs.com

Member of SGS Group

**CH-High**

**DH1**

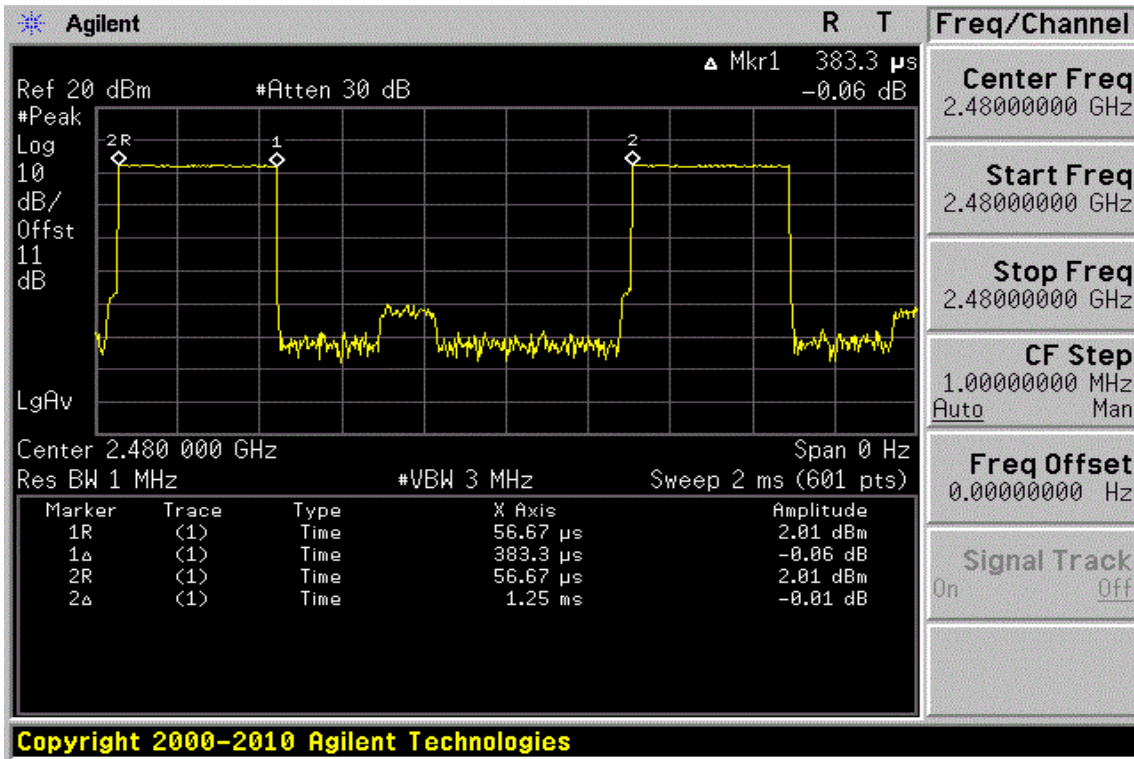

**DH3**

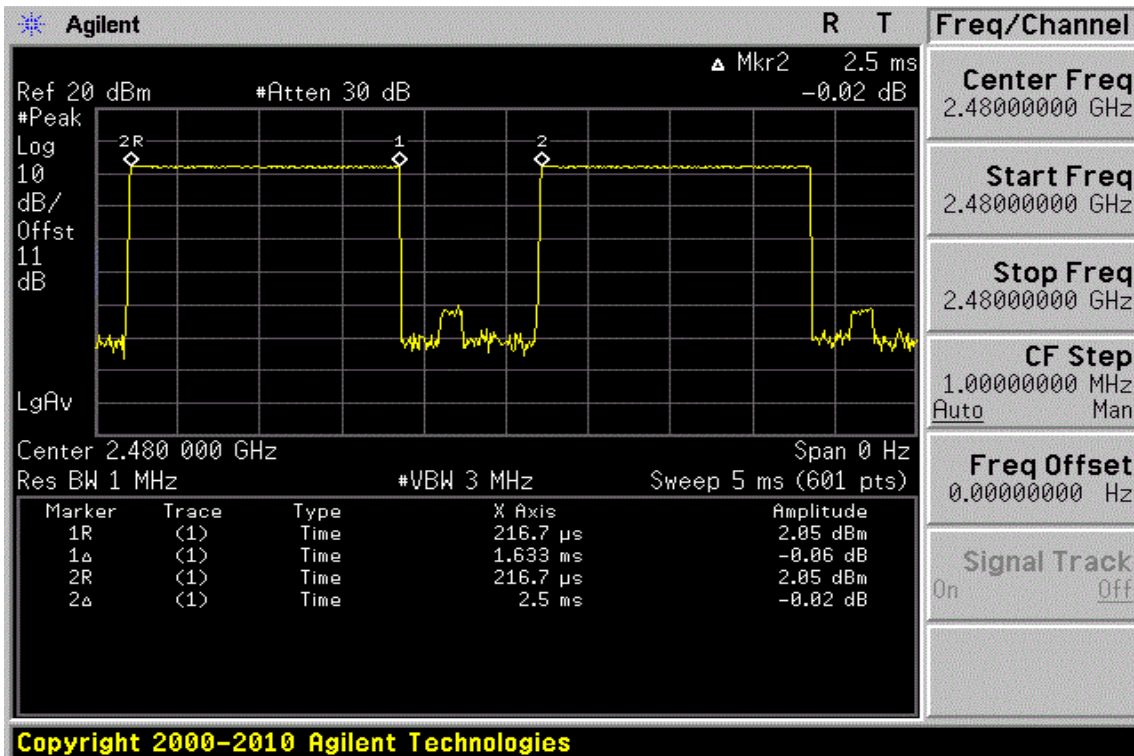

Unless otherwise stated the results shown in this test report refer only to the sample(s) tested and such sample(s) are retained for 90 days only.

除非另有說明，此報告結果僅對測試之樣品負責，同時此樣品僅保留90天。本報告未經本公司書面許可，不可部份複製。

This document is issued by the Company subject to its General Conditions of Service printed overleaf, available on request or accessible at [www.sgs.com/terms\\_and\\_conditions.htm](http://www.sgs.com/terms_and_conditions.htm) and, for electronic format documents, subject to Terms and Conditions for Electronic Documents at [www.sgs.com/terms\\_e-document.htm](http://www.sgs.com/terms_e-document.htm). Attention is drawn to the limitation of liability, indemnification and jurisdiction issues defined therein. Any holder of this document is advised that information contained hereon reflects the Company's findings at the time of its intervention only and within the limits of Client's instructions, if any. The Company's sole responsibility is to its Client and this document does not exonerate parties to a transaction from exercising all their rights and obligations under the transaction documents. This document cannot be reproduced except in full, without prior written approval of the Company. Any unauthorized alteration, forgery or falsification of the content or appearance of this document is unlawful and offenders may be prosecuted to the fullest extent of the law.

SGS Taiwan Ltd.

No.134,WuKungRoad,NewTaipeiIndustrialPark,WukuDistrict,NewTaipeiCity,Taiwan24803/新北市五股區新北產業園區五工路 134 號

台灣檢驗科技股份有限公司

t (886-2) 2299-3279

f (886-2) 2298-0488

www.tw.sgs.com

Member of SGS Group

DH5

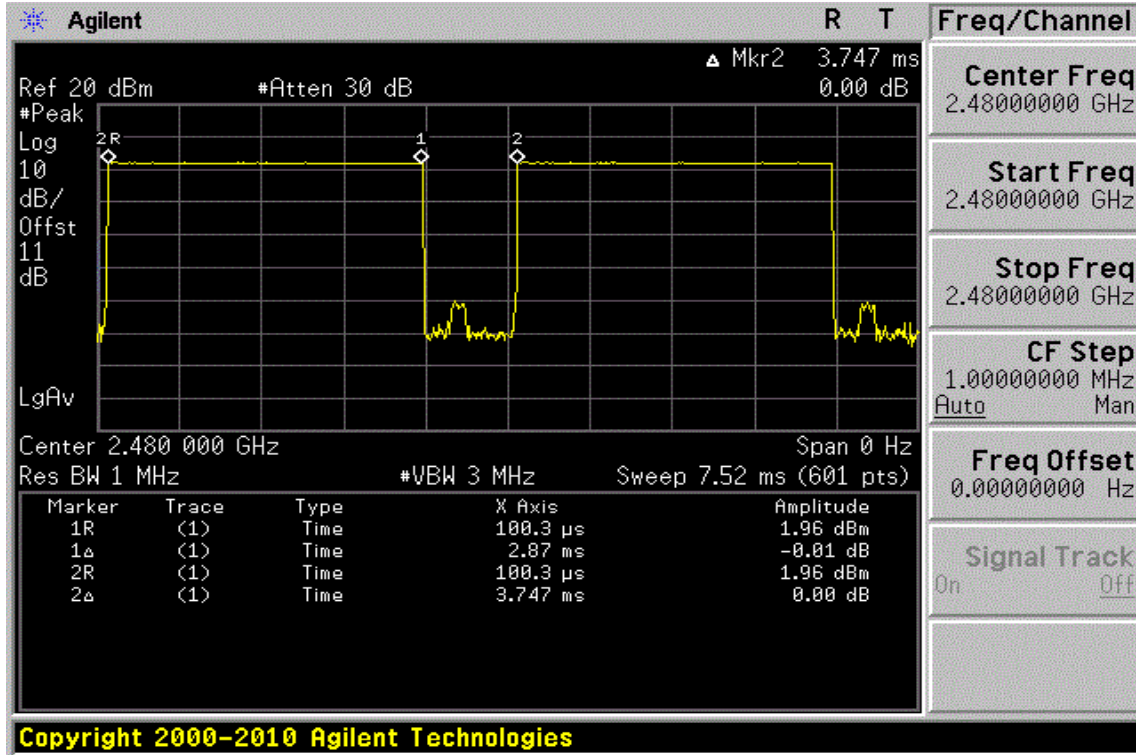

Unless otherwise stated the results shown in this test report refer only to the sample(s) tested and such sample(s) are retained for 90 days only.

除非另有說明，此報告結果僅對測試之樣品負責，同時此樣品僅保留90天。本報告未經本公司書面許可，不可部份複製。

This document is issued by the Company subject to its General Conditions of Service printed overleaf, available on request or accessible at [www.sgs.com/terms\\_and\\_conditions.htm](http://www.sgs.com/terms_and_conditions.htm) and, for electronic format documents, subject to Terms and Conditions for Electronic Documents at [www.sgs.com/terms\\_e-document.htm](http://www.sgs.com/terms_e-document.htm). Attention is drawn to the limitation of liability, indemnification and jurisdiction issues defined therein. Any holder of this document is advised that information contained hereon reflects the Company's findings at the time of its intervention only and within the limits of Client's instructions, if any. The Company's sole responsibility is to its Client and this document does not exonerate parties to a transaction from exercising all their rights and obligations under the transaction documents. This document cannot be reproduced except in full, without prior written approval of the Company. Any unauthorized alteration, forgery or falsification of the content or appearance of this document is unlawful and offenders may be prosecuted to the fullest extent of the law.

SGS Taiwan Ltd.

No.134,WuKungRoad,NewTaipeiIndustrialPark,WukuDistrict,NewTaipeiCity,Taiwan24803/新北市五股區新北產業園區五工路 134 號

台灣檢驗科技股份有限公司

t (886-2) 2299-3279

f (886-2) 2298-0488

www.tw.sgs.com

Member of SGS Group



CH-Mid

2DH1

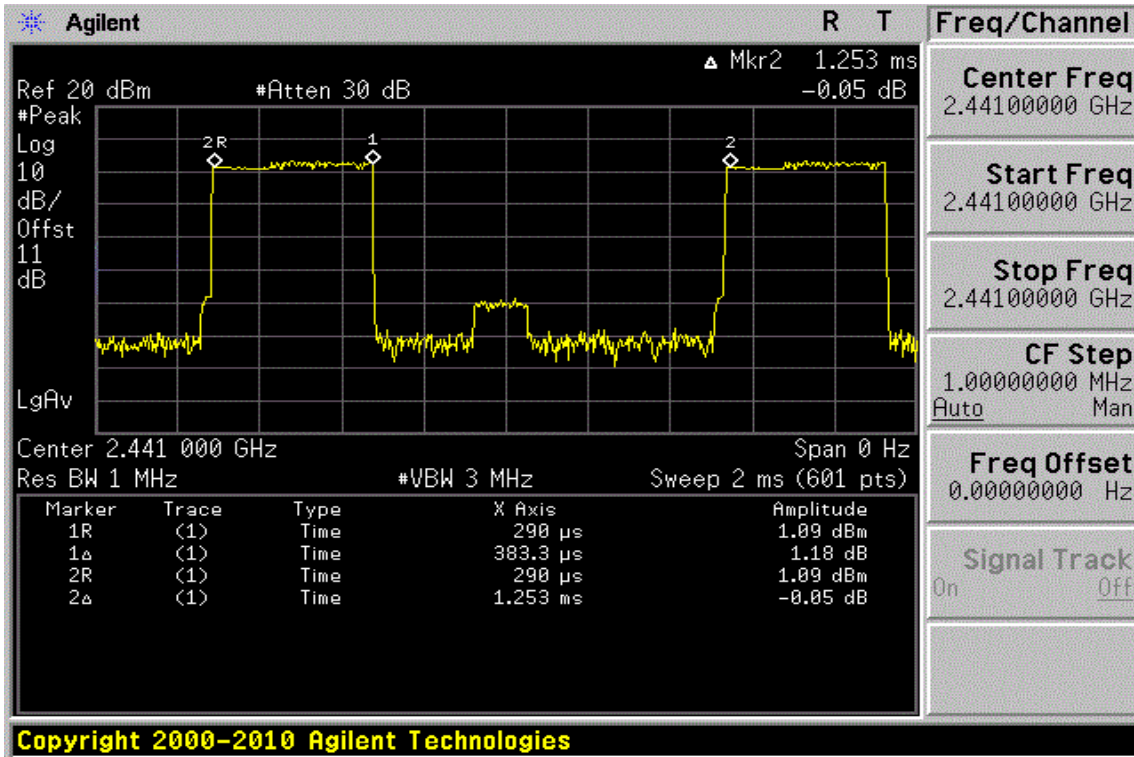

2DH3

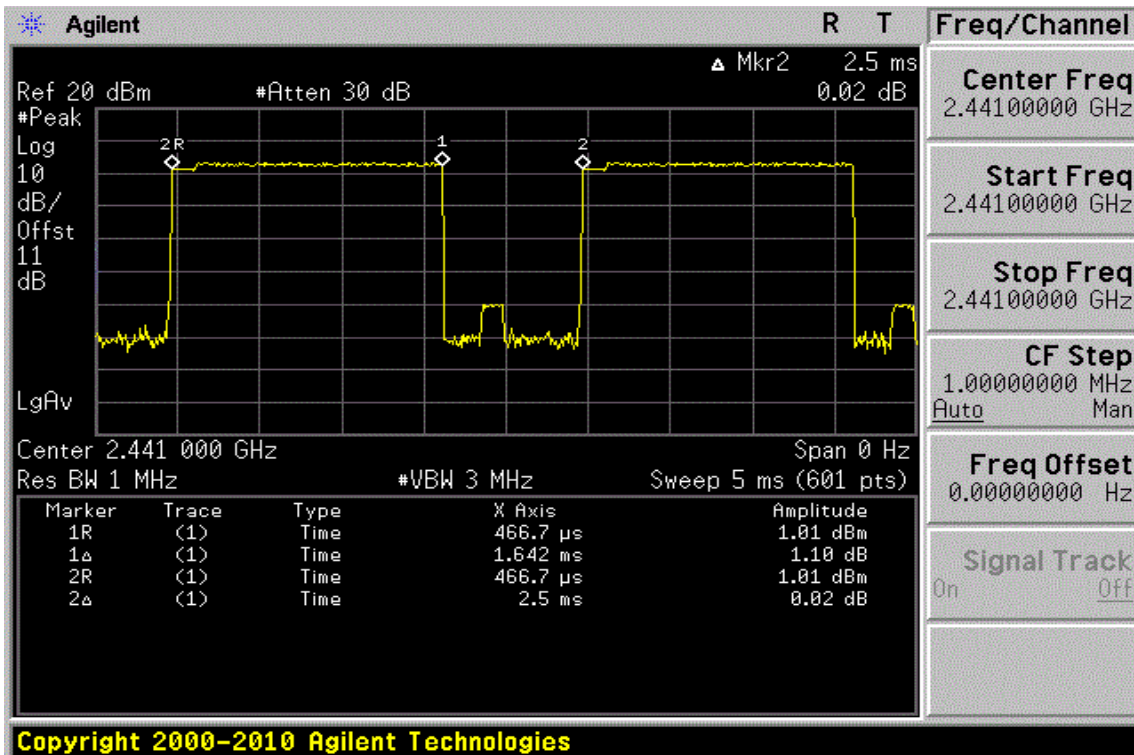

Unless otherwise stated the results shown in this test report refer only to the sample(s) tested and such sample(s) are retained for 90 days only.

除非另有說明，此報告結果僅對測試之樣品負責，同時此樣品僅保留90天。本報告未經本公司書面許可，不可部份複製。

This document is issued by the Company subject to its General Conditions of Service printed overleaf, available on request or accessible at [www.sgs.com/terms\\_and\\_conditions.htm](http://www.sgs.com/terms_and_conditions.htm) and, for electronic format documents, subject to Terms and Conditions for Electronic Documents at [www.sgs.com/terms\\_e-document.htm](http://www.sgs.com/terms_e-document.htm). Attention is drawn to the limitation of liability, indemnification and jurisdiction issues defined therein. Any holder of this document is advised that information contained hereon reflects the Company's findings at the time of its intervention only and within the limits of Client's instructions, if any. The Company's sole responsibility is to its Client and this document does not exonerate parties to a transaction from exercising all their rights and obligations under the transaction documents. This document cannot be reproduced except in full, without prior written approval of the Company. Any unauthorized alteration, forgery or falsification of the content or appearance of this document is unlawful and offenders may be prosecuted to the fullest extent of the law.

SGS Taiwan Ltd.

No.134,WuKungRoad,NewTaipeiIndustrialPark,WukuDistrict,NewTaipeiCity,Taiwan24803/新北市五股區新北產業園區五工路 134 號

台灣檢驗科技股份有限公司

t (886-2) 2299-3279

f (886-2) 2298-0488

www.tw.sgs.com

Member of SGS Group

2DH5

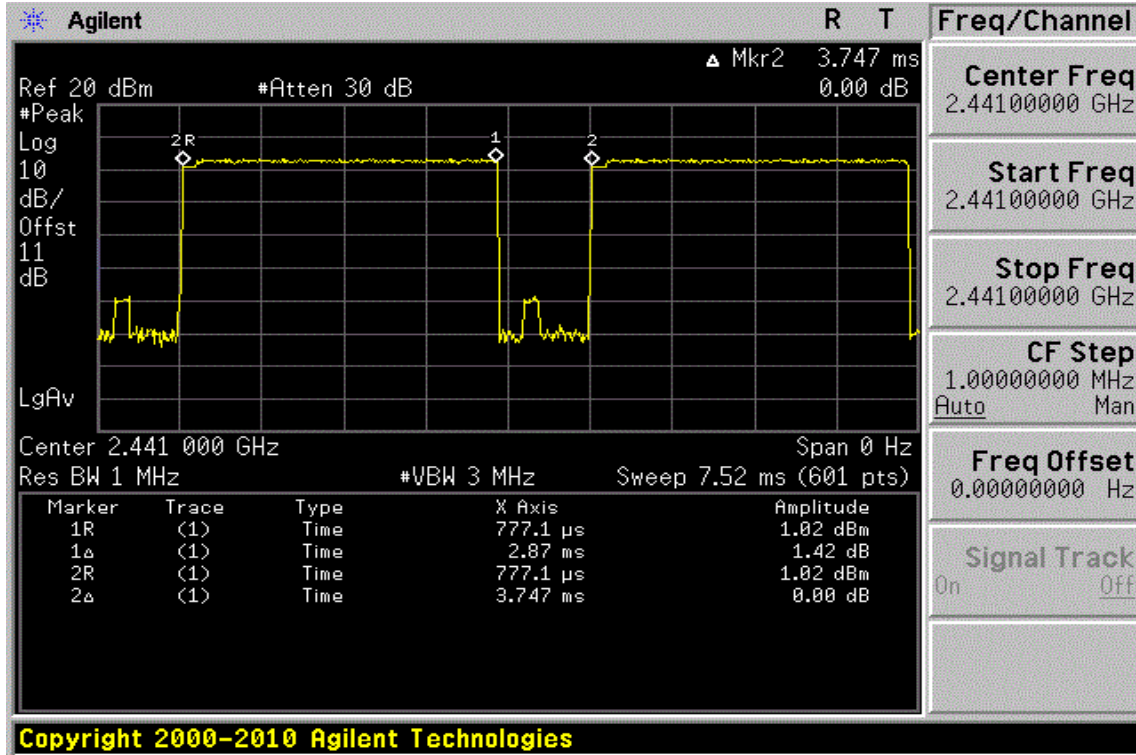

Unless otherwise stated the results shown in this test report refer only to the sample(s) tested and such sample(s) are retained for 90 days only.

除非另有說明，此報告結果僅對測試之樣品負責，同時此樣品僅保留90天。本報告未經本公司書面許可，不可部份複製。

This document is issued by the Company subject to its General Conditions of Service printed overleaf, available on request or accessible at [www.sgs.com/terms\\_and\\_conditions.htm](http://www.sgs.com/terms_and_conditions.htm) and, for electronic format documents, subject to Terms and Conditions for Electronic Documents at [www.sgs.com/terms\\_e-document.htm](http://www.sgs.com/terms_e-document.htm). Attention is drawn to the limitation of liability, indemnification and jurisdiction issues defined therein. Any holder of this document is advised that information contained hereon reflects the Company's findings at the time of its intervention only and within the limits of Client's instructions, if any. The Company's sole responsibility is to its Client and this document does not exonerate parties to a transaction from exercising all their rights and obligations under the transaction documents. This document cannot be reproduced except in full, without prior written approval of the Company. Any unauthorized alteration, forgery or falsification of the content or appearance of this document is unlawful and offenders may be prosecuted to the fullest extent of the law.

SGS Taiwan Ltd.

No.134,WuKungRoad,NewTaipeiIndustrialPark,WukuDistrict,NewTaipeiCity,Taiwan24803/新北市五股區新北產業園區五工路 134 號

台灣檢驗科技股份有限公司

t (886-2) 2299-3279

f (886-2) 2298-0488

www.tw.sgs.com

Member of SGS Group



CH-Mid

3DH1

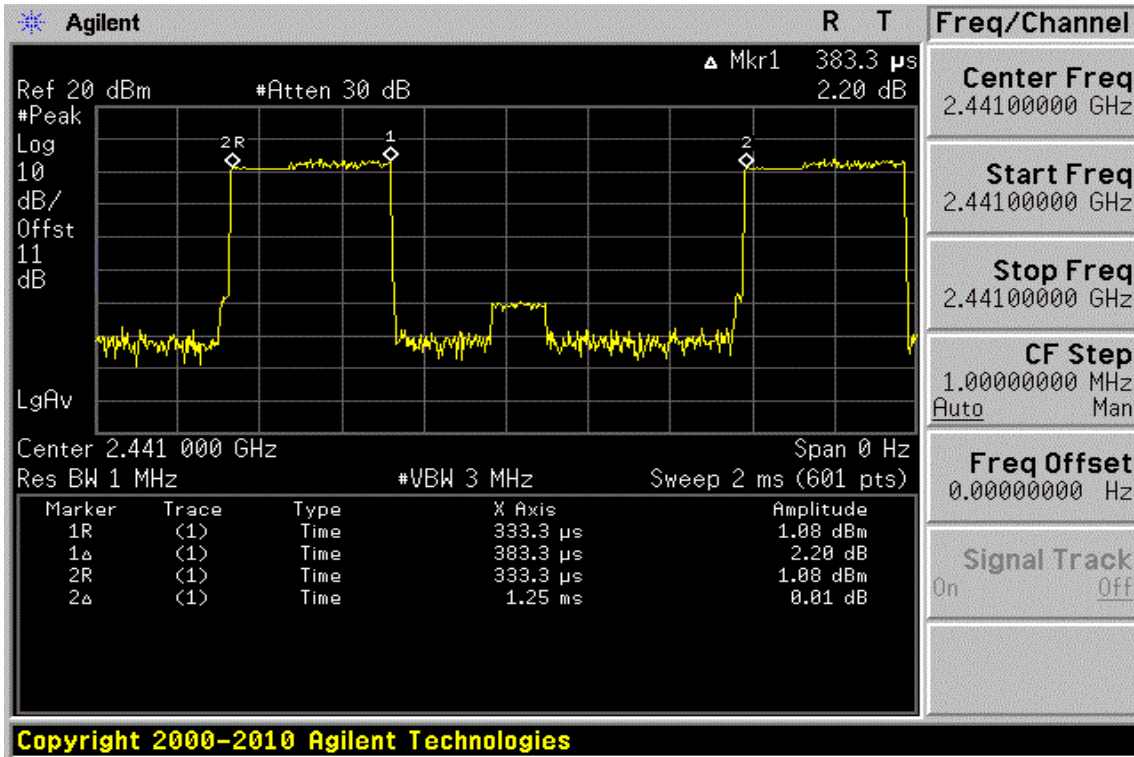

3DH3

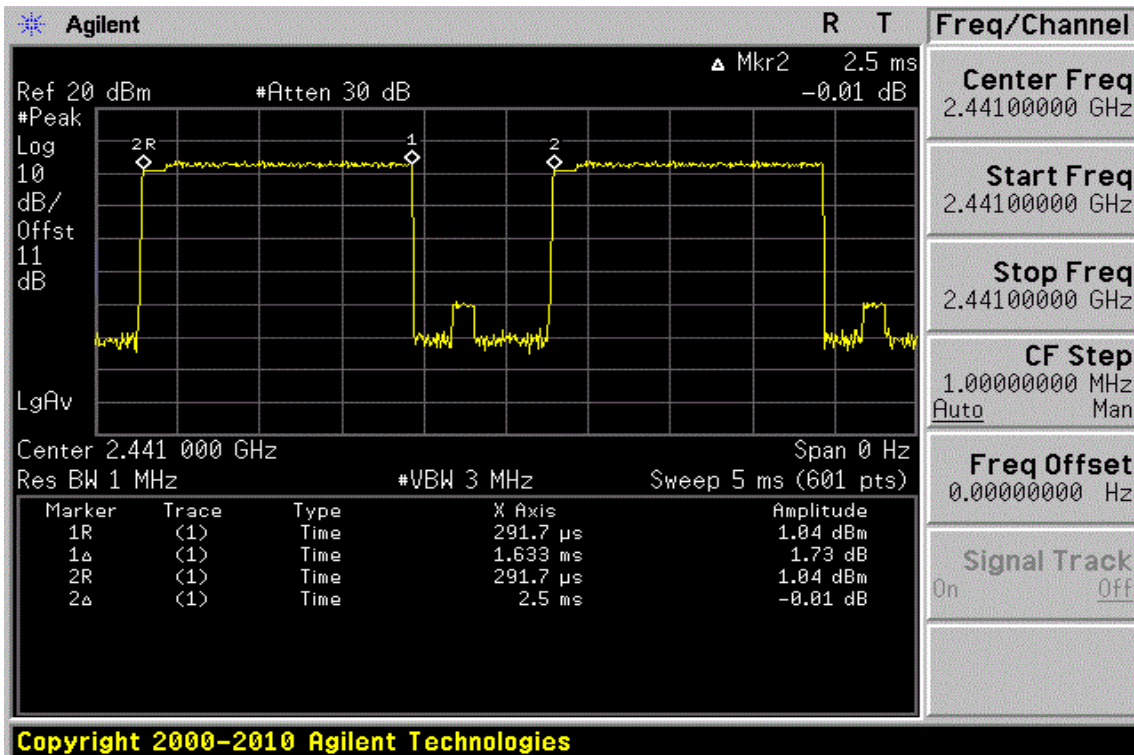

Unless otherwise stated the results shown in this test report refer only to the sample(s) tested and such sample(s) are retained for 90 days only.

除非另有說明，此報告結果僅對測試之樣品負責，同時此樣品僅保留90天。本報告未經本公司書面許可，不可部份複製。

This document is issued by the Company subject to its General Conditions of Service printed overleaf, available on request or accessible at [www.sgs.com/terms\\_and\\_conditions.htm](http://www.sgs.com/terms_and_conditions.htm) and, for electronic format documents, subject to Terms and Conditions for Electronic Documents at [www.sgs.com/terms\\_e-document.htm](http://www.sgs.com/terms_e-document.htm). Attention is drawn to the limitation of liability, indemnification and jurisdiction issues defined therein. Any holder of this document is advised that information contained hereon reflects the Company's findings at the time of its intervention only and within the limits of Client's instructions, if any. The Company's sole responsibility is to its Client and this document does not exonerate parties to a transaction from exercising all their rights and obligations under the transaction documents. This document cannot be reproduced except in full, without prior written approval of the Company. Any unauthorized alteration, forgery or falsification of the content or appearance of this document is unlawful and offenders may be prosecuted to the fullest extent of the law.

SGS Taiwan Ltd.

No.134,WuKungRoad,NewTaipeiIndustrialPark,WukuDistrict,NewTaipeiCity,Taiwan24803/新北市五股區新北產業園區五工路 134 號

台灣檢驗科技股份有限公司

t (886-2) 2299-3279

f (886-2) 2298-0488

www.tw.sgs.com

Member of SGS Group

3DH5

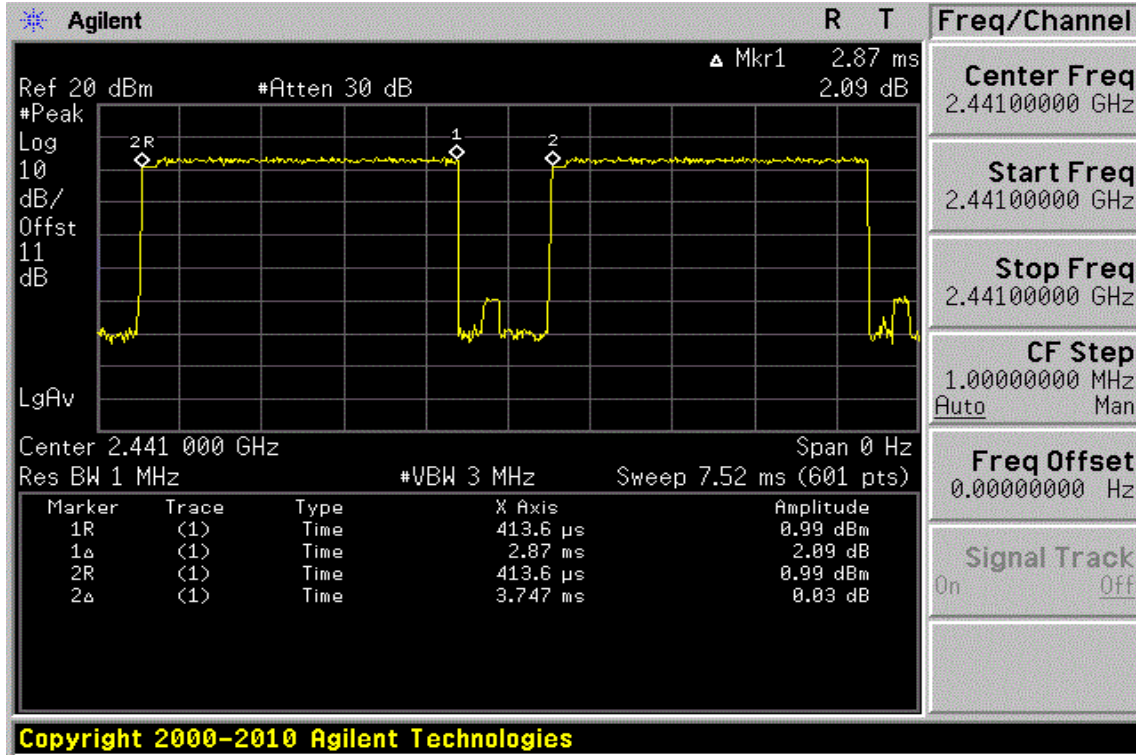

~ End of Report ~

Unless otherwise stated the results shown in this test report refer only to the sample(s) tested and such sample(s) are retained for 90 days only.

除非另有說明，此報告結果僅對測試之樣品負責，同時此樣品僅保留90天。本報告未經本公司書面許可，不可部份複製。

This document is issued by the Company subject to its General Conditions of Service printed overleaf, available on request or accessible at [www.sgs.com/terms\\_and\\_conditions.htm](http://www.sgs.com/terms_and_conditions.htm) and, for electronic format documents, subject to Terms and Conditions for Electronic Documents at [www.sgs.com/terms\\_e-document.htm](http://www.sgs.com/terms_e-document.htm). Attention is drawn to the limitation of liability, indemnification and jurisdiction issues defined therein. Any holder of this document is advised that information contained hereon reflects the Company's findings at the time of its intervention only and within the limits of Client's instructions, if any. The Company's sole responsibility is to its Client and this document does not exonerate parties to a transaction from exercising all their rights and obligations under the transaction documents. This document cannot be reproduced except in full, without prior written approval of the Company. Any unauthorized alteration, forgery or falsification of the content or appearance of this document is unlawful and offenders may be prosecuted to the fullest extent of the law.

SGS Taiwan Ltd.

No.134,WuKungRoad,NewTaipeiIndustrialPark,WukuDistrict,NewTaipeiCity,Taiwan24803/新北市五股區新北產業園區五工路 134 號

台灣檢驗科技股份有限公司

t (886-2) 2299-3279

f (886-2) 2298-0488

www.tw.sgs.com

Member of SGS Group