



Trimble TSC5

Controller

Powered by Android™ 10

Draft Version 01

Revision 01

May 2020

Corporate Office

Trimble Inc.
935 Stewart Drive
Sunnyvale, CA 94085
USA
www.trimble.com

Geospatial Division

10368 Westmoor Drive
Westminster, CO 80021
USA

Global Technical Support

To request detailed technical assistance for Trimble solutions, contact trimble_support@trimble.com or locate the appropriate [Trimble Support](#) representative for your solution.

Copyright and Trademarks

© 2020, Trimble Inc. All rights reserved. Trimble, the Globe & Triangle logo, Access & Ranger are trademarks of Trimble Inc., registered in the United States and in other countries. Google, Google Play and other marks are trademarks of Google LLC. The Android robot is reproduced or modified from work created and shared by Google and used according to terms described in the Creative Commons 3.0 Attribution License. The Bluetooth word mark and logos are owned by the Bluetooth SIG, Inc. and any use of such marks by Trimble Inc. is under license. All other trademarks are the property of their respective owners.

Release Notice

This is the May 2020 release (Revision A) of the Trimble Ranger 7 data collector / Trimble TSC5 controller documentation, Geospatial Division.

European declaration of conformity

According to ISO / IEC Guide 22 and EN 450 14

Manufacturer's Name: Trimble Inc.
Manufacturer's Address: 4408 Gibson Dr, Tipp City, OH 45371

Declares, under our sole responsibility, that the product:

Product Name: Ranger 5 / TSC5
Model Number(s): 121900

Spectrum and maximum power: BT 13dBm; Wi-Fi 2.4GHz 17dBm; Wi-Fi 5GHz 19dBm

Conforms to the following Product Specifications:
RED 2014/53/EU LVD 2014/35/EU EMC 2014/53/EU RED
R&TTE Directive 1999/5/EC

- ETSI EN 300 328
- ETSI EN 300 328 V1.8.1 (2012-06)
- ETSI EN 300 893
- ETSI EN 301 489-1 V1.9.2 (20011-09)
- ETSI EN 301 489-3
- ETSI EN 301 489-17 V2.2.1 (2012-09)
- ETSI EN 303 413
- EN 55022: 2010+AC: 2011
- EN 55024: 2010+A1:2015
- EN 55032: 2012+AC: 2013
- EN 60950-1 (2001)
- EN 60950-1:2006/A11:2009/A1:2010/

- EN 61000-3-2: 2006+A2: 2009
- EN 61000-3-3: 2013
- EN 62368-1:2014

Supplementary information

In addition, the product is battery powered and the power supply provided with this product has been certified to IEC 60950 +A1, A2, A3, A4, A11. As manufacturer, we declare under our sole responsibility that the equipment follows the provisions of the Standards stated above.

Importer of Record

Trimble European Regional Fulfillment Center
Logistics Manager
Trimble Europe B.V. & Trimble International B.V.
Industrieweg 187a
5683 CC Best
The Netherlands

Trimble EC

Trimble Germany
Am Prime Parc 11
65479 Raunheim
Germany



CAUTION: Only approved accessories may be used with this equipment. In general, all cables must be high quality, shielded, correctly terminated and normally restricted to two meters in length. Power supplies approved for this product employ special provisions to avoid radio interference and should not be altered or substituted. Unapproved modifications or operations beyond or in conflict with these instructions for use may void authorization by the authorities to operate the equipment.

Recycling information

You should dispose of the device and accessories properly according to local laws and regulations. Because the device contains electronic components, it must be disposed of separately from household waste. When the device reaches its end of life, contact your local Trimble reseller to learn about disposal and recycling options for your area.

Recycling in Europe



The symbol above means that according to local laws and regulations your product and/or its battery shall be disposed of separately from household waste. When this product reaches its end of life, take it to a collection point designated by local authorities. The separate collection and recycling of your product and/or its battery at the time of disposal will help conserve natural resources and ensure that it is recycled in a manner that protects human health and the environment.

For information about recycling Trimble WEEE (Waste Electrical and Electronic Equipment) products that run on electrical power go to http://www.trimble.com/corporate/about_WEEE_ROHS_initiatives.aspx.

To recycle Trimble WEEE products call +31 497 53 24 30, and ask for the "WEEE Associate". or mail a request for recycling instructions to:

Trimble Europe B.V. & Trimble International B.V.
Industrieweg 187a
5683 CC Best
The Netherlands

Taiwan Battery Recycling Requirements



The product contains a Lithium-ion battery. Taiwanese regulations require that waste batteries are recycled. 廢電池請回收.

Regional compliance

Australia and New Zealand



This product conforms with the regulatory requirements of the Australian Communications and Media Authority (ACMA) Telecommunications, Radiocommunications and EMC Labelling Notices, thus satisfying the requirements for RCM marking and sale within Australia and New Zealand.

Europe



	BE	BG	CZ	DK	DE	EE	IE
	EL	ES	FR	HR	IT	CY	LV
	LT	LU	HU	MT	NL	AT	PL
	PT	RO	SI	SK	FI	SE	UK



This Trimble product has been tested and found to comply with all requirements for CE Marking and sale within the European Economic Area (EEA). The device has Bluetooth and wireless LAN approval and satisfies the requirements for Radio and Telecommunication Terminal Equipment specified by European Council Directive 1999/5/EC. These requirements provide reasonable protection against harmful interference when the equipment is operated appropriately in a residential or commercial environment.

The device is intended for connection to European Networks operating on GSM 900, or GSM 1800 MHz.

Canada

IC ID: 5817A-EM7565 / 5817A-121900

This digital apparatus does not exceed the Class B limits for radio noise emissions from digital apparatus as set out in the radio interference regulations of the Canadian Department of Communications.

Le présent appareil numérique n'émet pas de bruits radioélectriques dépassant les limites applicables aux appareils numériques de Classe B prescrites dans le règlement sur le brouillage radioélectrique édicté par le Ministère des Communications du Canada.

Changes and modifications not expressly approved by the manufacturer or registrant of this equipment can void your authority to operate this equipment under Industry Canada rules.

Les changements et modifications non expressément approuvés par le fabricant ou le détenteur de cet équipement peuvent annuler votre droit à utiliser cet appareil en vertu des règles d'Industrie Canada.

Licence exempt

This device complies with Industry Canada licence-exempt RSS standard(s). Operation is subject to the following two conditions:

- (1) this device may not cause interference, and
- (2) this device must accept any interference, including interference that may cause undesired operation of the device.

Le présent appareil est conforme aux CNR d'Industrie Canada applicables aux appareils radio exempts de licence. L'exploitation est autorisée aux deux conditions suivantes :

- (1) l'appareil ne doit pas produire de brouillage, et
- (2) l'utilisateur de l'appareil doit accepter tout brouillage radioélectrique subi, même si le brouillage est susceptible d'en compromettre le fonctionnement.

This Class B digital apparatus complies with Canadian ICES-003.

Cet appareil numérique de la classe B est conforme à la norme NMB-003 du Canada.

This Category II radio communication device complies with Industry Canada Standard RSS-310.

Ce dispositif de radiocommunication de catégorie II respecte la norme CNR-310 d'Industrie Canada.

IMPORTANT NOTE: IC Radiation Exposure Statement

This EUT is compliant with SAR for general population/uncontrolled exposure limits in IC RSS-102 and had been tested in accordance with the measurement methods and procedures specified in IEEE 1528. This equipment should be installed and operated with minimum distance 1 cm between the radiator & your body. This device and its antenna(s) must not be co-located or operating in conjunction with any other antenna or transmitter. The County Code Selection feature is disabled for products marketed in the US/Canada.

Cet EUT est conforme au DAS pour la population générale / aux limites d'exposition non contrôlées de l'IC RSS-102 et a été testé en conformément aux méthodes et procédures de mesure spécifiées dans la norme IEEE 1528. Cet équipement doit être installé et fonctionne avec une distance minimale de 1 cm entre le radiateur et votre corps. Cet appareil et son (ses) antenne (s) ne doivent pas co-localisé ou fonctionnant en conjonction avec toute autre antenne ou émetteur La fonction de sélection du code de comté est désactivée pour les produits commercialisés aux États-Unis / au Canada.

[IC SAR warning](#)

Radio Frequency (RF) Exposure Information

The radiated output power of the Wireless Device is below the Industry Canada (IC) radio frequency exposure limits. The Wireless Device should be used in such a manner such that the potential for human contact during normal operation is minimized.

This device has been evaluated for and shown compliant with the IC Specific Absorption Rate ("SAR") limits when installed in specific host products operated in portable exposure conditions.

Informations concernant l'exposition aux fréquences radio (RF)

La puissance de sortie émise par l'appareil de sans fil est inférieure à la limite d'exposition aux fréquences radio d'Industrie Canada (IC). Utilisez l'appareil de sans fil de façon à minimiser les contacts humains lors du fonctionnement normal.

Ce périphérique a été évalué et démontré conforme aux limites SAR (Specific Absorption Rate - Taux d'absorption spécifique) d'IC lorsqu'il est installé dans des produits hôtes particuliers qui fonctionnent dans des conditions d'exposition à des appareils portables.

The device could automatically discontinue transmission in case of absence of information to transmit, or operational failure. Note that this is not intended to prohibit transmission of control or signaling information or the use of repetitive codes where required by the technology.

The device for the band 5150-5250 MHz is only for indoor usage to reduce potential for harmful interference to co-channel mobile satellite systems; the maximum antenna gain permitted (for devices in the bands 5250-5350 MHz and 5470-5725 MHz) to comply with the e.i.r.p. limit; and The maximum antenna gain permitted (for devices in the band 5725-5850 MHz) to comply with the e.i.r.p. limits specified for point-to-point and non-point-to-point operation as appropriate, as stated in section A9.2(3). In addition, High-power radars are allocated as primary users (meaning they have priority) of the band 5250-5350 MHz and this radar could cause interference and/or damage to LE-LAN devices.

Le dispositif pour la bande 5150-5250 MHz est uniquement destiné à une utilisation en intérieur afin de réduire les risques d'interférences nuisibles aux systèmes mobiles par satellite dans le même canal; le gain d'antenne maximal autorisé (pour les appareils dans les bandes 5250-5350 MHz et 5470-5725 MHz) pour se conformer à la p.i.r.e. limite; et Le gain d'antenne maximal autorisé (pour les appareils dans la bande 5725-5850 MHz) pour se conformer à la p.i.r.e. limites spécifiées pour le fonctionnement point à point et non point à point, selon le cas, comme indiqué dans la section A9.2 (3). De plus, les radars haute puissance sont attribués comme utilisateurs principaux (c'est-à-dire qu'ils ont la priorité) de la bande 5250-5350 MHz et ce radar pourrait causer des interférences et / ou endommager les dispositifs LE-LAN.

U.S.

FCC ID: S9E-121900

FCC Compliance Statement

This equipment has been tested and found to comply with the limits for a Class B digital device pursuant to Part 15 of the FCC Rules. Operation is subject to the following two conditions: (1) this device may not cause harmful interference, and (2) this device must accept any interference received, including interference that may cause undesired operation.

This equipment generates, uses, and can radiate radio frequency energy and, if not installed and used in accordance with the instructions may cause harmful interference to radio communication. However, there is no guarantee that interference will not occur in a particular installation. If this equipment does cause harmful interference to radio or television reception, which can be determined by turning the equipment off and on, the user is encouraged to try to correct the interference by one or more of the following measures:

- Reorient or relocate the receiving antenna.
- Increase the separation between the equipment and the receiver.
- Connect the equipment into an outlet on a circuit different from that to which the receiver is connected.
- Consult the dealer or an experienced radio/TV technician for help.

Changes and modifications not expressly approved by the manufacturer or registrant of this equipment can void your authority to operate this equipment under Federal Communications Commission rules.

The radios in this device have been designed and manufactured to not exceed stipulated emission limits for exposure to radio frequency (RF) energy as required by the Federal Communications Commission of the U.S. Government 47 C.F.R. § 2.1091 and 2.1093.

This equipment should be installed and operated with minimum distance 1 cm between the radiator & your body. This device and its antenna(s) must not be co-located or operating in conjunction with any other antenna or transmitter. The County Code Selection feature is disabled for products marketed in the US/Canada.

Operation on the 5.15-5.25GHz frequency band is restricted to indoor use only. The FCC requires indoor use for the 5.15-5.25GHz band to reduce the potential for harmful interference to co-channel Mobile Satellite Systems. Therefore, it will only transmit on the 5.25-5.35 GHz, 5.47-5.725 GHz and 5.725 –5.850 GHz band when associated with an access point (AP).

CE

a. Caution:

- Risk of explosion if battery replaced by an incorrect type.
- Dispose of used batteries according to the instructions.

b. Make sure the temperature for the adapter while charging is within 0-45 °C (32-113 °F).

Limited Warranty Terms and Conditions

Product Limited Warranty

Subject to the terms and conditions set forth herein, Trimble Inc. (“Trimble”) warrants that for a period of (2) years from date of purchase this Trimble product (the “Product”) will substantially conform to Trimble's publicly available specifications for the Product and that the hardware and any storage media components of the Product will be substantially free from defects in materials and workmanship.

Product Software

Product software, whether built into hardware circuitry as firmware, provided as a standalone computer software product, embedded in flash memory, or stored on magnetic or other media, is licensed solely for use with or as an integral part of the Product and is not sold. The terms of the end user license agreement, as included below, govern the use of the Product Software, including any differing limited warranty terms, exclusions and limitations, which shall control over the terms and conditions set forth in the limited Product warranty.

Warranty Remedies

If the Trimble Product fails during the warranty period for reasons covered by this limited warranty and you notify Trimble of such failure during the warranty period, Trimble will repair OR replace the nonconforming Product with new, equivalent to new, or reconditioned parts or Product, OR refund the Product purchase price paid by you, at Trimble's option, upon your

return of the Product in accordance with Trimble's product return procedures then in effect.

How to Obtain Warranty Service

To obtain warranty service for the Product, it is recommended you contact your Trimble dealer. Alternatively, you may contact Trimble to request warranty service by emailing Repair_Services@Trimble.com. Please be prepared to provide:

- your name, address, and telephone numbers;
- product name, Part Number and Serial Number
- proof of purchase; and
- an explanation of the problem.

The customer service representative may need additional information from you depending on the nature of the problem.

Warranty Exclusions and Disclaimer

This Product limited warranty shall only apply in the event and to the extent that (i) the Product is properly and correctly installed, configured, interfaced, maintained, stored, and operated in accordance with Trimble's applicable operator's manual and specifications, and; (ii) the Product is not modified or misused. This Product limited warranty shall not apply to, and Trimble shall not be responsible for, defects or performance problems resulting from (i) the combination or utilization of the Product with hardware or software products, information, data, systems, interfaces, or devices not made, supplied, or specified by Trimble; (ii) the operation of the Product under any specification other than, or in addition to, Trimble's standard specifications for its products; (iii) the unauthorized installation, modification, or use of the Product; (iv) damage caused by: accident, lightning or other electrical discharge, fresh or salt water immersion or spray (outside of Product specifications); or exposure to environmental conditions for which the Product is not intended; (v) normal wear and tear on consumable parts (e.g., batteries); or (vi) cosmetic damage. Trimble does not warrant or guarantee the results obtained through the use of the Product or Software, or that software components will operate error free.

NOTICE REGARDING PRODUCTS EQUIPPED WITH TECHNOLOGY CAPABLE OF TRACKING SATELLITE SIGNALS FROM SATELLITE BASED AUGMENTATION SYSTEMS (SBAS) (WAAS, EGNOS, GAGAN, MSAS AND LUCH), OMNISTAR, BEIDOU, GPS, GALILEO OR GLONASS SATELLITES, OR FROM IALA BEACON SOURCES: TRIMBLE IS NOT RESPONSIBLE FOR THE OPERATION OR FAILURE OF OPERATION OF ANY SATELLITE BASED POSITIONING SYSTEM OR THE AVAILABILITY OF ANY SATELLITE BASED POSITIONING SIGNALS.

THE FOREGOING LIMITED WARRANTY TERMS STATE TRIMBLE'S ENTIRE LIABILITY, AND YOUR EXCLUSIVE REMEDIES, RELATING TO THE TRIMBLE PRODUCT. EXCEPT AS OTHERWISE EXPRESSLY PROVIDED HEREIN, THE PRODUCT, AND ACCOMPANYING DOCUMENTATION AND MATERIALS ARE PROVIDED "AS-IS" AND WITHOUT EXPRESS OR IMPLIED WARRANTY OF ANY KIND, BY EITHER TRIMBLE OR ANYONE WHO HAS BEEN INVOLVED IN ITS CREATION, PRODUCTION, INSTALLATION, OR DISTRIBUTION, INCLUDING, BUT NOT LIMITED TO, THE IMPLIED WARRANTIES OF MERCHANTABILITY AND FITNESS FOR A PARTICULAR PURPOSE, TITLE, AND NONINFRINGEMENT. THE STATED EXPRESS WARRANTIES ARE IN LIEU OF ALL OBLIGATIONS OR LIABILITIES ON THE PART OF TRIMBLE ARISING OUT OF, OR IN CONNECTION WITH, ANY PRODUCT. BECAUSE SOME STATES AND JURISDICTIONS DO NOT ALLOW LIMITATIONS ON DURATION OR THE EXCLUSION OF AN IMPLIED WARRANTY, THE ABOVE LIMITATION MAY NOT APPLY TO YOU.

Limitation of Liability

TRIMBLE'S ENTIRE LIABILITY UNDER ANY PROVISION HEREIN SHALL BE LIMITED TO THE AMOUNT PAID BY YOU FOR THE PRODUCT. TO THE MAXIMUM EXTENT PERMITTED BY APPLICABLE LAW, IN NO EVENT SHALL TRIMBLE OR ITS SUPPLIERS BE LIABLE FOR ANY INDIRECT, SPECIAL, INCIDENTAL, OR CONSEQUENTIAL DAMAGE WHATSOEVER UNDER ANY CIRCUMSTANCE OR LEGAL THEORY RELATING IN ANYWAY TO THE PRODUCTS, SOFTWARE AND ACCOMPANYING DOCUMENTATION AND MATERIALS, (INCLUDING, WITHOUT LIMITATION, DAMAGES FOR LOSS OF BUSINESS PROFITS, BUSINESS INTERRUPTION, LOSS OF DATA, OR ANY OTHER PECUNIARY LOSS), REGARDLESS OF WHETHER TRIMBLE HAS BEEN ADVISED OF THE POSSIBILITY OF ANY SUCH LOSS AND REGARDLESS OF THE COURSE OF DEALING WHICH DEVELOPS OR HAS DEVELOPED BETWEEN YOU AND TRIMBLE. BECAUSE SOME STATES AND JURISDICTIONS DO NOT ALLOW THE EXCLUSION OR LIMITATION OF LIABILITY FOR CONSEQUENTIAL OR INCIDENTAL DAMAGES, THE ABOVE LIMITATION MAY NOT APPLY TO YOU.

NOTE: THE ABOVE TRIMBLE LIMITED WARRANTY PROVISIONS WILL NOT APPLY TO PRODUCTS PURCHASED IN THOSE JURISDICTIONS (E.G., MEMBER STATES OF THE EUROPEAN ECONOMIC AREA) IN WHICH PRODUCT WARRANTIES ARE THE RESPONSIBILITY OF THE LOCAL DEALER FROM WHOM THE PRODUCTS ARE ACQUIRED. IN SUCH A CASE, PLEASE CONTACT YOUR TRIMBLE DEALER FOR APPLICABLE WARRANTY INFORMATION.

Notice to Australian Purchasers - The Australian Consumer Law

Our goods come with guarantees that cannot be excluded under the Australian Consumer Law. You are entitled to a replacement or refund for a major failure and for compensation for any other reasonably foreseeable loss or damage. You are also entitled to have the goods repaired or replaced if the goods fail to be of acceptable quality and the failure does not

amount to a major failure.

Trimble's warranty, as set out in the user manual accompanying this statement, or as described in the warranty card accompanying the Product you purchased, is in addition to any mandatory rights and remedies that you may have under the Australian Consumer Law.

Official Language

THE OFFICIAL LANGUAGE OF THESE TERMS AND CONDITIONS IS ENGLISH. IN THE EVENT OF A CONFLICT BETWEEN ENGLISH AND OTHER LANGUAGE VERSIONS, THE ENGLISH LANGUAGE SHALL CONTROL.

End User License Agreement for Product Software

IMPORTANT, READ CAREFULLY. THIS END USER LICENSE AGREEMENT ("EULA") IS A LEGAL AGREEMENT BETWEEN YOU AND Trimble Inc. ("Trimble") and applies to the computer software provided with the Trimble product purchased by you (whether built into hardware circuitry as firmware, embedded in flash memory, or stored on magnetic or other media), or provided as a stand-alone computer software product, and includes any accompanying written materials such as a user's guide or product manual, as well as any "online" or electronic documentation ("Software" or "Product Software"). This EULA will also apply to any Software error corrections, updates and upgrades subsequently furnished by Trimble, unless such are accompanied by different license terms and conditions, which will govern their use. You have acquired a Trimble Product ("Device") that includes Software, some of which was licensed by Trimble from Microsoft Corporation or its affiliates (collectively "Microsoft"). The Software licensed from Microsoft, as well as associated updates, supplements, internet-based services and support services, media, printed materials, and "online" or electronic documentation ("Microsoft Software"), are protected under this EULA. The Software is also protected by copyright laws and international copyright treaties, as well as other intellectual property laws and treaties. The Software is licensed, not sold.

BY USING THE SOFTWARE, INCLUDING USE ON THIS DEVICE, YOU ACCEPT THESE TERMS. IF YOU DO NOT ACCEPT THEM, DO NOT USE THE DEVICE OR SOFTWARE. INSTEAD CONTACT TRIMBLE FOR A REFUND OR CREDIT. As described below, using some features also operates as your consent to the transmission of certain standard computer information for Internet-based services.

WARNING: If the Software contains voice operated technologies, then operating this Software requires user attention. Diverting attention away from the road while driving can possibly cause an accident or other serious consequence. Even occasional, short diversions of attention can be dangerous if your attention is diverted away from your driving task at a critical time. Trimble and Microsoft make no representations, warranties or other determinations that ANY use of this Software is legal, safe, or in any manner recommended or intended while driving or otherwise operating a motor vehicle.

1 LIMITED WARRANTY FOR TRIMBLE PRODUCT SOFTWARE

1.1 Limited Warranty. Trimble warrants that the Software, exclusive of the Microsoft Software, will perform substantially in accordance with the accompanying written materials for a period of twelve (12) months from the date of purchase. This limited warranty gives you specific legal rights; you may have others, which vary from state/jurisdiction to state/jurisdiction. The above limited warranty does not apply to Fixes, Minor Updates, or Major Upgrades of the Software after expiration of the twelve (12) month limited warranty period, all of which are provided "AS IS" and without warranty unless otherwise specified in writing by Trimble. Because the Software is inherently complex and may not be completely free of nonconformities, defects or errors, you are advised to verify your work. Trimble does not warrant that the Software will operate error free or uninterrupted, will meet your needs or expectations, or that all nonconformities can or will be corrected.

1.2 Software Fixes. During the limited warranty period described in section 1.1 above, you will be entitled to receive such Fixes to the Product Software that Trimble releases and makes commercially available and for which it does not charge separately, subject to the procedures for delivery to purchasers of Trimble products generally. If you have purchased the Product from an authorized Trimble dealer rather than from Trimble directly, Trimble may, at its option, forward the software Fix to the Trimble dealer for final distribution to you. Minor Updates, Major Upgrades, new products, or substantially new software releases, as identified by Trimble, are expressly excluded from this update process and limited warranty. Receipt of Software Fixes or other enhancements shall not serve to extend the limited warranty period.

For purposes of this warranty the following definitions shall apply : (1) "Fix(es)" means an error correction or other update created to fix a previous software version that does not substantially conform to its Trimble specifications; (2) "Minor Update" occurs when enhancements are made to current features in a software program; and (3) "Major Upgrade" occurs when significant new features are added to software, or when a new product containing new features replaces the further development of a current product line. Trimble reserves the right to determine, in its sole discretion, what constitutes a Fix, Minor Update, or Major Upgrade.

1.3 Customer Remedies. Trimble's and its suppliers' entire liability, and your sole remedy, with respect to the Software shall be either, at Trimble's option, (a) repair or replacement of the Software, or (b) return of the license fee paid for any Software that does not meet Trimble's limited warranty. This limited warranty is void if failure of the Software has resulted from (1) accident, misuse, abuse, or misapplication; (2) alteration or modification of the Software without Trimble's authorization; (3) interaction with software or hardware not supplied or supported by Trimble; (4) your improper, inadequate or unauthorized

installation, maintenance or storage; or (5) if you violate the terms of this EULA. Any replacement Software will be warranted for the remainder of the original warranty period or thirty (30) days, whichever is longer.

1.4 NO OTHER WARRANTIES. TO THE MAXIMUM EXTENT PERMITTED BY APPLICABLE LAW, TRIMBLE AND ITS SUPPLIERS DISCLAIM ALL OTHER WARRANTIES, TERMS AND CONDITIONS, EITHER EXPRESS OR IMPLIED, BY STATUTE, COMMON LAW OR OTHERWISE, INCLUDING BUT NOT LIMITED TO, IMPLIED WARRANTIES, TERMS AND CONDITIONS OF MERCHANTABILITY AND FITNESS FOR A PARTICULAR PURPOSE, TITLE, AND NONINFRINGEMENT WITH REGARD TO THE SOFTWARE, ITS SATISFACTORY QUALITY AND THE PROVISION OF OR FAILURE TO PROVIDE SUPPORT SERVICES. TO THE EXTENT ALLOWED BY APPLICABLE LAW, IMPLIED WARRANTIES, TERMS AND CONDITIONS ON THE SOFTWARE ARE LIMITED TO NINETY (90) DAYS. YOU MAY HAVE OTHER LEGAL RIGHTS WHICH VARY FROM STATE/JURISDICTION TO STATE/JURISDICTION.

NO WARRANTIES FOR THE MICROSOFT SOFTWARE. THE MICROSOFT SOFTWARE is provided "AS IS" and with all faults, AND TRIMBLE PROVIDES NO WARRANTY WITH RESPECT THERETO. THE ENTIRE RISK AS TO SATISFACTORY QUALITY, PERFORMANCE,

ACCURACY AND EFFORT (INCLUDING LACK OF NEGLIGENCE) FOR THE MICROSOFT SOFTWARE IS WITH YOU. ALSO, THERE IS NO WARRANTY AGAINST INTERFERENCE WITH YOUR ENJOYMENT OF THE MICROSOFT SOFTWARE OR AGAINST INFRINGEMENT.

1.5 PLEASE NOTE: THE FOREGOING TRIMBLE LIMITED WARRANTY PROVISIONS MAY NOT APPLY TO SOFTWARE PRODUCT LICENSES PURCHASED IN THOSE JURISDICTIONS (SUCH AS COUNTRIES OF THE EUROPEAN UNION) IN WHICH PRODUCT WARRANTIES ARE OBTAINED FROM THE LOCAL DISTRIBUTOR. IN SUCH CASES, PLEASE CONTACT YOUR TRIMBLE DEALER FOR APPLICABLE WARRANTY INFORMATION.

2 TRIMBLE LIMITATION OF LIABILITY

2.1 LIMITATION OF LIABILITY. TO THE MAXIMUM EXTENT PERMITTED BY APPLICABLE LAW, IN NO EVENT SHALL TRIMBLE OR ITS SUPPLIERS BE LIABLE FOR ANY SPECIAL, INCIDENTAL, INDIRECT, CONSEQUENTIAL OR PUNITIVE DAMAGES HOWEVER CAUSED AND REGARDLESS OF THE THEORY OF LIABILITY (INCLUDING, WITHOUT LIMITATION, DAMAGES FOR LOSS OF BUSINESS PROFITS, BUSINESS INTERRUPTION, LOSS OF BUSINESS INFORMATION, OR ANY OTHER PECUNIARY LOSS) ARISING OUT OF THE USE OR INABILITY TO USE THE SOFTWARE, OR THE PROVISION OF OR FAILURE TO PROVIDE SUPPORT SERVICES, EVEN IF TRIMBLE HAS BEEN ADVISED OF THE POSSIBILITY OF SUCH DAMAGES AND NOTWITHSTANDING ANY FAILURE OF ESSENTIAL PURPOSE OF ANY EXCLUSIVE REMEDY PROVIDED IN THIS EULA.

IN NO EVENT SHALL THE TOTAL CUMULATIVE LIABILITY OF TRIMBLE AND ITS SUPPLIERS IN CONNECTION WITH THIS EULA OR THE SOFTWARE, WHETHER BASED ON CONTRACT, WARRANTY, TORT (INCLUDING NEGLIGENCE), STRICT LIABILITY OR OTHERWISE, EXCEED THE ACTUAL AMOUNT PAID TO TRIMBLE FOR THE SOFTWARE LICENSE GIVING RISE TO THE CLAIM. BECAUSE SOME STATES AND JURISDICTIONS DO NOT ALLOW THE EXCLUSION OR LIMITATION OF LIABILITY FOR CONSEQUENTIAL OR INCIDENTAL DAMAGES, THE ABOVE LIMITATION MAY NOT APPLY TO YOU.

3 GENERAL

3.1 This EULA shall be governed by the laws of the State of California and applicable United States Federal law without reference to "conflict of laws" principles or provisions. The United Nations Convention on Contracts for the International Sale of Goods will not apply to this EULA. Jurisdiction and venue of any dispute or court action arising from or related to this EULA or the Software shall lie exclusively in or be transferred to the courts the County of Santa Clara, California, and/or the United States District Court for the Northern District of California. You hereby consent and agree not to contest, such jurisdiction, venue and governing law.

3.2 Section 3.1 notwithstanding, if you acquired this product in Canada, this EULA is governed by the laws of the Province of Ontario, Canada. In such case each of the parties to this EULA irrevocably attorns to the jurisdiction of the courts of the Province of Ontario and further agrees to commence any litigation that may arise under this EULA in the courts located in the Judicial District of York, Province of Ontario. If you acquired this product in the European Union, this EULA is governed by the laws of The Netherlands, excluding its rules governing conflicts of laws and excluding the United Nations Convention on the International Sale of Goods. In such case each of the parties to this EULA irrevocably attorns to the jurisdiction of the courts of The Netherlands and further agrees to commence any litigation that may arise under this EULA in the courts of The Hague, The Netherlands.

3.3 Trimble reserves all rights not expressly granted by this EULA.

3.4 Official Language. The official language of this EULA and of any documents relating thereto is English. For purposes of interpretation, or in the event of a conflict between English and versions of this EULA or related documents in any other language, the English language version shall be controlling.

Contents

- Safety Information** **16**
- Battery safety 16
- Power supply safety 17
- Touchscreen glass 17
- Service safety 17
- Safe environments of use 17
- Distraction 17
- Telecommunications & Internet Association (TIA) 18
- Specific Absorption Rate (SAR) 18
- Caring for your device 18
- Cleaning 18
- Touchscreen care 18
- Battery care 19
- Product specifications 20

- Chapter 1: Introduction to the Trimble Ranger 5 data collector / Trimble TSC5 controller** **23**
- Registration 23
- Configuration options 23
- In the box 24
- Replacement and spare or optional accessories 24
- Trimble EMPOWER Modules 25
- Parts of the Ranger 5 data collector / TSC5 controller 26

- Chapter 2: Basic setup and operation** **28**
- Inserting a SIM card 28
- Installing and removing the optional accessory battery pack 29
- Installing the optional accessory battery pack 30
- Removing / warm-swapping the optional accessory battery pack 31
- Tethering the stylus 32
- Installing the screen protector 32
- Attaching the pole bracket 36
- Attaching the handstrap 36
- Charging and power modes 37
- Charging the internal batteries and the optional accessory battery pack while installed in the Ranger 5 / TSC5 37
- LED charging status 38
- Checking the battery level of the internal batteries and the accessory battery pack in the OS 39
- Charging the accessory battery pack separately from the Ranger 5 / TSC5 39
- Charging the battery pack using the AC adapter and USB-C to USB-C cable included in the

packout	40
LED charging status on the accessory battery pack	40
Checking the battery pack charge level using the battery indicator	40
Charging the battery pack using the dual bay battery charger accessory	41
Making your battery last longer	42
Setting up your Ranger 5 / TSC5 for the first time	44
Turning the device on	44
About Sleep state	44
Waking and unlocking the device	44
Restarting the device	44
Turning off the device	45
Using the touchscreen	45
Switching between finger, glove and stylus mode	45
Using the stylus	45
Display settings	47
Adjusting the backlight	47
Adaptive brightness	47
Screen auto-rotation	47
Using the onscreen keypad	48
Using a USB or Bluetooth® mouse	48
Using the integrated keyboard	48
Modifier keys and Sticky keys	51
Configuring built-in keypad settings	53
Sticky Keys	53
Backlight	54
Status Icons	54
SYM Key	54
Status icons in the taskbar	54
Pinning keypad status icons to the taskbar	55
Using SYM Key IME	55
Selected Input Method Indicator	55
Selecting the SYM Key IME	55
Using the SYM Key IME	56
Switching Modes	56
Application Support for SYM IME	56
SYM IME Issues and Limitations	57
Assign Keys app: F keys	57
Chapter 3: Using the Android 10 operating system	59
Using Accounts	59
Sign in to your account	59
Sign out of your account	59
Manage multiple accounts	59

The Android interface	59
Home screen	59
Android Navigation keys	61
Status bar	61
Apps Screen	61
Adding apps to a Home screen	62
Removing apps from the Home screen	62
Uninstalling apps	62
Settings	62
Chapter 4: Using wireless networks	63
Connecting to Wi-Fi	63
Disconnecting from Wi-Fi	63
Forgetting a Wi-Fi network	63
Advanced Wi-Fi settings	64
Configure proxy settings	64
Managing Wi-Fi from the Status bar / Quick Settings on the Home screen	64
Working with mobile broadband	65
Using mobile data	65
Locating the device's IMEI number	65
Airplane mode	66
Chapter 5: Working with GNSS	66
Using the GNSS status application	66
Chapter 6: Using accessories and connecting to other devices	66
Connecting to USB accessories	67
Connecting to Bluetooth accessories	67
Turning Bluetooth on or off	67
Pairing and connecting a Bluetooth device with the Ranger 5 / TSC5	68
Step 1: Pair a Bluetooth device	68
Step 2: Connect to a Bluetooth device	68
Connecting to RS-232 peripherals	68
Transferring data between your Ranger 5 / TSC5 and another computer	68
Transferring data using a USB-C cable	69
Transfer with the Windows operating system	69
Transfer with a MacOS device	69
Using EMPOWER modules	69
About EMPOWER modules	69
Installing & removing EMPOWER modules on the device	70
Installing EMPOWER module drivers and software	71
Trimble EMPOWER Hub	72
Disabling and enabling modules in the EMPOWER Hub	72
Using the shoulder sling	72

Using the desktop hub	72
Using the accessory battery and charger	73
Chapter 7: Using the camera	73
Taking photos and videos	74
Changing camera settings	75
Advanced camera settings	75
Enable the Camera app to access your location to geo-tag photos	75
Viewing photos and videos	75
Chapter 8: Using the pre-installed apps	76
Trimble EMPOWER Hub	76
Trimble GNSS Status utility	76
Bundled Google apps	76
Getting more apps	78
Chapter 9: Troubleshooting, downloading updates, and repair	78
Troubleshooting	78
Further assistance and support with the Android 10 operating system	78
Performance issues	79
Device is running slowly, restarts or crashes frequently	79
Check for Android updates	79
Check storage and free up space	79
Check for app updates	79
Close apps that you are not using	79
See if an app is causing the issue	80
EMPOWER module issues	81
My field software doesn't recognize my EMPOWER module	81
The EMPOWER Hub doesn't show my module	81
Wireless connectivity issues	81
Wi-Fi speed is slow	81
Power and battery issues	81
Battery will not charge	81
Device will not start up	82
Device suddenly turned off during use	82
Device shut-down when warm-swapping the battery	82
Restarting or resetting the operating system	83
Restarting your (unresponsive) device	83
Resetting your device to factory default settings	83
Operating system and software updates	84
Android 10 Updates	84
Software downloads and updates	84
Repairing your device	84

Safety Information

- Battery safety
- Power supply safety
- Touchscreen glass
- Service safety
- Safe environments of use
- Distraction
- Telecommunication & Internet Association (TIA)
- Specific Absorption Rate (SAR)
- Caring for your device

Read this guide for important safety and health information and the terms of the Limited Warranty that apply to the Trimble Ranger 5 / TSC5 device that you have purchased. Keep all printed guides for future reference. Failure to follow instructions and properly set up, use, and care for this product can increase the risk of serious injury or death, or damage to the device or devices.

Battery safety

Lithium-Ion batteries are classified by the U. S. Federal Government as non-hazardous waste and are safe for disposal in the normal municipal waste stream. These batteries contain recyclable materials and are accepted for recycling. Dispose of used batteries in accordance with local regulations.



WARNING - Non-approved batteries will not function in the device. Use only the battery for the system for which it was specified. Only use the battery with a charging system that has been qualified with the system per this standard. Use of an unqualified battery or charger may present a risk of fire, explosion, leakage, or other hazard.



WARNING - There are no user-serviceable parts in the battery pack. Do not disassemble or open, crush, bend or deform, puncture, or shred the battery. Do not modify or remanufacture, attempt to insert foreign objects into the battery, immerse or expose to water or other liquids, or expose to fire, explosion, or other hazard. Do not expose to temperatures above +70 °C (+158 °F).



WARNING - Improper battery use may result in a fire, explosion, or other hazard.

- Do not short circuit a battery or allow metallic or conductive objects to contact the battery terminals.
 - Avoid dropping the device or battery. If dropped, especially on a hard surface, and the user suspects damage to the battery, take it to a service center for inspection.
 - In the event of a battery leak, do not allow the liquid to come in contact with the skin or eyes. If contact has been made, wash the affected area with large amounts of water and seek medical advice.
 - Battery usage by children should be supervised.
-

Power supply safety



WARNING - Use only AC and vehicle adapters intended for the device. Other external power sources may damage your product and void the warranty.

- Ensure the input voltage on the adapter matches the voltage in your location. Ensure the adapter has prongs compatible with your outlets.
 - The AC power supply is designed for indoor use only. Avoid using the AC power supply in wet areas.
 - Unplug the power supply from power when not in use.
 - Do not short the output connector.
-

Touchscreen glass



CAUTION - The touch screen on this device is made of glass. This glass could break if the device is dropped on a hard surface or receives a significant impact. If the glass chips or cracks, do not touch or attempt to remove the broken glass. Cracked or chipped glass due to misuse or abuse is not covered under the product's limited warranty.

Service safety



WARNING - Do not attempt to take apart, open, service, or modify the product, accessories, or power supply. Doing so could present the risk of electric shock or other hazard. Any evidence of any attempt to open and/or modify this device, including any peeling, puncturing, or removal of any of the labels, will void the Limited Warranty.

Safe environments of use



WARNING - Areas with potentially explosive atmospheres are often, but not always, posted and can include fueling areas, such as below decks on boats, fuel or chemical transfer or storage facilities, or areas where the air contains chemicals or particles, such as grain dust, or metal powders. When you are in such an area, turn off your mobile device, and do not remove or install battery chargers, AC adapters, or any other accessory. In such areas, sparks can occur and cause an explosion or fire.

Distraction



WARNING - Using the device in some circumstances can distract you and may cause a dangerous situation. Observe rules that prohibit or restrict the use of mobile devices (for example, avoid operating the device while driving a vehicle).

Telecommunications & Internet Association (TIA)

Hearing Aids: Some digital wireless phones may interfere with some hearing aids. In the event of such interference, you may want to consult your service provider, or call the customer service line to discuss alternatives.

Pacemakers and Other Medical Devices: The Health Industry Manufacturers Association recommends a minimum separation of six inches be maintained between a handheld wireless phone and a pacemaker to avoid potential interference with the pacemaker. These recommendations are consistent with the independent research by and recommendations of Wireless Technology Research. Persons with pacemakers should use the ear opposite the pacemaker to minimize the potential for interference. If you have any reason to suspect that interference is taking place, turn the phone OFF immediately.

If you use any other personal medical device, consult the manufacturer of your device to determine if they are adequately shielded from external RF energy. Your physician may be able to assist you in obtaining this information.

Turn the phone OFF in health care facilities when any regulations posted in these areas instruct you to do so. Hospitals or health care facilities may be using equipment that could be sensitive to external RF energy.

Specific Absorption Rate (SAR)

This device complies with FCC and CE standards when used as designed. Due to radio frequency emissions, it is unsafe to operate the radio with the device in a holster, dangling from a lanyard, or with any method that keeps the powered device in very close proximity to the head or torso. For safe operation, carry the device in your hand with the antennas located at least 20 cm (~8 inches) from the head or torso. SAR is measured with this device at a separation of 5mm to the body, while transmitting at the highest certified output power level in all frequency bands of this device. Keep this device at least 5mm away from your body to ensure exposure levels remain at or below the as-tested levels.

Caring for your device

Cleaning

Turn off the device, and remove it from external power. Use a soft, dampened cloth with either water or a diluted mild detergent. If a mild detergent is used, ensure all soap residue is removed. Do not use chemical cleaners.

Touchscreen care

Ranger 5 / TSC5 is extremely rugged, and is designed to withstand extreme conditions and harsh treatment, however taking proper care of your touchscreen will prolong the life and ensure optimal display performance of the touchscreen of this product. Excessive or prolonged exposure to abrasives, oil, dust, chemicals, and ultraviolet light can affect the performance of your touchscreen over time.

- **Clean it frequently.** Use a soft, lint-free cloth to wipe the screen. You can dampen the cloth with water or an eyeglass cleaner. If the display is very dirty, it can be washed off under a gently running tap.



WARNING - Make sure that all ports and doors are fully closed, and that the device is not connected to an external power supply. Do not use chemical or abrasive cleaners.

- **Keep it covered when not in use.** Store the Ranger 5 / TSC5 in a carry case or pouch while

you're in transit or not using it.

- **Keep it out of the sun when not in use.** Do not store your Ranger 5 / TSC5 in direct sunlight for a long time unnecessarily. Ultraviolet light and excessive heat from sun-loading heat can damage the display.
- **Use proper touchscreen tools.** Use either fingers or the Ranger 5 / TSC5 stylus pen, or other devices specifically designed for use with capacitive touchscreens to operate the touchscreen of this device. The use of ballpoint pens, metal tools or other sharp objects to operate the touchscreen may scratch and/or damage the surface of the touchscreen.
- **Avoid drops, tumbles, and abrasives.** Ranger 5 / TSC5 is designed to resist damage for drops up to 122 cm (4 feet). However, you should protect the display from impact, pressure, and abrasive substances that can scratch it or crack it. The device should not be dropped unnecessarily. Use the screen protectors to keep the touchscreen clean and protected, following the instructions provided on the screen protector packaging.

Battery care

Use and Storage Temperature: Lithium-ion batteries are sensitive to high temperatures, so keep the device's batteries out of direct sun for long periods, and don't leave batteries in a hot car, especially on a dashboard in full sun or other environments where temperatures can exceed +70 °C (+158°F). Battery life can be shortened if stored or operated outside of these temperature ranges. The batteries have a storage temperature rating of (-40 °F to 158 °F), however, for maximum battery life, the recommended storage temperature is at room temperature (~+20°C/+68°F). When you are using the device or charging the batteries, it is normal for the device and batteries to get warm.

If the interior temperature of the device exceeds normal operating temperatures (for example, in a hot car or in direct sunlight for extended periods of time), you may experience the following as it attempts to regulate its temperature automatically:

- The device stops charging
- If the device can't regulate its internal temperature, it may go into Sleep state until it cools.

Move the device to a cooler location out of direct sunlight and wait a few minutes before trying to use the device again.

Charging: Recharge the batteries any time; the batteries do not need to be empty or low before you recharge them. However, it is best to let the battery run to below 10 percent at least once a month before you recharge it. Battery recharging is supported at temperatures between 0 °C and +45 °C (+32 °F and +113 °F). Use only the manufacturer designated charging accessories to recharge the batteries.

Other environmental conditions: The batteries are sealed from water and dust, and are tested for protection from drops from heights up to 122 cm (4 feet). However to prolong the life of the battery, dry it off with a cloth if it becomes wet, do not intentionally submerge the battery, and take care to avoid unnecessary drops, mechanical shocks, and vibrations.

The Ranger 5 / TSC5 is designed to work in ambient temperatures between -30 °C and +60 °C (-22 °F and +140 °F), and to be stored in temperatures between -40 °C and +70 °C (-40 °F and +158 °F). Avoid exposing the device to dramatic changes in temperature or humidity.

Product specifications

Physical	Size 288.4 x 176 x 42.3 mm (11.35 x 6.93 x 1.67") Weight 1 kg (2.2 lb) Housing PC-EXL9330 Case with TPU-Texin990 Overmold
Operating System	Android 10 (Q)
Processor	Qualcomm SDA660
Graphics	Intel HD Graphics
RAM	4GB LPDDR4X RAM
User storage	64 GB Flash eMMC
Display	5-inch, HD landscape display 1280x720 pixels 300 DPI Transflective type TFT Display 365 cd/m ² sunlight readable LED backlight Projective capacitive multi-touch touchscreen with stylus, touch, and glove modes
Keyboard	International backlit Alpha-Numeric & QWERTY with Fn keys (12 physical + x 2nd function Fn keys)
Battery & Power	<p>Batteries</p> <ul style="list-style-type: none"> Internal Li-Ion batteries 4530 mAh / 7.2V (32.6 Wh) nominal capacity Removable, warm swappable Li-Ion accessory battery pack provides an additional 32.6 Wh <p>Battery Life</p> <ul style="list-style-type: none"> RTS or GNSS RTK usage approx. 10 hours, can range xx-xx hours (depending on display settings, connectivity, data processing, ambient temperature, etc.) Fully charged battery can support sleep state for 9.5 days and standby for 6.4 days <p>Charging Time</p> <ul style="list-style-type: none"> Full-charge 4 hours, fast-charge (0-50%) 2 hours <p>Power Input</p> <ul style="list-style-type: none"> 5V/9A charging, USB-PD compliant with Type C connector
Notification LED	Charging LED indicator and Fn, Shift, AltGr LEDs
I/O	x1 USB 3.0 Type-C PD Host/Client port for charging and data transfer; supports charger inputs up to 9V/3A x1 EMPOWER module bay
Audio	1W Mono Speaker Dual Microphones with noise cancelling technology USB-C port for external headsets
External speaker / microphone	USB-C port for external headsets Bluetooth headsets supported
Bluetooth	Bluetooth 5 classic & BLE 5, Class 1
Wi-Fi	2.4 GHz 802.11 b/g/n/ac & 5.0 GHz 802.11a/n/ac
Mobile broadband	Worldwide LTE 4G in regions where it is available, and compatible with 3G networks

/ WWAN (optional)	AT&T and Verizon certified. MicroSIM card
GNSS	Integrated Sierra Wireless EM7565 chipset L1 C/A GPS/GLONASS/BeiDou/Galileo/QZSS <10 m accuracy
Camera	Rear camera: 13MP auto-focus with LED flash
Sensors	Orientation: 3-axis accelerometer, Magnetic heading sensor (E-compass), 3-axis Gyroscope. Display: Ambient light sensor, proximity sensor
Environmental	<p>IEC-529: Independently tested and certified for:</p> <ul style="list-style-type: none"> • Water Ingress Protection: IPx5 • Sand & Dust Ingress Protection: IP6x <p>MIL-STD-810H: Independently tested and certified for:</p> <ul style="list-style-type: none"> • Operating temperature: -30 °C to +60 °C (-22 °F to 140 °F) • Storage temperature: -40 °C to +70 °C (-40 °F to 158 °F) • Charging temperature: 0 °C to 45 °C (32 °F to 113 °F) • Temperature Shock, operating: Survives cycles between -30 °C and 60 °C (-22 °F and 140 °F) • Humidity: 90% RH temp cycle +30 °C / +60 °C (+86 °F / +140 °F) • Vibration: General Minimum Integrity and Loose Cargo Test • High altitude (low pressure) operation to 9,144 m (30,000 ft) and storage 12,192m (40,000 ft) • Drop / Shock protection: 26 drops at room temperature from 1.22 m (4 ft) onto concrete <ul style="list-style-type: none"> ◦ Ball drop protection steel ball 0.5 m on to touch panel • Solar Radiation Exposure: Survives prolonged solar exposure
Environmental Certifications	EU RoHS, China RoHS, REACH, WEEE
Regional Compliance	...FCC, NRTL, ICES, IC, ACMA, RSM, ANATEL, BIS, WPC, MCMC, CERT, CE, CB, TRA, NCC, ICASA, RCM, VCCI, KC, CCC, SRRC, FAC, EAC, BSMI approvals, NRTL scheme
Security	
Configuration Options: EMPOWER Modules	x1 EMPOWER module bay supports: <ul style="list-style-type: none"> • EM100 GNSS Receiver Module • EM120 2.4 GHz Receiver Module • EM11x Barcode/RFID Modules • Custom modules
Compatible Trimble Field Software	Android 10 applications Trimble Access version 2020 and later Spectra Geospatial Survey Pro Siteworks Capture Trimble Unity Trimble Forensics Capture Trimble GasOps LoaderWiz Trimble Catalyst GNSS Direct

Chapter 1: Introduction to the Trimble Ranger 5 data collector / Trimble TSC5 controller

- Registration
- Configuration options
- In the box
- Replacement and spare or optional accessories
- Parts of the Ranger 5 data collector / TSC5 controller

This user guide describes how to configure and use the Trimble® Ranger® 5 data collector / Trimble TSC5 controller powered by the Android® 10 operating system. The information in this guide supplements the information in the Quick Start Guide, which you receive in the box with the device.

Even if you have used other Trimble handheld field computers, data collectors or survey controllers before, Trimble recommends that you spend some time reading this guide to learn about the special features of the product.



WARNING - Before you use this product, make sure that you have read and understood all safety requirements. Failure to follow these safety instructions could result in fire, electric shock, or other injury, or damage to the device and/or other property. For more information refer to the [Important safety information](#) section of this guide.

Registration

To receive information regarding updates and new products, contact your local dealer or visit the Trimble customer registration website at www.trimble.com/register or go to <https://mytrimbleprotected.com/cc/productsRegistration.html>. When you register your device, you can select the newsletter, upgrade, or new product information.

To register your device, you will need the serial number. The serial number is a unique 12 digit number for your Ranger 5 / TSC5, for example, JAJ201300096, and is located on a label inside the removable battery / SIM door compartment.



Configuration options

The Ranger 5 data collector / TSC5 controller is powered by the Android 10 operating system, and has a built in QWERTY keypad, integrated Wi-Fi, Bluetooth® wireless technology, and optional worldwide 4G LTE Cellular WWAN connectivity (data only).

For a full list of product features and their specifications, refer to the [Product specifications](#) section of this user guide, or see your local Trimble reseller for information.

In the box

A standard pack-out has the following items:

- Ranger 5 data collector / TSC5 controller
- AC power supply with regional plugs and USB-C port
- USB-C to USB-C cable for charging and data transfer
- Glass screen protector
- Capacitive stylus with tether, 2 extra stylus tips and Phillips #1 screwdriver
- Handstrap
- Protective pouch

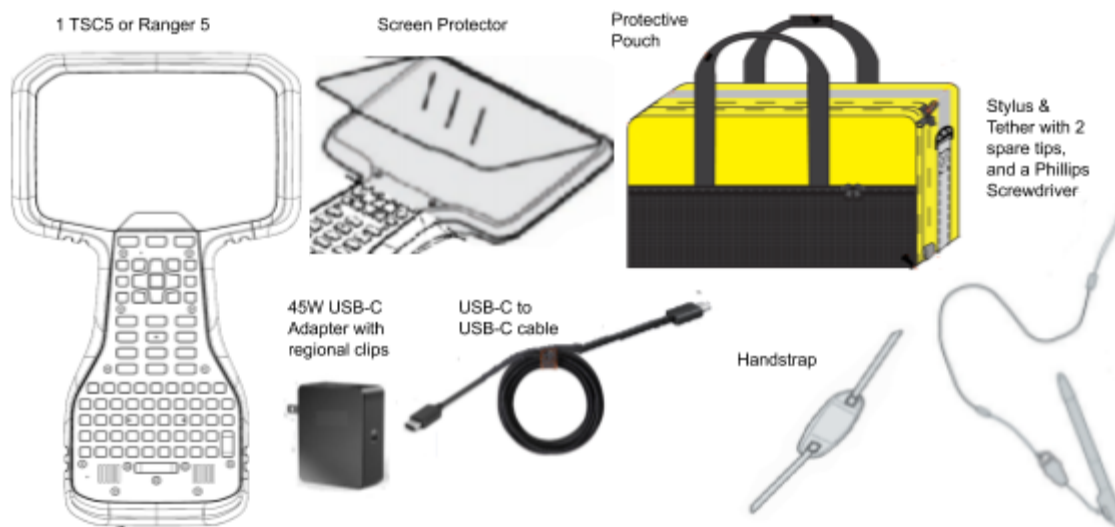

Replacement and spare or optional accessories



WARNING - Only Trimble approved accessories should be used with this product. Failure to use Trimble approved accessories could result in fire, electric shock, or other injury, or damage to the handheld computer and/or other property. For more information refer to the Safety Information section of this guide, page XXX.

A wide range of replacement and optional accessories are available to purchase for the Ranger 5 / TSC5, including:

- AC power supply with regional plugs and USB-C port
- USB-C to USB-C cable for charging and data transfer
- Tempered glass screen protector (1-pack)
- Capacitive stylus with tether, 2 extra stylus tips and Phillips #1 screwdriver
- Pack of 5 replacement stylus tips

- Handstrap
- Protective pouch
- Removeable, rechargeable accessory battery pack to double battery run time
 - Compatible with the Ranger 5 / TSC5 USB-C power supply and USB-C to USB-C cable
- Accessory screwdriver
- USB-A to USB-C cable
- Ranger 5 / TSC5 quick release pole mount bracket
- Quick release pole mount clamp
- Fabric shoulder bag
- USB Desktop Hub
- Shoulder Sling

Trimble EMPOWER Modules

The following Trimble EMPOWER modules are also available:

- Trimble EM120 2.4GHz Radio Module
- Trimble EM100 GNSS Receiver Module
- Trimble EM110 1D/2D Barcode Imager Module
- Trimble EM111 1D/2D Barcode Imager & UHF 902-928 MHz RFID – NA
- Trimble EM111 1D/2D Barcode Imager & UHF 865.6-867.6 MHz RFID – EU
- Trimble EM112 1D/2D Barcode Imager & UHF 902-928 MHz RFID with AEI – NA

Parts of the Ranger 5 data collector / TSC5 controller

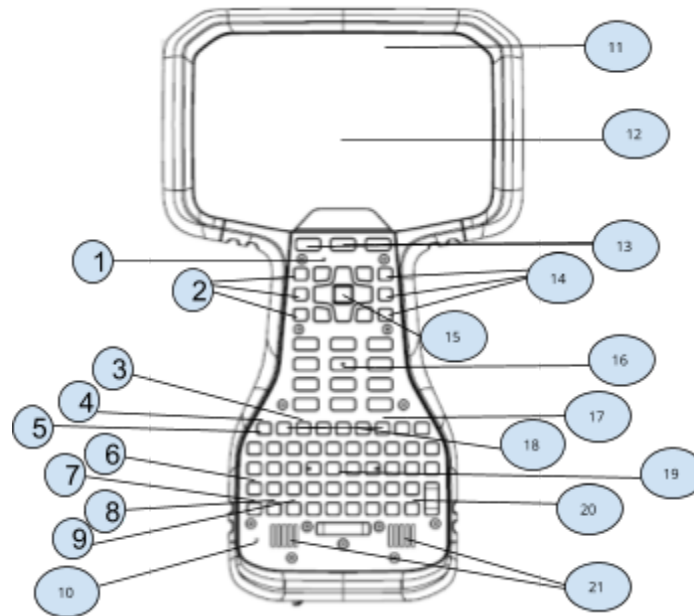

- | | | |
|-------------------------|--------------------------------------------------------|--------------------------|
| 1. Microphone | 9. Search LED | 17. Cursor Lock LED |
| 2. F1- F3 Function Keys | 10. Microphone | 18. F7-F12 Function Keys |
| 3. Caps Lock LED | 11. Ambient Light Sensor | 19. QWERTY Keyboard |
| 4. Battery Charging LED | 12. Touchscreen | 20. AGr LED |
| 5. Power Button | 13. Android Keys | 21. Speakers |
| 6. Shift LED | 14. F4-F6 Function Keys | |
| 7. Fn LED | 15. OK Key, surrounded by 4
directional spider keys | |
| 8. Ctrl LED | 16. Numeric Keypad | |

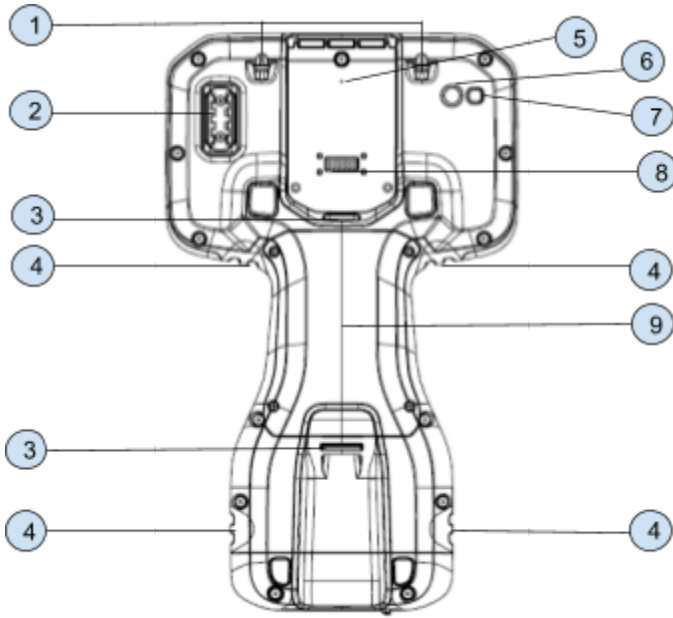

- 1. Stylus Tether Points
- 2. Stylus Holder
- 3. Pole Mount Latches
- 4. Hand strap Connector Points
- 5. Gore Vent; **do not cover this!**

- 6. Rear Camera
- 7. LED Camera Flash
- 8. EMPOWER Module Bay
- 9. Cover for optional battery pack & SIM Card Slot; remove with 4 screws using stylus screwdriver

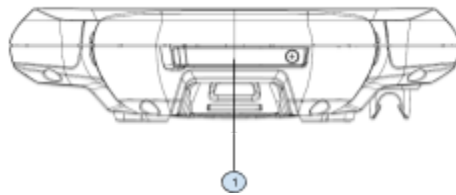

- 1. USB Type C Port, under the port cover

Chapter 2: Basic setup and operation

- Inserting a SIM card
- Installing and removing the optional accessory battery pack
- Tethering the stylus
- Installing the screen protector
- Attaching the pole bracket
- Attaching the handstrap
- Charging and power modes
- Setting up your Ranger 5 / TSC5 for the first time
- Using the touchscreen
- Using the integrated keyboard

This section tells you how to get started using your Ranger 5 / TSC5 and explains some basic operating system features. When you start your device for the first time, the Android operating system will take you through some basic set-up steps; follow the instructions on the screen.

For more details on setting up and using the Android operating system, see [Using the Android 10 operating system](#) or visit the [Android 10 website](#).

Inserting a SIM card

If your Ranger 5 / TSC5 device configuration is equipped with a 4G LTE modem you will require a data plan and microSIM card from your local cellular service provider to use cellular data. If you are unsure, check with your mobile operator. See [Working with mobile broadband](#) for more information.



WARNING - Do not replace the SIM card while outdoors. Water, dust, dirt or debris may collect inside the SIM card bay causing performance issues.



CAUTION - The SIM card door can be damaged if handled carelessly or if sharp tools are used to open the door. Take care not to twist or warp the door when opening or closing it.

1. If the device is on, turn it off; press and hold the Power key, then tap **Power off**.
2. Using the Philips screwdriver integrated into the stylus pen, loosen the 4 screws to remove the battery bay cover from the back of the device.
 - a. NOTE - If the accessory battery is installed, remove it to access the SIM card door.





3. Pry open the SIM bay splash cover using a coin or the tool located on the stylus tether as shown; do not remove the door completely.

<add photo of sim card bay and orientation of a SIM card

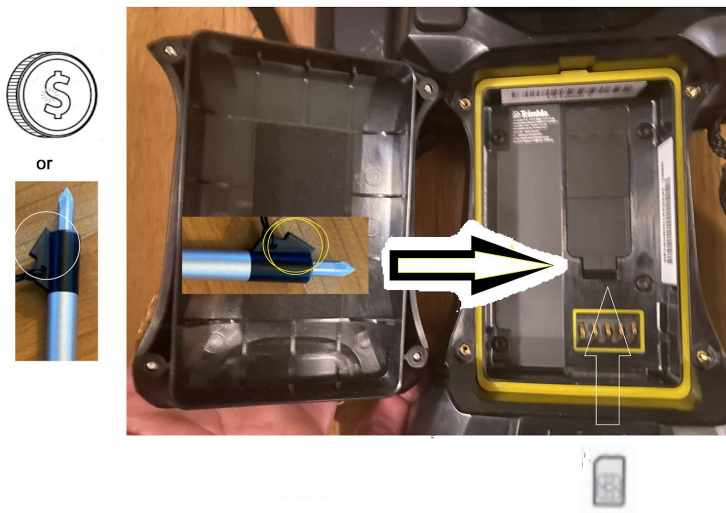

4. Slide the microSIM card into the bay in the orientation shown.

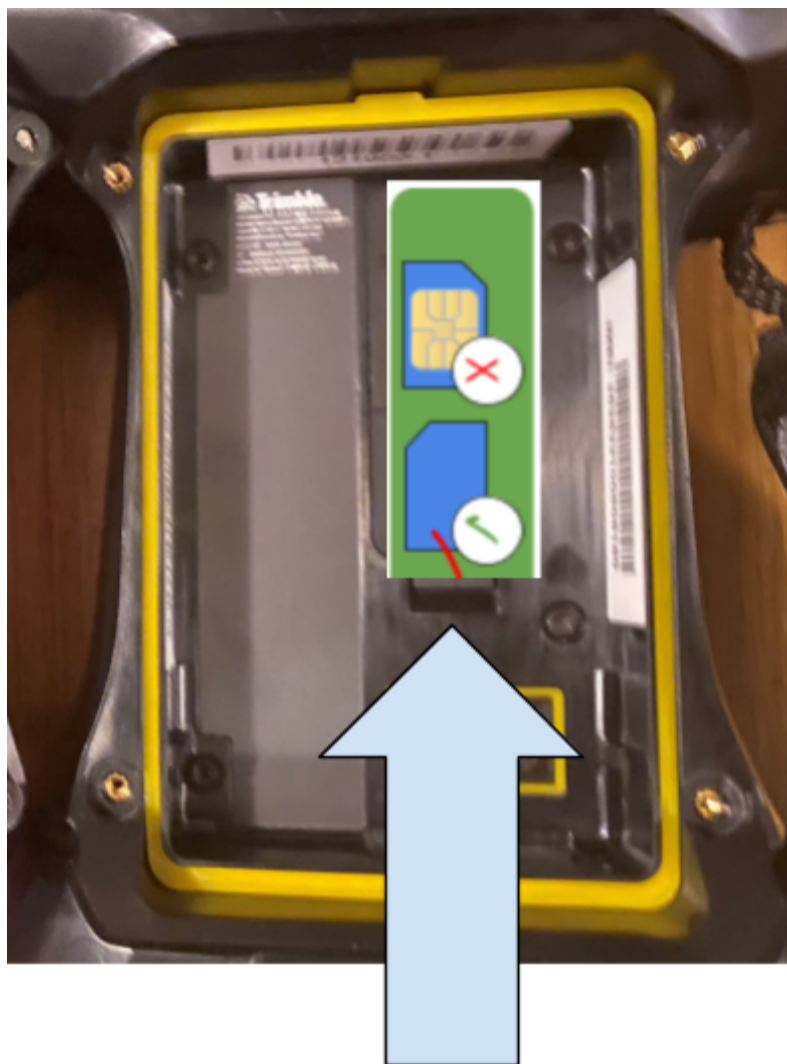

5. Close the SIM card bay splash cover, making sure it clicks into place
6. See the next section to [Install the optional accessory battery](#)
7. Replace the battery bay cover and tighten the 4 screws using the stylus screwdriver.

Installing and removing the optional accessory battery pack

The Ranger 5 / TSC5 contains internal batteries which are not removable. An optional, user replaceable accessory battery pack is also available to double the battery runtime.

If you are using the optional user replaceable accessory battery pack, it may be charged while installed in the device or externally to decrease total charging time. See [Charging the optional user replaceable accessory battery](#) for more information.

The battery pack for the Ranger 5 / TSC5 is warm swappable. If the internal batteries have power remaining, the accessory battery pack may be removed and replaced with a fully charged battery while the device is still running on internal batteries, without shutting down or needing to restart the device.



CAUTION - If the internal batteries are fully depleted and you remove the accessory battery, the device will instantly turn off due to power loss. Ensure that the internal batteries have some charge or work may be lost.

Trimble strongly recommends that before you swap a battery:

- In the Trimble Access software, you complete your task;
- In all other applications, you save your data



WARNING - Do not replace the accessory battery pack while outdoors. Water, dust, dirt or debris may collect around the battery contacts causing performance issues.

Installing the optional accessory battery pack

1. The accessory battery pack may be installed while the device is on or off. However, if the internal batteries are low on charge and the device is on, you should complete your task, save your work and turn it off; press and hold the Power key, then tap **Power off**.
2. Ensure you are indoors when you remove the battery bay door cover and install the accessory battery pack to avoid dust or water from entering the battery bay.
3. Using the Philips screwdriver integrated into the stylus pen, loosen the 4 screws to remove the battery bay cover from the back of the device.

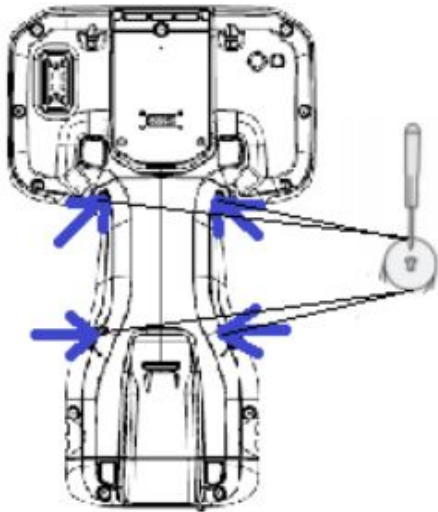

4. Insert the battery as shown:



5. Replace the battery bay cover and tighten the 4 screws using the stylus screwdriver.

Removing / warm-swapping the optional accessory battery pack

1. The accessory battery pack may be removed while the device is on only if the internal batteries have sufficient charge to keep the device on. If the internal batteries are fully depleted and you remove the accessory battery, the device will instantly turn off due to power loss, which may result in lost work.
 - a. Check the charge level of the internal batteries (see [Checking the battery level of the internal batteries and the accessory battery pack in the OS](#)).
 - b. Check the charge level of the accessory battery pack in the same location as internal batteries, or by pressing the button on the battery pack, if removed (see [Checking the battery level](#)).
2. If the internal batteries are low on charge and the device is on, before replacing the battery, you should either plug the device into a power source or complete your task, save your work and shut the device down to prevent loss of data.
 - a. To turn the device off; press and hold the Power key, then tap **Power off**.
3. Ensure you are indoors when you remove the battery bay door cover and install the accessory battery pack.
4. Using the Philips screwdriver integrated into the stylus pen, loosen the 4 screws to remove the battery bay cover from the back of the device.
5. Remove the battery, lifting up and out.
6. Replace the battery with a fully charged battery if available.
7. Replace the battery bay cover and tighten the 4 screws using the stylus screwdriver.

NOTE – the Ranger 5 / TSC5 consumes electricity even when the device is off. Depending on how your system is configured, if the battery pack is fully charged, it will fully discharge in approximately the following period of time:

Power state	Discharge period
When power is off	Approximately X days.
In sleep/suspended	Approximately X days.
In hibernation	Approximately X days.

Tethering the stylus

Attach the stylus to the device to prevent accidentally dropping the stylus. The stylus is supplied with one end of the tether cord pre-looped to the stylus. You can attach the stylus to the left or right side of the device. To tether the stylus to the device:

1. Take the loose end of the tether cord and push it through the tether point.
2. Feed the stylus through the loop and pull tight.
3. Place the stylus in the stylus dock to store it when not in use (top left corner as in image below).

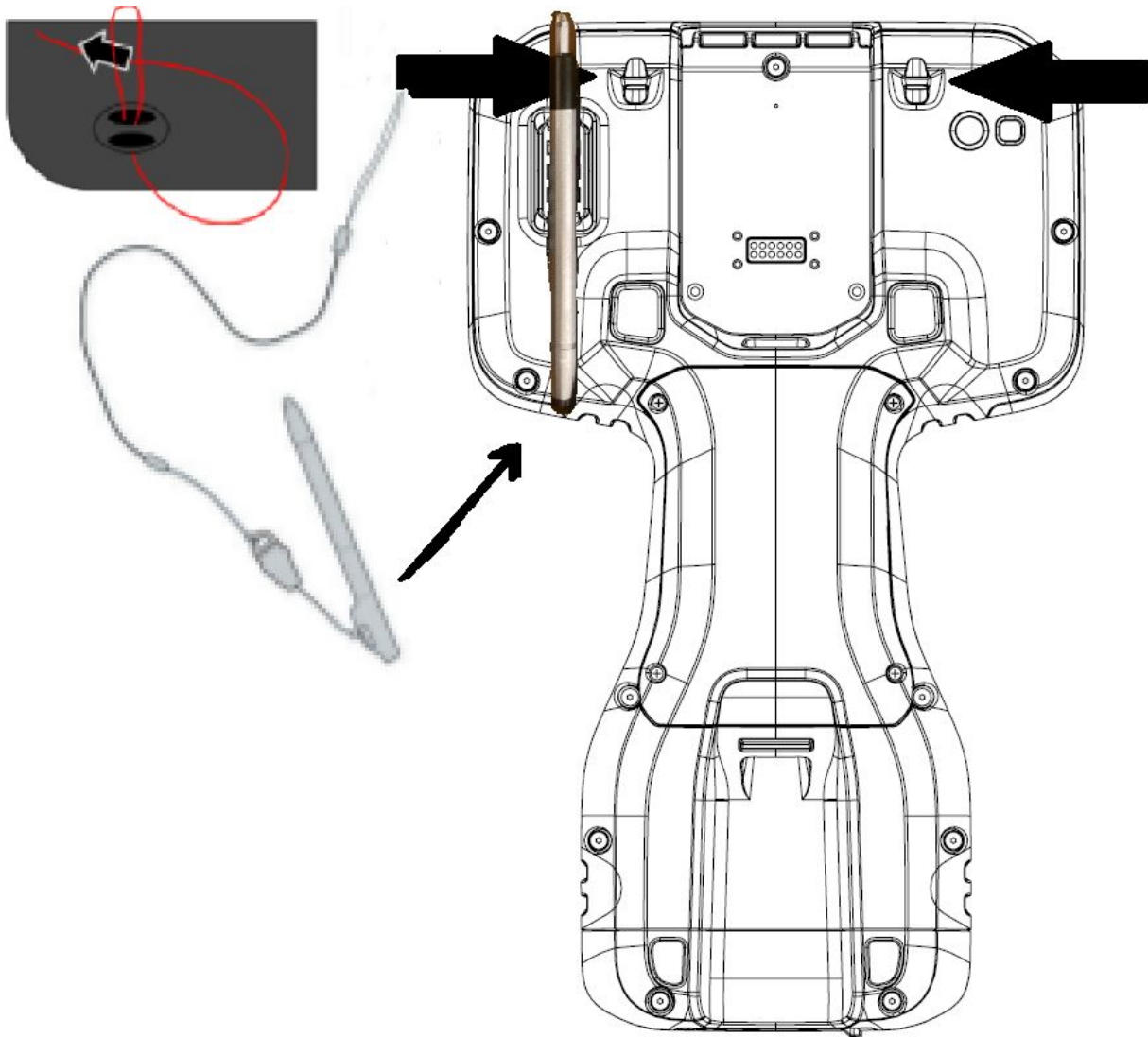

Installing the screen protector

The Ranger 5 / TSC5 device is fitted with a chemically strengthened glass touchscreen which is highly resistant to abrasion and impact damage. However to ensure maximum protection, it is recommended that you use a Trimble-approved toughened glass Ranger 5 / TSC5 screen protector.

To install the screen protector:

1. Place the device on a clean, flat surface. Make sure your hands are clean.
2. Clean the touchscreen with the supplied alcohol wipe, damp cloth, or similar.

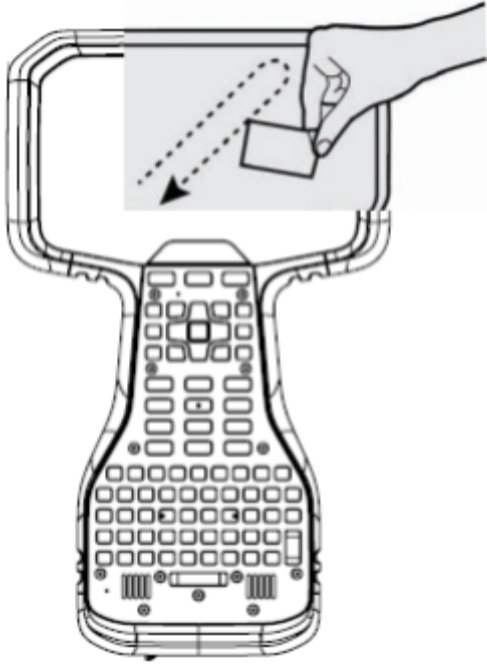

3. Polish and dry the screen with the lint-free cleaning cloth supplied.

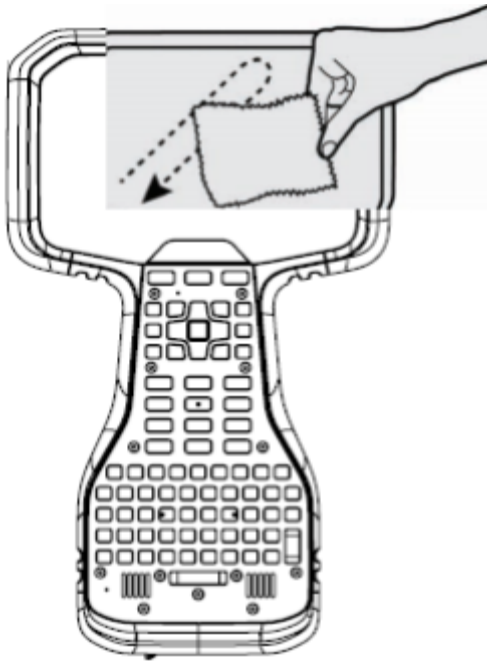

4. Remove any dust specs with the supplied dust sticker.

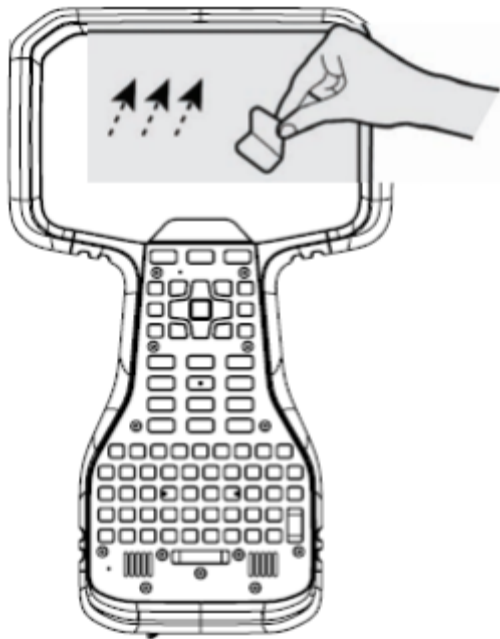

5. Remove the protective film from the screen protector.

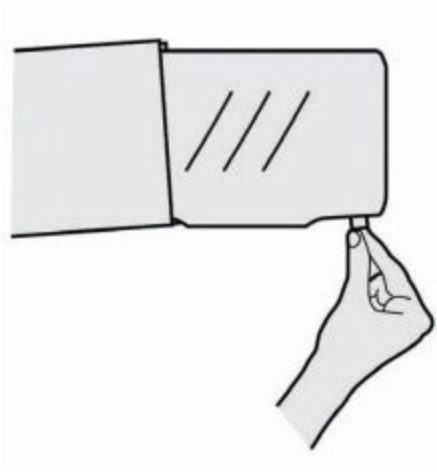

6. Align the screen protector with the top of the glass display. Use the Ranger 5 / TSC5 label at the top of the keypad as a guide. The screen protector should line up evenly with the Ranger 5 / TSC5 label and the edges of the device.

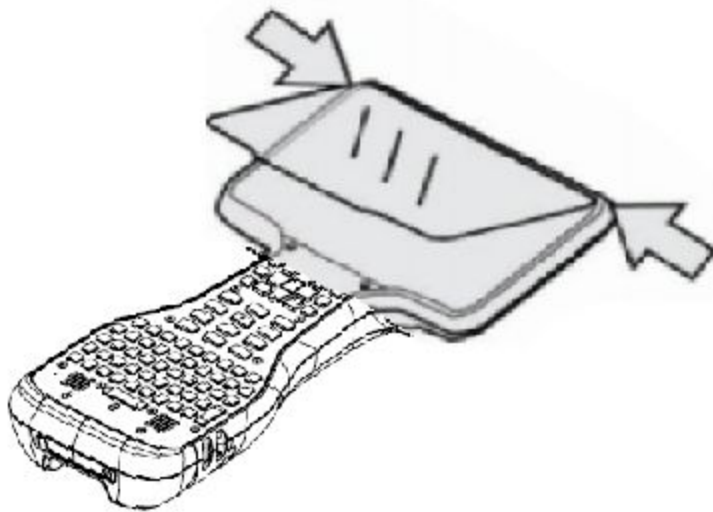

7. Carefully lay the screen protector down on the screen. If you make a mistake and the glass looks off-center, you can gently lift it up and realign it. Then, once the protector is on the screen, give it a soft press in the center and allow the adhesive surface to grip to the screen naturally.

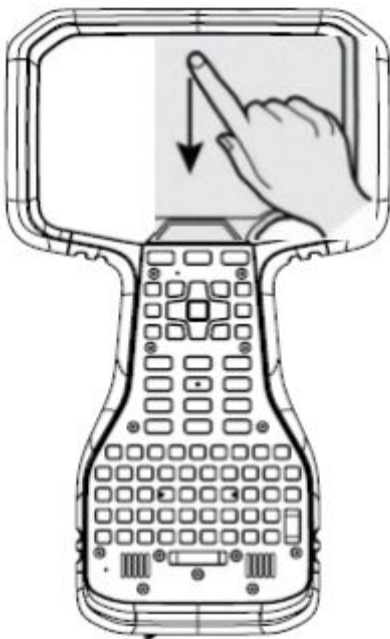

TIP – You can place the screen protector in place and fix it on the upper side with adhesive strips to the housing. This will keep the screen protector aligned when sticking in on.

8. If there are any bubbles remaining, use the cloth provided to gently smooth them toward the edges of the glass protector.

For more information on where to purchase the correct screen protector for your device, contact

your local Trimble reseller.

Attaching the pole bracket

An optional accessory for the Ranger 5 / TSC5 controller, the pole mount consists of three parts:

- The Ranger 5 / TSC5 facing part.
 - This is a custom bracket mount which attaches to the Ranger 5 / TSC5.
- The adjustable arm.
 - One end screws onto the custom Ranger 5 / TSC5 bracket mount, and the other end includes a connector that is compatible with other Trimble mounting products.
 - The arm can be set up for left or right hand usage. To switch it from one side to the other, unscrew the black screws in the cradle plate where the device sits, rotate the cradle plate, then screw it back into place.
 - This is a part which is also used for the Ranger 7 / TSC7.
- The pole-facing part.
 - One side attaches to the connector on the adjustable arm, and the other side includes the pole clamp.
 - This is a part which is also used for the Ranger 7 / TSC7 and other Trimble products.
 - The pole-facing part is compact, so that it fits into a 10 cm (4") pipe for storage.

The Ranger 5 / TSC5 bracket mount “snaps” easily onto the controller. To attach the bracket to the Ranger 5 / TSC5 controller, you will first need to screw on the adjustable arm to the bracket mount. Next, to install the bracket onto the Ranger 5 / TSC5, place the bracket hook into the mount point directly above the battery door on the Ranger 5 / TSC5. Then, pull down on the spring mechanism on the bottom of the bracket mount and push firmly into the controller to snap into place.

To remove the bracket mount from the Ranger 5 / TSC5 controller, pull down on the spring mechanism and lift up to remove.

When the pole bracket mount and adjustable arm are attached to the Ranger 5 / TSC5 controller, it “snaps” easily into the cradle of the pole clamp assembly. To attach the Ranger 5 / TSC5 controller onto the pole mount, place the connector on the adjustable arm into the pole clamp and then push it firmly into the snap lock. To remove the Ranger 5 / TSC5 controller from the pole clamp, on the back of the locking mechanism, pull the lever to release the Ranger 5 / TSC5 controller.

Attaching the handstrap

Attach the handstrap to the left or the right side of the device, according to your personal preference. To ensure a good fit:

1. Thread one end of the handstrap ribbon through the top handstrap slot; thread from the center of the device toward the top of the device.
2. Pull the end of the ribbon back towards the center of the handstrap and feed it up, over, and down through the lock buckle on the handstrap and pull it tight.
3. Thread the ribbon at the other end of the handstrap through the bottom handstrap slot; thread from the center of the device toward the bottom of the device.
4. Pull the end of the ribbon back towards the center of the handstrap and feed it up, over, and down through the lock buckle on the handstrap and pull it as tight as is comfortable for your hand. If required, use a small blunt tool to push the ribbons through the handstrap slots on the device. Do not use a sharp tool. When using the handstrap, the device should sit firmly in the hand.

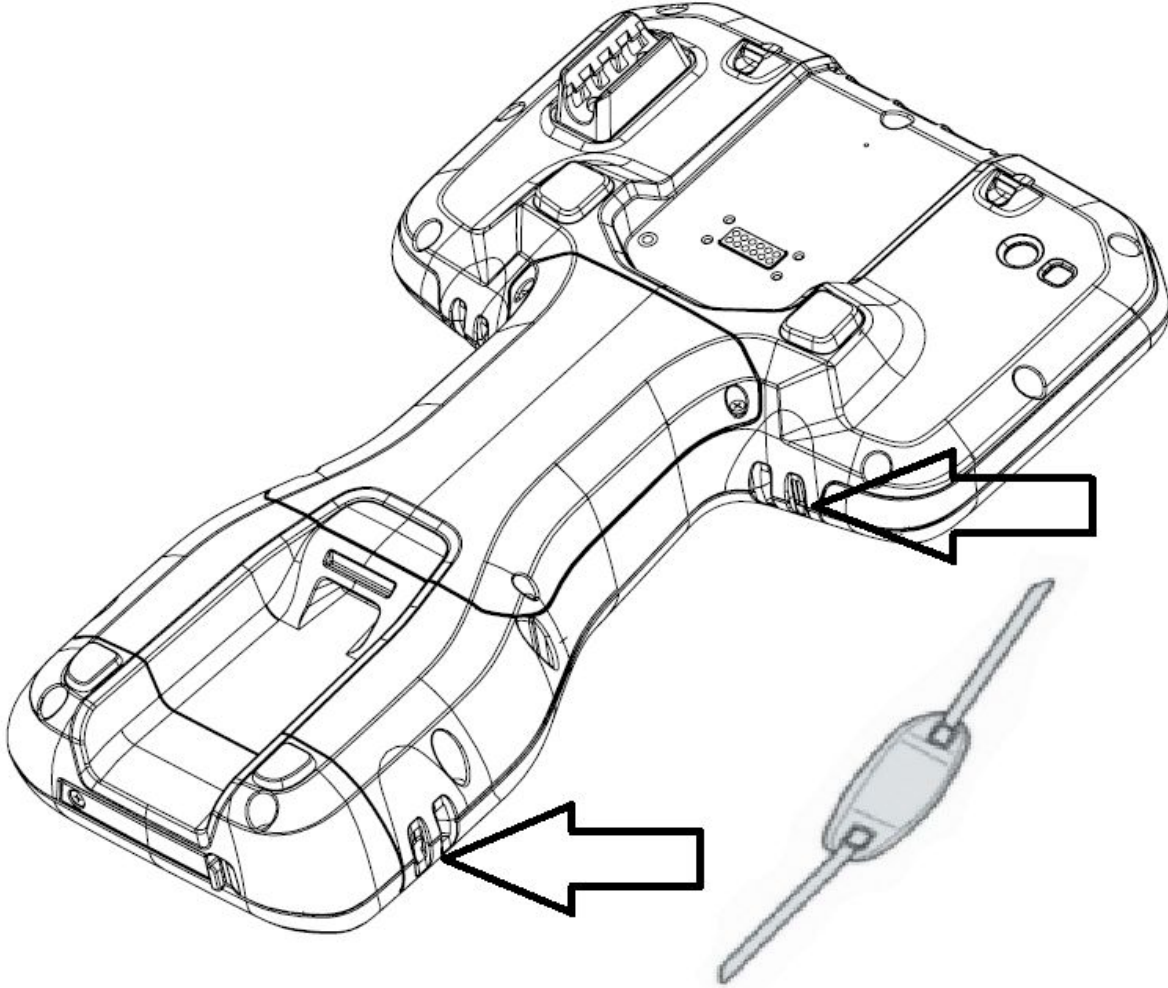

Charging and power modes

It takes approximately 4 hours to fully charge the Ranger 5 / TSC5 internal batteries from an empty state using the AC adapter and USB-C to USB-C cable included in the packout. If you are using the optional user replaceable accessory battery pack, it may be charged while installed in the device or externally. While installed in the device, the total time to fully charge both internal and accessory batteries, when in an empty state, is approximately 8 hours. It may take longer if you are using your device for power-intensive activities, for example using GNSS or processing a lot of data while you are charging it.

For details on other charging options and charge time for the accessory battery pack, see the section below, [Charging the accessory battery pack](#).



CAUTION - Using 3rd party AC adapters may take longer to charge the batteries.

Charging the internal batteries and the optional accessory battery pack while installed in the Ranger 5 / TSC5

The internal batteries are charged using the USB-C port directly on the bottom of the device. If you have the accessory battery pack installed, it will also be charged through the USB-C port.





1. Connect the appropriate international plug adapter for your region to the AC adapter.
2. Connect one end of the USB-C to USB-C cable to the USB-C port located on the AC adaptor.
3. Connect the other end of the USB-C cable to the USB-C port on the Ranger 5 / TSC5.
4. Plug the power supply into an electrical outlet.



5. The internal Ranger 5 / TSC5 batteries will charge first. When they are fully charged, the optional user replaceable battery pack will charge next, if installed.

LED charging status

The charging status for the batteries is shown with an LED on the keyboard.

-  Green: Ranger 5 / TSC5 is fully charged.
-  Green & Flashing: Ranger 5 / TSC5 is in Sleep state.
-  Orange: Ranger 5 / TSC5 is charging.
-  Red: charging error. It can take the device approximately 30 seconds to recognize a bad battery and indicate a charging error

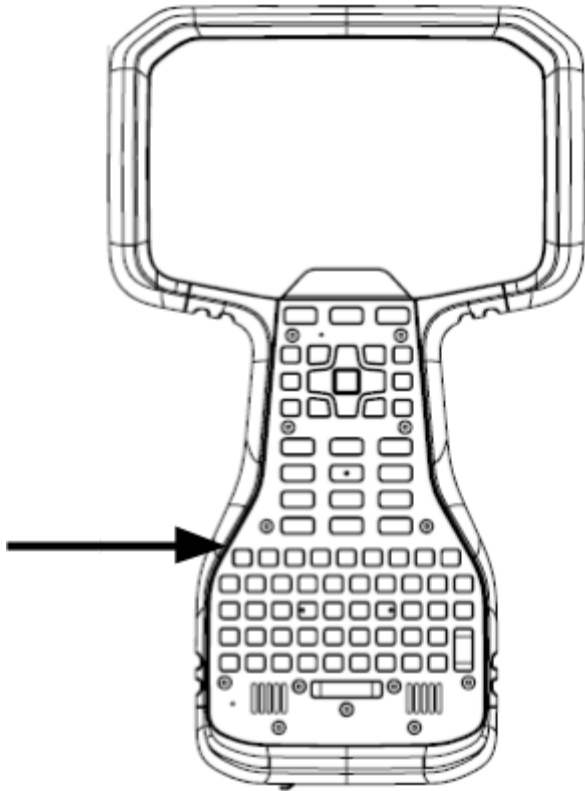

Checking the battery level of the internal batteries and the accessory battery pack in the OS

You can check the battery level of the internal batteries as well as the accessory battery pack from the Status bar.

- The battery status appears in the top-right corner of the **Status** bar. If you have the accessory battery installed, a second battery icon will appear.
- To check the battery status of the accessory battery pack while it is removed from the device, see [Checking the battery pack charge level using the battery indicator](#).
- To access the detailed battery level information for internal and removable batteries, swipe down from the top of the display, tap the **Settings** icon, and tap **Battery**.



Charging the accessory battery pack separately from the Ranger 5 / TSC5

If you are using the optional user replaceable accessory battery pack, it may be charged while installed in the device or externally. To charge the battery pack while installed in the device, see [Charging the internal batteries and the optional accessory battery pack while installed in the Ranger 5 / TSC5](#).

To charge the accessory battery pack outside the Ranger 5 / TSC5 device, you may use the AC

adapter and USB-C to USB-C cable included in the packout or the dual bay battery charger accessory.

Charging the battery pack using the AC adapter and USB-C to USB-C cable included in the packout

It takes approximately 4 hours to fully charge the Ranger 5 / TSC5 accessory battery pack from an empty state using the AC adapter and USB-C to USB-C cable included in the packout while charging outside of the device.

Charging the battery pack using a 3rd party USB-C charger may increase the charge time. Trimble recommends using the USB-C charger and cable provided in the packout of the Ranger 5 / TSC5 for best results.

The accessory battery pack is charged using the USB-C port directly on the battery pack.

1. Connect the appropriate international plug adapter for your region to the AC adapter.
2. Connect one end of the USB-C to USB-C cable to the USB-C port located on the AC adaptor.
3. Connect the other end of the USB-C cable to the accessory battery pack.
4. Plug the power supply into an electrical outlet.

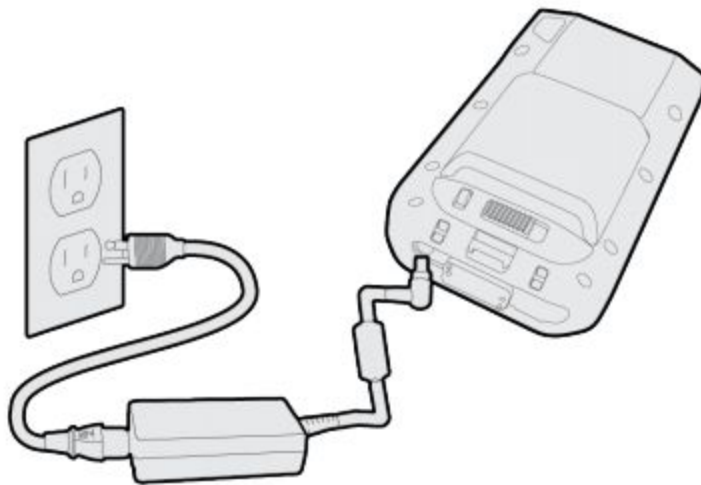

LED charging status on the accessory battery pack

<TODO, or link to accessory battery pack user guide when complete>







Checking the battery pack charge level using the battery indicator

You can check the battery level of the accessory battery pack while it is removed from the device.

- Press and hold the button on the battery to check the battery charge level.



The LEDs on the battery will show one of the following:

Battery pack	Battery Charge Level
	No LEDs are lit: Empty battery
	Green LED flashing = < 10% charged
	Green LED solidly lit = 10-25% charged
	25-50% charged
	50-75% charged
	ALL LEDs are lit: 75-100% charged

Charging the battery pack using the dual bay battery charger accessory

The dual bay battery charger accessory provides a convenient way to charge the accessory battery separately from the Ranger 5 / TSC5 device, decreasing total charge time. It takes approximately 4 hours to fully charge the Ranger 5 / TSC5 accessory battery pack from an empty state using the dual bay battery charger accessory.

To charge the accessory battery in the dual bay battery charger:

1. Connect the power cord with the appropriate regional plug to the AC adapter.
2. Connect the AC adapter to the charging port on the dual bay battery charger.
3. Plug the power supply into an electrical outlet.

To charge the spare battery in the charging dock, place it in one of the charging dock's battery charger slots.



For more information on charging specifications and the charger's LED status indicators, refer to the user guide:

http://trl.trimble.com/docushare/dsweb/Get/Document-856922/DualSlotBatteryCharger_NoCarAdaptor_V2-A.pdf.

Making your battery last longer

The Android 10 operating system includes a number of features to help you get the maximum run time out of your battery. Here are some practical suggestions that you can do to maximize the operating time of the battery:

- **Use Battery Saver mode** to help the device's battery last longer when it is running low. This mode turns off or restricts background activity, some visual effects & other high-power features to extend battery life. To turn on **Battery Saver** mode, swipe down from the **Status** bar and tap the **Battery Saver** icon, then tap **TURN ON**. When Battery Saver mode is on, the battery icon in the **Status** bar is red.

NOTE - Battery saver turns off automatically when your device is charging.

- **Keep Battery optimization on.** To have apps use your device's battery only when they need to, keep Battery optimization on for all apps. **Battery optimization** is on by default.

- 
 - To specify battery optimization for any apps, go to **Settings / Battery**, then tap **Battery usage**. Tap on any app in the list to view options. Under the **MANAGE BATTERY USAGE** heading, you can view or select **Background restriction** and **Battery optimization**.
 - **Background restriction** - to save battery, tap this and then choose **RESTRICT**, which will stop the app from using battery in the background. NOTE: this may cause apps to work improperly and cause delayed notifications.
 - **Battery optimization** - most apps will have the **Optimizing battery use** setting enabled by default. Tap this option to view apps that are not optimized. Select **All apps** from the drop down next to **NOT OPTIMIZED** to view all apps. Select an app from the list to turn Battery Optimization on or off. Turning off is not recommended, as it may drain the battery more quickly as the app will no longer be restricted from using background battery.
- **Stretch a low battery's power.** To help a dying battery last until you can plug in your device, first turn on **Battery saver** mode. Often, battery saver is all you'll need for a low battery's power to last until you can get to a charger. Stretch your remaining battery power with temporary changes to your settings/usage.

Tip: You'll want to turn your features back on when you recharge.

- **Avoid high-drain activities** (for example, heavy screen use, heavy data processing).
- **Turn off the wireless radios** when not using them to limit connectivity (for example, turn on Airplane mode, turn off Bluetooth). See [Using wireless networks](#).
- **Limit location data** (for example, turn on GPS battery saving mode, turn off Location services).
- **Limit automatic syncing** (for example, turn off auto-sync for your Google account, turn off auto-sync for certain Google apps).
- **Unplug USB devices.** Many USB devices use power just by being connected. If you use a USB flash drive, unplug it when you are not using it.
- **Turn off EMPOWER modules if you will not be using them for a prolonged period;** see [Disabling and enabling modules in the EMPOWER Hub](#).
- **Decrease the display brightness** to the lowest comfortable level. See [Display settings](#) for more information.
- Turn off screen rotation. See [Display settings](#) for more information.
- If you don't work in low light settings, disable the keypad backlight. Navigate to **Settings > System > Languages & input > Physical keyboard > Built-in Keyboard**. Tap the slider next to **Enable** to disable the keyboard backlight.
 - You may also adjust the brightness of the keyboard backlight in the same section by moving the slider left or right under the title **Backlight brightness**.
- **Turn off the handheld when you are not using it.** See [Turning off the device](#).

- **Shorten the length of time before the operating system turns off the display.** To further save battery power, ensure the device settings are configured to turn off the screen when you haven't used it for a length of time. See [About Sleep state](#).

For more information on making your battery last longer, refer to the help topic [Get the most life from your battery](#) on the [google.com](#) support site.

Setting up your Ranger 5 / TSC5 for the first time

The first time you use your Ranger 5 / TSC5, the Android operating system will guide you through some basic setup steps.

Press the Power button to turn on your Ranger 5 / TSC5. Android 10 starts and guides you through the setup process. The first time you use your Ranger 5 / TSC5 handheld, you'll be prompted to select a:

- Language
- Wi-Fi network
- Google Account to use with your device.

You can sign up for a Google Account or use one that you already have. You already have a Google Account if you use an email address to sign in to any Google product, for example:

- Gmail
- YouTube
- Google Apps
- Any other Google product

When you sign in with your Google Account, you'll have access to your email, contacts, calendar events, and other data associated with that account. If you have multiple Google Accounts, you can add the others later.

Turning the device on

To turn on the Ranger 5 / TSC5, press and hold the **Power** key until the *Powered by Android* boot screen appears. Swipe up on the touchscreen to enter a PIN or password, if one has been set.

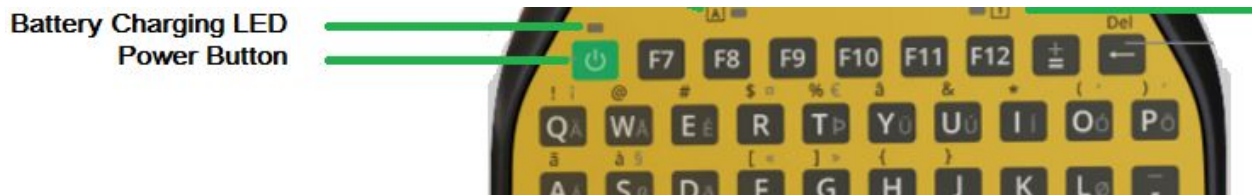

About Sleep state

If you don't use the Ranger 5 / TSC5 for a few minutes, the screen turns off and the device goes into a power-saving Sleep state. Sleep state saves your work, turns off the device and allows your device to resume quickly when you want to start working again.

To force your device to Sleep, briefly press the **Power** key

To set the screen turn-off time, navigate to **Settings / Display / Advanced / Screen timeout**, and select 2, 5, 10 or 30 minutes.

Waking and unlocking the device

To wake the screen when it has turned off, briefly press the **Power** key.

Depending on your security settings, your device may be locked. To unlock it, swipe up on the screen

then enter your password, PIN, or unlock pattern.

Restarting the device

To restart your device, press and hold the Power key until the **Power** menu appears, then tap **Restart**.

Turning off the device

To turn off the device, press and hold the Power key until the **Power** menu appears, then tap **Power Off**.

Interacting with the device

Your Ranger 5 / TSC5 can be easily operated with the touchscreen (using your fingers, a stylus, or a glove), a mouse, an onscreen keypad, or the full built-in keypad. You can easily switch between any of these input methods.

Using the touchscreen

Switching between finger, glove and stylus mode

Open Touch Panel Mode settings to select or switch between Finger, Glove, and Stylus mode.

- Swipe down on the **Home** Screen, then swipe down again and select the **Settings** icon. Select **Display** then tap on the drop down arrow next to **Advanced**. Select **Touch Panel Mode** and choose between **Finger, Stylus or Glove Mode**.

Trimble recommends that you always use **Finger** mode in the rain.





Using the stylus

Take notes, draw, navigate, and mark up documents in your apps using the stylus that comes with your Ranger 5 / TSC5. To make a selection, tap the screen once on the item you want to select. To display a right click sub-menu, tap and hold an item on the screen, then tap the required menu item.

***NOTE** – Trimble recommends that you use the Trimble Ranger 5 / TSC5 handheld stylus accessory. There are many other capacitive touch styli available that will work with the Ranger 5 / TSC5 as long as they have a rubber tip; however the stylus available as an accessory is tuned for the Ranger 5 / TSC5 display and it fits into the stylus holder. Trimble offers no guarantee that other styli will work.*

The table below describes the main touchscreen input gestures and functions supported on this device.

Tap	Tap once on the screen.	Select or start something on your device.
	Tap to type.	To enter text, tap where you want to type; the onscreen keypad displays.

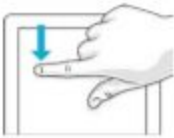
<p>Tap and hold</p> 	<p>Tap and hold your finger or the stylus on the screen for a couple seconds</p>	<p>Shows a menu with options related to what you're doing (like right-clicking with a mouse). On the popup menu that appears, tap the action you want to perform. .</p>
<p>Slide / swipe</p> 	<p>Slide / swipe your finger or the stylus across the screen vertically or horizontally.</p>	<p>Scrolls through what's on the screen. Quickly move your finger across the surface of the screen, without pausing when you first touch it, to scroll a page or a list up or down. Scrolls vertically or horizontally.</p> <p>Swipe a Home screen left or right to see your other Home screens.</p>
<p>Drag</p> 	<p>Drag your finger or the stylus across the screen.</p>	<p>Tap and hold an item with your finger or stylus for a moment, and then, without lifting your finger/ stylus, drag it or move it across the screen to the desired location.</p> <ul style="list-style-type: none"> • Drag in a list to select multiple items. • Drag items on the screen to reposition them.
<p>Pinch / stretch</p> 	<p>Pinch your thumb and forefinger together or move them apart.</p>	<p>Zooms in or out of a website, map, or picture.</p>
<p>Rotate</p> 	<p>Put two or more fingers on an item and then turn your hand.</p>	
<p>Swipe from top</p> 	<p>Swipe down from the top of the screen.</p>	<p>Displays the Notifications bar. Swipe up to close the Notification bar.</p>
<p>Swipe from edge</p>	<p>Swipe in from an edge of the screen.</p>	<p>Left edge swipe opens Google search.</p>

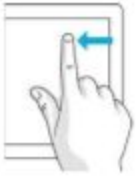

Display settings

The Ranger 5 / TSC5 is equipped with a high brightness outdoor readable display. You can easily increase the brightness of the display to increase the readability of the device in bright sunlight conditions, or turn down the brightness to help conserve battery power when working indoors or in dull conditions. You can also have the device automatically adjust the backlight power depending on the ambient light conditions.

Adjusting the backlight

To quickly adjust the backlight setting:

- Swipe down from the **Status Bar** at the top edge of the screen to view the **Quick Settings** bar.
- Slide the backlight slider  left or right to adjust the brightness.

NOTE - You can also access the backlight slider by pressing **Fn + 7**.

To manually or automatically adjust the backlight settings:

- Open the **Settings** app .
- Tap **Display**.
- Tap the setting that you want to change.

Adaptive brightness

To automatically fit your screen's brightness to the light around you, use **Adaptive brightness**. Adaptive brightness is on by default and will adjust brightness depending on the amount of light exposed to the ambient light sensor.





You can manually adjust your brightness level while adaptive brightness is on.

Screen auto-rotation

Ranger 5 / TSC5 is equipped with orientation sensors that can detect if your device is in portrait or landscape orientation. The operating system can automatically adjust the display to match your device orientation, or you can lock the orientation.

To adjust the auto-rotate setting, swipe down from the top of the screen to display the **Quick Settings** bar. Tap auto-rotate  to toggle auto-rotate On or Off.

- If auto-rotate is turned on, the auto-rotate icon  is visible. Orientate the device to **Portrait** or **Landscape**, then tap  to turn off auto-rotate and lock the device in the selected orientation.
- If auto-rotate is turned off, the auto-rotate icon  is not visible; **Portrait** or **Landscape** will be displayed instead. Tap to turn on auto-rotate.

Using the onscreen keypad

You can type on the device using a keypad on the touchscreen. The onscreen keypad is disabled by default. To turn it on, navigate to: **Settings > System > Languages & input > Physical keyboard**. Next to the **Show virtual keyboard setting**, tap the slider to turn it on. To access the onscreen keypad, tap in a text field and it will appear. You will still be able to use the physical keyboard while this setting is on.

Using a USB or Bluetooth® mouse

You can attach a physical keyboard, mouse and other peripherals to your Ranger 5 / TSC5 via USB or Bluetooth. For more information see, [Chapter 5: Using accessories and connecting to other devices](#).

Using the integrated keyboard

This section covers how to interact with the Ranger 5 / TSC5 device's built-in keyboard. It describes the special/non-standard functionality of the keyboard and the associated utilities. The Ranger 5 / TSC5 controller has a full physical QWERTY keypad. You can configure some keypad behaviors under **Settings > System > Languages & input > Physical keyboard > Built-in Keyboard**. See [Configuring built-in keypad settings](#).



CAUTION - When you first set up the device, make sure you select English US (Eng US) as the keypad language, independent of the keypad layout (ABCD or QWERTY) and the language you use on the TSC7 controller

The keyboard functions, in most ways, function like a standard PC keyboard with some concessions/alterations because of the small physical size. In addition, some special features have been added to support our customers' specific needs.

Figure 1 shows key items on the keyboard:

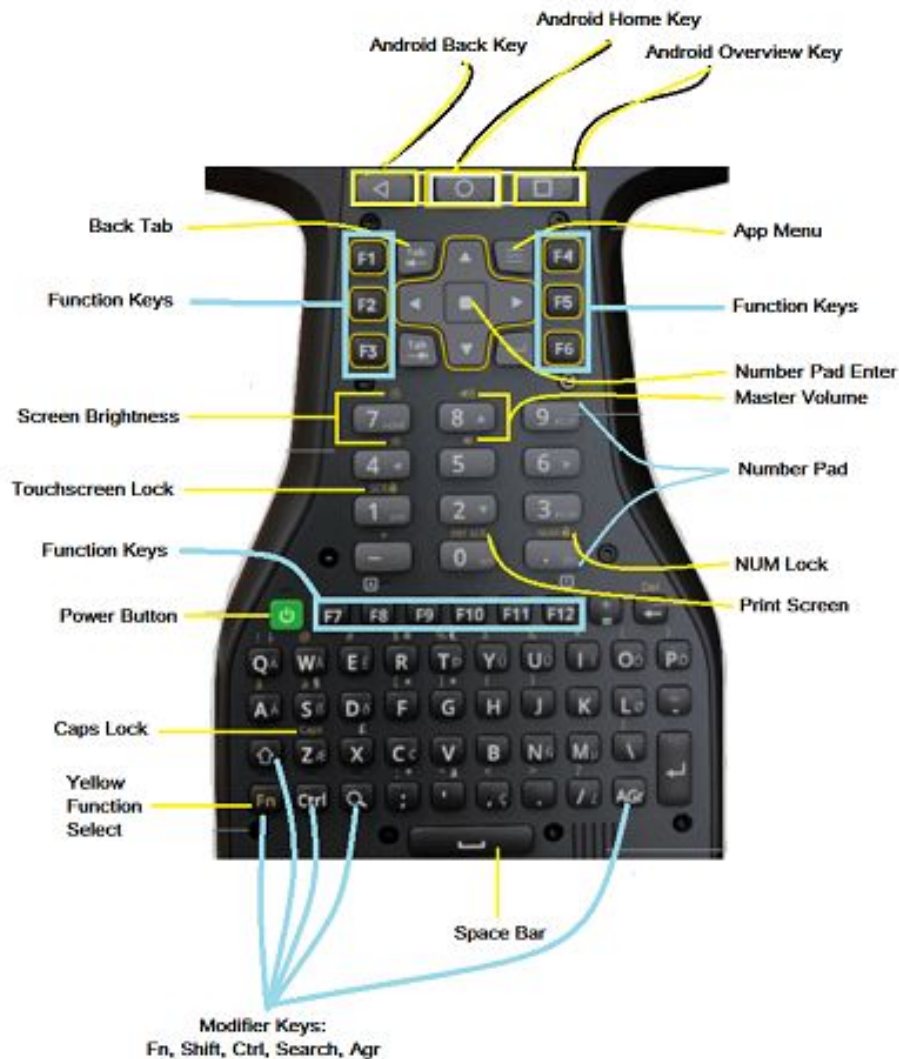

Figure 1

1. **Android Back Key**
2. **Android Home Key**
3. **Android Overview Key**
4. **App Menu** App-specific, this launches the menu for the active app.
 - a. The App Menu key (application menu) performs the same function as the App Menu key on a standard menu. The meaning is application specific, but usually it displays the context menu for the currently selected application windows or control.
5. **Function Keys F1 - F12** 12 keys, **XX** functions.

TIP - These can be configured in the Trimble Access software according to your requirements. Refer to the Trimble Access software documentation.
6. **Number Pad, Number Pad Enter, and NumLock**
 - a. **Number Pad** The number pad keys; 0 to 9, decimal ('.') and minus ('-') perform the same as the numeric keyboard on a standard PC keyboard. The number pad is on

and locked by default, which is different from a standard PC keyboard.

- i. NOTE: This is different from the TSC7/Ranger 7 where Num Lock was not turned on by default. The Shift key was used to switch between the number functions and the cursor movement functions and locking the state with the Num Lock button. It was activated by pressing the Fn key and the decimal (". Del") at the same time.
 - ii. NOTE: This is different from the TSC3/Ranger 3 where the number buttons were the same as the number keys along the top of a PC keyboard and did not support the cursor movement functions.
 - b. **Numeric Keypad Enter key** performs the same as the numeric keyboard enter key on a standard PC keyboard.
 - c. **NumLock (Fn+. - Decimal)**. NUM pad is locked by default. To turn off NUM lock and turn on DPAD lock, press Fn +. Keys. Use to lock the Numeric keypad in Num state, or cursor Navigation state. In Navigation state, the keys will function according to the key+Shift behavior (Home; End; Page up; Page Down; left, right, up, or down arrow; Insert; and Delete.) Num Lock is on by default. When Cursor lock is on (the Numeric keypad is locked in DPAD/Cursor lock state) the LED status icon will turn on.
 - i. *NOTE - The "A" part of this status icon indicates if CAPS lock is on or off. See [Status icons in the taskbar](#).*
 - ii. *NOTE - As on a standard PC keyboard, the Shift key can be used to temporarily invert the Num lock state.*
7. **Master Volume Keys (Fn+8 Volume up; Fn+5 Volume down)**. Use to adjust the device's speaker volume.
8. **Print Screen (Fn+0)**. Print all or part of the screen to the clipboard, similar to a standard PC keyboard.
 - a. *NOTE - Press the Windows key + Fn + 0 to save a screen capture to the My Pictures / Screenshots folder.*
9. **Space Bar**
10. **Modifier Keys: Fn, Shift, Ctrl, Search, AGr**
 - a. The modifier or shift keys are keys that modify the action taken when other keys are pressed while the modifier key is held down. Modifier keys can be used in combinations with more than one pressed at the same time. These modifier keys are the Shift key, the Fn Key, the Ctrl (control) key, and the AGr key. To make the keyboard easier to use the modifier keys can be configured as sticky keys. When sticky keys are enabled the modifier keys "stick down" when pressed so that they do not have to be held while the other key is pressed. See the [Modifier keys and Sticky keys](#) section for more information.
11. **Yellow Function Select Key (Fn)**. Use the Fn key to access a key's alternate function, as printed in yellow above the key; press and hold the Fn key and press the other key.
 - a. If **Sticky keys** are enabled you do not need to hold the **Fn** key while pressing the other key. For more information see [Sticky Keys](#).
12. **Caps Lock (Fn+Z)** Performs the capital letters lock function.
13. **Power Button**. Turn the device On / Off.
14. **Touchscreen Lock (Fn+1)**. Use to temporarily disable the touchscreen, for example to clean the display. This is a toggle function; the first press locks the touchscreen, the second press unlocks the touchscreen.
 - a. When the touchscreen is locked, a message shows briefly on the display and the

touchscreen locked icon



displays on the taskbar. Note that this icon is not

pinned to the taskbar by default. You can pin the icon to the taskbar to make it always visible when the touchscreen is locked; see [Pinning keypad status icons to the Taskbar](#) for more information.

- b. When the touch screen becomes locked the following notification is displayed and the touch locked icon, indicated by the red arrow in the image below, is displayed on the taskbar.

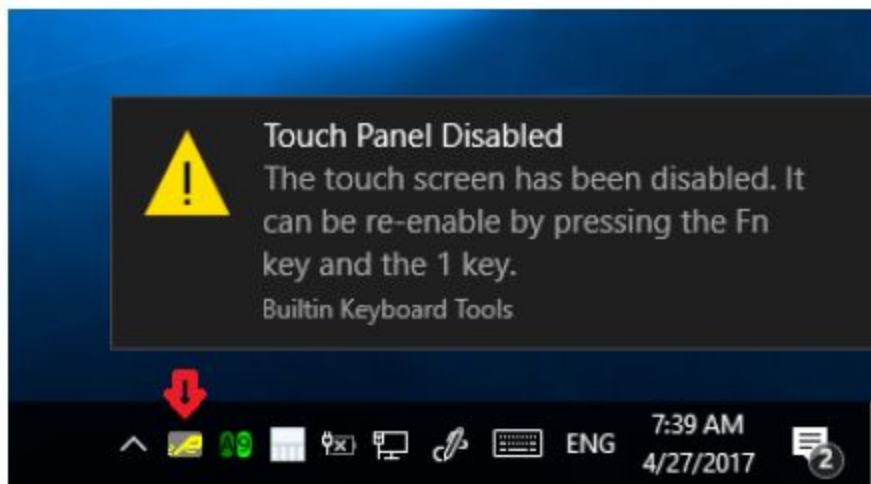

15. **Screen Display Brightness (Fn+7 Brighter; Fn+4 Dimmer).** Adjust the display backlight brightness. *NOTE - You can also set the display brightness to adjust automatically when the ambient lighting conditions change. See [Display settings](#).*

16. **Back Tab**

- a. The back tab key performs the same function as pressing the Shift key and the Tab key. For many applications this will move the focus to the previous control in the sequence, as opposed to the Tab key which moves the focus to the next control. For applications that use the Tab key for text entry it typically performs the same as the Tab key.

Modifier keys and Sticky keys

The modifier (or shift) keys are keys that modify the action taken when other keys are pressed while the modifier key is held down. Modifier keys can be used in combinations with more than one pressed at the same time. The modifier keys are:

- the **Shift** key
- the **Fn** key
- the **Ctrl** key
- the **Search** key
- the **AGr** key

Since the device is normally hand-held, it can be difficult to press multiple keys on the built-in keypad at the same time. To make the keypad easier to use, you can configure all modifier keys (Fn, GUI/Meta, Shift, Alt, and Ctrl) as **Sticky Keys**. When enabled, the modifier keys “stick down” when pressed so that they do not have to be held while the other key is pressed, allowing multiple key combinations to be pressed by pressing the keys sequentially. For example, the **Ctrl+Alt+Del** combination can be entered as press and release **Ctrl**, press and release **Alt**, and press and release **Del** requiring only one finger to do what normally would require three.

Sticky Keys is on by default. For information on configuring Sticky Keys behavior, see [Sticky Keys](#). The sticky key behavior is controlled through the custom “Built-in Keyboard” settings applet. The keyboard controller will manage the sticky key operation of all modifier keys. The different **Sticky Keys** modes/settings and behaviour of the modifier keys when sticky keys is enabled is shown below:

Setting/Mode	Modifier Key Behavior
Sticky Keys Disabled	All modifier keys must be pressed and held to access modified key functions. For instance the Shift key must be pressed and held while an alpha key is pressed to access capital letters.
Normal Sticky Keys Mode Temporarily latch modifier key when pressed.	Pressing and releasing a modifier key one time latches the modifier key state down until another non-modifier key is pressed at which point the modifier key is released.
Lock Sticky Keys Mode Lock modifier key when pressed twice in a row	Pressing and releasing a modifier key one time latches the modifier key state down until another non-modifier key is pressed at which point the modifier key is released. Pressing and releasing a modifier key two times in a row locks the modifier key state down until it is pressed and released a third time.
Allow the GUI/Meta key to not be included as a Sticky Key.	Because the GUI/Meta key is sometimes used in a non-modifier fashion this control allows the GUI/Meta key to not be sticky while the other keys remain sticky. The GUI/Meta key is not sticky by default.
Play sound when modifier key is latched, locked, or released	Sounds are played when a modifier key is latched down, locked down, or released.

To make it easier to determine the locked state of the modifier keys, feedback is provided:

- Audible. A sound is played when a modifier key is locked down or unlocked
- Visible. LED turns on.

Status LEDs

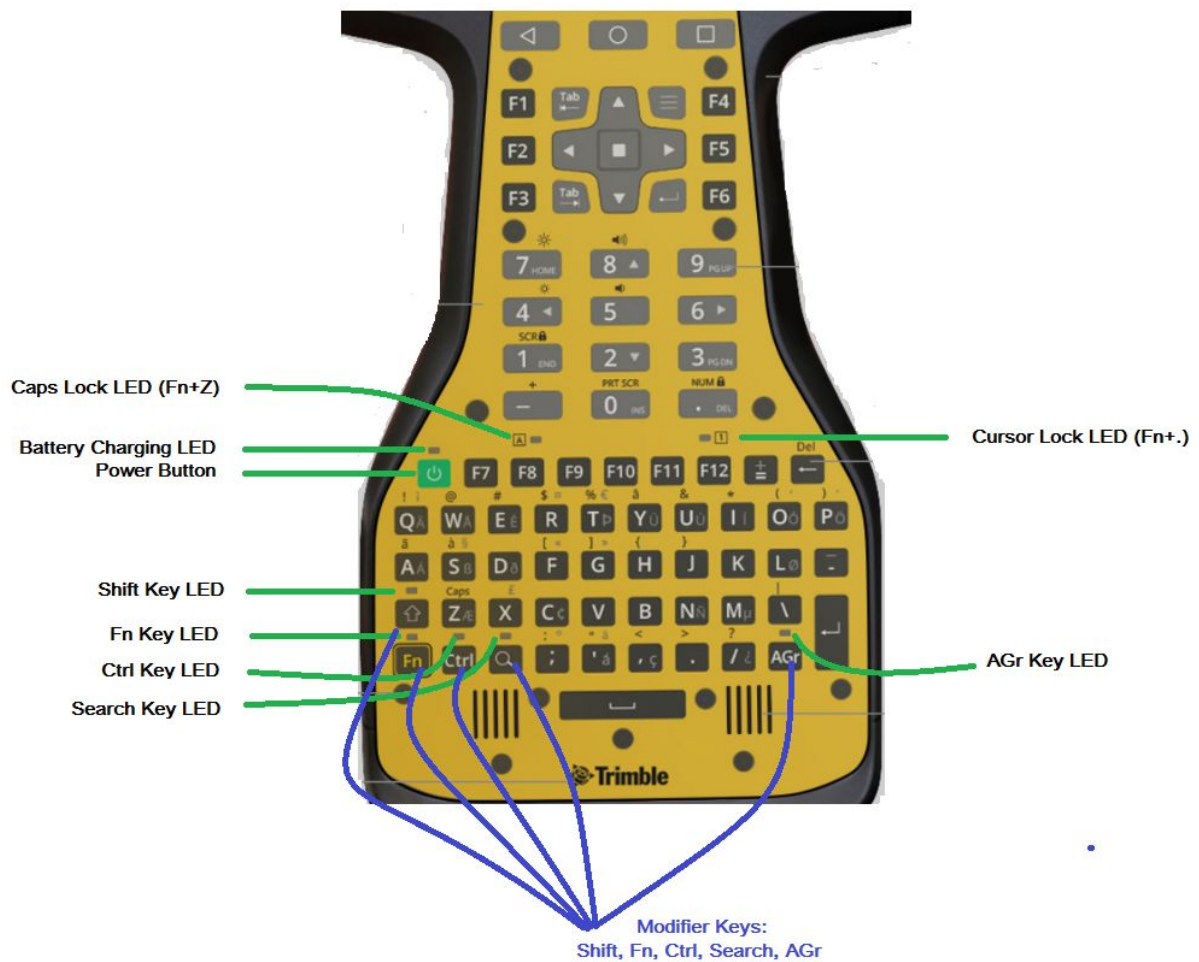

There are 8 LEDs on the keyboard, including 5 **Modifier** or “**Sticky key**” LEDs. The Sticky key LEDs represent the sticky state of the Modifier key it is located above. The different LED states are:

No LEDs On	indicates that none of the modifier keys are “sticky” down.
Caps Lock LED	ON: Caps locked. Uppercase alphabet letters are produced. OFF (Default): Caps unlocked. Lowercase alphabet letters are produced.
Cursor Lock LED On	ON: Cursor locked, Num unlocked; the number pad performs the cursor movement function. Indicates that the Cursor Lock is “sticky down”; the Numeric keypad is locked to the cursor functions. To return to NumLock function, press

	Fn + “.”. OFF (Default): Num locked. The number pad performs the number functions.
Battery Charging LED	
Shift Key LED On	indicates that the Shift key is “sticky” down.
Fn Key LED On	indicates that the Fn key is “sticky” down.
Ctrl Key LED On	indicates that the Ctrl key is “sticky” down.
Search Key LED On	indicates that the Search key is “sticky” down.
AGr Key LED On	indicates that the AGr key is “sticky” down.

NOTE – As on a standard PC keyboard, the Shift key can be used to temporarily invert the Caps and Num lock states.

Configuring built-in keypad settings

To edit the Ranger 5 / TSC5 controller keypad behaviors navigate to: **Settings > System > Languages & input > Physical keyboard > Built-in Keyboard**.

Use the Built-in Keypad utility to change the behavior of some of the built-in keypad features.

- Tap , scroll down and expand **Windows System**, then tap **Control Panel**.

NOTE – In Tablet mode, tap , then tap the All Applications icon to show the list of applications.

- In **Category** view, select **Hardware and Sound**, or **Ease of Access**.
- Tap **Built-in Keyboard** or one of the subcategories in blue to open the settings applet to a specific page.

The Built-in Keyboard utility has four options:

- [Sticky Keys](#), page 43
- [Backlight](#), page 44
- [Status Icons](#), page 44
- [SYM Key](#), page 44

It also has an **About** page which shows the Built-in keypad utility version, the version of the keypad's firmware, and the identifier for the type of built-in keypad installed.

To use the utility:

- Select the option you want to configure settings for by tapping it. Details for the options are covered below.

- Click **Apply** or **Ok** to commit any changes to the settings. **Ok** also closes the utility.
- To close the utility without committing the last uncommitted changes, click the **Cancel** button.

Sticky Keys

To enable **Sticky Keys** behavior if it has been turned off, select **Turn on Sticky Keys**. The options here are:

- **Include Windows key as sticky key.** Because the **Windows** key is used as a non-modifier key to open the Windows Start menu, you can make it non-sticky by deselecting **Include Windows key as sticky key**. The **Windows** key as a sticky key is disabled by default.
- **Lock Modifier keys when pressed twice in a row.** You can set a modifier key to be locked down indefinitely by setting **Lock Modifier keys when pressed twice in a row**; when you then press a modifier key twice, it locks down until you press the key a third time. This is deselected by default.
- **Play a sound when modifier keys are pressed.** Plays a sound when sticky keys are locked down or released. This is set by default.
- **Display the Sticky Keys icon on the taskbar.** Select this option to show the sticky keys icon on the taskbar. This is set by default.
- If you need to use the Windows supplied **Ease of Access** sticky keys function, because you need it for an external keyboard, you may want to disable the Built-in keypad's sticky keys feature for the **Windows, Shift, Ctrl, and Alt** keys because the two features conflict with each other. In this case set **Use Windows Sticky Keys for standard modifier keys (Shift, Ctrl, Alt, and Windows)**. This is deselected by default.

Backlight

The built-in keypad may be equipped with a backlight that makes the keypad easier to use in dimly lit areas. The backlight is activated when a key is pressed, stays on for a while, and then turns off to conserve power. The backlight can be disabled and the brightness adjusted. The system ambient light sensor can also be used to keep the backlight from turning on in well lit areas.

- The backlight is enabled by default.
- If you don't work in low light settings, you can disable the keypad backlight to save power. Clear the **Enable Keyboard backlight** to completely disable the backlight.
- Set the **Timeout** value to determine how long the backlight stays on when no keys are being pressed.
- Select **Automatically disable the keyboard backlight in well lit areas** to prevent the backlight from turning on if you are in a well lit area. This is selected by default.
- Move the **Set keyboard backlight brightness** slider to control how bright the backlight is; slide right for brighter, and left for dimmer. Brighter settings consume more power than dimmer settings.

Status Icons

Use the **Status Icons** option to show or hide the **Caps Lock/Num Lock** icon on the taskbar. **Show Caps Lock & Num Lock status on the taskbar** is selected by default.

SYM Key

The **SYM Key** option allows you to turn the SYM Key input method on or off. When enabled the **SYM Key input method** allows you to easily enter certain accented characters and special symbols. See [Using SYM Key IME](#) for details on its usage.

If **SYM Key input method** is not enabled, when you press the **SYM** key (Fn + spacebar), this **SYM Key settings** page displays.

Note that enabling and disabling the **SYM Key input method** requires administrator privileges and

must be done for both 32 bit and 64 bit applications. Because of this requirement you will be prompted for your approval twice and possibly prompted for administrator credentials. Enter your password if necessary and tap **Yes** for both instances.

Pinning keypad status icons to the taskbar

Because the Sticky keys, Caps Lock/Num Lock, Touchscreen Disable, and Keypad Disable icons show real time information about the state of the keypad, you may want to pin them to the taskbar. If you don't see both icons and they are enabled in the Built-in Keyboard Settings utility you can find them by tapping on the ^ symbol at the left side of the taskbar icons area.

To “pin” an icon to the taskbar, tap-hold on the icon in the popup window you want to pin, then drag it to the taskbar.

To “unpin” icons, tap-hold on the icon in the taskbar and drag it to the popup window.

Using SYM Key IME

The **SYM** key is a hotkey that is used to invoke the Symbol IME (Input Method Editor). Use the Symbol IME to enter accented characters and other special symbols.

This option is disabled by default. To enable it, open the **Built-In Keyboard settings** utility and select the **Sym Key** option. See [Configuring built-in keypad settings](#).

If the SYM Key IME is not enabled when you press the **SYM** key (**Fn+ Space bar**), a warning message displays. Tap the message to open the **Built-In Keyboard settings** utility.

Selected Input Method Indicator

The Windows 10 operating system shows which input method is selected in one of several ways depending on whether the language bar is enabled, and the state of the language bar.

- If the language bar is disabled (the default) the selected input method is indicated on the taskbar:
 - <add screenshot>
- If the language bar is enabled and maximized, the selected input method is indicated on the language bar at the top of the screen:
 - <add screenshot>
- If the language bar is enabled and minimized, the selected input method is indicated on the minimized language bar in the taskbar:
 - <add screenshot>

Selecting the SYM Key IME

The SYM Key IME can be selected as the active input method by one of the following methods:

- Repeatedly pressing the **Windows+Space bar** hotkey combination until the SYM Key IME is selected.
- If the language bar is disabled, clicking on the input method icon on the taskbar and selecting the SYM Key IME from the popup menu:
 - <add screenshot>
- If the language bar is enabled and maximized, clicking on the input method selector and selecting the SYM Key IME from the dropdown menu:
 - <add screenshot>
- If the language bar is enabled and minimized to the taskbar, clicking on the input method selector and selecting the SYM Key IME from the popup menu:
 - <add screenshot>

Using the SYM Key IME

When you type, the SYM Key IME highlights characters that have accented versions or alternate symbols (that is, different currency or punctuation symbols). The SYM Key IME works in one of two modes:

- **Inline Mode.** In Inline mode, characters that have alternates are highlighted as you type. When a character is highlighted, press the **SYM** key (**Fn+ Space bar**) to change the character to the next available character in the list of possible characters. Repeatedly press the **SYM** key until the desired character is shown, and then continue typing normally. To accept a highlighted character, press **Enter**.

For example, to type **fenêtre**:

- a. Type **fone**; the first e and the n are highlighted and then the second e is highlighted.
 - b. Press **Fn+Space bar (SYM)** three times to select the **ê** character.
 - c. Type **tre**.
 - d. Press **Enter** to accept the final e.
- **Popup Mode.** In Popup mode, characters that have alternates are highlighted as you type and a popup window of the list of alternate characters is shown. When a character is highlighted, press the **SYM** key (**Fn+ Space bar**) to change the character to the next available character in the list of possible characters. To select the character you want to use from the popup window, do one of the following:
 - Repeatedly press the **SYM** key until the desired character is highlighted in the popup window.
 - Use the cursor keys to select a character from the popup window.
 - Press the number key associated with the desired character in the popup window.
 - Tap the desired character in the popup window.

When the popup window is open, you can select the currently highlighted character and close the popup window in the following ways:

- Press **Enter**.
- Continue to type characters other than the cursor movement keys.

You can also press the Escape key (**ESC**) to close the popup window; this deletes the character being input.

For example, to type **fenêtre**:

- a. Type **fone**; ignore the popups that appear for the first e and the n. The second e is highlighted, with a popup window.
- b. Press **Fn+Space bar (SYM)** three times to highlight the **ê** character.
- c. Type **t**; the **ê** character is accepted.
- d. Then type **re**. A popup remains open.
- e. Press **Enter** to close the final popup.

Switching Modes

There are two ways to switch between inline and popup modes.

- Press the **Ctrl+Space bar** key combination.
- Tap the mode button on the language bar.
 - If the language bar is maximized this is at the top of the screen.
 - If the language bar is minimized, this is at the bottom of the screen

Application Support for SYM IME

SYM IME only works with applications which support Text Services Framework (TFS). For information

about adding TFS support to your application, go to:
[https://msdn.microsoft.com/en-us/library/windows/desktop/ms629032\(v=vs.85\).aspx](https://msdn.microsoft.com/en-us/library/windows/desktop/ms629032(v=vs.85).aspx)

SYM IME Issues and Limitations

The following are known issues and limitation with version 1.0.3 of SYM IME:

- Edit Controls.
 - If a composition is active, a character is highlighted by SYM IME for editing, and you mouse-click or tap somewhere else in the text of the edit control, the composition highlighted character is moved to the location of the mouse-click / tap. This is usually not what you intended. To avoid this, press **Enter** to close the composition before you click or tap at the new location.
- ComboBox Controls.
 - If a composition is active when leaving a ComboBox control then the highlighted character is moved to the beginning of the string. For example, if you type abc into a ComboBox control and then click on another control, the typed string changes to **cab** if the c was still highlighted. To avoid this, press **Enter** to end the composition before you click on another control.
 - The ComboBox drop listbox can interfere with the SYM IME popup window. Sometimes the list box will be on top and sometimes the popup window will be on top.

Assign Keys app: F keys

There are 3 "F" keys on the front of the device that you can assign actions or apps to. By default, the keys are set as follows:

- **F1**. Launch the EMPOWER Hub. See [Using EMPOWER modules](#) and [Trimble EMPOWER Hub](#) for more information.
- **F2**. Launch **Settings**.
- **F3**. Launch the Camera app. See [Using the camera](#) for more information.

To assign other functions to any of the F keys:

1. From the **Apps** screen, open the **Assign Keys** app.
2. From the list, tap the **F** key and its associated function that you want to change.
3. Under **Reassign key**, tap the required option:
 - **Launch application**. Use to assign a different app to the **F** key. Tap **Launch application** and select the app you want to assign to the key.
 - **Send intent**. Intents are used to send actions to other applications; use this option if you know the specific intent you need to send.
 - **Send keystroke(s)**. This option is used to send a set of keystrokes to the active application, for example a carriage return or line feed.
 - To unassign any function from the **F** key, tap **Unassign**.

To close the Assign Keys app, tap the **Back** or **Home** Android key.

Chapter 3: Using the Android 10 operating system

- Using Accounts
- The Android interface
- Using apps
- Settings

This section introduces some basic information on using the Android 10 operating system on the Ranger 5 / TSC5 controller. For additional information, visit the [Android 10 website](#).

Using Accounts

When you set up your Ranger 5 / TSC5, you will need to set up a new or use an existing Google Account.

Sign in to your account

When prompted, sign in with your Google Account, or create a new one. Signing in lets you immediately access everything associated with your Google Account, like Gmail and Calendar.

An email address used for any of the following Google services counts as a Google Account:

- Gmail
- YouTube
- Google Play
- AdWords
- Any other Google product

When you sign in, you can easily get all the apps you've purchased on Google Play onto the Ranger 5 / TSC5. All email, contacts, calendar events and other data associated with that account are automatically synced with the device.



WARNING - Make sure you remember the password you use to sign into your device or else you won't be able to access it. Even if you do a factory reset, you will be required to enter the password you used to sign into this device.

Sign out of your account

<TODO>

Manage multiple accounts

If you have multiple accounts, you can add other accounts from the device's settings; go to **Settings / Accounts**.

The Android interface

Home screen

When you have finished setting up your device for the first time, the main **Home** screen appears. The **Home** screen is the primary screen for accessing all of the Ranger 5 / TSC5 features in the operating system. You can customize the **Home** screen(s) by adding app shortcuts and widgets (an at-a-glance view of the app's most important information). The main parts of the screen are:



1. **Home** screen. To move between **Home** screens if you have more than one, swipe left or right.
On the main **Home** screen, tap **Google** at the top of the screen or say **OK Google** to search, send messages, ask for directions, or give other instructions.
2. **Notifications**. To see notifications, swipe down from the top of the screen with one finger.
3. **Android Back** key. Returns to the previous screen you were working in, even if it was in a different app. Once you are back up to the **Home** screen, you can't go back any further.
4. **Status bar & Settings**. The status bar shows the mobile signal strength, Wi-Fi signal strength, how much battery charge is left, and the time on the right side. On the left, you can see which apps have sent you notifications.

To open **Quick Settings** (frequently used settings), swipe down from the top of the screen.

To open all **Settings** swipe down from the top of the screen, then tap the **Settings** icon.

~~5. **Apps launcher**. Opens the Apps screen. See [Using Apps](#).~~

6. **Android Home** key. Returns to the **Home** screen.

To get suggestions based on the screen you're currently viewing, tap and hold this button.

7. **Android Overview** key. Opens thumbnails of items you've worked with recently. To open an item, tap it. To remove an item, swipe it left or right or tap **x** in its top right corner.
8. A widget
9. App shortcuts

Function keys. See [Assign Keys app: F keys](#).

Android Navigation keys

The Ranger 5 / TSC5 includes navigation keys on the physical keyboard, so they will not appear on the screen.

Status bar

[TODO - Add Status bar screen snap and a table of all the icons that may appear there.]

Apps Screen

[TODO - Add screen snap and instructions on managing apps.]

To see all your apps, including those that come with your device and those you downloaded from Google Play tap the App launcher arrow on a **Home** screen:

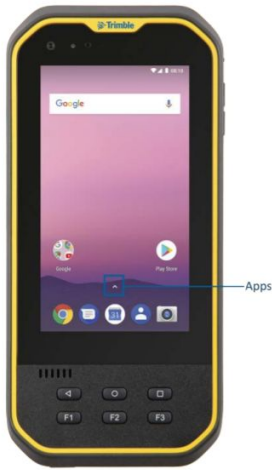

Swipe up on the **Home** screen to access the apps screen.

The apps that you've used most recently appear in the first row.

Tap in the Favourites tray on any Home screen.

On the **Apps** screen:

- To open an app, tap its icon.
- To search apps, enter the name of the app you are looking for in the **Search apps** bar.
- To place an app icon on a **Home** screen, see [Adding apps to a Home screen](#).
- To get more apps, tap the Google **Play Store** icon .
- **Explore apps.** Swipe up and down from the All Apps screen.

Many screens in apps and settings include a **menu**  icon at the top right of the screen. Tap it to explore additional options, including help and feedback.

Adding apps to a Home screen

You can move app icons to any of your Home screens.

1. From the **Home** screen (or any **Home** screen if you have more than one) open the **Apps** screen. 
2. Swipe down or from left to right to find the app you want.
3. Touch-hold the app until the **Home** screen appears, then slide the app icon to where you want to place it, and lift your finger off the screen

Removing apps from the Home screen

To remove an app icon from the **Home** screen without removing it permanently from your device, touch-hold it, then slide your finger toward the top of the screen, and drop the app over **Remove**  in the top left.

Uninstalling apps

To uninstall an app permanently from your device, touch-hold it, then slide your finger towards the

top of the screen and drop the app over **Uninstall**  in the top right.

[Settings](#)

[Wi-Fi settings](#)

[Bluetooth settings](#)

[Screen brightness](#)

Chapter 4: Using wireless networks

- Working with Wi-Fi networks
- Working with mobile broadband
- Airplane mode

The Ranger 5 / Nomad 5 supports wireless connectivity; connect to wireless networks using the built-in Wi-Fi radio (also sometimes called Wireless LAN, WLAN, or 802.11), or the built-in mobile broadband data (also called Wireless WAN, WWAN, or cellular data) capability.

This section describes how to get online with your Ranger 5 / TSC5 using these wireless networking capabilities.

Using Wi-Fi you can connect to a wireless network and browse the Internet, download apps, send email messages, access online services, or access other computers and devices on your network.

Before you can send and receive data over Wi-Fi, you need to turn on Wi-Fi on your Ranger 5 / TSC5 and connect to a wireless network.

To access Wi-Fi settings, do one of the following:

- From the Apps screen (see [The Android interface](#)), open the **Settings** app .
- Tap **Network & Internet**, then tap **Wi-Fi**.
- On a **Home** screen, swipe down from the status bar at the top of the screen twice with one finger, or once with two fingers to open **Quick Settings**. If the device is connected to Wi-Fi, the network name is displayed; otherwise, it shows **Wi-Fi**. Tap the dropdown arrow, then tap **More Settings**.

TIP – See [The Android interface](#) for more information.

Connecting to Wi-Fi

1. At the top of the Wi-Fi screen, tap the **On/Off** switch to turn on Wi-Fi.
2. A list of available wireless networks appears. Tap the Wi-Fi network you want to connect to. If

the network is secured and you need a password, you'll see the Wi-Fi lock icon .

Once you are connected:

- **Connected** shows under the network name.
- The Wi-Fi network is a **Saved network**. When in range, your device automatically connects to it.

Disconnecting from Wi-Fi

At the top of the Wi-Fi screen, tap the **On/Off** switch to turn off Wi-Fi.

Forgetting a Wi-Fi network

If you do not want your device to automatically connect to a saved Wi-Fi network, you can forget that network.

To forget a wireless network so it no longer appears in your list of networks:

1. Open your device's Settings app .
2. Tap **Wi-Fi**.
3. At the top of the Wi-Fi screen, make sure the **On/Off** switch is On.
4. Tap the saved network you want to forget, then tap **Forget**.

Advanced Wi-Fi settings



You can change the advanced Wi-Fi settings on your device.

1. Scroll to the bottom of the Wi-Fi screen.
2. Tap **More** .
3. Tap **Wi-Fi preferences** then tap **Advanced**.
4. Tap an available setting option:
 - **Open network notification.** Get a notification when your device finds a Wi-Fi network to which it can connect.
 - **Keep Wi-Fi on during sleep**
Choose how your device handles Wi-Fi when it's asleep.
 - **Install certificates.** Digital certificates can identify your device for many purposes, including VPN or Wi-Fi network access.
 - **Network rating provider.** Select None or Google.
 - **Wi-Fi Direct.** Let your device connect with other Wi-Fi Direct-capable devices without a network.
 - **WPS Push Button.** Turn on Wi-Fi protected setup (WPS) for a WPS-capable network.
 - **WPS Pin Entry.** Enter the Wi-Fi protected setup (WPS) personal identification number (PIN).

Here you can view the MAC address and IP address.

Configure proxy settings

To connect to a Wi-Fi network via a proxy:

1. Open your device's Settings app .
2. Tap **Wi-Fi**.
3. On the Wi-Fi screen, tap-hold the Wi-Fi network name.
4. Tap **Modify network**.
5. Scroll down if required and tap the **Advanced options** dropdown  menu.
6. Tap the **Proxy** dropdown  menu, and select the required option:
 - **None**
 - **Manual**
 - **Proxy Auto-Config**
7. If necessary, enter the proxy settings.
8. Tap the **IP settings** dropdown menu, and select the required option.
9. Tap **Save**.

Proxy settings must be set up separately for each Wi-Fi network.

Managing Wi-Fi from the Status bar / Quick Settings on the Home screen

You can quickly turn Wi-Fi on or off, or switch networks, from the Status bar / Quick Settings on a **Home** screen.

On a **Home** screen, swipe down from the Status bar at the top of the screen twice with one finger, or once with two fingers to open **Quick Settings**. If the device is connected to Wi-Fi, the network name is displayed; otherwise, it shows **Wi-Fi**.

- To turn Wi-Fi on if it is off, tap the Wi-Fi icon.
- To turn Wi-Fi off if it is on, tap the network name that the device is connected to.
- To connect to a different network, tap the dropdown arrow then select the network you want to connect to.

See [The Android interface](#) for more information about the Status bar and Quick Settings.

Working with mobile broadband

The Ranger 5 / TSC5 has an integrated cellular modem enabling you to connect to a mobile broadband network. The Ranger 5 / TSC5 supports Worldwide LTE (where available), and is compatible with AT&T and Verizon certified 3G and 4G networks.

Before you can send and receive data over mobile broadband, you must have a MicroSIM card in the device (see [Inserting a SIM card](#)). You must then turn on cellular data on the Ranger 5 / TSC5 and configure the connection.

Using mobile data

You can adjust how your device uses mobile data by changing your cellular network settings.

Depending on your carrier and service plan, your device may connect automatically to your carrier's fastest available data network. Or you may need to choose settings and use a SIM card for a specific carrier.

To adjust cellular network settings:

1. Open the **Settings** app .
2. Tap **Network & Internet**, then tap **Mobile network**.
3. Adjust the settings as required:
 - **Mobile data.**
 - **Roaming.** Let your device transmit data over other carriers' networks when you leave an area covered by your own carrier's networks.
 - **Data usage.**
 - **Preferred network type.** Select your preferred network type, for example, 4G (recommended).
 - **Network.** Choose your network operator from available networks, or set the device to automatically select an available network.
 - **Access Point Names.** Help your carrier identify the right IP address for your device and connect your device securely.
 - **Enhanced 4G LTE mode**
Improve voice and other communications.

Locating the device's IMEI number

The IMEI number is a unique 15-digit number that identifies the cellular module installed on your device. Your mobile broadband operator may need to know the IMEI number of your device in order to register the device with the network and activate your mobile broadband data plan.

If your Ranger 5 / TSC5 is mobile broadband enabled, the IMEI number will be printed on the serial number label under the battery.

Alternatively, to check the IMEI number in the operating system:





1. Open the **Settings** app  .
2. Tap **System**, then tap **About tablet**.
3. Tap **Status / IMEI information**.

If you cannot find the IMEI number for your device, or you do not have the device with you, contact your reseller.

Airplane mode

If you are travelling on an airplane, or don't need to use wireless functions on the Ranger 5 / TSC5 for a while, use Airplane mode to turn off all wireless radios with transmitting features built into the Ranger 5 / TSC5, including Bluetooth, Wi-Fi, Cellular, or GNSS, as well as any wireless radios connected to the Ranger 5 / TSC5 such as EMPOWER modules.

To turn Airplane mode on or off:

- Swipe down from the top edge of the screen to open **Quick Settings** (see [The Android interface](#) for more information about **Quick Settings**).
- Tap **Airplane mode**  to turn it on  .
- If it is on, tap  to turn it off  .
- On the keypad, use the Airplane mode key = Fn key (lower left corner) and 6 on the numeric keypad.

Chapter 5: Working with GNSS

The Ranger 5 / TSC5 has a built in 10 m accuracy GNSS (Global Navigation Satellite System) receiver module, and an integrated antenna with automatic SBAS corrections. The integrated receiver supports SBAS satellites under normal conditions.

The Controller supports most of the Trimble GNSS receivers, including the submeter Trimble EM100 GNSS EMPOWER module. Refer to the documentation for the Trimble receiver you want to use, and check the specifications and connection options. If you want to connect via Bluetooth make sure your receiver is capable of using a Bluetooth PIN; older receivers may not connect due to the security expectations of the Android operating system.

You cannot use an external antenna with the Controller's integrated GNSS receiver. For advanced GNSS setups, use a survey grade receiver, or the Trimble EM100 GNSS EMPOWER module; refer to the Trimble EMPOWER module user documentation for more information. With a GNSS L1/L-band GNSS module you can receive GNSS positions with submeter accuracy.

You cannot post-process GNSS data from the internal receiver. If you want raw GNSS data for post-processing, use an external GNSS receiver or the EM100 GNSS EMPOWER module; refer to the Trimble EMPOWER module user documentation for more information.

Using the GNSS status application

The app allows for more granular configuration settings of the GNSS receiver. If required, you can

download it from website.

Chapter 6: Using accessories and connecting to other devices

- Connecting to USB accessories
- Using Bluetooth wireless technology
- Connecting to RS-232 peripherals
- Transferring data between your Ranger 5 / TSC5 and another computer
- Using EMPOWER modules
- Using the accessory battery pack and charger

You can connect monitors, accessories, and other devices directly to your Ranger 5 / TSC5 using USB (type C) . You can also connect a Bluetooth headset.

Connecting to USB accessories

The Ranger 5 / TSC5 has a USB (type C) port for connecting USB devices, such as a flash drive, scanner, printer, keyboard, or mouse. The Ranger 5 / TSC5 has built-in support for mass storage devices and human interface devices.

Other types of USB devices may require drivers.

To connect a USB device, plug the device cable into the USB (type C) port on the bottom of the Ranger 5 / TSC5.



Connecting to Bluetooth accessories

The Ranger 5 / TSC5 has embedded Bluetooth wireless technology—a short-range wireless communication technology that allows wireless data transfer and communication between devices over a distance of up to 10 meters (30 feet).

You can use Bluetooth wireless technology to connect the Ranger 5 / TSC5 handheld to a Bluetooth headset.

Turning Bluetooth on or off

1. Open the **Settings** app .
2. Under **Wireless & networks**, tap **Bluetooth**.
3. Tap to switch Bluetooth **On** or **Off**.



At the top of the screen, a Bluetooth icon shows when Bluetooth is turned on.

TIP - To save battery, turn off Bluetooth when you are not using it. Bluetooth is off in [Airplane mode](#).

Pairing and connecting a Bluetooth device with the Ranger 5 / TSC5

Before you can transfer data or communicate between your Ranger 5 / TSC5 and another Bluetooth enabled device, you must pair the Ranger 5 / TSC5 and the device.

Step 1: Pair a Bluetooth device

1. Open the **Settings** app .
2. Under **Wireless & networks**, tap **Bluetooth**.
3. Make sure Bluetooth is turned On and the Ranger 5 / TSC5 is set to visible.
4. The Ranger 5 / TSC5 scans for and displays, under **Available devices**, all available Bluetooth devices in range. If your Bluetooth device isn't showing in the list, tap more  and then **Refresh**.
5. Tap the name of the Bluetooth device you want to pair with.
6. Follow the on-screen steps.
 - If the pairing is successful, the Ranger 5 / TSC5 connects to the device.
 - If you are asked to enter a passcode or Bluetooth PIN, try entering 0000 or 1234 (the most common passcodes), or see the documentation that came with your Bluetooth device. Some old Bluetooth devices do not require a PIN.
 - **NOTE** - *To connect to a Bluetooth-enabled receiver with a PIN, if for any reason you cannot connect via Bluetooth, connect over Wi-Fi to configure the receiver. The IP address is in most cases 192.168.142.1. Refer to the documentation for the receiver for details and receiver specific settings.*

Step 2: Connect to a Bluetooth device

After pairing with a Bluetooth device, you can connect to it manually — for example, to switch devices or to reconnect after a device comes back in range.

1. Open the **Settings** app .
2. Under **Wireless & networks**, tap **Bluetooth**.
3. Make sure Bluetooth is On.
4. In the list of paired devices, tap a paired but unconnected device.
5. When the Ranger 5 / TSC5 and the Bluetooth device are connected, the device is displayed in the list as connected.

Connecting to RS-232 peripherals

If you require an RS-232 port, you may connect a 3rd party USB-C to RS-232 adapter. To connect an RS-232 device, plug the device cable into the RS-232 adapter port and plug the USB-C plug on the adapter into the USB-C port on the Ranger 5 / TSC5. The adapter may require drivers to be installed on the Ranger 5 / TSC5. Refer to the documentation for the RS-232 device for instructions on setting up and using the device.

Transferring data between your Ranger 5 / TSC5 and another computer

You can transfer data or files between your Ranger 5 / TSC5 and another device. There are a number of ways you can do this, including:

- using a USB data transfer cable (type C). See [Transferring data using a USB-C cable](#).

- using a USB (type C) memory stick; see [Connecting to USB accessories](#).
- via Wireless LAN; see [Working with Wi-Fi networks](#).
- using cloud-based file sync services, such as [Dropbox](#), [Microsoft OneDrive](#), [Google Drive](#) over Wi-Fi or 4G.
- via Ethernet, see [Using the desktop hub](#) or 3rd party USB-C to Ethernet adapters

Transferring data using a USB-C cable

You can transfer data to a device powered by a Windows operating system or to a MacOS device using a USB (type C) data cable.

Transfer with the Windows operating system

1. Unlock the screen on the Ranger 5 / TSC5.
2. Use a USB type C data transfer cable to connect the Ranger 5 / TSC5 to the Windows device.
3. Swipe down from the top of the Ranger 5 / TSC5 screen to see your notifications.
4. Tap the **USB for...** notification. Then tap **Transfer files (MTP)**.
5. A **File Transfer** window opens on the Windows device. Use it to drag and drop files, just like with other external devices and storage.
6. When you are done, eject the Ranger 5 / TSC5 from the Windows device.
7. Unplug the USB cable.

Transfer with a MacOS device

To transfer files, you must have Android File Transfer installed on your device. Android File Transfer is compatible with MacOS X 10.5 or later and Android 3.0 or later.

1. Download and install [Android File Transfer](#) on your Ranger 5 / TSC5.
2. Open Android File Transfer. (The next time that you connect your device, it should open automatically.)
3. Unlock the screen on the Ranger 5 / TSC5.
4. Use a USB type C data transfer cable to connect the Ranger 5 / TSC5 to the MacOS device.
5. Swipe down from the top of the Ranger 5 / TSC5 screen to see your notifications.
6. Tap the **USB for...** notification. Then tap **Transfer files (MTP)**.
7. An **Android File Transfer** window opens on the MacOS device. Use it to drag and drop files.
8. When you are done, unplug the USB cable.

Using EMPOWER modules

EMPOWER modules can be used to extend or expand the basic capabilities of your device. Each EMPOWER module can be installed, removed, or moved from one EMPOWER enabled device to another. The Ranger 5 / TSC5 allows one EMPOWER module to be installed at a time.

This section tells you how to install and start using Trimble EMPOWER modules.

- [About EMPOWER modules](#)
- [Attaching the EMPOWER module to the device](#)
- [Installing EMPOWER module software and drivers](#)
- Configure and control the module with the [Trimble EMPOWER Hub](#) application

About EMPOWER modules

The Ranger 5 / TSC5 handheld is part of the Trimble EMPOWER platform, a family of professional modular field devices that can be customized for nearly any application and industry. Each product in this product family is equipped with one or more EMPOWER module bays, which can be used to extend or expand the basic capabilities of your device. Each EMPOWER module can be installed, removed, or moved from one EMPOWER enabled device to another.

The EMPOWER platform devices and modules make it easy for you to manage a fleet of devices

across multiple users, field roles and job requirements.

For more information about the EMPOWER platform, and the selection of EMPOWER enabled modules that are compatible with your device, contact your local reseller, or go to empower.trimble.com.

The functionality of EMPOWER modules is unlocked through applications and utilities developed specifically for each module. For more information about using Trimble EMPOWER modules, refer to the module documentation available here: www.trimble.com/empowermodules.

Module functionality can also be directly integrated into field software by developers with access to the Trimble EMPOWER Developer Program using system and module SDKs and APIs. Module Developer Kits are also available to quickly prototype custom modules.

For more information on the developer resources and tools available for the Ranger 5 / TSC5, contact your local reseller, or go to empower.trimble.com/developer.

Installing & removing EMPOWER modules on the device

To attach or remove a module to your Ranger 5 / TSC5, follow the steps below:

1. **NOTE** - Before you install or remove a module from the device, **make sure the device is powered off or in Sleep state**.
 - a. For more information, see [Charging and power modes](#).
2. Turn the device over.
3. To attach the module:
 - a. Hook the EMPOWER module onto the device, ensuring that the slots on the top of the device line up with those on the EMPOWER module.

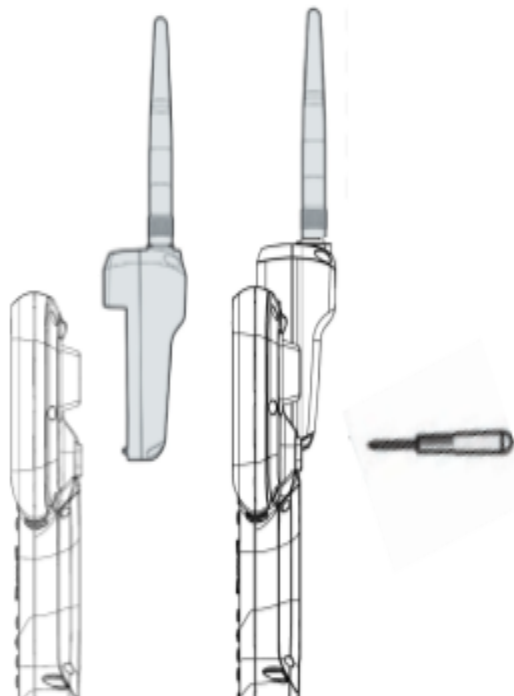

- b. Tighten the 2 captive screws at the bottom of the EMPOWER module using a Phillips #1 screwdriver. The stylus included in the Ranger 5 / TSC5 packout has an integrated screwdriver which may be used. Do not overtighten the screws.
 - c. Press the **Power** key to start or wake-up your Ranger 5 / TSC5, then follow the instructions in the next section to install drivers and software for your module if

necessary.

4. To remove the module:
 - a. Loosen the 2 captive screws at the bottom of the EMPOWER module using the screwdriver provided on the stylus. Slide the module up and off. Store the module in a safe, dry location to prevent damage to the module interface pogo-pins.

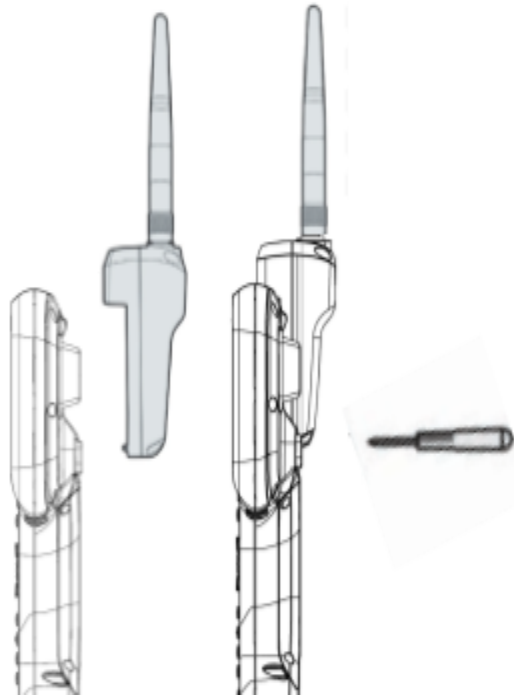

Installing EMPOWER module drivers and software

Before using an EMPOWER module for the first time, you may need to install drivers and software apps on your Ranger 5 / TSC5 handheld in order for the device to recognize and operate the module. The Trimble EMPOWER drivers and software come pre-installed on the Ranger 5 / TSC5, however, if you need to download or update these components, you can find the apps and drivers on the Google Play Store app, which is pre-installed on your Ranger 5 / TSC5 handheld:

- Open **Apps** and tap the **Play Store**  app.
- Use the Google Play Store to search and browse for content to download.
- Download the apps and drivers directly to the Ranger 5 / TSC5.
- Follow the instructions on the screen to install the drivers and other software as required for your EMPOWER module.

Refer to the documentation supplied with your module for instructions on which components to update and how to use the module and software utilities.

NOTE – Additional information regarding EMPOWER modules is located here: www.trimble.com/empowermodules.

Trimble EMPOWER Hub

The EMPOWER Hub is a centralized location to control and manage Trimble EMPOWER modules from one convenient, easy-to-use application. The EMPOWER Hub comes pre-installed on your Ranger 5 / TSC5 and can be used to monitor module status and manage modules attached to your device, including:

- View module status information

- Enable and Disable connected modules
- Launch utilities to configure your module(s)
- Configure and launch applications associated with your modules
- Check for and install module firmware updates

Turn on the device and start the EMPOWER Hub. From the **Home** screen, swipe up to open the **Apps** screen. Tap on the **EMPOWER Hub** icon to open the app.

For more information, refer to the module documentation available here: www.trimble.com/empowermodules.

TIP - To save battery power, turn off EMPOWER modules if you will not be using them for a prolonged period.

Disabling and enabling modules in the EMPOWER Hub

Refer to the module documentation available here: www.trimble.com/empowermodules

Using the shoulder sling

There are several ways to attach the shoulder sling to the Ranger 5 / TSC5 controller:

- If you have a handstrap attached to the device (see [Attaching the handstrap](#)), clip the shoulder sling onto the handstrap buckles.
- If you do not have a handstrap attached to the device, attach the shoulder sling standalone connector straps to the handstrap slots on the device, and clip the shoulder sling to the connector straps.
- You can attach the shoulder sling to the handstrap slots/shoulder sling connector straps on either side of the device, according to your preference.
- You can attach a shoulder sling to the top or bottom handstrap slots, or use two shoulder slings and attach them crosswise to the device to create a harness.

Using the desktop hub

The optional desktop hub accessory provides a convenient way to use your Ranger 5 / TSC5 in an office. The desktop hub connects to the device with a USB cable and includes::

- One display port, which supports a single 2K monitor (up to 2560 x 1600 x 30 fps)
- One DVI-I and one HDMI port, which support dual monitors (up to 2048 x 1152 x 60 fps)
- One Gigabit Ethernet port for wired access at ultra-fast speeds
- Three USB 3.0 SuperSpeed ports for the latest peripherals, including mouse and keyboard
- One USB 3.0 powered port for fast device charging
- One Audio In/Out port for microphones, speakers, and earphones
- An integrated lock slot which accommodates security locks to safeguard equipment

To use external monitors, drivers are required; the Ranger 5 / TSC5 controller downloads the drivers when it is first connected to the desktop hub (this may take a few minutes). Once the drivers are downloaded, the Ranger 5 / TSC5 controller will use the drivers every time the hub is connected.

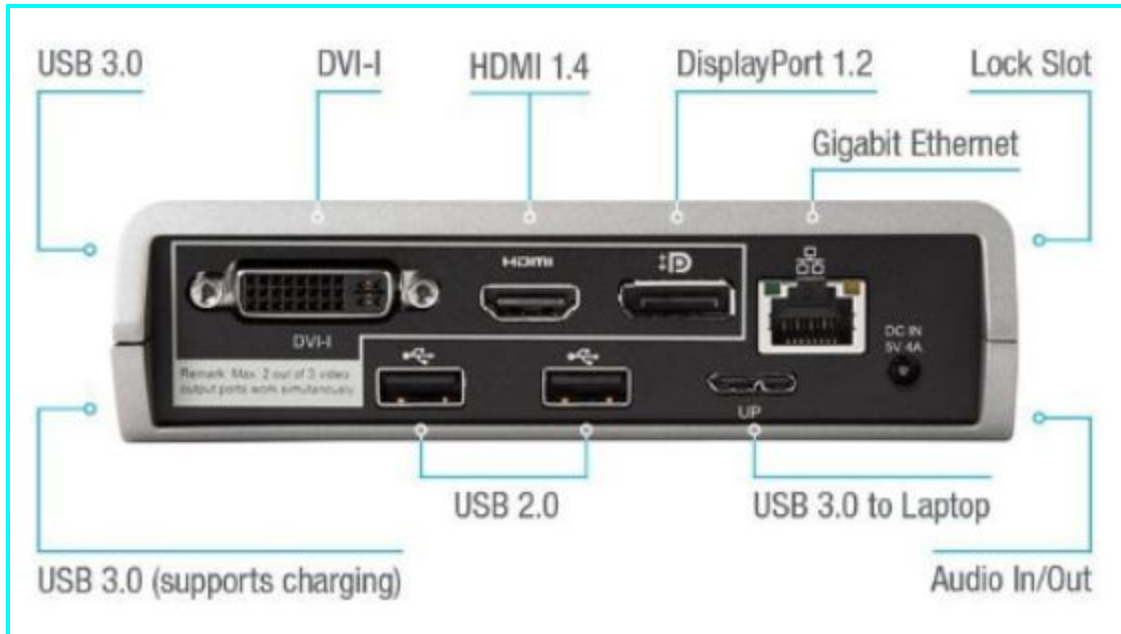

To set up your workspace with the desktop hub:

1. Plug the AC end of the desktop hub power cord into an electrical outlet or power strip, and plug the other end into the power port on the desktop hub.
2. If you want to use a wired network connection, connect a network cable to the Ethernet port on the desktop hub.
3. Connect your computer peripherals to the USB ports on the desktop hub.
4. Connect a cable from your monitor to the HDMI Port on the desktop hub. If your monitor cable doesn't have a HDMI connector, you'll need to buy another cable or an adapter.
5. Connect the Ranger 5 / TSC5 to the desktop hub using the USB-C cable included with the Ranger 5 / TSC5.

Using the accessory battery and charger

- Using the accessory battery
- Charging and power modes

Chapter 7: Using the camera

- Taking photos and videos
- Changing camera settings
- Viewing photos and videos

The Ranger 5 / TSC5 is fitted with one rear facing 13MP autofocus camera with LED flash. The camera is accessible by the camera application. [This section describes how to make use of the Ranger 5 / TSC5 device's onboard camera.](#)

NOTE - The device may be shipped with a protective film covering the rear camera and flash windows. Remove the film before first use to ensure proper focus and exposure of your photos and videos





Discard the protective film on the camera and flash windows before first use.



Taking photos and videos

By default, the built-in Camera app is ready to take photos, but you can switch easily between photo and video mode.

To take a photo or record a video:

1. Launch the Camera app by doing one of the following:
 - Double-tap your device's Power button
 - On the lock screen, swipe away from the camera icon in the bottom right corner.
 - With the screen unlocked, tap the **Google Camera** app icon or say **OK Google, take a picture.**
2. Tap the icon in the bottom right corner to select the mode you want to use:
 -  Photo
 -  Panorama
 -  Video
 - Swipe from the left to display the capture mode choices
 - Choose Camera for still images
 - Choose Video for videos
3. To take a photo, panorama, or video:
 - Point the camera and wait for it to autofocus.
 - To zoom in, move your thumb and forefinger apart on your screen. To zoom out, pinch your thumb and forefinger on your screen.
 - To focus on and expose the subject of the photo, tap it on your screen.



Tap the capture icon in the bottom center of the screen. The capture icon will vary depending on the mode you selected:

-  Take a **Photo.**
-  Start capturing a **Panorama.**
-  Start shooting a **Video.**

4. To see the photos you've saved, tap the thumbnail image in the corner of the screen.

Changing camera settings

To change how photos or videos are being captured:

1. Tap the icon in the bottom right corner to select the mode you want to change settings for:
 -  Photo.
 -  Video
2. Do any of the following:
 - Tap the **Settings** icon  to access a list of settings specific to photo or video capture.
 - Tap the Front / Rear camera icon top center of the screen to switch between the front and rear camera.
 - Tap any of the options at the top of the screen to access other settings specific to the active capture mode.

Tap the **...** icon. The capture mode icons display, and allow you to change basic capture modes:

1. Switch between the front and rear camera
2. Set a timer (3 seconds, 10 seconds, or Off)
3. Display a grid to help compose your images
4. Use the camera flash

Advanced camera settings

To access advanced camera settings, swipe from the left side of the device from the Camera app, then tap the settings cog icon. Advanced settings allow you to change:

- Set Image and video resolution and quality
- Turn on or off Geotagging
- Turn on or off manual exposure control

Enable the Camera app to access your location to geo-tag photos

1. In the Camera app settings, tap the **Settings** icon .
2. In the Settings list, tap **GPS location** to toggle on/off as required.
3. To close the Settings list, tap anywhere on the screen off the list.

Viewing photos and videos

By default, your photos and videos are saved to the **Photos** and **Gallery** apps on the Ranger 5 / TSC5; open these apps from the Apps screen.

There are several ways to look through your photos and videos:

- **Camera app:** From within the Camera app, tap on an image thumbnail, or swipe from the right of the screen to view saved photos and videos.
 - tap the thumbnail in the bottom right corner of the screen to open the **Photos app** and then do any of the following:
 - select **See all photos**

- swipe right or left to scroll through other photos / videos in your collection.
- **Photos app:** Images captured with the Camera app are automatically accessible in the Photos app.
 - open the **Photos app** from the Windows Start menu.
- **File Explorer or OneDrive app:** Go to your **Pictures library** and open your **Camera roll**.

Chapter 8: Using the pre-installed apps

- [Touch Modes](#) (under Settings)
- [Assign Keys app: F keys](#)
- Trimble EMPOWER Hub
- Trimble GNSS Status utility
- Bundled Google apps
- Getting more apps

The Ranger 5 / TSC5 comes with a range of useful pre-installed software. This section describes the most important pre-installed applications you should know about, and summarizes what they can be used for.

Trimble EMPOWER Hub

see [Trimble EMPOWER Hub](#).

Trimble GNSS Status utility



The Trimble GNSS Status utility enables you to view accuracy information for the currently selected GNSS source. For receivers that support these functions, use the GNSS Status utility to:







- set up correction sources
- apply licensing options
- configure NMEA output



For more information, refer to the *Trimble GNSS Status Utility User Guide* on www.trimble.com.

Bundled Google apps

Here are some of the useful productivity applications that come bundled with your Ranger 5 / TSC5 handheld, powered by the Android 10 operating system.

	Google and Google Chrome. Use to browse the Internet and access anything online.
	Gmail. Use Gmail to manage your email. You can add multiple accounts and access them through this single point.
	Calendar. Use Calendar to manage your schedule.

	<p>Google+. Use Google+ to build a social network with contacts from your Google account(s).</p>
	<p>Contacts. The Contacts app brings all your contacts together in a single space. See each contact's email address, phone number, website, and other information at a glance.</p>
	<p>Messages. Use for text conversations with your contacts.</p>
	<p>Maps. Use to view maps, get directions, and find local businesses.</p>
	<p>Camera. The Camera app lets you take regular photos or video using either the front or back camera on the device.</p>
	<p>Photos. Edit and organize your photos using the Photos app. Crop, enhance, and add effects to your images.</p>
	<p>Gallery. Use to store and manage your photos.</p>
	<p>Hangouts. Use Google Hangouts for messaging, video chat, SMS and VOIP.</p>
	<p>Drive. Store files, photos, drawings, recordings, videos and much more in Google Drive; you can then access your files stored in Drive from any smartphone, tablet, or computer.</p>
	<p>Docs, Sheets, Slides. Use to manage your office documents stored on Google Drive.</p>
	<p>Keep. Use Google Keep to take notes, including text, lists, images, and audio.</p>
	<p>Play Music and Play Movies.</p>
	<p>News & Weather brings you the latest breaking stories as well as more in-depth coverage. You can customize the coverage to add more local information or highlight the topics you choose.</p>

	Clock
	Calculator
	YouTube
	Downloads
	Android Pay ...

Getting more apps

You can get apps, games, and digital content for your device using the Google Play™ Store app. The Google Play Store app is pre-installed on your Ranger 5 / TSC5 handheld:

- Open **Apps** and tap the **Play Store**  app.
- Use the Google Play Store to search and browse for content to download.

Chapter 9: Troubleshooting, downloading updates, and repair

- > Troubleshooting
- > Operating system and software updates
- > Repairing your device

Troubleshooting

This section contains answers to some common troubleshooting questions. If you encounter problems when using your Ranger 5 / TSC5, try the following troubleshooting tips to detect and solve the problem. If problems persist, contact your local distributor for support.

Further assistance and support with the Android 10 operating system

For comprehensive online support, how-to guides, troubleshooting articles and related downloads for the Android 10 operating system, go to the online [Android support pages](#) for the Android 10 operating system.

Performance issues

Device is running slowly, restarts or crashes frequently

If your device is running slowly, keeps rebooting itself, or crashing without restarting, one of the steps below may fix the issue. After following the steps for each recommended solution, check whether it fixed your issue.

Check for Android updates

System updates can bring improvements that may fix your issue. To check for and install system updates:

1. Open the **Settings** app  .
2. Scroll to the bottom and tap **About tablet**  **-System update.**

3. The update status displays. Follow any on-screen instructions.

Check storage and free up space



You may see issues if the device's internal storage is full or almost full. To free up space that the device needs to work properly, you can remove unnecessary files and clear cached data.

To check how much storage the device has:

1. Open the **Settings** app .
2. Tap **Storage**.
3. See how much storage you have available. The device can start having issues when less than 10% of storage is free.

Check for app updates

App updates can bring improvements that may fix your issue. To see and get updates for your apps:

1. Open the **Play Store** app .
2. At the top left, tap **Menu** .
3. Tap **My apps & games**.
4. Apps with available updates are labeled **Update**. If an update is available, tap the app  **Update**. If multiple updates are available, tap **Update all**.

Close apps that you are not using

Normally, you don't need to close apps; Android automatically manages the memory that apps use. But to completely shut down an app, including any background services that it may be using:

1. Open the **Settings** app .
2. Tap **Apps & notifications**, then if required tap to expand the list of all apps.
3. Tap the app that you want to close then tap **Force stop**.
4. Tap **Force stop**.

TIP - To help identify apps that cause problems, make a list of which apps you have manually force-stopped.

See if an app is causing the issue

The issue may be caused by an app that you downloaded. To see whether a downloaded app is causing the issue, you can reboot your device in safe mode. Safe mode temporarily disables all downloaded apps.

1. To reboot the device in safe mode, follow the instructions here: https://support.google.com/android/answer/7665064?visit_id=1-636628110244432672-3485170295&rd=1. **Follow these steps to turn on safe mode. Safe mode temporarily disables all downloaded apps.**
2. Once in safe mode, wait to see if the problem goes away.
 - **If the issue isn't resolved in safe mode**, a downloaded app is most likely not causing the issue. **Restart the device** and try other troubleshooting solutions.
 - **If the issue is resolved in safe mode**, a downloaded app is most likely causing the issue. To find out which app it is:
 - a. **Restart the device** to exit safe mode.
 - b. One by one, **uninstall recently downloaded apps**. After each removal, restart the device and check if the issue is resolved.

- c. When you have identified and removed the app that was causing the problem, you can reinstall the other apps that you removed.

TSC7 tips, some could be useful for Bobcat?:

- Operating system updates may be installing.

Windows 10 Pro may have automatically downloaded software or operating system updates, and is installing these in the background. While these updates are being installed, system performance may be reduced, or wireless connectivity speed may appear to be slower than normal.

- You may have too many background applications are running.

Some programs start automatically and run in the background. You can disable these programs at startup to improve Windows startup time and overall system performance.

- You may have malware or a virus.

A virus or other malicious software could cause your device to run slowly. Check whether your device has a virus by using Windows Defender, which is included with Windows 10, or refer to the documentation for your third party antivirus software.

- Check your wireless network speed.

If the apps you are using are connecting to the Internet, a poor network connection may be causing them to run slowly. For detailed information on checking your network, see Wi-Fi speed is slow, page 71.

- Check for low disk space.

You may be able to improve performance if you free up some disk space on your device. Disk Cleanup can delete temporary and system files, empty the Recycle bin, and remove apps and data that you no longer need.

- Your device may have overheated.

If you are using your device in a hot environment and/or are using a processor or memory-intensive, your device may have become too hot. Move your device to a cooler spot, wait five minutes, and see if it runs faster.

Audio



EMPOWER module issues

My field software doesn't recognize my EMPOWER module

- Check module contacts and attachment
It is possible the contacts between the module and the device are dirty, or that the module is not attached correctly. Ensure that the module contacts are clean and that the screws are tightened correctly.
- Your field software is not configured to communicate with the EMPOWER module
Check that your field software supports the EMPOWER module directly and that the field software is configured to talk to the EMPOWER module directly or through the correct COM port.

Refer to the Trimble EMPOWER modules documentation here www.trimble.com/empowermodules for more information.

The EMPOWER Hub doesn't show my module

- Check module contacts and attachment.
It is possible the contacts between the module and the device are dirty, or that the module is not attached correctly. Ensure that the module contacts are clean and that the screws are tightened correctly.

Wireless connectivity issues

Wi-Fi speed is slow

- Your network is running slow for all devices.
You should first check to see whether your network is slow on another device. Can you

connect to your wireless network and browse the web at normal speeds from another device? Try running a Network Speed Test to ensure your Internet connection is functioning normally.

- Your Wi-Fi signal is weak.

Look at the wireless network icon in the taskbar.



This icon in the Status bar shows the current Wi-Fi signal strength. If the icon is partially dimmed, move your device closer to your wireless router to see if the signal improves. If your router is broadcasting on both a 2.4GHz and 5GHz frequency, try connecting to a different frequency. In general, a network operating on the 5GHz frequency will be faster and less susceptible to interference, but will have a shorter range than a 2.4GHz network.

Power and battery issues

Battery will not charge

- The battery is overheated, or too cold.

The battery will charge between 0 °C and 45 °C (32 °F and 113 °F). If you have been using or storing the battery and/or device in a particularly hot or cold environment, the battery may be outside the safe charging temperature range. Sensors in the battery will prevent the battery from charging until its temperature returns to a normal level.

- The battery is not installed correctly.

If the battery is not installed correctly in the device or the battery charger, it may not have a proper connection and will not charge.

- The battery terminals are dirty or corroded.

If the terminals of the battery are dirty or corroded, it may not have a proper connection and will not charge.

Device will not start up

- The battery does not have enough charge to power the device.

Remove the battery from the device, and press-hold the charge indicator button on the battery. At least one charge LED must be lit up to indicate that a battery has enough power for the device to start on battery power. If no LEDs light up on a battery, reinsert the battery into the device and attach the device to an external power source, swap the battery for a charged battery, or charge the battery using the charging dock (see Using the charging dock, page 45) before reinserting it.

- The battery is not correctly installed.

The device may not be receiving power from the battery if it is not installed properly. Remove the battery, then replace it correctly, pressing down on both corners until it clicks into place. Slide the battery lock to the lock position (down).

Device suddenly turned off during use

- Make sure you are not accidentally pressing the Power key.

The Power key is located in the middle on the left side of the keyboard. Make sure that while gripping the device that you are not accidentally pressing the Power key, which places the

device in suspend mode.

- The device may have run out of power.

If your Ranger 5 / TSC5 battery charge level gets too low, the device will automatically go into a hibernate mode to prevent loss of data. Remove the battery from the device, and check the battery level by pressing-holding the battery level button on the battery. If the battery charge is too low, reinsert the battery into the device and attach the device to an external power source, swap the battery for a charged battery, or charge the battery using the charging dock (see Using the charging dock, page 45) before reinserting it.

If you regularly run out of battery power while in the field, consider carrying a spare battery with you. Ranger 5 / TSC5 supports warm-swapping of the battery, which means that the device will keep running for a few minutes while you remove the battery pack and replace it with another. Ensure you have sufficient charge in the internal battery before you remove a battery and replace it with another, or else the device shuts down.

Device shut-down when warm-swapping the battery

- Internal batteries or Warm-swap battery is not sufficiently charged
 - The hot-swap back-up battery allows you to change the main device battery pack for a charged one without shutting the device down. In order to function correctly, the hot-swap battery needs at least X minutes of charging time before it can work properly. If you attempt multiple hot-swaps without allowing the back-up battery to recharge, your device may shut-down when the battery pack is removed.

Restarting or resetting the operating system

If your device becomes unresponsive, and the troubleshooting guide does not resolve the problem, restarting or resetting your device may solve the problem.

For detailed instructions on the recovery options in Android 10, refer to the <insert link>.

Restarting your (unresponsive) device

If your device is no longer responding to touchscreen or keyboard input, you may need to force it to restart by removing power from the system.

NOTE - Restarting the system by holding down the Power key removes power to the CPU. Any unsaved files and settings will be lost.

To force your device to restart:

1. Press and hold the Power key until the **Power Off** and **Restart** options appear on the screen.
2. Tap **Restart** to restart the device.

To force your device to restart, press and hold the Power key until the device shuts down (~15 seconds), then restart your device by pressing the Power key.

Resetting your device to factory default settings

If restarting your device does not resolve the issue that you are seeing, resetting it might help.

You can remove all data from your device by resetting it to factory settings.



WARNING - A factory reset wipes all data from the device. While any data stored in your Google Account will be restored, all apps and their associated data will be uninstalled.



WARNING - Your device is protected to prevent other people from using it if it's been reset to factory settings. To ensure that it's really you doing the reset, you'll need to enter a Google username and password associated with the device after factory reset. If you don't have this information, you won't be able to finish the setup process and use the device at all after factory reset.

Erasing your data may take some time, so make sure that you plug your device into a power source before you start.



1. Open the **Settings** app
2. Tap **System**, then tap **Advanced**.
3. Tap **Reset options**, and then tap the reset option you want to use: **Reset Wi-Fi, mobile & Bluetooth, Reset app preferences, or Erase all data (factory reset)**.
4. Follow the on-screen instructions for the option you selected. You may need to enter your unlock pattern, PIN, or password.
5. When the device has finished erasing, select the option to reboot your device. If you have a screen lock, you'll need to enter your pattern, PIN, or password.

Operating system and software updates

Periodically, operating system and software application updates will be available for your device.

Android 10 Updates

Any operating system updates for your device will be available to you over the air.

TODO - Add Android update info for Trimble OS updates and Google security updates....

Android is much different than W10. The Windows 10 operating system periodically checks for updates so you don't have to. When an update is available, it is automatically downloaded and installed — keeping your device up-to-date with the latest features.

Installing the latest updates can help fix common issues, but you must be online to download the updates. If you are having trouble connecting and downloading updates because your wireless network is too slow, you can try using a wired network via the Desktop Hub accessory.

Once online, to check for and install the latest updates manually, go to Settings / Update & security / Windows Update, and select Check for updates. If Windows Update says your device is up to date, you have all the updates that are currently available.

Trimble recommends that you keep the Windows operating system updated. This reduces your vulnerability to cyber attacks, and helps to improve the Windows operating system. You can configure the settings to prevent downloads and restarts in field; go to Settings / Update & Security / Windows Update / Update Settings.

For more information about Windows updates, refer to the official Windows Update: FAQ on www.microsoft.com.

Software downloads and updates

The latest versions of software including drivers, firmware updates, and software utilities, are available on the Google Play store, or on the Trimble technical support pages at www.trimble.com.

Repairing your device

Before you send your Ranger 5 / TSC5 for repair, check the troubleshooting tips in this document. If you can't solve the problem with troubleshooting, contact your local Trimble dealer for further support.

Repair of this product should only be performed by a Trimble Authorized Service Provider. Any attempt to disassemble this product by a non-authorized service provider will void the warranty.

For more information, contact your local Trimble dealer.