

TEST REPORT

CERTIFICATE OF CONFORMITY

Standard: 47 CFR FCC Part 22
47 CFR FCC Part 24
47 CFR FCC Part 27
47 CFR FCC Part 2

Report No.: RFBICM-WTW-P22110528-9

FCC ID: S9E-125500

Product: Rugged Handheld Computer

Brand: 

Model No.: 125500

Received Date: 2022/12/7

Test Date: 2023/4/27 ~ 2023/10/3

Issued Date: 2023/10/27

Applicant: Trimble Inc.

Address: 5475 Kellenburger Road, Dayton, Ohio, 45424

Issued By: Bureau Veritas Consumer Products Services (H.K.) Ltd., Taoyuan Branch
Lin Kou Laboratories

Lab Address: No. 47-2, 14th Ling, Chia Pau Vil., Lin Kou Dist., New Taipei City, Taiwan

Test Location (1): No. 19, Hwa Ya 2nd Rd., Wen Hwa Vil., Kwei Shan Dist., Taoyuan City 33383, TAIWAN

FCC Registration / 788550 / TW0003

Designation Number:

Test Location (2): No. 70, Wenming Rd., Guishan Dist., Taoyuan City 333, Taiwan (R.O.C.)

FCC Registration / 281270 / TW0032

Designation Number:

Approved by: Jeremy Lin, **Date:** 2023/10/27
Jeremy Lin / Project Engineer

This test report consists of 299 pages in total. It may be duplicated completely for legal use with the approval of the applicant. It should not be reproduced except in full, without the written approval of our laboratory. The test results in the report only apply to the tested sample. The test results in this report are traceable to the national or international standards.



Prepared by : Gina Liu / Specialist

This report is governed by, and incorporates by reference, the Conditions of Testing as posted at the date of issuance of this report at <http://www.bureauveritas.com/home/about-us/our-business/cps/about-us/terms-conditions/> and is intended for your exclusive use. Any copying or replication of this report to or for any other person or entity, or use of our name or trademark, is permitted only with our prior written permission. This report sets forth our findings solely with respect to the test samples identified herein. The results set forth in this report are not indicative or representative of the quality or characteristics of the lot from which a test sample was taken or any similar or identical product unless specifically and expressly noted. Our report includes all of the tests requested by you and the results thereof based upon the information that you provided to us. Measurement uncertainty is only provided upon request for accredited tests. Statements of conformity are based on simple acceptance criteria without taking measurement uncertainty into account, unless otherwise requested in writing. You have 60 days from date of issuance of this report to notify us of any material error or omission caused by our negligence or if you require measurement uncertainty; provided, however, that such notice shall be in writing and shall specifically address the issue you wish to raise. A failure to raise such issue within the prescribed time shall constitute your unqualified acceptance of the completeness of this report, the tests conducted and the correctness of the report contents.

Table of Contents

Release Control Record	5
1 Certificate	6
2 Summary of Test Results	7
2.1 Measurement Uncertainty	8
2.2 Supplementary Information	8
3 General Information	9
3.1 General Description of EUT	9
3.2 Antenna Description of EUT	12
3.3 Test Mode Applicability and Tested Channel Detail	13
3.4 Test Program Used and Operation Descriptions	26
3.5 Connection Diagram of EUT and Peripheral Devices	26
3.6 Configuration of Peripheral Devices and Cable Connections	26
4 Test Instruments	27
4.1 Effective Radiated Power and Equivalent Isotropically Radiated Power	27
4.2 Modulation Characteristics	27
4.3 Peak to Average Ratio	27
4.4 Bandwidth	27
4.5 Conducted Spurious Emissions	27
4.6 Radiated Spurious Emissions below 1GHz	28
4.7 Radiated Spurious Emissions above 1GHz	29
4.8 Frequency Stability	30
5 Limits of Test Items	31
5.1 Effective Radiated Power and Equivalent Isotropically Radiated Power	31
5.2 Modulation Characteristics	31
5.3 Peak to Average Ratio	31
5.4 Bandwidth	31
5.5 Conducted Spurious Emissions	32
5.6 Radiated Spurious Emissions below 1GHz	33
5.7 Radiated Spurious Emissions above 1GHz	34
5.8 Frequency Stability	34
6 Test Arrangements	35
6.1 Effective Radiated Power and Equivalent Isotropically Radiated Power	35
6.1.1 Test Setup	35
6.1.2 Test Procedure	35
6.2 Modulation Characteristics	36
6.2.1 Test Setup	36
6.2.2 Test Procedure	36
6.3 Peak to Average Ratio	36
6.3.1 Test Setup	36
6.3.2 Test Procedure	36
6.4 Bandwidth	37
6.4.1 Test Setup	37
6.4.2 Test Procedure	37
6.5 Conducted Spurious Emissions	39
6.5.1 Test Setup	39
6.5.2 Test Procedure	39
6.6 Radiated Spurious Emissions below 1GHz	40
6.6.1 Test Setup	40
6.6.2 Test Procedure	40
6.7 Radiated Spurious Emissions above 1GHz	41
6.7.1 Test Setup	41
6.7.2 Test Procedure	41
6.8 Frequency Stability	42
6.8.1 Test Setup	42



6.8.2	Test Procedure.....	42
7	Test Results of Test Item.....	43
7.1	Effective Radiated Power and Equivalent Isotropically Radiated Power	43
7.1.1	NR n2 SCS 15 kHz	43
7.1.2	NR n5 SCS 15 kHz	47
7.1.3	NR n41 SCS 30 kHz	51
7.1.4	NR n71 SCS 15 kHz	59
7.1.5	NR n77 (3450-3550 MHz) SCS 30 kHz	63
7.1.6	NR n77 (3700-3980 MHz) SCS 30 kHz	67
7.1.7	NR n78 SCS 30 kHz	71
7.2	Modulation Characteristics	77
7.2.1	NR n2 SCS 15 kHz	77
7.2.2	NR n5 SCS 15 kHz	78
7.2.3	NR n41 SCS 30 kHz	79
7.2.4	NR n71 SCS 15 kHz	80
7.2.5	NR n77 (3450-3550 MHz) SCS 30 kHz	81
7.2.6	NR n77 (3700-3980 MHz) SCS 30 kHz	82
7.2.7	NR n78 SCS 30 kHz	83
7.3	Peak to Average Ratio	84
7.3.1	NR n2 SCS 15 kHz	84
7.3.2	NR n5 SCS 15 kHz	88
7.3.3	NR n41 SCS 30 kHz	92
7.3.4	NR n71 SCS 15 kHz	99
7.3.5	NR n77 (3450-3550 MHz) SCS 30 kHz	103
7.3.6	NR n77 (3700-3980 MHz) SCS 30 kHz	106
7.3.7	NR n78 (3700-3980 MHz) SCS 30 kHz	109
7.4	Bandwidth.....	114
7.4.1	NR n2 SCS 15 kHz	114
7.4.2	NR n5 SCS 15 kHz	118
7.4.3	NR n41 SCS 30 kHz	122
7.4.4	NR n71 SCS 15 kHz	129
7.4.5	NR n77 (3450-3550 MHz) SCS 30 kHz	133
7.4.6	NR n77 (3700-3980 MHz) SCS 30 kHz	136
7.4.7	NR n78 SCS 30 kHz	139
7.5	Conducted Spurious Emissions	144
7.5.1	NR n2 SCS 15 kHz	144
7.5.2	NR n5 SCS 15 kHz	152
7.5.3	NR n41 SCS 30 kHz	160
7.5.4	NR n71 SCS 15 kHz	174
7.5.5	NR n77 (3450-3550 MHz) SCS 30 kHz	182
7.5.6	NR n77 (3700-3980 MHz) SCS 30 kHz	188
7.5.7	NR n78 SCS 30 kHz	196
7.6	Radiated Spurious Emissions below 1GHz.....	206
7.6.1	NR n2 SCS 15 kHz	206
7.6.2	NR n5 SCS 15 kHz	208
7.6.3	NR n41 SCS 30 kHz	210
7.6.4	NR n71 SCS 15 kHz	212
7.6.5	NR n77 (3450-3550 MHz) SCS 30 kHz	214
7.6.6	NR n77 (3700-3980 MHz) SCS 30 kHz	216
7.6.7	NR n78 SCS 30 kHz	218
7.7	Radiated Spurious Emissions above 1GHz	220
7.7.1	NR n2 SCS 15 kHz	220
7.7.2	NR n5 SCS 15 kHz	226
7.7.3	NR n41 SCS 30 kHz	232
7.7.4	NR n71 SCS 15 kHz	241
7.7.5	NR n77 (3450-3550 MHz) SCS 30 kHz	247
7.7.6	NR n77 (3700-3980 MHz) SCS 30 kHz	253
7.7.7	NR n78 SCS 30 kHz	259
7.8	Frequency Stability	268
7.8.1	NR n2 SCS 15 kHz	268



7.8.2	NR n5 SCS 15 kHz	272
7.8.3	NR n41 SCS 30 kHz	276
7.8.4	NR n71 SCS 15 kHz	283
7.8.5	NR n77 (3450-3550 MHz) SCS 30 kHz	287
7.8.6	NR n77 (3700-3980 MHz) SCS 30 kHz	290
7.8.7	NR n78 SCS 30 kHz	293
8	Pictures of Test Arrangements	298
9	Information of the Testing Laboratories	299





Release Control Record

Issue No.	Description	Date Issued
RFBICM-WTW-P22110528-9	Original release.	2023/10/27

1 Certificate

Product: Rugged Handheld Computer

Brand: 

Test Model: 125500

Sample Status: Engineering sample

Applicant: Trimble Inc.

Test Date: 2023/4/27 ~ 2023/10/3

Standard: 47 CFR FCC Part 22
47 CFR FCC Part 24
47 CFR FCC Part 27
47 CFR FCC Part 2

Measurement procedure: ANSI/TIA/EIA-603-E 2016

ANSI C63.26-2015

KDB 971168 D01 Power Meas License Digital Systems v03r01

KDB 971168 D02 Misc Rev Approv License Devices v02r01

The above equipment has been tested by **Bureau Veritas Consumer Products Services (H.K.) Ltd., Taoyuan Branch**, and found compliance with the requirement of the above standards. The test record, data evaluation & Equipment Under Test (EUT) configurations represented herein are true and accurate accounts of the measurements of the sample's RF characteristics under the conditions specified in this report.

2 Summary of Test Results

47 CFR FCC Part 22 47 CFR FCC Part 24 47 CFR FCC Part 27 47 CFR FCC Part 2			
Standard / Clause	Test Item	Result	Remark
FCC 47 CFR Part 2.1046 FCC 47 CFR Part 22.913 (a) FCC 47 CFR Part 24.232 (c) FCC 47 CFR Part 27.50(h) FCC 47 CFR Part 27.50(c) FCC 47 CFR Part 27.50(j) FCC 47 CFR Part 27.50(k)	Effective Radiated Power and Equivalent Isotropically Radiated Power	Pass	Meet the requirement of limit.
FCC 47 CFR Part 2.1047	Modulation Characteristics	Pass	Meet the requirement of limit.
FCC 47 CFR Part 22.913 (d) FCC 47 CFR Part 24.232 (d) FCC 47 CFR Part 27.50(k)(4) FCC 47 CFR Part 27.50(j)(4)	Peak to Average Ratio	Pass	Meet the requirement of limit.
FCC 47 CFR Part 2.1049	Bandwidth	Pass	Meet the requirement of limit.
FCC 47 CFR Part 2.1051 FCC 47 CFR Part 22.917 FCC 47 CFR Part 24.238 FCC 47 CFR Part 27.53(m) FCC 47 CFR Part 27.53(g) FCC 47 CFR Part 27.53(l) FCC 47 CFR Part 27.53(n)	Conducted Spurious Emissions	Pass	Meet the requirement of limit.
FCC 47 CFR Part 2.1053 FCC 47 CFR Part 22.917 FCC 47 CFR Part 24.238 FCC 47 CFR Part 27.53(m) FCC 47 CFR Part 27.53(g) FCC 47 CFR Part 27.53(l) FCC 47 CFR Part 27.53(n)	Radiated Spurious Emissions below 1GHz	Pass	Minimum passing margin is -26.84 dB at 39.70 MHz
FCC 47 CFR Part 2.1053 FCC 47 CFR Part 22.917 FCC 47 CFR Part 24.238 FCC 47 CFR Part 27.53(m) FCC 47 CFR Part 27.53(g) FCC 47 CFR Part 27.53(l) FCC 47 CFR Part 27.53(n)	Radiated Spurious Emissions above 1GHz	Pass	Minimum passing margin is -23.05 dB at 5185.98 MHz
FCC 47 CFR Part 2.1055 FCC 47 CFR Part 22.355 FCC 47 CFR Part 24.235 FCC 47 CFR Part 27.54	Frequency Stability	Pass	Meet the requirement of limit.

Note: Determining compliance based on the results of the compliance measurement, not taking into account measurement instrumentation uncertainty.

2.1 Measurement Uncertainty

Where relevant, the following measurement uncertainty levels have been estimated for tests performed on the EUT as specified in CISPR 16-4-2:

Measurement	Specification	Expanded Uncertainty (k=2) (±)
Radiated Spurious Emissions below 1GHz	9 kHz ~ 30 MHz	3.00 dB
	30 MHz ~ 1 GHz	2.93 dB
Radiated Spurious Emissions above 1GHz	1 GHz ~ 18 GHz	1.76 dB
	18 GHz ~ 40 GHz	1.77 dB

The other instruments specified are routine verified to remain within the calibrated levels, no measurement uncertainty is required to be calculated.

2.2 Supplementary Information

There is not any deviation from the test standards for the test method, and no modifications required for compliance.

3 General Information

3.1 General Description of EUT

Product	Rugged Handheld Computer
Brand	
Test Model	125500
Status of EUT	Engineering sample
Power Supply Rating	Refer to note

Note:

1. The EUT supports the following ENDC configuration.

5GNR	FCC 5G FR1			ENDC
	Band	SCS	Bandwidth (MHz)	
	n2	15kHz	5/10/15/20	-
	n5	15kHz	5/10/15/20	-
	n41	30kHz	20/40/50/60/80/90/100	-
	n71	15kHz	5/10/15/20	-
	n77	30kHz	20/40/50	Band 2/5/7/12/41
	n78	30kHz	20/30/40/50/60	Band 2/7/12/38/41

* This EUT support SA mode and NSA mode, after verification, SA mode was the worst case and chosen for final test.

2. EUT Overview.

Band / Bandwidth	TX Frequency Range (MHz)	Max. EIRP Power				
		BPSK	QPSK	16QAM	64QAM	256QAM
n2 (Channel Bandwidth 5MHz)	1852.50-1907.50	241.546mW (23.83dBm)	248.313mW (23.95dBm)	179.473mW (22.54dBm)	142.561mW (21.54dBm)	87.096mW (19.40dBm)
n2 (Channel Bandwidth 10MHz)	1855.00-1905.00	241.546mW (23.83dBm)	247.172mW (23.93dBm)	179.473mW (22.54dBm)	141.906mW (21.52dBm)	87.498mW (19.42dBm)
n2 (Channel Bandwidth 15MHz)	1857.50-1902.50	244.343mW (23.88dBm)	248.886mW (23.96dBm)	186.209mW (22.70dBm)	142.889mW (21.55dBm)	87.297mW (19.41dBm)
n2 (Channel Bandwidth 20MHz)	1860.00-1900.00	281.190mW (24.49dBm)	286.418mW (24.57dBm)	214.783mW (23.32dBm)	164.059mW (22.15dBm)	104.232mW (20.18dBm)
n41 (Channel Bandwidth 20MHz)	2506.02-2679.99	288.403mW (24.60dBm)	286.418mW (24.57dBm)	210.863mW (23.24dBm)	169.044mW (22.28dBm)	103.039mW (20.13dBm)
n41 (Channel Bandwidth 40MHz)	2516.01-2670.00	284.446mW (24.54dBm)	286.418mW (24.57dBm)	213.304mW (23.29dBm)	169.434mW (22.29dBm)	101.859mW (20.08dBm)
n41 (Channel Bandwidth 50MHz)	2521.02-2664.99	283.792mW (24.53dBm)	288.403mW (24.60dBm)	212.814mW (23.28dBm)	169.044mW (22.28dBm)	103.276mW (20.14dBm)
n41 (Channel Bandwidth 60MHz)	2526.00-2659.98	288.403mW (24.60dBm)	287.078mW (24.58dBm)	211.836mW (23.26dBm)	169.434mW (22.29dBm)	103.276mW (20.14dBm)
n41 (Channel Bandwidth 80MHz)	2531.01-2655.00	288.403mW (24.60dBm)	285.759mW (24.56dBm)	214.289mW (23.31dBm)	169.044mW (22.28dBm)	101.859mW (20.08dBm)
n41 (Channel Bandwidth 90MHz)	2541.00-2644.98	287.740mW (24.59dBm)	283.139mW (24.52dBm)	214.289mW (23.31dBm)	169.434mW (22.29dBm)	103.039mW (20.13dBm)
n41 (Channel Bandwidth 100MHz)	2546.01-2640.00	286.418mW (24.57dBm)	295.121mW (24.70dBm)	219.786mW (23.42dBm)	173.380mW (22.39dBm)	105.925mW (20.25dBm)



Band / Bandwidth	TX Frequency Range (MHz)	Max. EIRP Power				
		BPSK	QPSK	16QAM	64QAM	256QAM
For Part 27Q						
n77 (Channel Bandwidth 20MHz)	3460.02-3540.00	458.142mW (26.61dBm)	467.735mW (26.70dBm)	367.282mW (25.65dBm)	269.153mW (24.30dBm)	164.059mW (22.15dBm)
n77 (Channel Bandwidth 40MHz)	3470.01-3529.98	460.257mW (26.63dBm)	466.659mW (26.69dBm)	363.078mW (25.60dBm)	267.917mW (24.28dBm)	163.682mW (22.14dBm)
n77 (Channel Bandwidth 50MHz)	3475.02-3525.00	456.037mW (26.59dBm)	465.586mW (26.68dBm)	363.915mW (25.61dBm)	267.917mW (24.28dBm)	164.816mW (22.17dBm)
n78 (Channel Bandwidth 20MHz)	3460.20-3540.00	445.656mW (26.49dBm)	459.198mW (26.62dBm)	366.438mW (25.64dBm)	258.226mW (24.12dBm)	162.930mW (22.12dBm)
n78 (Channel Bandwidth 30MHz)	3465.00-3534.99	444.631mW (26.48dBm)	462.381mW (26.65dBm)	365.595mW (25.63dBm)	257.040mW (24.10dBm)	162.930mW (22.12dBm)
n78 (Channel Bandwidth 40MHz)	3470.10-3529.98	452.898mW (26.56dBm)	461.318mW (26.64dBm)	365.595mW (25.63dBm)	255.859mW (24.08dBm)	161.065mW (22.07dBm)
n78 (Channel Bandwidth 50MHz)	3475.02-3525.00	453.942mW (26.57dBm)	456.037mW (26.59dBm)	363.078mW (25.60dBm)	258.226mW (24.12dBm)	160.694mW (22.06dBm)
n78 (Channel Bandwidth 60MHz)	3480.00-3519.99	447.713mW (26.51dBm)	459.198mW (26.62dBm)	361.410mW (25.58dBm)	259.418mW (24.14dBm)	162.930mW (22.12dBm)
For Part 27O						
n77 (Channel Bandwidth 20MHz)	3710.01-3969.99	439.542mW (26.43dBm)	449.780mW (26.53dBm)	349.945mW (25.44dBm)	257.040mW (24.10dBm)	160.325mW (22.05dBm)
n77 (Channel Bandwidth 40MHz)	3720.00-3960.00	448.745mW (26.52dBm)	458.142mW (26.61dBm)	363.078mW (25.60dBm)	251.768mW (24.01dBm)	158.125mW (21.99dBm)
n77 (Channel Bandwidth 50MHz)	3725.01-3954.99	445.656mW (26.49dBm)	462.381mW (26.65dBm)	361.410mW (25.58dBm)	257.040mW (24.10dBm)	162.181mW (22.10dBm)

Band / Bandwidth	TX Frequency Range (MHz)	Max. ERP Power				
		BPSK	QPSK	16QAM	64QAM	256QAM
n5 (Channel Bandwidth 5MHz)	826.50-846.50	69.984mW (18.45dBm)	69.984mW (18.45dBm)	54.828mW (17.39dBm)	37.239mW (15.71dBm)	23.442mW (13.70dBm)
n5 (Channel Bandwidth 10MHz)	829.00-844.00	68.707mW (18.37dBm)	69.984mW (18.45dBm)	54.576mW (17.37dBm)	37.497mW (15.74dBm)	23.878mW (13.78dBm)
n5 (Channel Bandwidth 15MHz)	831.50-841.50	69.984mW (18.45dBm)	69.823mW (18.44dBm)	55.335mW (17.43dBm)	37.325mW (15.72dBm)	23.933mW (13.79dBm)
n5 (Channel Bandwidth 20MHz)	834.00-839.00	70.146mW (18.46dBm)	71.121mW (18.52dBm)	55.335mW (17.43dBm)	37.757mW (15.77dBm)	23.988mW (13.80dBm)
n71 (Channel Bandwidth 5MHz)	665.50-695.50	90.365mW (19.56dBm)	88.716mW (19.48dBm)	63.973mW (18.06dBm)	47.315mW (16.75dBm)	29.242mW (14.66dBm)
n71 (Channel Bandwidth 10MHz)	668.00-693.00	89.950mW (19.54dBm)	87.902mW (19.44dBm)	63.973mW (18.06dBm)	47.206mW (16.74dBm)	29.309mW (14.67dBm)
n71 (Channel Bandwidth 15MHz)	670.50-690.50	89.950mW (19.54dBm)	88.308mW (19.46dBm)	63.241mW (18.01dBm)	47.206mW (16.74dBm)	29.309mW (14.67dBm)
n71 (Channel Bandwidth 20MHz)	673.00-688.00	90.573mW (19.57dBm)	92.897mW (19.68dBm)	67.143mW (18.27dBm)	49.659mW (16.96dBm)	30.690mW (14.87dBm)

Band / Bandwidth	TX Frequency Range (MHz)	Emission Designator				
		BPSK	QPSK	16QAM	64QAM	256QAM
n2 (Channel Bandwidth 5MHz)	1852.50-1907.50	4M48G7D	4M48G7D	4M47D7W	4M48D7W	4M48D7W
n2 (Channel Bandwidth 10MHz)	1855.00-1905.00	9M28G7D	9M30G7D	9M30D7W	9M30D7W	9M30D7W
n2 (Channel Bandwidth 15MHz)	1857.50-1902.50	14M1G7D	14M1G7D	14M1D7W	14M1D7W	14M1D7W
n2 (Channel Bandwidth 20MHz)	1860.00-1900.00	18M8G7D	19M0G7D	19M0G7D	19M0G7D	19M0G7D
n5 (Channel Bandwidth 5MHz)	826.50-846.50	4M48G7D	4M48G7D	4M48D7W	4M48D7W	4M48D7W
n5 (Channel Bandwidth 10MHz)	829.00-844.00	9M24G7D	9M30G7D	9M30D7W	9M30D7W	9M30D7W
n5 (Channel Bandwidth 15MHz)	831.50-841.50	14M0G7D	14M1G7D	14M1D7W	14M1D7W	14M1D7W
n5 (Channel Bandwidth 20MHz)	834.00-839.00	18M8G7D	18M9G7D	18M9D7W	18M9D7W	18M9D7W
n41 (Channel Bandwidth 20MHz)	2506.02-2679.99	18M1G7D	18M2G7D	18M2D7W	18M1D7W	18M1D7W
n41 (Channel Bandwidth 40MHz)	2516.01-2670.00	37M7G7D	38M0G7D	38M0D7W	38M0D7W	37M9D7W
n41 (Channel Bandwidth 50MHz)	2521.02-2664.99	47M3G7D	47M6G7D	47M6D7W	47M6D7W	47M5D7W
n41 (Channel Bandwidth 60MHz)	2526.00-2659.98	57M9G7D	58M0G7D	57M9D7W	57M9D7W	57M9D7W
n41 (Channel Bandwidth 80MHz)	2531.01-2655.00	77M2G7D	77M3G7D	77M3D7W	77M3D7W	77M2D7W
n41 (Channel Bandwidth 90MHz)	2541.00-2644.98	86M9G7D	87M6G7D	87M6D7W	87M6D7W	87M5D7W
n41 (Channel Bandwidth 100MHz)	2546.01-2640.00	96M9G7D	97M7G7D	97M7D7W	97M7D7W	97M6D7W
n71 (Channel Bandwidth 5MHz)	665.50-695.50	4M48G7D	4M47G7D	4M48D7W	4M48D7W	4M48D7W
n71 (Channel Bandwidth 10MHz)	668.00-693.00	9M22G7D	9M29G7D	9M29D7W	9M30D7W	9M29D7W
n71 (Channel Bandwidth 15MHz)	670.50-690.50	14M0G7D	14M1G7D	14M1D7W	14M1D7W	14M1D7W
n71 (Channel Bandwidth 20MHz)	673.00-688.00	18M7G7D	18M9G7D	18M9D7W	18M9D7W	18M9D7W
For Part 27Q						
n77 (Channel Bandwidth 20MHz)	3460.02-3540.00	18M1G7D	18M2G7D	18M2D7W	18M3D7W	18M2D7W
n77 (Channel Bandwidth 40MHz)	3470.01-3529.98	37M6G7D	37M8G7D	37M8D7W	37M9D7W	37M8D7W
n77 (Channel Bandwidth 50MHz)	3475.02-3525.00	47M1G7D	47M5G7D	47M5D7W	47M5D7W	47M5D7W
n78 (Channel Bandwidth 20MHz)	3460.20-3540.00	18M0G7D	18M2G7D	18M2D7W	18M3D7W	18M2D7W
n78 (Channel Bandwidth 30MHz)	3465.00-3534.99	27M8G7D	27M9G7D	27M9D7W	27M9D7W	27M9D7W
n78 (Channel Bandwidth 40MHz)	3470.10-3529.98	37M5G7D	37M8G7D	37M8D7W	37M8D7W	37M8D7W
n78 (Channel Bandwidth 50MHz)	3475.02-3525.00	47M1G7D	47M5G7D	47M5D7W	47M5D7W	47M5D7W
n78 (Channel Bandwidth 60MHz)	3480.00-3519.99	57M9G7D	57M9G7D	57M9D7W	57M9D7W	57M9D7W
For Part 27O						
n77 (Channel Bandwidth 20MHz)	3710.01-3969.99	18M0G7D	18M2G7D	18M2D7W	18M3D7W	18M2D7W
n77 (Channel Bandwidth 40MHz)	3720.00-3960.00	37M5G7D	37M8G7D	37M8D7W	37M8D7W	37M8D7W
n77 (Channel Bandwidth 50MHz)	3725.01-3954.99	47M0G7D	47M5G7D	47M5D7W	47M5D7W	47M5D7W

3. The EUT uses following accessories.

Battery		
Brand	Model	Specification
N/A	1400-900069G	Manufacturer : LIFUN TECHNOLOGY CO.,LTD. Power Rating : 3.85 Vdc 4950mAh
USB Cable		
Brand	Model	Specification
Trimble	121920	Signal Line : 2 meters, shielded cable. w/o ferrite core

4. The above EUT information is declared by manufacturer and for more detailed features description, please refers to the manufacturer's specifications or user's manual.

3.2 Antenna Description of EUT

1. The antenna information is listed as below.

Antenna Type		LDS		
Antenna Connector		shrapel		
Item	Antenna No.	Band		Gain (dBi)
5G NR	ANT0	TX+RX	Band 2	0.3
			Band 5	-2.2
			Band 41	0.04
			Band 71	-2.45
	ANT1	TX+RX	Band 77	-1.14
			Band 78	-1.14
	ANT4	RX	-	-
	ANT5	RX	-	-
ANT6	RX	-	-	

* Detail antenna specification please refer to antenna datasheet and/or antenna measurement report.

* 5G NR N2/N5/71 uses ANT0+ANT4+ANT5+ANT6

5G NR N41 uses ANT0+ANT4+ANT5+ANT6

5G NR N77/78 uses ANT1+ANT4+ANT5+ANT6

3.3 Test Mode Applicability and Tested Channel Detail

Pre-Scan:	EUT can be used in the following ways: X-axis/ Y-axis/ Z-axis. Pre-scan these ways and find the worst case as a representative test condition.
Worst Case:	X-axis/ Y-axis/ Z-axis Worst Condition: Y-axis

For NR n2

Test Item	Tested Channel	Channel Bandwidth	Modulation	Mode	
EIRP	370500 (1852.50 MHz) 376000 (1880.00 MHz) 381500 (1907.50 MHz)	5 MHz	BPSK / QPSK / 16QAM / 64QAM / 256QAM	1 RB Half RB Full RB	
	371000 (1855.00 MHz) 376000 (1880.00 MHz) 381000 (1905.00 MHz)	10 MHz	BPSK / QPSK / 16QAM / 64QAM / 256QAM	1 RB Half RB Full RB	
	371500 (1857.50 MHz) 376000 (1880.00 MHz) 380500 (1902.50 MHz)	15 MHz	BPSK / QPSK / 16QAM / 64QAM / 256QAM	1 RB Half RB Full RB	
	372000 (1860.00 MHz) 376000 (1880.00 MHz) 380000 (1900.00 MHz)	20 MHz	BPSK / QPSK / 16QAM / 64QAM / 256QAM	1 RB Half RB Full RB	
	Modulation Characteristics	376000 (1880.00 MHz)	20 MHz	BPSK / QPSK / 16QAM / 64QAM / 256QAM	Full RB
	Frequency Stability	370500 (1852.50 MHz) 381500 (1907.50 MHz)	5 MHz	QPSK	Full RB
		371000 (1855.00 MHz) 381000 (1905.00 MHz)	10 MHz	QPSK	Full RB
		371500 (1857.50 MHz) 380500 (1902.50 MHz)	15 MHz	QPSK	Full RB
372000 (1860.00 MHz) 380000 (1900.00 MHz)		20 MHz	QPSK	Full RB	
Occupied Bandwidth		370500 (1852.50 MHz) 376000 (1880.00 MHz) 381500 (1907.50 MHz)	5 MHz	BPSK / QPSK / 16QAM / 64QAM / 256QAM	Full RB
	371000 (1855.00 MHz) 376000 (1880.00 MHz) 381000 (1905.00 MHz)	10 MHz	BPSK / QPSK / 16QAM / 64QAM / 256QAM	Full RB	
	371500 (1857.50 MHz) 376000 (1880.00 MHz) 380500 (1902.50 MHz)	15 MHz	BPSK / QPSK / 16QAM / 64QAM / 256QAM	Full RB	
	372000 (1860.00 MHz) 376000 (1880.00 MHz) 380000 (1900.00 MHz)	20 MHz	BPSK / QPSK / 16QAM / 64QAM / 256QAM	Full RB	

Test Item	Tested Channel	Channel Bandwidth	Modulation	Mode
Peak to Average Ratio	370500 (1852.50 MHz) 376000 (1880.00 MHz) 381500 (1907.50 MHz)	5 MHz	BPSK / QPSK / 16QAM / 64QAM / 256QAM	1 RB
	371000 (1855.00 MHz) 376000 (1880.00 MHz) 381000 (1905.00 MHz)	10 MHz	BPSK / QPSK / 16QAM / 64QAM / 256QAM	1 RB
	371500 (1857.50 MHz) 376000 (1880.00 MHz) 380500 (1902.50 MHz)	15 MHz	BPSK / QPSK / 16QAM / 64QAM / 256QAM	1 RB
	372000 (1860.00 MHz) 376000 (1880.00 MHz) 380000 (1900.00 MHz)	20 MHz	BPSK / QPSK / 16QAM / 64QAM / 256QAM	1 RB
Conducted Emission	370500 (1852.50 MHz) 376000 (1880.00 MHz) 381500 (1907.50 MHz)	5 MHz	QPSK	1 RB Full RB
	371000 (1855.00 MHz) 376000 (1880.00 MHz) 381000 (1905.00 MHz)	10 MHz	QPSK	1 RB Full RB
	371500 (1857.50 MHz) 376000 (1880.00 MHz) 380500 (1902.50 MHz)	15 MHz	QPSK	1 RB Full RB
	372000 (1860.00 MHz) 376000 (1880.00 MHz) 380000 (1900.00 MHz)	20 MHz	QPSK	1 RB Full RB
RE Below 1GHz	381500 (1907.50 MHz)	5 MHz	QPSK	1 RB
RE Above 1GHz	370500 (1852.50 MHz) 376000 (1880.00 MHz) 381500 (1907.50 MHz)	5 MHz	QPSK	1 RB
	372000 (1860.00 MHz) 376000 (1880.00 MHz) 380000 (1900.00 MHz)	20 MHz	QPSK	1 RB

For NR n5

Test Item	Tested Channel	Channel Bandwidth	Modulation	Mode
ERP	165300 (826.50 MHz) 167300 (836.50 MHz) 169300 (846.50 MHz)	5 MHz	BPSK / QPSK / 16QAM / 64QAM / 256QAM	1 RB Half RB Full RB
	165800 (829.00 MHz) 167300 (836.50 MHz) 168800 (844.00 MHz)	10 MHz	BPSK / QPSK / 16QAM / 64QAM / 256QAM	1 RB Half RB Full RB
	166300 (831.50 MHz) 167300 (836.50 MHz) 168300 (841.50 MHz)	15 MHz	BPSK / QPSK / 16QAM / 64QAM / 256QAM	1 RB Half RB Full RB
	166800 (834.00 MHz) 167300 (836.50 MHz) 167800 (839.00 MHz)	20 MHz	BPSK / QPSK / 16QAM / 64QAM / 256QAM	1 RB Half RB Full RB
Modulation Characteristics	167300 (836.50 MHz)	20 MHz	BPSK / QPSK / 16QAM / 64QAM / 256QAM	Full RB
Frequency Stability	165300 (826.50 MHz) 169300 (846.50 MHz)	5 MHz	QPSK	Full RB
	165800 (829.00 MHz) 168800 (844.00 MHz)	10 MHz	QPSK	Full RB
	166300 (831.50 MHz) 168300 (841.50 MHz)	15 MHz	QPSK	Full RB
	166800 (834.00 MHz) 167800 (839.00 MHz)	20 MHz	QPSK	Full RB
Occupied Bandwidth	165300 (826.50 MHz) 167300 (836.50 MHz) 169300 (846.50 MHz)	5 MHz	BPSK / QPSK / 16QAM / 64QAM / 256QAM	Full RB
	165800 (829.00 MHz) 167300 (836.50 MHz) 168800 (844.00 MHz)	10 MHz	BPSK / QPSK / 16QAM / 64QAM / 256QAM	Full RB
	166300 (831.50 MHz) 167300 (836.50 MHz) 168300 (841.50 MHz)	15 MHz	BPSK / QPSK / 16QAM / 64QAM / 256QAM	Full RB
	166800 (834.00 MHz) 167300 (836.50 MHz) 167800 (839.00 MHz)	20 MHz	BPSK / QPSK / 16QAM / 64QAM / 256QAM	Full RB
Peak to Average Ratio	165300 (826.50 MHz) 167300 (836.50 MHz) 169300 (846.50 MHz)	5 MHz	BPSK / QPSK / 16QAM / 64QAM / 256QAM	1 RB
	165800 (829.00 MHz) 167300 (836.50 MHz) 168800 (844.00 MHz)	10 MHz	BPSK / QPSK / 16QAM / 64QAM / 256QAM	1 RB
	166300 (831.50 MHz) 167300 (836.50 MHz) 168300 (841.50 MHz)	15 MHz	BPSK / QPSK / 16QAM / 64QAM / 256QAM	1 RB
	166800 (834.00 MHz) 167300 (836.50 MHz) 167800 (839.00 MHz)	20 MHz	BPSK / QPSK / 16QAM / 64QAM / 256QAM	1 RB

Test Item	Tested Channel	Channel Bandwidth	Modulation	Mode
Conducted Emission	165300 (826.50 MHz) 167300 (836.50 MHz) 169300 (846.50 MHz)	5 MHz	QPSK	1 RB Full RB
	165800 (829.00 MHz) 167300 (836.50 MHz) 168800 (844.00 MHz)	10 MHz	QPSK	1 RB Full RB
	166300 (831.50 MHz) 167300 (836.50 MHz) 168300 (841.50 MHz)	15 MHz	QPSK	1 RB Full RB
	166800 (834.00 MHz) 167300 (836.50 MHz) 167800 (839.00 MHz)	20 MHz	QPSK	1 RB Full RB
RE Below 1GHz	167300 (836.50 MHz)	5 MHz	QPSK	1 RB
RE Above 1GHz	165300 (826.50 MHz) 167300 (836.50 MHz) 169300 (846.50 MHz)	5 MHz	QPSK	1 RB
	166800 (834.00 MHz) 167300 (836.50 MHz) 167800 (839.00 MHz)	20 MHz	QPSK	1 RB



For NR n41

Test Item	Tested Channel	Channel Bandwidth	Modulation	Mode
EIRP	501204 (2506.02 MHz) 518598 (2592.99 MHz) 535998 (2679.99 MHz)	20 MHz	BPSK / QPSK / 16QAM / 64QAM / 256QAM	1 RB Half RB Full RB
	503202 (2516.01 MHz) 518598 (2592.99 MHz) 534000 (2670.00 MHz)	40 MHz	BPSK / QPSK / 16QAM / 64QAM / 256QAM	1 RB Half RB Full RB
	504204 (2521.02 MHz) 518598 (2592.99 MHz) 532998 (2664.99 MHz)	50 MHz	BPSK / QPSK / 16QAM / 64QAM / 256QAM	1 RB Half RB Full RB
	505200 (2526.00 MHz) 518598 (2592.99 MHz) 531996 (2659.98 MHz)	60 MHz	BPSK / QPSK / 16QAM / 64QAM / 256QAM	1 RB Half RB Full RB
	507204 (2536.02 MHz) 518598 (2592.99 MHz) 529998 (2649.99 MHz)	80 MHz	BPSK / QPSK / 16QAM / 64QAM / 256QAM	1 RB Half RB Full RB
	508200 (2541.00 MHz) 518598 (2592.99 MHz) 528996 (2644.98 MHz)	90 MHz	BPSK / QPSK / 16QAM / 64QAM / 256QAM	1 RB Half RB Full RB
	509202 (2546.01 MHz) 518598 (2592.99 MHz) 528000 (2640.00 MHz)	100 MHz	BPSK / QPSK / 16QAM / 64QAM / 256QAM	1 RB Half RB Full RB
	Modulation Characteristics	518598 (2592.99 MHz)	100 MHz	BPSK / QPSK / 16QAM / 64QAM / 256QAM
Frequency Stability	501204 (2506.02 MHz) 535998 (2679.99 MHz)	20 MHz	QPSK	Full RB
	503202 (2516.01 MHz) 534000 (2670.00 MHz)	40 MHz	QPSK	Full RB
	504204 (2521.02 MHz) 532998 (2664.99 MHz)	50 MHz	QPSK	Full RB
	505200 (2526.00 MHz) 531996 (2659.98 MHz)	60 MHz	QPSK	Full RB
	507204 (2536.02 MHz) 529998 (2649.99 MHz)	80 MHz	QPSK	Full RB
	508200 (2541.00 MHz) 528996 (2644.98 MHz)	90 MHz	QPSK	Full RB
	509202 (2546.01 MHz) 528000 (2640.00 MHz)	100 MHz	QPSK	Full RB

Test Item	Tested Channel	Channel Bandwidth	Modulation	Mode
Occupied Bandwidth	501204 (2506.02 MHz) 518598 (2592.99 MHz) 535998 (2679.99 MHz)	20 MHz	BPSK / QPSK / 16QAM / 64QAM / 256QAM	Full RB
	503202 (2516.01 MHz) 518598 (2592.99 MHz) 534000 (2670.00 MHz)	40 MHz	BPSK / QPSK / 16QAM / 64QAM / 256QAM	Full RB
	504204 (2521.02 MHz) 518598 (2592.99 MHz) 532998 (2664.99 MHz)	50 MHz	BPSK / QPSK / 16QAM / 64QAM / 256QAM	Full RB
	505200 (2526.00 MHz) 518598 (2592.99 MHz) 531996 (2659.98 MHz)	60 MHz	BPSK / QPSK / 16QAM / 64QAM / 256QAM	Full RB
	507204 (2536.02 MHz) 518598 (2592.99 MHz) 529998 (2649.99 MHz)	80 MHz	BPSK / QPSK / 16QAM / 64QAM / 256QAM	Full RB
	508200 (2541.00 MHz) 518598 (2592.99 MHz) 528996 (2644.98 MHz)	90 MHz	BPSK / QPSK / 16QAM / 64QAM / 256QAM	Full RB
	509202 (2546.01 MHz) 518598 (2592.99 MHz) 528000 (2640.00 MHz)	100 MHz	BPSK / QPSK / 16QAM / 64QAM / 256QAM	Full RB
	Peak to Average Ratio	501204 (2506.02 MHz) 518598 (2592.99 MHz) 535998 (2679.99 MHz)	20 MHz	BPSK / QPSK / 16QAM / 64QAM / 256QAM
503202 (2516.01 MHz) 518598 (2592.99 MHz) 534000 (2670.00 MHz)		40 MHz	BPSK / QPSK / 16QAM / 64QAM / 256QAM	1 RB
504204 (2521.02 MHz) 518598 (2592.99 MHz) 532998 (2664.99 MHz)		50 MHz	BPSK / QPSK / 16QAM / 64QAM / 256QAM	1 RB
505200 (2526.00 MHz) 518598 (2592.99 MHz) 531996 (2659.98 MHz)		60 MHz	BPSK / QPSK / 16QAM / 64QAM / 256QAM	1 RB
507204 (2536.02 MHz) 518598 (2592.99 MHz) 529998 (2649.99 MHz)		80 MHz	BPSK / QPSK / 16QAM / 64QAM / 256QAM	1 RB
508200 (2541.00 MHz) 518598 (2592.99 MHz) 528996 (2644.98 MHz)		90 MHz	BPSK / QPSK / 16QAM / 64QAM / 256QAM	1 RB
509202 (2546.01 MHz) 518598 (2592.99 MHz) 528000 (2640.00 MHz)		100 MHz	BPSK / QPSK / 16QAM / 64QAM / 256QAM	1 RB

Test Item	Tested Channel	Channel Bandwidth	Modulation	Mode
Conducted Emission	501204 (2506.02 MHz) 518598 (2592.99 MHz) 535998 (2679.99 MHz)	20 MHz	QPSK	1 RB Full RB
	503202 (2516.01 MHz) 518598 (2592.99 MHz) 534000 (2670.00 MHz)	40 MHz	QPSK	1 RB Full RB
	504204 (2521.02 MHz) 518598 (2592.99 MHz) 532998 (2664.99 MHz)	50 MHz	QPSK	1 RB Full RB
	505200 (2526.00 MHz) 518598 (2592.99 MHz) 531996 (2659.98 MHz)	60 MHz	QPSK	1 RB Full RB
	507204 (2536.02 MHz) 518598 (2592.99 MHz) 529998 (2649.99 MHz)	80 MHz	QPSK	1 RB Full RB
	508200 (2541.00 MHz) 518598 (2592.99 MHz) 528996 (2644.98 MHz)	90 MHz	QPSK	1 RB Full RB
	509202 (2546.01 MHz) 518598 (2592.99 MHz) 528000 (2640.00 MHz)	100 MHz	QPSK	1 RB Full RB
	RE Below 1GHz	518598 (2592.99 MHz)	50 MHz	QPSK
RE Above 1GHz	501204 (2506.02 MHz) 518598 (2592.99 MHz) 535998 (2679.99 MHz)	20 MHz	QPSK	1 RB
	504204 (2521.02 MHz) 518598 (2592.99 MHz) 532998 (2664.99 MHz)	50 MHz	QPSK	1 RB
	509202 (2546.01 MHz) 518598 (2592.99 MHz) 528000 (2640.00 MHz)	100 MHz	QPSK	1 RB

For NR n71

Test Item	Tested Channel	Channel Bandwidth	Modulation	Mode
ERP	133147 (665.50 MHz) 133297 (680.50 MHz) 133447 (695.50 MHz)	5 MHz	BPSK / QPSK / 16QAM / 64QAM / 256QAM	1 RB Half RB Full RB
	133172 (668.00 MHz) 133297 (680.50 MHz) 133422 (693.00 MHz)	10 MHz	BPSK / QPSK / 16QAM / 64QAM / 256QAM	1 RB Half RB Full RB
	133197 (670.50 MHz) 133297 (680.50 MHz) 133397 (690.50 MHz)	15 MHz	BPSK / QPSK / 16QAM / 64QAM / 256QAM	1 RB Half RB Full RB
	133222 (673.00 MHz) 133297 (680.50 MHz) 133372 (688.00 MHz)	20 MHz	BPSK / QPSK / 16QAM / 64QAM / 256QAM	1 RB Half RB Full RB
Modulation Characteristics	133297 (680.50 MHz)	20 MHz	BPSK / QPSK / 16QAM / 64QAM / 256QAM	Full RB
Frequency Stability	133147 (665.50 MHz) 133447 (695.50 MHz)	5 MHz	QPSK	Full RB
	133172 (668.00 MHz) 133422 (693.00 MHz)	10 MHz	QPSK	Full RB
	133197 (670.50 MHz) 133397 (690.50 MHz)	15 MHz	QPSK	Full RB
	133222 (673.00 MHz) 133372 (688.00 MHz)	20 MHz	QPSK	Full RB
Occupied Bandwidth	133147 (665.50 MHz) 133297 (680.50 MHz) 133447 (695.50 MHz)	5 MHz	BPSK / QPSK / 16QAM / 64QAM / 256QAM	Full RB
	133172 (668.00 MHz) 133297 (680.50 MHz) 133422 (693.00 MHz)	10 MHz	BPSK / QPSK / 16QAM / 64QAM / 256QAM	Full RB
	133197 (670.50 MHz) 133297 (680.50 MHz) 133397 (690.50 MHz)	15 MHz	BPSK / QPSK / 16QAM / 64QAM / 256QAM	Full RB
	133222 (673.00 MHz) 133297 (680.50 MHz) 133372 (688.00 MHz)	20 MHz	BPSK / QPSK / 16QAM / 64QAM / 256QAM	Full RB
Peak to Average Ratio	133147 (665.50 MHz) 133297 (680.50 MHz) 133447 (695.50 MHz)	5 MHz	BPSK / QPSK / 16QAM / 64QAM / 256QAM	1 RB
	133172 (668.00 MHz) 133297 (680.50 MHz) 133422 (693.00 MHz)	10 MHz	BPSK / QPSK / 16QAM / 64QAM / 256QAM	1 RB
	133197 (670.50 MHz) 133297 (680.50 MHz) 133397 (690.50 MHz)	15 MHz	BPSK / QPSK / 16QAM / 64QAM / 256QAM	1 RB
	133222 (673.00 MHz) 133297 (680.50 MHz) 133372 (688.00 MHz)	20 MHz	BPSK / QPSK / 16QAM / 64QAM / 256QAM	1 RB

Test Item	Tested Channel	Channel Bandwidth	Modulation	Mode
Conducted Emission	133147 (665.50 MHz) 133297 (680.50 MHz) 133447 (695.50 MHz)	5 MHz	BPSK / QPSK / 16QAM / 64QAM / 256QAM	1 RB Full RB
	133172 (668.00 MHz) 133297 (680.50 MHz) 133422 (693.00 MHz)	10 MHz	BPSK / QPSK / 16QAM / 64QAM / 256QAM	1 RB Full RB
	133197 (670.50 MHz) 133297 (680.50 MHz) 133397 (690.50 MHz)	15 MHz	BPSK / QPSK / 16QAM / 64QAM / 256QAM	1 RB Full RB
	133222 (673.00 MHz) 133297 (680.50 MHz) 133372 (688.00 MHz)	20 MHz	BPSK / QPSK / 16QAM / 64QAM / 256QAM	1 RB Full RB
RE Below 1GHz	133147 (665.50 MHz)	5 MHz	QPSK	1 RB
RE Above 1GHz	133147 (665.50 MHz) 133297 (680.50 MHz) 133447 (695.50 MHz)	5 MHz	QPSK	1 RB
	133222 (673.00 MHz) 133297 (680.50 MHz) 133372 (688.00 MHz)	20 MHz	QPSK	1 RB

For NR n77 (3450-3550 MHz)

Test Item	Tested Channel	Channel Bandwidth	Modulation	Mode	
EIRP	630668 (3460.02 MHz) 633334 (3500.01 MHz) 636000 (3540.00 MHz)	20 MHz	BPSK / QPSK / 16QAM / 64QAM / 256QAM	1 RB Half RB Full RB	
	631334 (3470.01 MHz) 633334 (3500.01 MHz) 635332 (3529.98 MHz)	40 MHz	BPSK / QPSK / 16QAM / 64QAM / 256QAM	1 RB Half RB Full RB	
	631668 (3475.02 MHz) 633334 (3500.01 MHz) 635000 (3525.00 MHz)	50 MHz	BPSK / QPSK / 16QAM / 64QAM / 256QAM	1 RB Half RB Full RB	
	Modulation Characteristics	633334 (3500.01 MHz)	50 MHz	BPSK / QPSK / 16QAM / 64QAM / 256QAM	Full RB
	Frequency Stability	630668 (3460.02 MHz) 636000 (3540.00 MHz)	20 MHz	QPSK	Full RB
		631334 (3470.01 MHz) 635332 (3529.98 MHz)	40 MHz	QPSK	Full RB
631668 (3475.02 MHz) 635000 (3525.00 MHz)		50 MHz	QPSK	Full RB	
Occupied Bandwidth	630668 (3460.02 MHz) 633334 (3500.01 MHz) 636000 (3540.00 MHz)	20 MHz	BPSK / QPSK / 16QAM / 64QAM / 256QAM	Full RB	
	631334 (3470.01 MHz) 633334 (3500.01 MHz) 635332 (3529.98 MHz)	40 MHz	BPSK / QPSK / 16QAM / 64QAM / 256QAM	Full RB	
	631668 (3475.02 MHz) 633334 (3500.01 MHz) 635000 (3525.00 MHz)	50 MHz	BPSK / QPSK / 16QAM / 64QAM / 256QAM	Full RB	
Peak to Average Ratio	630668 (3460.02 MHz) 633334 (3500.01 MHz) 636000 (3540.00 MHz)	20 MHz	BPSK / QPSK / 16QAM / 64QAM / 256QAM	1 RB	
	631334 (3470.01 MHz) 633334 (3500.01 MHz) 635332 (3529.98 MHz)	40 MHz	BPSK / QPSK / 16QAM / 64QAM / 256QAM	1 RB	
	631668 (3475.02 MHz) 633334 (3500.01 MHz) 635000 (3525.00 MHz)	50 MHz	BPSK / QPSK / 16QAM / 64QAM / 256QAM	1 RB	
Conducted Emission	630668 (3460.02 MHz) 633334 (3500.01 MHz) 636000 (3540.00 MHz)	20 MHz	QPSK	1 RB Full RB	
	631334 (3470.01 MHz) 633334 (3500.01 MHz) 635332 (3529.98 MHz)	40 MHz	QPSK	1 RB Full RB	
	631668 (3475.02 MHz) 633334 (3500.01 MHz) 635000 (3525.00 MHz)	50 MHz	QPSK	1 RB Full RB	
RE Below 1GHz	635000 (3525.00 MHz)	50 MHz	QPSK	1 RB	
RE Above 1GHz	630668 (3460.02 MHz) 633334 (3500.01 MHz) 636000 (3540.00 MHz)	20 MHz	QPSK	1 RB	
	631668 (3475.02 MHz) 633334 (3500.01 MHz) 635000 (3525.00 MHz)	50 MHz	QPSK	1 RB	



For NR n77 (3700-3980 MHz)

Test Item	Tested Channel	Channel Bandwidth	Modulation	Mode
EIRP	647334 (3710.01 MHz) 656000 (3840.00 MHz) 664666 (3969.99 MHz)	20 MHz	BPSK / QPSK / 16QAM / 64QAM / 256QAM	1 RB Half RB Full RB
	648000 (3720.00 MHz) 656000 (3840.00 MHz) 664000 (3960.00 MHz)	40 MHz	BPSK / QPSK / 16QAM / 64QAM / 256QAM	1 RB Half RB Full RB
	648334 (3725.01 MHz) 656000 (3840.00 MHz) 663666 (3954.99 MHz)	50 MHz	BPSK / QPSK / 16QAM / 64QAM / 256QAM	1 RB Half RB Full RB
Modulation Characteristics	656000 (3840.00 MHz)	50 MHz	BPSK / QPSK / 16QAM / 64QAM / 256QAM	Full RB
Frequency Stability	647334 (3710.01 MHz) 664666 (3969.99 MHz)	20 MHz	QPSK	Full RB
	648000 (3720.00 MHz) 664000 (3960.00 MHz)	40 MHz	QPSK	Full RB
	648334 (3725.01 MHz) 663666 (3954.99 MHz)	50 MHz	QPSK	Full RB
Occupied Bandwidth	647334 (3710.01 MHz) 656000 (3840.00 MHz) 664666 (3969.99 MHz)	20 MHz	BPSK / QPSK / 16QAM / 64QAM / 256QAM	Full RB
	648000 (3720.00 MHz) 656000 (3840.00 MHz) 664000 (3960.00 MHz)	40 MHz	BPSK / QPSK / 16QAM / 64QAM / 256QAM	Full RB
	648334 (3725.01 MHz) 656000 (3840.00 MHz) 663666 (3954.99 MHz)	50 MHz	BPSK / QPSK / 16QAM / 64QAM / 256QAM	Full RB
Peak to Average Ratio	647334 (3710.01 MHz) 656000 (3840.00 MHz) 664666 (3969.99 MHz)	20 MHz	BPSK / QPSK / 16QAM / 64QAM / 256QAM	1 RB
	648000 (3720.00 MHz) 656000 (3840.00 MHz) 664000 (3960.00 MHz)	40 MHz	BPSK / QPSK / 16QAM / 64QAM / 256QAM	1 RB
	648334 (3725.01 MHz) 656000 (3840.00 MHz) 663666 (3954.99 MHz)	50 MHz	BPSK / QPSK / 16QAM / 64QAM / 256QAM	1 RB
Conducted Emission	647334 (3710.01 MHz) 656000 (3840.00 MHz) 664666 (3969.99 MHz)	20 MHz	QPSK	1 RB Full RB
	648000 (3720.00 MHz) 656000 (3840.00 MHz) 664000 (3960.00 MHz)	40 MHz	QPSK	1 RB Full RB
	648334 (3725.01 MHz) 656000 (3840.00 MHz) 663666 (3954.99 MHz)	50 MHz	QPSK	1 RB Full RB
RE Below 1GHz	656000 (3840.00 MHz)	20 MHz	QPSK	1 RB
RE Above 1GHz	647334 (3710.01 MHz) 656000 (3840.00 MHz) 664666 (3969.99 MHz)	20 MHz	QPSK	1 RB
	648334 (3725.01 MHz) 656000 (3840.00 MHz) 663666 (3954.99 MHz)	50 MHz	QPSK	1 RB

For NR n78

Test Item	Tested Channel	Channel Bandwidth	Modulation	Mode
EIRP	630668 (3460.02 MHz) 633334 (3500.01 MHz) 636000 (3540.00 MHz)	20 MHz	BPSK / QPSK / 16QAM / 64QAM / 256QAM	1 RB Half RB Full RB
	631000 (3465.00 MHz) 633334 (3500.01 MHz) 635666 (3534.99 MHz)	30 MHz	BPSK / QPSK / 16QAM / 64QAM / 256QAM	1 RB Half RB Full RB
	631334 (3470.01 MHz) 633334 (3500.01 MHz) 635332 (3529.98 MHz)	40 MHz	BPSK / QPSK / 16QAM / 64QAM / 256QAM	1 RB Half RB Full RB
	631668 (3475.02 MHz) 633334 (3500.01 MHz) 635000 (3525.00 MHz)	50 MHz	BPSK / QPSK / 16QAM / 64QAM / 256QAM	1 RB Half RB Full RB
	632000 (3480.00 MHz) 633334 (3500.01 MHz) 634666 (3519.99 MHz)	60 MHz	BPSK / QPSK / 16QAM / 64QAM / 256QAM	1 RB Half RB Full RB
Modulation Characteristics	633334 (3500.01 MHz)	60 MHz	BPSK / QPSK / 16QAM / 64QAM / 256QAM	Full RB
Frequency Stability	630668 (3460.02 MHz) 636000 (3540.00 MHz)	20 MHz	QPSK	Full RB
	631000 (3465.00 MHz) 635666 (3534.99 MHz)	30 MHz	QPSK	Full RB
	631334 (3470.01 MHz) 635332 (3529.98 MHz)	40 MHz	QPSK	Full RB
	631668 (3475.02 MHz) 635000 (3525.00 MHz)	50 MHz	QPSK	Full RB
	632000 (3480.00 MHz) 634666 (3519.99 MHz)	60 MHz	QPSK	Full RB
Occupied Bandwidth	630668 (3460.02 MHz) 633334 (3500.01 MHz) 636000 (3540.00 MHz)	20 MHz	BPSK / QPSK / 16QAM / 64QAM / 256QAM	1 RB Half RB Full RB
	631000 (3465.00 MHz) 633334 (3500.01 MHz) 635666 (3534.99 MHz)	30 MHz	BPSK / QPSK / 16QAM / 64QAM / 256QAM	1 RB Half RB Full RB
	631334 (3470.01 MHz) 633334 (3500.01 MHz) 635332 (3529.98 MHz)	40 MHz	BPSK / QPSK / 16QAM / 64QAM / 256QAM	1 RB Half RB Full RB
	631668 (3475.02 MHz) 633334 (3500.01 MHz) 635000 (3525.00 MHz)	50 MHz	BPSK / QPSK / 16QAM / 64QAM / 256QAM	1 RB Half RB Full RB
	632000 (3480.00 MHz) 633334 (3500.01 MHz) 634666 (3519.99 MHz)	60 MHz	BPSK / QPSK / 16QAM / 64QAM / 256QAM	1 RB Half RB Full RB

Test Item	Tested Channel	Channel Bandwidth	Modulation	Mode	
Peak to Average Ratio	630668 (3460.02 MHz) 633334 (3500.01 MHz) 636000 (3540.00 MHz)	20 MHz	BPSK / QPSK / 16QAM / 64QAM / 256QAM	1 RB	
	631000 (3465.00 MHz) 633334 (3500.01 MHz) 635666 (3534.99 MHz)	30 MHz	BPSK / QPSK / 16QAM / 64QAM / 256QAM	1 RB	
	631334 (3470.01 MHz) 633334 (3500.01 MHz) 635332 (3529.98 MHz)	40 MHz	BPSK / QPSK / 16QAM / 64QAM / 256QAM	1 RB	
	631668 (3475.02 MHz) 633334 (3500.01 MHz) 635000 (3525.00 MHz)	50 MHz	BPSK / QPSK / 16QAM / 64QAM / 256QAM	1 RB	
	632000 (3480.00 MHz) 633334 (3500.01 MHz) 634666 (3519.99 MHz)	60 MHz	BPSK / QPSK / 16QAM / 64QAM / 256QAM	1 RB	
	Conducted Emission	630668 (3460.02 MHz) 633334 (3500.01 MHz) 636000 (3540.00 MHz)	20 MHz	QPSK	1 RB Full RB
		631000 (3465.00 MHz) 633334 (3500.01 MHz) 635666 (3534.99 MHz)	30 MHz	QPSK	1 RB Full RB
		631334 (3470.01 MHz) 633334 (3500.01 MHz) 635332 (3529.98 MHz)	40 MHz	QPSK	1 RB Full RB
		631668 (3475.02 MHz) 633334 (3500.01 MHz) 635000 (3525.00 MHz)	50 MHz	QPSK	1 RB Full RB
		632000 (3480.00 MHz) 633334 (3500.01 MHz) 634666 (3519.99 MHz)	60 MHz	QPSK	1 RB Full RB
RE Below 1GHz	632000 (3480.00 MHz)	60 MHz	QPSK	1 RB	
RE Above 1GHz	630668 (3460.02 MHz) 633334 (3500.01 MHz) 636000 (3540.00 MHz)	20 MHz	QPSK	1 RB	
	631668 (3475.02 MHz) 633334 (3500.01 MHz) 635000 (3525.00 MHz)	50 MHz	QPSK	1 RB	
	632000 (3480.00 MHz) 633334 (3500.01 MHz) 634666 (3519.99 MHz)	60 MHz	QPSK	1 RB	

3.4 Test Program Used and Operation Descriptions

There is no need to controlling software during the test, and the EUT can be paired with the 5G Wireless Test Platforms to test the connection when it is powered on.

3.5 Connection Diagram of EUT and Peripheral Devices

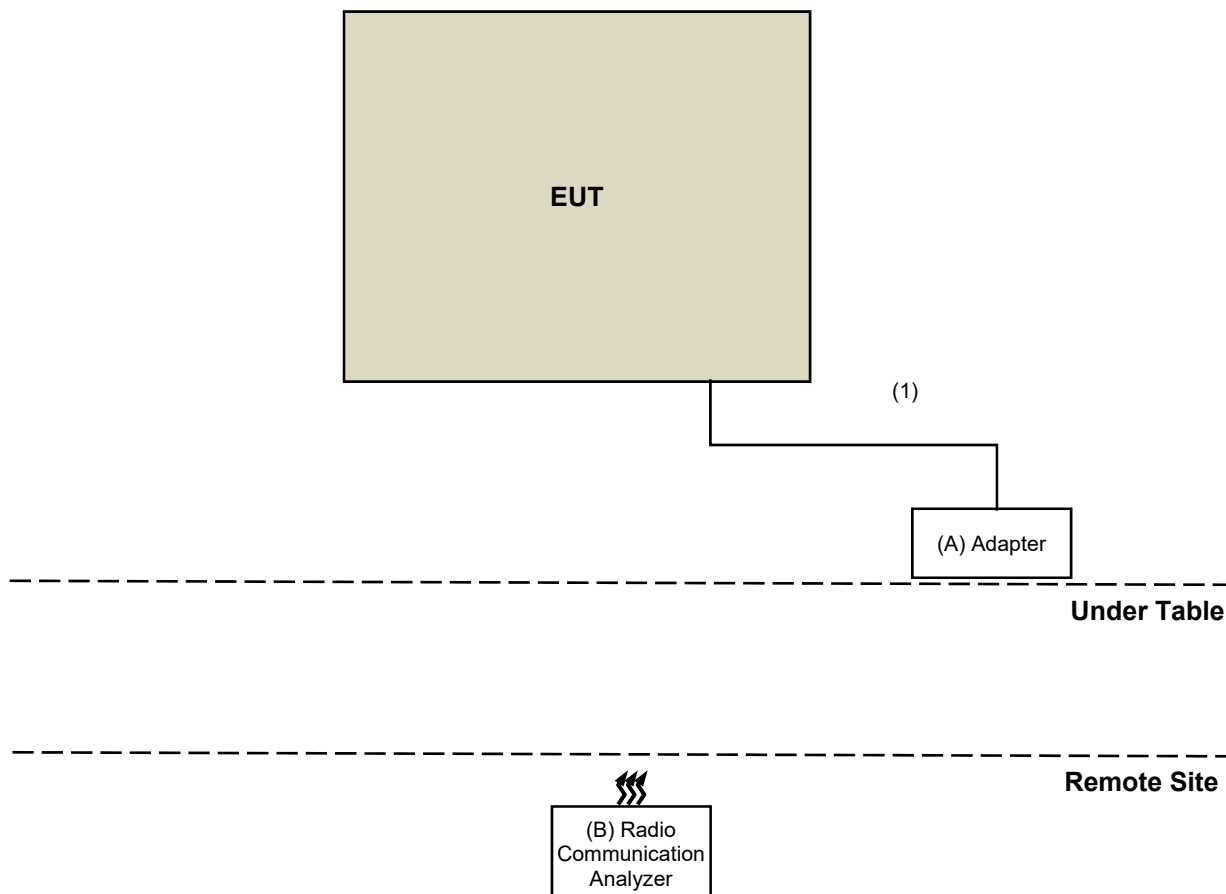

3.6 Configuration of Peripheral Devices and Cable Connections

ID	Product	Brand	Model No.	Serial No.	FCC ID	Remarks
A	Adapter	FULLPOWER	TYPE-C451C	N/A	N/A	Supplied by applicant
B	Radio Communication Analyzer	Anritsu	MT8821C	6201462755	N/A	Provided by Lab

ID	Cable Descriptions	Qty.	Length (m)	Shielding (Yes/No)	Cores (Qty.)	Remarks
1	Type-C Cable	1	2	Yes	0	Supplied by applicant

4 Test Instruments

The calibration interval of the all test instruments are 12 months and the calibrations are traceable to NML/ROC and NIST/USA.

4.1 Effective Radiated Power and Equivalent Isotropically Radiated Power

Description Manufacturer	Model No.	Serial No.	Calibrated Date	Calibrated Until
N9030B - PXA Signal Analyzer KEYSIGHT	N9030B	MY57140488	2023/3/6	2024/3/5
Radio Communication Analyzer Anritsu	MT8821C	6201462755	2023/3/3	2024/3/2
Software BV	ADT_RF Test Software V6.6.5.4	N/A	N/A	N/A

Notes:

1. The test was performed in Oven room.
2. Tested Date: 2023/10/3

4.2 Modulation Characteristics

Description Manufacturer	Model No.	Serial No.	Calibrated Date	Calibrated Until
N9030B - PXA Signal Analyzer KEYSIGHT	N9030B	MY57140938	2023/3/16	2024/3/15
Radio Communication Analyzer Anritsu	MT8821C	6201462755	2023/3/3	2024/3/2
Software BV	ADT_RF Test Software V6.6.5.4	N/A	N/A	N/A

Notes:

1. The test was performed in Oven room.
2. Tested Date: 2023/4/27-5/8

4.3 Peak to Average Ratio

Refer to section 4.2 to get information of the instruments.

4.4 Bandwidth

Refer to section 4.2 to get information of the instruments.

4.5 Conducted Spurious Emissions

Refer to section 4.2 to get information of the instruments.

4.6 Radiated Spurious Emissions below 1GHz

Description Manufacturer	Model No.	Serial No.	Calibrated Date	Calibrated Until
Antenna Tower Max-Full	MFT-151SS-0.5T	N/A	N/A	N/A
Bi_Log Antenna Schwarzbeck	VULB 9168	9168-1213	2022/10/20	2023/10/19
EMI Test Receiver R&S	ESR3	102782	2022/12/12	2023/12/11
Loop Antenna Electro-Metrics	EM-6879	269	2022/9/19	2023/9/18
Loop Antenna TESEQ	HLA 6121	45745	2022/7/27	2023/7/26
Preamplifier EMCI	EMC330N	980782	2023/1/16	2024/1/15
	EMC001340	980201	2022/9/23	2023/9/22
RF Coaxial Cable EMCI	5D-NM-BM	140903+140902	2023/1/7	2024/1/6
	EMCCFD400-NM-NM- 500	201233	2023/1/16	2024/1/15
	EMCCFD400-NM-NM- 3000	201235	2023/1/16	2024/1/15
	EMCCFD400-NM-NM- 9000	201236(with PAD)	2023/1/16	2024/1/15
Signal & Spectrum Analyzer R&S	FSW43	101866	2023/1/10	2024/1/9
Software BV ADT	ADT_Radiated_ V7.6.15.9.5	N/A	N/A	N/A
Turn Table Max-Full	MF-7802BS	N/A	N/A	N/A
Turn Table Controller Max-Full	MF-7802BS	MF780208674	N/A	N/A

Notes:

1. The test was performed in WM - 966 chamber 8.
2. Tested Date: 2023/7/5

4.7 Radiated Spurious Emissions above 1GHz

Description Manufacturer	Model No.	Serial No.	Calibrated Date	Calibrated Until
Antenna Tower Max-Full	MFT-151SS-0.5T	N/A	N/A	N/A
Horn Antenna RFSPIN	DRH18-E	210103A18E	2022/11/13	2023/11/12
Horn Antenna Schwarzbeck	BBHA 9170	9170-1049	2022/11/13	2023/11/12
Pre_Amplifier EMCI	EMC118A45SE	980808	2022/12/29	2023/12/28
	EMC184045SE	980788	2023/1/16	2024/1/15
RF Coaxial Cable EMCI	EMC101G-KM-KM-2000	201254	2023/1/16	2024/1/15
	EMC101G-KM-KM-3000	201257	2023/1/16	2024/1/15
	EMC101G-KM-KM-5000	201260	2023/1/16	2024/1/15
	EMC104-SM-SM-1000	210102	2023/1/16	2024/1/15
	EMC104-SM-SM-3000	201231	2023/1/16	2024/1/15
	EMC104-SM-SM-9000	201243	2023/1/16	2024/1/15
Software BV ADT	ADT_Radiated_ V7.6.15.9.5	N/A	N/A	N/A
Spectrum Analyzer R&S	FSW43	101866	2023/1/10	2024/1/9
Test Receiver R&S	ESR3+	102782	2022/12/12	2023/12/11
Turn Table Max-Full	MF-7802BS	N/A	N/A	N/A
Turn Table Controller Max-Full	MF-7802BS	MF780208674	N/A	N/A
5G Wireless Test Platforms Keysight	E7515B	MY60102114	2023/5/18	2024/5/17

Notes:

1. The test was performed in WM - 966 chamber 8.
2. Tested Date: 2023/7/4 ~ 2023/9/21

4.8 Frequency Stability

Description Manufacturer	Model No.	Serial No.	Calibrated Date	Calibrated Until
3-channel DC power supply JIN YIH Technology	ODP3033	ODP30332128138	N/A	N/A
Digital Multimeter Fluke	87-III	70360742	2023/7/6	2024/7/5
Software BV	ADT_RF Test Software V6.6.5.4	N/A	N/A	N/A
Spectrum Analyzer R&S	FSV40	100980	2023/5/3	2024/5/2
Temperature & Humidity Chamber TERCHY	HRM-120RF	931022	2022/12/27	2023/12/26
5G Wireless Test Platforms Keysight	E7515B	MY60102114	2023/5/18	2024/5/17

Notes:

1. The test was performed in Oven room.
2. Tested Date: 2023/10/3

5 Limits of Test Items

5.1 Effective Radiated Power and Equivalent Isotropically Radiated Power

For NR n2:

Mobile and portable stations are limited to 2 watts EIRP.

For NR n5:

The ERP of mobile transmitters and auxiliary test transmitters must not exceed 7 watts.

For NR n41:

Mobile stations are limited to 2.0 watts EIRP. All user stations are limited to 2.0 watts transmitter output power.

For NR n71:

Portable stations (hand-held devices) in the 600 MHz uplink band and the 698-746 MHz band, and fixed and mobile stations in the 600 MHz uplink band are limited to 3 watts ERP.

For NR n77 (3450-3550 MHz), NR n78:

Mobile devices are limited to 1Watt (30 dBm) EIRP.

For NR n77 (3700-3980 MHz):

Mobile and portable stations are limited to 1 Watt EIRP.

5.2 Modulation Characteristics

A curve or equivalent data which shows that the equipment will meet the modulation requirements of the rules under which the equipment is to be licensed.

5.3 Peak to Average Ratio

In measuring transmissions in this band using an average power technique, the peak to-average ratio (PAR) of the transmission may not exceed 13 dB.

5.4 Bandwidth

According to FCC 47 CFR part 2.1049, the occupied bandwidth, that is the frequency bandwidth such that, below its lower and above its upper frequency limits, the mean powers radiated are each equal to 0.5% of the total mean power radiated by a given emission.

5.5 Conducted Spurious Emissions

For NR n2, NR n5:

The power of any emission outside of the authorized operating frequency ranges must be attenuated below the transmitting power (P) by a factor of at least $43 + 10 \log(P)$ dB. The emission limit equal to -13 dBm.

For NR n41:

According to FCC 47 CFR part 27.53(m)(4) regulations, any transmit power outside of the channel edge must be attenuated below the transmitting power (P) by a factor shall be not less than $40 + 10 \log(P)$ dB on all frequencies between the channel edge and 5 megahertz from the channel edge, $43 + 10 \log(P)$ dB on all frequencies between 5 megahertz and X megahertz from the channel edge, and $55 + 10 \log(P)$ dB on all frequencies more than X megahertz from the channel edge, where X is the greater of 6 megahertz or the actual emission bandwidth. In addition, the attenuation factor shall not be less than $43 + 10 \log(P)$ dB on all frequencies between 2490.5 MHz and 2496 MHz and $55 + 10 \log(P)$ dB at or below 2490.5 MHz. In the 1 MHz bands immediately outside and adjacent to the frequency block a resolution bandwidth of at least two percent may be employed, except when the 1 megahertz band is 2495-2496 MHz, in which case a resolution bandwidth of at least one percent may be employed.

For NR n71:

According to FCC 47 CFR part 27.53(g), for operations in the 600 MHz band and the 698-746 MHz band, the power of any emission outside a licensee's frequency band(s) of operation shall be attenuated below the transmitter power (P) within the licensed band(s) of operation, measured in watts, by at least $43 + 10 \log(P)$ dB. Compliance with this provision is based on the use of measurement instrumentation employing a resolution bandwidth of 100 kilohertz or greater. However, in the 100 kilohertz bands immediately outside and adjacent to a licensee's frequency block, a resolution bandwidth of at least 30 kHz may be employed.

For NR n77 (3450-3550 MHz), NR n78:

According to FCC 47 CFR part 27.53(n), for operations in the 3450-3550 MHz band, the conducted power of any emission outside the licensee's authorized bandwidth shall not exceed -13 dBm/MHz. Compliance with this paragraph (n)(2) is based on the use of measurement instrumentation employing a resolution bandwidth of 1 megahertz or greater. However, in the 1 megahertz bands immediately outside and adjacent to the licensee's frequency block, a resolution bandwidth of at least one percent of the emission bandwidth of the fundamental emission of the transmitter may be employed, but limited to a maximum of 200 kHz. In the bands between 1 and 5 MHz removed from the licensee's frequency block, the minimum resolution bandwidth for the measurement shall be 500 kHz.

For NR n77 (3700-3980 MHz):

According to FCC 47 CFR part 27.53(l), for mobile operations in the 3700-3980 MHz band, the conducted power of any emission outside the licensee's authorized bandwidth shall not exceed -13 dBm/MHz. Compliance with this paragraph (l)(2) is based on the use of measurement instrumentation employing a resolution bandwidth of 1 megahertz or greater. However, in the 1 megahertz bands immediately outside and adjacent to the licensee's frequency block, the minimum resolution bandwidth for the measurement shall be either one percent of the emission bandwidth of the fundamental emission of the transmitter or 350 kHz. In the bands between 1 and 5 MHz removed from the licensee's frequency block, the minimum resolution bandwidth for the measurement shall be 500 kHz.

5.6 Radiated Spurious Emissions below 1GHz

For NR n2, NR n5:

The power of any emission outside of the authorized operating frequency ranges must be attenuated below the transmitting power (P) by a factor of at least $43 + 10 \log(P)$ dB. The emission limit equal to -13 dBm.

For NR n41:

According to FCC 47 CFR part 27.53(m)(4), on any frequency outside a licensee's frequency block, The power of any emission shall be attenuated below the transmitter power (P) by at least $55 + 10 \log(P)$ dB. The emission limit equal to -25 dBm.

For NR n71:

According to FCC 47 CFR part 27.53(g), for operations in the 600 MHz band and the 698-746 MHz band, the power of any emission outside a licensee's frequency band(s) of operation shall be attenuated below the transmitter power (P) within the licensed band(s) of operation, measured in watts, by at least $43 + 10 \log(P)$ dB. The limit of emissions is equal to -13 dBm.

For NR n77 (3450-3550 MHz), NR n78:

According to FCC 47 CFR part 27.53(n), for operations in the 3450-3550 MHz band, the conducted power of any emission outside the licensee's authorized bandwidth shall not exceed -13 dBm/MHz.

For NR n77 (3700-3980 MHz):

According to FCC 47 CFR part 27.53(l), for mobile operations in the 3700-3980 MHz band, the conducted power of any emission outside the licensee's authorized bandwidth shall not exceed -13 dBm/MHz.

5.7 Radiated Spurious Emissions above 1GHz

For NR n2, NR n5:

The power of any emission outside of the authorized operating frequency ranges must be attenuated below the transmitting power (P) by a factor of at least $43 + 10 \log(P)$ dB. The emission limit equal to -13 dBm.

For NR n41:

According to FCC 47 CFR part 27.53(m)(4), on any frequency outside a licensee's frequency block, The power of any emission shall be attenuated below the transmitter power (P) by at least $55 + 10 \log(P)$ dB. The emission limit equal to -25 dBm.

For NR n71:

According to FCC 47 CFR part 27.53(g), for operations in the 600 MHz band and the 698-746 MHz band, the power of any emission outside a licensee's frequency band(s) of operation shall be attenuated below the transmitter power (P) within the licensed band(s) of operation, measured in watts, by at least $43 + 10 \log(P)$ dB. The limit of emissions is equal to -13 dBm.

For NR n77 (3450-3550 MHz), NR n78:

According to FCC 47 CFR part 27.53(n), for operations in the 3450-3550 MHz band, the conducted power of any emission outside the licensee's authorized bandwidth shall not exceed -13 dBm/MHz.

For NR n77 (3700-3980 MHz):

According to FCC 47 CFR part 27.53(l), for mobile operations in the 3700-3980 MHz band, the conducted power of any emission outside the licensee's authorized bandwidth shall not exceed -13 dBm/MHz.

5.8 Frequency Stability

For NR n5:

1.5 ppm is for base and fixed station. 2.5 ppm is for mobile station.

For NR n2, NR n41, NR n71, NR n77 (3450-3550 MHz), NR n77 (3700-3980 MHz), NR n78:

The frequency stability shall be sufficient to ensure that the fundamental emissions stay within the authorized bands of operation (authorized frequency block).

6 Test Arrangements

6.1 Effective Radiated Power and Equivalent Isotropically Radiated Power

6.1.1 Test Setup

Conducted Power Measurement:

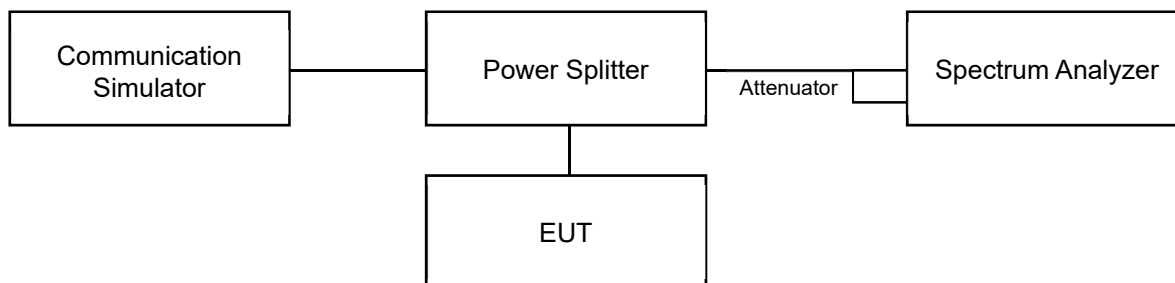

6.1.2 Test Procedure

Conducted Power Measurement:

The EUT is configured by emulator to set data modulation and maximum power using WWAN technology. The power measurement was performed on emulator and power value was measured from power function on emulator. Set the EUT to transmit under low, middle and high channel and record the power level shown on simulator.

Measurement method refers to ANSI C63.26 section 5.2.4.4.

- a. Set span to $2 \times$ to $3 \times$ the OBW.
- b. Set RBW = 1% to 5% of the OBW.
- c. Set VBW $\geq 3 \times$ RBW.
- d. Set number of measurement points in sweep $\geq 2 \times$ span / RBW.
- e. Set Sweep time = auto-couple.
- f. Detector = power averaging (rms).
- g. Set sweep trigger to "free run."
- h. Trace average at least 100 traces in power averaging (rms) mode.
- i. Compute power by integrating the spectrum across the OBW of the signal using the instrument's band or channel power measurement function with band/channel limits set equal to the OBW band edges.
- j. If Duty cycle < 98%, Add $10 \log (1/\text{duty cycle})$ to the measured power level to compute the average power during continuous transmission.

Maximum EIRP / ERP

The relevant equation for determining the maximum ERP or EIRP from the measured RF output power is given in Equation as follows:

$$\text{EIRP} = P_{\text{Meas}} + G_{\text{T}}$$

$$\text{ERP} = P_{\text{Meas}} + G_{\text{T}} - 2.15$$

where

ERP or EIRP effective radiated power or equivalent isotropically radiated power, respectively

(expressed in the same units as P_{Meas} , e.g., dBm or dBW)

P_{Meas} measured transmitter output power or PSD, in dBm or dBW

G_{T} gain of the transmitting antenna, in dBd (ERP) or dBi (EIRP)

6.2 Modulation Characteristics

6.2.1 Test Setup

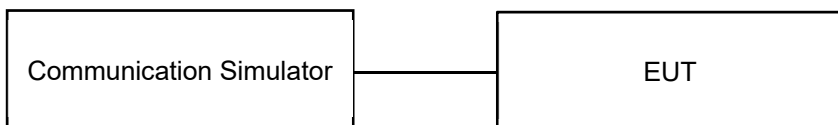

6.2.2 Test Procedure

Connect the EUT to Communication Simulator via the antenna connector, the frequency band is set as EUT supported Modulation and Channels, the EUT output is matched with 50 ohm load, the waveform quality and constellation of the EUT was tested.

6.3 Peak to Average Ratio

6.3.1 Test Setup

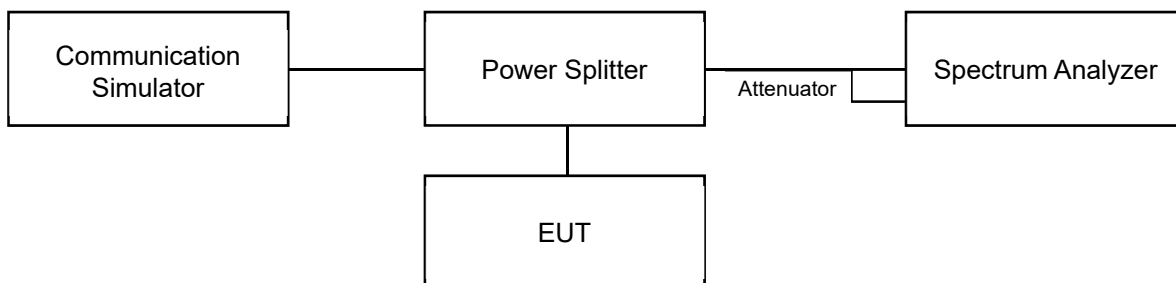

6.3.2 Test Procedure

- a. Set resolution/measurement bandwidth \geq signal's occupied bandwidth;
- b. Set the number of counts to a value that stabilizes the measured CCDF curve;
- c. Record the maximum PAPR level associated with a probability of 0.1%.

6.4 Bandwidth

6.4.1 Test Setup

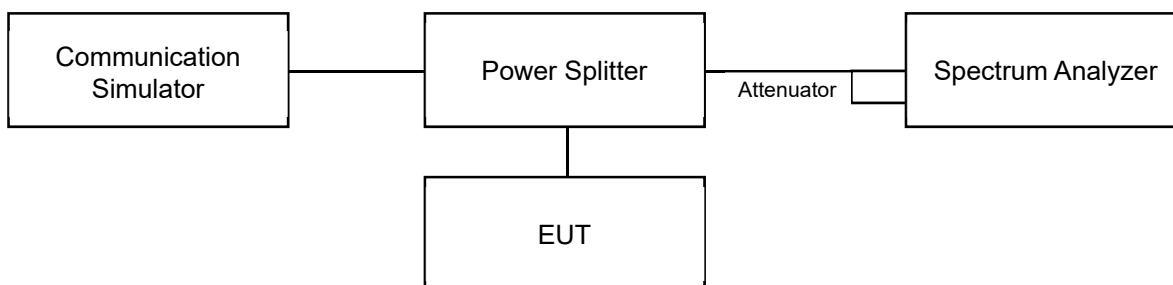

6.4.2 Test Procedure

For the 26 dBc bandwidth measurement method, please refer to section 5.4.3 of ANSI C63.26.

- a. The spectrum analyzer center frequency is set to the nominal EUT channel center frequency. The span range for the spectrum analyzer shall be wide enough to see sufficient roll off of the signal to make the measurement.
- b. The nominal RBW shall be in the range of 1% to 5% of the anticipated OBW, and the VBW shall be set $\geq 3 \times$ RBW.
- c. Set the reference level of the instrument as required to prevent the signal amplitude from exceeding the maximum spectrum analyzer input mixer level for linear operation. See guidance provided in 4.2.3.
- d. The dynamic range of the spectrum analyzer at the selected RBW shall be more than 10 dB below the target “-X dB” requirement, i.e., if the requirement calls for measuring the -26 dB OBW, the spectrum analyzer noise floor at the selected RBW shall be at least 36 dB below the reference level.
- e. Set spectrum analyzer detection mode to peak, and the trace mode to max hold.
- f. Determine the following reference values: Set the EUT to transmit a modulated signal. Allow the trace to stabilize. Set the spectrum analyzer marker to the highest level of the displayed trace (this is the reference value).
- g. Determine the “-X dB amplitude” as equal to (Reference Value - X). Alternatively, this calculation can be performed on the spectrum analyzer using the delta-marker measurement function.
- h. Place two markers, one at the lowest and the other at the highest frequency of the envelope of the spectral display such that each marker is at or slightly below the “-X dB amplitude” determined in step f). If a marker is below this “-X dB amplitude” value it should be as close as possible to this value. The OBW is the positive frequency difference between the two markers.
- i. The OBW shall be reported by providing plot(s) of the measuring instrument display, to include markers depicting the relevant frequency and amplitude information (e.g., marker table). The frequency and amplitude axis and scale shall be clearly labeled. Tabular data may be reported in addition to the plot(s).

For the occupied bandwidth measurement method, please refer to section 5.4.4 of ANSI C63.26.

- a. The spectrum analyzer center frequency is set to the nominal EUT channel center frequency. The span range for the spectrum analyzer shall be wide enough to see sufficient roll off of the signal to make the measurement.
- b. The nominal RBW shall be in the range of 1% to 5% of the anticipated OBW, and the VBW shall be set $\geq 3 \times$ RBW.
- c. Set the reference level of the instrument as required to prevent the signal amplitude from exceeding the maximum spectrum analyzer input mixer level for linear operation. See guidance provided in 4.2.3.
- d. The dynamic range of the spectrum analyzer at the selected RBW shall be more than 10 dB below the target “-X dB” requirement, i.e., if the requirement calls for measuring the -26 dB OBW, the spectrum analyzer noise floor at the selected RBW shall be at least 36 dB below the reference level.
- e. Set spectrum analyzer detection mode to peak, and the trace mode to max hold.
- f. Determine the reference value by either of the following:
 - g. 1) Set the EUT to transmit a modulated signal. Allow the trace to stabilize. Set the spectrum analyzer marker to the highest level of the displayed trace (this is the reference value).
 - h. 2) Set the EUT to transmit an unmodulated carrier. Set the spectrum analyzer marker to the level of the carrier.
- i. Determine the “-X dB amplitude” as equal to (Reference Value - X). Alternatively, this calculation can be performed on the spectrum analyzer using the delta-marker measurement function.
- j. If the reference value was determined using an unmodulated carrier, turn the EUT modulation on, then either clear the existing trace or start a new trace on the spectrum analyzer and allow the new trace to stabilize. Otherwise the trace from step f) shall be used for step i).
- k. Place two markers, one at the lowest and the other at the highest frequency of the envelope of the spectral display such that each marker is at or slightly below the “-X dB amplitude” determined in step f). If a marker is below this “-X dB amplitude” value it should be as close as possible to this value. The OBW is the positive frequency difference between the two markers. The spectral envelope can cross the “-X dB amplitude” at multiple points. The lowest or highest frequency shall be selected as the frequencies that are the farthest away from the center frequency at which the spectral envelope crosses the “-X dB amplitude.”
- l. The OBW shall be reported by providing plot(s) of the measuring instrument display, to include markers depicting the relevant frequency and amplitude information (e.g., marker table). The frequency and amplitude axis and scale shall be clearly labeled. Tabular data may be reported in addition to the plot(s).

6.5 Conducted Spurious Emissions

6.5.1 Test Setup

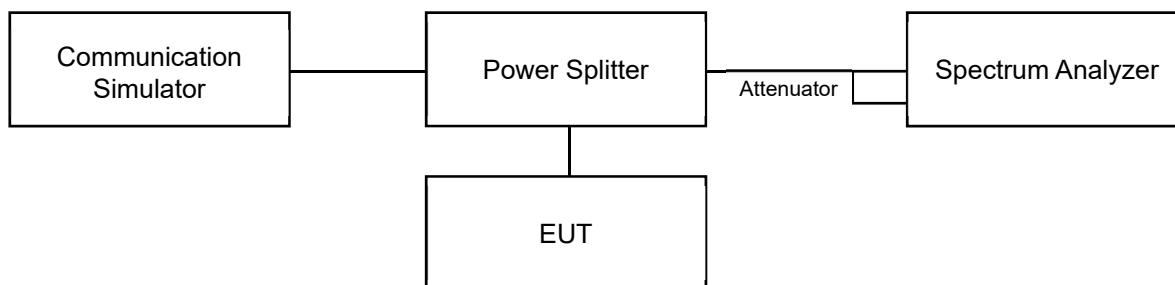

6.5.2 Test Procedure

- a. Measurement refer to ANSI C63.26 section 5.7.
- b. All measurements were done at 3 channels: low, middle and high operational frequency range.
- c. Measuring frequency range is from 9 kHz up to the tenth harmonic of the highest fundamental frequency or to 40 GHz, whichever is lower. 20 dB attenuation pad is connected with spectrum.
- d. The fundamental frequency above 1 GHz, the spectrum set RBW = 1 MHz, VBW = 3 MHz, Detector = Average.
- e. The fundamental frequency below 1 GHz, the spectrum set RBW \geq 100 kHz, VBW \geq 3 x RBW, Detector = Average.
- f. Measuring frequency band edge, narrow RBW (no less than 1% of the OBW) is used for conducted emission measurement.

6.6 Radiated Spurious Emissions below 1GHz

6.6.1 Test Setup

For radiated emission 30 MHz to 1 GHz

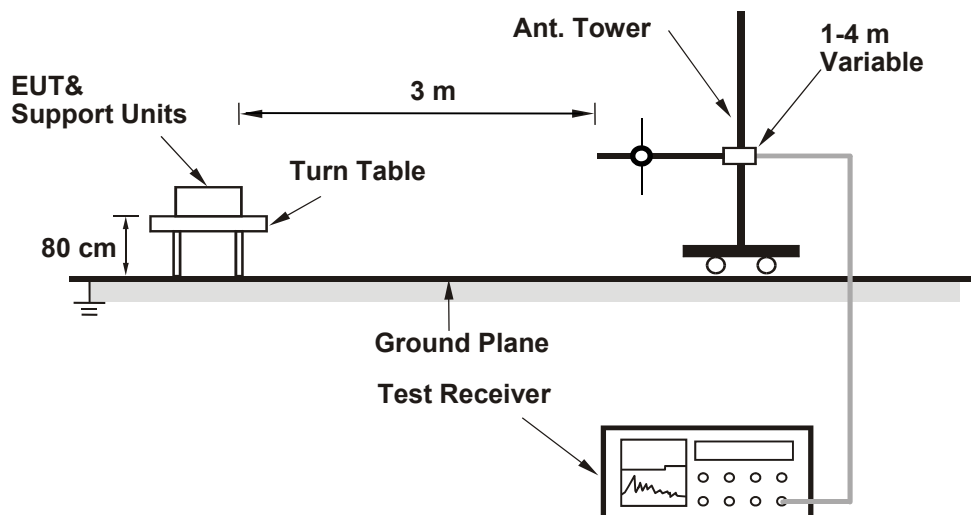

For the actual test configuration, please refer to the attached file (Test Setup Photo).

6.6.2 Test Procedure

The EUT is configured by emulator to set data modulation and maximum power using WWAN technology.

- In the semi-anechoic chamber, EUT placed on the 0.8 m (below or equal 1 GHz) height of turn table, rotated the table around 360 degrees to search the maximum radiation power and receiver antenna shall be rotated vertical and horizontal polarization and moved height from 1 m to 4 m to find the maximum polar radiated power. The "Read Value" is the spectrum reading the maximum power value.
- The height of antenna is varied from one meter to four meters above the ground to determine the maximum value of the field strength. Both horizontal and vertical polarizations of the antenna are set to make the measurement.
- Perform a field strength measurement and record the worse read value, is the field strength value via a spectrum reading obtained corrected for antenna factor, cable loss and pre-amplifier factor and then mathematically convert the measured field strength level to EIRP/ERP level.
- Following C63.26 section 5.5 and 5.2.7
- $EIRP (dBm) = E (dB\mu V/m) + 20\log(D) - 104.8$; where D is the measurement distance (in the far field region) in m.
- $ERP (dBm) = E (dB\mu V/m) + 20\log(D) - 104.8 - 2.15$; where D is the measurement distance (in the far field region) in m.

Note:

- The resolution bandwidth and video bandwidth of test receiver/spectrum analyzer is 1 MHz/3 MHz.
- The emission levels were against the limit of frequency range 9 kHz ~ 30 MHz:
The amplitude of spurious emissions attenuated more than 20 dB below the permissible value is not required to be report.

6.7 Radiated Spurious Emissions above 1GHz

6.7.1 Test Setup

For radiated emission above 1 GHz

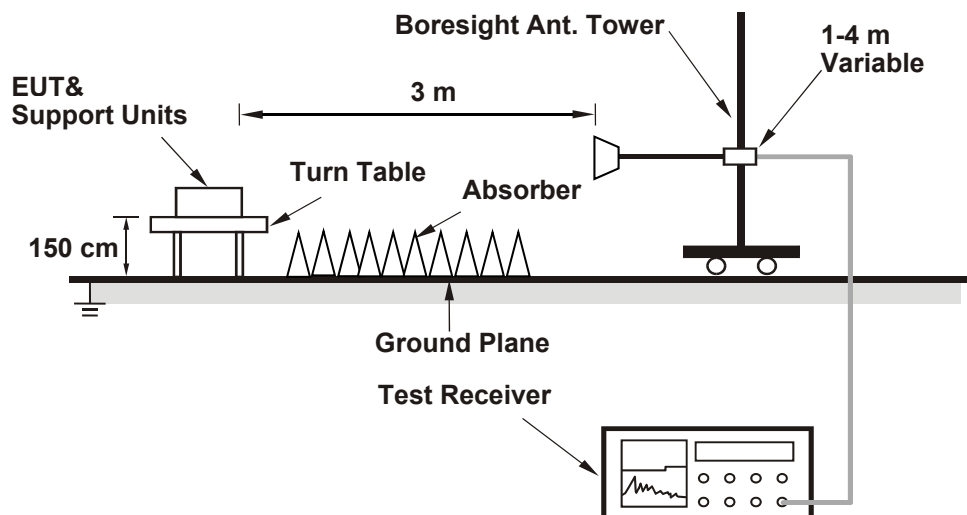

For the actual test configuration, please refer to the attached file (Test Setup Photo).

6.7.2 Test Procedure

The EUT is configured by emulator to set data modulation and maximum power using WWAN technology.

- In the semi-anechoic chamber, EUT placed on the 1.5 m height of turn table, rotated the table around 360 degrees to search the maximum radiation power and receiver antenna shall be rotated vertical and horizontal polarization and moved height from 1 m to 4 m to find the maximum polar radiated power. The "Read Value" is the spectrum reading the maximum power value.
- The height of antenna is varied from one meter to four meters above the ground to determine the maximum value of the field strength. Both horizontal and vertical polarizations of the antenna are set to make the measurement.
- Perform a field strength measurement and record the worse read value, is the field strength value via a spectrum reading obtained corrected for antenna factor, cable loss and pre-amplifier factor and then mathematically convert the measured field strength level to EIRP/ERP level.
- Following C63.26 section 5.5 and 5.2.7
- $EIRP (dBm) = E (dB\mu V/m) + 20\log(D) - 104.8$; where D is the measurement distance (in the far field region) in m.
- $ERP (dBm) = E (dB\mu V/m) + 20\log(D) - 104.8 - 2.15$; where D is the measurement distance (in the far field region) in m.

Note:

- The resolution bandwidth and video bandwidth of test receiver/spectrum analyzer is 1 MHz/3 MHz.

6.8 Frequency Stability

6.8.1 Test Setup

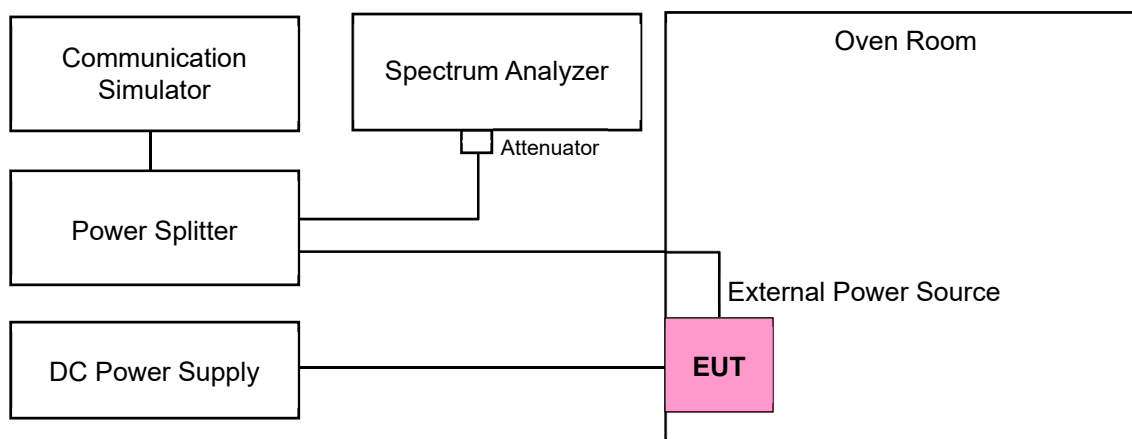

6.8.2 Test Procedure

The EUT is configured by emulator to set data modulation and maximum power using WWAN technology.

- Device is placed at the oven room. The oven room could control the temperatures and humidity. Power warm up is at least 15 min and power applied should perform before recording frequency error.
- EUT is connected the external power supply to control the DC input power. The test voltage range is from minimum to maximum working voltage. Each step shall be record the frequency error rate.
- The temperature range step is 10 degrees in this test items. All temperature levels shall be hold the $\pm 0.5^{\circ}\text{C}$ during the measurement testing. The each temperature step shall be at least 0.5 hours, consider the EUT could be test under the stability condition.

Note: The frequency error was recorded frequency error from the communication simulator.

7 Test Results of Test Item

7.1 Effective Radiated Power and Equivalent Isotropically Radiated Power

Input Power:	3.85 Vdc	Environmental Conditions:	22°C, 73% RH	Tested By:	Willy Cheng
--------------	----------	---------------------------	--------------	------------	-------------

7.1.1 NR n2 SCS 15 kHz

Conducted Output Power (dBm)

NR Band 2						
BW	MCS Index	RB Size	RB Offset	Low	Mid	High
		Channel		372000	376000	380000
		Frequency (MHz)		1860	1880	1900
20M	DFT-S PI/2 BPSK	1	1	23.65	23.84	24.19
20M	DFT-S QPSK	1	1	23.75	23.92	24.27
		1	53	23.73	23.75	24.07
		1	104	23.56	23.39	23.79
		50	0	22.93	22.9	22.97
		50	28	23.9	23.73	23.91
		50	56	22.73	22.82	23.02
		100	0	22.87	22.75	23.14
20M	DFT-S 16QAM	1	1	22.67	22.71	23.02
20M	DFT-S 64QAM	1	1	21.48	21.64	21.85
20M	DFT-S 256QAM	1	1	19.63	19.54	19.88
20M	CP QPSK	1	1	22.33	22.36	22.56
BW	MCS Index	Channel		371500	376000	380500
		Frequency (MHz)		1857.5	1880	1902.5
15M	DFT-S PI/2 BPSK	1	1	23.54	23.56	23.58
15M	DFT-S QPSK	1	1	23.59	23.66	23.57
		1	40	23.35	23.41	23.36
		1	77	22.99	23.05	23.03
		36	0	22.45	22.52	22.54
		36	22	23.29	23.36	23.43
		36	43	22.32	22.33	22.39
		75	0	22.44	22.48	22.47
15M	DFT-S 16QAM	1	1	22.23	22.27	22.4
15M	DFT-S 64QAM	1	1	21.2	21.25	21.08
15M	DFT-S 256QAM	1	1	19.04	19.11	19.08
15M	CP QPSK	1	1	21.79	21.83	21.95

NR Band 2						
BW	MCS Index	RB Size	RB Offset	Low	Mid	High
		Channel		371000	376000	381000
		Frequency (MHz)		1855	1880	1905
10M	DFT-S PI/2 BPSK	1	1	23.47	23.53	23.49
10M	DFT-S QPSK	1	1	23.61	23.63	23.61
		1	26	23.33	23.38	23.24
		1	50	22.96	23.02	23.05
		25	0	22.51	22.49	22.52
		25	14	23.34	23.33	23.4
		25	27	22.25	22.3	22.33
		50	0	22.47	22.45	22.32
		10M	DFT-S 16QAM	1	1	22.21
10M	DFT-S 64QAM	1	1	21.18	21.22	21.05
10M	DFT-S 256QAM	1	1	19.09	19.08	19.12
10M	CP QPSK	1	1	21.8	21.8	21.87
BW	MCS Index	Channel		370500	376000	381500
		Frequency (MHz)		1852.5	1880	1907.5
5M	DFT-S PI/2 BPSK	1	1	23.5	23.53	23.48
5M	DFT-S QPSK	1	1	23.62	23.65	23.63
		1	13	23.35	23.33	23.4
		1	23	22.96	23.02	23.01
		12	0	22.5	22.46	22.48
		12	7	23.28	23.28	23.29
		12	13	22.31	22.32	22.29
		25	0	22.45	22.42	22.45
5M	DFT-S 16QAM	1	1	22.24	22.22	22.2
5M	DFT-S 64QAM	1	1	21.24	21.19	21.18
5M	DFT-S 256QAM	1	1	19.1	19.1	19.02
5M	CP QPSK	1	1	21.79	21.81	21.78

EIRP Power (dBm)

NR Band 2						
BW	MCS Index	RB Size	RB Offset	Low	Mid	High
		Channel		372000	376000	380000
		Frequency (MHz)		1860	1880	1900
20M	DFT-S PI/2 BPSK	1	1	23.95	24.14	24.49
20M	DFT-S QPSK	1	1	24.05	24.22	24.57
		1	53	24.03	24.05	24.37
		1	104	23.86	23.69	24.09
		50	0	23.23	23.20	23.27
		50	28	24.20	24.03	24.21
		50	56	23.03	23.12	23.32
		100	0	23.17	23.05	23.44
20M	DFT-S 16QAM	1	1	22.97	23.01	23.32
20M	DFT-S 64QAM	1	1	21.78	21.94	22.15
20M	DFT-S 256QAM	1	1	19.93	19.84	20.18
20M	CP QPSK	1	1	22.63	22.66	22.86
BW	MCS Index	Channel		371500	376000	380500
		Frequency (MHz)		1857.5	1880	1902.5
15M	DFT-S PI/2 BPSK	1	1	23.84	23.86	23.88
15M	DFT-S QPSK	1	1	23.89	23.96	23.87
		1	40	23.65	23.71	23.66
		1	77	23.29	23.35	23.33
		36	0	22.75	22.82	22.84
		36	22	23.59	23.66	23.73
		36	43	22.62	22.63	22.69
		75	0	22.74	22.78	22.77
15M	DFT-S 16QAM	1	1	22.53	22.57	22.70
15M	DFT-S 64QAM	1	1	21.50	21.55	21.38
15M	DFT-S 256QAM	1	1	19.34	19.41	19.38
15M	CP QPSK	1	1	22.09	22.13	22.25

*EIRP (dBm) = Conducted Output Power (dBm) + Antenna Gain (dBi)

NR Band 2						
BW	MCS Index	RB Size	RB Offset	Low	Mid	High
		Channel		371000	376000	381000
		Frequency (MHz)		1855	1880	1905
10M	DFT-S PI/2 BPSK	1	1	23.77	23.83	23.79
10M	DFT-S QPSK	1	1	23.91	23.93	23.91
		1	26	23.63	23.68	23.54
		1	50	23.26	23.32	23.35
		25	0	22.81	22.79	22.82
		25	14	23.64	23.63	23.70
		25	27	22.55	22.60	22.63
		50	0	22.77	22.75	22.62
10M	DFT-S 16QAM	1	1	22.51	22.54	22.54
10M	DFT-S 64QAM	1	1	21.48	21.52	21.35
10M	DFT-S 256QAM	1	1	19.39	19.38	19.42
10M	CP QPSK	1	1	22.10	22.10	22.17
BW	MCS Index	Channel		370500	376000	381500
		Frequency (MHz)		1852.5	1880	1907.5
5M	DFT-S PI/2 BPSK	1	1	23.80	23.83	23.78
5M	DFT-S QPSK	1	1	23.92	23.95	23.93
		1	13	23.65	23.63	23.70
		1	23	23.26	23.32	23.31
		12	0	22.80	22.76	22.78
		12	7	23.58	23.58	23.59
		12	13	22.61	22.62	22.59
		25	0	22.75	22.72	22.75
5M	DFT-S 16QAM	1	1	22.54	22.52	22.50
5M	DFT-S 64QAM	1	1	21.54	21.49	21.48
5M	DFT-S 256QAM	1	1	19.40	19.40	19.32
5M	CP QPSK	1	1	22.09	22.11	22.08

*EIRP (dBm) = Conducted Output Power (dBm) + Antenna Gain (dBi)

7.1.2 NR n5 SCS 15 kHz

Conducted Output Power (dBm)

NR Band 5						
BW	MCS Index	RB Size	RB Offset	Low	Mid	High
		Channel		166800	167300	167800
		Frequency (MHz)		834	836.5	839
20M	DFT-S PI/2 BPSK	1	1	22.26	22.81	22.67
20M	DFT-S QPSK	1	1	22.34	22.87	22.83
		1	53	22.23	22.53	22.45
		1	104	22.18	22.25	22.2
		50	0	21.82	21.85	21.78
		50	28	22.32	22.76	22.71
		50	56	21.55	21.65	21.58
		100	0	21.79	21.87	21.69
20M	DFT-S 16QAM	1	1	21.45	21.78	21.66
20M	DFT-S 64QAM	1	1	20.09	20.12	20.11
20M	DFT-S 256QAM	1	1	18.04	18.15	18.09
20M	CP QPSK	1	1	21.23	21.33	21.27
BW	MCS Index	Channel		166300	167300	168300
		Frequency (MHz)		831.5	836.5	841.5
15M	DFT-S PI/2 BPSK	1	1	22.76	22.8	22.57
15M	DFT-S QPSK	1	1	22.33	22.79	22.73
		1	40	22.19	22.45	22.42
		1	77	22.18	22.21	22.15
		36	0	21.73	21.82	21.78
		36	22	22.22	22.66	22.68
		36	43	21.47	21.59	21.51
		75	0	21.72	21.81	21.69
15M	DFT-S 16QAM	1	1	21.38	21.78	21.61
15M	DFT-S 64QAM	1	1	20.06	20.07	20.07
15M	DFT-S 256QAM	1	1	18.03	18.14	18.08
15M	CP QPSK	1	1	21.18	21.26	21.25

NR Band 5						
BW	MCS Index	RB Size	RB Offset	Low	Mid	High
		Channel		165800	167300	168800
		Frequency (MHz)		829	836.5	844
10M	DFT-S PI/2 BPSK	1	1	22.7	22.72	22.65
10M	DFT-S QPSK	1	1	22.29	22.8	22.76
		1	26	22.22	22.5	22.35
		1	50	22.18	22.19	22.15
		25	0	21.81	21.8	21.71
		25	14	22.31	22.73	22.65
		25	27	21.52	21.64	21.48
		50	0	21.77	21.84	21.62
		10M	DFT-S 16QAM	1	1	21.42
10M	DFT-S 64QAM	1	1	20.09	20.07	20.04
10M	DFT-S 256QAM	1	1	17.97	18.13	17.99
10M	CP QPSK	1	1	21.16	21.32	21.19
BW	MCS Index	Channel		165300	167300	169300
		Frequency (MHz)		826.5	836.5	846.5
5M	DFT-S PI/2 BPSK	1	1	22.73	22.8	22.6
5M	DFT-S QPSK	1	1	22.33	22.8	22.8
		1	13	22.17	22.48	22.41
		1	23	22.12	22.2	22.15
		12	0	21.78	21.8	21.72
		12	7	22.29	22.74	22.7
		12	13	21.51	21.6	21.54
		25	0	21.73	21.81	21.61
		5M	DFT-S 16QAM	1	1	21.37
5M	DFT-S 64QAM	1	1	20.03	20.04	20.06
5M	DFT-S 256QAM	1	1	18.01	18.05	18.05
5M	CP QPSK	1	1	21.13	21.33	21.21



ERP Power (dBm)

NR Band 5						
BW	MCS Index	RB Size	RB Offset	Low	Mid	High
		Channel		166800	167300	167800
		Frequency (MHz)		834	836.5	839
20M	DFT-S PI/2 BPSK	1	1	17.91	18.46	18.32
20M	DFT-S QPSK	1	1	17.99	18.52	18.48
		1	53	17.88	18.18	18.10
		1	104	17.83	17.90	17.85
		50	0	17.47	17.50	17.43
		50	28	17.97	18.41	18.36
		50	56	17.20	17.30	17.23
		100	0	17.44	17.52	17.34
20M	DFT-S 16QAM	1	1	17.10	17.43	17.31
20M	DFT-S 64QAM	1	1	15.74	15.77	15.76
20M	DFT-S 256QAM	1	1	13.69	13.80	13.74
20M	CP QPSK	1	1	16.88	16.98	16.92
BW	MCS Index	Channel		166300	167300	168300
		Frequency (MHz)		831.5	836.5	841.5
15M	DFT-S PI/2 BPSK	1	1	18.41	18.45	18.22
15M	DFT-S QPSK	1	1	17.98	18.44	18.38
		1	40	17.84	18.10	18.07
		1	77	17.83	17.86	17.80
		36	0	17.38	17.47	17.43
		36	22	17.87	18.31	18.33
		36	43	17.12	17.24	17.16
		75	0	17.37	17.46	17.34
15M	DFT-S 16QAM	1	1	17.03	17.43	17.26
15M	DFT-S 64QAM	1	1	15.71	15.72	15.72
15M	DFT-S 256QAM	1	1	13.68	13.79	13.73
15M	CP QPSK	1	1	16.83	16.91	16.90

*ERP (dBm) = Conducted Output Power (dBm) + Antenna Gain (dBi) - 2.15

NR Band 5						
BW	MCS Index	RB Size	RB Offset	Low	Mid	High
		Channel		165800	167300	168800
		Frequency (MHz)		829	836.5	844
10M	DFT-S PI/2 BPSK	1	1	18.35	18.37	18.30
10M	DFT-S QPSK	1	1	17.94	18.45	18.41
		1	26	17.87	18.15	18.00
		1	50	17.83	17.84	17.80
		25	0	17.46	17.45	17.36
		25	14	17.96	18.38	18.30
		25	27	17.17	17.29	17.13
		50	0	17.42	17.49	17.27
10M	DFT-S 16QAM	1	1	17.07	17.37	17.28
10M	DFT-S 64QAM	1	1	15.74	15.72	15.69
10M	DFT-S 256QAM	1	1	13.62	13.78	13.64
10M	CP QPSK	1	1	16.81	16.97	16.84
BW	MCS Index	Channel		165300	167300	169300
		Frequency (MHz)		826.5	836.5	846.5
5M	DFT-S PI/2 BPSK	1	1	18.38	18.45	18.25
5M	DFT-S QPSK	1	1	17.98	18.45	18.45
		1	13	17.82	18.13	18.06
		1	23	17.77	17.85	17.80
		12	0	17.43	17.45	17.37
		12	7	17.94	18.39	18.35
		12	13	17.16	17.25	17.19
		25	0	17.38	17.46	17.26
5M	DFT-S 16QAM	1	1	17.02	17.39	17.22
5M	DFT-S 64QAM	1	1	15.68	15.69	15.71
5M	DFT-S 256QAM	1	1	13.66	13.70	13.70
5M	CP QPSK	1	1	16.78	16.98	16.86

*ERP (dBm) = Conducted Output Power (dBm) + Antenna Gain (dBi) - 2.15

7.1.3 NR n41 SCS 30 kHz

Conducted Output Power (dBm)

NR Band 41						
BW	MCS Index	RB Size	RB Offset	Low	Mid	High
		Channel		509202	518598	528000
		Frequency (MHz)		2546.01	2592.99	2640
100M	DFT-S PI/2 BPSK	1	1	24.53	24.46	24.39
100M	DFT-S QPSK	1	1	24.62	24.66	24.44
		1	137	24.36	24.52	24.37
		1	271	24.39	24.57	24.44
		135	0	23.45	23.57	23.52
		135	69	24.47	24.57	24.52
		135	138	23.24	23.41	23.29
		270	0	23.42	23.56	23.28
100M	DFT-S 16QAM	1	1	23.20	23.38	23.26
100M	DFT-S 64QAM	1	1	22.25	22.35	22.25
100M	DFT-S 256QAM	1	1	20.10	20.21	20.04
100M	CP QPSK	1	1	23.03	23.06	23.04
BW	MCS Index	Channel		508200	518598	528996
		Frequency (MHz)		2541	2592.99	2644.98
90M	DFT-S PI/2 BPSK	1	1	24.48	24.55	24.45
90M	DFT-S QPSK	1	1	24.46	24.48	24.46
		1	123	24.38	24.38	24.36
		1	243	24.42	24.42	24.41
		120	0	23.40	23.41	23.35
		120	63	24.36	24.42	24.37
		120	125	23.30	23.21	23.24
		243	0	23.40	23.44	23.35
90M	DFT-S 16QAM	1	1	23.27	23.23	23.20
90M	DFT-S 64QAM	1	1	22.15	22.25	22.24
90M	DFT-S 256QAM	1	1	20.09	20.02	20.04
90M	CP QPSK	1	1	22.91	22.88	22.85

NR Band 41						
BW	MCS Index	RB Size	RB Offset	Low	Mid	High
		Channel		507204	518598	529998
		Frequency (MHz)		2536.02	2592.99	2649.99
80M	DFT-S PI/2 BPSK	1	1	24.51	24.56	24.48
80M	DFT-S QPSK	1	1	24.52	24.48	24.47
		1	109	24.38	24.34	24.37
		1	215	24.36	24.37	24.36
		108	0	23.37	23.36	23.36
		108	55	24.41	24.42	24.47
		108	109	23.28	23.27	23.30
		216	0	23.40	23.36	23.43
		80M	DFT-S 16QAM	1	1	23.27
80M	DFT-S 64QAM	1	1	22.22	22.19	22.24
80M	DFT-S 256QAM	1	1	20.03	20.00	20.04
80M	CP QPSK	1	1	22.88	22.90	22.87
BW	MCS Index	RB Size	RB Offset	Low	Mid	High
		Channel		505200	518598	531996
		Frequency (MHz)		2526	2592.99	2659.98
60M	DFT-S PI/2 BPSK	1	1	24.56	24.55	24.45
60M	DFT-S QPSK	1	1	24.49	24.54	24.51
		1	81	24.36	24.35	24.38
		1	160	24.42	24.42	24.37
		81	0	23.42	23.40	23.35
		81	41	24.46	24.42	24.47
		81	81	23.20	23.28	23.23
		162	0	23.37	23.40	23.45
		60M	DFT-S 16QAM	1	1	23.22
60M	DFT-S 64QAM	1	1	22.25	22.25	22.24
60M	DFT-S 256QAM	1	1	20.10	20.08	20.04
60M	CP QPSK	1	1	22.94	22.86	22.89

NR Band 41						
BW	MCS Index	Channel		504204	518598	532998
		Frequency (MHz)		2521.02	2592.99	2664.99
50M	DFT-S PI/2 BPSK	1	1	24.49	24.45	24.47
50M	DFT-S QPSK	1	1	24.53	24.52	24.56
		1	67	24.40	24.42	24.32
		1	131	24.47	24.36	24.37
		64	0	23.37	23.35	23.41
		64	35	24.44	24.36	24.38
		64	69	23.28	23.29	23.22
		128	0	23.39	23.44	23.45
50M	DFT-S 16QAM	1	1	23.24	23.21	23.20
50M	DFT-S 64QAM	1	1	22.21	22.24	22.24
50M	DFT-S 256QAM	1	1	20.04	20.10	20.04
50M	CP QPSK	1	1	22.95	22.89	22.90
BW	MCS Index	RB Size	RB Offset	Low	Mid	High
		Channel		503202	518598	534000
		Frequency (MHz)		2516.01	2592.99	2670
40M	DFT-S PI/2 BPSK	1	1	24.49	24.48	24.50
40M	DFT-S QPSK	1	1	24.53	24.50	24.45
		1	53	24.36	24.31	24.41
		1	104	24.44	24.36	24.42
		50	0	23.38	23.45	23.41
		50	28	24.43	24.42	24.47
		50	56	23.22	23.30	23.26
		100	0	23.37	23.38	23.35
40M	DFT-S 16QAM	1	1	23.25	23.17	23.20
40M	DFT-S 64QAM	1	1	22.25	22.23	22.24
40M	DFT-S 256QAM	1	1	20.00	20.01	20.04
40M	CP QPSK	1	1	22.92	22.86	22.88



NR Band 41						
BW	MCS Index	RB Size	RB Offset	Low	Mid	High
		Channel		501204	518598	535998
		Frequency (MHz)		2506.02	2592.99	2679.99
20M	DFT-S PI/2 BPSK	1	1	24.51	24.56	24.54
20M	DFT-S QPSK	1	1	24.48	24.52	24.53
		1	26	24.38	24.38	24.39
		1	49	24.41	24.42	24.43
		25	0	23.37	23.45	23.43
		25	13	24.39	24.43	24.43
		25	26	23.28	23.26	23.28
		50	0	23.36	23.40	23.35
		20M	DFT-S 16QAM	1	1	23.17
20M	DFT-S 64QAM	1	1	22.19	22.21	22.24
20M	DFT-S 256QAM	1	1	20.08	20.09	20.04
20M	CP QPSK	1	1	22.91	22.91	22.91



EIRP Power (dBm)

NR Band 41						
BW	MCS Index	RB Size	RB Offset	Low	Mid	High
		Channel		509202	518598	528000
		Frequency (MHz)		2546.01	2592.99	2640
100M	DFT-S PI/2 BPSK	1	1	24.57	24.50	24.43
100M	DFT-S QPSK	1	1	24.66	24.70	24.48
		1	137	24.40	24.56	24.41
		1	271	24.43	24.61	24.48
		135	0	23.49	23.61	23.56
		135	69	24.51	24.61	24.56
		135	138	23.28	23.45	23.33
		270	0	23.46	23.60	23.32
100M	DFT-S 16QAM	1	1	23.24	23.42	23.30
100M	DFT-S 64QAM	1	1	22.29	22.39	22.29
100M	DFT-S 256QAM	1	1	20.14	20.25	20.08
100M	CP QPSK	1	1	23.07	23.10	23.08
BW	MCS Index	Channel		508200	518598	528996
		Frequency (MHz)		2541	2592.99	2644.98
90M	DFT-S PI/2 BPSK	1	1	24.52	24.59	24.49
90M	DFT-S QPSK	1	1	24.50	24.52	24.50
		1	123	24.42	24.42	24.40
		1	243	24.46	24.46	24.45
		120	0	23.44	23.45	23.39
		120	63	24.40	24.46	24.41
		120	125	23.34	23.25	23.28
		243	0	23.44	23.48	23.39
90M	DFT-S 16QAM	1	1	23.31	23.27	23.24
90M	DFT-S 64QAM	1	1	22.19	22.29	22.28
90M	DFT-S 256QAM	1	1	20.13	20.06	20.08
90M	CP QPSK	1	1	22.95	22.92	22.89

*EIRP (dBm) = Conducted Output Power (dBm) + Antenna Gain (dBi)

NR Band 41						
BW	MCS Index	RB Size	RB Offset	Low	Mid	High
		Channel		507204	518598	529998
		Frequency (MHz)		2536.02	2592.99	2649.99
80M	DFT-S PI/2 BPSK	1	1	24.55	24.60	24.52
80M	DFT-S QPSK	1	1	24.56	24.52	24.51
		1	109	24.42	24.38	24.41
		1	215	24.40	24.41	24.40
		108	0	23.41	23.40	23.40
		108	55	24.45	24.46	24.51
		108	109	23.32	23.31	23.34
		216	0	23.44	23.40	23.47
80M	DFT-S 16QAM	1	1	23.31	23.30	23.24
80M	DFT-S 64QAM	1	1	22.26	22.23	22.28
80M	DFT-S 256QAM	1	1	20.07	20.04	20.08
80M	CP QPSK	1	1	22.92	22.94	22.91
BW	MCS Index	RB Size	RB Offset	Low	Mid	High
		Channel		505200	518598	531996
		Frequency (MHz)		2526	2592.99	2659.98
60M	DFT-S PI/2 BPSK	1	1	24.60	24.59	24.49
60M	DFT-S QPSK	1	1	24.53	24.58	24.55
		1	81	24.40	24.39	24.42
		1	160	24.46	24.46	24.41
		81	0	23.46	23.44	23.39
		81	41	24.50	24.46	24.51
		81	81	23.24	23.32	23.27
		162	0	23.41	23.44	23.49
60M	DFT-S 16QAM	1	1	23.26	23.21	23.24
60M	DFT-S 64QAM	1	1	22.29	22.29	22.28
60M	DFT-S 256QAM	1	1	20.14	20.12	20.08
60M	CP QPSK	1	1	22.98	22.90	22.93

*EIRP (dBm) = Conducted Output Power (dBm) + Antenna Gain (dBi)



NR Band 41						
BW	MCS Index	Channel		504204	518598	532998
		Frequency (MHz)		2521.02	2592.99	2664.99
50M	DFT-S PI/2 BPSK	1	1	24.53	24.49	24.51
50M	DFT-S QPSK	1	1	24.57	24.56	24.60
		1	67	24.44	24.46	24.36
		1	131	24.51	24.40	24.41
		64	0	23.41	23.39	23.45
		64	35	24.48	24.40	24.42
		64	69	23.32	23.33	23.26
		128	0	23.43	23.48	23.49
50M	DFT-S 16QAM	1	1	23.28	23.25	23.24
50M	DFT-S 64QAM	1	1	22.25	22.28	22.28
50M	DFT-S 256QAM	1	1	20.08	20.14	20.08
50M	CP QPSK	1	1	22.99	22.93	22.94
BW	MCS Index	RB Size	RB Offset	Low	Mid	High
		Channel		503202	518598	534000
		Frequency (MHz)		2516.01	2592.99	2670
40M	DFT-S PI/2 BPSK	1	1	24.53	24.52	24.54
40M	DFT-S QPSK	1	1	24.57	24.54	24.49
		1	53	24.40	24.35	24.45
		1	104	24.48	24.40	24.46
		50	0	23.42	23.49	23.45
		50	28	24.47	24.46	24.51
		50	56	23.26	23.34	23.30
		100	0	23.41	23.42	23.39
40M	DFT-S 16QAM	1	1	23.29	23.21	23.24
40M	DFT-S 64QAM	1	1	22.29	22.27	22.28
40M	DFT-S 256QAM	1	1	20.04	20.05	20.08
40M	CP QPSK	1	1	22.96	22.90	22.92

*EIRP (dBm) = Conducted Output Power (dBm) + Antenna Gain (dBi)

NR Band 41						
BW	MCS Index	RB Size	RB Offset	Low	Mid	High
		Channel		501204	518598	535998
		Frequency (MHz)		2506.02	2592.99	2679.99
20M	DFT-S PI/2 BPSK	1	1	24.55	24.60	24.58
20M	DFT-S QPSK	1	1	24.52	24.56	24.57
		1	26	24.42	24.42	24.43
		1	49	24.45	24.46	24.47
		25	0	23.41	23.49	23.47
		25	13	24.43	24.47	24.47
		25	26	23.32	23.30	23.32
		50	0	23.40	23.44	23.39
		20M	DFT-S 16QAM	1	1	23.21
20M	DFT-S 64QAM	1	1	22.23	22.25	22.28
20M	DFT-S 256QAM	1	1	20.12	20.13	20.08
20M	CP QPSK	1	1	22.95	22.95	22.95

*EIRP (dBm) = Conducted Output Power (dBm) + Antenna Gain (dBi)

7.1.4 NR n71 SCS 15 kHz

Conducted Output Power (dBm)

NR Band 71						
BW	MCS Index	RB Size	RB Offset	Low	Mid	High
		Channel		134600	136100	137600
		Frequency (MHz)		673	680.5	688
20M	DFT-S PI/2 BPSK	1	1	23.89	24.17	24.01
20M	DFT-S QPSK	1	1	24.01	24.28	24.14
		1	53	23.81	24.06	23.82
		1	104	23.83	24.05	23.81
		50	0	22.86	23.09	23.08
		50	28	23.97	23.99	23.96
		50	56	22.74	22.99	22.74
		100	0	23.04	23.08	22.87
20M	DFT-S 16QAM	1	1	22.63	22.87	22.59
20M	DFT-S 64QAM	1	1	21.32	21.56	21.32
20M	DFT-S 256QAM	1	1	19.23	19.47	19.21
20M	CP QPSK	1	1	22.43	22.69	22.48
BW	MCS Index	Channel		134100	136100	138100
		Frequency (MHz)		670.5	680.5	690.5
15M	DFT-S PI/2 BPSK	1	1	23.85	24.14	23.97
15M	DFT-S QPSK	1	1	24.03	24.06	24.04
		1	40	23.84	23.85	23.83
		1	77	23.81	23.78	23.83
		36	0	22.87	22.81	22.85
		36	22	23.75	23.75	23.82
		36	43	22.77	22.78	22.70
		75	0	22.85	22.80	22.78
15M	DFT-S 16QAM	1	1	22.60	22.61	22.60
15M	DFT-S 64QAM	1	1	21.29	21.34	21.33
15M	DFT-S 256QAM	1	1	19.27	19.21	19.26
15M	CP QPSK	1	1	22.25	22.19	22.18

NR Band 71						
BW	MCS Index	RB Size	RB Offset	Low	Mid	High
		Channel		133600	136100	138600
		Frequency (MHz)		668	680.5	693
10M	DFT-S PI/2 BPSK	1	1	23.85	24.14	24.01
10M	DFT-S QPSK	1	1	24.04	24.00	24.00
		1	26	23.77	23.82	23.77
		1	50	23.84	23.78	23.85
		25	0	22.79	22.85	22.83
		25	14	23.80	23.75	23.77
		25	27	22.73	22.73	22.71
		50	0	22.85	22.79	22.81
		10M	DFT-S 16QAM	1	1	22.61
10M	DFT-S 64QAM	1	1	21.34	21.30	21.30
10M	DFT-S 256QAM	1	1	19.26	19.27	19.26
10M	CP QPSK	1	1	22.35	22.70	22.52
BW	MCS Index	Channel		133100	136100	139100
		Frequency (MHz)		665.5	680.5	695.5
5M	DFT-S PI/2 BPSK	1	1	23.93	24.16	24.00
5M	DFT-S QPSK	1	1	24.05	23.98	24.08
		1	13	23.82	23.80	23.82
		1	23	23.84	23.85	23.77
		12	0	22.80	22.89	22.84
		12	7	23.82	23.74	23.73
		12	13	22.79	22.72	22.73
		25	0	22.85	22.85	22.84
5M	DFT-S 16QAM	1	1	22.63	22.61	22.66
5M	DFT-S 64QAM	1	1	21.35	21.29	21.27
5M	DFT-S 256QAM	1	1	19.26	19.25	19.24
5M	CP QPSK	1	1	22.42	22.62	22.49



ERP Power (dBm)

NR Band 71						
BW	MCS Index	RB Size	RB Offset	Low	Mid	High
		Channel		134600	136100	137600
		Frequency (MHz)		673	680.5	688
20M	DFT-S PI/2 BPSK	1	1	19.29	19.57	19.41
20M	DFT-S QPSK	1	1	19.41	19.68	19.54
		1	53	19.21	19.46	19.22
		1	104	19.23	19.45	19.21
		50	0	18.26	18.49	18.48
		50	28	19.37	19.39	19.36
		50	56	18.14	18.39	18.14
		100	0	18.44	18.48	18.27
20M	DFT-S 16QAM	1	1	18.03	18.27	17.99
20M	DFT-S 64QAM	1	1	16.72	16.96	16.72
20M	DFT-S 256QAM	1	1	14.63	14.87	14.61
20M	CP QPSK	1	1	17.83	18.09	17.88
BW	MCS Index	Channel		134100	136100	138100
		Frequency (MHz)		670.5	680.5	690.5
15M	DFT-S PI/2 BPSK	1	1	19.25	19.54	19.37
15M	DFT-S QPSK	1	1	19.43	19.46	19.44
		1	40	19.24	19.25	19.23
		1	77	19.21	19.18	19.23
		36	0	18.27	18.21	18.25
		36	22	19.15	19.15	19.22
		36	43	18.17	18.18	18.10
		75	0	18.25	18.20	18.18
15M	DFT-S 16QAM	1	1	18.00	18.01	18.00
15M	DFT-S 64QAM	1	1	16.69	16.74	16.73
15M	DFT-S 256QAM	1	1	14.67	14.61	14.66
15M	CP QPSK	1	1	17.65	17.59	17.58

*ERP (dBm) = Conducted Output Power (dBm) + Antenna Gain (dBi) - 2.15

NR Band 71						
BW	MCS Index	RB Size	RB Offset	Low	Mid	High
		Channel		133600	136100	138600
		Frequency (MHz)		668	680.5	693
10M	DFT-S PI/2 BPSK	1	1	19.25	19.54	19.41
10M	DFT-S QPSK	1	1	19.44	19.40	19.40
		1	26	19.17	19.22	19.17
		1	50	19.24	19.18	19.25
		25	0	18.19	18.25	18.23
		25	14	19.20	19.15	19.17
		25	27	18.13	18.13	18.11
		50	0	18.25	18.19	18.21
		10M	DFT-S 16QAM	1	1	18.01
10M	DFT-S 64QAM	1	1	16.74	16.70	16.70
10M	DFT-S 256QAM	1	1	14.66	14.67	14.66
10M	CP QPSK	1	1	17.75	18.10	17.92
BW	MCS Index	Channel		133100	136100	139100
		Frequency (MHz)		665.5	680.5	695.5
5M	DFT-S PI/2 BPSK	1	1	19.33	19.56	19.40
5M	DFT-S QPSK	1	1	19.45	19.38	19.48
		1	13	19.22	19.20	19.22
		1	23	19.24	19.25	19.17
		12	0	18.20	18.29	18.24
		12	7	19.22	19.14	19.13
		12	13	18.19	18.12	18.13
		25	0	18.25	18.25	18.24
5M	DFT-S 16QAM	1	1	18.03	18.01	18.06
5M	DFT-S 64QAM	1	1	16.75	16.69	16.67
5M	DFT-S 256QAM	1	1	14.66	14.65	14.64
5M	CP QPSK	1	1	17.82	18.02	17.89

*ERP (dBm) = Conducted Output Power (dBm) + Antenna Gain (dBi) - 2.15

7.1.5 NR n77 (3450-3550 MHz) SCS 30 kHz

Conducted Output Power (dBm)

NR Band 77						
BW	MCS Index	RB Size	RB Offset	Low	Mid	High
		Channel		631668	633334	635000
		Frequency (MHz)		3475.02	3500.01	3525
50M	DFT-S PI/2 BPSK	1	1	27.49	27.68	27.73
50M	DFT-S QPSK	1	1	27.48	27.77	27.82
		1	81	27.42	27.45	27.58
		1	160	27.36	27.48	27.53
		81	0	27.45	26.67	26.74
		81	41	27.69	27.67	27.74
		81	81	26.75	26.78	26.85
		162	0	26.71	26.59	26.84
50M	DFT-S 16QAM	1	1	26.69	26.70	26.75
50M	DFT-S 64QAM	1	1	25.27	25.38	25.42
50M	DFT-S 256QAM	1	1	23.19	23.21	23.31
50M	CP QPSK	1	1	26.23	26.28	26.30
BW	MCS Index	Channel		631334	633334	635332
		Frequency (MHz)		3470.01	3500.01	3529.98
40M	DFT-S PI/2 BPSK	1	1	27.50	27.70	27.77
40M	DFT-S QPSK	1	1	27.48	27.80	27.83
		1	53	27.40	27.45	27.61
		1	104	27.38	27.50	27.53
		50	0	27.48	26.69	26.75
		50	28	27.68	27.68	27.74
		50	56	26.71	26.79	26.85
		100	0	26.73	26.56	26.84
40M	DFT-S 16QAM	1	1	26.64	26.68	26.74
40M	DFT-S 64QAM	1	1	25.27	25.35	25.42
40M	DFT-S 256QAM	1	1	23.17	23.20	23.28
40M	CP QPSK	1	1	26.23	26.28	26.32

NR Band 77						
BW	MCS Index	Channel		630668	633334	636000
		Frequency (MHz)		3460.02	3500.01	3540
20M	DFT-S PI/2 BPSK	1	1	27.46	27.70	27.75
20M	DFT-S QPSK	1	1	27.51	27.79	27.84
		1	26	27.41	27.45	27.61
		1	49	27.37	27.47	27.57
		25	0	27.47	26.71	26.74
		25	13	27.71	27.69	27.74
		25	26	26.71	26.76	26.86
		50	0	26.71	26.58	26.81
20M	DFT-S 16QAM	1	1	26.64	26.71	26.79
20M	DFT-S 64QAM	1	1	25.27	25.38	25.44
20M	DFT-S 256QAM	1	1	23.14	23.22	23.29
20M	CP QPSK	1	1	26.19	26.25	26.32

EIRP Power (dBm)

NR Band 77						
BW	MCS Index	RB Size	RB Offset	Low	Mid	High
		Channel		631668	633334	635000
		Frequency (MHz)		3475.02	3500.01	3525
50M	DFT-S PI/2 BPSK	1	1	26.35	26.54	26.59
50M	DFT-S QPSK	1	1	26.34	26.63	26.68
		1	81	26.28	26.31	26.44
		1	160	26.22	26.34	26.39
		81	0	26.31	25.53	25.60
		81	41	26.55	26.53	26.60
		81	81	25.61	25.64	25.71
		162	0	25.57	25.45	25.70
50M	DFT-S 16QAM	1	1	25.55	25.56	25.61
50M	DFT-S 64QAM	1	1	24.13	24.24	24.28
50M	DFT-S 256QAM	1	1	22.05	22.07	22.17
50M	CP QPSK	1	1	25.09	25.14	25.16
BW	MCS Index	Channel		631334	633334	635332
		Frequency (MHz)		3470.01	3500.01	3529.98
40M	DFT-S PI/2 BPSK	1	1	26.36	26.56	26.63
40M	DFT-S QPSK	1	1	26.34	26.66	26.69
		1	53	26.26	26.31	26.47
		1	104	26.24	26.36	26.39
		50	0	26.34	25.55	25.61
		50	28	26.54	26.54	26.60
		50	56	25.57	25.65	25.71
		100	0	25.59	25.42	25.70
40M	DFT-S 16QAM	1	1	25.50	25.54	25.60
40M	DFT-S 64QAM	1	1	24.13	24.21	24.28
40M	DFT-S 256QAM	1	1	22.03	22.06	22.14
40M	CP QPSK	1	1	25.09	25.14	25.18

*EIRP (dBm) = Conducted Output Power (dBm) + Antenna Gain (dBi)

NR Band 77						
BW	MCS Index	Channel		630668	633334	636000
		Frequency (MHz)		3460.02	3500.01	3540
20M	DFT-S PI/2 BPSK	1	1	26.32	26.56	26.61
20M	DFT-S QPSK	1	1	26.37	26.65	26.70
		1	26	26.27	26.31	26.47
		1	49	26.23	26.33	26.43
		25	0	26.33	25.57	25.60
		25	13	26.57	26.55	26.60
		25	26	25.57	25.62	25.72
		50	0	25.57	25.44	25.67
20M	DFT-S 16QAM	1	1	25.50	25.57	25.65
20M	DFT-S 64QAM	1	1	24.13	24.24	24.30
20M	DFT-S 256QAM	1	1	22.00	22.08	22.15
20M	CP QPSK	1	1	25.05	25.11	25.18

*EIRP (dBm) = Conducted Output Power (dBm) + Antenna Gain (dBi)

7.1.6 NR n77 (3700-3980 MHz) SCS 30 kHz

Conducted Output Power (dBm)

NR Band 77						
BW	MCS Index	RB Size	RB Offset	Low	Mid	High
		Channel		648334	656000	663666
		Frequency (MHz)		3725.01	3840	3954.99
50M	DFT-S PI/2 BPSK	1	1	27.40	27.63	26.57
50M	DFT-S QPSK	1	1	27.50	27.79	26.74
		1	81	27.26	27.44	26.55
		1	160	26.69	26.91	26.08
		81	0	26.41	26.61	25.75
		81	41	27.05	27.30	26.42
		81	81	25.61	25.89	25.23
		162	0	26.13	26.31	25.40
50M	DFT-S 16QAM	1	1	26.57	26.72	25.72
50M	DFT-S 64QAM	1	1	25.00	25.24	24.21
50M	DFT-S 256QAM	1	1	23.08	23.24	22.19
50M	CP QPSK	1	1	25.91	26.11	25.18
BW	MCS Index	Channel		648000	656000	664000
		Frequency (MHz)		3720	3840	3960
40M	DFT-S PI/2 BPSK	1	1	27.40	27.66	26.71
40M	DFT-S QPSK	1	1	27.50	27.75	26.78
		1	53	27.14	27.34	26.71
		1	104	26.85	27.04	26.04
		50	0	26.59	26.76	25.88
		50	28	27.17	27.34	26.47
		50	56	25.62	25.91	25.24
		100	0	25.99	26.27	25.39
40M	DFT-S 16QAM	1	1	26.56	26.74	25.66
40M	DFT-S 64QAM	1	1	25.00	25.15	24.22
40M	DFT-S 256QAM	1	1	22.86	23.13	22.13
40M	CP QPSK	1	1	25.78	26.01	25.14

NR Band 77						
BW	MCS Index	Channel		647334	656000	664666
		Frequency (MHz)		3710.01	3840	3969.99
20M	DFT-S PI/2 BPSK	1	1	27.31	27.57	26.59
20M	DFT-S QPSK	1	1	27.46	27.67	26.80
		1	26	27.33	27.52	26.63
		1	49	26.74	26.99	26.07
		25	0	26.48	26.65	25.72
		25	13	27.17	27.39	26.30
		25	26	25.71	25.98	25.13
		50	0	26.13	26.39	25.42
		20M	DFT-S 16QAM	1	1	26.34
20M	DFT-S 64QAM	1	1	25.02	25.24	24.26
20M	DFT-S 256QAM	1	1	23.00	23.19	22.30
20M	CP QPSK	1	1	25.97	26.16	25.09



EIRP Power (dBm)

NR Band 77						
BW	MCS Index	RB Size	RB Offset	Low	Mid	High
		Channel		648334	656000	663666
		Frequency (MHz)		3725.01	3840	3954.99
50M	DFT-S PI/2 BPSK	1	1	26.26	26.49	25.43
50M	DFT-S QPSK	1	1	26.36	26.65	25.60
		1	81	26.12	26.30	25.41
		1	160	25.55	25.77	24.94
		81	0	25.27	25.47	24.61
		81	41	25.91	26.16	25.28
		81	81	24.47	24.75	24.09
		162	0	24.99	25.17	24.26
50M	DFT-S 16QAM	1	1	25.43	25.58	24.58
50M	DFT-S 64QAM	1	1	23.86	24.10	23.07
50M	DFT-S 256QAM	1	1	21.94	22.10	21.05
50M	CP QPSK	1	1	24.77	24.97	24.04
BW	MCS Index	Channel		648000	656000	664000
		Frequency (MHz)		3720	3840	3960
40M	DFT-S PI/2 BPSK	1	1	26.26	26.52	25.57
40M	DFT-S QPSK	1	1	26.36	26.61	25.64
		1	53	26.00	26.20	25.57
		1	104	25.71	25.90	24.90
		50	0	25.45	25.62	24.74
		50	28	26.03	26.20	25.33
		50	56	24.48	24.77	24.10
		100	0	24.85	25.13	24.25
40M	DFT-S 16QAM	1	1	25.42	25.60	24.52
40M	DFT-S 64QAM	1	1	23.86	24.01	23.08
40M	DFT-S 256QAM	1	1	21.72	21.99	20.99
40M	CP QPSK	1	1	24.64	24.87	24.00

NR Band 77						
BW	MCS Index	Channel		647334	656000	664666
		Frequency (MHz)		3710.01	3840	3969.99
20M	DFT-S PI/2 BPSK	1	1	26.17	26.43	25.45
20M	DFT-S QPSK	1	1	26.32	26.53	25.66
		1	26	26.19	26.38	25.49
		1	49	25.60	25.85	24.93
		25	0	25.34	25.51	24.58
		25	13	26.03	26.25	25.16
		25	26	24.57	24.84	23.99
		50	0	24.99	25.25	24.28
		20M	DFT-S 16QAM	1	1	25.20
20M	DFT-S 64QAM	1	1	23.88	24.10	23.12
20M	DFT-S 256QAM	1	1	21.86	22.05	21.16
20M	CP QPSK	1	1	24.83	25.02	23.95

*EIRP (dBm) = Conducted Output Power (dBm) + Antenna Gain (dBi)

7.1.7 NR n78 SCS 30 kHz

Conducted Output Power (dBm)

NR Band 78						
BW	MCS Index	RB Size	RB Offset	Low	Mid	High
		Channel		632000	633334	634666
		Frequency (MHz)		3480	3500.01	3519.99
60M	DFT-S PI/2 BPSK	1	1	27.53	27.65	27.57
60M	DFT-S QPSK	1	1	27.76	27.75	27.66
		1	81	27.12	27.05	27.09
		1	160	27.57	27.48	27.60
		81	0	26.52	26.54	26.44
		81	41	27.30	27.27	27.14
		81	81	26.30	26.33	26.44
		162	0	26.35	26.24	26.32
60M	DFT-S 16QAM	1	1	26.70	26.66	26.72
60M	DFT-S 64QAM	1	1	25.17	25.28	25.20
60M	DFT-S 256QAM	1	1	23.26	23.14	23.09
60M	CP QPSK	1	1	26.18	26.18	26.12
BW	MCS Index	Channel		631668	633334	635000
		Frequency (MHz)		3475.02	3500.01	3525
50M	DFT-S PI/2 BPSK	1	1	27.62	27.71	27.59
50M	DFT-S QPSK	1	1	27.59	27.67	27.73
		1	67	27.05	27.05	27.15
		1	131	27.43	27.59	27.58
		64	0	26.38	26.51	26.42
		64	35	27.27	27.31	27.18
		64	69	26.41	26.28	26.46
		128	0	26.37	26.29	26.24
50M	DFT-S 16QAM	1	1	26.70	26.61	26.74
50M	DFT-S 64QAM	1	1	25.26	25.17	25.22
50M	DFT-S 256QAM	1	1	23.18	23.20	23.12
50M	CP QPSK	1	1	26.19	26.07	26.21

NR Band 78						
BW	MCS Index	RB Size	RB Offset	Low	Mid	High
		Channel		631334	633334	635332
		Frequency (MHz)		3470.01	3500.01	3529.98
40M	DFT-S PI/2 BPSK	1	1	27.60	27.70	27.70
40M	DFT-S QPSK	1	1	27.78	27.73	27.77
		1	53	27.08	27.01	27.07
		1	104	27.47	27.43	27.60
		50	0	26.45	26.44	26.46
		50	28	27.13	27.28	27.28
		50	56	26.35	26.31	26.40
		100	0	26.23	26.24	26.36
		40M	DFT-S 16QAM	1	1	26.62
40M	DFT-S 64QAM	1	1	25.15	25.10	25.22
40M	DFT-S 256QAM	1	1	23.18	23.12	23.21
40M	CP QPSK	1	1	26.11	26.10	26.09
BW	MCS Index	RB Size	RB Offset	Low	Mid	High
		Channel		631000	633334	635666
		Frequency (MHz)		3465	3500.01	3534.99
30M	DFT-S PI/2 BPSK	1	1	27.54	27.62	27.57
30M	DFT-S QPSK	1	1	27.79	27.75	27.61
		1	26	26.98	27.08	27.06
		1	49	27.51	27.59	27.50
		25	0	26.34	26.39	26.52
		25	13	27.32	27.22	27.25
		25	26	26.33	26.41	26.41
		50	0	26.34	26.32	26.32
		30M	DFT-S 16QAM	1	1	26.61
30M	DFT-S 64QAM	1	1	25.24	25.20	25.22
30M	DFT-S 256QAM	1	1	23.25	23.26	23.14
30M	CP QPSK	1	1	26.09	26.22	26.15



NR Band 78						
BW	MCS Index	RB Size	RB Offset	Low	Mid	High
		Channel		630668	633334	636000
		Frequency (MHz)		3460.02	3500.01	3540
20M	DFT-S PI/2 BPSK	1	1	27.62	27.53	27.63
20M	DFT-S QPSK	1	1	27.61	27.76	27.65
		1	26	26.99	26.97	27.14
		1	49	27.45	27.49	27.48
		25	0	26.51	26.37	26.49
		25	13	27.13	27.26	27.24
		25	26	26.40	26.43	26.42
		50	0	26.26	26.38	26.35
		20M	DFT-S 16QAM	1	1	26.68
20M	DFT-S 64QAM	1	1	25.23	25.11	25.26
20M	DFT-S 256QAM	1	1	23.26	23.12	23.23
20M	CP QPSK	1	1	26.11	26.16	26.25

EIRP Power (dBm)

NR Band 78						
BW	MCS Index	RB Size	RB Offset	Low	Mid	High
		Channel		632000	633334	634666
		Frequency (MHz)		3480	3500.01	3519.99
60M	DFT-S PI/2 BPSK	1	1	26.39	26.51	26.43
60M	DFT-S QPSK	1	1	26.62	26.61	26.52
		1	81	25.98	25.91	25.95
		1	160	26.43	26.34	26.46
		81	0	25.38	25.40	25.30
		81	41	26.16	26.13	26.00
		81	81	25.16	25.19	25.30
		162	0	25.21	25.10	25.18
60M	DFT-S 16QAM	1	1	25.56	25.52	25.58
60M	DFT-S 64QAM	1	1	24.03	24.14	24.06
60M	DFT-S 256QAM	1	1	22.12	22.00	21.95
60M	CP QPSK	1	1	25.04	25.04	24.98
BW	MCS Index	Channel		631668	633334	635000
		Frequency (MHz)		3475.02	3500.01	3525
50M	DFT-S PI/2 BPSK	1	1	26.48	26.57	26.45
50M	DFT-S QPSK	1	1	26.45	26.53	26.59
		1	67	25.91	25.91	26.01
		1	131	26.29	26.45	26.44
		64	0	25.24	25.37	25.28
		64	35	26.13	26.17	26.04
		64	69	25.27	25.14	25.32
		128	0	25.23	25.15	25.10
50M	DFT-S 16QAM	1	1	25.56	25.47	25.60
50M	DFT-S 64QAM	1	1	24.12	24.03	24.08
50M	DFT-S 256QAM	1	1	22.04	22.06	21.98
50M	CP QPSK	1	1	25.05	24.93	25.07

*EIRP (dBm) = Conducted Output Power (dBm) + Antenna Gain (dBi)

NR Band 78						
BW	MCS Index	RB Size	RB Offset	Low	Mid	High
		Channel		631334	633334	635332
		Frequency (MHz)		3470.01	3500.01	3529.98
40M	DFT-S PI/2 BPSK	1	1	26.46	26.56	26.56
40M	DFT-S QPSK	1	1	26.64	26.59	26.63
		1	53	25.94	25.87	25.93
		1	104	26.33	26.29	26.46
		50	0	25.31	25.30	25.32
		50	28	25.99	26.14	26.14
		50	56	25.21	25.17	25.26
		100	0	25.09	25.10	25.22
		40M	DFT-S 16QAM	1	1	25.48
40M	DFT-S 64QAM	1	1	24.01	23.96	24.08
40M	DFT-S 256QAM	1	1	22.04	21.98	22.07
40M	CP QPSK	1	1	24.97	24.96	24.95
BW	MCS Index	RB Size	RB Offset	Low	Mid	High
		Channel		631000	633334	635666
		Frequency (MHz)		3465	3500.01	3534.99
30M	DFT-S PI/2 BPSK	1	1	26.40	26.48	26.43
30M	DFT-S QPSK	1	1	26.65	26.61	26.47
		1	26	25.84	25.94	25.92
		1	49	26.37	26.45	26.36
		25	0	25.20	25.25	25.38
		25	13	26.18	26.08	26.11
		25	26	25.19	25.27	25.27
		50	0	25.20	25.18	25.18
		30M	DFT-S 16QAM	1	1	25.47
30M	DFT-S 64QAM	1	1	24.10	24.06	24.08
30M	DFT-S 256QAM	1	1	22.11	22.12	22.00
30M	CP QPSK	1	1	24.95	25.08	25.01

*EIRP (dBm) = Conducted Output Power (dBm) + Antenna Gain (dBi)

NR Band 78						
BW	MCS Index	RB Size	RB Offset	Low	Mid	High
		Channel		630668	633334	636000
		Frequency (MHz)		3460.02	3500.01	3540
20M	DFT-S PI/2 BPSK	1	1	26.48	26.39	26.49
20M	DFT-S QPSK	1	1	26.47	26.62	26.51
		1	26	25.85	25.83	26.00
		1	49	26.31	26.35	26.34
		25	0	25.37	25.23	25.35
		25	13	25.99	26.12	26.10
		25	26	25.26	25.29	25.28
		50	0	25.12	25.24	25.21
		20M	DFT-S 16QAM	1	1	25.54
20M	DFT-S 64QAM	1	1	24.09	23.97	24.12
20M	DFT-S 256QAM	1	1	22.12	21.98	22.09
20M	CP QPSK	1	1	24.97	25.02	25.11

*EIRP (dBm) = Conducted Output Power (dBm) + Antenna Gain (dBi)

7.2 Modulation Characteristics

Input Power:	3.85 Vdc	Environmental Conditions:	25°C, 66% RH	Tested By:	Noah Chang
--------------	----------	---------------------------	--------------	------------	------------

7.2.1 NR n2 SCS 15 kHz

NR n2 SCS 15 kHz, Channel Bandwidth: 20 MHz

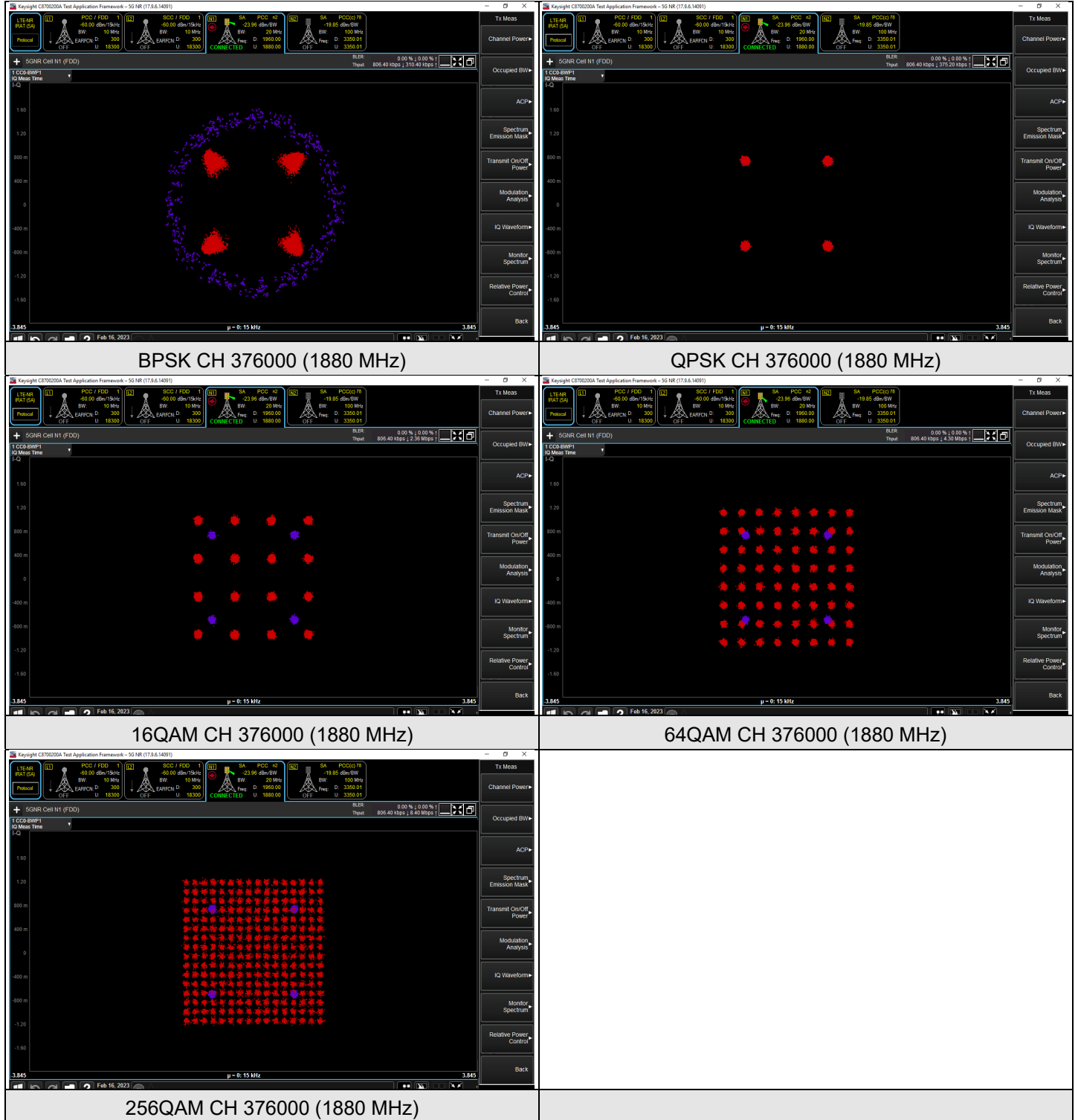

7.2.2 NR n5 SCS 15 kHz

NR n5 SCS 15 kHz, Channel Bandwidth: 20 MHz

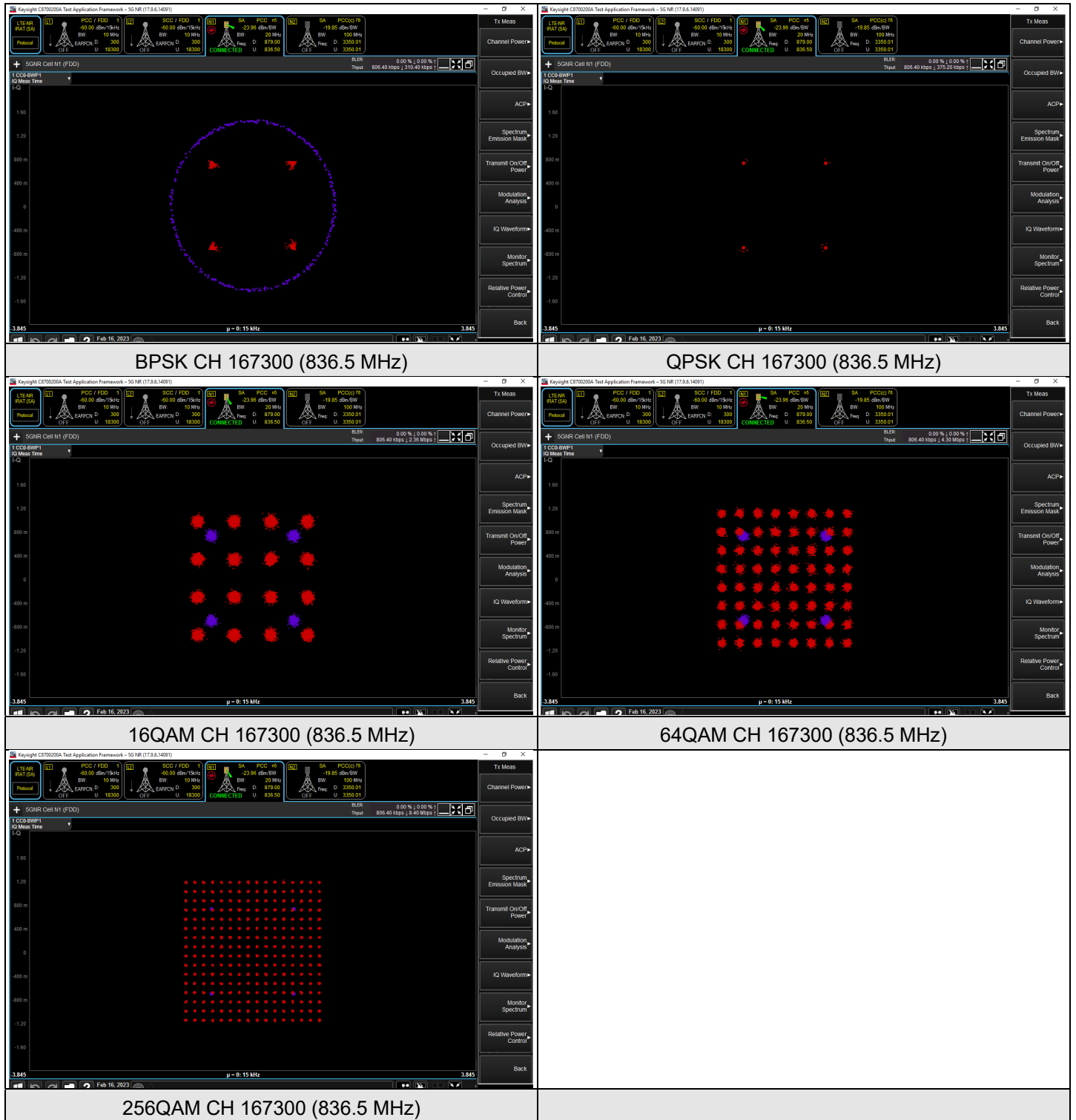

7.2.3 NR n41 SCS 30 kHz

NR n41 SCS 30 kHz, Channel Bandwidth: 100 MHz

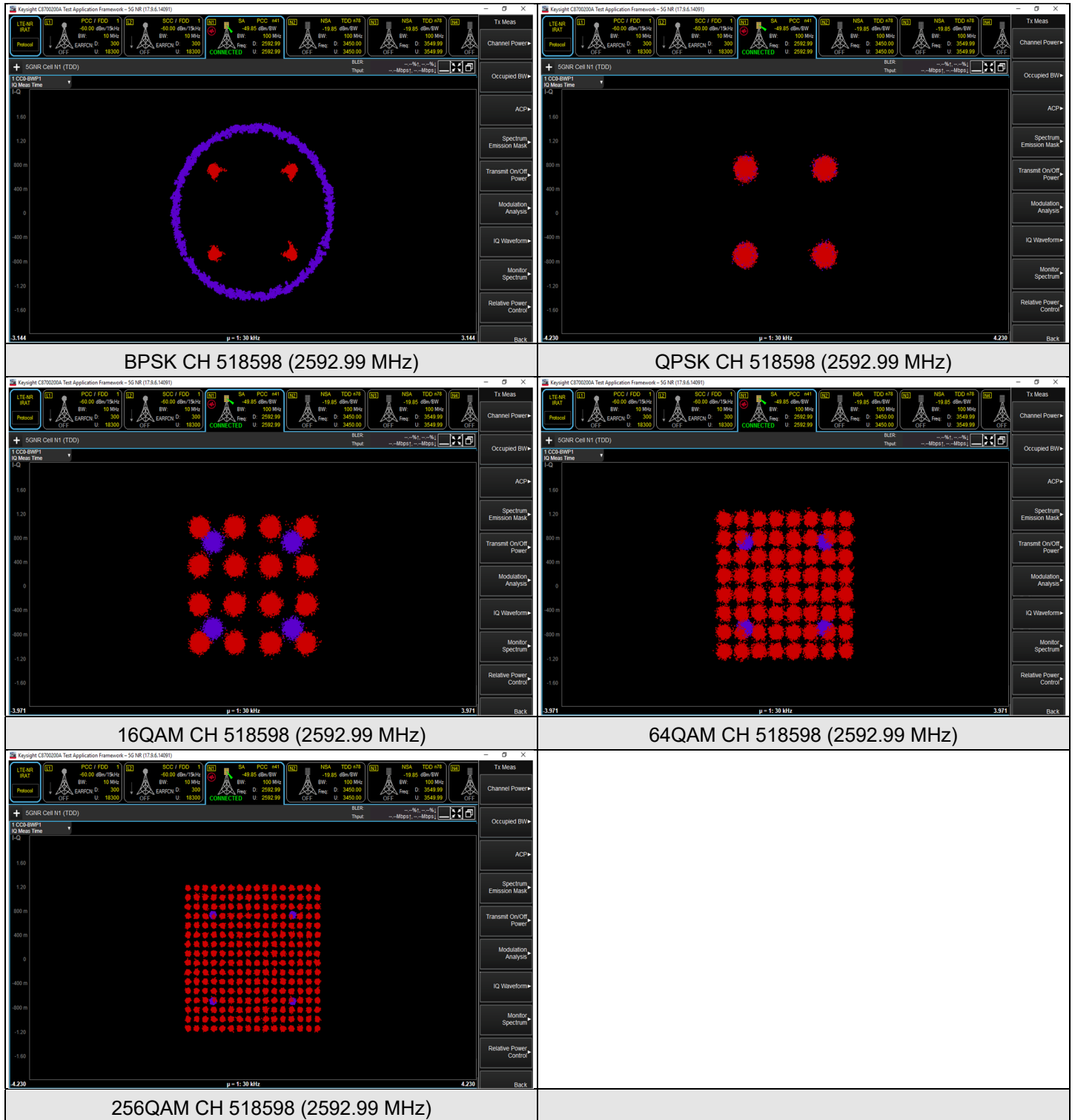

7.2.4 NR n71 SCS 15 kHz

NR n71 SCS 15 kHz, Channel Bandwidth: 20 MHz

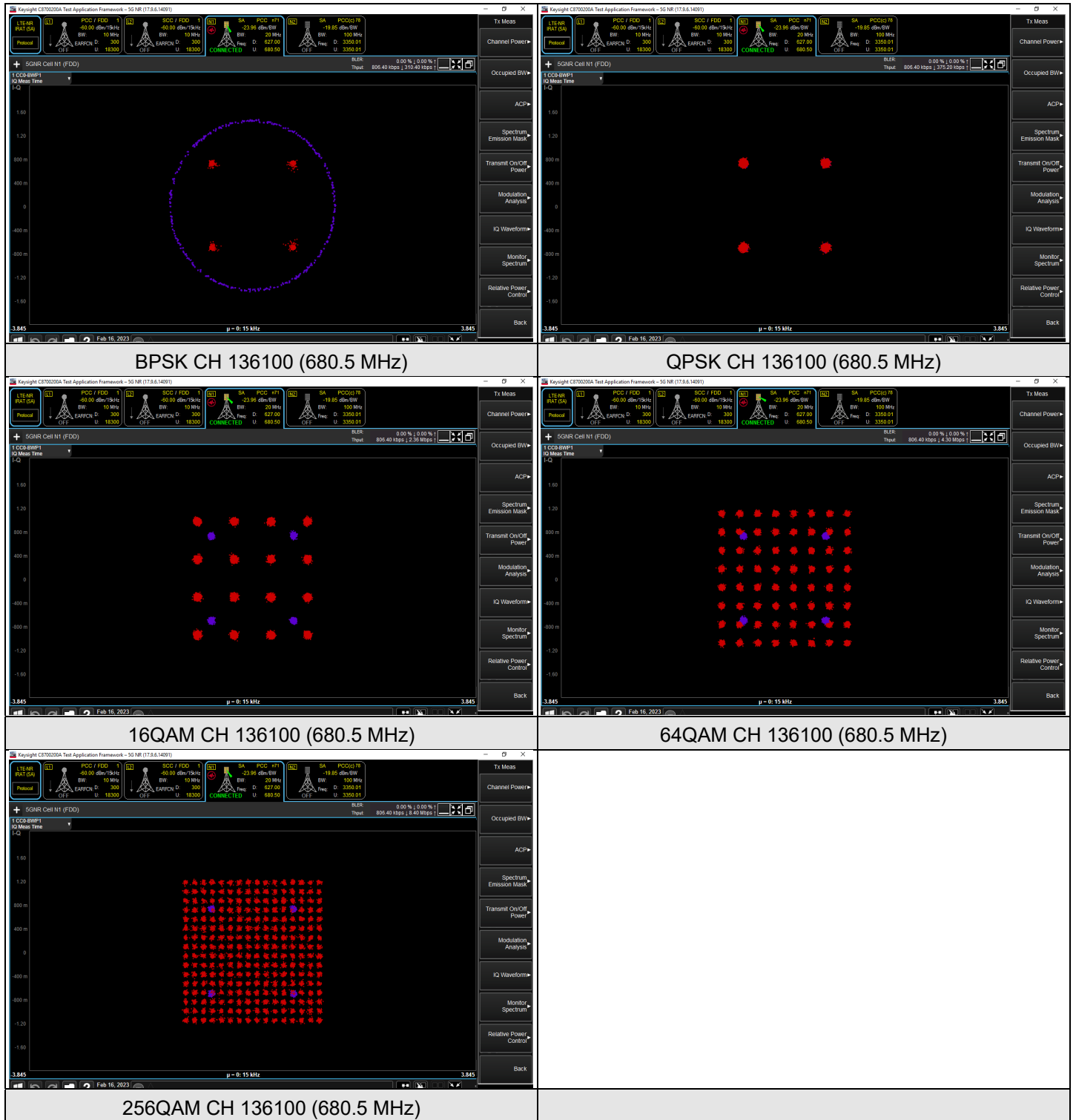

7.2.5 NR n77 (3450-3550 MHz) SCS 30 kHz

NR n77 (3450-3550 MHz) SCS 30 kHz, Channel Bandwidth: 50 MHz

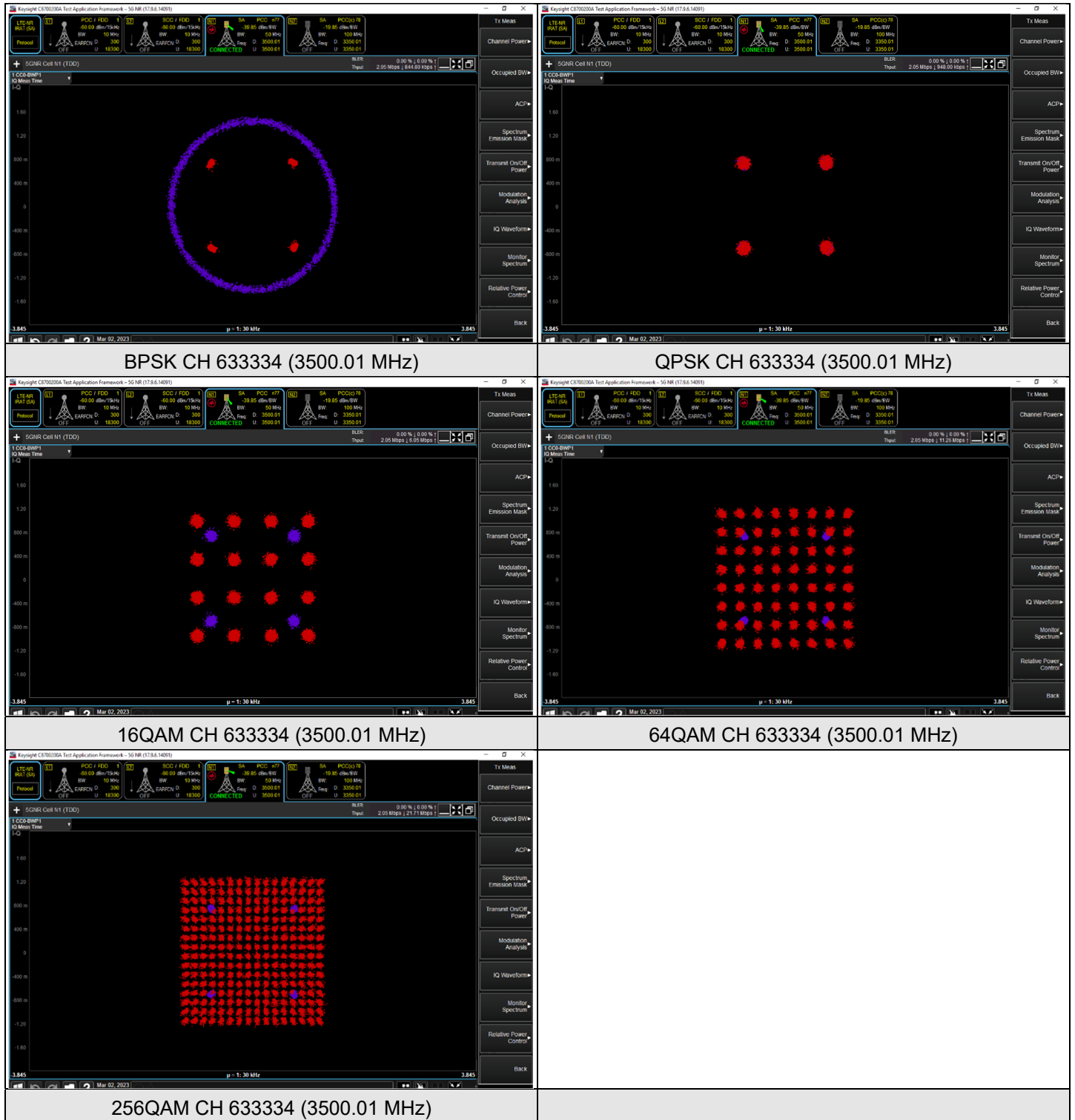

7.2.6 NR n77 (3700-3980 MHz) SCS 30 kHz

NR n77 (3700-3980 MHz) SCS 30 kHz, Channel Bandwidth: 50 MHz

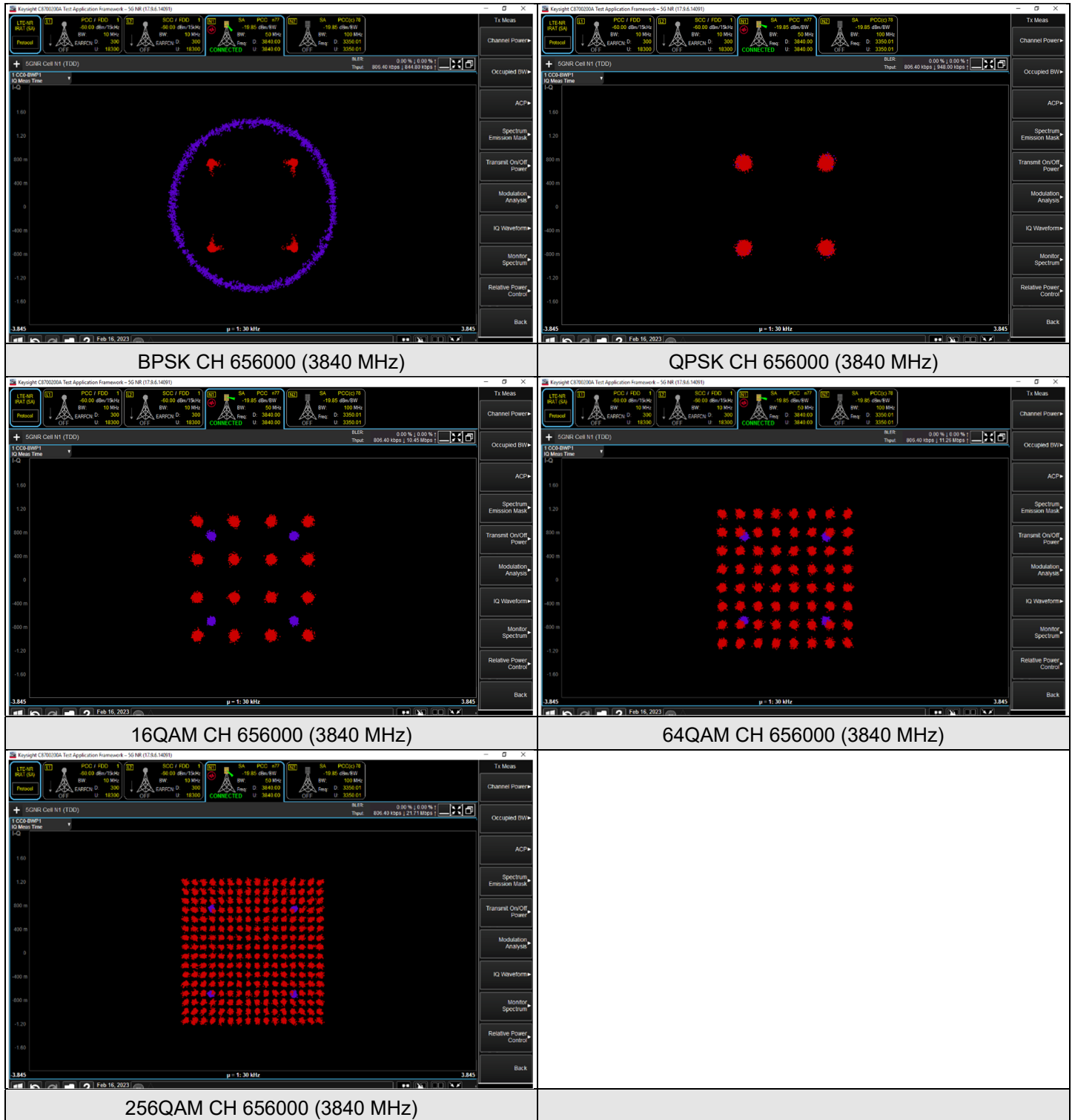

7.2.7 NR n78 SCS 30 kHz

NR n78 SCS 30 kHz, Channel Bandwidth: 60 MHz

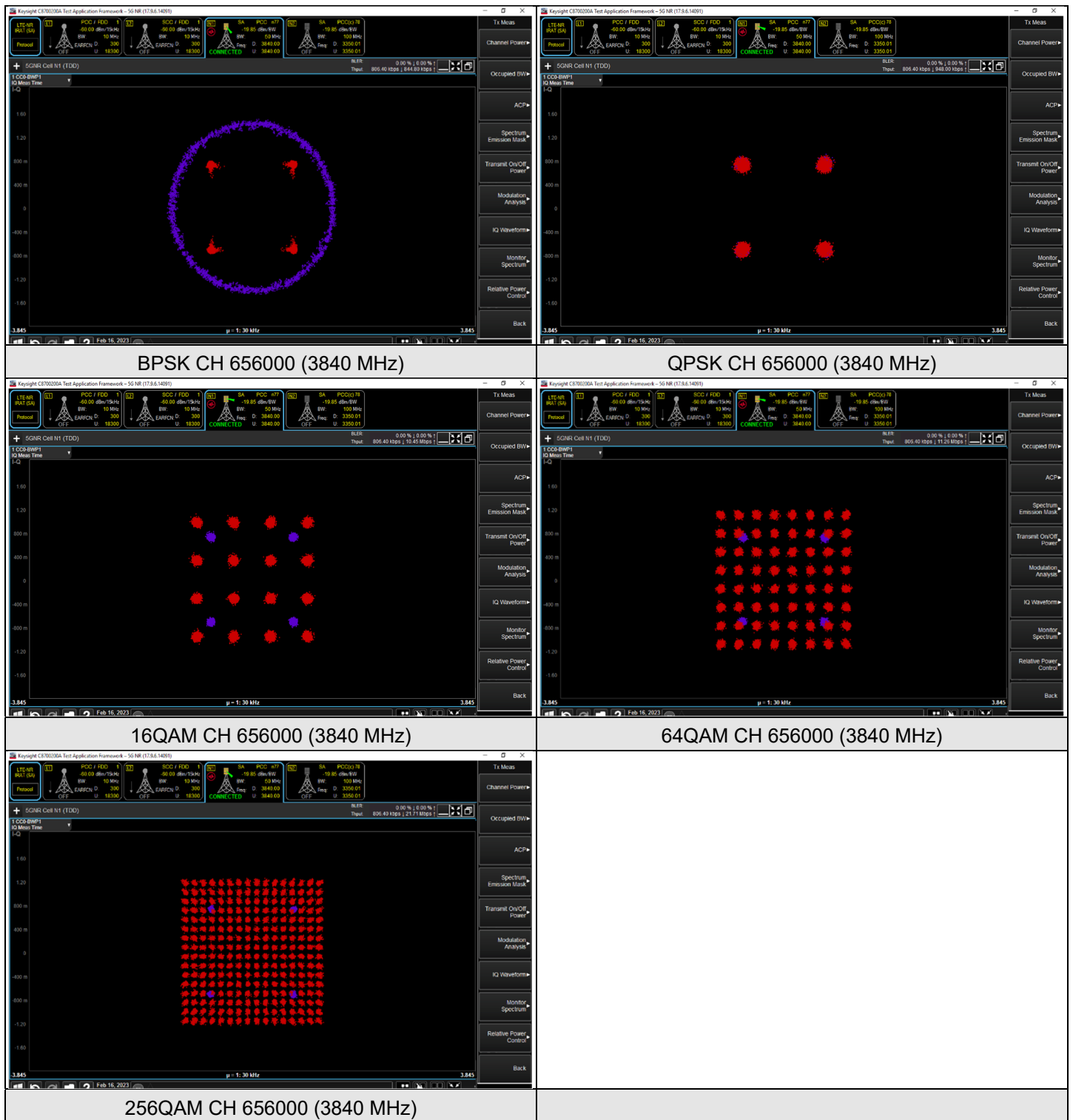

7.3 Peak to Average Ratio

Input Power:	3.85 Vdc	Environmental Conditions:	25°C, 66% RH	Tested By:	Noah Chang
--------------	----------	---------------------------	--------------	------------	------------

7.3.1 NR n2 SCS 15 kHz

NR n2 SCS 15 kHz, Channel Bandwidth: 5 MHz

Modulation	RB Size	RB Offset	Peak to Average Ratio (dB)		
			CH 370500	CH 376000	CH 381500
			1852.5 MHz	1880 MHz	1907.5 MHz
BPSK	1	24	3.27	3.46	4.15
	1	0	3.35	3.47	4.17
	25	0	3.25	3.43	4.14
QPSK	1	24	6.96	6.28	6.88
	1	0	7.05	6.30	6.98
	25	0	6.96	6.26	6.90
16QAM	1	24	6.15	6.48	6.79
	1	0	6.20	6.50	6.88
	25	0	6.19	6.48	6.82
64QAM	1	24	7.19	6.87	7.33
	1	0	7.21	6.91	7.49
	25	0	7.20	6.77	7.38
256QAM	1	24	8.16	8.22	7.73
	1	0	8.19	8.24	7.80
	25	0	8.08	8.13	7.75

Spectrum Plot of Worst Value

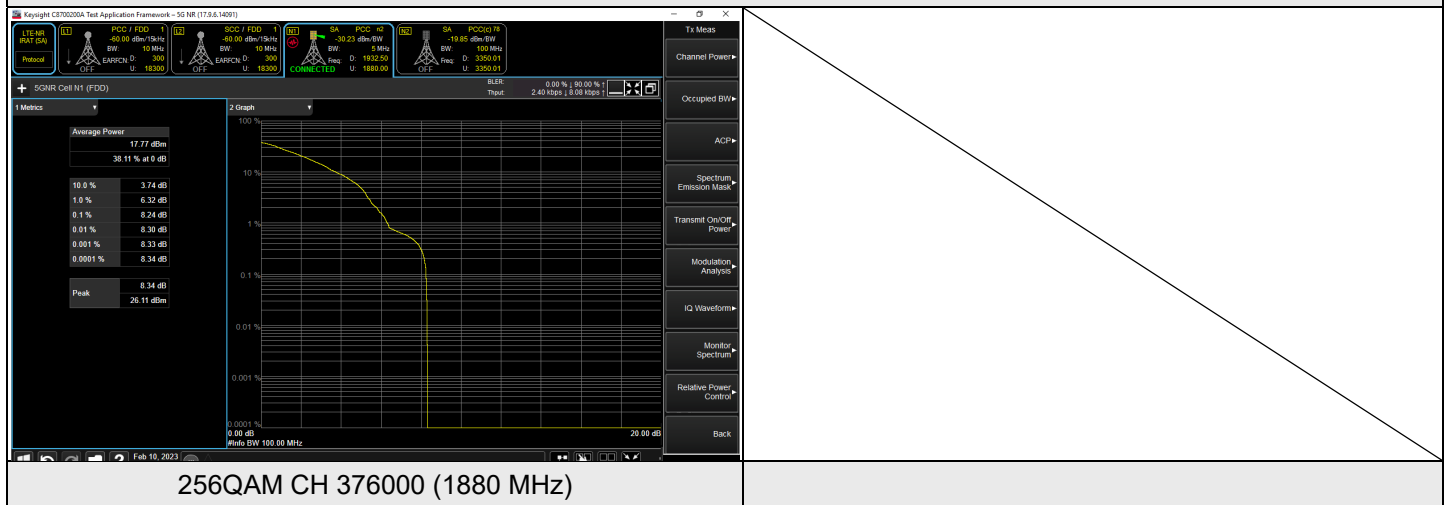

NR n2 SCS 15 kHz, Channel Bandwidth: 10 MHz

Modulation	RB Size	RB Offset	Peak to Average Ratio (dB)		
			CH 371000	CH 376000	CH 381000
			1855 MHz	1880 MHz	1905 MHz
BPSK	1	51	3.25	3.55	2.84
	1	0	3.35	3.67	2.94
	50	0	3.33	3.58	2.86
QPSK	1	51	5.89	6.87	6.17
	1	0	5.90	6.90	6.19
	52	0	5.83	6.88	6.07
16QAM	1	51	6.12	6.62	5.39
	1	0	6.19	6.68	5.48
	52	0	6.11	6.59	5.37
64QAM	1	51	6.69	7.04	6.58
	1	0	6.73	7.05	6.61
	52	0	6.62	7.00	6.55
256QAM	1	51	7.62	7.98	7.84
	1	0	7.73	8.02	7.90
	52	0	7.65	7.95	7.82

Spectrum Plot of Worst Value

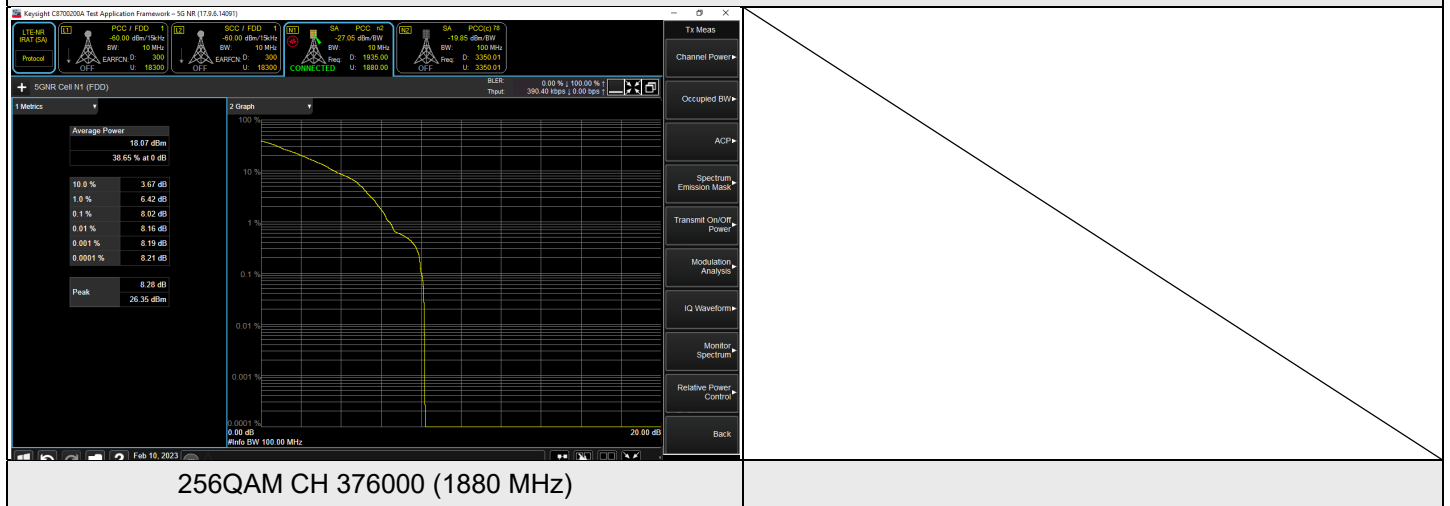

NR n2 SCS 15 kHz, Channel Bandwidth: 15 MHz

Modulation	RB Size	RB Offset	Peak to Average Ratio (dB)		
			CH 371500	CH 376000	CH 380500
			1857.5 MHz	1880 MHz	1902.5 MHz
BPSK	1	78	4.20	3.85	3.25
	1	0	4.30	3.95	3.36
	75	0	4.13	3.89	3.28
QPSK	1	78	6.57	6.28	6.00
	1	0	6.68	6.36	6.07
	79	0	6.58	6.26	6.03
16QAM	1	78	6.63	6.69	5.97
	1	0	6.74	6.76	6.01
	79	0	6.66	6.67	5.96
64QAM	1	78	6.96	7.20	5.97
	1	0	7.07	7.25	6.04
	79	0	7.02	7.15	5.87
256QAM	1	78	8.51	6.94	7.38
	1	0	8.52	6.99	7.42
	79	0	8.47	6.97	7.34

Spectrum Plot of Worst Value

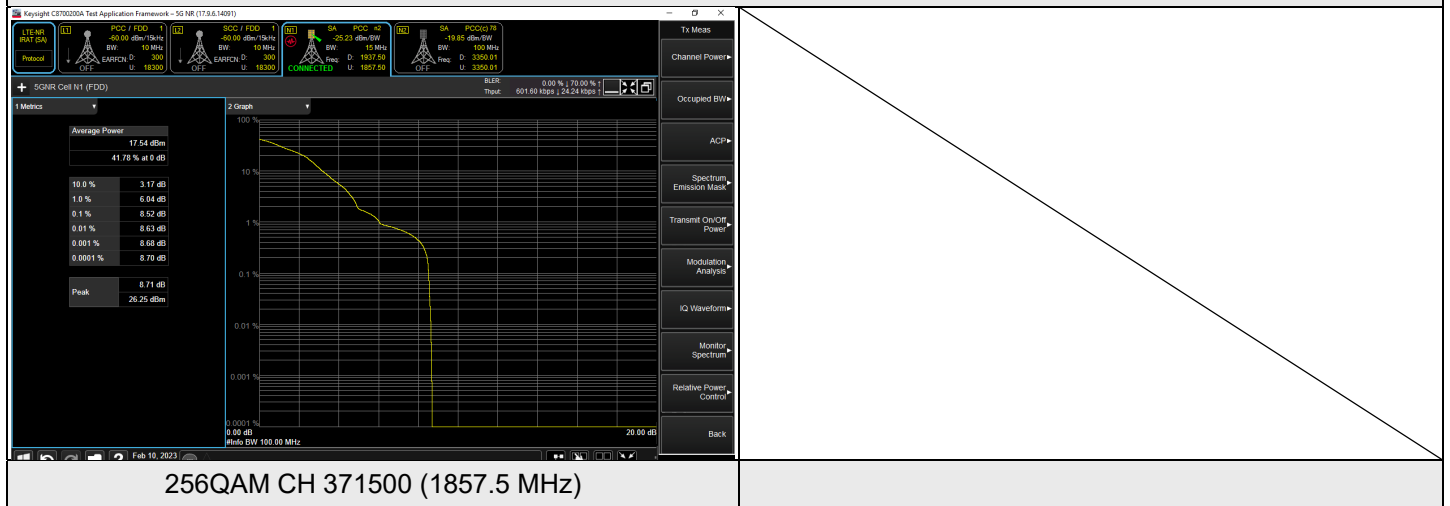

NR n2 SCS 15 kHz, Channel Bandwidth: 20 MHz

Modulation	RB Size	RB Offset	Peak to Average Ratio (dB)		
			CH 372000	CH 376000	CH 380000
			1860 MHz	1880 MHz	1900 MHz
BPSK	1	105	3.64	3.25	3.55
	1	0	3.72	3.29	3.63
	100	0	3.48	3.21	3.44
QPSK	1	105	7.06	6.21	6.12
	1	0	7.09	6.71	6.45
	106	0	7.04	6.66	6.11
16QAM	1	105	6.77	6.31	6.96
	1	0	6.95	6.42	7.01
	106	0	6.60	6.35	6.92
64QAM	1	105	6.72	6.38	6.33
	1	0	6.83	6.67	6.63
	106	0	6.77	6.31	6.29
256QAM	1	105	7.65	7.44	7.42
	1	0	7.70	7.77	7.63
	106	0	7.42	7.30	7.57

Spectrum Plot of Worst Value

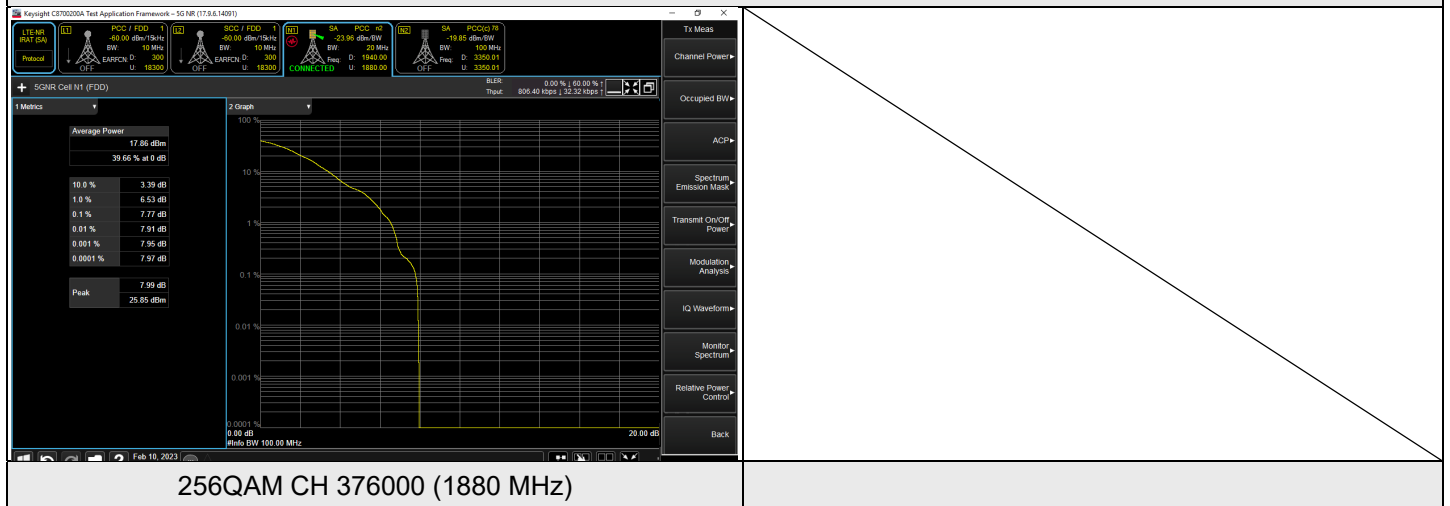

7.3.2 NR n5 SCS 15 kHz

NR n5 SCS 15 kHz, Channel Bandwidth: 5 MHz

Modulation	RB Size	RB Offset	Peak to Average Ratio (dB)		
			CH 165300	CH 167300	CH 169300
			826.5 MHz	836.5 MHz	846.5 MHz
BPSK	1	24	3.58	3.56	3.61
	1	0	3.74	3.63	3.96
	25	0	3.45	3.44	3.54
QPSK	1	24	5.50	6.19	6.67
	1	0	5.72	6.31	6.98
	25	0	5.41	6.28	6.52
16QAM	1	24	6.19	6.02	6.17
	1	0	6.37	6.36	6.54
	25	0	6.23	6.13	6.21
64QAM	1	24	6.09	6.08	6.38
	1	0	6.19	6.19	6.54
	25	0	6.12	5.97	6.42
256QAM	1	24	6.74	7.41	8.06
	1	0	6.80	7.56	8.34
	25	0	6.68	7.34	8.14

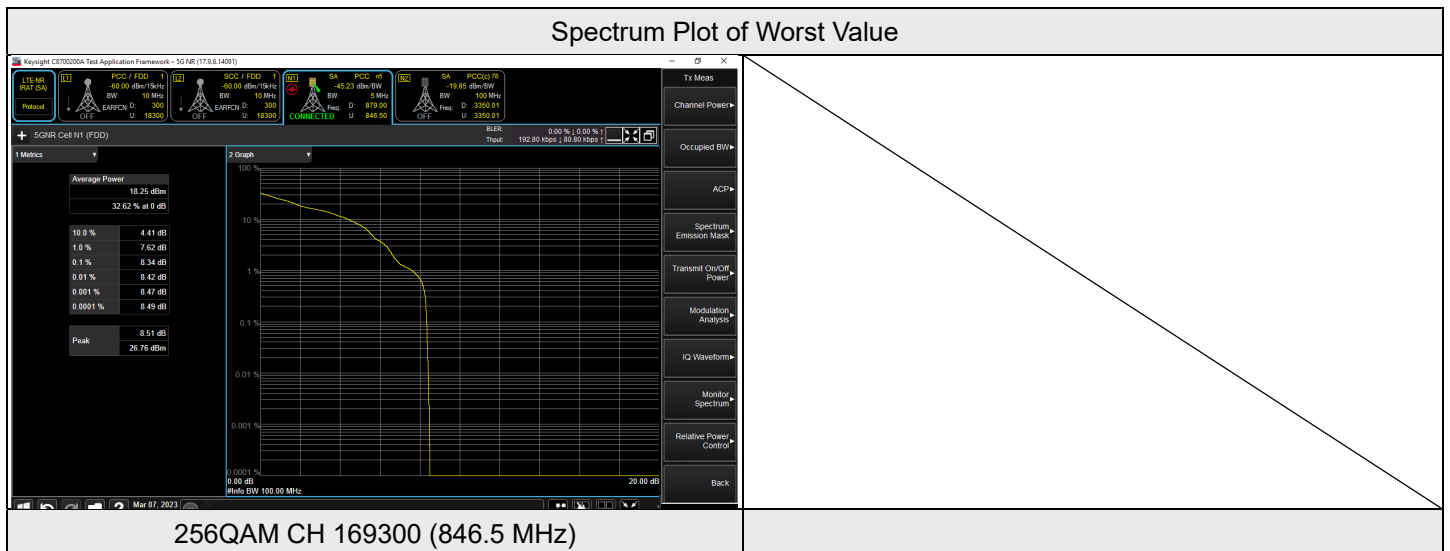

NR n5 SCS 15 kHz, Channel Bandwidth: 10 MHz

Modulation	RB Size	RB Offset	Peak to Average Ratio (dB)		
			CH 165800	CH 167300	CH 168800
			829 MHz	836.5 MHz	844 MHz
BPSK	1	51	4.03	3.14	3.19
	1	0	4.11	3.21	3.33
	50	0	3.91	3.09	3.22
QPSK	1	51	6.07	5.49	6.57
	1	0	6.18	5.85	6.65
	52	0	6.12	5.34	6.44
16QAM	1	51	6.09	6.55	5.92
	1	0	6.20	6.70	6.14
	52	0	6.15	6.63	6.02
64QAM	1	51	6.21	6.24	6.35
	1	0	6.41	6.65	6.37
	52	0	6.30	6.28	6.31
256QAM	1	51	8.12	8.50	8.05
	1	0	8.49	8.76	8.19
	52	0	8.09	8.63	8.12

Spectrum Plot of Worst Value

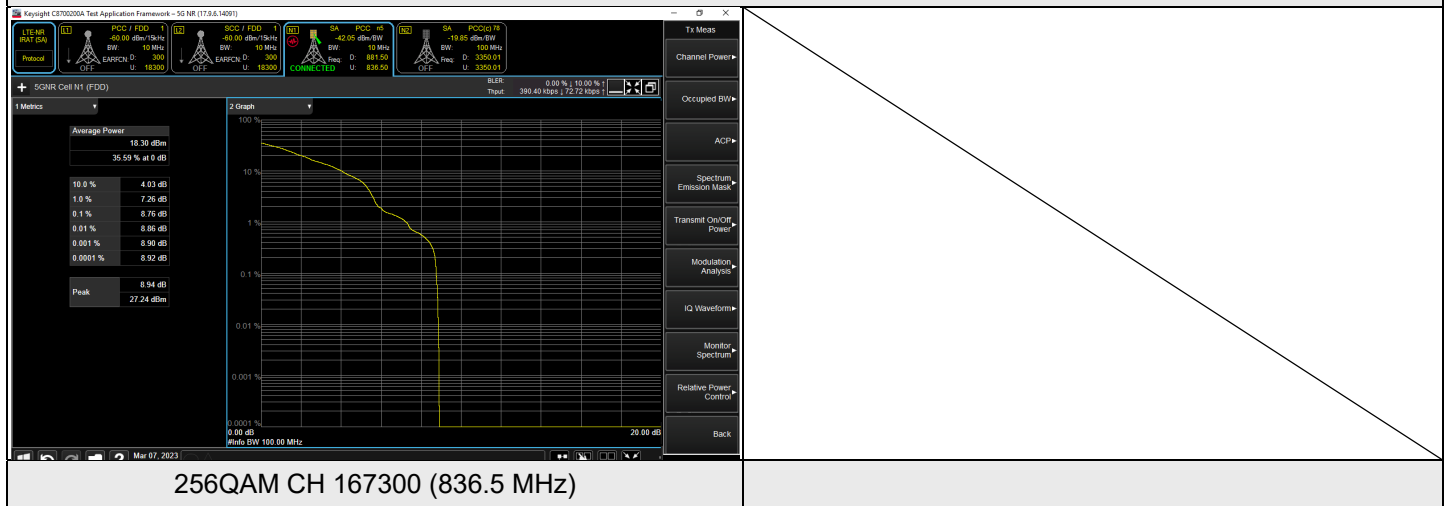

NR n5 SCS 15 kHz, Channel Bandwidth: 15 MHz

Modulation	RB Size	RB Offset	Peak to Average Ratio (dB)		
			CH 166300	CH 167300	CH 168300
			831.5 MHz	836.5 MHz	841.5 MHz
BPSK	1	78	3.42	3.29	3.61
	1	0	3.47	3.45	3.64
	75	0	3.27	3.31	3.58
QPSK	1	78	5.90	6.80	5.90
	1	0	6.09	7.01	5.98
	79	0	5.95	6.95	5.82
16QAM	1	78	6.57	6.85	6.22
	1	0	6.63	6.96	6.33
	79	0	6.47	6.76	6.30
64QAM	1	78	6.64	6.96	6.13
	1	0	6.71	7.05	6.46
	79	0	6.50	6.85	6.22
256QAM	1	78	8.72	7.72	8.26
	1	0	8.97	7.90	8.44
	79	0	8.84	7.82	8.35

Spectrum Plot of Worst Value

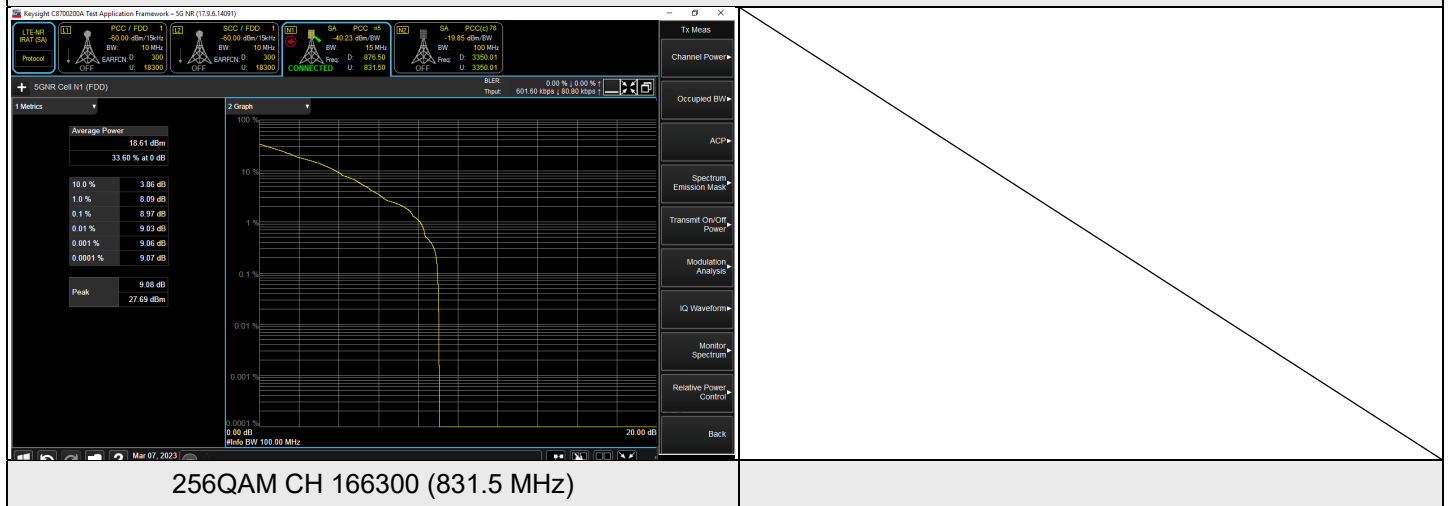

NR n5 SCS 15 kHz, Channel Bandwidth: 20 MHz

Modulation	RB Size	RB Offset	Peak to Average Ratio (dB)		
			CH 166800	CH 167300	CH 167800
			834 MHz	836.5 MHz	839 MHz
BPSK	1	105	3.54	3.59	3.09
	1	0	3.73	3.88	3.39
	100	0	3.61	3.42	3.12
QPSK	1	106	5.87	6.11	6.69
	1	0	6.10	6.61	6.89
	106	0	5.81	6.58	6.78
16QAM	1	106	6.10	6.75	6.47
	1	0	6.39	6.91	6.57
	106	0	6.06	6.84	6.39
64QAM	1	106	6.87	7.32	6.47
	1	0	6.89	7.38	6.67
	106	0	6.75	7.15	6.55
256QAM	1	106	8.01	8.13	7.42
	1	0	8.12	8.24	7.54
	106	0	7.95	8.08	7.50

Spectrum Plot of Worst Value

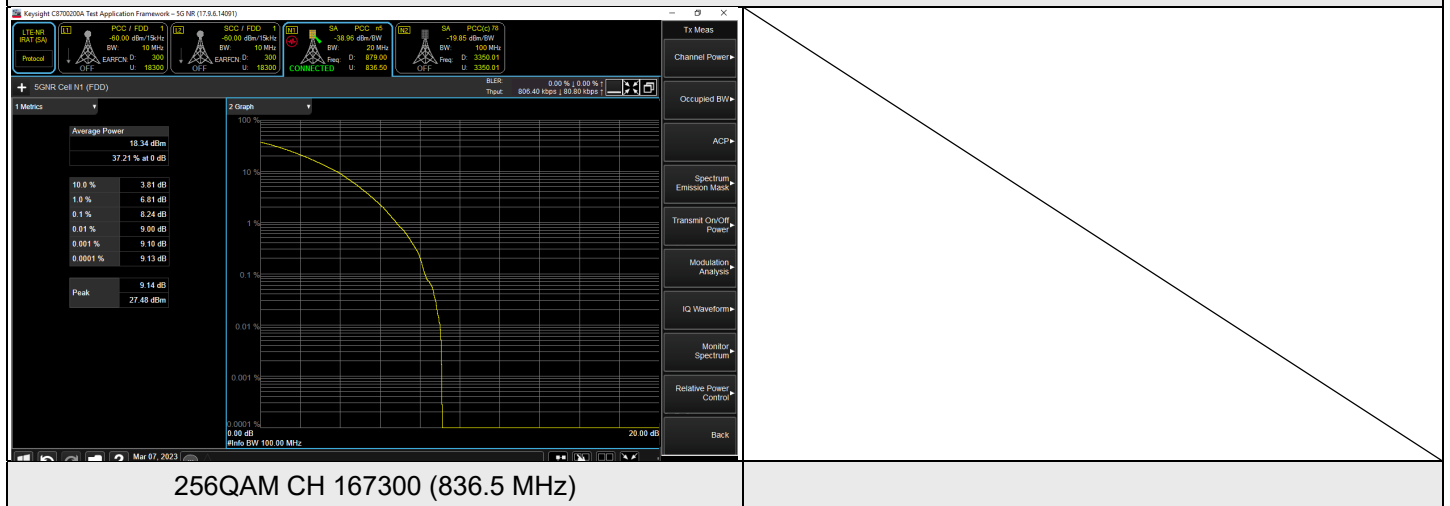

7.3.3 NR n41 SCS 30 kHz

NR n41 SCS 30 kHz, Channel Bandwidth: 20 MHz

Modulation	RB Size	RB Offset	Peak to Average Ratio (dB)		
			CH 501204	CH 518598	CH 535998
			2506.02 MHz	2592.99 MHz	2679.99 MHz
BPSK	1	50	3.8	4.14	3.89
	1	0	3.82	4.16	3.97
	50	0	3.78	4.15	3.85
QPSK	1	50	5.16	4.81	6.01
	1	0	5.17	4.91	6.07
	51	0	5.08	4.78	6.01
16QAM	1	50	5.12	5.9	5.54
	1	0	5.15	5.99	5.65
	51	0	5.12	5.89	5.52
64QAM	1	50	6.22	5.53	5.42
	1	0	6.24	5.62	5.54
	51	0	6.11	5.55	5.53
256QAM	1	50	7.89	7.72	7.95
	1	0	8.01	7.75	7.97
	51	0	7.93	7.74	7.84

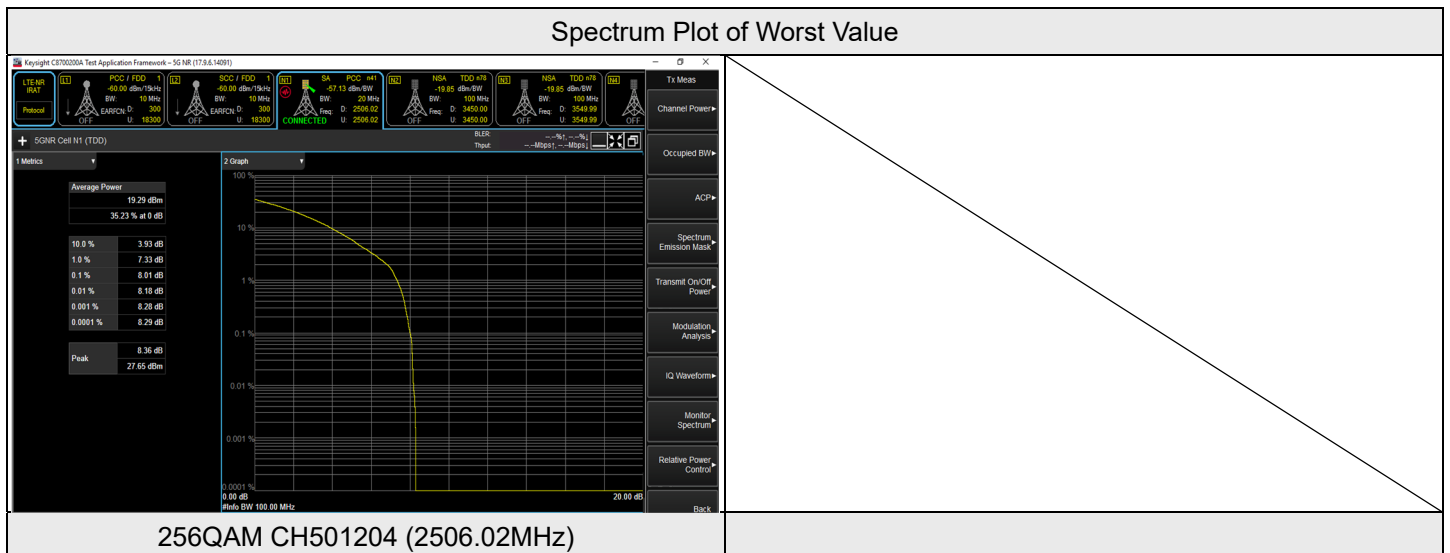

NR n41 SCS 30 kHz, Channel Bandwidth: 40 MHz

Modulation	RB Size	RB Offset	Peak to Average Ratio (dB)		
			CH 503202	CH 518598	CH 534000
			2516.01MHz	2592.99MHz	2670MHz
BPSK	1	105	3.88	3.21	3.27
	1	0	3.98	3.24	3.36
	100	0	3.89	3.17	3.34
QPSK	1	105	5.77	5.52	4.8
	1	0	5.79	5.59	4.81
	106	0	5.77	5.53	4.68
16QAM	1	105	5.77	5.68	4.63
	1	0	5.83	5.7	4.72
	106	0	5.8	5.64	4.66
64QAM	1	105	5.78	5.24	4.69
	1	0	5.81	5.25	4.75
	106	0	5.73	5.16	4.74
256QAM	1	105	7.84	7.51	7.95
	1	0	7.9	7.63	7.98
	106	0	7.85	7.53	7.85

Spectrum Plot of Worst Value

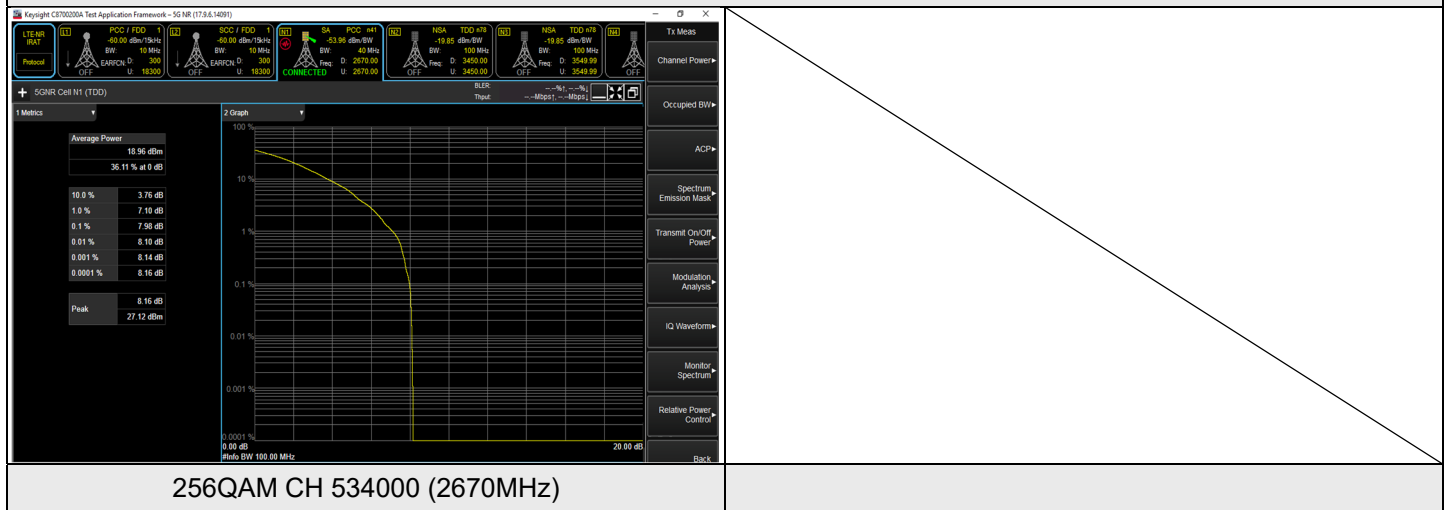

NR n41 SCS 30 kHz, Channel Bandwidth: 50 MHz

Modulation	RB Size	RB Offset	Peak to Average Ratio (dB)		
			CH 504204	CH 518598	CH 532998
			2521.02 MHz	2592.99 MHz	2664.99 MHz
BPSK	1	132	3.51	3.45	3.56
	1	0	3.58	3.48	3.6
	128	0	3.5	3.38	3.53
QPSK	1	132	5.98	5.63	5.98
	1	0	6.03	5.67	6.08
	133	0	5.97	5.55	6.01
16QAM	1	132	5.68	5.48	5.62
	1	0	5.77	5.5	5.72
	133	0	5.67	5.48	5.66
64QAM	1	132	5.67	5.54	5.63
	1	0	5.72	5.63	5.7
	133	0	5.6	5.51	5.66
256QAM	1	132	7.92	7.64	7.91
	1	0	7.97	7.7	8.03
	133	0	7.92	7.63	7.9

Spectrum Plot of Worst Value

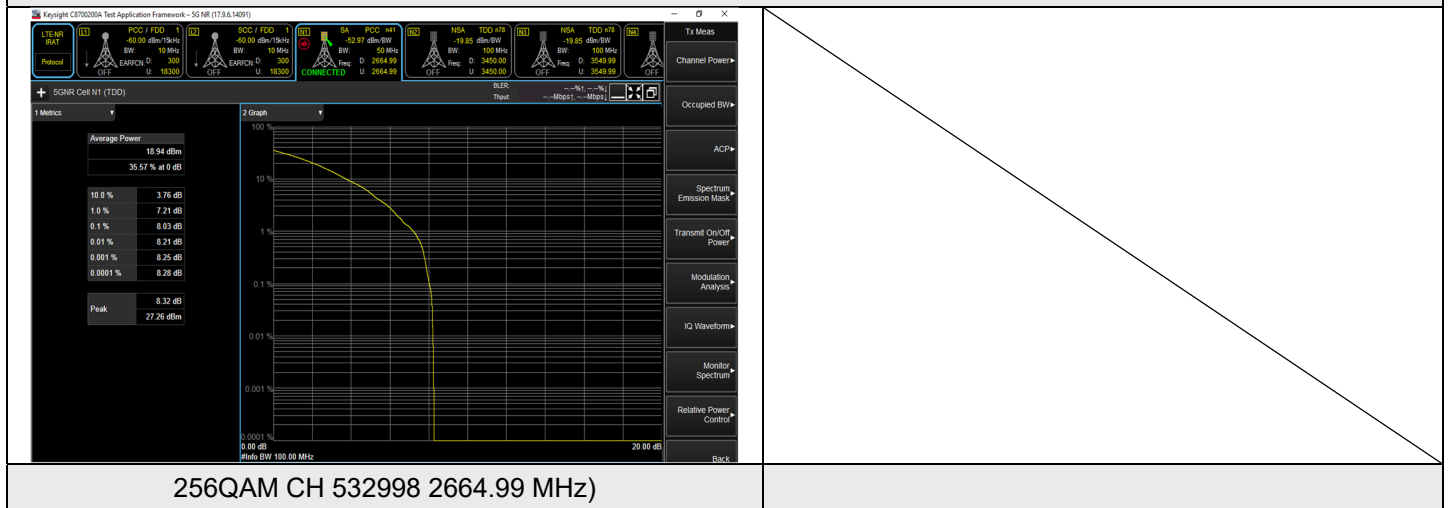

256QAM CH 532998 2664.99 MHz)

