

FCC Test Report

Report No.: RF170926C17

FCC ID: S9E-121300

Test Model: 121300

Received Date: Sep. 26, 2017

Test Date: Oct. 24, 2017 ~ Nov. 03, 2017

Issued Date: Nov. 16, 2017

Applicant: Trimble Navigation Limited

Address: 345 SW Avery Ave Corvallis, Oregon, United States, 97333

Issued By: Bureau Veritas Consumer Products Services (H.K.) Ltd., Taoyuan Branch

Lab Address: No. 47-2, 14th Ling, Chia Pau Vil., Lin Kou Dist., New Taipei City, Taiwan
(R.O.C)

Test Location (1): No.19, Hwa Ya 2nd Rd., Wen Hwa Vil., Kwei Shan Dist., Taoyuan City
33383, Taiwan, R.O.C.

Test Location (2): No.215, Sec. 3, Beixin Rd., Xindian Dist., New Taipei City 231, Taiwan,
R.O.C



This report is for your exclusive use. Any copying or replication of this report to or for any other person or entity, or use of our name or trademark, is permitted only with our prior written permission. This report sets forth our findings solely with respect to the test samples identified herein. The results set forth in this report are not indicative or representative of the quality or characteristics of the lot from which a test sample was taken or any similar or identical product unless specifically and expressly noted. Our report includes all of the tests requested by you and the results thereof based upon the information that you provided to us. You have 60 days from date of issuance of this report to notify us of any material error or omission caused by our negligence, provided, however, that such notice shall be in writing and shall specifically address the issue you wish to raise. A failure to raise such issue within the prescribed time shall constitute your unqualified acceptance of the completeness of this report, the tests conducted and the correctness of the report contents. Unless specific mention, the uncertainty of measurement has been explicitly taken into account to declare the compliance or non-compliance to the specification.

Table of Contents

Release Control Record	4
1 Certificate of Conformity	5
2 Summary of Test Results	6
2.1 Measurement Uncertainty	6
2.2 Modification Record	6
3 General Information	7
3.1 General Description of EUT	7
3.2 Description of Test Modes	8
3.2.1 Test Mode Applicability and Tested Channel Detail	9
3.3 Duty Cycle of Test Signal	11
3.4 Description of Support Units	12
3.4.1 Configuration of System under Test	12
3.5 General Description of Applied Standards	12
4 Test Types and Results	13
4.1 Radiated Emission and Bandedge Measurement	13
4.1.1 Limits of Radiated Emission and Bandedge Measurement	13
4.1.2 Test Instruments	14
4.1.3 Test Procedures	15
4.1.4 Deviation from Test Standard	15
4.1.5 Test Set Up	16
4.1.6 EUT Operating Conditions	17
4.1.7 Test Results	18
4.2 Conducted Emission Measurement	31
4.2.1 Limits of Conducted Emission Measurement	31
4.2.2 Test Instruments	31
4.2.3 Test Procedures	32
4.2.4 Deviation from Test Standard	32
4.2.5 Test Setup	32
4.2.6 EUT Operating Conditions	32
4.2.7 Test Results	33
4.3 6 dB Bandwidth Measurement	35
4.3.1 Limits of 6 dB Bandwidth Measurement	35
4.3.2 Test Setup	35
4.3.3 Test Instruments	35
4.3.4 Test Procedure	35
4.3.5 Deviation from Test Standard	35
4.3.6 EUT Operating Conditions	35
4.3.7 Test Result	36
4.4 Occupied Bandwidth Measurement	38
4.4.1 Test Setup	38
4.4.2 Test Instruments	38
4.4.3 Test Procedure	38
4.4.4 Deviation from Test Standard	38
4.4.5 EUT Operating Conditions	38
4.4.6 Test Results	39
4.5 Conducted Output Power Measurement	41
4.5.1 Limits of Conducted Output Power Measurement	41
4.5.2 Test Setup	41
4.5.3 Test Instruments	41
4.5.4 Test Procedures	41
4.5.5 Deviation from Test Standard	41
4.5.6 EUT Operating Conditions	41
4.5.7 Test Results	42

4.6	Power Spectral Density Measurement	43
4.6.1	Limits of Power Spectral Density Measurement.....	43
4.6.2	Test Setup.....	43
4.6.3	Test Instruments	43
4.6.4	Test Procedure	43
4.6.5	Deviation from Test Standard	43
4.6.6	EUT Operating Condition	43
4.6.7	Test Results	44
4.7	Conducted Out of Band Emission Measurement	46
4.7.1	Limits of Conducted Out of Band Emission Measurement.....	46
4.7.2	Test Setup.....	46
4.7.3	Test Instruments	46
4.7.4	Test Procedure	46
4.7.5	Deviation from Test Standard	46
4.7.6	EUT Operating Condition	46
4.7.7	Test Results	47
5	Pictures of Test Arrangements.....	59
	Appendix – Information on the Testing Laboratories	60

Release Control Record

Issue No.	Description	Date Issued
RF170926C17	Original Release	Nov. 16, 2017

1 Certificate of Conformity

Product: Handheld PC

Brand: Trimble

Test Model: 121300

Applicant: Trimble Navigation Limited

Test Date: Oct. 24, 2017 ~ Nov. 03, 2017

Standards: 47 CFR FCC Part 15, Subpart C (Section 15.247)
ANSI C63.10:2013

The above equipment has been tested by **Bureau Veritas Consumer Products Services (H.K.) Ltd., Taoyuan Branch**, and found compliance with the requirement of the above standards. The test record, data evaluation & Equipment Under Test (EUT) configurations represented herein are true and accurate accounts of the measurements of the sample's EMC characteristics under the conditions specified in this report.

Prepared by : Rona Chen , **Date:** Nov. 16, 2017
Rona Chen / Specialist

Approved by : Dylan Chiou , **Date:** Nov. 16, 2017
Dylan Chiou / Project Engineer

2 Summary of Test Results

47 CFR FCC Part 15, Subpart C (Section 15.247)			
FCC Clause	Test Item	Result	Remarks
15.207	AC Power Conducted Emission	Pass	Meet the requirement of limit. Minimum passing margin is -20.46 dB at 2.84008 MHz.
15.205 / 15.209 / 15.247(d)	Radiated Emissions and Band Edge Measurement	Pass	Meet the requirement of limit. Minimum passing margin is -1.01 dB at 4874 MHz.
15.247(d)	Antenna Port Emission	Pass	Meet the requirement of limit.
15.247(a)(2)	6 dB Bandwidth	Pass	Meet the requirement of limit.
---	Occupied Bandwidth Measurement	Pass	Reference only
15.247(b)	Conducted power	Pass	Meet the requirement of limit.
15.247(e)	Power Spectral Density	Pass	Meet the requirement of limit.
15.203	Antenna Requirement	Pass	Antenna connector is I-pex.

2.1 Measurement Uncertainty

Where relevant, the following measurement uncertainty levels have been estimated for tests performed on the EUT:

The listed uncertainties are the worst case uncertainty for the entire range of measurement. Please note that the uncertainty values are provided for informational purposes only and are not used in determining the PASS/FAIL results.

Measurement	Frequency	Expanded Uncertainty (k=2) (\pm)
Conducted Emissions at mains ports	150 kHz ~ 30 MHz	2.44 dB
Radiated Emissions up to 1 GHz	30 MHz ~ 200 MHz	2.0153 dB
	200 MHz ~ 1000 MHz	2.0224 dB
Radiated Emissions above 1 GHz	1 GHz ~ 18 GHz	1.0121 dB
	18 GHz ~ 40 GHz	1.1508 dB

2.2 Modification Record

There were no modifications required for compliance.

3 General Information

3.1 General Description of EUT

Product	Handheld PC	
Brand	Trimble	
Test Model	121300	
Power Supply Rating	19.0 Vdc (Adapter) 7.27 Vdc (Li-ion battery)	
Modulation Type	CCK, DQPSK, DBPSK for DSSS 64QAM, 16QAM, QPSK, BPSK for OFDM	
Modulation Technology	DSSS, OFDM	
Transfer Rate	802.11b: 11.0 / 5.5 / 2.0 / 1.0 Mbps 802.11g: 54.0 / 48.0 / 36.0 / 24.0 / 18.0 / 12.0 / 9.0 / 6.0 Mbps 802.11n: up to MCS7	
Operating Frequency	2412 ~ 2462 MHz	
Number of Channel	11 for 802.11b, 802.11g, 802.11n (HT20) 7 for 802.11n (HT40)	
Output Power	507.075 mW	
Antenna Type	PIFA antenna with	1.44 dBi gain (Main) -1.98 dBi gain (Aux.)
Antenna Connector	I-pex	
Accessory Device	Refer to Note as below	
Data Cable Supplied	Refer to Note as below	

Note:

- The EUT incorporates a MIMO function. Physically, the EUT provides two completed transmitters and two receivers.

Modulation Mode	Tx Function
802.11b	1TX
802.11g	1TX
802.11n (HT20)	2TX
802.11n (HT40)	2TX

- The EUT contains following accessory devices.

Product	Brand	Model	Description
Adapter	DELTA ELECTRONICS, INC.	ADP-90MD H	I/P: 100-240 Vac, 50-60 Hz, 1.5 A O/P: 19 Vdc, 4.74 A
Battery	Trimble	121300	3.27 Vdc, 3150 mAh, 22.9 Wh
BT/WLAN Module	Qualcomm Atheros	QCNFA364A	--

- The above EUT information is declared by manufacturer and for more detailed features description, please refer to the manufacturer's specifications or user's manual.

3.2 Description of Test Modes

11 channels are provided for 802.11b, 802.11g and 802.11n (HT20):

Channel	Frequency (MHz)	Channel	Frequency (MHz)
1	2412	7	2442
2	2417	8	2447
3	2422	9	2452
4	2427	10	2457
5	2432	11	2462
6	2437		

7 channels are provided for 802.11n (HT40):

Channel	Frequency (MHz)	Channel	Frequency (MHz)
3	2422	7	2442
4	2427	8	2447
5	2432	9	2452
6	2437		

3.2.1 Test Mode Applicability and Tested Channel Detail

EUT Configure Mode	Applicable To				Description
	RE \geq 1G	RE<1G	PLC	APCM	
A	√	√	√	√	SISO
B	√	-	-	√	MIMO

Where **RE \geq 1G**: Radiated Emission above 1 GHz **RE<1G**: Radiated Emission below 1 GHz
PLC: Power Line Conducted Emission **APCM**: Antenna Port Conducted Measurement

NOTE: 1. The EUT had been pre-tested on the positioned of each 3 axis. The worst case was found when positioned on **X-plane**.
2. "-" means no effect.

Radiated Emission Test (Above 1 GHz):

- Pre-Scan has been conducted to determine the worst-case mode from all possible combinations between available modulations, data rates and antenna ports (if EUT with antenna diversity architecture).
- Following channel(s) was (were) selected for the final test as listed below.

EUT Configure Mode	Mode	Available Channel	Tested Channel	Modulation Technology	Modulation Type	Data Rate (Mbps)
A	802.11b	1 to 11	1, 6, 11	DSSS	DBPSK	1.0
	802.11g	1 to 11	1, 6, 11	OFDM	BPSK	6.0
B	802.11n (HT20)	1 to 11	1, 6, 11	OFDM	BPSK	MCS0
	802.11n (HT40)	3 to 9	3, 6, 9	OFDM	BPSK	MCS0

Radiated Emission Test (Below 1 GHz):

- Pre-Scan has been conducted to determine the worst-case mode from all possible combinations between available modulations, data rates and antenna ports (if EUT with antenna diversity architecture).
- Following channel(s) was (were) selected for the final test as listed below.

EUT Configure Mode	Mode	Available Channel	Tested Channel	Modulation Technology	Modulation Type	Data Rate (Mbps)
A	802.11b	1 to 11	6	DSSS	DBPSK	1.0

Power Line Conducted Emission Test:

- Pre-Scan has been conducted to determine the worst-case mode from all possible combinations between available modulations, data rates and antenna ports (if EUT with antenna diversity architecture).
- Following channel(s) was (were) selected for the final test as listed below.

EUT Configure Mode	Mode	Available Channel	Tested Channel	Modulation Technology	Modulation Type	Data Rate (Mbps)
A	802.11b	1 to 11	6	DSSS	DBPSK	1.0

Bandedge Measurement:

- Pre-Scan has been conducted to determine the worst-case mode from all possible combinations between available modulations, data rates and antenna ports (if EUT with antenna diversity architecture).
- Following channel(s) was (were) selected for the final test as listed below.

EUT Configure Mode	Mode	Available Channel	Tested Channel	Modulation Technology	Modulation Type	Data Rate (Mbps)
A	802.11b	1 to 11	1, 11	DSSS	DBPSK	1.0
	802.11g	1 to 11	1, 11	OFDM	BPSK	6.0
B	802.11n (HT20)	1 to 11	1, 11	OFDM	BPSK	MCS0
	802.11n (HT40)	3 to 9	3, 9	OFDM	BPSK	MCS0

Antenna Port Conducted Measurement:

- This item includes all test value of each mode, but only includes spectrum plot of worst value of each mode.
- Pre-Scan has been conducted to determine the worst-case mode from all possible combinations between available modulations, data rates and antenna ports (if EUT with antenna diversity architecture).
- Following channel(s) was (were) selected for the final test as listed below.

EUT Configure Mode	Mode	Available Channel	Tested Channel	Modulation Technology	Modulation Type	Data Rate (Mbps)
A	802.11b	1 to 11	1, 6, 11	DSSS	DBPSK	1.0
	802.11g	1 to 11	1, 6, 11	OFDM	BPSK	6.0
B	802.11n (HT20)	1 to 11	1, 6, 11	OFDM	BPSK	MCS0
	802.11n (HT40)	3 to 9	3, 6, 9	OFDM	BPSK	MCS0

Test Condition:

Applicable To	Environmental Conditions	Input Power	Tested by
RE≥1G	25 deg. C, 65 % RH	120 Vac, 60 Hz	Charles Hsiao
RE<1G	25 deg. C, 65 % RH	120 Vac, 60 Hz	Charles Hsiao
PLC	25 deg. C, 65 % RH	120 Vac, 60 Hz	Getaz Yang
APCM	25 deg. C, 65 % RH	7.27 Vdc	Luke Chen

3.3 Duty Cycle of Test Signal

Mode A

802.11b: Duty cycle of test signal is 100 %, duty factor is not required.

802.11g: Duty cycle = $2.062/2.261 = 0.912$, Duty factor = $10 * \log(1/0.912) = 0.40$

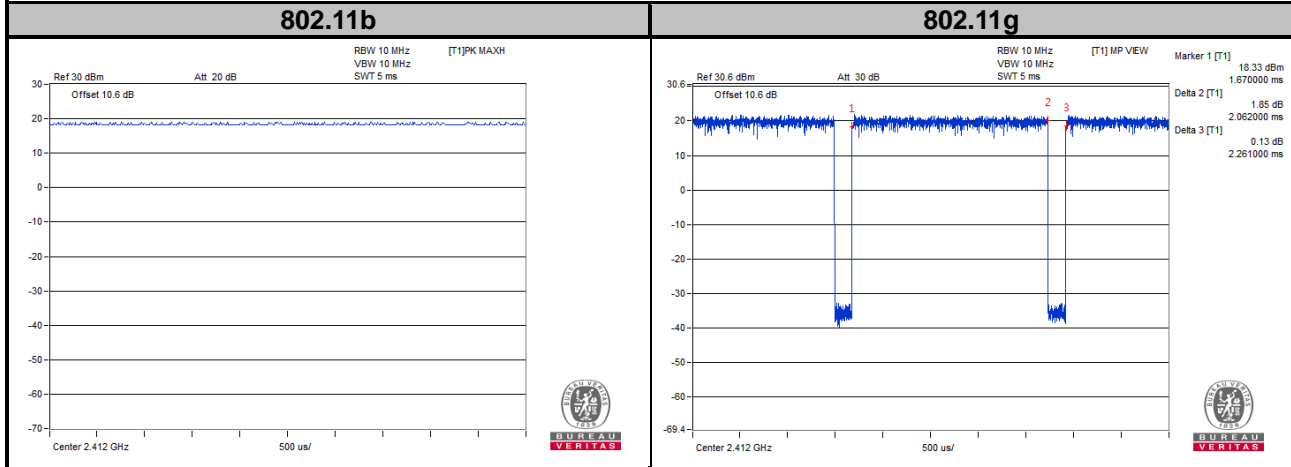

Mode B

802.11n (HT20): Duty cycle = $1.737/1.954 = 0.889$, Duty factor = $10 * \log(1/0.889) = 0.51$

802.11n (HT40): Duty cycle = $0.855/1.060 = 0.807$, Duty factor = $10 * \log(1/0.807) = 0.93$

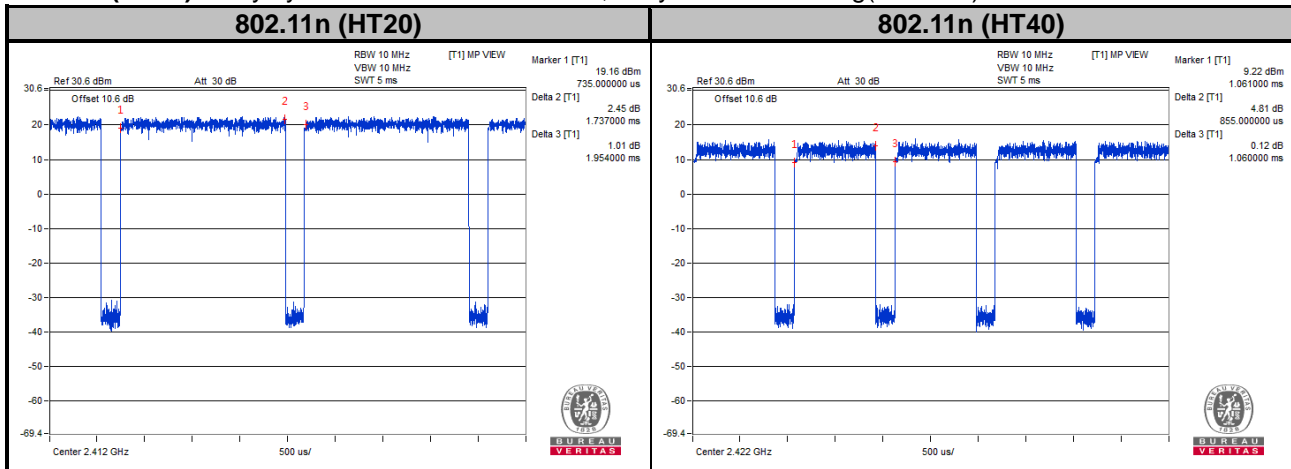

3.4 Description of Support Units

The EUT has been tested as an independent unit together with other necessary accessories or support units.

3.4.1 Configuration of System under Test

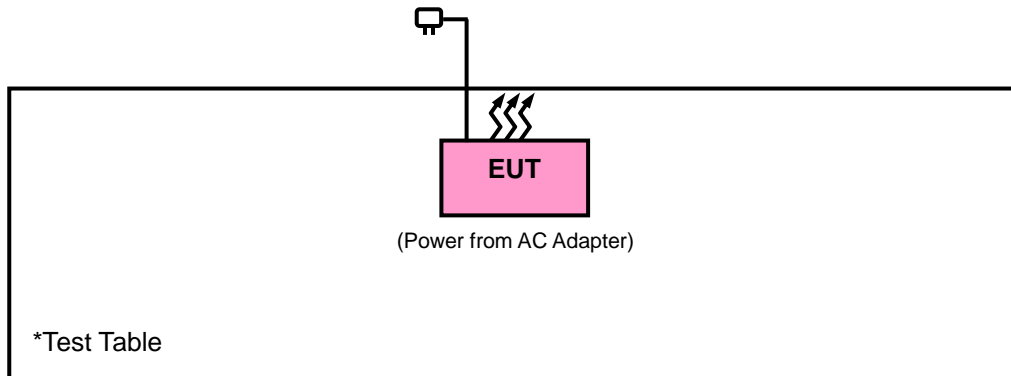

3.5 General Description of Applied Standards

The EUT is a RF Product. According to the specifications of the manufacturer, it must comply with the requirements of the following standards:

FCC Part 15, Subpart C (15.247)

558074 D01 DTS Meas Guidance v04

662911 D01 Multiple Transmitter Output v02r01

ANSI C63.10-2013

All test items have been performed and recorded as per the above standards.

NOTE: The EUT has been verified to comply with the requirements of FCC Part 15, Subpart B, Class B (DoC).
The test report has been issued separately.

4 Test Types and Results

4.1 Radiated Emission and Bandedge Measurement

4.1.1 Limits of Radiated Emission and Bandedge Measurement

Radiated emissions which fall in the restricted bands must comply with the radiated emission limits specified as below table. Other emissions shall be at least 20 dB below the highest level of the desired power:

Frequencies (MHz)	Field Strength (microvolts/meter)	Measurement Distance (meters)
0.009 ~ 0.490	2400/F (kHz)	300
0.490 ~ 1.705	24000/F (kHz)	30
1.705 ~ 30.0	30	30
30 ~ 88	100	3
88 ~ 216	150	3
216 ~ 960	200	3
Above 960	500	3

NOTE:

1. The lower limit shall apply at the transition frequencies.
2. Emission level (dBuV/m) = 20 log Emission level (uV/m).
3. For frequencies above 1000 MHz, the field strength limits are based on average detector, however, the peak field strength of any emission shall not exceed the maximum permitted average limits, specified above by more than 20 dB under any condition of modulation.

4.1.2 Test Instruments

Description & Manufacturer	Model No.	Serial No.	Date of Calibration	Due Date of Calibration
Test Receiver Agilent Technologies	N9038A	MY52260177	Jul. 05, 2017	Jul. 04, 2018
Spectrum Analyzer ROHDE & SCHWARZ	FSU43	101261	Dec. 13, 2016	Dec. 12, 2017
BILOG Antenna SCHWARZBECK	VULB9168	9168-472	Dec. 16, 2016	Dec. 15, 2017
HORN Antenna ETS-Lindgren	3117	00143293	Dec. 29, 2016	Dec. 28, 2017
HORN Antenna SCHWARZBECK	BBHA 9170	9170-480	Dec. 14, 2016	Dec. 13, 2017
Fixed Attenuator Mini-Circuits	MDCS18N-10	MDCS18N-10-01	Apr. 17, 2017	Apr. 16, 2018
Bluetooth Tester	CBT	100980	Jun. 28, 2017	Jun. 27, 2019
Loop Antenna	HLA 6121	45745	May 19, 2017	May 18, 2018
Preamplifier Agilent	310N	187226	Jun. 23, 2017	Jun. 22, 2018
Preamplifier Agilent	83017A	MY39501357	Jun. 23, 2017	Jun. 22, 2018
Power Meter Anritsu	ML2495A	1012010	Aug. 15, 2017	Aug. 14, 2018
Power Sensor Anritsu	MA2411B	1315050	Aug. 15, 2017	Aug. 14, 2018
RF signal cable ETS-LINDGREN	5D-FB	Cable-CH1-01(R FC-SMS-100-SM S-120+RFC-SMS -100-SMS-400)	Jun. 23, 2017	Jun. 22, 2018
RF signal cable ETS-LINDGREN	8D-FB	Cable-CH1-02(R FC-SMS-100-SM S-24)	Jun. 23, 2017	Jun. 22, 2018
Software BV ADT	E3 8.130425b	NA	NA	NA
Antenna Tower MF	NA	NA	NA	NA
Turn Table MF	NA	NA	NA	NA
Antenna Tower & Turn Table Controller MF	MF-7802	NA	NA	NA

- Note: 1. The calibration interval of the above test instruments is 12 months and the calibrations are traceable to NML/ROC and NIST/USA.
2. The test was performed in HsinTien Chamber 1.
3. The horn antenna and preamplifier (model: 83017A) are used only for the measurement of emission frequency above 1 GHz if tested.
4. The FCC Designation Number is TW0011. The number will be varied with the Lab location and scope as attached.
5. The IC Site Registration No. is IC7450I-1.

4.1.3 Test Procedures

- a. The EUT was placed on the top of a rotating table 0.8 meters (for below 1 GHz) / 1.5 meters (for above 1 GHz) above the ground at 3 meter chamber room for test. The table was rotated 360 degrees to determine the position of the highest radiation.
- b. The EUT was set 3 meters away from the interference-receiving antenna, which was mounted on the top of a variable-height antenna tower.
- c. The height of antenna is varied from one meter to four meters above the ground to determine the maximum value of the field strength. Both horizontal and vertical polarizations of the antenna are set to make the measurement.
- d. For each suspected emission, the EUT was arranged to its worst case and then the antenna was tuned to heights from 1 meter to 4 meters and the rotatable table was turned from 0 degrees to 360 degrees to find the maximum reading.
- e. The test-receiver system was set to quasi-peak detect function and specified bandwidth with maximum hold mode when the test frequency is below 1 GHz.
- f. The test-receiver system was set to peak and average detected function and specified bandwidth with maximum hold mode when the test frequency is above 1 GHz. If the peak reading value also meets average limit, measurement with the average detector is unnecessary.

Note:

1. The resolution bandwidth and video bandwidth of test receiver/spectrum analyzer is 120 kHz & 360 KHz for Quasi-peak detection (QP) at frequency below 1 GHz.
2. The resolution bandwidth of test receiver/spectrum analyzer is 1 MHz and the video bandwidth is 3 MHz for Peak detection (PK) at frequency above 1 GHz.
3. The resolution bandwidth of test receiver/spectrum analyzer is 1 MHz and the video bandwidth is 1/T for Average (Duty cycle < 98 %) detection at frequency above 1 GHz.
4. The resolution bandwidth of test receiver/spectrum analyzer is 1 MHz and the video bandwidth is 10 Hz (Duty cycle \geq 98 %) for Average detection (AV) at frequency above 1 GHz.
5. All modes of operation were investigated and the worst-case emissions are reported.

4.1.4 Deviation from Test Standard

No deviation.

4.1.5 Test Set Up

<Radiated emission below 30 MHz>

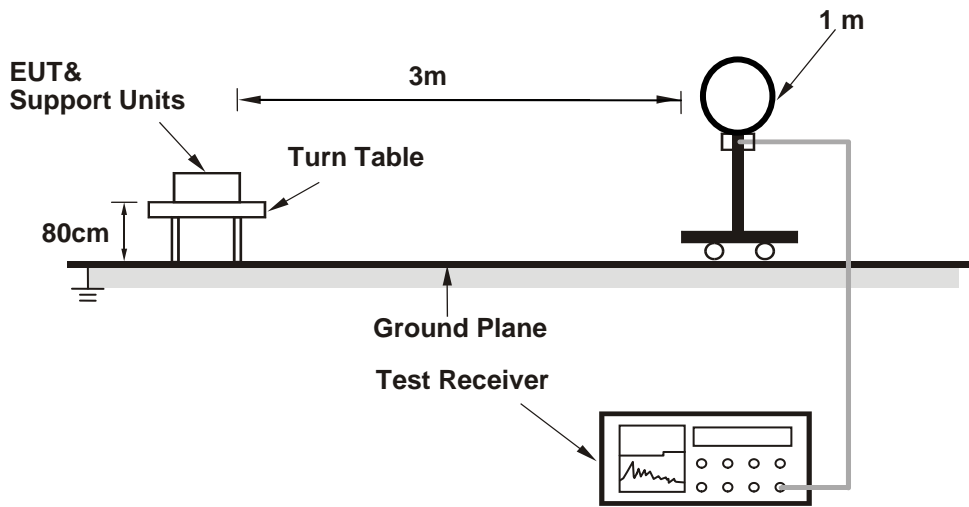

<Frequency Range below 1 GHz>

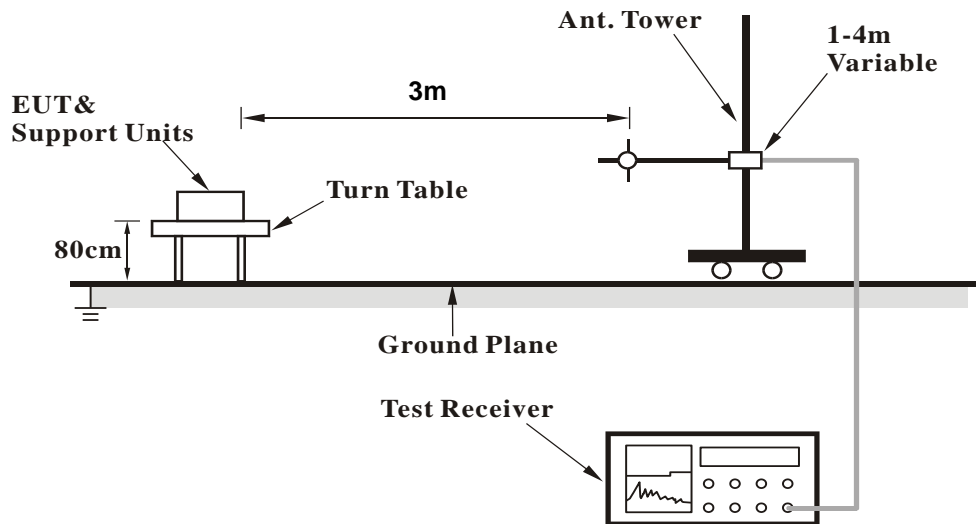

<Frequency Range above 1 GHz>

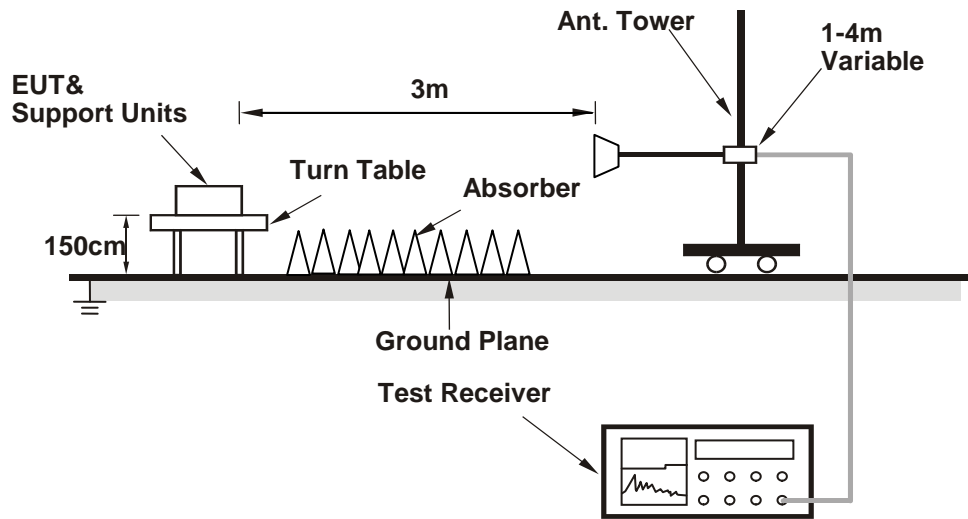

For the actual test configuration, please refer to the attached file (Test Setup Photo).

4.1.6 EUT Operating Conditions

- a. Placed the EUT on a testing table.
- b. Use the software to control the EUT under transmission condition continuously at specific channel frequency.

4.1.7 Test Results

Above 1 GHz Data :

Mode A

802.11b

EUT Test Condition		Measurement Detail	
Channel	Channel 1	Frequency Range	1 GHz ~ 25 GHz
Input Power	120 Vac, 60 Hz	Detector Function	Peak (PK) Average (AV)
Environmental Conditions	25 deg. C, 65 % RH	Tested By	Charles Hsiao

Antennal Polarity & Test Distance: Horizontal at 3 m										
Frequency (MHz)	Emission Level (dBuV/m)	Read Level (dBuV)	Limit (dBuV/m)	Margin (dB)	Antenna Factor (dB/m)	Cable Loss (dB)	Preamp Factor (dB)	Antenna Height (cm)	Table Angle (Degree)	Remark
2387.31	50.35	48.64	54	-3.65	31.8	5.4	35.49	211	117	Average
2387.31	56.72	55.01	74	-17.28	31.8	5.4	35.49	211	117	Peak
2412	109.05	107.28			31.81	5.43	35.47	192	126	Average
2412	112.68	110.91			31.81	5.43	35.47	192	126	Peak
4824	50.71	42.58	54	-3.29	33.97	8.26	34.1	100	213	Average
4824	52.63	44.5	74	-21.37	33.97	8.26	34.1	100	213	Peak
Antennal Polarity & Test Distance: Vertical at 3 m										
Frequency (MHz)	Emission Level (dBuV/m)	Read Level (dBuV)	Limit (dBuV/m)	Margin (dB)	Antenna Factor (dB/m)	Cable Loss (dB)	Preamp Factor (dB)	Antenna Height (cm)	Table Angle (Degree)	Remark
2387.31	46.18	44.47	54	-7.82	31.8	5.4	35.49	108	147	Average
2387.31	54.93	53.22	74	-19.07	31.8	5.4	35.49	108	147	Peak
2412	106.61	104.84			31.81	5.43	35.47	108	147	Average
2412	109.06	107.29			31.81	5.43	35.47	108	147	Peak
4824	52.48	44.35	54	-1.52	33.97	8.26	34.1	100	188	Average
4824	56.62	48.49	74	-17.38	33.97	8.26	34.1	100	188	Peak

Remarks:

- Emission Level = Read Level + Antenna Factor + Cable Loss - Preamp Factor
Margin value = Emission level – Limit value
- 2412 MHz: Fundamental frequency.

EUT Test Condition		Measurement Detail	
Channel	Channel 6	Frequency Range	1 GHz ~ 25 GHz
Input Power	120 Vac, 60 Hz	Detector Function	Peak (PK) Average (AV)
Environmental Conditions	25 deg. C, 65 % RH	Tested By	Charles Hsiao

Antennal Polarity & Test Distance: Horizontal at 3 m										
Frequency (MHz)	Emission Level (dBuV/m)	Read Level (dBuV)	Limit (dBuV/m)	Margin (dB)	Antenna Factor (dB/m)	Cable Loss (dB)	Preamp Factor (dB)	Antenna Height (cm)	Table Angle (Degree)	Remark
2389.65	41.59	39.88	54	-12.41	31.8	5.4	35.49	192	126	Average
2389.65	52.39	50.68	74	-21.61	31.8	5.4	35.49	192	126	Peak
2437	109.55	107.7			31.85	5.46	35.46	192	126	Average
2437	112.58	110.73			31.85	5.46	35.46	192	126	Peak
2484.24	42.58	40.59	54	-11.42	31.88	5.53	35.42	192	126	Average
2484.24	53.37	51.38	74	-20.63	31.88	5.53	35.42	192	126	Peak
4874	50.55	42.36	54	-3.45	33.98	8.27	34.06	100	213	Average
4874	53.15	44.96	74	-20.85	33.98	8.27	34.06	100	213	Peak
Antennal Polarity & Test Distance: Vertical at 3 m										
Frequency (MHz)	Emission Level (dBuV/m)	Read Level (dBuV)	Limit (dBuV/m)	Margin (dB)	Antenna Factor (dB/m)	Cable Loss (dB)	Preamp Factor (dB)	Antenna Height (cm)	Table Angle (Degree)	Remark
2388.75	40.69	38.98	54	-13.31	31.8	5.4	35.49	108	147	Average
2388.75	51.63	49.92	74	-22.37	31.8	5.4	35.49	108	147	Peak
2437	106.47	104.62			31.85	5.46	35.46	108	147	Average
2437	109.84	107.99			31.85	5.46	35.46	108	147	Peak
2492.6	41.13	39.11	54	-12.87	31.9	5.53	35.41	108	147	Average
2492.6	52.52	50.5	74	-21.48	31.9	5.53	35.41	108	147	Peak
4874	52.99	44.8	54	-1.01	33.98	8.27	34.06	100	185	Average
4874	56.04	47.85	74	-17.96	33.98	8.27	34.06	100	185	Peak

Remarks:

- Emission Level = Read Level + Antenna Factor + Cable Loss - Preamp Factor
Margin value = Emission level – Limit value
- 2437 MHz: Fundamental frequency.

EUT Test Condition		Measurement Detail	
Channel	Channel 11	Frequency Range	1 GHz ~ 25 GHz
Input Power	120 Vac, 60 Hz	Detector Function	Peak (PK) Average (AV)
Environmental Conditions	25 deg. C, 65 % RH	Tested By	Charles Hsiao

Antennal Polarity & Test Distance: Horizontal at 3 m										
Frequency (MHz)	Emission Level (dBuV/m)	Read Level (dBuV)	Limit (dBuV/m)	Margin (dB)	Antenna Factor (dB/m)	Cable Loss (dB)	Preamp Factor (dB)	Antenna Height (cm)	Table Angle (Degree)	Remark
2462	108.49	106.56			31.87	5.5	35.44	192	126	Average
2462	111.9	109.97			31.87	5.5	35.44	192	126	Peak
2483.52	51.92	49.96	54	-2.08	31.88	5.5	35.42	102	92	Average
2483.52	58.42	56.46	74	-15.58	31.88	5.5	35.42	102	92	Peak
4924	49.49	41.24	54	-4.51	33.99	8.28	34.02	100	214	Average
4924	52.19	43.94	74	-21.81	33.99	8.28	34.02	100	214	Peak

Antennal Polarity & Test Distance: Vertical at 3 m										
Frequency (MHz)	Emission Level (dBuV/m)	Read Level (dBuV)	Limit (dBuV/m)	Margin (dB)	Antenna Factor (dB/m)	Cable Loss (dB)	Preamp Factor (dB)	Antenna Height (cm)	Table Angle (Degree)	Remark
2462	105.14	103.21			31.87	5.5	35.44	108	147	Average
2462	108	106.07			31.87	5.5	35.44	108	147	Peak
2483.52	45.06	43.1	54	-8.94	31.88	5.5	35.42	108	147	Average
2483.52	54.35	52.39	74	-19.65	31.88	5.5	35.42	108	147	Peak
4924	52.21	43.96	54	-1.79	33.99	8.28	34.02	100	186	Average
4924	56.76	48.51	74	-17.24	33.99	8.28	34.02	100	186	Peak

Remarks:

- Emission Level = Read Level + Antenna Factor + Cable Loss - Preamp Factor
Margin value = Emission level – Limit value
- 2462 MHz: Fundamental frequency.

802.11g

EUT Test Condition		Measurement Detail	
Channel	Channel 1	Frequency Range	1 GHz ~ 25 GHz
Input Power	120 Vac, 60 Hz	Detector Function	Peak (PK) Average (AV)
Environmental Conditions	25 deg. C, 65 % RH	Tested By	Charles Hsiao

Antennal Polarity & Test Distance: Horizontal at 3 m

Frequency (MHz)	Emission Level (dBuV/m)	Read Level (dBuV)	Limit (dBuV/m)	Margin (dB)	Antenna Factor (dB/m)	Cable Loss (dB)	Preamp Factor (dB)	Antenna Height (cm)	Table Angle (Degree)	Remark
2389.92	52.9	51.17	54	-1.1	31.8	5.4	35.47	108	104	Average
2389.92	65.46	63.73	74	-8.54	31.8	5.4	35.47	108	104	Peak
2412	104.88	103.11			31.81	5.43	35.47	192	126	Average
2412	111.09	109.32			31.81	5.43	35.47	192	126	Peak
4824	40.37	32.24	54	-13.63	33.97	8.26	34.1	100	187	Average
4824	48.09	39.96	74	-25.91	33.97	8.26	34.1	100	187	Peak

Antennal Polarity & Test Distance: Vertical at 3 m

Frequency (MHz)	Emission Level (dBuV/m)	Read Level (dBuV)	Limit (dBuV/m)	Margin (dB)	Antenna Factor (dB/m)	Cable Loss (dB)	Preamp Factor (dB)	Antenna Height (cm)	Table Angle (Degree)	Remark
2389.92	48.91	47.18	54	-5.09	31.8	5.4	35.47	108	147	Average
2389.92	60.26	58.53	74	-13.74	31.8	5.4	35.47	108	147	Peak
2412	101.32	99.55			31.81	5.43	35.47	108	147	Average
2412	108.3	106.53			31.81	5.43	35.47	108	147	Peak
4824	40.48	32.35	54	-13.52	33.97	8.26	34.1	105	32	Average
4824	48.08	39.95	74	-25.92	33.97	8.26	34.1	105	32	Peak

Remarks:

- Emission Level = Read Level + Antenna Factor + Cable Loss - Preamp Factor
Margin value = Emission level – Limit value
- 2412 MHz: Fundamental frequency.

EUT Test Condition		Measurement Detail	
Channel	Channel 6	Frequency Range	1 GHz ~ 25 GHz
Input Power	120 Vac, 60 Hz	Detector Function	Peak (PK) Average (AV)
Environmental Conditions	25 deg. C, 65 % RH	Tested By	Charles Hsiao

Antennal Polarity & Test Distance: Horizontal at 3 m										
Frequency (MHz)	Emission Level (dBuV/m)	Read Level (dBuV)	Limit (dBuV/m)	Margin (dB)	Antenna Factor (dB/m)	Cable Loss (dB)	Preamp Factor (dB)	Antenna Height (cm)	Table Angle (Degree)	Remark
2389.2	41.49	39.78	54	-12.51	31.8	5.4	35.49	192	126	Average
2389.2	52	50.29	74	-22	31.8	5.4	35.49	192	126	Peak
2437	106.69	104.84			31.85	5.46	35.46	192	126	Average
2437	113.37	111.52			31.85	5.46	35.46	192	126	Peak
2483.96	42.56	40.6	54	-11.44	31.88	5.5	35.42	192	126	Average
2483.96	53.66	51.7	74	-20.34	31.88	5.5	35.42	192	126	Peak
Antennal Polarity & Test Distance: Vertical at 3 m										
Frequency (MHz)	Emission Level (dBuV/m)	Read Level (dBuV)	Limit (dBuV/m)	Margin (dB)	Antenna Factor (dB/m)	Cable Loss (dB)	Preamp Factor (dB)	Antenna Height (cm)	Table Angle (Degree)	Remark
2388.75	41.1	39.39	54	-12.9	31.8	5.4	35.49	104	144	Average
2388.75	52.47	50.76	74	-21.53	31.8	5.4	35.49	104	144	Peak
2437	103.65	101.8			31.85	5.46	35.46	104	144	Average
2437	110.29	108.44			31.85	5.46	35.46	104	144	Peak
2484.4	41.57	39.58	54	-12.43	31.88	5.53	35.42	104	144	Average
2484.4	53.4	51.41	74	-20.6	31.88	5.53	35.42	104	144	Peak

Remarks:

- Emission Level = Read Level + Antenna Factor + Cable Loss - Preamp Factor
Margin value = Emission level – Limit value
- 2437 MHz: Fundamental frequency.

EUT Test Condition		Measurement Detail	
Channel	Channel 11	Frequency Range	1 GHz ~ 25 GHz
Input Power	120 Vac, 60 Hz	Detector Function	Peak (PK) Average (AV)
Environmental Conditions	25 deg. C, 65 % RH	Tested By	Charles Hsiao

Antennal Polarity & Test Distance: Horizontal at 3 m										
Frequency (MHz)	Emission Level (dBuV/m)	Read Level (dBuV)	Limit (dBuV/m)	Margin (dB)	Antenna Factor (dB/m)	Cable Loss (dB)	Preamp Factor (dB)	Antenna Height (cm)	Table Angle (Degree)	Remark
2462	102.49	100.56			31.87	5.5	35.44	192	126	Average
2462	109.37	107.44			31.87	5.5	35.44	192	126	Peak
2483.56	51.84	49.88	54	-2.16	31.88	5.5	35.42	187	100	Average
2483.56	63.91	61.95	74	-10.09	31.88	5.5	35.42	187	100	Peak
4924	40.19	31.94	54	-13.81	33.99	8.28	34.02	123	104	Average
4924	47.92	39.67	74	-26.08	33.99	8.28	34.02	123	104	Peak
Antennal Polarity & Test Distance: Vertical at 3 m										
Frequency (MHz)	Emission Level (dBuV/m)	Read Level (dBuV)	Limit (dBuV/m)	Margin (dB)	Antenna Factor (dB/m)	Cable Loss (dB)	Preamp Factor (dB)	Antenna Height (cm)	Table Angle (Degree)	Remark
2462	99.46	97.53			31.87	5.5	35.44	104	144	Average
2462	106.04	104.11			31.87	5.5	35.44	104	144	Peak
2483.56	47.17	45.21	54	-6.83	31.88	5.5	35.42	104	144	Average
2483.56	59.44	57.48	74	-14.56	31.88	5.5	35.42	104	144	Peak
4924	40.24	31.99	54	-13.76	33.99	8.28	34.02	100	117	Average
4924	48.12	39.87	74	-25.88	33.99	8.28	34.02	100	117	Peak

Remarks:

- Emission Level = Read Level + Antenna Factor + Cable Loss - Preamp Factor
Margin value = Emission level – Limit value
- 2462 MHz: Fundamental frequency.

Mode B

802.11n (HT20)

EUT Test Condition		Measurement Detail	
Channel	Channel 1	Frequency Range	1 GHz ~ 25 GHz
Input Power	120 Vac, 60 Hz	Detector Function	Peak (PK) Average (AV)
Environmental Conditions	25 deg. C, 65 % RH	Tested By	Charles Hsiao

Antennal Polarity & Test Distance: Horizontal at 3 m										
Frequency (MHz)	Emission Level (dBuV/m)	Read Level (dBuV)	Limit (dBuV/m)	Margin (dB)	Antenna Factor (dB/m)	Cable Loss (dB)	Preamp Factor (dB)	Antenna Height (cm)	Table Angle (Degree)	Remark
2389.92	52.71	50.98	54	-1.29	31.8	5.4	35.47	126	103	Average
2389.92	63.8	62.07	74	-10.2	31.8	5.4	35.47	126	103	Peak
2414	101.92	100.15			31.81	5.43	35.47	148	103	Average
2414	110.6	108.83			31.81	5.43	35.47	148	103	Peak
4824	40.45	32.32	54	-13.55	33.97	8.26	34.1	151	123	Average
4824	48.15	40.02	74	-25.85	33.97	8.26	34.1	151	123	Peak

Antennal Polarity & Test Distance: Vertical at 3 m										
Frequency (MHz)	Emission Level (dBuV/m)	Read Level (dBuV)	Limit (dBuV/m)	Margin (dB)	Antenna Factor (dB/m)	Cable Loss (dB)	Preamp Factor (dB)	Antenna Height (cm)	Table Angle (Degree)	Remark
2389.83	49.32	47.59	54	-4.68	31.8	5.4	35.47	263	275	Average
2389.83	59.69	57.96	74	-14.31	31.8	5.4	35.47	263	275	Peak
2412	101.11	99.34			31.81	5.43	35.47	259	278	Average
2412	109.81	108.04			31.81	5.43	35.47	259	278	Peak
4824	40.28	32.15	54	-13.72	33.97	8.26	34.1	105	200	Average
4824	47.56	39.43	74	-26.44	33.97	8.26	34.1	105	200	Peak

Remarks:

- Emission Level = Read Level + Antenna Factor + Cable Loss - Preamp Factor
Margin value = Emission level – Limit value
- 2412 MHz: Fundamental frequency.

EUT Test Condition		Measurement Detail	
Channel	Channel 6	Frequency Range	1 GHz ~ 25 GHz
Input Power	120 Vac, 60 Hz	Detector Function	Peak (PK) Average (AV)
Environmental Conditions	25 deg. C, 65 % RH	Tested By	Charles Hsiao

Antennal Polarity & Test Distance: Horizontal at 3 m										
Frequency (MHz)	Emission Level (dBuV/m)	Read Level (dBuV)	Limit (dBuV/m)	Margin (dB)	Antenna Factor (dB/m)	Cable Loss (dB)	Preamp Factor (dB)	Antenna Height (cm)	Table Angle (Degree)	Remark
2389.65	41.48	39.77	54	-12.52	31.8	5.4	35.49	192	126	Average
2389.65	53.01	51.3	74	-20.99	31.8	5.4	35.49	192	126	Peak
2437	105.21	103.36			31.85	5.46	35.46	192	126	Average
2437	112.03	110.18			31.85	5.46	35.46	192	126	Peak
2484.56	42.78	40.79	54	-11.22	31.88	5.53	35.42	192	126	Average
2484.56	53.37	51.38	74	-20.63	31.88	5.53	35.42	192	126	Peak
Antennal Polarity & Test Distance: Vertical at 3 m										
Frequency (MHz)	Emission Level (dBuV/m)	Read Level (dBuV)	Limit (dBuV/m)	Margin (dB)	Antenna Factor (dB/m)	Cable Loss (dB)	Preamp Factor (dB)	Antenna Height (cm)	Table Angle (Degree)	Remark
2389.92	40.98	39.25	54	-13.02	31.8	5.4	35.47	108	147	Average
2389.92	53.3	51.57	74	-20.7	31.8	5.4	35.47	108	147	Peak
2437	102.48	100.63			31.85	5.46	35.46	108	147	Average
2437	109.6	107.75			31.85	5.46	35.46	108	147	Peak
2484.96	41.21	39.22	54	-12.79	31.88	5.53	35.42	108	147	Average
2484.96	53.31	51.32	74	-20.69	31.88	5.53	35.42	108	147	Peak

Remarks:

- Emission Level = Read Level + Antenna Factor + Cable Loss - Preamp Factor
Margin value = Emission level – Limit value
- 2437 MHz: Fundamental frequency.

EUT Test Condition		Measurement Detail	
Channel	Channel 11	Frequency Range	1 GHz ~ 25 GHz
Input Power	120 Vac, 60 Hz	Detector Function	Peak (PK) Average (AV)
Environmental Conditions	25 deg. C, 65 % RH	Tested By	Charles Hsiao

Antennal Polarity & Test Distance: Horizontal at 3 m										
Frequency (MHz)	Emission Level (dBuV/m)	Read Level (dBuV)	Limit (dBuV/m)	Margin (dB)	Antenna Factor (dB/m)	Cable Loss (dB)	Preamp Factor (dB)	Antenna Height (cm)	Table Angle (Degree)	Remark
2462	100.08	98.15			31.87	5.5	35.44	272	99	Average
2462	108.87	106.94			31.87	5.5	35.44	272	99	Peak
2483.56	52.93	50.97	54	-1.07	31.88	5.5	35.42	266	91	Average
2483.56	65.46	63.5	74	-8.54	31.88	5.5	35.42	266	91	Peak
4924	40.23	31.98	54	-13.77	33.99	8.28	34.02	104	75	Average
4924	47.94	39.69	74	-26.06	33.99	8.28	34.02	104	75	Peak
Antennal Polarity & Test Distance: Vertical at 3 m										
Frequency (MHz)	Emission Level (dBuV/m)	Read Level (dBuV)	Limit (dBuV/m)	Margin (dB)	Antenna Factor (dB/m)	Cable Loss (dB)	Preamp Factor (dB)	Antenna Height (cm)	Table Angle (Degree)	Remark
2462	99.39	97.46			31.87	5.5	35.44	309	278	Average
2462	107.66	105.73			31.87	5.5	35.44	309	278	Peak
2483.6	48.65	46.69	54	-5.35	31.88	5.5	35.42	309	293	Average
2483.6	60.84	58.88	74	-13.16	31.88	5.5	35.42	309	293	Peak
4924	40.52	32.27	54	-13.48	33.99	8.28	34.02	102	300	Average
4924	47.63	39.38	74	-26.37	33.99	8.28	34.02	102	300	Peak

Remarks:

- Emission Level = Read Level + Antenna Factor + Cable Loss - Preamp Factor
Margin value = Emission level – Limit value
- 2462 MHz: Fundamental frequency.

802.11n (HT40)

EUT Test Condition		Measurement Detail	
Channel	Channel 3	Frequency Range	1 GHz ~ 25 GHz
Input Power	120 Vac, 60 Hz	Detector Function	Peak (PK) Average (AV)
Environmental Conditions	25 deg. C, 65 % RH	Tested By	Charles Hsiao

Antennal Polarity & Test Distance: Horizontal at 3 m

Frequency (MHz)	Emission Level (dBuV/m)	Read Level (dBuV)	Limit (dBuV/m)	Margin (dB)	Antenna Factor (dB/m)	Cable Loss (dB)	Preamp Factor (dB)	Antenna Height (cm)	Table Angle (Degree)	Remark
2389.29	49.66	47.95	54	-4.34	31.8	5.4	35.49	155	99	Average
2389.29	69.76	68.05	74	-4.24	31.8	5.4	35.49	155	99	Peak
2422	97.49	95.69			31.83	5.43	35.46	192	126	Average
2422	104.04	102.24			31.83	5.43	35.46	192	126	Peak
2485.52	43.92	41.93	54	-10.08	31.88	5.53	35.42	192	126	Average
2485.52	60.69	58.7	74	-13.31	31.88	5.53	35.42	192	126	Peak

Antennal Polarity & Test Distance: Vertical at 3 m

Frequency (MHz)	Emission Level (dBuV/m)	Read Level (dBuV)	Limit (dBuV/m)	Margin (dB)	Antenna Factor (dB/m)	Cable Loss (dB)	Preamp Factor (dB)	Antenna Height (cm)	Table Angle (Degree)	Remark
2389.92	45.53	43.8	54	-8.47	31.8	5.4	35.47	108	147	Average
2389.92	62.25	60.52	74	-11.75	31.8	5.4	35.47	108	147	Peak
2422	94.62	92.82			31.83	5.43	35.46	108	147	Average
2422	101.25	99.45			31.83	5.43	35.46	108	147	Peak
2491.48	41.98	39.97	54	-12.02	31.9	5.53	35.42	108	147	Average
2491.48	53.72	51.71	74	-20.28	31.9	5.53	35.42	108	147	Peak

Remarks:

- Emission Level = Read Level + Antenna Factor + Cable Loss - Preamp Factor
Margin value = Emission level – Limit value
- 2422 MHz: Fundamental frequency.

EUT Test Condition		Measurement Detail	
Channel	Channel 6	Frequency Range	1 GHz ~ 25 GHz
Input Power	120 Vac, 60 Hz	Detector Function	Peak (PK) Average (AV)
Environmental Conditions	25 deg. C, 65 % RH	Tested By	Charles Hsiao

Antennal Polarity & Test Distance: Horizontal at 3 m										
Frequency (MHz)	Emission Level (dBuV/m)	Read Level (dBuV)	Limit (dBuV/m)	Margin (dB)	Antenna Factor (dB/m)	Cable Loss (dB)	Preamp Factor (dB)	Antenna Height (cm)	Table Angle (Degree)	Remark
2389.92	49.2	47.47	54	-4.8	31.8	5.4	35.47	236	105	Average
2389.92	66.13	64.4	74	-7.87	31.8	5.4	35.47	236	105	Peak
2437	99.49	97.64			31.85	5.46	35.46	252	113	Average
2437	107.07	105.22			31.85	5.46	35.46	252	113	Peak
2483.6	52.7	50.74	54	-1.3	31.88	5.5	35.42	236	105	Average
2483.6	65.96	64	74	-8.04	31.88	5.5	35.42	236	105	Peak
Antennal Polarity & Test Distance: Vertical at 3 m										
Frequency (MHz)	Emission Level (dBuV/m)	Read Level (dBuV)	Limit (dBuV/m)	Margin (dB)	Antenna Factor (dB/m)	Cable Loss (dB)	Preamp Factor (dB)	Antenna Height (cm)	Table Angle (Degree)	Remark
2389.56	48.14	46.43	54	-5.86	31.8	5.4	35.49	314	275	Average
2389.56	63.11	61.4	74	-10.89	31.8	5.4	35.49	314	275	Peak
2437	98.22	96.37			31.85	5.46	35.46	314	289	Average
2437	106.68	104.83			31.85	5.46	35.46	314	289	Peak
2483.8	50.2	48.24	54	-3.8	31.88	5.5	35.42	314	275	Average
2483.8	62.17	60.21	74	-11.83	31.88	5.5	35.42	314	275	Peak

Remarks:

- Emission Level = Read Level + Antenna Factor + Cable Loss - Preamp Factor
Margin value = Emission level – Limit value
- 2437 MHz: Fundamental frequency.

EUT Test Condition		Measurement Detail	
Channel	Channel 9	Frequency Range	1 GHz ~ 25 GHz
Input Power	120 Vac, 60 Hz	Detector Function	Peak (PK) Average (AV)
Environmental Conditions	25 deg. C, 65 % RH	Tested By	Charles Hsiao

Antennal Polarity & Test Distance: Horizontal at 3 m										
Frequency (MHz)	Emission Level (dBuV/m)	Read Level (dBuV)	Limit (dBuV/m)	Margin (dB)	Antenna Factor (dB/m)	Cable Loss (dB)	Preamp Factor (dB)	Antenna Height (cm)	Table Angle (Degree)	Remark
2388.93	42.75	41.04	54	-11.25	31.8	5.4	35.49	192	126	Average
2388.93	58.7	56.99	74	-15.3	31.8	5.4	35.49	192	126	Peak
2452	96.66	94.79			31.85	5.46	35.44	192	126	Average
2452	103.62	101.75			31.85	5.46	35.44	192	126	Peak
2483.52	51.41	49.45	54	-2.59	31.88	5.5	35.42	200	121	Average
2483.52	66.76	64.8	74	-7.24	31.88	5.5	35.42	200	121	Peak
Antennal Polarity & Test Distance: Vertical at 3 m										
Frequency (MHz)	Emission Level (dBuV/m)	Read Level (dBuV)	Limit (dBuV/m)	Margin (dB)	Antenna Factor (dB/m)	Cable Loss (dB)	Preamp Factor (dB)	Antenna Height (cm)	Table Angle (Degree)	Remark
2385.6	41.62	39.91	54	-12.38	31.8	5.4	35.49	104	144	Average
2385.6	55.9	54.19	74	-18.1	31.8	5.4	35.49	104	144	Peak
2452	93.35	91.48			31.85	5.46	35.44	104	144	Average
2452	100.07	98.2			31.85	5.46	35.44	104	144	Peak
2483.56	46.62	44.66	54	-7.38	31.88	5.5	35.42	104	144	Average
2483.56	60.23	58.27	74	-13.77	31.88	5.5	35.42	104	144	Peak

Remarks:

- Emission Level = Read Level + Antenna Factor + Cable Loss - Preamp Factor
Margin value = Emission level – Limit value
- 2452 MHz: Fundamental frequency.

9 kHz ~ 30 MHz Data:

The amplitude of spurious emissions attenuated more than 20 dB below the permissible value is not required to be report.

30 MHz ~ 1 GHz Worst-Case Data:

Mode A

802.11b

EUT Test Condition		Measurement Detail	
Channel	Channel 6	Frequency Range	30 MHz ~ 1 GHz
Input Power	120 Vac, 60 Hz	Detector Function	Peak (PK) Quasi-peak (QP)
Environmental Conditions	25 deg. C, 65 % RH	Tested By	Charles Hsiao

Antennal Polarity & Test Distance: Horizontal at 3 m										
Frequency (MHz)	Emission Level (dBuV/m)	Read Level (dBuV)	Limit (dBuV/m)	Margin (dB)	Antenna Factor (dB/m)	Cable Loss (dB)	Preamp Factor (dB)	Antenna Height (cm)	Table Angle (Degree)	Remark
102.36	20.28	38.9	43.5	-23.22	12.36	1.28	32.26	124	326	Peak
209.82	15.13	34.59	43.5	-28.37	11.15	1.65	32.26	116	109	Peak
257.61	16.13	33.83	46	-29.87	12.46	1.94	32.1	157	152	Peak
475.7	15.11	28.69	46	-30.89	15.98	2.56	32.12	151	308	Peak
738.2	18.85	28.13	46	-27.15	19.69	3.16	32.13	154	188	Peak
890.1	22.93	29.58	46	-23.07	21.4	3.49	31.54	122	224	Peak
Antennal Polarity & Test Distance: Vertical at 3 m										
Frequency (MHz)	Emission Level (dBuV/m)	Read Level (dBuV)	Limit (dBuV/m)	Margin (dB)	Antenna Factor (dB/m)	Cable Loss (dB)	Preamp Factor (dB)	Antenna Height (cm)	Table Angle (Degree)	Remark
37.02	26.99	45.83	40	-13.01	12.65	0.74	32.23	165	62	Peak
185.25	24.5	44.93	43.5	-19	10.2	1.61	32.24	152	158	Peak
230.07	18.44	37.01	46	-27.56	11.76	1.85	32.18	117	179	Peak
480.6	15.22	28.69	46	-30.78	16.08	2.56	32.11	186	164	Peak
723.5	18.92	28.32	46	-27.08	19.55	3.16	32.11	105	142	Peak
817.3	21.9	29.93	46	-24.1	20.61	3.32	31.96	153	325	Peak

Remarks:

- Emission Level = Read Level + Antenna Factor + Cable Loss - Preamp Factor
Margin value = Emission level – Limit value

4.2 Conducted Emission Measurement

4.2.1 Limits of Conducted Emission Measurement

Frequency (MHz)	Conducted Limit (dBuV)	
	Quasi-peak	Average
0.15 - 0.5	66 - 56	56 - 46
0.50 - 5.0	56	46
5.0 - 30.0	60	50

- Note: 1. The lower limit shall apply at the transition frequencies.
 2. The limit decreases in line with the logarithm of the frequency in the range of 0.15 to 0.50 MHz.

4.2.2 Test Instruments

Description & Manufacturer	Model No.	Serial No.	Date of Calibration	Due Date of Calibration
Test Receiver ROHDE & SCHWARZ	ESCI	100613	Nov. 21, 2016	Nov. 20, 2017
RF signal cable (with 10dB PAD) Woken	5D-FB	Cable-cond1-01	Sep. 05, 2017	Sep. 04, 2018
LISN/AMN ROHDE & SCHWARZ (EUT)	ESH3-Z5	835239/001	Mar. 10, 2017	Mar. 09, 2018
LISN/AMN ROHDE & SCHWARZ (Peripheral)	ENV216	101196	Apr. 20, 2017	Apr. 19, 2018
Software ADT	BV ADT_Cond_ V7.3.7.3	NA	NA	NA

- Note: 1. The calibration interval of the above test instruments is 12 months and the calibrations are traceable to NML/ROC and NIST/USA.
 2. The test was performed in HwaYa Shielded Room 1.
 3. The VCCI Site Registration No. is C-2040.

4.2.3 Test Procedures

- a. The EUT was placed 0.4 meters from the conducting wall of the shielded room with EUT being connected to the power mains through a line impedance stabilization network (LISN). Other support units were connected to the power mains through another LISN. The two LISNs provide 50 ohm/50 uH of coupling impedance for the measuring instrument.
- b. Both lines of the power mains connected to the EUT were checked for maximum conducted interference.
- c. The frequency range from 150 kHz to 30 MHz was searched. Emission levels under (Limit – 20 dB) was not recorded.

NOTE: All modes of operation were investigated and the worst-case emissions are reported.

4.2.4 Deviation from Test Standard

No deviation.

4.2.5 Test Setup

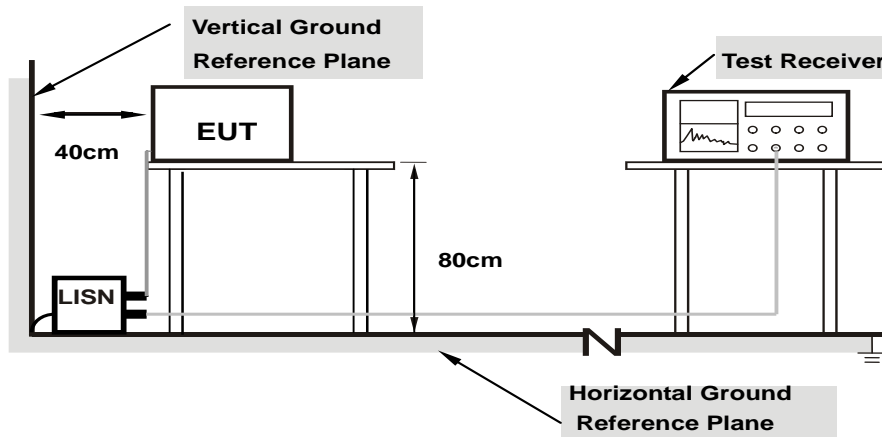

Note: 1.Support units were connected to second LISN.

For the actual test configuration, please refer to the attached file (Test Setup Photo).

4.2.6 EUT Operating Conditions

- a. Placed the EUT on a testing table.
- b. Use the software to control the EUT under transmission condition continuously at specific channel frequency.

4.2.7 Test Results

Frequency Range	150kHz ~ 30MHz	Detector Function & Resolution Bandwidth	Quasi-Peak (QP) / Average (AV), 9kHz
Input Power	120Vac, 60Hz	Environmental Conditions	25°C, 65%RH
Tested by	Getaz Yang	Test Date	2017/11/3

Phase Of Power : Line (L)										
No	Frequency (MHz)	Correction Factor (dB)	Reading Value (dBuV)		Emission Level (dBuV)		Limit (dBuV)		Margin (dB)	
			Q.P.	AV.	Q.P.	AV.	Q.P.	AV.	Q.P.	AV.
1	0.16569	10.39	29.74	12.50	40.13	22.89	65.17	55.17	-25.04	-32.28
2	0.29076	10.40	19.52	10.40	29.92	20.80	60.50	50.50	-30.58	-29.70
3	0.41588	10.41	16.43	8.01	26.84	18.42	57.53	47.53	-30.69	-29.11
4	0.55974	10.41	22.28	12.93	32.69	23.34	56.00	46.00	-23.31	-22.66
5	0.77951	10.42	19.97	11.59	30.39	22.01	56.00	46.00	-25.61	-23.99
6	2.84008	10.50	21.10	15.04	31.60	25.54	56.00	46.00	-24.40	-20.46

Remarks:

1. Q.P. and AV. are abbreviations of quasi-peak and average individually.
2. The emission levels of other frequencies were very low against the limit.
3. Margin value = Emission level – Limit value
4. Correction factor = Insertion loss + Cable loss
5. Emission Level = Correction Factor + Reading Value

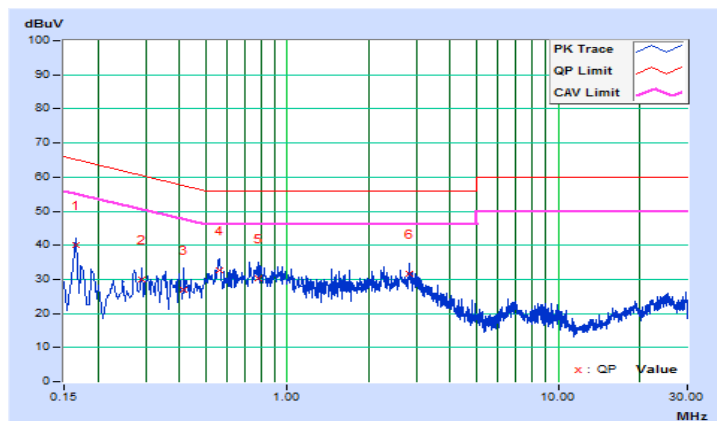

Frequency Range	150kHz ~ 30MHz	Detector Function & Resolution Bandwidth	Quasi-Peak (QP) / Average (AV), 9kHz
Input Power	120Vac, 60Hz	Environmental Conditions	25°C, 65%RH
Tested by	Getaz Yang	Test Date	2017/11/3

Phase Of Power : Neutral (N)										
No	Frequency (MHz)	Correction Factor (dB)	Reading Value (dBuV)		Emission Level (dBuV)		Limit (dBuV)		Margin (dB)	
			Q.P.	AV.	Q.P.	AV.	Q.P.	AV.	Q.P.	AV.
1	0.19305	10.16	26.31	16.41	36.47	26.57	63.90	53.90	-27.43	-27.33
2	0.43934	10.17	15.59	8.75	25.76	18.92	57.07	47.07	-31.31	-28.15
3	0.57228	10.17	23.75	15.28	33.92	25.45	56.00	46.00	-22.08	-20.55
4	1.75701	10.22	15.12	8.00	25.34	18.22	56.00	46.00	-30.66	-27.78
5	2.75015	10.27	18.37	13.25	28.64	23.52	56.00	46.00	-27.36	-22.48
6	6.87911	10.45	11.65	5.21	22.10	15.66	60.00	50.00	-37.90	-34.34

Remarks:

1. Q.P. and AV. are abbreviations of quasi-peak and average individually.
2. The emission levels of other frequencies were very low against the limit.
3. Margin value = Emission level – Limit value
4. Correction factor = Insertion loss + Cable loss
5. Emission Level = Correction Factor + Reading Value

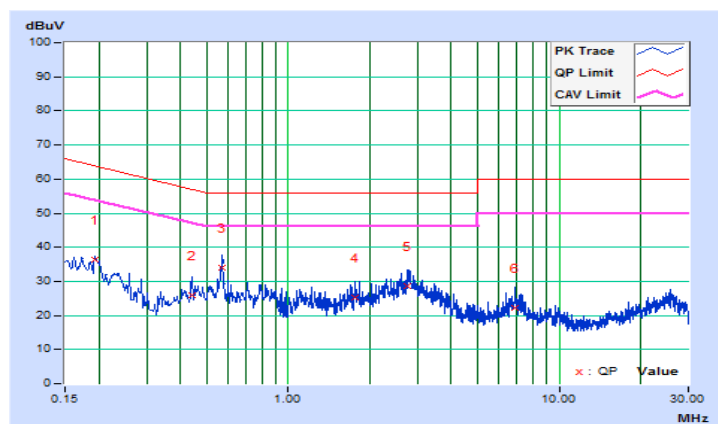

4.3 6 dB Bandwidth Measurement

4.3.1 Limits of 6 dB Bandwidth Measurement

The minimum of 6 dB Bandwidth Measurement is 0.5 MHz.

4.3.2 Test Setup

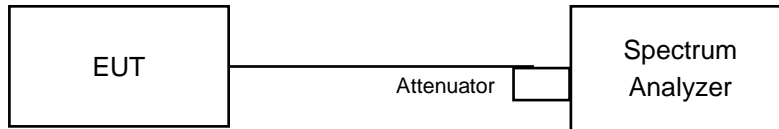

4.3.3 Test Instruments

Refer to section 4.1.2 to get information of above instrument.

4.3.4 Test Procedure

- Set resolution bandwidth (RBW) = 100 kHz
- Set the video bandwidth (VBW) $\geq 3 \times$ RBW, Detector = Peak.
- Trace mode = max hold.
- Sweep = auto couple.
- Measure the maximum width of the emission that is constrained by the frequencies associated with the two amplitude points (upper and lower) that are attenuated by 6 dB relative to the maximum level measured in the fundamental emission

4.3.5 Deviation from Test Standard

No deviation.

4.3.6 EUT Operating Conditions

The software provided by client to enable the EUT under transmission condition continuously at lowest, middle and highest channel frequencies individually.

4.3.7 Test Result

Mode A

802.11b

Channel	Frequency (MHz)	6 dB Bandwidth (MHz)	Minimum Limit (MHz)	Pass / Fail
1	2412	7.59	0.5	Pass
6	2437	7.61	0.5	Pass
11	2462	8.09	0.5	Pass

802.11g

Channel	Frequency (MHz)	6 dB Bandwidth (MHz)	Minimum Limit (MHz)	Pass / Fail
1	2412	15.18	0.5	Pass
6	2437	15.18	0.5	Pass
11	2462	15.17	0.5	Pass

Mode B

802.11n (HT20)

Channel	Frequency (MHz)	6 dB Bandwidth (MHz)		Minimum Limit (MHz)	Pass / Fail
		Chain 0	Chain 1		
1	2412	15.16	15.16	0.5	Pass
6	2437	15.17	15.17	0.5	Pass
11	2462	15.17	15.17	0.5	Pass

802.11n (HT40)

Channel	Frequency (MHz)	6 dB Bandwidth (MHz)		Minimum Limit (MHz)	Pass / Fail
		Chain 0	Chain 1		
3	2422	35.17	35.17	0.5	Pass
6	2437	35.20	33.97	0.5	Pass
9	2452	35.22	35.16	0.5	Pass

Spectrum Plot of Worst Value

802.11b

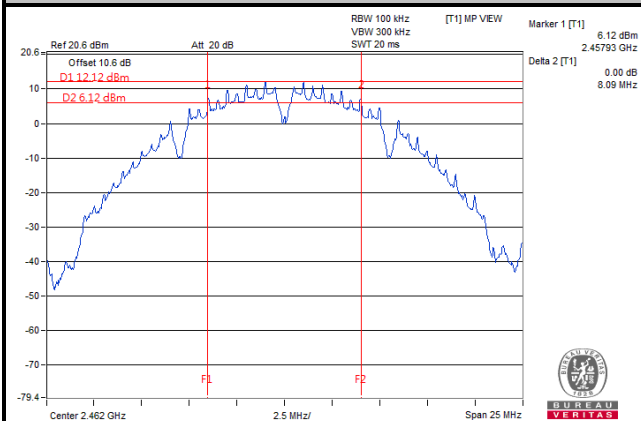

802.11g

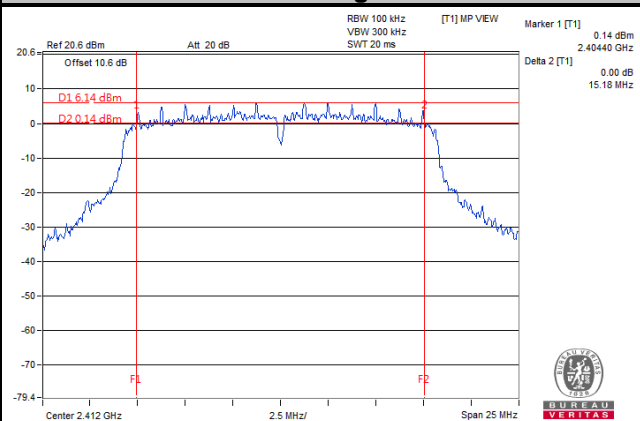

802.11n (HT20)

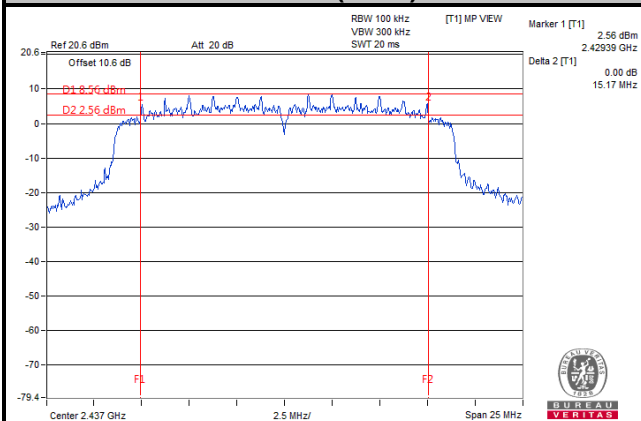

802.11n (HT40)

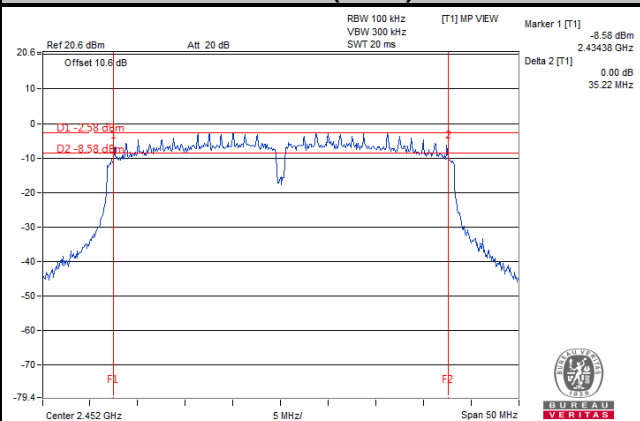

4.4 Occupied Bandwidth Measurement

4.4.1 Test Setup

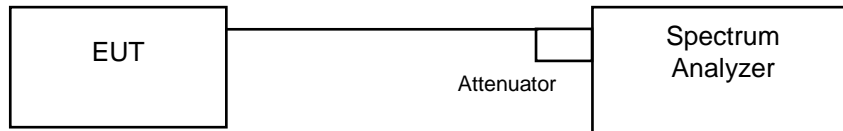

4.4.2 Test Instruments

Refer to section 4.1.2 to get information of above instrument.

4.4.3 Test Procedure

The transmitter output was connected to the spectrum analyzer through an attenuator. The bandwidth of the fundamental frequency was measured by spectrum analyzer with resolution bandwidth in the range of 1 % to 5 % of the anticipated emission bandwidth, and a video bandwidth at least 3x the resolution bandwidth and set the detector to PEAK. The width of a frequency band such that, below the lower and above the upper frequency limits, the mean powers emitted are each equal to a specified percentage 0.5 % of the total mean power of a given emission.

4.4.4 Deviation from Test Standard

No deviation.

4.4.5 EUT Operating Conditions

The software provided by client to enable the EUT under transmission condition continuously at lowest, middle and highest channel frequencies individually.

4.4.6 Test Results

Mode A

802.11b

Channel	Frequency (MHz)	Occupied Bandwidth (MHz)	Pass / Fail
1	2412	13.13	Pass
6	2437	13.20	Pass
11	2462	13.21	Pass

802.11g

Channel	Frequency (MHz)	Occupied Bandwidth (MHz)	Pass / Fail
1	2412	16.30	Pass
6	2437	16.40	Pass
11	2462	16.30	Pass

Mode B

802.11n (HT20)

Channel	Frequency (MHz)	Occupied Bandwidth (MHz)		Pass / Fail
		Chain 0	Chain 1	
1	2412	17.47	17.47	Pass
6	2437	17.50	20.05	Pass
11	2462	17.45	17.65	Pass

802.11n (HT40)

Channel	Frequency (MHz)	Occupied Bandwidth (MHz)		Pass / Fail
		Chain 0	Chain 1	
3	2422	35.94	35.94	Pass
6	2437	36.00	40.16	Pass
9	2452	36.00	36.00	Pass

Spectrum Plot of Worst Value

802.11b

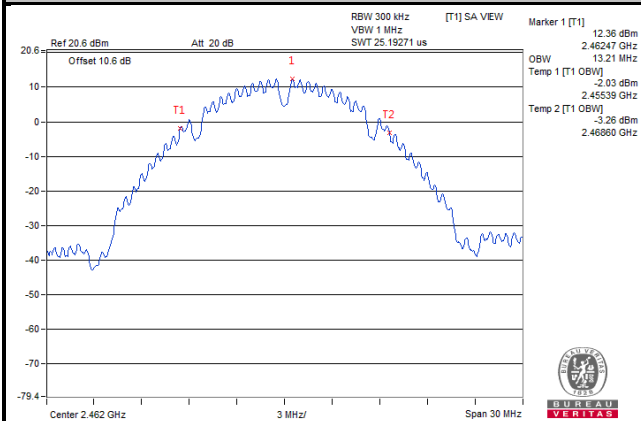

802.11g

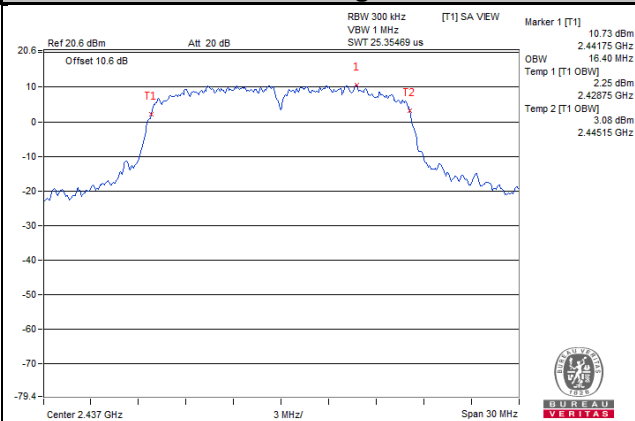

802.11n (HT20)

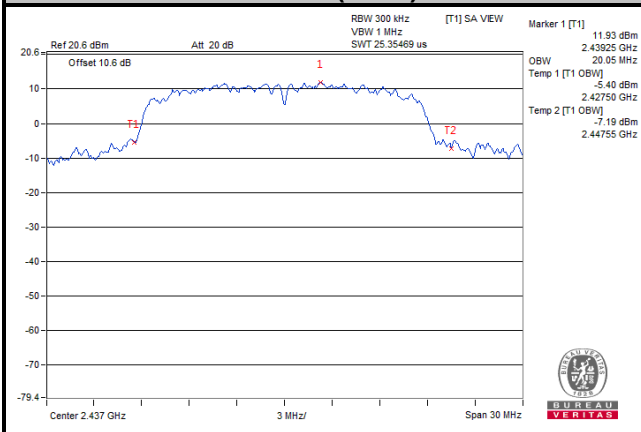

802.11n (HT40)

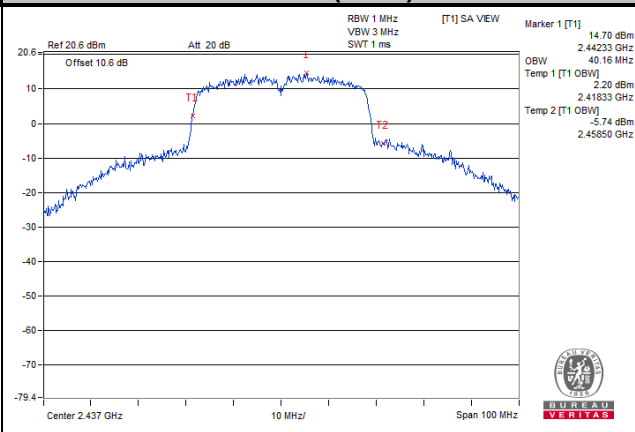

4.5 Conducted Output Power Measurement

4.5.1 Limits of Conducted Output Power Measurement

For systems using digital modulation in the 2400–2483.5 MHz bands: 1 Watt (30 dBm)

Per KDB 662911 D01 Multiple Transmitter Output Method of conducted output power measurement on IEEE 802.11 devices,

Array Gain = 0 dB (i.e., no array gain) for NANT \leq 4;

Array Gain = 0 dB (i.e., no array gain) for channel widths \geq 40 MHz for any NANT;

Array Gain = $5 \log(\text{NANT}/\text{NSS})$ dB or 3 dB, whichever is less for 20 MHz channel widths with NANT \geq 5.

For power measurements on all other devices: Array Gain = $10 \log(\text{NANT}/\text{NSS})$ dB.

4.5.2 Test Setup

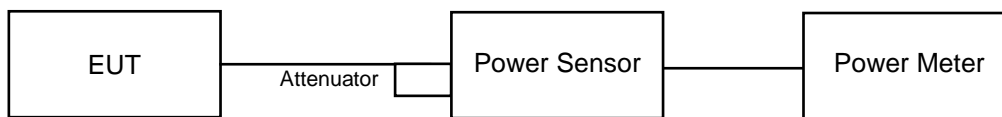

4.5.3 Test Instruments

Refer to section 4.1.2 to get information of above instrument.

4.5.4 Test Procedures

A peak power sensor was used on the output port of the EUT. A power meter was used to read the response of the peak power sensor. Record the power level.

4.5.5 Deviation from Test Standard

No deviation.

4.5.6 EUT Operating Conditions

The software provided by client to enable the EUT under transmission condition continuously at lowest, middle and highest channel frequencies individually.

4.5.7 Test Results

Mode A

802.11b

Channel	Frequency (MHz)	Peak Power (mW)	Peak Power (dBm)	Limit (dBm)	Pass / Fail
1	2412	171.791	22.35	30	Pass
6	2437	188.799	22.76	30	Pass
11	2462	175.792	22.45	30	Pass

802.11g

Channel	Frequency (MHz)	Peak Power (mW)	Peak Power (dBm)	Limit (dBm)	Pass / Fail
1	2412	196.336	22.93	30	Pass
6	2437	283.139	24.52	30	Pass
11	2462	183.231	22.63	30	Pass

Mode B

802.11n (HT20)

Channel	Frequency (MHz)	Peak Power (dBm)		Total Power (mW)	Total Power (dBm)	Limit (dBm)	Pass / Fail
		Chain 0	Chain 1				
1	2412	22.77	23.08	392.47	25.94	30	Pass
6	2437	23.98	24.10	507.075	27.05	30	Pass
11	2462	21.93	22.63	339.186	25.30	30	Pass

802.11n (HT40)

Channel	Frequency (MHz)	Peak Power (dBm)		Total Power (mW)	Total Power (dBm)	Limit (dBm)	Pass / Fail
		Chain 0	Chain 1				
3	2422	20.29	20.52	219.625	23.42	30	Pass
6	2437	23.95	24.04	501.826	27.01	30	Pass
9	2452	18.89	19.91	175.395	22.44	30	Pass

4.6 Power Spectral Density Measurement

4.6.1 Limits of Power Spectral Density Measurement

The Maximum of Power Spectral Density Measurement is 8 dBm.

4.6.2 Test Setup

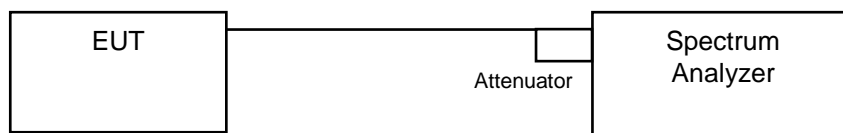

4.6.3 Test Instruments

Refer to section 4.1.2 to get information of above instrument.

4.6.4 Test Procedure

- a. Set analyzer center frequency to DTS channel center frequency.
- b. Set the span to 1.5 times the DTS bandwidth.
- c. Set the RBW to: $3 \text{ kHz} \leq \text{RBW} \leq 100 \text{ kHz}$.
- d. Set the VBW $\geq 3 \times \text{RBW}$.
- e. Detector = peak.
- f. Sweep time = auto couple.
- g. Trace mode = max hold.
- h. Allow trace to fully stabilize.
- i. Use the peak marker function to determine the maximum amplitude level within the RBW.

4.6.5 Deviation from Test Standard

No deviation.

4.6.6 EUT Operating Condition

The software provided by client to enable the EUT under transmission condition continuously at lowest, middle and highest channel frequencies individually.

4.6.7 Test Results

Mode A
802.11b

Channel	Frequency (MHz)	PSD (dBm/3 kHz)	Limit (dBm/3 kHz)	Pass / Fail
1	2412	-3.78	8	Pass
6	2437	-3.40	8	Pass
11	2462	-3.64	8	Pass

802.11g

Channel	Frequency (MHz)	PSD (dBm/3 kHz)	Limit (dBm/3 kHz)	Pass / Fail
1	2412	-9.98	8	Pass
6	2437	-7.00	8	Pass
11	2462	-10.93	8	Pass

Mode B
802.11n (HT20)

TX Chain	Channel	Freq. (MHz)	PSD (dBm/3 kHz)	10 log (N=2) dB	Total PSD (dBm/3 kHz)	Limit (dBm/3 kHz)	Pass / Fail
0	1	2412	-8.34	3.01	-5.33	8	Pass
	6	2437	-7.17	3.01	-4.16	8	Pass
	11	2462	-10.63	3.01	-7.62	8	Pass
1	1	2412	-8.90	3.01	-5.89	8	Pass
	6	2437	-6.23	3.01	-3.22	8	Pass
	11	2462	-9.62	3.01	-6.61	8	Pass

NOTE: Directional gain = $10\log[(10^{G1/20} + 10^{G2/20} + \dots + 10^{GN/20})^2 / N_{ANT}] = 2.91 \text{ dBi} < 6 \text{ dBi}$, so the limit no need to reduced.

802.11n (HT40)

TX Chain	Channel	Freq. (MHz)	PSD (dBm/3 kHz)	10 log (N=2) dB	Total PSD (dBm/3 kHz)	Limit (dBm/3 kHz)	Pass / Fail
0	3	2422	-17.34	3.01	-14.33	8	Pass
	6	2437	-11.23	3.01	-8.22	8	Pass
	9	2452	-18.52	3.01	-15.51	8	Pass
1	3	2422	-16.12	3.01	-13.11	8	Pass
	6	2437	-9.22	3.01	-6.21	8	Pass
	9	2452	-16.73	3.01	-13.72	8	Pass

NOTE: Directional gain = $10\log[(10^{G1/20} + 10^{G2/20} + \dots + 10^{GN/20})^2 / N_{ANT}] = 2.91 \text{ dBi} < 6 \text{ dBi}$, so the limit no need to reduced.

Spectrum Plot of Worst Value

802.11b

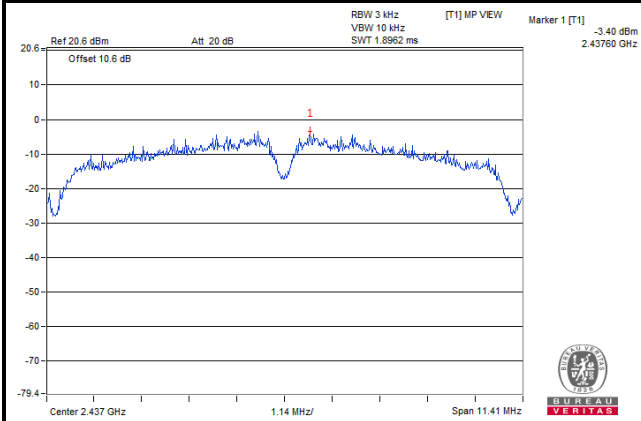

802.11g

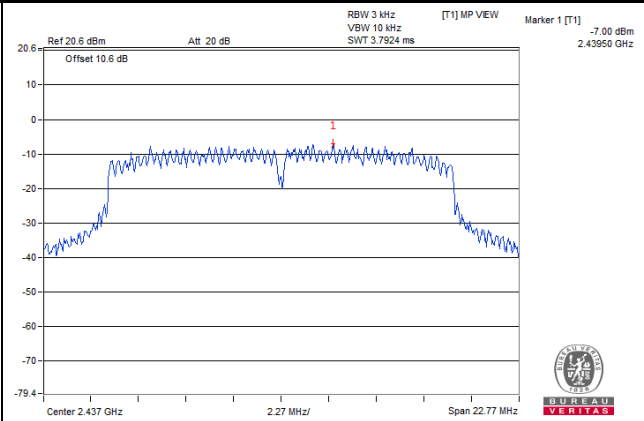

802.11n (HT20)

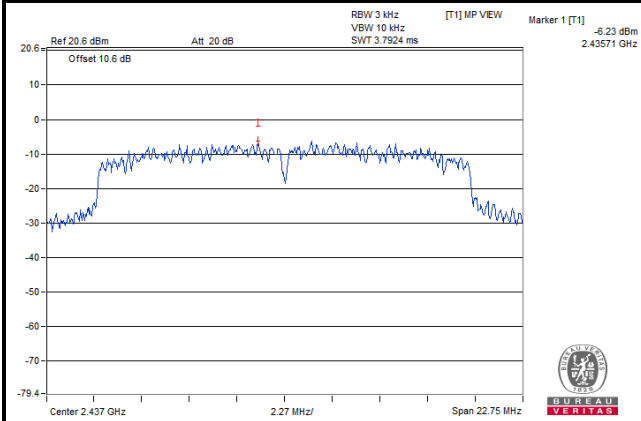

802.11n (HT40)

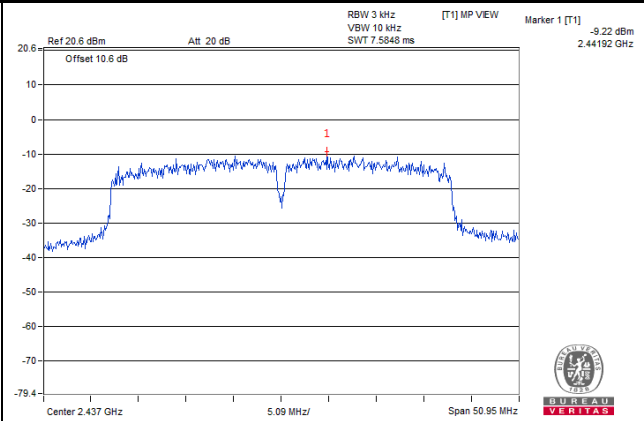

4.7 Conducted Out of Band Emission Measurement

4.7.1 Limits of Conducted Out of Band Emission Measurement

Below 20 dB of the highest emission level of operating band (in 100 kHz Resolution Bandwidth).

4.7.2 Test Setup

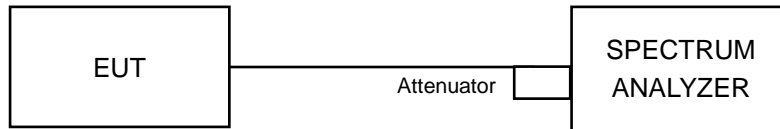

4.7.3 Test Instruments

Refer to section 4.1.2 to get information of above instrument.

4.7.4 Test Procedure

MEASUREMENT PROCEDURE REF

1. Set the RBW = 100 kHz.
2. Set the VBW \geq 300 kHz.
3. Detector = peak.
4. Sweep time = auto couple.
5. Trace mode = max hold.
6. Allow trace to fully stabilize.
7. Use the peak marker function to determine the maximum power level in any 100 kHz band segment within the fundamental EBW.

MEASUREMENT PROCEDURE OOB

1. Set RBW = 100 kHz.
2. Set VBW \geq 300 kHz.
3. Detector = peak.
4. Sweep = auto couple.
5. Trace Mode = max hold.
6. Allow trace to fully stabilize.
7. Use the peak marker function to determine the maximum amplitude level.

4.7.5 Deviation from Test Standard

No deviation.

4.7.6 EUT Operating Condition

The software provided by client to enable the EUT under transmission condition continuously at lowest, middle and highest channel frequencies individually.

4.7.7 Test Results

The spectrum plots are attached on the following images. D1 line indicates the highest level, and D2 line indicates the 20 dB offset below D1. It shows compliance with the requirement.

Mode A

802.11b

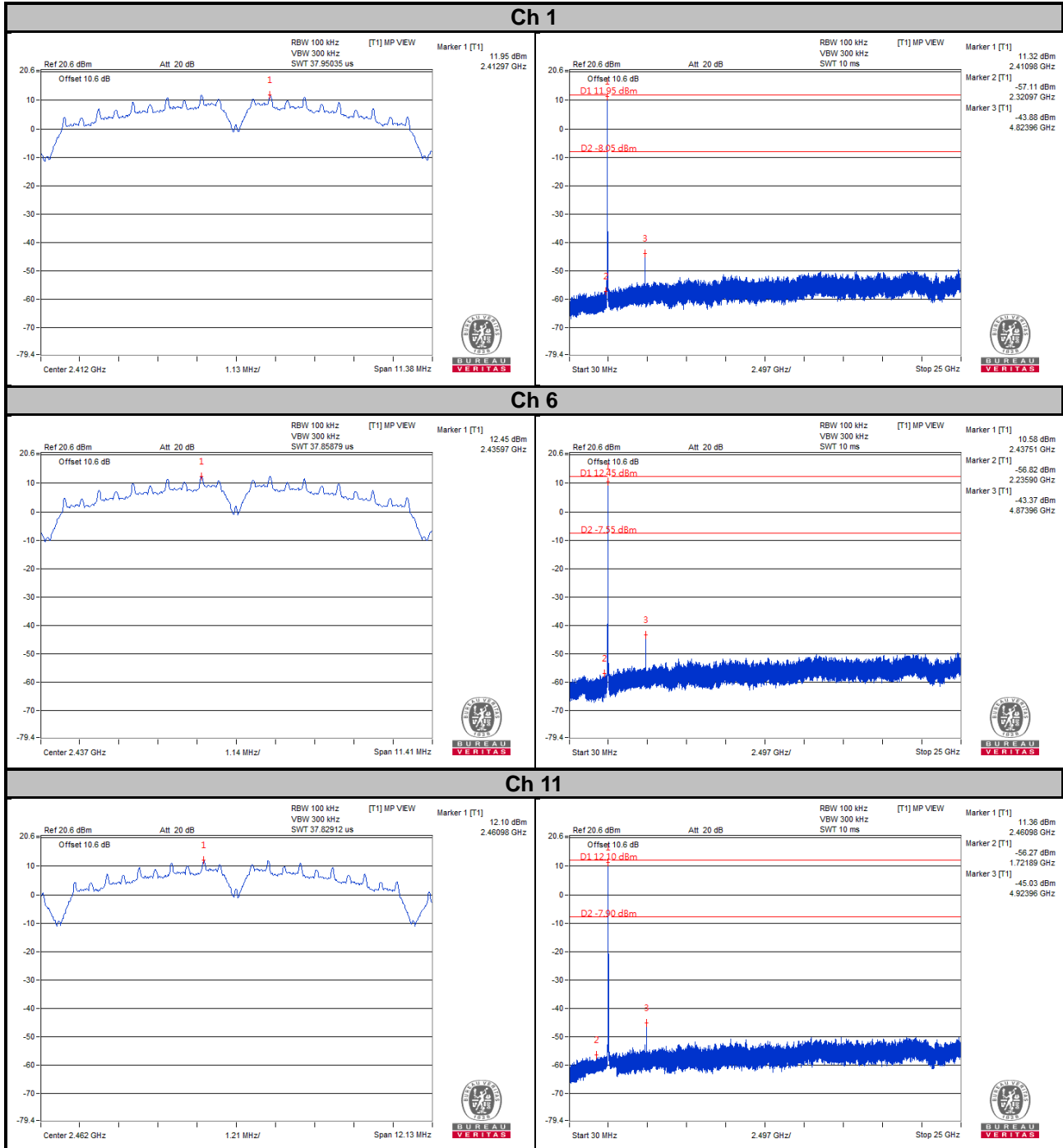

Ch 1 Band Edge

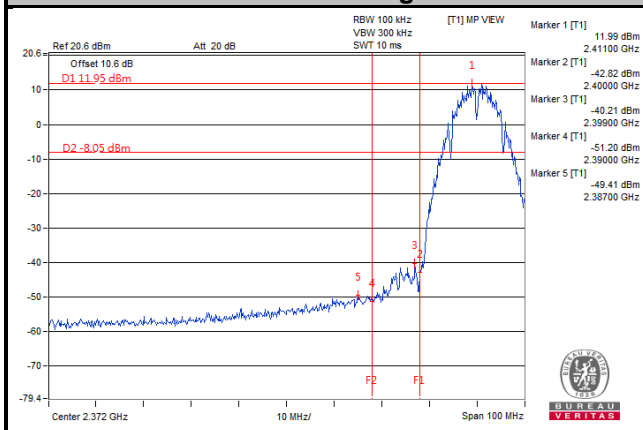

Ch 11 Band Edge

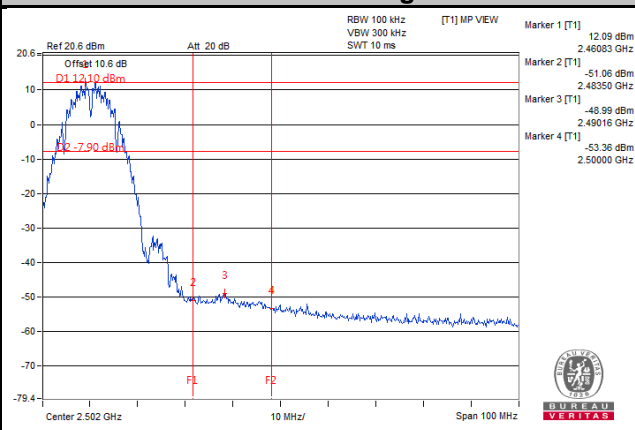

802.11g

Ch 1

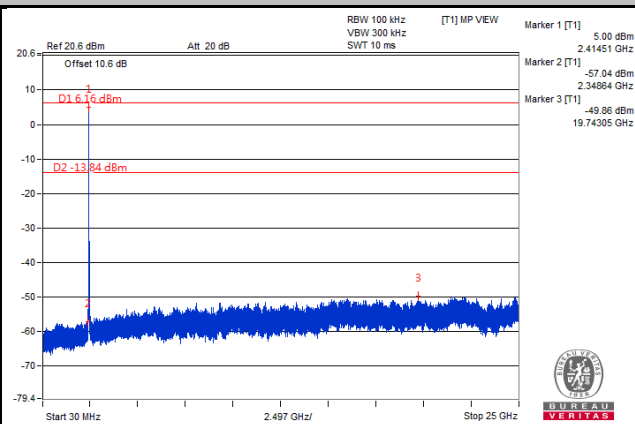
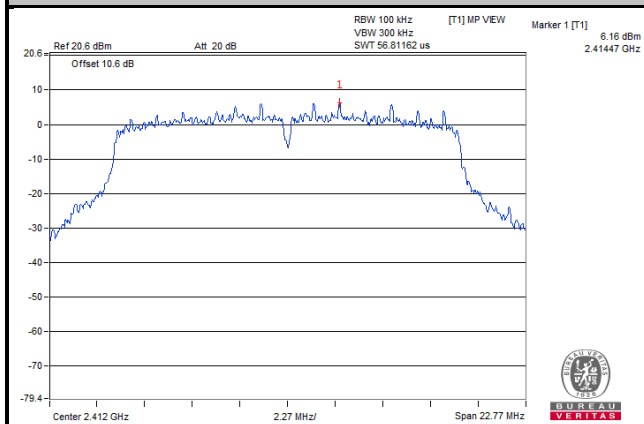

Ch 6

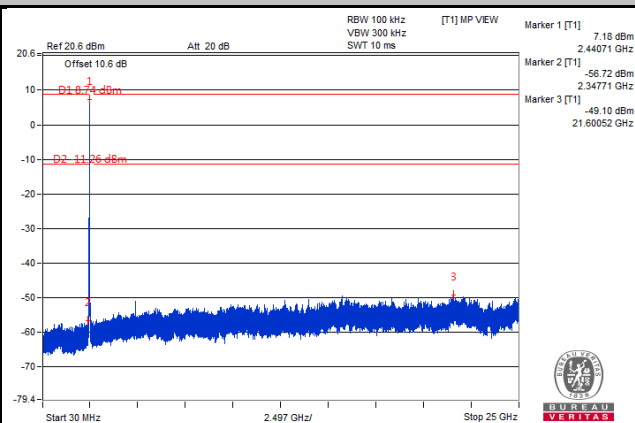
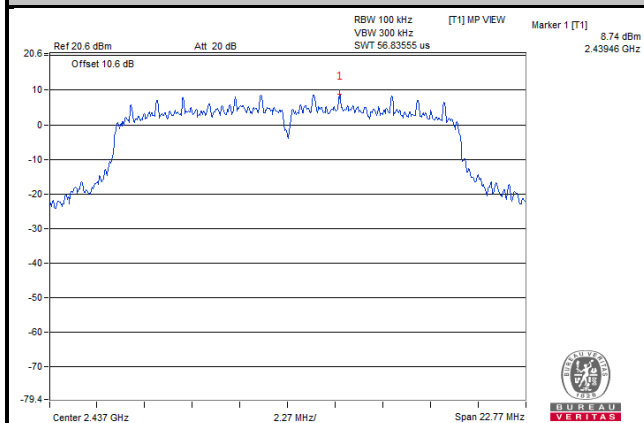

Ch 11

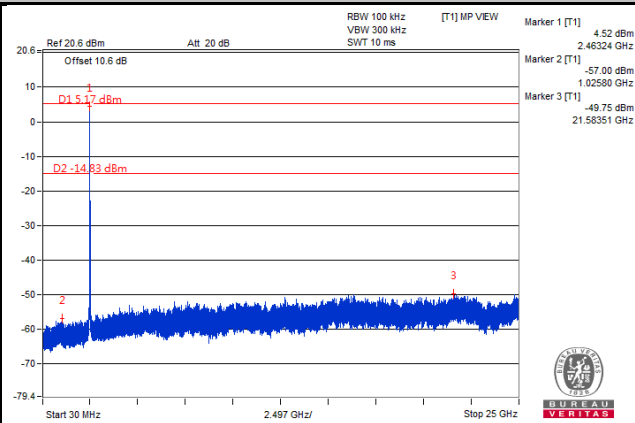
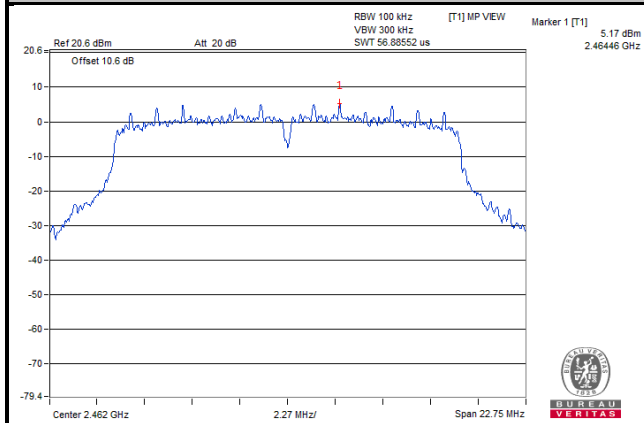

Ch 1 Band Edge

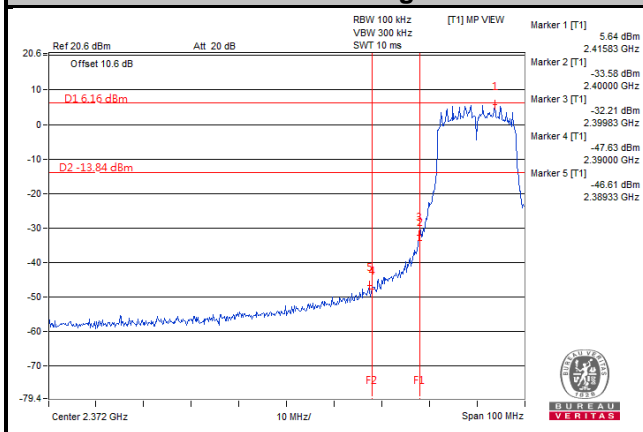

Ch 11 Band Edge

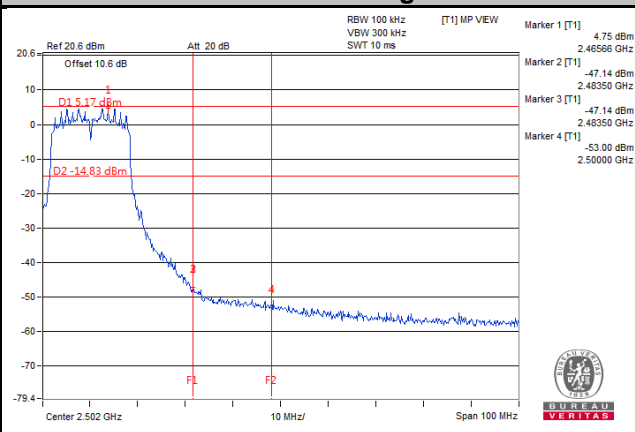

Mode B
802.11n (HT20)
CHAIN 0

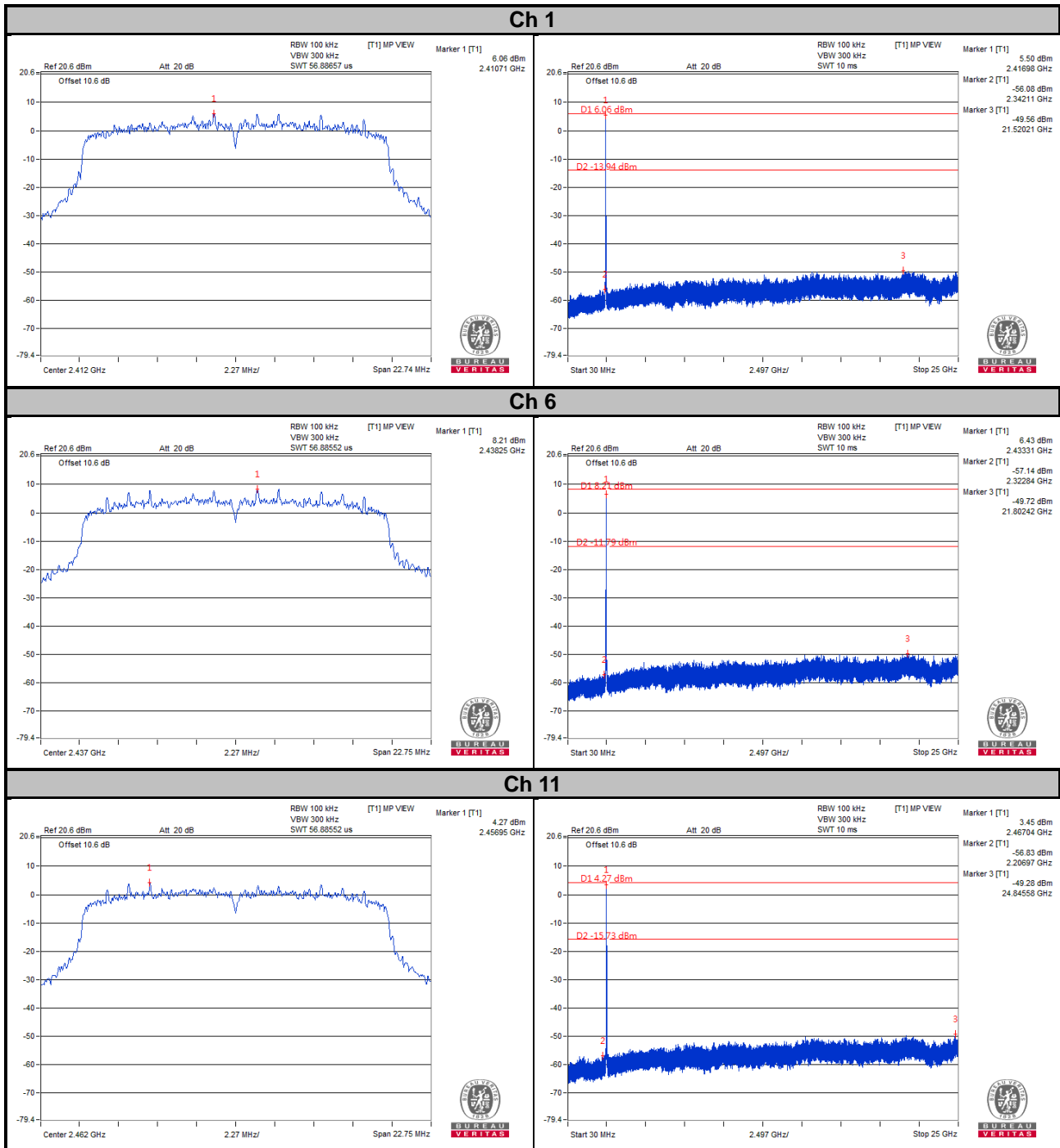

Ch 1 Band Edge

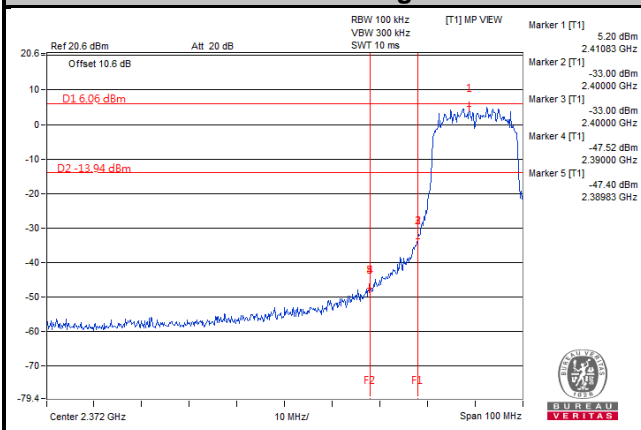

Ch 11 Band Edge

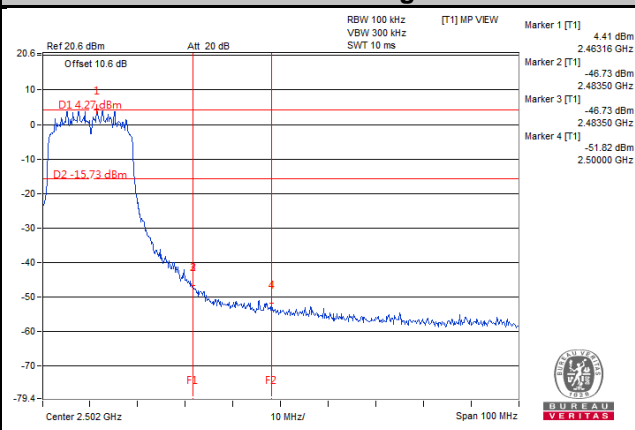

CHAIN 1

Ch 1

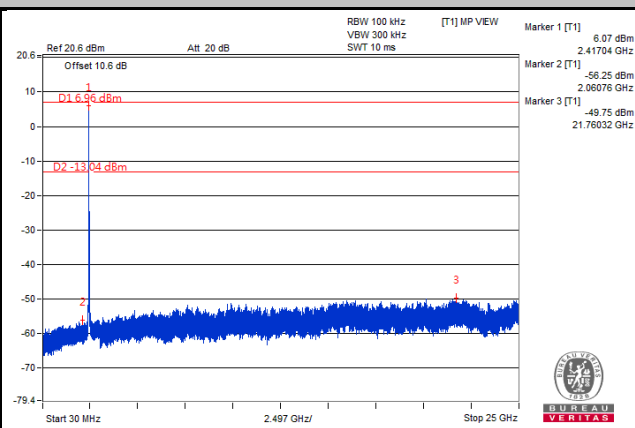
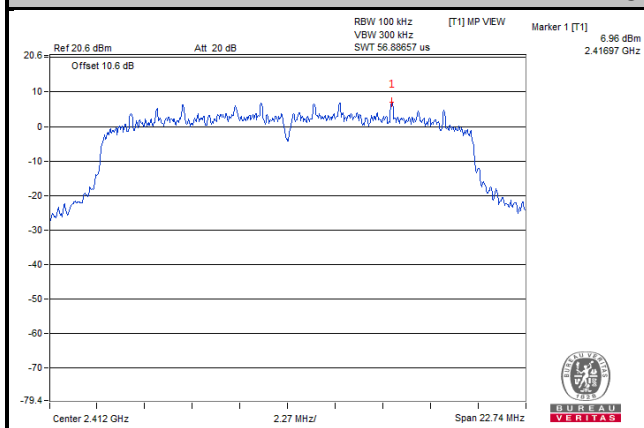

Ch 6

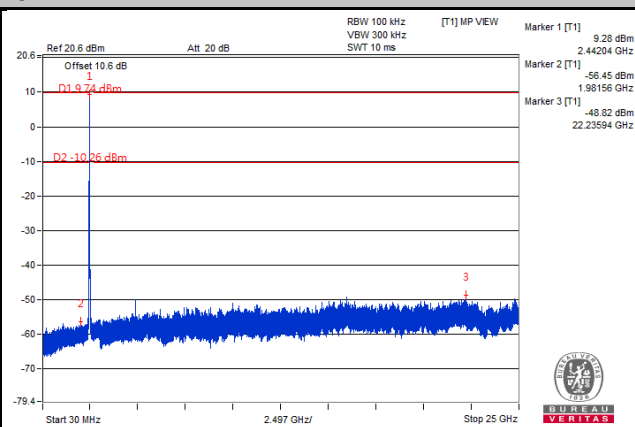
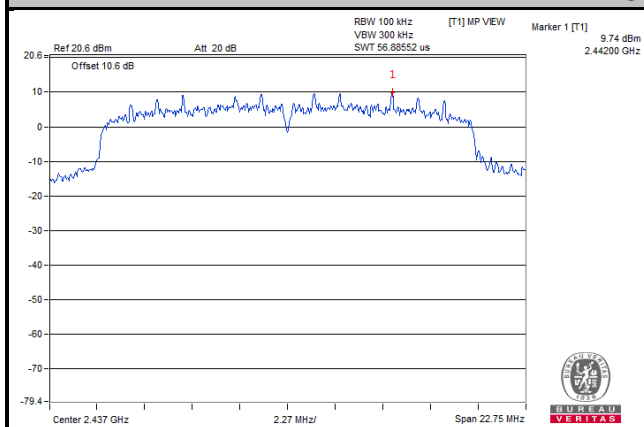

Ch 11

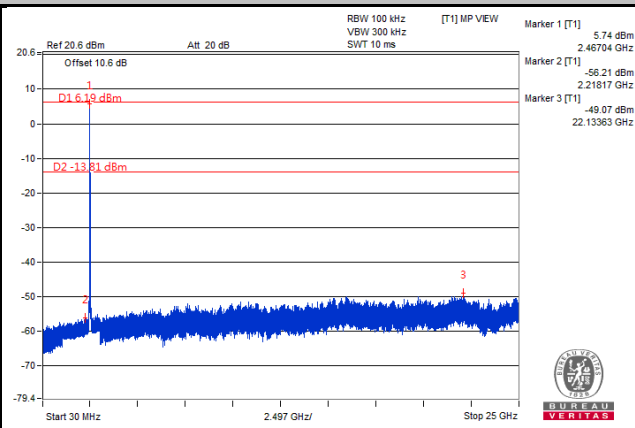
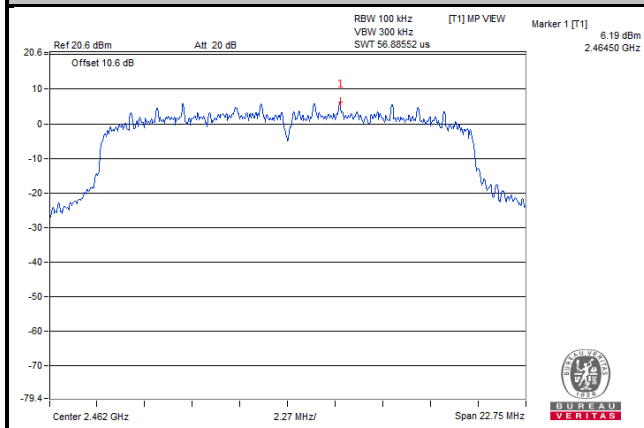

Ch 1 Band Edge

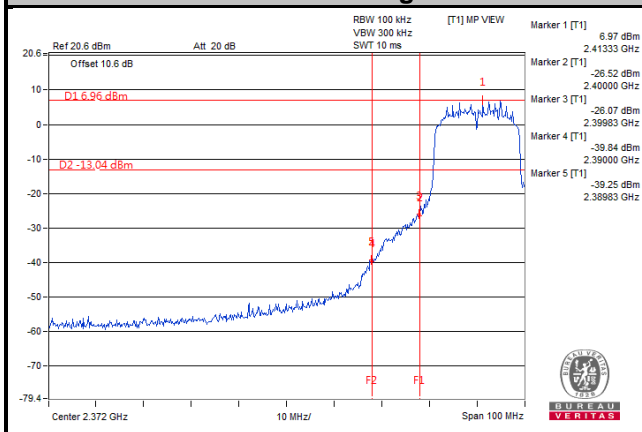

Ch 11 Band Edge

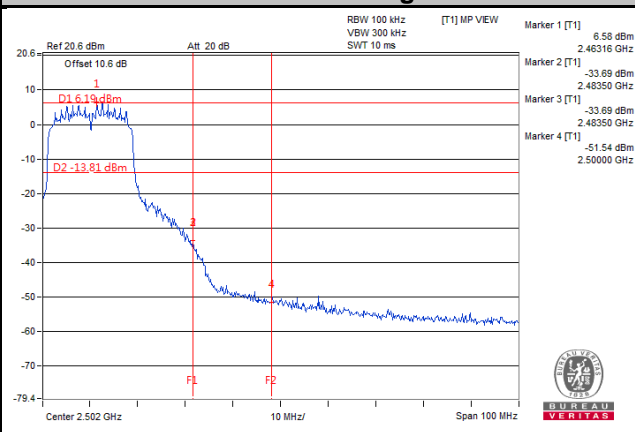

802.11n (HT40)
CHAIN 0

Ch 3

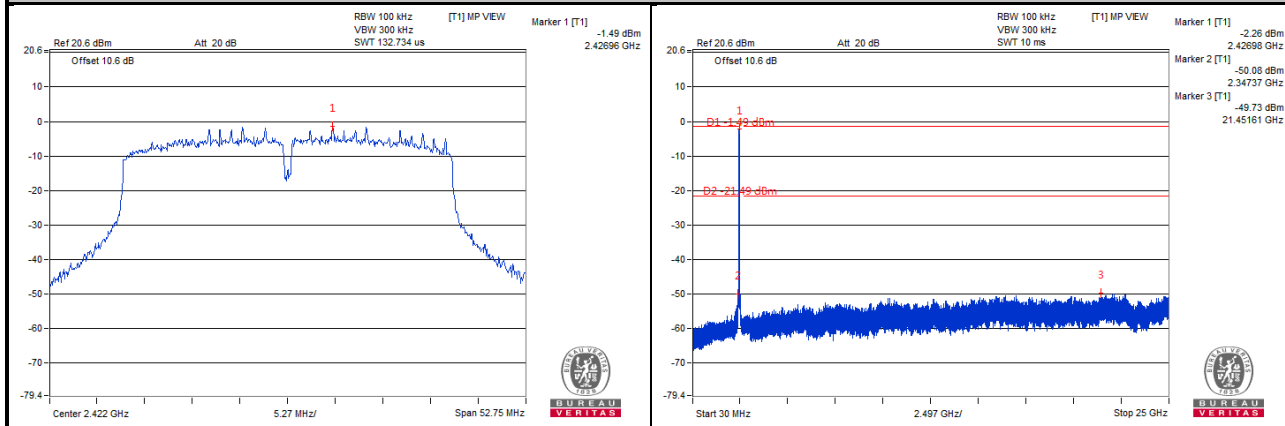

Ch 6

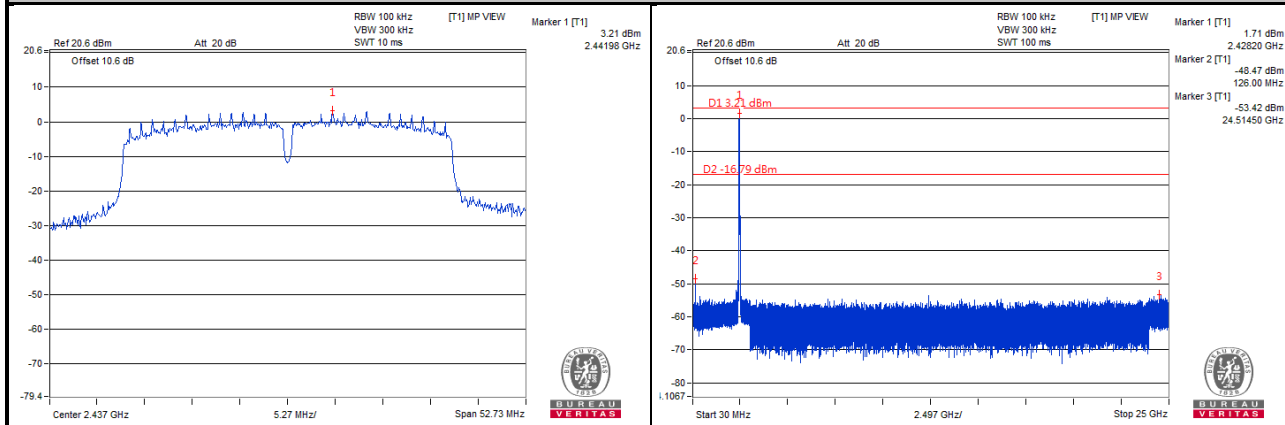

Ch 9

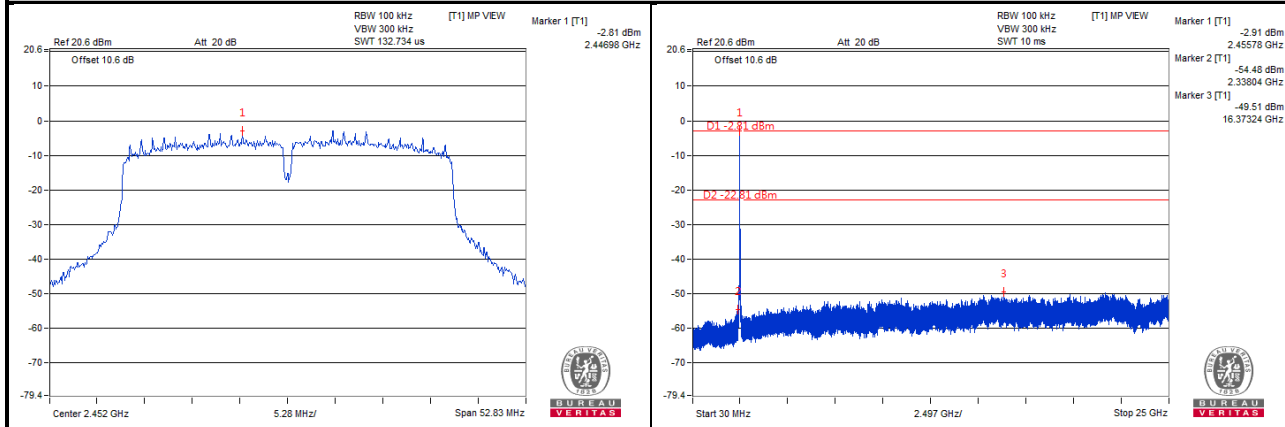

Ch 3 Band Edge

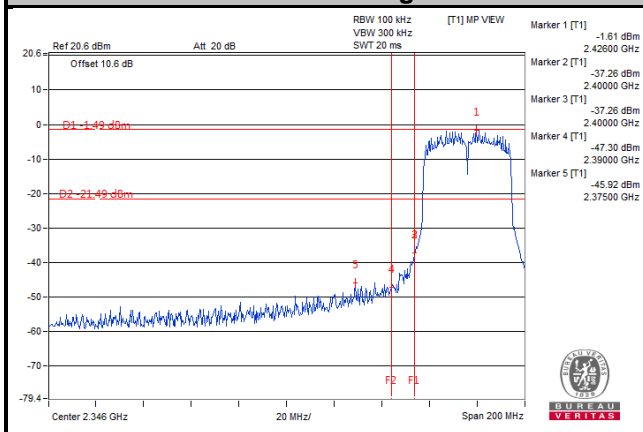

Ch 9 Band Edge

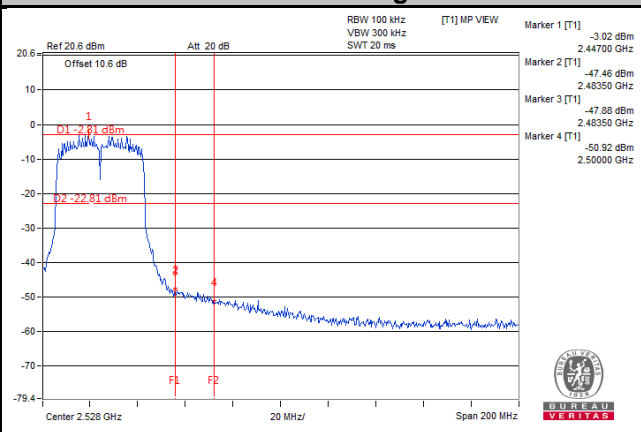

CHAIN 1

Ch 3

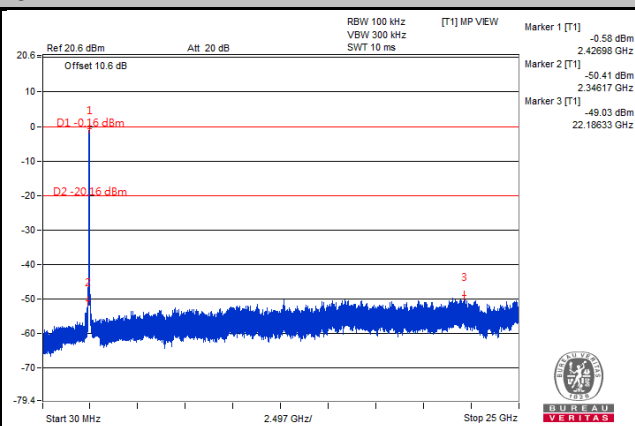
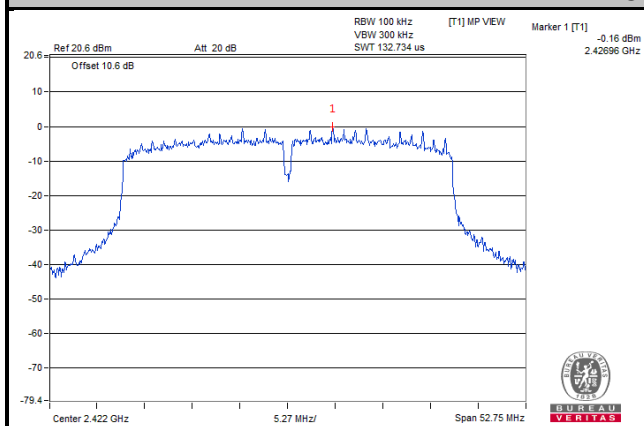

Ch 6

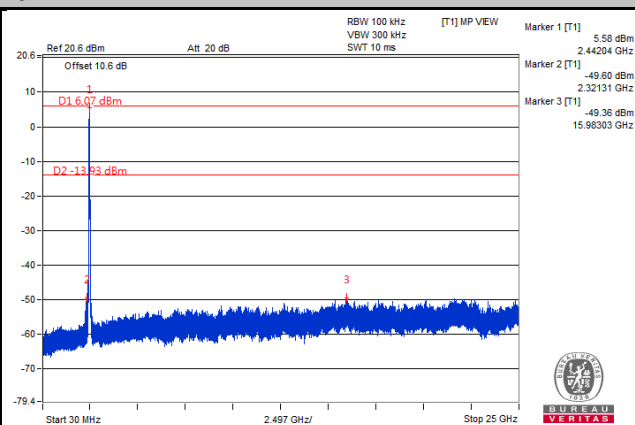
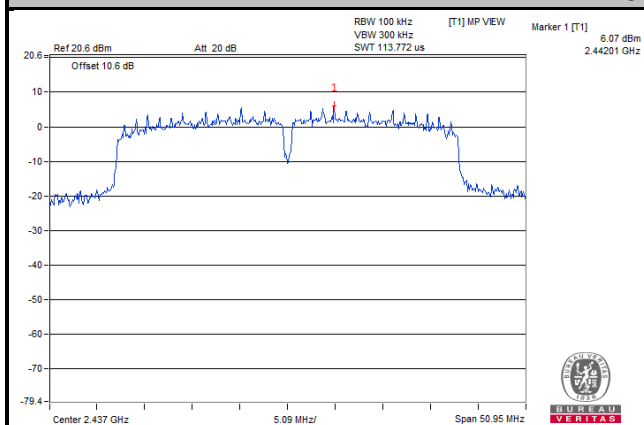

Ch 9

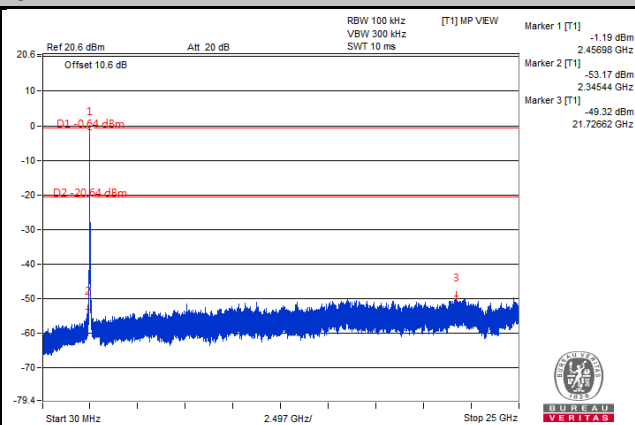
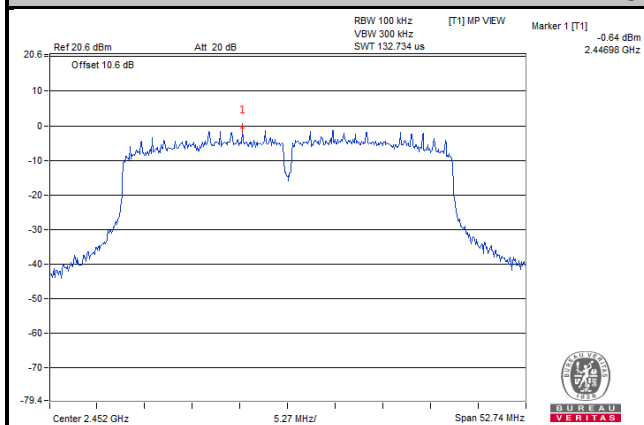

Ch 3 Band Edge

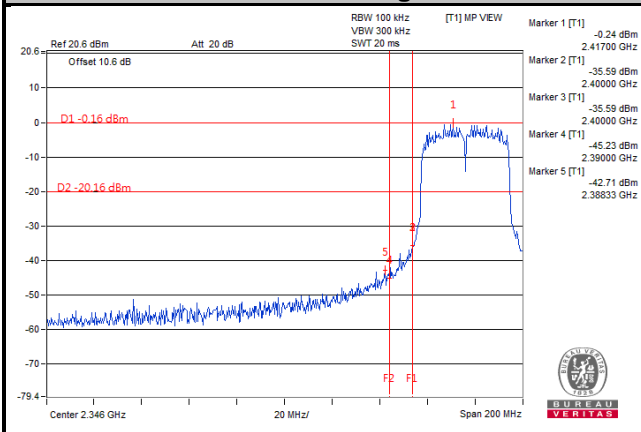

Ch 9 Band Edge

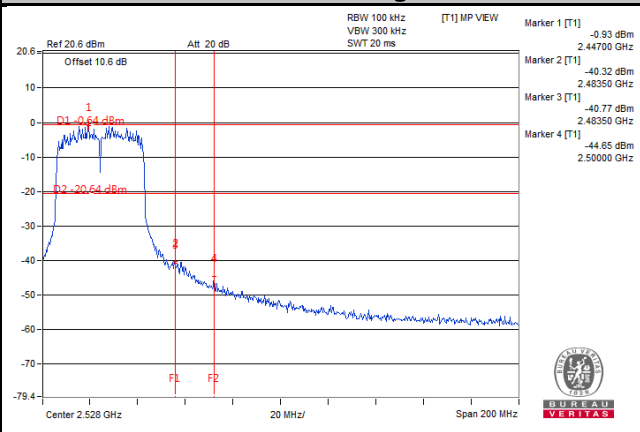

5 Pictures of Test Arrangements

Please refer to the attached file (Test Setup Photo).

Appendix – Information on the Testing Laboratories

We, Bureau Veritas Consumer Products Services (H.K.) Ltd., Taoyuan Branch, were founded in 1988 to provide our best service in EMC, Radio, Telecom and Safety consultation. Our laboratories are FCC recognized accredited test firms and accredited according to ISO/IEC 17025.

If you have any comments, please feel free to contact us at the following:

Linko EMC/RF Lab

Tel: 886-2-26052180

Fax: 886-2-26051924

Hsin Chu EMC/RF/Telecom Lab

Tel: 886-3-6668565

Fax: 886-3-6668323

Hwa Ya EMC/RF/Safety Lab

Tel: 886-3-3183232

Fax: 886-3-3270892

Email: service.adt@tw.bureauveritas.com

Web Site: www.bureauveritas-adt.com

The address and road map of all our labs can be found in our web site also.

--- END ---