

RADIO TEST REPORT

Report No: STS1706006F02

Issued for

General Procurement, INC.

800 E Dyer Road Santa Ana, Ca 92705 Santa Ana California
United States

Product Name:	4.0 inch Smart phone
Brand Name:	HYUNDAI, VULCAN
Model Name:	G24027K
Series Model:	VS4011, T20
FCC ID:	S94G24027K
Test Standard:	FCC Part 15.247

Any reproduction of this document must be done in full. No single part of this document may be reproduced without permission from BZT, All Test Data Presented in this report is only applicable to presented Test sample.

BZT Testing Technology Co., Ltd

Add. : Buliding 17, Xinghua Road Xingwei industrial Park Fuyong,
Baoan District, Shenzhen, Guangdong, China
TEL: +86-755 3307 1680 FAX: +86-755 27341758 E-mail:bruce@bzt.Cn

TEST RESULT CERTIFICATION

Applicant's name : General Procurement,INC.
 Address..... : 800 E Dyer Road Santa Ana,Ca 92705 Santa Ana California United States
Manufacture's Name : Sintave
 Address..... : 6th F, 3rd building, Sangtai Technology Park, Xili Nanshan Shenzhen

Product description

Product name..... : 4.0 inch Smart phone
 Brand name : HYUNDAI, VULCAN
 Model and/or type reference : G24027K
 Series Model : VS4011 , T20

Standards : FCC Part15.247

Test procedure ANSI C63.10-2013

This device described above has been tested by BZT, the test results show that the equipment under test (EUT) is in compliance with the FCC requirements. And it is applicable only to the tested sample identified in the report.

This report shall not be reproduced except in full, without the written approval of BZT, this document may be altered or revised by BZT, personal only, and shall be noted in the revision of the document

Date of Test..... :

Date (s) of performance of tests..... : 02 Jun. 2017~07 Jun. 2017

Date of Issue : 07 Jun. 2017

Test Result : **Pass**

Testing Engineer :



(Leo li)

Technical Manager :



(Tony liu)

Authorized Signatory :



(Vita Li)

Table of Contents	Page
1. SUMMARY OF TEST RESULTS	6
1.1 TEST FACTORY	7
1.2 MEASUREMENT UNCERTAINTY	7
2. GENERAL INFORMATION	8
2.1 GENERAL DESCRIPTION OF EUT	8
2.2 DESCRIPTION OF TEST MODES	10
2.3 BLOCK DIGRAM SHOWING THE CONFIGURATION OF SYSTEM TESTED	11
2.4 DESCRIPTION OF SUPPORT UNITS	12
2.5 EQUIPMENTS LIST FOR ALL TEST ITEMS	13
3. EMC EMISSION TEST	14
3.1 CONDUCTED EMISSION MEASUREMENT	14
3.2 RADIATED EMISSION MEASUREMENT	18
4. CONDUCTED SPURIOUS & BAND EDGE EMISSION	28
4.1 APPLIED PROCEDURES / LIMIT	28
4.2 TEST PROCEDURE	28
4.3 DEVIATION FROM STANDARD	28
4.4 TEST SETUP	28
4.5 EUT OPERATION CONDITIONS	28
4.6 TEST RESULTS	29
5. POWER SPECTRAL DENSITY TEST	38
5.1 APPLIED PROCEDURES / LIMIT	38
5.2 TEST PROCEDURE	38
5.3 DEVIATION FROM STANDARD	38
5.4 TEST SETUP	38
5.5 EUT OPERATION CONDITIONS	38
5.6 TEST RESULTS	39
6. BANDWIDTH TEST	45
6.1 APPLIED PROCEDURES / LIMIT	45
6.2 TEST PROCEDURE	45
6.3 DEVIATION FROM STANDARD	45
6.4 TEST SETUP	45
6.5 EUT OPERATION CONDITIONS	45
6.6 TEST RESULTS	46

Table of Contents	Page
7. PEAK OUTPUT POWER TEST	52
7.1 APPLIED PROCEDURES / LIMIT	52
7.2 TEST PROCEDURE	52
7.3 DEVIATION FROM STANDARD	52
7.4 TEST SETUP	52
7.5 EUT OPERATION CONDITIONS	52
7.6 TEST RESULTS	53
8. ANTENNA REQUIREMENT	54
8.1 STANDARD REQUIREMENT	54
8.2 EUT ANTENNA	54
APPENDIX - PHOTOS OF TEST SETUP	55

Revision History

Rev.	Issue Date	Report NO.	Effect Page	Contents
00	07 Jun. 2017	STS1706006F02	ALL	Initial Issue

1. SUMMARY OF TEST RESULTS

Test procedures according to the technical standards:
KDB 558074 D01 DTS Meas Guidance v04

FCC Part 15.247,Subpart C			
Standard Section	Test Item	Judgment	Remark
15.207	Conducted Emission	PASS	
15.247 (a)(2)	6dB Bandwidth	PASS	
15.247 (b)(3)	Output Power	PASS	
15.247 (c)	Radiated Spurious Emission	PASS	
15.247 (d)	Conducted Spurious & Band Edge Emission	PASS	
15.247 (e)	Power Spectral Density	PASS	
15.205	Restricted Band Edge Emission	PASS	
Part 15.247(d)/part 15.209(a)	Band Edge Emission	PASS	
15.203	Antenna Requirement	PASS	

NOTE:

(1) "N/A" denotes test is not applicable in this Test Report

(2) all tests are according to ANSI C63.10-2013 .

1.1 TEST FACTORY

BZT Testing Technology Co., Ltd.

Add. : Buliding 17, Xinghua Road Xingwei industrial Park Fuyong,
Baoan District, Shenzhen, Guangdong, China

FCC Registration No.: 701733

1.2 MEASUREMENT UNCERTAINTY

The reported uncertainty of measurement $y \pm U$, where expanded uncertainty U is based on a standard uncertainty multiplied by a coverage factor of $k=2$, providing a level of confidence of approximately 95 %.

No.	Item	Uncertainty
1	Conducted Emission (9KHz-150KHz)	$\pm 2.88\text{dB}$
2	Conducted Emission (150KHz-30MHz)	$\pm 2.67\text{dB}$
3	RF power,conducted	$\pm 0.70\text{dB}$
4	Spurious emissions,conducted	$\pm 1.19\text{dB}$
5	All emissions,radiated(<30M) (9KHz-30MHz)	$\pm 2.45\text{dB}$
6	All emissions,radiated(<1G) 30MHz-200MHz	$\pm 2.83\text{dB}$
7	All emissions,radiated(<1G) 200MHz-1000MHz	$\pm 2.94\text{dB}$
8	All emissions,radiated(>1G)	$\pm 3.03\text{dB}$
9	Temperature	$\pm 0.5^{\circ}\text{C}$
10	Humidity	$\pm 2\%$

2. GENERAL INFORMATION

2.1 GENERAL DESCRIPTION OF EUT

Equipment	4.0 inch Smart phone	
Trade Name	HYUNDAI, VULCAN	
Model Name	G24027K	
Series Model	VS4011, T20	
Model Difference	Only different in model name and brand name.	
Product Description	The EUT is a 4.0 inch Smart phone	
	Operation Frequency:	802.11b/g/n 20: 2412~2462 MHz
	Modulation Type:	CCK/BPSK/QPSK/16QAM
	Bit Rate of Transmitter:	802.11b:11/5.5/2/1 Mbps 802.11g:54/48/36/24/18/12/9/6 Mbps 802.11n(20MHz): 65/58.5/52/39/26/19.5/13/6.5 Mbps
	Number Of Channel:	802.11b/g/n20: 11CH
	Antenna Designation:	Please see Note 3.
	Antenna Gain (dBi):	1.43 dBi
	Duty Cycle:	>98%
Channel List	Please refer to the Note 2.	
Adapter	Input: AC100-240V, 0.4A, 50/60 Hz Output: DC 5V, 1000mA	
Battery	Rated Voltage: 3.8V capacity :1400mAh	
Hardware version number	T825W3-V1.1	
Software version number	HYUNDAI_ G24027K_V01 VULCAN_ VS4011_V01	
Connecting I/O Port(s)	Please refer to the User's Manual	

Note:

- 1 For a more detailed features description, please refer to the manufacturer's specifications or the User's Manual.

2

Operation Frequency of channel	
802.11b/g/n(20MHz)	
Channel	Frequency
01	2412
02	2417
03	2422
04	2427
05	2432
06	2437
07	2442
08	2447
09	2452
10	2457
11	2462

- 3 Note:
In section 15.31(m), regards to the operating frequency range over 10 MHz, the Lowest frequency, the middle frequency, and the highest frequency of channel were selected to perform the test, and the selected channel see below:
Carrier Frequency Channel

2.4GHz Test Frequency:

For 802.11b/g/n (HT20)	
Channel	Freq.(MHz)
01	2412
06	2437
11	2462

3

Ant	Brand	Model Name	Antenna Type	Connector	Gain (dBi)	NOTE
1	HYUNDAI, VULCAN	G24027K	PIFA Antenna	N/A	1.43	WIFI Antenna

2.2 DESCRIPTION OF TEST MODES

Each of these EUT operation mode(s) or test configuration mode(s) mentioned above was evaluated respectively.

Worst Mode	Description	Data Rate
Mode 1	TX IEEE 802.11b CH1	1 Mbps
Mode 2	TX IEEE 802.11b CH6	1 Mbps
Mode 3	TX IEEE 802.11 b CH11	1 Mbps
Mode 4	TX IEEE 802.11g CH1	6 Mbps
Mode 5	TX IEEE 802.11g CH6	6 Mbps
Mode 6	TX IEEE 802.11g CH11	6 Mbps
Mode 7	TX IEEE 802.11n HT20 CH1	MCS 0
Mode 8	TX IEEE 802.11n HT20 CH6	MCS 0
Mode 9	TX IEEE 802.11n HT20 CH11	MCS 0

Note:

- (1) The measurements are performed at all Bit Rate of Transmitter, the worst data was reported
- (2) We have be tested for all available U.S. voltage and frequencies (For 120V,50/60Hz and 240V,50/60Hz) for which the device is capable of operation.
- (3) The EUT was programmed to be in continuously transmitting mode and the transmit duty cycle is not less than 98%.

AC Conducted Emission

Test Case	
AC Conducted Emission	Mode10: Keeping WIFI TX

2.3 BLOCK DIGRAM SHOWING THE CONFIGURATION OF SYSTEM TESTED

Radiation Test Set

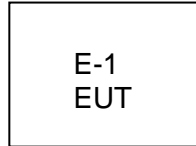

conduction Test Set

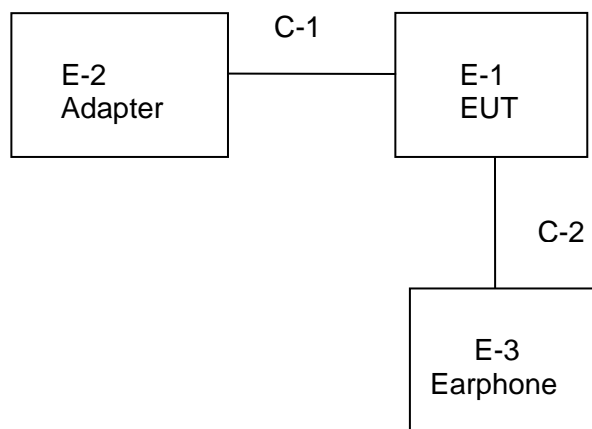

2.4 DESCRIPTION OF SUPPORT UNITS

The EUT has been tested as an independent unit together with other necessary accessories or support units. The following support units or accessories were used to form a representative test configuration during the tests.

Item	Equipment	Mfr/Brand	Model/Type No.	Serial No.	Note
E-1	4.0 inch Smart phone	HYUNDAI, VULCAN	G24027K	N/A	EUT
E-2	Adapter	HYUNDAI	RWX-AA050100U	N/A	EUT
E-3	Earphone	N/A	N/A	N/A	EUT

Item	Shielded Type	Ferrite Core	Length	Note
C-1	USB Cable shielded line (Charging)	NO	100cm	N/A
C-2	Earphone Line	NO	110cm	N/A

Note:

- (1) The support equipment was authorized by Declaration of Confirmation.
- (2) For detachable type I/O cable should be specified the length in cm in 『Length』 column.
- (3) “YES” is means “shielded” “with core”; “NO” is means “unshielded” “without core”.

2.5 EQUIPMENTS LIST FOR ALL TEST ITEMS

Radiation Test equipment

Kind of Equipment	Manufacturer	Type No.	Serial No.	Last calibration	Calibrated until
Spectrum Analyzer	Agilent	E4407B	MY50140340	2016.10.23	2017.10.22
Test Receiver	R&S	ESCI	101427	2016.10.23	2017.10.22
Bilog Antenna	TESEQ	CBL6111D	34678	2014.11.24	2017.11.23
Horn Antenna	Schwarzbeck	BBHA 9120D(1201)	9120D-1343	2015.03.05	2018.03.04
Horn Antenna	Schwarzbeck	BBHA 9170	9170-0741	2016.03.06	2019.03.05
50Ω Coaxial Switch	Anritsu	MP59B	6200264416	2016.10.23	2017.10.22
PreAmplifier	Agilent	8449B	60538	2016.10.23	2017.10.22
Loop Antenna	EMCO	6502	9003-2485	2016.03.06	2019.03.05
Preamplifier	Agilent	8449B	60538	2016.10.23	2017.10.22
Low frequency cable	EM	R01	N/A	NCR	NCR
High frequency cable	SCHWARZBECK	AK9515H	SN-96286/96287	NCR	NCR
Semi-anechoic chamber	Changling	966	N/A	2016.10.23	2017.10.22

Conduction Test equipment

Kind of Equipment	Manufacturer	Type No.	Serial No.	Last calibration	Calibrated until
EMI Test Receiver	R&S	ESPI	102086	2016.10.23	2017.10.22
LISN	R&S	ENV216	101242	2016.10.23	2017.10.22
LISN	EMCO	3810/2NM	000-23625	2016.10.23	2017.10.22
Conduction Cable	EM	C01	N/A	NCR	NCR
Shielding Room	Changling	854	N/A	2016.10.23	2017.10.22

RF Connected Test

Kind of Equipment	Manufacturer	Type No.	Serial No.	Last calibration	Calibrated until
USB RF power sensor	DARE	RPR3006W	15I00041SNO03	2016.10.23	2017.10.22
Spectrum Analyzer	Agilent	E4407B	MY50140340	2016.10.23	2017.10.22
Signal Analyzer	Agilent	N9020A	MY49100060	2016.10.23	2017.10.22

3. EMC EMISSION TEST

3.1 CONDUCTED EMISSION MEASUREMENT

3.1.1 POWER LINE CONDUCTED EMISSION LIMITS

operating frequency band. In case the emission fall within the restricted band specified on Part 15. 207(a) limit in the table below has to be followed.

FREQUENCY (MHz)	Conducted Emission limit (dBuV)	
	Quasi-peak	Average
0.15 -0.5	66 - 56 *	56 - 46 *
0.50 -5.0	56.00	46.00
5.0 -30.0	60.00	50.00

Note:

- (1) The tighter limit applies at the band edges.
- (2) The limit of " * " marked band means the limitation decreases linearly with the logarithm of the frequency in the range.

The following table is the setting of the receiver

Receiver Parameters	Setting
Attenuation	10 dB
Start Frequency	0.15 MHz
Stop Frequency	30 MHz
IF Bandwidth	9 kHz

3.1.2 TEST PROCEDURE

- a. The EUT was 0.8 meters from the horizontal ground plane and 0.4 meters from the vertical ground plane with EUT being connected to the power mains through a line impedance stabilization network (LISN). All other support equipments powered from additional LISN(s). The LISN provide 50 Ohm/ 50uH of coupling impedance for the measuring instrument.
- b. Interconnecting cables that hang closer than 40 cm to the ground plane shall be folded back and forth in the center forming a bundle 30 to 40 cm long.
- c. I/O cables that are not connected to a peripheral shall be bundled in the center. The end of the cable may be terminated, if required, using the correct terminating impedance. The overall length shall not exceed 1 m.
- d. LISN at least 80 cm from nearest part of EUT chassis.
- e. For the actual test configuration, please refer to the related Item –EUT Test Photos.

3.1.3 TEST SETUP

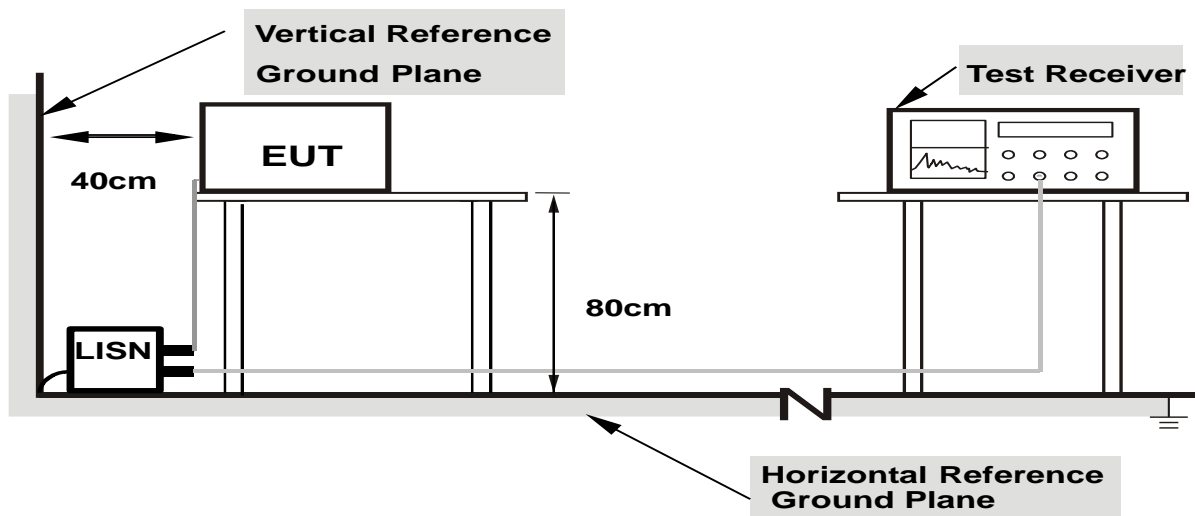

Note: 1.Support units were connected to second LISN.

2.Both of LISNs (AMN) are 80 cm from EUT and at least 80 from other units and other metal planes

3.1.4 EUT OPERATING CONDITIONS

The EUT was configured for testing in a typical fashion (as a customer would normally use it). The EUT has been programmed to continuously transmit during test. This operating condition was tested and used to collect the included data.

3.1.5 TEST RESULT

Temperature:	23.1 °C	Relative Humidity:	60%
Pressure:	1010hPa	Phase:	L
Test Voltage:	AC 120V/60Hz	Test Mode:	Mode 10

Frequency (MHz)	Reading (dBUV)	Correct Factor(dB)	Result (dBUV)	Limit (dBUV)	Margin (dB)	Remark
0.1580	40.45	9.23	49.68	65.57	-15.89	QP
0.1580	24.87	9.23	34.10	55.57	-21.47	AVG
0.1980	35.22	9.23	44.45	63.69	-19.24	QP
0.1980	17.43	9.23	26.66	53.69	-27.03	AVG
0.5500	36.70	9.17	45.87	56.00	-10.13	QP
0.5500	18.03	9.17	27.20	46.00	-18.80	AVG
1.0340	38.23	9.15	47.38	56.00	-8.62	QP
1.0340	17.52	9.15	26.67	46.00	-19.33	AVG
3.3780	29.64	9.26	38.90	56.00	-17.10	QP
3.3780	9.30	9.26	18.56	46.00	-27.44	AVG
5.7940	28.46	9.27	37.73	60.00	-22.27	QP
5.7940	6.31	9.27	15.58	50.00	-34.42	AVG

Remark:

1. All readings are Quasi-Peak and Average values.
2. Margin = Result (Result = Reading + Factor) – Limit

100.0 dBUV

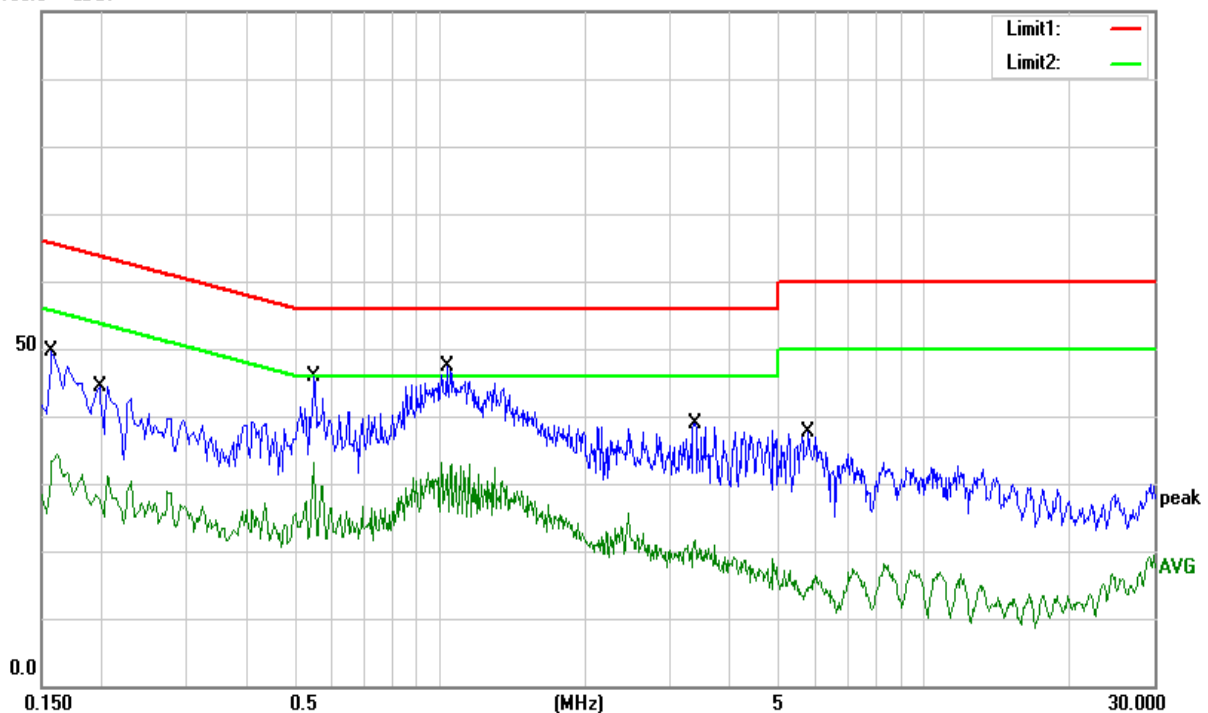

Temperature:	23.1 °C	Relative Humidity:	60%
Pressure:	1010hPa	Phase:	N
Test Voltage:	AC 120V/60Hz	Test Mode:	Mode 10

Frequency (MHz)	Reading (dBuV)	Correct Factor(dB)	Result (dBuV)	Limit (dBuV)	Margin (dB)	Remark
0.1780	37.73	9.23	46.96	64.58	-17.62	QP
0.1780	20.60	9.23	29.83	54.58	-24.75	AVG
0.2700	31.62	9.16	40.78	61.12	-20.34	QP
0.2700	22.62	9.16	31.78	51.12	-19.34	AVG
0.5460	38.24	9.16	47.40	56.00	-8.60	QP
0.5460	32.27	9.16	41.43	46.00	-4.57	AVG
1.0700	37.63	9.16	46.79	56.00	-9.21	QP
1.0700	28.07	9.16	37.23	46.00	-8.77	AVG
2.1460	33.57	9.26	42.83	56.00	-13.17	QP
2.1460	20.00	9.26	29.26	46.00	-16.74	AVG
3.4740	31.32	9.26	40.58	56.00	-15.42	QP
3.4740	19.62	9.26	28.88	46.00	-17.12	AVG

Remark:

- All readings are Quasi-Peak and Average values.
- Margin = Result (Result = Reading + Factor) - Limit

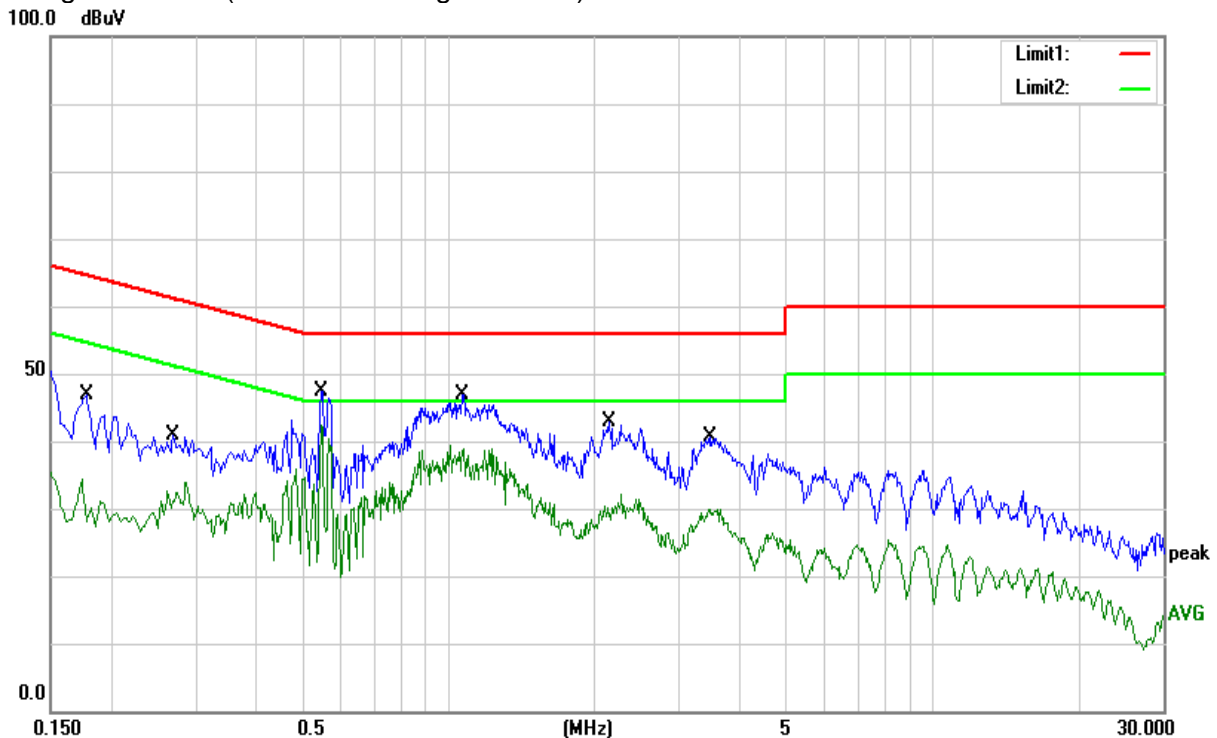

3.2 RADIATED EMISSION MEASUREMENT

3.2.1 RADIATED EMISSION LIMITS

in any 100 kHz bandwidth outside the operating frequency band. In case the emission fall within the Restricted band specified on Part15.205(a)&209(a) limit in the table and according to ANSI C63.10-2013 below has to be followed.

LIMITS OF RADIATED EMISSION MEASUREMENT (0.009MHz - 1000MHz)

Frequencies (MHz)	Field Strength (micovolts/meter)	Measurement Distance (meters)
0.009~0.490	2400/F(KHz)	300
0.490~1.705	24000/F(KHz)	30
1.705~30.0	30	30
30~88	100	3
88~216	150	3
216~960	200	3
Above 960	500	3

LIMITS OF RADIATED EMISSION MEASUREMENT (1000MHz-25GHz)

FREQUENCY (MHz)	(dBuV/m) (at 3M)	
	PEAK	AVERAGE
Above 1000	74	54

Notes:

- (1) The limit for radiated test was performed according to FCC PART 15C.
- (2) The tighter limit applies at the band edges.
- (3) Emission level (dBuV/m)=20log Emission level (uV/m).

For Radiated Emission

Spectrum Parameter	Setting
Attenuation	Auto
Detector	Peak
Start Frequency	1000 MHz(Peak/AV)
Stop Frequency	10th carrier hamonic(Peak/AV)
RB / VB (emission in restricted band)	1 MHz /3MHz

For Band edge

Spectrum Parameter	Setting
Detector	Peak
Start/Stop Frequency	Lower Band Edge: 2300 to 2412 MHz Upper Band Edge: 2462 to 2500 MHz
RB / VB (emission in restricted band)	1 MHz /3MHz

Receiver Parameter	Setting
Start ~ Stop Frequency	9kHz~90kHz / RB 200Hz for PK & AV
Start ~ Stop Frequency	90kHz~110kHz / RB 200Hz for QP
Start ~ Stop Frequency	110kHz~490kHz / RB 200Hz for PK & AV
Start ~ Stop Frequency	490kHz~30MHz / RB 9kHz for QP
Start ~ Stop Frequency	30MHz~1000MHz / RB 120kHz for QP

3.2.2 TEST PROCEDURE

- a. The measuring distance of at 3 m shall be used for measurements at frequency 0.009MHz up to 1GHz, and above 1GHz
- b. The EUT was placed on the top of a rotating table 0.8 meters(above 1GHz is 1.5 m) above the ground at a 3 meter anechoic chamber. The table was rotated 360 degrees to determine the position of the highest radiation.
- c. The height of the equipment shall be 0.8 m(above 1GHz is 1.5 m); the height of the test antenna shall vary between 1 m to 4 m. Horizontal and vertical polarizations of the antenna are set to make the measurement
- d. The initial step in collecting conducted emission data is a spectrum analyzer peak detector mode pre-scanning the measurement frequency range. Significant peaks are then marked and then Quasi Peak detector mode re-measured.
- e. If the Peak Mode measured value compliance with and lower than Quasi Peak Mode Limit, the EUT shall be deemed to meet QP Limits and then no additional QP Mode measurement performed.
- f. For the actual test configuration, please refer to the related Item –EUT Test Photos.

Note:

Both horizontal and vertical antenna polarities were tested and performed test to three orthogonal axis. The worst case emissions were reported

3.2.3 TEST SETUP

(A) Radiated Emission Test-Up Frequency Below 30MHz

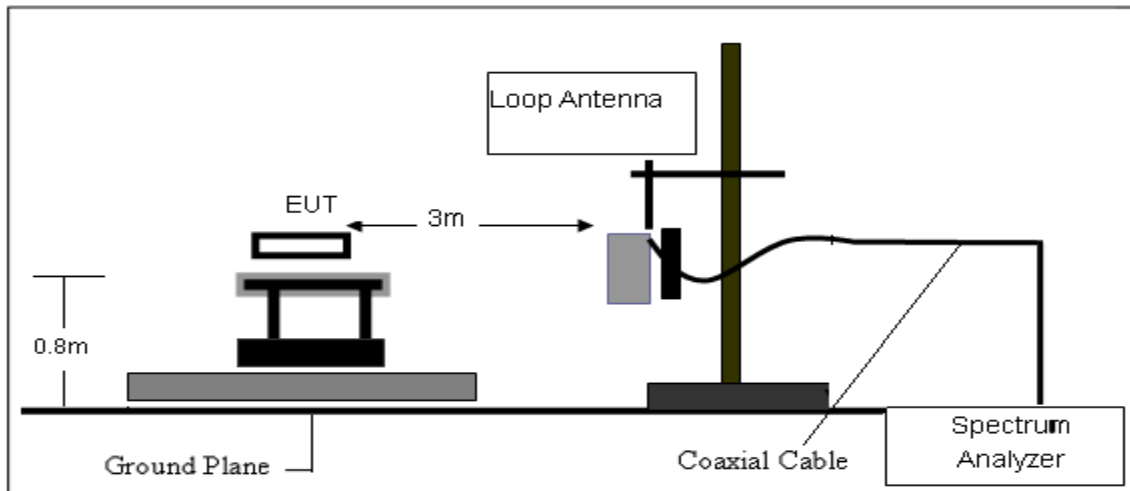

(B) Radiated Emission Test-Up Frequency 30MHz~1GHz

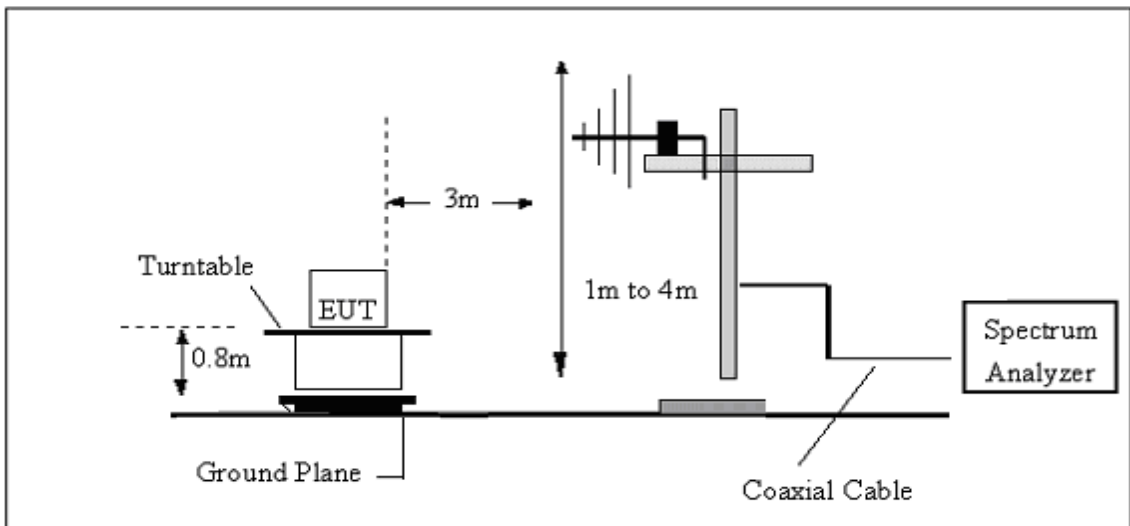

(C) Radiated Emission Test-Up Frequency Above 1GHz

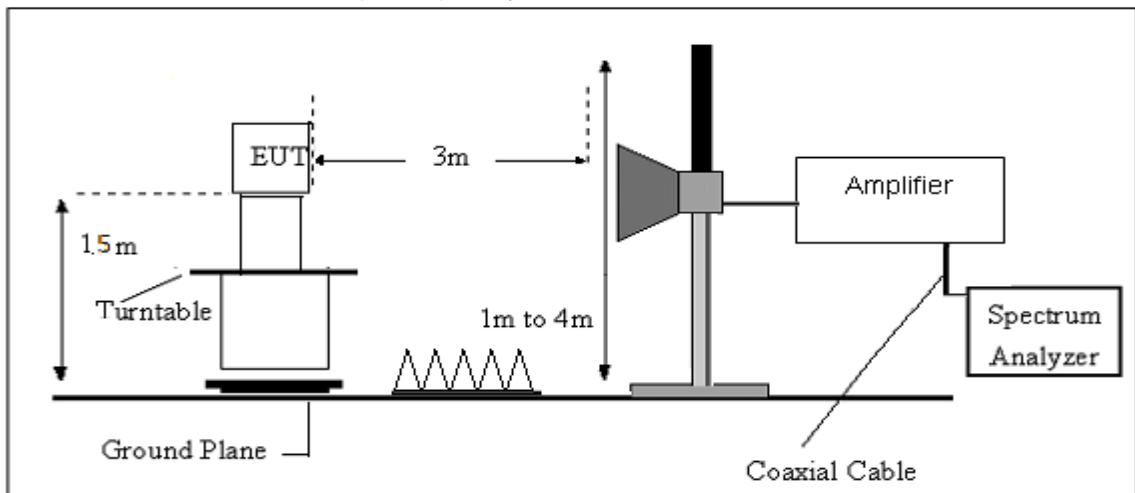

3.2.4 EUT OPERATING CONDITIONS

The EUT tested system was configured as the statements of 2.3 Unless otherwise a special operating condition is specified in the follows during the testing.

3.2.5 TEST RESULT

9KHz-30MHz

Temperature:	23.1 °C	Relative Humidity:	60%
Pressure:	1010 hPa	Test Voltage:	DC 3.8V From Battery
Test Mode:	TX Mode	Polarization:	--

Freq. (MHz)	Reading (dBuV/m)	Limit (dBuV/m)	Margin (dB)	State P/F	Test Result
--	--	--	--	--	
--	--	--	--	--	PASS

Note:

The amplitude of spurious emissions which are attenuated by more than 20dB below the permissible value has no need to be reported.

Distance extrapolation factor = $40 \log (\text{specific distance}/\text{test distance})$ (dB);

Limit line = specific limits(dBuv) + distance extrapolation factor.

(30MHz - 1000MHz)

Temperature:	26 °C	Relative Humidity:	60%
Pressure:	1010 hPa	Test Voltage:	DC 3.8V From Battery
Test Mode:	Mode 1/2/3/4/5/6/7/8/9 (Mode 3-1M worst mode)	Polarization:	Horizontal

Frequency (MHz)	Reading (dBuV)	Correct Factor(dB/m)	Result (dBuV/m)	Limit (dBuV/m)	Margin (dB)	Remark
30.7454	31.69	-11.57	20.12	40.00	-19.88	QP
47.1600	42.11	-20.01	22.10	40.00	-17.90	QP
88.3421	50.06	-20.62	29.44	43.50	-14.06	QP
99.1795	43.87	-19.26	24.61	43.50	-18.89	QP
400.4318	28.34	-11.22	17.12	46.00	-28.88	QP
948.7610	26.93	-0.45	26.48	46.00	-19.52	QP

Remark:

1. Margin = Result (Result =Reading + Factor)–Limit

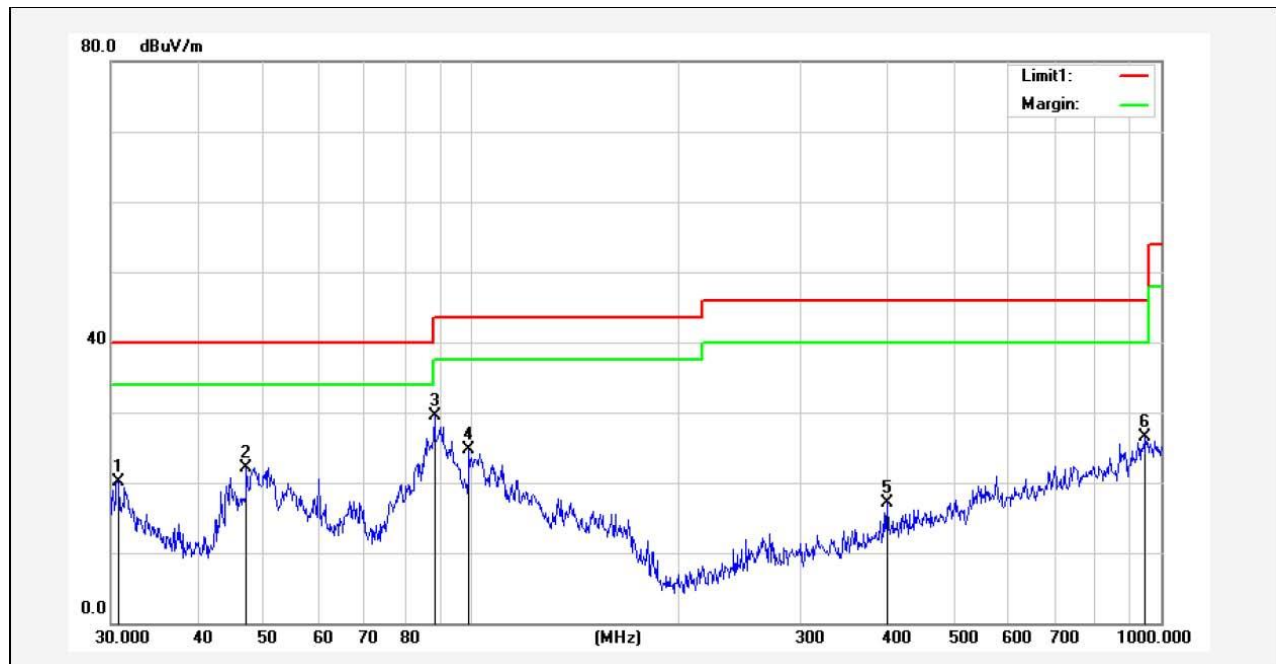

Temperature:	26 °C	Relative Humidity:	60%
Pressure:	1010 hPa	Test Voltage:	DC 3.8V From Battery
Test Mode:	Mode 1/2/3/4/5/6/7/8/9 (Mode 3-1M worst mode)	Polarization:	Vertical

Frequency (MHz)	Reading (dBuV)	Correct Factor(dB/m)	Result (dBuV/m)	Limit (dBuV/m)	Margin (dB)	Remark
34.5172	48.65	-13.51	35.14	40.00	-4.86	QP
38.6160	51.08	-15.61	35.47	40.00	-4.53	QP
95.7622	45.06	-19.61	25.45	43.50	-18.05	QP
170.7923	57.92	-19.35	38.57	43.50	-4.93	QP
341.9786	55.38	-13.93	41.45	46.00	-4.55	QP
513.6331	49.67	-8.86	40.81	46.00	-5.19	QP

Remark:.

1. Margin = Result (Result =Reading + Factor)–Limit

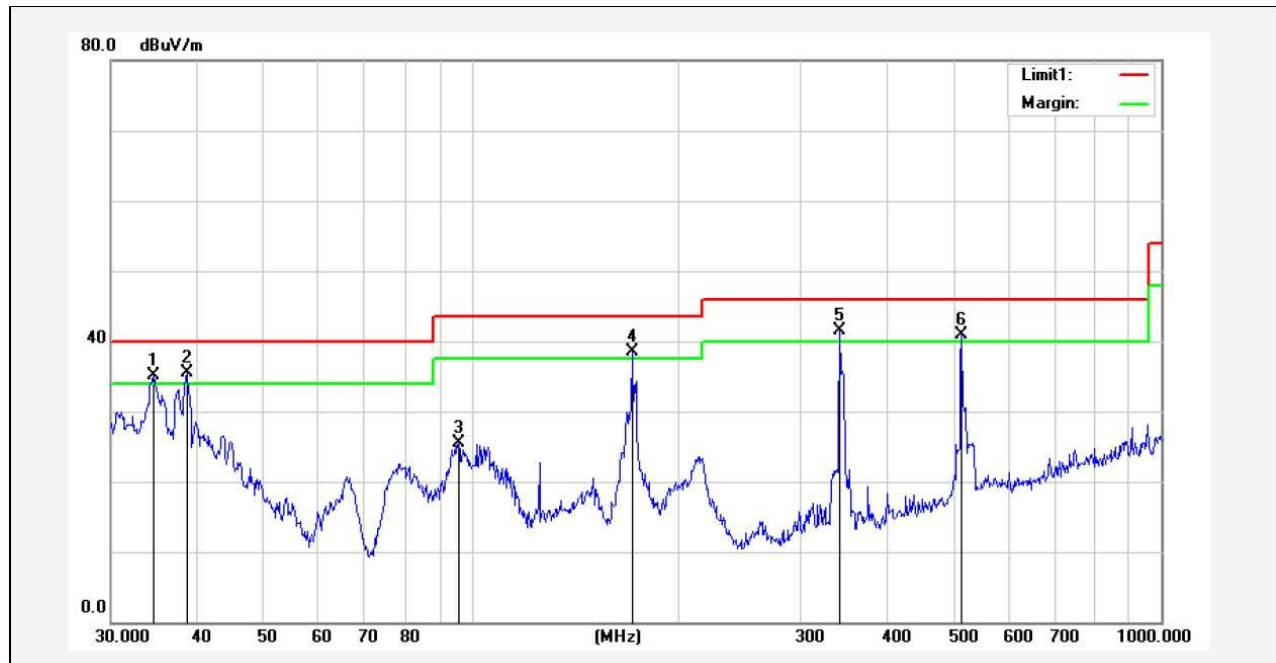

(1000MHz-25GHz) Restricted band and Spurious emission Requirements

802.11b Low Channel

Frequency (MHz)	Reading (dBμV)	Amplifier (dB)	Loss (dB)	Antenna	Corrected	Emission		Margin (dB)	Detector Type	Comment
				Factor (dB/m)	Factor (dB)	Level (dBμV/m)	Limits (dBμV/m)			
Low Channel (2412 MHz)										
3264.65	47.96	44.70	6.70	28.20	-9.80	38.16	74.00	-35.84	PK	Vertical
3264.65	38.60	44.70	6.70	28.20	-9.80	28.80	54.00	-25.20	AV	Vertical
3264.69	48.56	44.70	6.70	28.20	-9.80	38.76	74.00	-35.24	PK	Horizontal
3264.69	38.87	44.70	6.70	28.20	-9.80	29.07	54.00	-24.93	AV	Horizontal
4824.31	59.27	44.20	9.04	31.60	-3.56	55.71	74.00	-18.29	PK	Vertical
4824.31	38.76	44.20	9.04	31.60	-3.56	35.20	54.00	-18.80	AV	Vertical
4824.59	59.02	44.20	9.04	31.60	-3.56	55.46	74.00	-18.54	PK	Horizontal
4824.59	39.54	44.20	9.04	31.60	-3.56	35.98	54.00	-18.02	AV	Horizontal
5359.77	45.18	44.20	9.86	32.00	-2.34	42.84	74.00	-31.16	PK	Vertical
5359.77	37.56	44.20	9.86	32.00	-2.34	35.22	54.00	-18.78	AV	Vertical
5359.82	45.99	44.20	9.86	32.00	-2.34	43.65	74.00	-30.35	PK	Horizontal
5359.82	37.14	44.20	9.86	32.00	-2.34	34.80	54.00	-19.20	AV	Horizontal
7235.79	51.92	43.50	11.40	35.50	3.40	55.32	74.00	-18.68	PK	Vertical
7235.79	33.42	43.50	11.40	35.50	3.40	36.82	54.00	-17.18	AV	Vertical
7235.71	50.52	43.50	11.40	35.50	3.40	53.92	74.00	-20.08	PK	Horizontal
7235.71	32.60	43.50	11.40	35.50	3.40	36.00	54.00	-18.00	AV	Horizontal
11035.99	40.23	43.60	14.30	39.50	10.20	50.43	74.00	-23.57	PK	Vertical
11035.99	30.82	43.60	14.30	39.50	10.20	41.02	54.00	-12.98	AV	Vertical
11036.13	41.08	43.60	14.30	39.50	10.20	51.28	74.00	-22.72	PK	Horizontal
11036.13	30.04	43.60	14.30	39.50	10.20	40.24	54.00	-13.76	AV	Horizontal
13299.15	40.14	42.60	15.90	38.90	12.20	52.34	74.00	-21.66	PK	Vertical
13299.15	28.54	42.60	15.90	38.90	12.20	40.74	54.00	-13.26	AV	Vertical
13299.28	39.93	42.60	15.90	38.90	12.20	52.13	74.00	-21.87	PK	Horizontal
13299.28	29.13	42.60	15.90	38.90	12.20	41.33	54.00	-12.67	AV	Horizontal
15999.77	39.96	42.70	18.00	37.10	12.40	52.36	74.00	-21.64	PK	Vertical
15999.77	28.64	42.70	18.00	37.10	12.40	41.04	54.00	-12.96	AV	Vertical
15999.59	40.18	42.70	18.00	37.10	12.40	52.58	74.00	-21.42	PK	Horizontal
15999.59	29.80	42.70	18.00	37.10	12.40	42.20	54.00	-11.80	AV	Horizontal
17997.83	30.11	42.70	19.40	46.50	23.20	53.31	74.00	-20.69	PK	Vertical
17997.83	19.75	42.70	19.40	46.50	23.20	42.95	54.00	-11.05	AV	Vertical
17997.59	30.28	42.70	19.40	46.50	23.20	53.48	74.00	-20.52	PK	Horizontal
17997.59	18.79	42.70	19.40	46.50	23.20	41.99	54.00	-12.01	AV	Horizontal

802.11b Mid Channel

Frequency (MHz)	Reading (dBµV)	Amplifier (dB)	Loss (dB)	Antenna	Corrected	Emission	Limits (dBµV/m)	Margin (dB)	Detector Type	Comment
				Factor (dB/m)	Factor (dB)	Level (dBµV/m)				
Mid Channel (2437 MHz)										
3264.68	49.02	44.70	6.70	28.20	-9.80	39.22	74.00	-34.78	PK	Vertical
3264.68	38.57	44.70	6.70	28.20	-9.80	28.77	54.00	-25.23	AV	Vertical
3264.77	49.04	44.70	6.70	28.20	-9.80	39.24	74.00	-34.76	PK	Horizontal
3264.77	38.17	44.70	6.70	28.20	-9.80	28.37	54.00	-25.63	AV	Horizontal
4874.52	58.25	44.20	9.04	31.60	-3.56	54.69	74.00	-19.31	PK	Vertical
4874.52	38.88	44.20	9.04	31.60	-3.56	35.32	54.00	-18.68	AV	Vertical
4874.58	58.37	44.20	9.04	31.60	-3.56	54.81	74.00	-19.19	PK	Horizontal
4874.58	38.57	44.20	9.04	31.60	-3.56	35.01	54.00	-18.99	AV	Horizontal
5359.73	45.05	44.20	9.86	32.00	-2.34	42.71	74.00	-31.29	PK	Vertical
5359.73	37.69	44.20	9.86	32.00	-2.34	35.35	54.00	-18.65	AV	Vertical
5359.85	45.16	44.20	9.86	32.00	-2.34	42.82	74.00	-31.18	PK	Horizontal
5359.85	37.15	44.20	9.86	32.00	-2.34	34.81	54.00	-19.19	AV	Horizontal
7310.87	51.78	43.50	11.40	35.50	3.40	55.18	74.00	-18.82	PK	Vertical
7310.87	33.72	43.50	11.40	35.50	3.40	37.12	54.00	-16.88	AV	Vertical
7310.95	50.72	43.50	11.40	35.50	3.40	54.12	74.00	-19.88	PK	Horizontal
7310.95	33.12	43.50	11.40	35.50	3.40	36.52	54.00	-17.48	AV	Horizontal
9747.84	40.64	43.60	14.30	39.50	10.20	50.84	74.00	-23.16	PK	Vertical
9747.84	29.91	43.60	14.30	39.50	10.20	40.11	54.00	-13.89	AV	Vertical
9748.11	40.41	43.60	14.30	39.50	10.20	50.61	74.00	-23.39	PK	Horizontal
9748.11	30.48	43.60	14.30	39.50	10.20	40.68	54.00	-13.32	AV	Horizontal
13299.41	39.67	42.60	15.90	38.90	12.20	51.87	74.00	-22.13	PK	Vertical
13299.41	28.54	42.60	15.90	38.90	12.20	40.74	54.00	-13.26	AV	Vertical
13299.27	40.55	42.60	15.90	38.90	12.20	52.75	74.00	-21.25	PK	Horizontal
13299.27	29.79	42.60	15.90	38.90	12.20	41.99	54.00	-12.01	AV	Horizontal
15999.94	40.79	42.70	18.00	37.10	12.40	53.19	74.00	-20.81	PK	Vertical
15999.94	28.64	42.70	18.00	37.10	12.40	41.04	54.00	-12.96	AV	Vertical
15999.83	39.62	42.70	18.00	37.10	12.40	52.02	74.00	-21.98	PK	Horizontal
15999.83	29.02	42.70	18.00	37.10	12.40	41.42	54.00	-12.58	AV	Horizontal
17997.81	30.96	42.70	19.40	46.50	23.20	54.16	74.00	-19.84	PK	Vertical
17997.81	19.57	42.70	19.40	46.50	23.20	42.77	54.00	-11.23	AV	Vertical
17997.63	29.82	42.70	19.40	46.50	23.20	53.02	74.00	-20.98	PK	Horizontal
17997.63	17.78	42.70	19.40	46.50	23.20	40.98	54.00	-13.02	AV	Horizontal

802.11b High Channel

Frequency (MHz)	Reading (dBμV)	Amplifier (dB)	Loss (dB)	Antenna	Corrected	Emission		Margin (dB)	Detector Type	Comment
				Factor (dB/m)	Factor (dB)	Level (dBμV/m)	Limits (dBμV/m)			
High Channel (2462 MHz)										
3264.60	47.99	44.70	6.70	28.20	-9.80	38.19	74.00	-35.81	PK	Vertical
3264.60	38.40	44.70	6.70	28.20	-9.80	28.60	54.00	-25.40	AV	Vertical
3264.66	48.96	44.70	6.70	28.20	-9.80	39.16	74.00	-34.84	PK	Horizontal
3264.66	38.15	44.70	6.70	28.20	-9.80	28.35	54.00	-25.65	AV	Horizontal
4924.31	59.26	44.20	9.04	31.60	-3.56	55.70	74.00	-18.30	PK	Vertical
4924.31	39.19	44.20	9.04	31.60	-3.56	35.63	54.00	-18.37	AV	Vertical
4924.54	59.07	44.20	9.04	31.60	-3.56	55.51	74.00	-18.49	PK	Horizontal
4924.54	38.81	44.20	9.04	31.60	-3.56	35.25	54.00	-18.75	AV	Horizontal
5359.63	45.19	44.20	9.86	32.00	-2.34	42.85	74.00	-31.15	PK	Vertical
5359.63	37.25	44.20	9.86	32.00	-2.34	34.91	54.00	-19.09	AV	Vertical
5359.79	45.70	44.20	9.86	32.00	-2.34	43.36	74.00	-30.64	PK	Horizontal
5359.79	37.70	44.20	9.86	32.00	-2.34	35.36	54.00	-18.64	AV	Horizontal
7385.86	50.98	43.50	11.40	35.50	3.40	54.38	74.00	-19.62	PK	Vertical
7385.86	33.59	43.50	11.40	35.50	3.40	36.99	54.00	-17.01	AV	Vertical
7385.80	51.36	43.50	11.40	35.50	3.40	54.76	74.00	-19.24	PK	Horizontal
7385.80	33.74	43.50	11.40	35.50	3.40	37.14	54.00	-16.86	AV	Horizontal
9847.88	40.03	43.60	14.30	39.50	10.20	50.23	74.00	-23.77	PK	Vertical
9847.88	30.48	43.60	14.30	39.50	10.20	40.68	54.00	-13.32	AV	Vertical
9848.21	40.88	43.60	14.30	39.50	10.20	51.08	74.00	-22.92	PK	Horizontal
9848.21	30.83	43.60	14.30	39.50	10.20	41.03	54.00	-12.97	AV	Horizontal
13299.20	40.45	42.70	18.00	37.10	12.40	52.85	74.00	-21.15	PK	Vertical
13299.20	28.54	42.70	18.00	37.10	12.40	40.94	54.00	-13.06	AV	Vertical
13299.54	40.74	42.70	18.00	37.10	12.40	53.14	74.00	-20.86	PK	Horizontal
13299.54	28.89	42.70	18.00	37.10	12.40	41.29	54.00	-12.71	AV	Horizontal
17997.67	30.12	42.70	19.40	46.50	23.20	53.32	74.00	-20.68	PK	Vertical
17997.67	18.80	42.70	19.40	46.50	23.20	42.00	54.00	-12.00	AV	Vertical
17997.72	31.26	42.70	19.40	46.50	23.20	54.46	74.00	-19.54	PK	Horizontal
17997.72	19.21	42.70	19.40	46.50	23.20	42.41	54.00	-11.59	AV	Horizontal

Remark:

1. Factor = Antenna Factor + Cable Loss – Pre-amplifier.

2. Scan with 802.11b, 802.11g, 802.11n (HT-20) the worst case is 802.11b.

Emission Level = Reading + Factor

Margin = Limit - Emission Level

3. The frequency emission of peak points that did not show above the forms are at least 20dB below the limit, the frequency emission is mainly from the environment noise.

3.2.6 TEST RESULTS (Band edge Requirements)

Frequency (MHz)	Reading (dB μ V)	Amplifier (dB)	Loss (dB)	Antenna Factor (dB/m)	Corrected Factor (dB)	Emission Level (dB μ V/m)	Limits (dB μ V/m)	Margin (dB)	Detector Type	Comment
802.11b										
2390.00	68.14	43.80	4.91	25.90	-12.99	55.15	74.00	-18.85	PK	Vertical
2390.00	53.72	43.80	4.91	25.90	-12.99	40.73	54.00	-13.27	AV	Vertical
2390.00	69.55	43.80	4.91	25.90	-12.99	56.56	74.00	-17.44	PK	Horizontal
2390.00	52.45	43.80	4.91	25.90	-12.99	39.46	54.00	-14.54	AV	Horizontal
2483.50	70.15	43.80	5.12	25.90	-12.78	57.37	74.00	-16.63	PK	Vertical
2483.50	53.51	43.80	5.12	25.90	-12.78	40.73	54.00	-13.27	AV	Vertical
2483.50	69.87	43.80	5.12	25.90	-12.78	57.09	74.00	-16.91	PK	Horizontal
2483.50	53.17	43.80	5.12	25.90	-12.78	40.39	54.00	-13.61	AV	Horizontal
802.11g										
2390.00	66.06	43.80	4.91	25.90	-12.99	53.07	74.00	-20.93	PK	Vertical
2390.00	52.49	43.80	4.91	25.90	-12.99	39.50	54.00	-14.50	AV	Vertical
2390.00	65.73	43.80	4.91	25.90	-12.99	52.74	74.00	-21.26	PK	Horizontal
2390.00	53.86	43.80	4.91	25.90	-12.99	40.87	54.00	-13.13	AV	Horizontal
2483.50	65.34	43.80	5.12	25.90	-12.78	52.56	74.00	-21.44	PK	Vertical
2483.50	53.13	43.80	5.12	25.90	-12.78	40.35	54.00	-13.65	AV	Vertical
2483.50	65.50	43.80	5.12	25.90	-12.78	52.72	74.00	-21.28	PK	Horizontal
2483.50	52.69	43.80	5.12	25.90	-12.78	39.91	54.00	-14.09	AV	Horizontal
802.11n20										
2390.00	67.08	43.80	4.91	25.90	-12.99	54.09	74.00	-19.91	PK	Vertical
2390.00	53.28	43.80	4.91	25.90	-12.99	40.29	54.00	-13.71	AV	Vertical
2390.00	65.84	43.80	4.91	25.90	-12.99	52.85	74.00	-21.15	PK	Horizontal
2390.00	53.87	43.80	4.91	25.90	-12.99	40.88	54.00	-13.12	AV	Horizontal
2483.50	66.49	43.80	5.12	25.90	-12.78	53.71	74.00	-20.29	PK	Vertical
2483.50	53.03	43.80	5.12	25.90	-12.78	40.25	54.00	-13.75	AV	Vertical
2483.50	65.23	43.80	5.12	25.90	-12.78	52.45	74.00	-21.55	PK	Horizontal
2483.50	52.60	43.80	5.12	25.90	-12.78	39.82	54.00	-14.18	AV	Horizontal

Remark: Factor = Antenna Factor + Cable Loss – Pre-amplifier.

Low measurement frequencies is range from 2300 to 2412 MHz, high measurement frequencies is range from 2462 to 2500 MHz.

Only show the worst point data of the emissions in the frequency 2300-2412 MHz and 2462-2500 MHz.

4. CONDUCTED SPURIOUS & BAND EDGE EMISSION

4.1 APPLIED PROCEDURES / LIMIT

According to FCC section 15.247(d), in any 100kHz bandwidth outside the frequency band in which the spread spectrum or digitally modulated intentional radiator is operating, the radio frequency power that is produced by the intentional radiator shall be at least 20dB below that in the 100kHz bandwidth within the band that contains the highest level of the desired power, based on either an RF conducted or a radiated measurement.

4.2 TEST PROCEDURE

Spectrum Parameter	Setting
Detector	Peak
Start/Stop Frequency	30 MHz to 10th carrier harmonic
RB / VB (emission in restricted band)	100 KHz/300 KHz
Trace-Mode:	Max hold

For Band edge

Spectrum Parameter	Setting
Detector	Peak
Start/Stop Frequency	Lower Band Edge: 2300 to 2412 MHz Upper Band Edge: 2462 to 2500 MHz
RB / VB (emission in restricted band)	100 KHz/300 KHz
Trace-Mode:	Max hold

4.3 DEVIATION FROM STANDARD

No deviation.

4.4 TEST SETUP

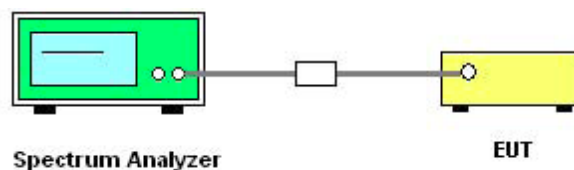

The EUT which is powered by the Battery, is coupled to the Spectrum Analyzer; the RF load attached to the EUT antenna terminal is 50Ohm; the path loss as the factor is calibrated to correct the reading.

Make the measurement with the spectrum analyzer's resolution bandwidth (RBW) = 100 kHz. In order to make an accurate measurement, set the span greater than RBW.

4.5 EUT OPERATION CONDITIONS

The EUT tested system was configured as the statements of 2.3 Unless otherwise a special operating condition is specified in the follows during the testing.

4.6 TEST RESULTS

Temperature:	25 °C	Relative Humidity:	60%
Pressure:	1015 hPa	Test Voltage:	DC 3.8V
Test Mode:	TX b Mode /CH01, CH06, CH11		

CH 01

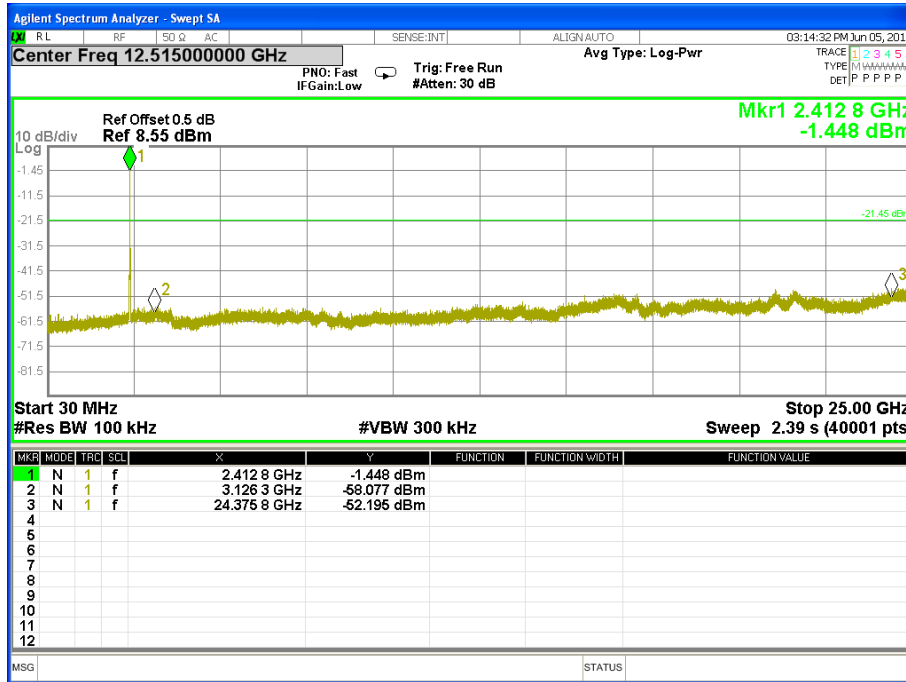

CH 06

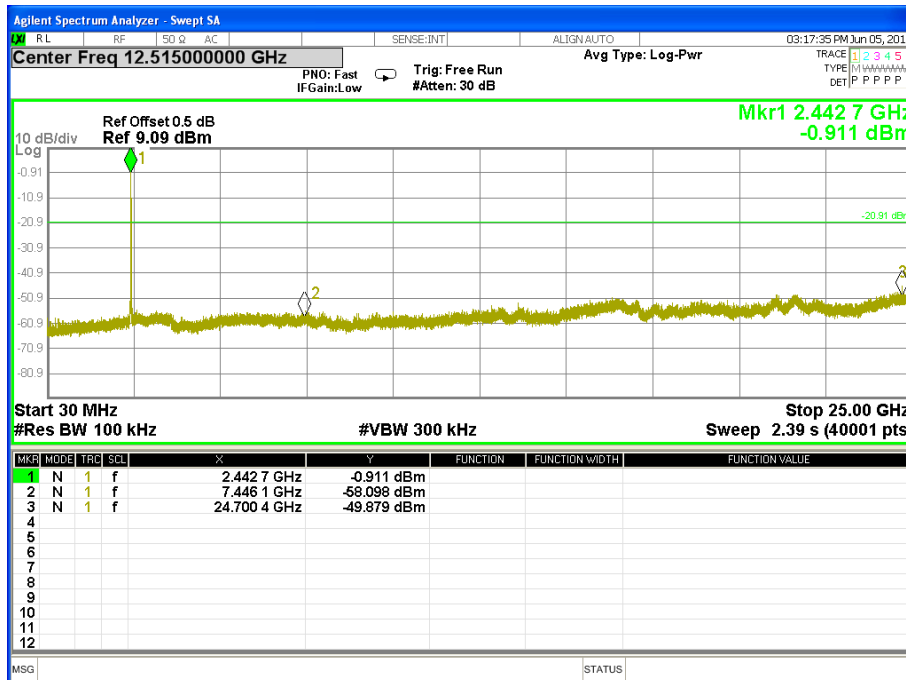

5. POWER SPECTRAL DENSITY TEST

5.1 APPLIED PROCEDURES / LIMIT

FCC Part15.247 , Subpart C				
Section	Test Item	Limit	Frequency Range (MHz)	Result
15.247(e)	Power Spectral Density	≤ 8 dBm (RBW ≥ 3 KHz)	2400-2483.5	PASS

5.2 TEST PROCEDURE

1. Set analyzer center frequency to DTS channel center frequency.
2. Set the span to 1.5 times the DTS channel bandwidth.
3. Set the $100 \text{ kHz} \geq \text{RBW} \geq 3 \text{ kHz}$.
4. Set the $\text{VBW} \geq 3 \times \text{RBW}$.
5. Detector = peak.
6. Sweep time = auto couple.
7. Trace mode = max hold.
8. Allow trace to fully stabilize.
9. Use the peak marker function to determine the maximum amplitude level.
10. If measured value exceeds limit, reduce RBW (no less than 3 kHz) and repeat.

5.3 DEVIATION FROM STANDARD

No deviation.

5.4 TEST SETUP



5.5 EUT OPERATION CONDITIONS

The EUT tested system was configured as the statements of 2.3 Unless otherwise a special operating condition is specified in the follows during the testing.

5.6 TEST RESULTS

Temperature:	25 °C	Relative Humidity:	60%
Pressure:	1015 hPa	Test Voltage:	DC 3.8V
Test Mode:	TX b Mode /CH01, CH06, CH11		

Frequency	Power Density (dBm/3kHz)	Limit (dBm)	Result
2412 MHz	-14.228	≤8	PASS
2437 MHz	-12.100	≤8	PASS
2462 MHz	-12.833	≤8	PASS

TX CH01

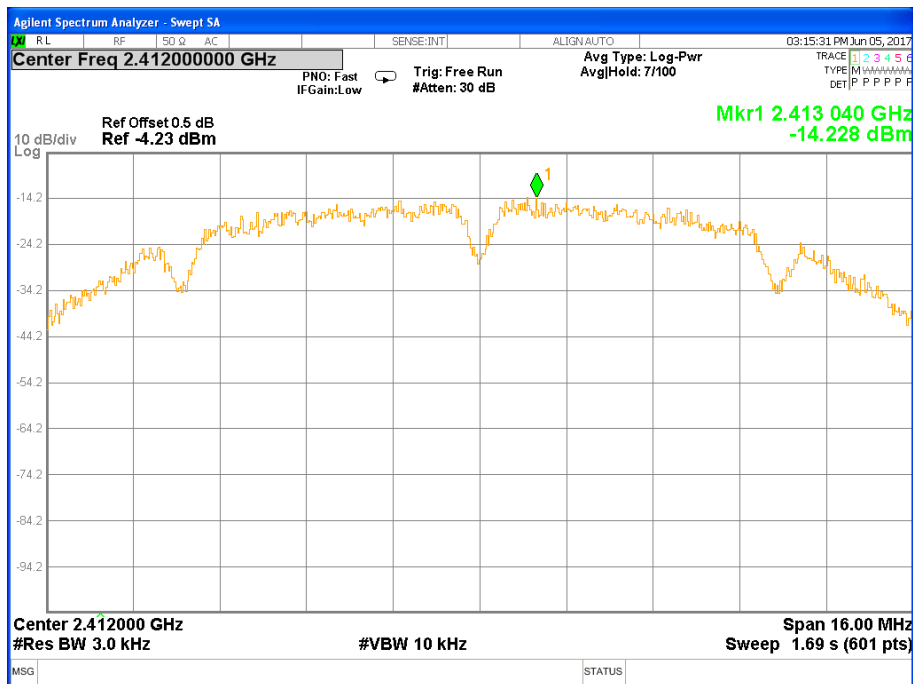

TX CH06

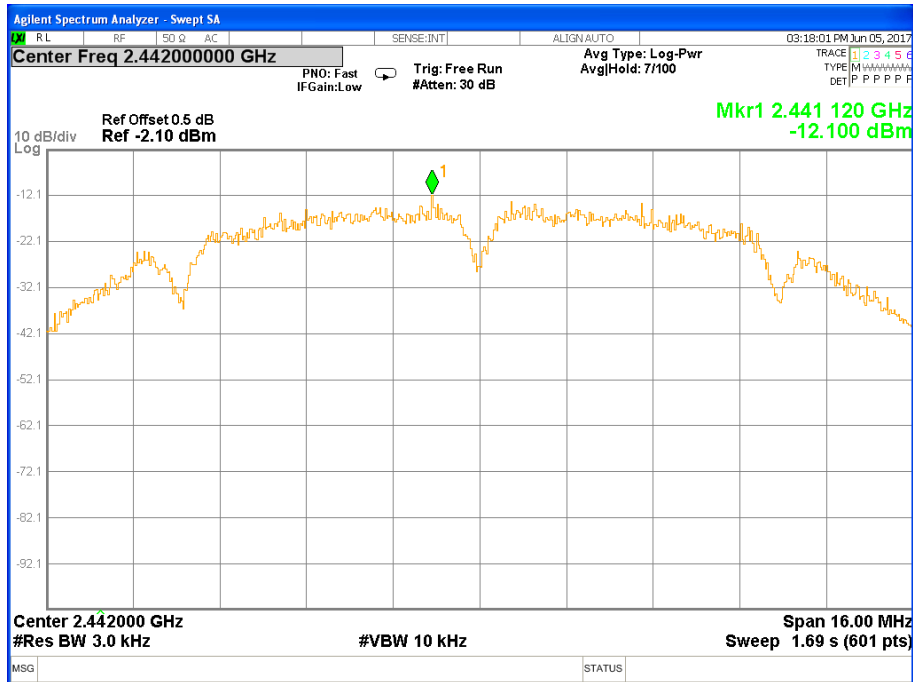

TX CH11

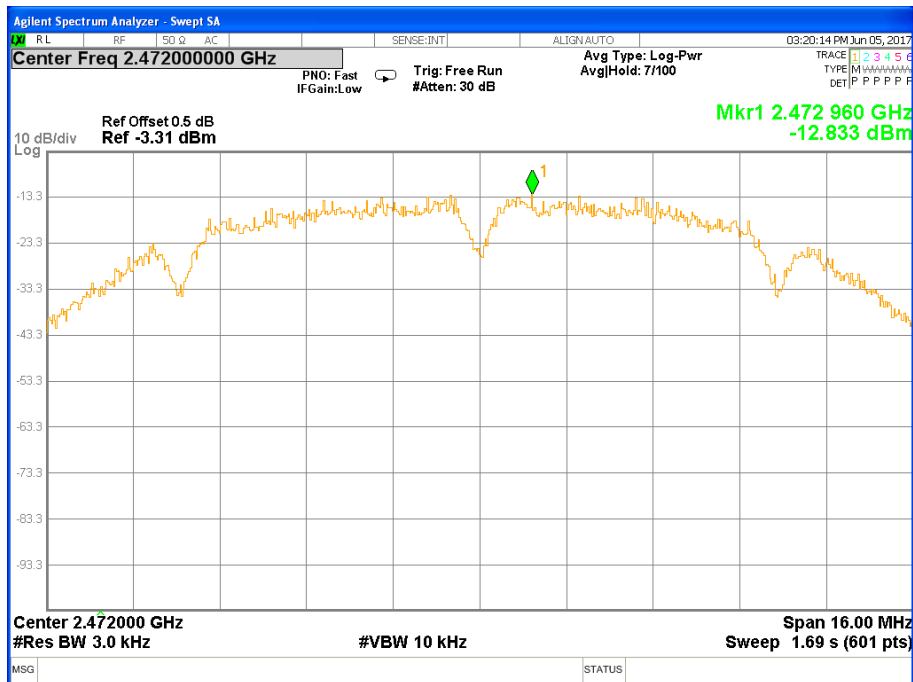

Temperature:	25 °C	Relative Humidity:	60%
Pressure:	1015 hPa	Test Voltage:	DC 3.8V
Test Mode:	TX g Mode /CH01, CH06, CH11		

Frequency	Power Density (dBm/3kHz)	Limit (dBm)	Result
2412 MHz	-20.084	≤8	PASS
2437 MHz	-17.231	≤8	PASS
2462 MHz	-15.506	≤8	PASS

TX CH01

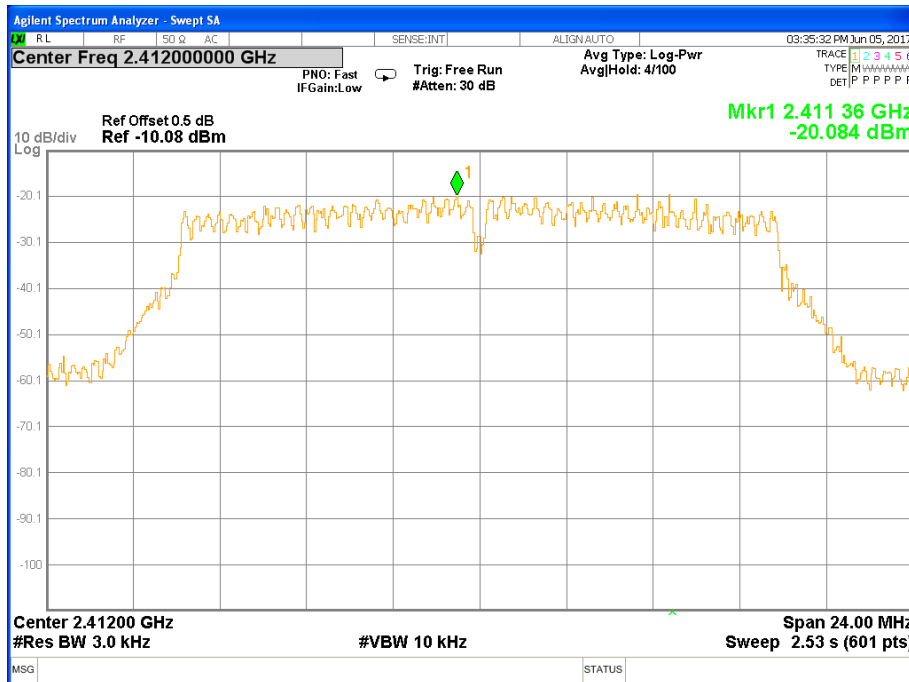

TX CH06

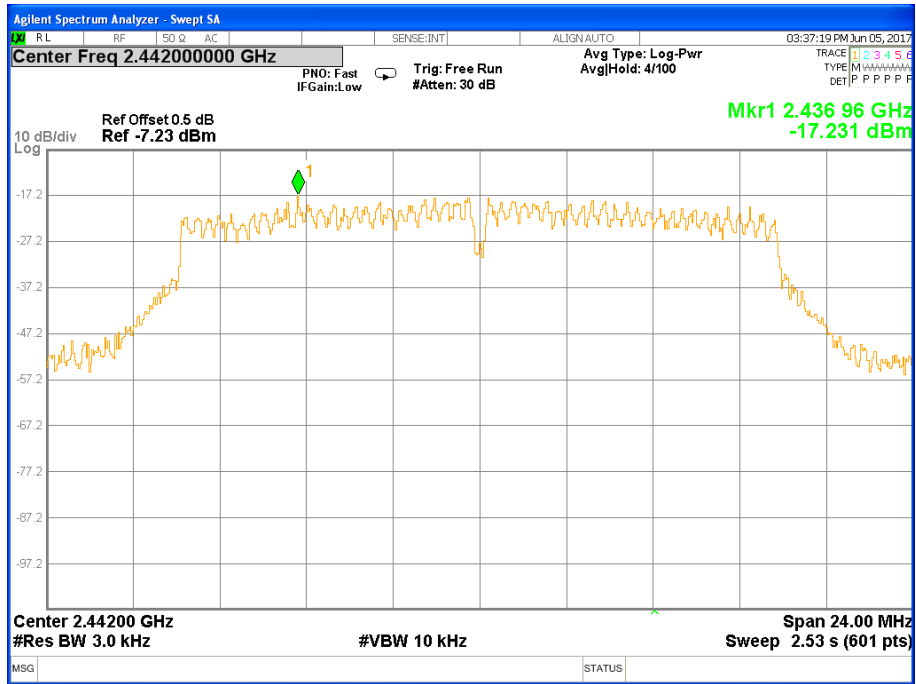

TX CH11

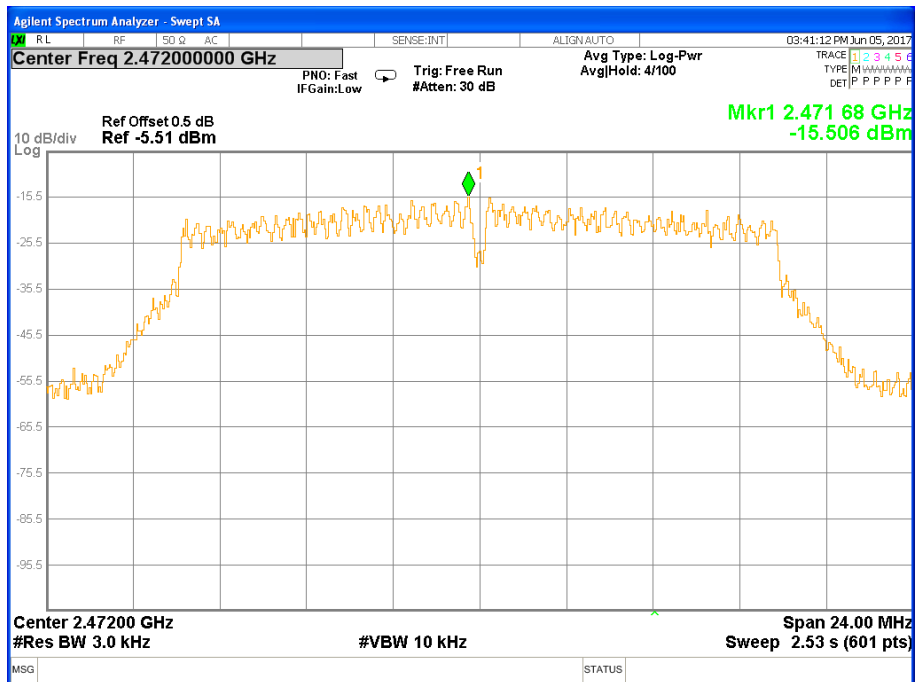

Temperature:	25 °C	Relative Humidity:	60%
Pressure:	1015 hPa	Test Voltage:	DC 3.8V
Test Mode:	TX n Mode(20M) /CH01, CH06, CH11		

Frequency	Power Density (dBm/3kHz)	Limit (dBm)	Result
2412 MHz	-20.137	≤8	PASS
2437 MHz	-19.615	≤8	PASS
2462 MHz	-18.641	≤8	PASS

TX CH01

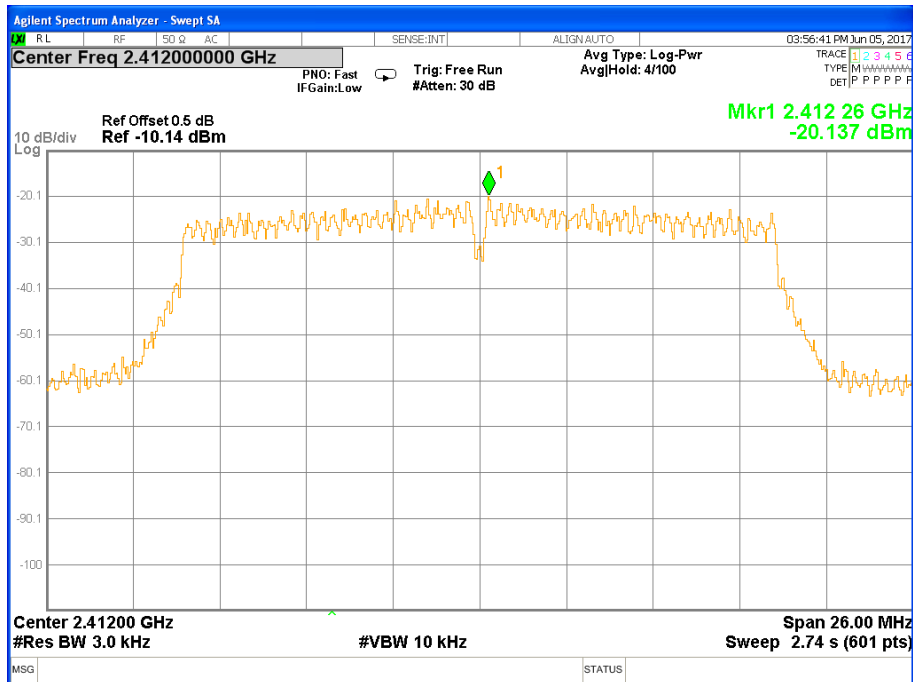

TX CH06

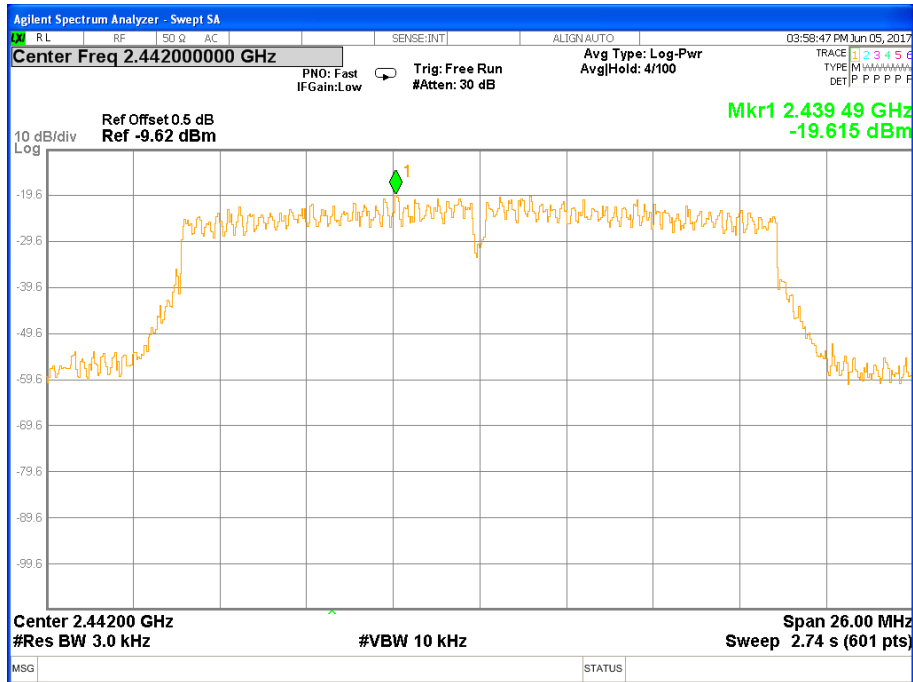

TX CH11

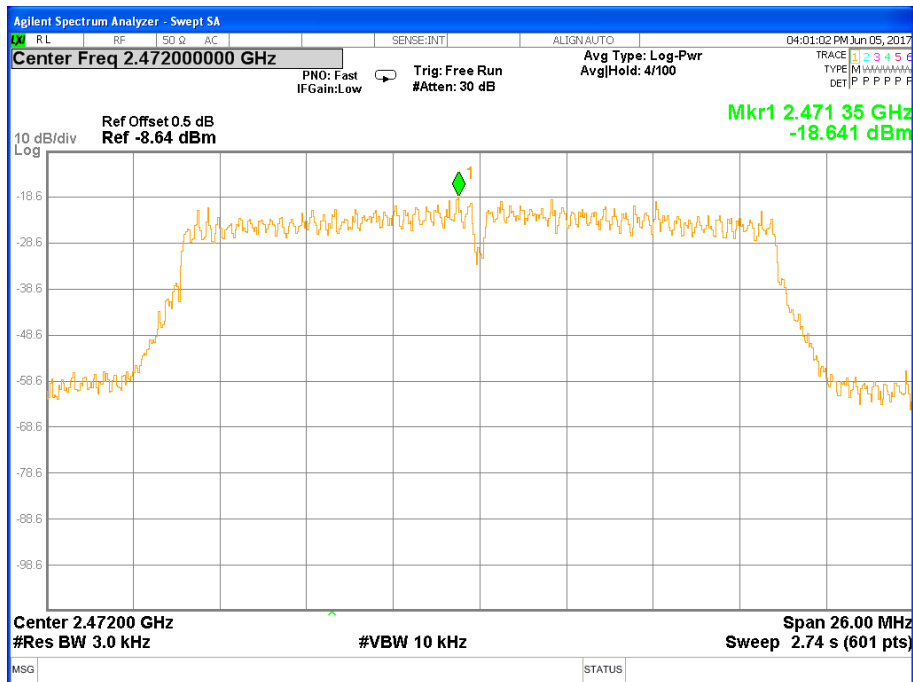

6. BANDWIDTH TEST

6.1 APPLIED PROCEDURES / LIMIT

FCC Part 15.247, Subpart C				
Section	Test Item	Limit	Frequency Range (MHz)	Result
15.247(a)(2)	Bandwidth	$\geq 500\text{KHz}$ (6dB bandwidth)	2400-2483.5	PASS

6.2 TEST PROCEDURE

The automatic bandwidth measurement capability of an instrument may be employed using the X dB bandwidth mode with X set to 6 dB, if the functionality described above (i.e., RBW = 100 kHz, VBW \geq 3RBW, peak detector with maximum hold) is implemented by the instrumentation function. When using this capability, care shall be taken so that the bandwidth measurement is not influenced by any intermediate power nulls in the fundamental emission that might be ≥ 6 dB.

6.3 DEVIATION FROM STANDARD

No deviation.

6.4 TEST SETUP

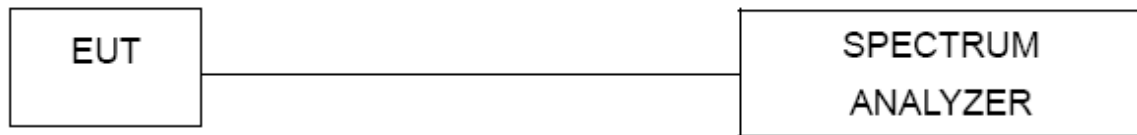

6.5 EUT OPERATION CONDITIONS

The EUT tested system was configured as the statements of 2.3 Unless otherwise a special operating condition is specified in the follows during the testing.

6.6 TEST RESULTS

Temperature:	25 °C	Relative Humidity:	60%
Pressure:	1012 hPa	Test Voltage:	DC 3.8V
Test Mode:	TX b Mode /CH01, CH06, CH11		

Remark: PEAK DETECTOR IS USED

Frequency	6dB Bandwidth (MHz)	Channel Separation (KHz)	Result
2412 MHz	10.01	≥500KHz	PASS
2437 MHz	10.04	≥500KHz	PASS
2462 MHz	10.02	≥500KHz	PASS

TX CH 01

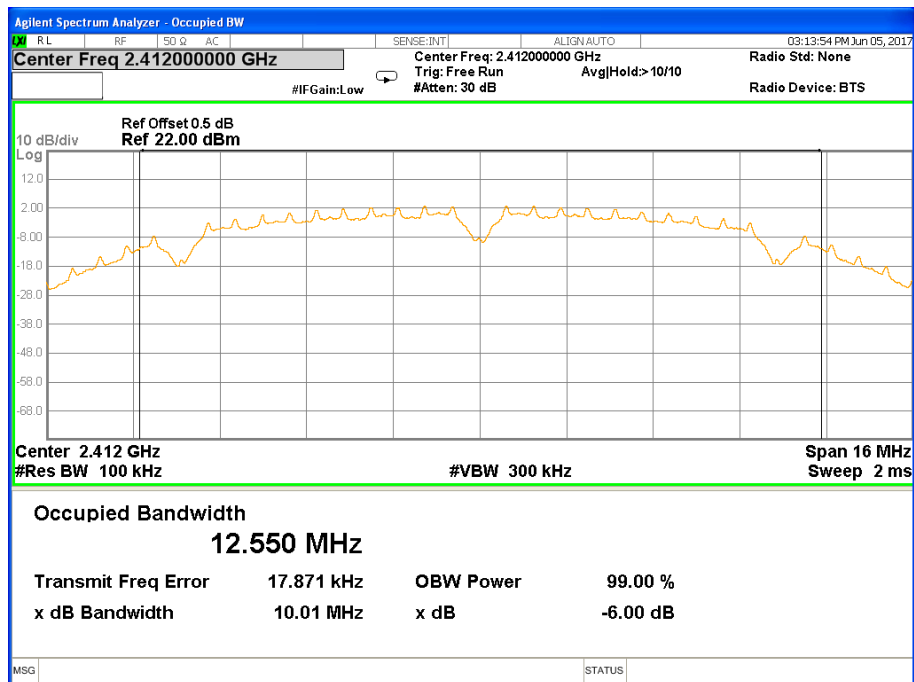

TX CH 06

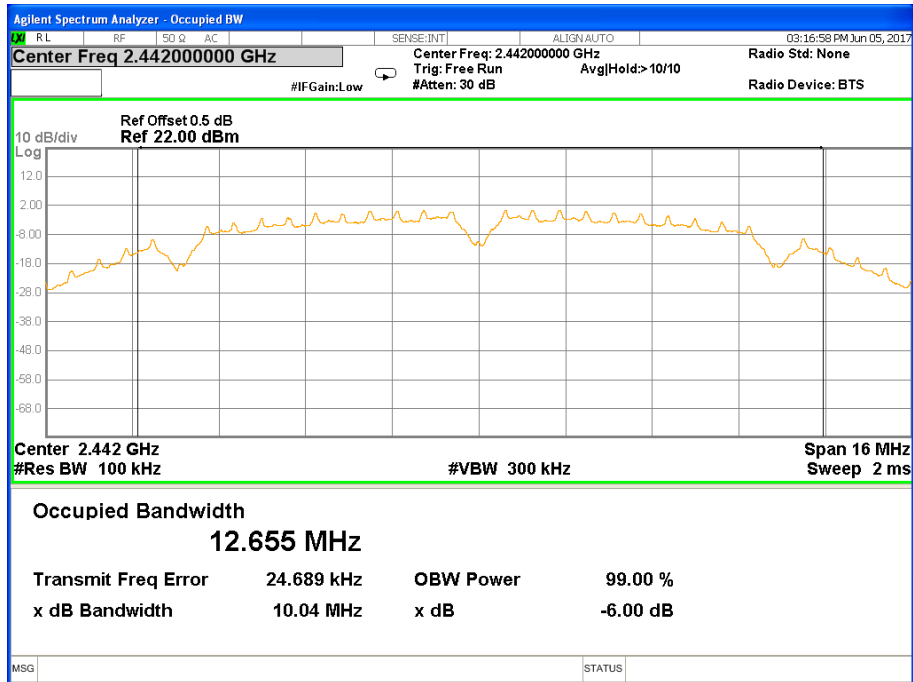

TX CH 11

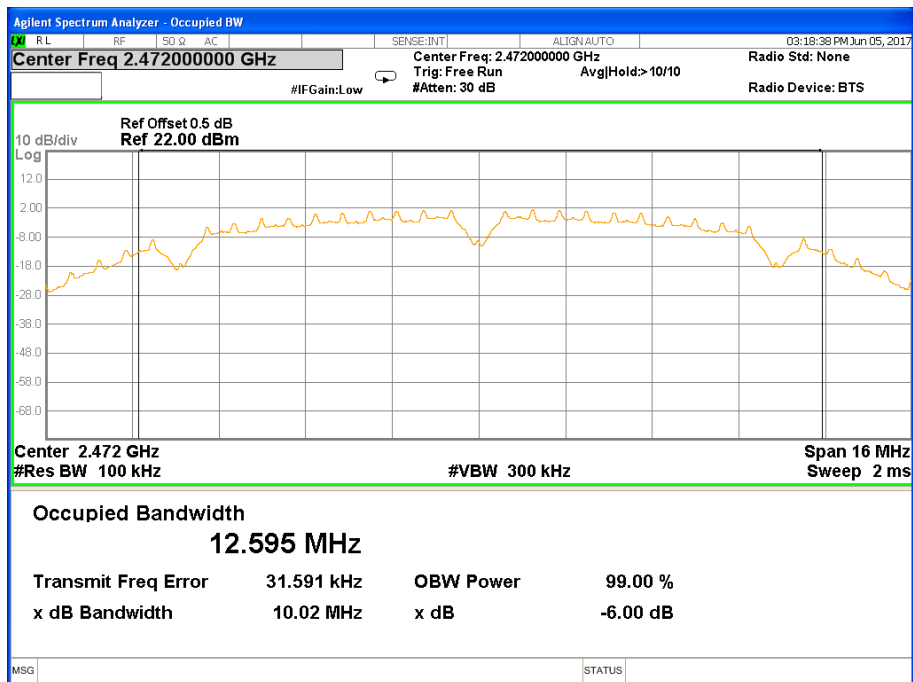

Temperature:	25 °C	Relative Humidity:	60%
Pressure:	1012 hPa	Test Voltage:	DC 3.8V
Test Mode:	TX g Mode /CH01, CH06, CH11		

Frequency	6dB Bandwidth (MHz)	Channel Separation (KHz)	Result
2412 MHz	15.13	≥500KHz	PASS
2437 MHz	15.12	≥500KHz	PASS
2462 MHz	15.13	≥500KHz	PASS

TX CH 01

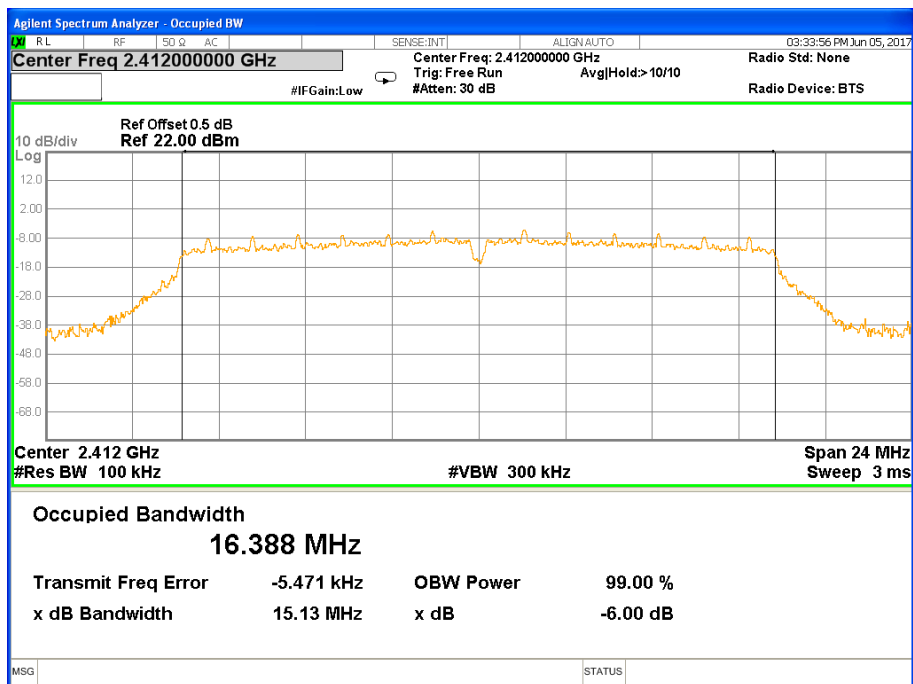

TX CH 06

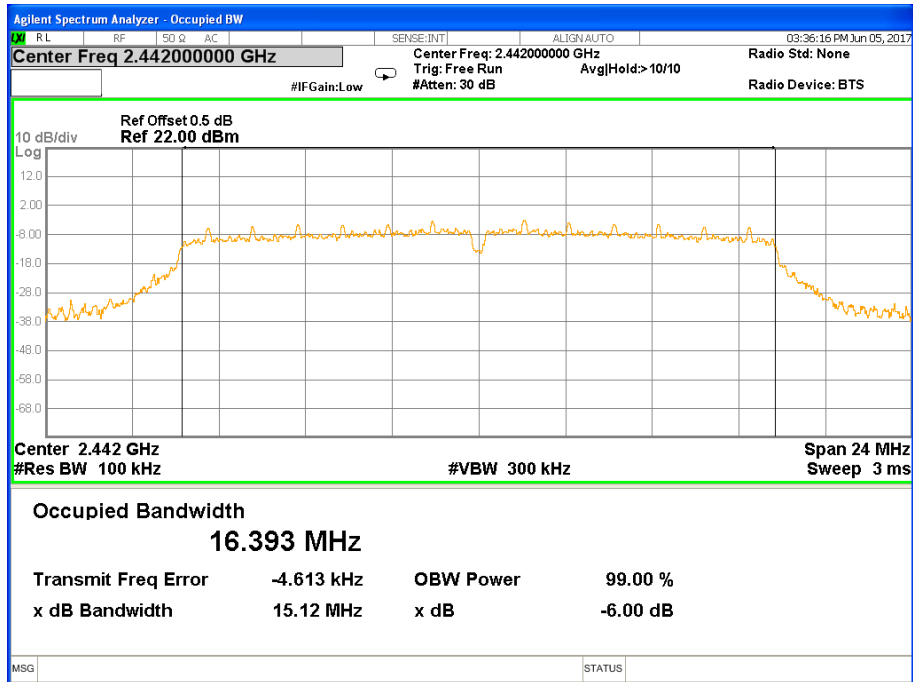

TX CH 11

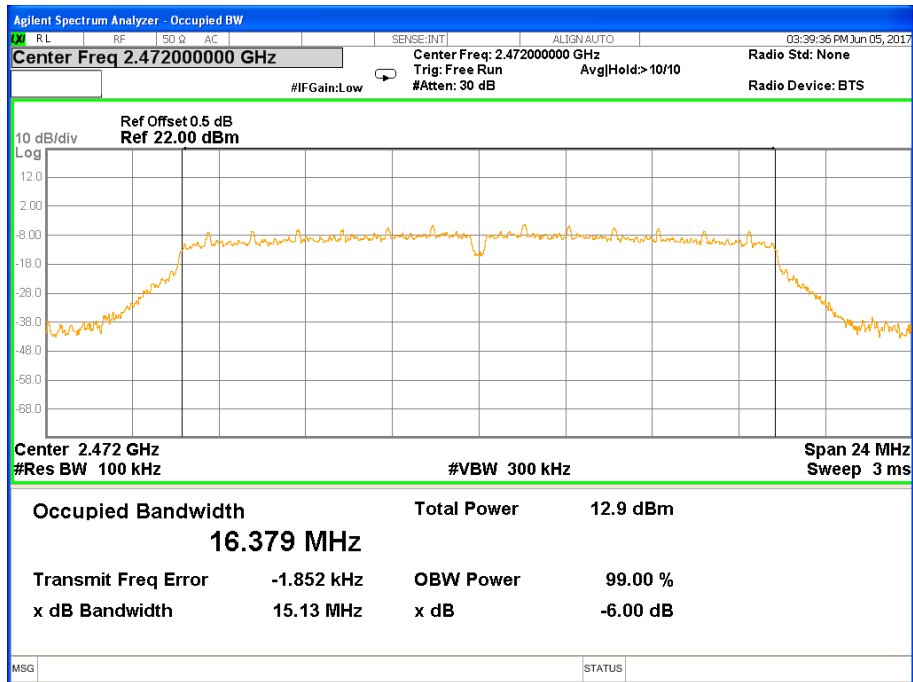

Temperature:	25 °C	Relative Humidity:	60%
Pressure:	1012 hPa	Test Voltage:	DC 3.8V
Test Mode:	TX n Mode(20M) /CH01, CH06, CH11		

Frequency	6dB Bandwidth (MHz)	Channel Separation (KHz)	Result
2412 MHz	15.14	≥500KHz	PASS
2437 MHz	15.13	≥500KHz	PASS
2462 MHz	15.95	≥500KHz	PASS

TX CH 01

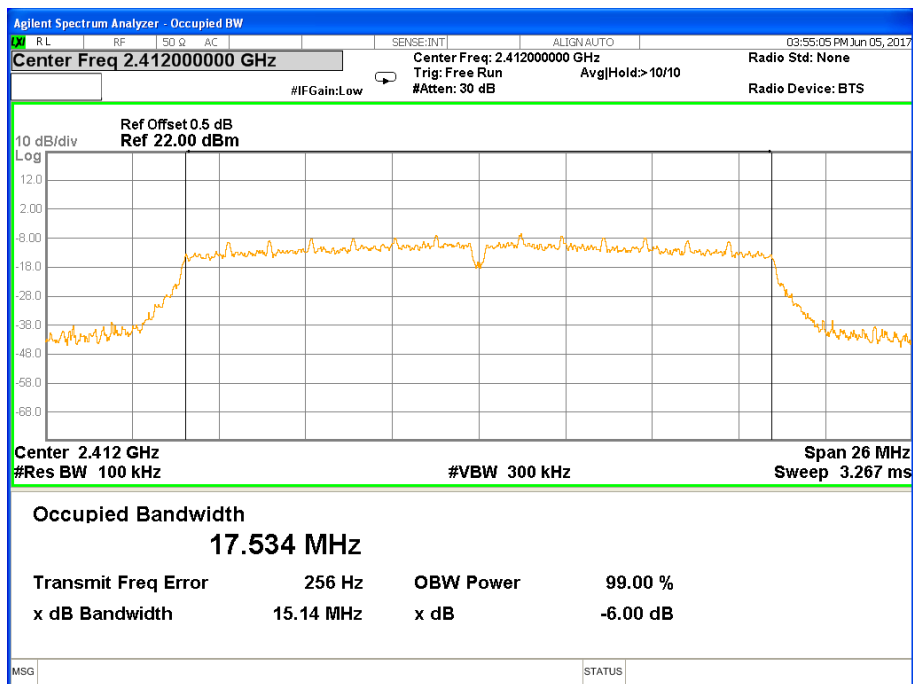

TX CH 06

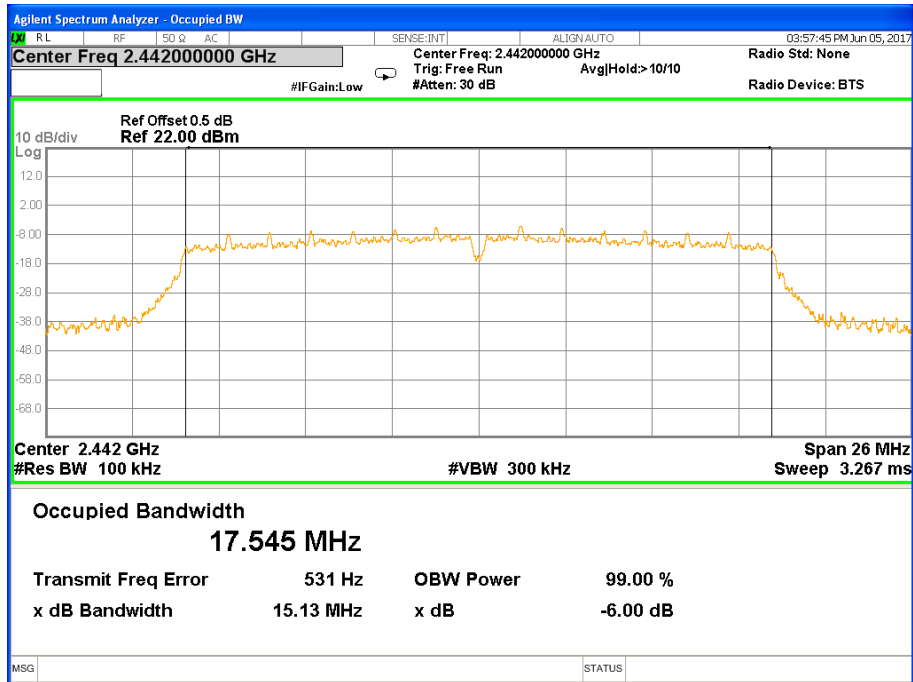

TX CH 11

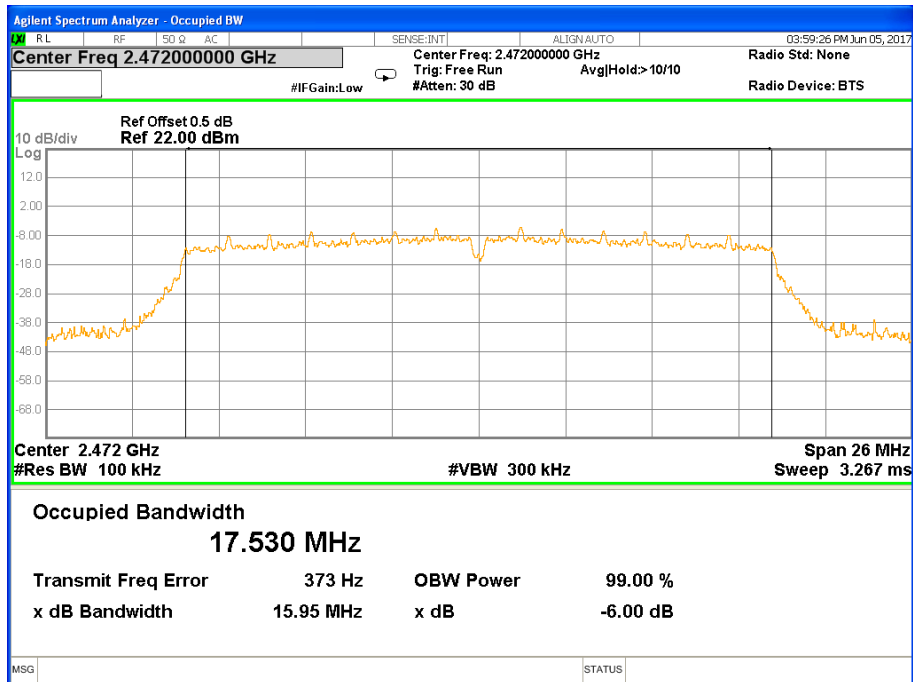

7. PEAK OUTPUT POWER TEST

7.1 APPLIED PROCEDURES / LIMIT

FCC Part 15.247, Subpart C				
Section	Test Item	Limit	Frequency Range (MHz)	Result
15.247(b)(3)	Output Power	1 watt or 30dBm	2400-2483.5	PASS

7.2 TEST PROCEDURE

- a. The EUT was directly connected to the Power Sensor&PC

7.3 DEVIATION FROM STANDARD

No deviation.

7.4 TEST SETUP

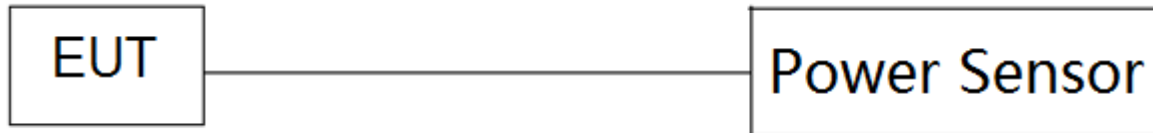

7.5 EUT OPERATION CONDITIONS

The EUT tested system was configured as the statements of 2.3 Unless otherwise a special operating condition is specified in the follows during the testing.

7.6 TEST RESULTS

Temperature:	25 °C	Relative Humidity:	60%
Pressure:	1012 hPa	Test Voltage:	DC 3.8V

TX 802.11b Mode				
Test Channel	Frequency	Conducted Output Power		LIMIT
	(MHz)	Peak(dBm)	AVG(dBm)	dBm
CH01	2412	12.41	11.29	30
CH06	2437	12.53	11.51	30
CH11	2462	12.62	11.59	30

TX 802.11g Mode				
Test Channel	Frequency	Conducted Output Power		LIMIT
	(MHz)	Peak(dBm)	AVG(dBm)	dBm
CH01	2412	10.47	9.49	30
CH06	2437	10.84	9.91	30
CH11	2462	10.31	9.35	30

TX 802.11n20 Mode				
Test Channel	Frequency	Conducted Output Power		LIMIT
	(MHz)	Peak(dBm)	AVG(dBm)	dBm
CH01	2412	9.37	7.39	30
CH06	2437	9.69	7.71	30
CH11	2462	9.31	7.33	30

8. ANTENNA REQUIREMENT

8.1 STANDARD REQUIREMENT

15.203 requirement: For intentional device, according to 15.203: an intentional radiator shall be designed to ensure that no antenna other than that furnished by the responsible party shall be used with the device.

8.2 EUT ANTENNA

The EUT antenna is PIFA Antenna. It comply with the standard requirement.

APPENDIX - PHOTOS OF TEST SETUP

Radiated Measurement Photos

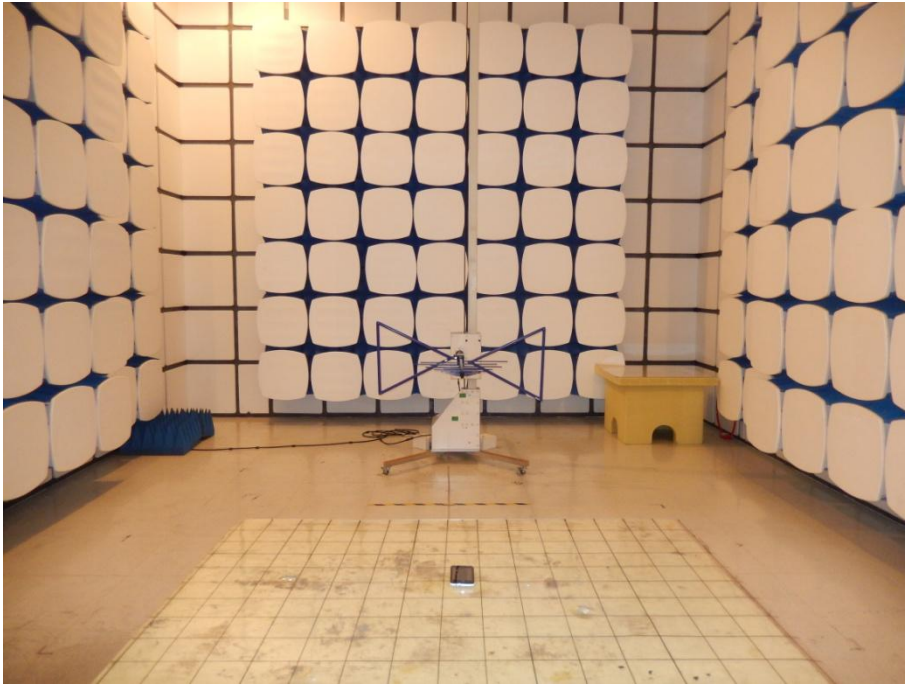

Conducted Measurement Photos



*****END OF THE REPORT*****